

MARKS PUBLISHED FOR OPPOSITION

The following marks are published in compliance with section 12(a) of the Trademark Act of 1946. Applications for the registration of marks in more than one class have been filed as provided in section 30 of said act as amended by Public Law 772, 87th Congress, approved Oct. 9, 1962, 76 Stat. 769. Opposition under section 13 may be filed within thirty days of the date of this publication. See rules 2.101 to 2.105.

A separate fee of two hundred dollars for opposing each mark in each class must accompany the opposition.

SECTION 1.— INTERNATIONAL CLASSIFICATION

The short titles associated below with the international class numbers are terms designed merely for quick identification and are not an official part of the international classification. The full names of international classes are given in section 6.1 of the trademark rules of practice.

The designation "U.S. Cl." appearing in this section refers to the U.S. class in effect prior to Sep. 1, 1973 rather than the international class which applies to applications filed on or after that date. For adoption of international classification see notice in the OFFICIAL GAZETTE of Jun. 26, 1973 (911 O.G. TM 210).

Application in more than one class

SN 76-467,116. DECODE ENTERTAINMENT INC., TORONTO, ONTARIO, CANADA, FILED 11-6-2002.

SAVE-UMS!

CLASS 9—ELECTRICAL AND SCIENTIFIC APPARATUS

FOR CHILDREN'S AUDIO AND VIDEO CHILDREN'S EDUCATIONAL SOFTWARE; PRERECORDED AUDIO AND VIDEO RECORDINGS IN THE NATURE OF ANIMATED OR LIVE ACTION TELEVISION PROGRAMS, SOFTWARE CD ROMS FOR CHILDREN RELATING TO AN ANIMATED OR LIVE ACTION TELEVISION PROGRAM; VIDEO GAME SOFTWARE, GRADUATED RULERS (U.S. CLS. 21, 23, 26, 36 AND 38).

CLASS 16—PAPER GOODS AND PRINTED MATTER

FOR BOOKS, NAMELY, FICTION BOOKS, COLORING BOOKS, CHILDREN'S ACTIVITY BOOKS, CHILDREN'S EDUCATIONAL WORKBOOKS, STORY BOOKS, PICTURE BOOKS, CHILDREN'S NOVELTY BOOKS, LIFT-THE-FLAP BOOKS, CLOTH BOOKS, BATH BOOKS, PEN AND ACTIVITY BOOKS, STICKER BOOKS AND SOUND BOOKS, FLASH CARDS; CALENDARS; PARTY SUPPLIES, NAMELY, PAPER PARTY DECORATIONS, PAPER BANNERS, PAPER CENTER PIECES, PAPER CAKE DECORATIONS, PAPER PARTY HATS, PAPER TABLE-CLOTHS, AND INVITATIONS; SCHOOL SUPPLIES, NAMELY, FOLDERS, BINDERS, STENCILS; PENCIL AND PEN BOXES, AND PEN CASES (U.S. CLS. 2, 5, 22, 23, 29, 37, 38 AND 50).

CLASS 25—CLOTHING

FOR CLOTHING AND ACCESSORIES FOR INFANTS, TODDLERS, AND CHILDREN, NAMELY, OVERALLS, CREEPER DRESSES, DRESSES, SUNDRESSES, DRESS SETS COMPRISED OF DRESSES WITH A TOP, SWEATER, CARDIGAN, OR JACKET; COORDINATE PANTS AND SHIRTS; PLAY SETS COMPRISED OF TOPS WITH SHORTS, PANTS, OVERALLS, OR SHORTALLS; KNIT SETS COMPRISED OF TOPS WITH PANTS OR SHORTS; SHORTALLS, ROMPERS, JUMPERS, JOG SETS COMPRISED OF SWEATSUITS, SWEATPANTS WITH SWEAT-SHIRTS; LAYETTES, NAMELY, SETS COMPRISING SOCKS, WASHCLOTHS, BIBS AND HOODED TOWELS; PLAYETTES, NAMELY, SETS COMPRISING SLEEPWEAR, UNDERWEAR, AND PLAYSUITS; JUMPSUITS, SWIMWEAR, LIGHT WEIGHT OUTERWEAR, NAMELY, RAINCOATS, HOODED AND NON-HOODED JACKETS, AND ANORAKS; T-SHIRTS, BLANKET SLEEPING SHIRTS, DORM SHIRTS, PAJAMAS NIGHTGOWNS, UNION SUITS, JUMP SUITS, ROBES, UNDERGARMENTS, LONG UNDERWEAR SETS COMPRISED OF TOPS AND BOTTOMS, HANGING SETS COMPRISED OF GIRLS' PANTIES WITH UNDERSHIRTS, BOXER SHORTS, PANTIES; FOOTWEAR, SLIPPERS, SANDALS, ATHLETIC SNEAKERS, PLASTIC SANDALS, BELTS, SUSPENDERS, MITTENS, GLOVES, CAPS, SCARVES, SOCKS AND HOSIERY, SLIPPER SOCKS, ATHLETIC SOCKS, DRESS SOCKS, HEADWEAR, BASEBALL CAPS, BUCKET CAPS, BEANIES, HEADBANDS, EARMUFFS, RAINCOATS AND SLICKERS (U.S. CLS. 22 AND 39).

CLASS 28—TOYS AND SPORTING GOODS

FOR TOYS, NAMELY, INFANT TOYS, BUBBLE MAKING WANDS AND SOLUTION SETS, PUSH TOYS, PULL TOYS, TOY BLOCKS AND ACCESSORIES THEREFOR; TOY BUILDING SETS, TOY VILLAGES, TOY SCENERY SETS, DOLL HOUSES, TOY FURNITURE, TOY ACTION FIGURES, EDUCATIONAL TOYS, NAMELY, SHAPE SORTERS AND STACKING RINGS DESIGNED TO TEACH COLOR AND SOUND RECOGNITION, ROLE PLAYING GAMES; BATH TOYS, NAMELY, BATH TOY SQUIRTERS, WATER SQUIRTING TOYS, PLUSH DOLLS FOR USE IN WATER, SCENERY SETS THAT CONNECT TO THE SIDE OF A TUB OR FLOAT, FOAM SHAPES, NUMBERS, AND LETTERS; POOL TOYS, NAMELY, RAFTS, WATER RINGS, KICK-BOARDS, FLOTATION DEVICES, MOLDED TOYS; BEACH TOYS, NAMELY, PAILS, SHOVELS, RAKES, SIFTERS, PLAY SWIMMING POOLS; MUSICAL AND SOUND MAKING TOYS, NAMELY, TOY MUSICAL INSTRUMENTS AND MUSICAL TOYS; TALKING TOYS, NAMELY, TALKING DOLLS; PLUSH TOYS, MUSICAL PLUSH TOYS, AND ELECTRONIC PLUSH TOYS; ACTIVITY TOYS, NAMELY, PLASTIC TOY HOUSEHOLD ITEMS AND TOY PLASTIC FOOD; GAMES, NAMELY, BOARD

GAMES, CARD GAMES, DICE GAMES, WORD GAMES COMPRISED OF DICE AND FLASH CARDS; TRAVEL GAMES COMPRISED OF DICE, CARDS, A PLAYING SURFACE, TIMER, AND SCORE CARD; AND ACTION SKILL GAMES, DOLLS, PUPPETS, JIGSAW PUZZLES, HALLOWEEN COSTUMES AND MASKS; BALLOONS; PLAY TENTS; HANDHELD UNITS FOR PLAYING EDUCATIONAL ELECTRONIC GAMES AND WORD GAMES; AND TOY RAZORS; HOBBY CRAFT KITS IN THE NATURE OF A SEWING KIT COMPRISED OF YARN, FABRIC, CARDBOARD PATTERNS, BOWS, FILLING AND STUFFING, PAPER BLOW OUT TOYS (U.S. CLS. 22, 23, 38 AND 50).

DEZMONA MIZELLE, EXAMINING ATTORNEY

SN 76-499.166, EASYGROUP IP LICENSING LIMITED, CAMDEN, LONDON, ENGLAND, FILED 3-20-2003.



PRIORITY CLAIMED UNDER SEC. 44(D) ON ERP N CMNTY TM OFC APPLICATION NO. 003088366, FILED 3-4-2003, REG. NO. 003088366, DATED 6-27-2008, EXPIRES 3-4-2013.

OWNER OF U.S. REG. NO. 2,197,131.

THE COLOR(S) ORANGE AND WHITE IS/ARE CLAIMED AS A FEATURE OF THE MARK.

THE MARK CONSISTS OF THE STYLIZED WORDS "EASYMUSIC" AND RECTANGLE BACKGROUND; LETTERING IS WHITE AND BACKGROUND IS ORANGE.

CLASS 9—ELECTRICAL AND SCIENTIFIC APPARATUS

FOR COMPUTER HARDWARE, NAMELY, COMMUNICATIONS SERVERS; TELEPHONE RECEIVERS, TELEPHONE TRANSMITTERS, PORTABLE TELEPHONES, MOBILE TELEPHONES; PHOTOGRAPHIC CAMERAS; SCALES, LASERS FOR MEASURING PURPOSES, ADDING MACHINES, CALCULATORS, DIRECTIONAL COMPASSES, MARINE COMPASSES, GRADUATED RULERS, PLUMB LEVELS, SMOKE DETECTORS, FIRE ALARMS, FIRE EXTINGUISHERS, FIRE BLANKETS, DIVING SUITS, DIVING MASKS, UNDERWATER BREATHING APPARATUS, LIFE BELTS, LIFE JACKETS; CONSUMER DOMESTIC ELECTRICAL AND ELECTRONIC APPARATUS, NAMELY, BATTERY CHARGERS, CAMCORDERS, CAMERAS, CASSETTE PLAYERS, COMPACT DISC PLAYERS; BLANK COMPACT DISCS, FLOPPY DISCS, VIDEO CASSETTES, DVDS AND VIDEOTAPES; COMPACT DISCS, VIDEO CASSETTES, DVDS, CD-ROMS AND VIDEOTAPES FEATURING MUSIC, MUSIC VIDEOS, MOTION PICTURES, DOCUMENTARIES AND COMPUTER GAMES; COMPUTERS, COMPUTER PRINTERS, DISK DRIVES FOR COMPUTERS, HEADPHONES, LOUDSPEAKERS, MODEMS, COMPUTER MONITORS, COMPUTER MOUSE, PERSONAL STEREO, POCKET CALCULATORS, MOBILE PHONES, RADIOS, RECORD PLAYERS, SCANNERS, STEREO AMPLIFIERS AND RECEIVERS, TAPE RECORDERS, TELEVISIONS, VIDEO PLAYERS, VDU'S, DVD PLAYERS; COMPUTER E-COMMERCE SOFTWARE TO ALLOW USERS TO PERFORM ELECTRONIC BUSINESS TRANSACTIONS VIA A GLOBAL COMPUTER NETWORK, COMMUNICATIONS SOFTWARE FOR CONNECTING TO COMPUTER NETWORK USERS, COMPUTER SOFTWARE FOR ACCESSING INFORMATION DIRECTORIES THAT MAY BE DOWNLOADED FROM A GLOBAL COMPUTER NETWORK; COMPUTER SOFTWARE TO ENHANCE THE AUDIO-VISUAL CAPABILITIES OF MULTIMEDIA APPLICATIONS, NAMELY, FOR THE INTEGRATION OF TEXT, AUDIO, GRAPHICS, STILL IMAGES AND MOVING PICTURES; MOVIE PROJECTORS, PHOTOGRAPHIC PROJECTORS, SLIDE PROJECTORS; MOTION PICTURE CAMERAS; MOTION PICTURE FILMS, FEATURING MOVIES, DOCUMENTARIES AND EDUCATIONAL FILMS; SOFTWARE TO ENABLE THE STORAGE OF MOVIES,

FILMS AND VIDEOS ON A COMPUTER; DOWNLOADABLE ELECTRONIC PUBLICATIONS IN THE NATURE OF MAGAZINES, NEWSPAPERS, BROCHURES, REVIEWS, AND ADVERTISEMENTS IN THE FIELD OF MUSIC, FILM AND VIDEOS; DOWNLOADABLE AUDIO AND VIDEO RECORDINGS WHICH FEATURE MUSIC, MUSIC VIDEOS, MOTION PICTURES AND DOCUMENTARIES; SOUND AND VIDEO RECORDINGS FEATURING MUSIC AND MOVIES; CASSETTE PLAYERS, HI-FI AMPLIFIERS AND RECEIVERS, RECORD PLAYERS, TAPE PLAYERS, CD PLAYERS, VIDEOCASSETTE AND VIDEOTAPE PLAYERS, DVD PLAYERS, MINI-DISC PLAYERS; GAMBLING MACHINES, NAMELY, SLOT MACHINES WITH OR WITHOUT VIDEO OUTPUT; VENDING MACHINES FOR DRINKS AND FOOD; VIDEO GAME MACHINES FOR USE WITH TELEVISIONS; EXPOSED CAMERA FILM, MOTION PICTURE FILMS, FEATURING MOVIES, DOCUMENTARIES AND EDUCATIONAL FILMS; PHOTOGRAPHIC SLIDE TRANSPARENCIES; AUDIO AND VISUAL EDUCATIONAL AND TEACHING APPARATUS AND INSTRUMENTS, NAMELY, INTERACTIVE ELECTRONIC WHITE BOARDS AND ASSOCIATED ELECTRONIC PINS AND PADS, SLIDE PROJECTORS, DISPLAY SCREENS FOR SLIDE PROJECTORS AND VIDEO MONITORS; ELECTRONICALLY, MAGNETICALLY AND OPTICALLY ENCODED IDENTITY AND MEMBERSHIP CARDS; PROTECTIVE HEADGEAR, NAMELY, HELMETS, HATS AND CAPS (U.S. CLS. 21, 23, 26, 36 AND 38).

CLASS 40—MATERIAL TREATMENT

FOR DESK-TOP PUBLISHING FOR OTHERS; PRESSING OF OPTICAL DISCS, MASTERS AND RECORD MASTERS; DUPLICATION OF COMPUTER SOFTWARE; TREATMENT OF MATERIALS, NAMELY, PHOTOGRAPHIC FILM DEVELOPMENT, PHOTOGRAPHIC PRINTING, LASER SCRIBING, LAMINATING, AND PHOTOGRAPHIC PRINTING; DUPLICATING OF TAPE RECORDINGS; DUPLICATING OF VIDEO RECORDINGS (U.S. CLS. 100, 103 AND 106).

CLASS 41—EDUCATION AND ENTERTAINMENT

FOR RECORDING STUDIOS, NAMELY, ELECTRONIC RECORDING OF SOUNDS AND/OR IMAGES AND RECORDING SERVICES; COMMISSIONED CUSTOM WRITING SERVICES FOR THE COMPILATION OF WEBPAGES ON THE INTERNET; INFORMATION RELATING TO ENTERTAINMENT AND EDUCATION, PROVIDED ONLINE FROM A COMPUTER DATABASE OR THE INTERNET; ENTERTAINMENT SERVICES, NAMELY, PROVIDING A WEB SITE FEATURING COMPUTER GAMES, MUSICAL PERFORMANCES, MUSICAL VIDEOS AND RELATED FILM CLIPS, AND OTHER MULTIMEDIA MATERIALS FEATURING LIVE MUSIC, SPORTING EVENTS, FILMS, THEATRICAL PRODUCTIONS AND GAMES PROVIDED ONLINE FROM A COMPUTER DATABASE OR THE INTERNET; EDUCATIONAL INFORMATION, NAMELY, INFORMATION RELATING TO MUSIC AND THE MUSIC INDUSTRY, PROVIDED ONLINE FROM A COMPUTER DATABASE OR THE INTERNET; ENTERTAINMENT SERVICES, NAMELY, LIVE MUSIC PERFORMANCES, RENTAL OF VIDEOTAPES AND DISCS, AND LIVE MUSIC EVENTS; EDUCATION SERVICES, NAMELY, PROVIDING INSTRUCTIONAL INFORMATION REGARDING MUSIC; ELECTRONIC PUBLISHING SERVICES, NAMELY, PUBLICATION OF TEXT AND GRAPHIC WORKS OF OTHERS ON CD, ON DVD, OR ONLINE FEATURING MUSIC VIDEOS, MOTION PICTURES, DOCUMENTARIES AND/OR COMPUTER GAMES; PRODUCTION, EDITING AND RENTAL OF SOUND AND VIDEO RECORDINGS AND FILMS; ORGANIZING COMMUNITY GAMES AND COMPETITIONS; INSTRUCTIONAL SERVICES IN THE FIELD OF MUSIC, ART, AND MOTION PICTURES; RENTAL OF CONSUMER DOMESTIC ELECTRIC AND ELECTRONIC GOODS, NAMELY, RENTAL OF AMUSEMENT GAME MACHINES, AUDIO AND VISUAL APPARATUS AND EQUIPMENT IN THE NATURE OF FILM PROJECTION EQUIPMENT, CAMCORDERS, COMPACT DISC PLAYERS, COMPACT DISCS, SLOT MACHINES, CASSETTE PLAYERS, CASSETTE RECORDERS, CASSETTE TAPES, AUDIO TAPES, VIDEO CAMERAS, VIDEO

CASSETTES, VIDEO DISCS, VIDEO TAPES, CD ROMS, RADIO SETS AND TELEVISION SETS, CINEMA FILMS, BAND MUSIC TAPES AND VIDEOCASSETTE TAPES AND DISCS; RENTAL OF TOYS, GAMES AND PLAY-THINGS; PROVIDING TRAINING SERVICES IN THE FIELD OF MUSIC AND MOTION PICTURES; ORGANIZING COMMUNITY SPORTING AND CULTURAL ACTIVITIES; GYMNASIUM SERVICES; AUDIO RECORDING SERVICES; RENTAL OF SOUND AND/OR VIDEO RECORDING APPARATUS, NAMELY, TAPE RECORDING EQUIPMENT, VIDEO RECORDING EQUIPMENT AND CD ROM RECORDING EQUIPMENT; PROVISION OF RECORDING STUDIO FACILITIES, RECORDING OF MUSIC; PRODUCTION FOR OTHERS OF OPTICAL DISCS, MASTERS AND RECORD MASTERS (U.S. CLS. 100, 101 AND 107).

SN 76-672,559. HSU, PETER, PANORAMA CITY, CA. FILED 2-12-2007.



NO CLAIM IS MADE TO THE EXCLUSIVE RIGHT TO USE "VIRGIN COCONUT OIL", APART FROM THE MARK AS SHOWN.

CLASS 3—COSMETICS AND CLEANING PREPARATIONS

FOR VIRGIN COCONUT OIL FOR COSMETIC PURPOSES (U.S. CLS. 1, 4, 6, 50, 51 AND 52).
FIRST USE 2-12-2007; IN COMMERCE 4-11-2007.

CLASS 5—PHARMACEUTICALS

FOR VIRGIN COCONUT OIL FOR USE AS DIETARY SUPPLEMENT (U.S. CLS. 6, 18, 44, 46, 51 AND 52).
FIRST USE 2-12-2007; IN COMMERCE 4-11-2007.

CLASS 42—SCIENTIFIC AND COMPUTER SERVICES

FOR RENTAL OF COMPUTER MONITORS; NON BUSINESS TECHNICAL PROFESSIONAL CONSULTANCY RELATING TO COMPUTER SOFTWARE, FIRMWARE, HARDWARE, AND INFORMATION TECHNOLOGY; METEOROLOGICAL FORECASTING INFORMATION SERVICES; TECHNICAL CONSULTANCY, DEVELOPMENT, ADVICE, ASSISTANCE, ANALYSIS, DESIGN, EVALUATION AND PROGRAMMING SERVICES RELATING TO COMPUTER SOFTWARE, FIRMWARE, HARDWARE AND INFORMATION TECHNOLOGY; COMPUTER RENTAL; RENTAL OF CONSUMER DOMESTIC ELECTRIC AND ELECTRONIC GOODS, NAMELY, RENTAL OF COMPUTERS, COMPUTER HARDWARE, COMPUTER SOFTWARE, COMPUTER APPARATUS AND EQUIPMENT; DESIGN, DRAWING, AND COMMISSIONED TECHNICAL WRITING, ALL FOR THE COMPILATION OF WEB PAGES ON THE INTERNET; HOSTING, CREATING AND MAINTAINING WEB SITES FOR OTHERS; LEASING COMPUTER FACILITIES IN THE SETTING OF AN INTERNET CAFE; TECHNICAL CONSULTANCY AND ADVICE RELATING TO THE EVALUATION, CHOOSING, AND IMPLEMENTATION OF COMPUTER SOFTWARE, FIRMWARE, HARDWARE, INFORMATION TECHNOLOGY AND OF DATA PROCESSING SYSTEMS; RECOVERY OF COMPUTER DATA; RENTAL OF COMPUTER SOFTWARE, FIRMWARE, AND HARDWARE; PROVISION OF INFORMATION RELATING TO TECHNICAL COMPUTER MATTERS, LEGAL MATTERS, INFORMATION TECHNOLOGY AND INTELLECTUAL PROPERTY; SCIENTIFIC AND TECHNOLOGICAL RESEARCH AND DESIGN RELATING TO THE FIELD OF COMPUTERS; INDUSTRIAL COMPUTER SYSTEMS ANALYSIS AND SCIENTIFIC RESEARCH SERVICES; LEGAL SERVICES; AND ALL THE AFORESAID SERVICES PROVIDED SPECIFICALLY BUT NOT EXCLUSIVELY VIA TELECOMMUNICATIONS NETWORKS, BY ON LINE DELIVERY AND BY WAY OF THE INTERNET AND THE WORLD WIDE WEB (U.S. CLS. 100 AND 101).
BRENDAN REGAN, EXAMINING ATTORNEY

CLASS 29—MEATS AND PROCESSED FOODS

FOR VIRGIN COCONUT OIL FOR COOKING (U.S. CL. 46).
FIRST USE 2-12-2007; IN COMMERCE 4-11-2007.
JULIE GUTTADAURO, EXAMINING ATTORNEY

SN 76-681,087. HERAEUS KULZER GMBH, D-63450 HANAU, FED REP GERMANY, FILED 8-24-2007.



PRIORITY CLAIMED UNDER SEC. 44(D) ON FED REP GERMANY APPLICATION NO. 30725993.5, FILED 4-19-2007, REG. NO. 30725993, DATED 7-5-2007, EXPIRES 4-19-2017.

CLASS 1—CHEMICALS

FOR CHEMICAL PRODUCTS FOR USE IN THE MANUFACTURE OF DENTAL PRODUCTS FOR DENTAL AND DENTAL TECHNICAL PURPOSES (U.S. CLS. 1, 5, 6, 10, 26 AND 46).

CLASS 5—PHARMACEUTICALS

FOR DENTAL CERAMICS FOR VENEERING AND FOR THE MANUFACTURE AND REPAIR OF CROWNS, BRIDGES, DENTURES, DENTURE COMPONENTS AND INLAYS; PRECIOUS AND NON-PRECIOUS METAL ALLOYS AND SOLDERS FOR DENTAL AND DENTAL TECHNOLOGY PURPOSES, INVESTING MASSES, PLASTERS AND MODEL CASTING FOR DENTAL TECHNOLOGY PURPOSES (U.S. CLS. 6, 18, 44, 46, 51 AND 52).

CLASS 9—ELECTRICAL AND SCIENTIFIC APPARATUS

FOR SCIENTIFIC, SURVEYING, ELECTRICAL, ELECTRONIC, OPTICAL, MEASURING AND CONTROL APPARATUS AND INSTRUMENTS FOR USE IN DENTAL TECHNOLOGY AND DENTAL MEDICINE, NAMELY, COMPUTERS AND DATA PROCESSING EQUIPMENT FOR USE IN DENTAL TECHNOLOGY AND DENTAL MEDICINE; COMPUTER SOFTWARE FOR USE IN THE DESIGN AND MANUFACTURE OF DENTAL RESTORATIONS IN THE FIELD OF DENTAL TECHNOLOGY AND DENTAL MEDICINE (U.S. CLS. 21, 23, 26, 36 AND 38).

CLASS 10—MEDICAL APPARATUS

FOR DENTAL INSTRUMENTS AND APPARATUS, NAMELY, DENTAL IMPLANTS, ARTIFICIAL TEETH, DENTAL BRIDGES, DENTAL CROWNS, DENTURES (U.S. CLS. 26, 39 AND 44).

RENEE MCCRAY, EXAMINING ATTORNEY

SN 76-683,090. POLAR SHADES, INC., HENDERSON, NV.
FILED 10-18-2007.

POLAR SHADES

THE MARK CONSISTS OF STANDARD CHARACTERS WITHOUT CLAIM TO ANY PARTICULAR FONT, STYLE, SIZE, OR COLOR.

NO CLAIM IS MADE TO THE EXCLUSIVE RIGHT TO USE "SHADES", APART FROM THE MARK AS SHOWN.

CLASS 19—NON-METALLIC BUILDING MATERIALS

FOR NONMETAL EXTERIOR WINDOW SHADES (U.S. CLS. 1, 12, 33 AND 50).
FIRST USE 6-1-1995; IN COMMERCE 6-1-1995.

CLASS 20—FURNITURE AND ARTICLES NOT OTHERWISE CLASSIFIED

FOR INDOOR WINDOW SHADES; WINDOW SHADES (U.S. CLS. 2, 13, 22, 25, 32 AND 50).
FIRST USE 6-1-1995; IN COMMERCE 6-1-1995.
GILBERT SWIFT, EXAMINING ATTORNEY

SN 76-684,066. CSM CORPORATION, MINNEAPOLIS, MN.
FILED 11-15-2007.



CSM

OWNER OF U.S. REG. NOS. 2,577,464 AND 2,577,465.
THE COLOR(S) BLACK, RED, AND WHITE IS/ARE CLAIMED AS A FEATURE OF THE MARK.

THE COLOR WHITE APPEARS IN THE THREE WHITE LINED QUARTER MOON SHAPES INSIDE THE CIRCLE, THE COLOR RED APPEARS IN THE CIRCLE, AND COLOR BLACK APPEARS IN THE LETTERS "CSM" POSITIONED ALONG SIDE THE DESIGN.

CLASS 36—INSURANCE AND FINANCIAL

FOR REAL ESTATE MANAGEMENT OF COMMERCIAL, OFFICE, MANUFACTURING, RESIDENTIAL, AND HOTEL PROPERTIES (U.S. CLS. 100, 101 AND 102).
FIRST USE 12-1-2003; IN COMMERCE 12-1-2003.

CLASS 42—SCIENTIFIC AND COMPUTER SERVICES

FOR DESIGN FOR OTHERS IN THE FIELD OF COMMERCIAL, OFFICE, MANUFACTURING, RESIDENTIAL, AND HOTEL PROPERTIES (U.S. CLS. 100 AND 101).

FIRST USE 12-1-2003; IN COMMERCE 12-1-2003.
KRISTINA MORRIS, EXAMINING ATTORNEY

SN 76-686,206. SHARPS COMPLIANCE, INC., HOUSTON, TX. FILED 1-28-2008.

SHARPS

Defining Change Through Innovation...
Sharps Disposal By Mail

OWNER OF U.S. REG. NOS. 2,530,938, 2,619,102 AND 2,634,460.

NO CLAIM IS MADE TO THE EXCLUSIVE RIGHT TO USE "SHARPS" AND "SHARPS DISPOSAL BY MAIL", APART FROM THE MARK AS SHOWN.

THE COLOR(S) BLACK, WHITE AND RED IS/ARE CLAIMED AS A FEATURE OF THE MARK.

THE COLOR BLACK APPEARS IN THE WORD "SHARPS" AND IN THE WORDS "SHARPS DEFINING CHANGE THROUGH INNOVATION, SHARPS DISPOSAL BY MAIL". IN THE WORD "SHARPS" FIRST APPEARING IN THE MARK, THE COLOR RED APPEARS IN THE ANGLED DESIGN IN THE LETTER "A", AND THE COLOR WHITE APPEARS BELOW THE ANGLED DESIGN AS A SHORT SEGMENT OF THE RIGHT ARM OF THE LETTER "A".

CLASS 10—MEDICAL APPARATUS

FOR SECURELY SEALED, LEAK AND PUNCTURE RESISTANT SHARPS CONTAINERS WITH INTERNAL ABSORBENT MATERIAL THAT SAFELY HOLDS UP TO 150 MILLIMETERS OF FLUIDS, AND SHARPS CONTAINERS IN THE FORM OF POSTAL SERVICE APPROVED SHIPPING CARTONS WITH PREPAID POSTAGE (U.S. CLS. 26, 39 AND 44).
FIRST USE 1-19-2007; IN COMMERCE 2-7-2007.

CLASS 16—PAPER GOODS AND PRINTED MATTER

FOR RED BAG CONTAINERS FOR PROVIDING ADDITIONAL CONTAINMENT ABOUT SHARPS CONTAINERS, NAMELY, PLASTIC BAGS FOR PACKAGING (U.S. CLS. 2, 5, 22, 23, 29, 37, 38 AND 50).

FIRST USE 1-19-2007; IN COMMERCE 2-7-2007.

CLASS 35—ADVERTISING AND BUSINESS

FOR MAIL SERVICE FOR SAFELY AND SECURELY MAILING MEDICAL WASTE, DEVICES, AND EQUIPMENT BY POSTAL SERVICE MAIL, NAMELY, TRACKING MAIL, PREPARING A TRACKING MANIFEST FOR CUSTOMERS AND REGULATORY AUTHORITIES, AND VERIFYING MAIL CONTENT DESTRUCTION TO CUSTOMERS AND REGULATORY AUTHORITIES (U.S. CLS. 100, 101 AND 102).

FIRST USE 1-19-2007; IN COMMERCE 2-7-2007.

CLASS 37—CONSTRUCTION AND REPAIR

FOR MEDICAL WASTE DISPOSAL (U.S. CLS. 100, 103 AND 106).

FIRST USE 1-19-2007; IN COMMERCE 2-7-2007.

CLASS 39—TRANSPORTATION AND STORAGE

FOR MAIL SERVICE FOR SAFELY AND SECURELY MAILING MEDICAL WASTE, DEVICES, AND EQUIPMENT BY POSTAL SERVICE MAIL, NAMELY, PACKAGING ARTICLES FOR TRANSPORTATION AND DELIVERING SUCH ARTICLES TO A POST OFFICE (U.S. CLS. 100 AND 105).

FIRST USE 1-19-2007; IN COMMERCE 2-7-2007.

CLASS 40—MATERIAL TREATMENT

FOR MEDICAL WASTE DESTRUCTION (U.S. CLS. 100, 103 AND 106).

FIRST USE 1-19-2007; IN COMMERCE 2-7-2007.

RUDY R. SINGLETON, EXAMINING ATTORNEY

CLASS 41—EDUCATION AND ENTERTAINMENT

FOR EDUCATION SERVICES, NAMELY, PROVIDING CLASSES, SEMINARS, WORKSHOPS AND CONVENTIONS IN THE FIELDS OF FARM LABOR, HUMAN RIGHTS AND ENGLISH (U.S. CLS. 100, 101 AND 107).

FIRST USE 0-0-1967; IN COMMERCE 0-0-1967.

CLASS 200—COLLECTIVE MEMBERSHIP

FOR INDICATING MEMBERSHIP IN A LABOR UNION OF FARM WORKERS.

FIRST USE 0-0-1967; IN COMMERCE 0-0-1967.

KIMBERLY FRYE, EXAMINING ATTORNEY

SN 76-687,046. AVINED TECHNICAL FURNISHINGS, INC., SPRINGDALE, PA. FILED 2-25-2008.

AVINED

THE MARK CONSISTS OF STANDARD CHARACTERS WITHOUT CLAIM TO ANY PARTICULAR FONT, STYLE, SIZE, OR COLOR.

CLASS 12—VEHICLES

FOR CARTS FOR MEDIA AND COMPUTER EQUIPMENT (U.S. CLS. 19, 21, 23, 31, 35 AND 44).

CLASS 20—FURNITURE AND ARTICLES NOT OTHERWISE CLASSIFIED

FOR FURNITURE, NAMELY, COMPUTER FURNITURE, MULTIMEDIA FURNITURE, NAMELY, LECTERNS, CONSOLES, DESKS, AND CABINETS FOR HOLDING MEDIA AND COMPUTER EQUIPMENT, AND PRESENTATION FURNITURE, NAMELY, LECTURE STANDS, CONSOLES, DESKS, AND CABINETS WHICH CAN BE USED BY A PRESENTER MAKING A PRESENTATION (U.S. CLS. 2, 13, 22, 25, 32 AND 50).

MARY CRAWFORD, EXAMINING ATTORNEY

SN 76-686,830. FARM LABOR ORGANIZING COMMITTEE, TOLEDO, OH. FILED 2-15-2008.

FARM LABOR ORGANIZING COMMITTEE

THE MARK CONSISTS OF STANDARD CHARACTERS WITHOUT CLAIM TO ANY PARTICULAR FONT, STYLE, SIZE, OR COLOR.

NO CLAIM IS MADE TO THE EXCLUSIVE RIGHT TO USE "ORGANIZING COMMITTEE", APART FROM THE MARK AS SHOWN. SEC. 2(F).

CLASS 35—ADVERTISING AND BUSINESS

FOR PROMOTING PUBLIC AWARENESS OF HUMAN RIGHTS; PROVIDING LABOR RELATIONS SERVICES, NAMELY, ESTABLISHING COMMITTEES WITH UNIONS TO IMPROVE RELATIONS BETWEEN EMPLOYERS AND UNIONS; PUBLIC ADVOCACY TO PROMOTE AWARENESS OF FARM LABOR, AGRICULTURE AND HUMAN RIGHTS (U.S. CLS. 100, 101 AND 102).

FIRST USE 0-0-1967; IN COMMERCE 0-0-1967.

SN 76-687,529. FELO-WERKZEUGFABRIK HOLLAND-LETZ GMBH, 35279 NEUSTADT, FED REP GERMANY, FILED 3-10-2008.

HMC

THE MARK CONSISTS OF STANDARD CHARACTERS WITHOUT CLAIM TO ANY PARTICULAR FONT, STYLE, SIZE, OR COLOR.

OWNER OF ERPN CMNTY TM OFC REG. NO. 003059128, DATED 12-7-2004, EXPIRES 2-18-2013.

CLASS 7—MACHINERY

FOR TOOL BITS FOR USE IN ELECTRIC OR PNEUMATIC MACHINES, NAMELY, TOOL BITS FOR USE IN ELECTRIC OR PNEUMATIC SCREWDRIVERS, SCREWDRIVER BITS; POWER-OPERATED DRILLS, BORERS, MILLING CUTTERS, THREAD-CUTTING TOOLS, CUTTING TOOLS, SAW BLADES, SAW BANDS AND SAW WIRES, ALL AFOREMENTIONED GOODS FOR USE IN MACHINES (U.S. CLS. 13, 19, 21, 23, 31, 34 AND 35).

CLASS 8—HAND TOOLS

FOR HAND TOOLS, NAMELY, SCREWDRIVERS, TOOL BITS, SCREWDRIVER BITS, SCREWDRIVER BITS WITH HAND-OPERATED HOLDERS, SOCKET BITS, WRENCHES, PLIERS, FILES, SCRAPERS, HAND SAWS, HAMMERS, CHISELS, TROWELS, PLANES, ALL AFOREMENTIONED GOODS HAND-OPERATED; SAW BLADES AND SAW BANDS FOR USE IN HAND SAWS (U.S. CLS. 23, 28 AND 44).

PAM WILLIS, EXAMINING ATTORNEY

SN 76-688,545. 12 BY 12 DESIGN, EDINA, MN. FILED 4-11-2008.

ELIA

THE MARK CONSISTS OF STANDARD CHARACTERS WITHOUT CLAIM TO ANY PARTICULAR FONT, STYLE, SIZE, OR COLOR.

THE NAME "ELIA" IDENTIFIES A LIVING INDIVIDUAL WHOSE CONSENT IS OF RECORD.

CLASS 16—PAPER GOODS AND PRINTED MATTER

FOR CRAFT KITS FOR PARENTS AND CHILDREN, NAMELY, KITS COMPRISING PAPER-BASED SUBSTRATES AND ONE OR MORE OF THE FOLLOWING ARTIST MATERIALS, NAMELY, WRITING INSTRUMENTS, PENS, PENCILS, MECHANICAL PENCILS, MARKERS, CRAYONS, HIGHLIGHTERS, ERASERS, PAPER, CONSTRUCTION PAPER, COLLAGES, PICTURES, STENCILS, PAPER CLIPS, STICKERS, STICKER ALBUMS, GLUE AND TAPE (U.S. CLS. 2, 5, 22, 23, 29, 37, 38 AND 50).

CLASS 20—FURNITURE AND ARTICLES NOT OTHERWISE CLASSIFIED

FOR FURNITURE CRAFT KITS FOR PARENTS AND CHILDREN COMPRISING CHAIR SEATS, CHAIR LEGS, CHAIR BACKS, TABLE LEAVES AND TABLE LEGS (U.S. CLS. 2, 13, 22, 25, 32 AND 50).

RONALD AIKENS, EXAMINING ATTORNEY

SN 76-687,530. FELO-WERKZEUGFABRIK HOLLAND-LETZ GMBH, 35279 NEUSTADT, FED REP GERMANY, FILED 3-10-2008.

ERGONIC

OWNER OF ERPN CMNTY TM OFC REG. NO. EM005323191, DATED 7-9-2007, EXPIRES 4-9-2016.

THE WORDING "ERGONIC" IN THE MARK HAS NO MEANING IN A FOREIGN LANGUAGE.

CLASS 8—HAND TOOLS

FOR HAND TOOLS, NAMELY, SCREWDRIVERS, TOOL BITS, SCREWDRIVER BITS, SCREWDRIVER BITS WITH HAND-OPERATED HOLDERS, SOCKET BITS, WRENCHES, PLIERS, FILES, SCRAPERS, HAND SAWS, HAMMERS, CHISELS, TROWELS, PLANES, ALL AFOREMENTIONED GOODS HAND-OPERATED (U.S. CLS. 23, 28 AND 44).

CLASS 20—FURNITURE AND ARTICLES NOT OTHERWISE CLASSIFIED

FOR HANDLES, NAMELY, TOOL HANDLES, KNIFE HANDLES, HANDLES FOR GARDENING IMPLEMENTS, HANDLES FOR GARDENING TOOLS, HANDLES FOR FORESTRY TOOLS, HANDLES FOR ELECTRIC TOOLS, ALL AFOREMENTIONED GOODS MADE OF PLASTIC (U.S. CLS. 2, 13, 22, 25, 32 AND 50).

PAM WILLIS, EXAMINING ATTORNEY

SN 76-688,787. LAKELAND INDUSTRIES, INC., RONKONKOMA, NY. FILED 4-21-2008.

COOL SUIT

THE MARK CONSISTS OF STANDARD CHARACTERS WITHOUT CLAIM TO ANY PARTICULAR FONT, STYLE, SIZE, OR COLOR.

CLASS 9—ELECTRICAL AND SCIENTIFIC APPARATUS

FOR FIRE PROTECTIVE GARMENTS FOR INDUSTRIAL USE, NAMELY, PANTS, JACKET, GLOVES, HOODS, APRONS, COVERALLS, AND THE LIKE (U.S. CLS. 21, 23, 26, 36 AND 38).

CLASS 24—FABRICS

FOR FIRE PROTECTIVE FABRICS FOR INDUSTRIAL USE (U.S. CLS. 42 AND 50).

ALICE SUE CARRUTHERS, EXAMINING ATTORNEY

SN 76-689,015. BRASSEUR, INC., LOS ANGELES, CA. FILED
4-25-2008.

DORINDA CLARK COLE

THE MARK CONSISTS OF STANDARD CHARACTERS WITHOUT CLAIM TO ANY PARTICULAR FONT, STYLE, SIZE, OR COLOR.

THE NAME "DORINDA CLARK COLE" IDENTIFIES A LIVING INDIVIDUAL WHOSE CONSENT IS OF RECORD.

CLASS 18—LEATHER GOODS

FOR PURSES, LEATHER PURSES, CLUTCH PURSES, CHANGE PURSES, COIN PURSES, AND WRIST MOUNTED PURSES (U.S. CLS. 1, 2, 3, 22 AND 41).

CLASS 25—CLOTHING

FOR LADIES CLOTHING, NAMELY, SUITS, JACKETS, COATS, SHORTS, JEANS, PANTS, SKIRTS, BLOUSES, SHIRTS, DRESSES, SWEATERS, T-SHIRTS, TOPS, TANK TOPS, CAMISOLES, BELTS, CAPS AND HATS, FUR HATS, HAT BANDS, SMALL HATS AND WOOLLY HATS, HEADGEAR, NAMELY, HEADBANDS AND BANDANNAS (U.S. CLS. 22 AND 39).

SARA THOMAS, EXAMINING ATTORNEY

SN 76-691,890. DERMACIA, INC., SANTA ANA, CA. FILED
8-7-2008.

B&G for Men

THE MARK CONSISTS OF STANDARD CHARACTERS WITHOUT CLAIM TO ANY PARTICULAR FONT, STYLE, SIZE, OR COLOR.

NO CLAIM IS MADE TO THE EXCLUSIVE RIGHT TO USE "FOR MEN", APART FROM THE MARK AS SHOWN.

CLASS 3—COSMETICS AND CLEANING PREPARATIONS

FOR COSMETICS AND COSMETIC-PHARMACEUTICALS, NAMELY, NON-MEDICATED MAKE-UP, FOUNDATION MAKE-UP, SKIN CREAMS, BODY POWDERS, SKIN CLARIFIERS, FACE CREAM, FACE EMOLLIENTS, FACE LOTION, FACIAL MASKS, FACE MOISTURIZER, HAND CREAM, PERFUME, COLOGNE, TOILET WATER, SCENTED BODY OIL FOR PERSONAL USE, PERSONAL DEODORANT, AFTER SUN LOTIONS, SHAVING CREAM AND LOTIONS, AFTER SHAVE CREAM, NON-MEDICATED LIP BALM, LIPSTICK, LIP GLOSS, BLUSH, EYE SHADOW INCLUDING EYE SHINES, AND MASCARA (U.S. CLS. 1, 4, 6, 50, 51 AND 52).

CLASS 5—PHARMACEUTICALS

FOR MEDICATED COSMETICS OR COSMETIC-PHARMACEUTICALS, NAMELY, MEDICATED MAKE-UP; MEDICATED SKIN CARE PREPARATIONS, NAMELY, POWDER, CREAMS, FACE CLEANERS, MAKE-UP REMOVER, FACE CLEANSING WIPES, FACE SCRUBS, SKIN SOAPS, SKIN TONERS, SHOWER GELS, BODY GELS, BODY SCRUBS AND EXFOLIANT CREAMS; MEDICATED SUN BLOCK; MEDICATED BATH FOAM; MEDICATED BATH GELS; MEDICATED HAIR CARE PREPARATIONS; MEDICATED HAIR STYLING PREPARATIONS; MEDICATED SUN CREAMS, SUN BLOCK LOTIONS AND STICKS, AND MEDICATED SELF-TANNING CREAMS AND LOTIONS (U.S. CLS. 6, 18, 44, 46, 51 AND 52).

RENEE MCCRAY, EXAMINING ATTORNEY

SN 76-691,891. DERMACIA, INC., SANTA ANA, CA. FILED
8-7-2008.

Beautiful & Green

THE MARK CONSISTS OF STANDARD CHARACTERS WITHOUT CLAIM TO ANY PARTICULAR FONT, STYLE, SIZE, OR COLOR.

NO CLAIM IS MADE TO THE EXCLUSIVE RIGHT TO USE "GREEN", APART FROM THE MARK AS SHOWN.

CLASS 3—COSMETICS AND CLEANING PREPARATIONS

FOR COSMETICS AND COSMETIC-PHARMACEUTICALS, NAMELY, NON-MEDICATED MAKE-UP, FOUNDATION MAKE-UP, SKIN CREAMS, BODY POWDERS, SKIN CLARIFIERS, FACE CREAM, FACE EMOLLIENTS, FACE LOTION, FACIAL MASKS, FACE MOISTURIZER, HAND CREAM, PERFUME, COLOGNE, TOILET WATER, SCENTED BODY OIL FOR PERSONAL USE, PERSONAL DEODORANT, AFTER SUN LOTIONS, SHAVING CREAM AND LOTIONS, AFTER SHAVE CREAM, NON-MEDICATED LIP BALM, LIPSTICK, LIP GLOSS, BLUSH, EYE SHADOW INCLUDING EYE SHINES, AND MASCARA (U.S. CLS. 1, 4, 6, 50, 51 AND 52).

CLASS 5—PHARMACEUTICALS

FOR MEDICATED COSMETICS OR COSMETIC-PHARMACEUTICALS, NAMELY, MEDICATED MAKE-UP; MEDICATED SKIN CARE PREPARATIONS, NAMELY, POWDER, CREAMS, FACE CLEANERS, MAKE-UP REMOVER, FACE CLEANSING WIPES, FACE SCRUBS, SKIN SOAPS, SKIN TONERS, SHOWER GELS, BODY GELS, BODY SCRUBS AND EXFOLIANT CREAMS; MEDICATED SUN BLOCK; MEDICATED BATH FOAM; MEDICATED BATH GELS; MEDICATED HAIR CARE PREPARATIONS; MEDICATED HAIR STYLING PREPARATIONS; MEDICATED SUN CREAMS, SUN BLOCK LOTIONS AND STICKS, AND MEDICATED SELF-TANNING CREAMS AND LOTIONS (U.S. CLS. 6, 18, 44, 46, 51 AND 52).

RENEE MCCRAY, EXAMINING ATTORNEY

SN 76-691,892. DERMACIA, INC., SANTA ANA, CA. FILED 8-7-2008.

Lycology

THE MARK CONSISTS OF STANDARD CHARACTERS WITHOUT CLAIM TO ANY PARTICULAR FONT, STYLE, SIZE, OR COLOR.

CLASS 3—COSMETICS AND CLEANING PREPARATIONS

FOR COSMETICS AND COSMETIC-PHARMACEUTICALS, NAMELY, NON-MEDICATED MAKE-UP, FOUNDATION MAKE-UP, SKIN CREAMS, BODY POWDERS, SKIN CLARIFIERS, FACE CREAM, FACE EMOLLIENTS, FACE LOTION, FACIAL MASKS, FACE MOISTURIZER, HAND CREAM, PERFUME, COLOGNE, TOILET WATER, SCENTED BODY OIL FOR PERSONAL USE, PERSONAL DEODORANT, AFTER SUN LOTIONS, SHAVING CREAM AND LOTIONS, AFTER SHAVE CREAM, NON-MEDICATED LIP BALM, LIPSTICK, LIP GLOSS, BLUSH, EYE SHADOW INCLUDING EYE SHINES, AND MASCARA (U.S. CLS. 1, 4, 6, 50, 51 AND 52).

CLASS 5—PHARMACEUTICALS

FOR MEDICATED COSMETICS OR COSMETIC-PHARMACEUTICALS, NAMELY, MEDICATED MAKE-UP; MEDICATED SKIN CARE PREPARATIONS, NAMELY, POWDER, CREAMS, FACE CLEANERS, MAKE-UP REMOVER, FACE CLEANSING WIPES, FACE SCRUBS, SKIN SOAPS, SKIN TONERS, SHOWER GELS, BODY GELS, BODY SCRUBS AND EXFOLIANT CREAMS; MEDICATED SUN BLOCK; MEDICATED BATH FOAM; MEDICATED BATH GELS; MEDICATED HAIR CARE PREPARATIONS; MEDICATED HAIR STYLING PREPARATIONS; MEDICATED SUN CREAMS, SUN BLOCK LOTIONS AND STICKS, AND MEDICATED SELF-TANNING CREAMS AND LOTIONS (U.S. CLS. 6, 18, 44, 46, 51 AND 52).

RENEE MCCRAY, EXAMINING ATTORNEY

SN 76-692,362. M TECH MFG. LTD., KOWLOON, HONG KONG, FILED 8-25-2008.

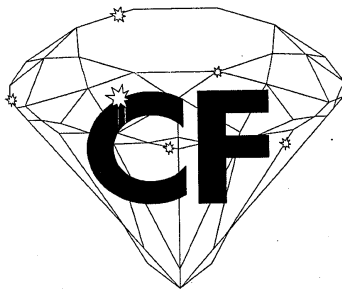

THE MARK CONSISTS OF THE SHAPE OF A CUT DIAMOND WITH STARS REPRESENTING SPARKLE AND THE LETTERS "CF" IN THE MIDDLE OF THE DESIGN

CLASS 9—ELECTRICAL AND SCIENTIFIC APPARATUS

FOR TELEPHONES; TELEPHONE SETS; TELEPHONE SETS WITH SCREEN AND KEYBOARD; CALL CENTER TELEPHONE HANDSETS; HEADSETS FOR USE WITH TELEPHONES, WIRELESS COMMUNICATION EARPHONES (U.S. CLS. 21, 23, 26, 36 AND 38).

CLASS 21—HOUSEWARES AND GLASS

FOR SCENTS RISER FOR ESSENTIAL AROMA OIL, NAMELY, FRAGRANCE OIL BURNERS (U.S. CLS. 2, 13, 23, 29, 30, 33, 40 AND 50).
CHERYL CLAYTON, EXAMINING ATTORNEY

SN 76-692,363. M TECH MFG. LTD., KOWLOON, HONG KONG, FILED 8-25-2008.

CRYSTAL FOCUS

THE MARK CONSISTS OF STANDARD CHARACTERS WITHOUT CLAIM TO ANY PARTICULAR FONT, STYLE, SIZE, OR COLOR.

CLASS 9—ELECTRICAL AND SCIENTIFIC APPARATUS

FOR TELEPHONES; TELEPHONE SETS; TELEPHONE SETS WITH SCREEN AND KEYBOARD; CALL CENTER TELEPHONE HANDSETS; HEADSETS FOR USE WITH TELEPHONES, WIRELESS COMMUNICATION EARPHONES (U.S. CLS. 21, 23, 26, 36 AND 38).

CLASS 21—HOUSEWARES AND GLASS

FOR SCENTS RISER FOR ESSENTIAL AROMA OIL, NAMELY, FRAGRANCE OIL BURNERS (U.S. CLS. 2, 13, 23, 29, 30, 33, 40 AND 50).
CHERYL CLAYTON, EXAMINING ATTORNEY

SN 76-692,413. REZZA, NANCY, DANVERS, MA. FILED 8-27-2008.

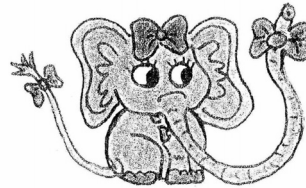

Mrs. B

CLASS 16—PAPER GOODS AND PRINTED MATTER

FOR CHILDREN'S STORY BOOKS, ACTIVITY BOOKS (U.S. CLS. 2, 5, 22, 23, 29, 37, 38 AND 50).

CLASS 25—CLOTHING

FOR CHILDREN'S PAJAMAS, UNDERWEAR, PANTS, SHIRTS, AND DRESSES (U.S. CLS. 22 AND 39).

CLASS 28—TOYS AND SPORTING GOODS

FOR CHILDREN'S MULTIPLE ACTIVITY TOYS, STUFFED DOLLS AND STUFFED TOY ANIMALS (U.S. CLS. 22, 23, 38 AND 50).
SIMON TENG, EXAMINING ATTORNEY

SN 77-016,124. FIFTH AVENUE OF LONG ISLAND REALTY ASSOCIATES, MANHASSET, NY. FILED 10-6-2006.

SN 76-692,605. WIREMASTERS, INC., COLUMBIA, TN. FILED 9-5-2008.

WIREMASTERS

AMERICANA AT MANHASSET

THE MARK CONSISTS OF STANDARD CHARACTERS WITHOUT CLAIM TO ANY PARTICULAR FONT, STYLE, SIZE, OR COLOR.

CLASS 35—ADVERTISING AND BUSINESS

FOR DISTRIBUTORSHIPS IN THE FIELD OF WIRES AND WIRE ACCESSORIES, NOT INCLUDING ELECTRICAL WIRING PANELS FOR MOTOR VEHICLES (U.S. CLS. 100, 101 AND 102).
FIRST USE 7-31-1988; IN COMMERCE 8-11-1988.

CLASS 40—MATERIAL TREATMENT

FOR TREATMENT OF METAL, NAMELY, DYEING, STRIPPING, TWISTING, HOT STAMPING, LASER MARKING, CUTTING, STRIPPING, AND CUSTOM BAR CODING OF WIRES AND WIRE ACCESSORIES, NOT INCLUDING ELECTRICAL WIRING PANELS FOR MOTOR VEHICLES (U.S. CLS. 100, 103 AND 106).
FIRST USE 7-31-1988; IN COMMERCE 8-11-1988.
CAROL SPILS, EXAMINING ATTORNEY

THE MARK CONSISTS OF STANDARD CHARACTERS WITHOUT CLAIM TO ANY PARTICULAR FONT, STYLE, SIZE, OR COLOR.

OWNER OF U.S. REG. NOS. 1,771,826 AND 2,648,932.
NO CLAIM IS MADE TO THE EXCLUSIVE RIGHT TO USE "MANHASSET", APART FROM THE MARK AS SHOWN.

CLASS 35—ADVERTISING AND BUSINESS

FOR PROMOTIONAL SERVICES, NAMELY, PROMOTING THE GOODS AND SERVICES OF SHOPPING CENTERS BY MEANS OF PROVIDING GIFT CARDS FOR USE AT THE SHOPPING CENTERS (U.S. CLS. 100, 101 AND 102).
FIRST USE 12-1-1985; IN COMMERCE 12-1-1985.

SN 76-692,658. ANGELS BASEBALL LP, ANAHEIM, CA. FILED 9-9-2008.

THE BIG A

CLASS 36—INSURANCE AND FINANCIAL

FOR CHARITABLE SERVICES, NAMELY, COORDINATION OF THE PROCUREMENT AND DISTRIBUTION OF DONATIONS OF MONEY BY SHOPPING CENTERS AND SHOPPING CENTER TENANTS TO MEET THE NEEDS OF NON-PROFIT ORGANIZATIONS (U.S. CLS. 100, 101 AND 102).
FIRST USE 12-1-1985; IN COMMERCE 12-1-1985.

THE MARK CONSISTS OF STANDARD CHARACTERS WITHOUT CLAIM TO ANY PARTICULAR FONT, STYLE, SIZE, OR COLOR.
OWNER OF U.S. REG. NOS. 1,408,209, 3,238,177 AND OTHERS.

CLASS 40—MATERIAL TREATMENT

FOR TAILORING SERVICES (U.S. CLS. 100, 103 AND 106).
FIRST USE 12-1-1985; IN COMMERCE 12-1-1985.

CLASS 12—VEHICLES

FOR LICENSE PLATE HOLDERS (U.S. CLS. 19, 21, 23, 31, 35 AND 44).
FIRST USE 6-0-2002; IN COMMERCE 6-0-2002.

CLASS 45—PERSONAL AND LEGAL SERVICES

FOR PERSONAL SHOPPING SERVICES; CONCIERGE SERVICES FOR OTHERS COMPRISING MAKING REQUESTED PERSONAL ARRANGEMENTS AND RESERVATIONS AND PROVIDING CUSTOMER-SPECIFIC INFORMATION TO MEET INDIVIDUAL NEEDS RENDERED TOGETHER IN A SHOPPING CENTER; SHOPPING CENTER SECURITY SERVICES FOR PROTECTION OF PROPERTY AND PERSONS; GIFT WRAPPING (U.S. CLS. 100 AND 101).
FIRST USE 12-1-1985; IN COMMERCE 12-1-1985.
KATHLEEN LORENZO, EXAMINING ATTORNEY

CLASS 20—FURNITURE AND ARTICLES NOT OTHERWISE CLASSIFIED

FOR NON-METAL KEY CHAINS (U.S. CLS. 2, 13, 22, 25, 32 AND 50).
FIRST USE 7-0-2003; IN COMMERCE 7-0-2003.
CHARISMA HAMPTON, EXAMINING ATTORNEY

SN 77-042,696. 1148 COMPANY INC./LA COMPAGNIE 1148 INC., MONTREAL, QUEBEC, CANADA, FILED 11-13-2006.

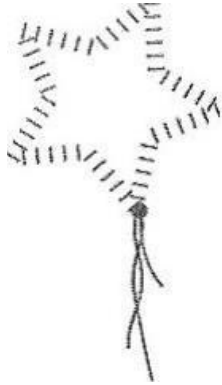

OWNER OF CANADA REG. NO. TMA712,345, DATED 4-21-2008, EXPIRES 4-21-2023.

THE MARK CONSISTS OF A STYLIZED HAND STITCHED SHOOTING STAR DESIGN.

CLASS 14—JEWELRY

FOR WATCHES; JEWELRY; WATCH STRAPS; CIGAR-ETTE CASES MADE OF PRECIOUS METAL (U.S. CLS. 2, 27, 28 AND 50).

CLASS 18—LEATHER GOODS

FOR LUGGAGE AND RELATED ITEMS, NAMELY, ALL-PURPOSE GEAR CARRYING BAGS; ATHLETIC BAGS; ATTACHE CASES; BACKPACKS; BARREL BAGS; BEACH BAGS; BILLFOLDS; BRIEFCASES; BUSINESS CARD CASES; CHANGE PURSES; CLUTCH BAGS; COSMETIC CASES SOLD EMPTY; DRAWSTRING POUCHES; DUFFEL BAGS; DUFFEL TOTE BAGS; FLIGHT BAGS; GARMENT BAGS FOR TRAVEL; GARMENT TRAVEL BAGS; GYM BAGS; KEY CASES; OVER-NIGHT BAGS; PARASOLS; PURSES; SCHOOL BAGS; SHOULDER BAGS; SPORT BAGS; STADIUM TOTE BAGS; SUIT BAGS FOR TRAVEL; SUITCASES; TOILETRY BAGS SOLD EMPTY; TOILETRY POUCHES SOLD EMPTY; TOTE BAGS; TRAVELING BAGS; TRAVELING CASES; UMBRELLAS; VANITY CASES SOLD EMPTY; WALLETS; WARDROBE BAGS FOR TRAVEL (U.S. CLS. 1, 2, 3, 22 AND 41).

CLASS 25—CLOTHING

FOR MEN'S, LADIES, WOMEN'S, CHILDREN AND TEENS' WEARING APPAREL, NAMELY, SHIRTS; DRESS SHIRTS; SPORT SHIRTS; KNIT SHIRTS; T-SHIRTS; OVER-SHIRTS; BLOUSES; HALTERS; SWEAT SHIRTS; TURTLENECK SHIRTS; MOCK TURTLENECK SHIRTS; POLO SHIRTS; TANK TOPS; SWEAT TOPS; JERSEYS; CAMISOLES; CHEMISES; BASEBALL SHIRTS; PULLOVER TOPS WITH POUCH POCKETS; MUSCLE TOPS; FITTED TOPS; GOLF SHIRTS; NIGHT SHIRTS; CARDIGANS; SLEEVELESS SWEATERS; SHORT SLEEVED SWEATERS; LONG SLEEVED SWEATERS; PULLOVERS; WARM-UP TOPS; SINGLET; PANTS; TROUSERS; SLACKS; JEANS; SWEAT PANTS; WARM-UP PANTS; PANTALOONS; ROMPERS; JODHPURS; JUMPERS; SHORTS; WALKING SHORTS; BERMUDAS; BOARDWALK SHORTS; CULOTTES; PARKAS; PEA JACKETS; BOMBER JACKETS; TOPCOATS; DUFFEL COATS; RAIN COATS; TRENCH COATS; WAIST COATS; OVERCOATS; SWEAT JACKETS; JACKETS; SUITS; BLAZERS; TUXEDOS; WIND RESISTANT JACKETS; PONCHOS; RAIN SUITS; TRAINING SUITS; PLAY-SUITS; COVERALLS; OVERALLS; SHORTALLS; JUMP-SUITS; JOGGING SUITS; SWEAT SUITS; SUN SUITS; WARM-UP SUITS; UNIFORMS; DRESSES; GOWNS; SKIRTS; KIMONOS; COATS; HOUSECOATS; SMOCKS; SHOP COATS; PAJAMAS; SLEEP WEAR; DRESSING GOWNS; ROBES; BATHROBES; SLEEPERS; UNDERWEAR; BOXER SHORTS; BOXER BRIEFS; TIGHTS; MITTENS; SKI BIBS; WRISTBANDS; CLOTH DIAPER SETS; BANDANAS; NECKTIES; HATS; CAPS; VISORS; TUQUES; BERETS; BELTS; SUSPENDERS; SCARVES; GLOVES; HEADBANDS; HOSIERY; SOCKS (U.S. CLS. 22 AND 39).

JENNIFER VASQUEZ, EXAMINING ATTORNEY

SN 77-044,837. AMERICAN INFRASTRUCTURE, INC., WORCESTER, PA. FILED 11-15-2006.



NO CLAIM IS MADE TO THE EXCLUSIVE RIGHT TO USE "CONSTRUCTION MATERIALS", APART FROM THE MARK AS SHOWN.

THE MARK CONSISTS OF THE WORDING INDEPENDENCE "CONSTRUCTION MATERIALS" WITH A CIRCLE OF STARS AROUND THE LETTERS "INDE".

CLASS 35—ADVERTISING AND BUSINESS

FOR BUSINESS INFORMATION MANAGEMENT IN THE FIELD OF HEAVY CIVIL CONSTRUCTION; SUPPLY SERVICES FOR THIRD PARTIES IN THE FIELD OF CONSTRUCTION MATERIALS, NAMELY, WHOLESALE DISTRIBUTORSHIP SERVICES FEATURING AGGREGATE, ASPHALT, AND CONCRETE FOR OTHER COMPANIES (U.S. CLS. 100, 101 AND 102).

FIRST USE 6-16-1998; IN COMMERCE 6-16-1998.

CLASS 37—CONSTRUCTION AND REPAIR

FOR CONSTRUCTION CONSULTATION; CONSTRUCTION MANAGEMENT; CONSTRUCTION PLANNING; BUILDING CONSTRUCTION FOR RESIDENTIAL, COMMERCIAL, AND INSTITUTIONAL USE; CONSULTATION SERVICES FOR THE CONSTRUCTION OF WATER AND WASTEWATER PLANTS; CONSTRUCTION OF WATER AND WASTEWATER PLANTS; LAYING AND CONSTRUCTION OF PIPELINES; ROAD AND HIGHWAY CONSTRUCTION; ROAD AND HIGHWAY PAVING SERVICES; BRIDGE CONSTRUCTION; EXCAVATION SERVICES; QUARRY SERVICES (U.S. CLS. 100, 103 AND 106).

FIRST USE 6-16-1998; IN COMMERCE 6-16-1998.

CLASS 40—MATERIAL TREATMENT

FOR QUARRY SERVICES IN THE NATURE OF STONE-CRUSHING (U.S. CLS. 100, 103 AND 106).
FIRST USE 6-16-1998; IN COMMERCE 6-16-1998.
DAVID ELTON, EXAMINING ATTORNEY

CLASS 35—ADVERTISING AND BUSINESS

FOR ADVERTISING AGENCIES; BUSINESS ADMINISTRATION AND MANAGEMENT; PROVIDING OFFICE FUNCTIONS (U.S. CLS. 100, 101 AND 102).
MICHAEL SOUDERS, EXAMINING ATTORNEY

SN 77-058,224. COIN S.P.A., VENEZIA, ITALY, FILED 12-6-2006.

SN 77-068,761. KAI U.S.A., LTD., TUALATIN, OR. FILED 12-20-2006.

JCT

THE MARK CONSISTS OF STANDARD CHARACTERS WITHOUT CLAIM TO ANY PARTICULAR FONT, STYLE, SIZE, OR COLOR.

PRIORITY CLAIMED UNDER SEC. 44(D) ON ITALY APPLICATION NO. MI2006C01178, FILED 11-28-2006, REG. NO. 1029124, DATED 11-20-2007, EXPIRES 11-20-2015.

PRIORITY CLAIMED UNDER SEC. 44(D) ON ITALY APPLICATION NO. MI2006C00983, FILED 10-4-2006, REG. NO. 1029124, DATED 11-20-2007, EXPIRES 11-20-2015.

PRIORITY CLAIMED UNDER SEC. 44(D) ON ITALY APPLICATION NO. MI2006C01104, FILED 11-8-2006, REG. NO. 1033491, DATED 11-20-2007, EXPIRES 11-20-2015.

CLASS 9—ELECTRICAL AND SCIENTIFIC APPARATUS

FOR SUNGLASSES, EYEGLASSES, LENSES AND FRAMES FOR SUNGLASSES AND EYEGLASSES, THEIR PARTS AND ACCESSORIES, CASES AND HOLDERS FOR SUNGLASSES AND EYEGLASSES (U.S. CLS. 21, 23, 26, 36 AND 38).

CLASS 18—LEATHER GOODS

FOR ALL PURPOSE CARRYING BAGS, HANDBAGS, BRIEFCASES, RUCKSACKS, TRAVELING BAGS AND TRUNKS FOR TRAVELING; HOLDALLS; TOILETRY CASES SOLD EMPTY; KEY CASES; CASES FOR BUSINESS AND CREDIT CARDS; WALLETS AND PURSES, ALL BEING ARTICLES MADE OF IMITATION LEATHER, UMBRELLAS, PARASOLS; WALKING STICKS (U.S. CLS. 1, 2, 3, 22 AND 41).

CLASS 24—FABRICS

FOR LINEN, WOOL, SILK AND COTTON FABRICS ALONE OR IN COMBINATION WITH EACH OTHER AND/OR MIXED WITH SYNTHETIC FABRICS, ALL FOR CLOTHING AS WELL AS FURNISHINGS AND INTERIOR DECORATIONS; BATH TOWELS; KITCHEN TOWELS; CLOTH NAPKINS; TABLE CLOTHS MADE OF CLOTH; BED COVER, NAMELY, PILLOW CASES, SHEET AND QUILTS (U.S. CLS. 42 AND 50).

CLASS 25—CLOTHING

FOR CASUAL CLOTHING, NAMELY, JEANS, T-SHIRTS, SKIRTS, TROUSERS, TOPS, BERMUDA SHORTS, BOTTOM NECK SWEATERS; BEACHWEAR, EXERCISE CLOTHING, NAMELY, JOGGING SUITS, JOGGING T-SHIRTS, SPORT UNDERWEAR; RAINWEAR, OUTDOOR PROTECTIVE CLOTHING, NAMELY, COATS, HEAVY JACKETS, RAINCOATS; SPORTS CLOTHING, NAMELY, TRACKSUITS, TRAINING SHOES, SPORT TOPS AND UNDERWEAR; DRESSES, SKIRTS, BLOUSES, SWEATSHIRTS, T-SHIRTS, UNDERWEAR SHIRTS, SHIRTS, SWEATERS, SPORTS SHIRTS, KNIT SHIRTS, JACKETS, WAIST-COATS, POLO SHIRTS, PANTS, SPORTS JACKETS AND RAIN COATS; FOOTWEAR, FABRIC FOOTWEAR, SOCKS, SCARVES, NECKERCHIEFS, FABRIC BELTS, TIES; HATS (U.S. CLS. 22 AND 39).

KAJI

THE MARK CONSISTS OF STANDARD CHARACTERS WITHOUT CLAIM TO ANY PARTICULAR FONT, STYLE, SIZE, OR COLOR.

THE ENGLISH TRANSLATION OF THE WORD "KAJI" IN THE MARK IS "THE BLACKSMITH'S FORGE".

CLASS 7—MACHINERY

FOR ELECTRIC KNIFE SHARPENERS; ELECTRIC FRUIT AND VEGETABLE PEELERS; ELECTRIC CAN OPENERS (U.S. CLS. 13, 19, 21, 23, 31, 34 AND 35).

CLASS 8—HAND TOOLS

FOR KITCHEN KNIVES; TABLE CUTLERY, NAMELY, FORKS, KNIVES, AND SPOONS; KNIFE SHARPENERS; MANDOLINES; NON-ELECTRIC FRUIT AND VEGETABLE PEELERS; NON-ELECTRIC CAN OPENERS; MEAT TENDERIZERS, NAMELY, KITCHEN MALLETS (U.S. CLS. 23, 28 AND 44).

CLASS 9—ELECTRICAL AND SCIENTIFIC APPARATUS

FOR MEASURING CUPS AND MEASURING SPOONS; FOOD TIMERS (U.S. CLS. 21, 23, 26, 36 AND 38).

CLASS 21—HOUSEWARES AND GLASS

FOR HOUSEHOLD KITCHEN TOOLS AND UTENSILS, NAMELY, WHISKS, SPATULAS, SERVING TONGS, BASTING SPOONS, MIXING SPOONS, SERVING SPOONS, SLOTTED SPOONS, GARLIC PRESSES, STRAINERS, COLANDERS AND BOWLS; COOKWARE, NAMELY, POTS AND PANS; CUTTING BOARDS; AND KNIFE BLOCKS (U.S. CLS. 2, 13, 23, 29, 30, 33, 40 AND 50).

JENNIFER VASQUEZ, EXAMINING ATTORNEY

SN 77-069,730. DAIMLER AG, STUTTGART, FED REP GERMANY, FILED 12-21-2006.

TWINSTORE

THE MARK CONSISTS OF STANDARD CHARACTERS WITHOUT CLAIM TO ANY PARTICULAR FONT, STYLE, SIZE, OR COLOR.

PRIORITY CLAIMED UNDER SEC. 44(D) ON ERPNTY TM OFC APPLICATION NO. 005268313, FILED 8-21-2006, REG. NO. 005268313, DATED 9-17-2007, EXPIRES 8-21-2016.

CLASS 6—METAL GOODS

FOR METAL STORAGE TANKS FOR HYDROGEN IN LIQUID, GASEOUS AND SOLID FORM (U.S. CLS. 2, 12, 13, 14, 23, 25 AND 50).

CLASS 9—ELECTRICAL AND SCIENTIFIC APPARATUS

FOR FUEL CELLS; REFORMERS FOR FUEL CELLS; BATTERIES; FUEL CELLS FOR MOTOR VEHICLES (U.S. CLS. 21, 23, 26, 36 AND 38).

CLASS 20—FURNITURE AND ARTICLES NOT OTHERWISE CLASSIFIED

FOR PLASTIC STORAGE TANKS FOR HYDROGEN IN LIQUID, GASEOUS AND SOLID FORM (U.S. CLS. 2, 13, 22, 25, 32 AND 50).

RENEE MCCRAY, EXAMINING ATTORNEY

CLASS 36—INSURANCE AND FINANCIAL

FOR FINANCIAL INFORMATION PROCESSING; FINANCIAL INFORMATION PROVIDED BY ELECTRONIC MEANS; CASH AND FOREIGN EXCHANGE TRANSACTIONS; FOREIGN EXCHANGE INFORMATION SERVICES; MONETARY EXCHANGE; ELECTRONIC FUNDS TRANSFER; FOREIGN EXCHANGE SERVICES, NAMELY, CURRENCY EXCHANGE SERVICES; CURRENCY EXCHANGE RATE QUOTATIONS; BROKERAGE OF CURRENCY; FORECASTING OF FOREIGN EXCHANGE RATES; FOREIGN MONETARY EXCHANGE; PROVISION OF FINANCIAL PROTECTION AGAINST FOREIGN EXCHANGE RISKS; FINANCIAL TRANSACTIONS RELATING TO CURRENCY SWAPS; FOREIGN EXCHANGE TRANSACTION SERVICES; INFORMATION AND ADVISORY SERVICES RELATING TO ALL THE AFORESAID SERVICES; PROVIDING A WIDE RANGE OF FOREIGN EXCHANGE INFORMATION VIA THE INTERNET; PROVIDING INTERACTIVE DATABASES FEATURING INFORMATION IN THE FIELD OF FOREIGN EXCHANGE; PROVIDING INTERNET LINKS TO WEB SITES OF OTHERS FEATURING INFORMATION IN THE FIELD OF FOREIGN EXCHANGE (U.S. CLS. 100, 101 AND 102).

CLASS 38—COMMUNICATION

FOR TELECOMMUNICATIONS SERVICES, NAMELY, COMMUNICATIONS VIA MULTINATIONAL TELECOMMUNICATION NETWORKS; PROVISION OF ACCESS TO THE INTERNET; PROVIDING MULTIPLE USER ACCESS TO A GLOBAL COMPUTER INFORMATION NETWORK (U.S. CLS. 100, 101 AND 104).

CLASS 42—SCIENTIFIC AND COMPUTER SERVICES

FOR COMPUTER PROGRAMMING; CREATION, INSTALLATION, SERVICING AND MAINTENANCE OF COMPUTER SOFTWARE; INFORMATION TECHNOLOGY SUPPORT AND CONSULTANCY SERVICES, NAMELY, INFORMATION TECHNOLOGY SUPPORT AND CONSULTANCY SERVICES RELATING TO THE TECHNICAL OPERATION AND CUSTOMIZATION OF COMPUTER PROGRAMS AND SOFTWARE FOR USE IN THE FIELD OF FINANCE, FOREIGN EXCHANGE AND BANKING (U.S. CLS. 100 AND 101).

JEAN IM, EXAMINING ATTORNEY

SN 77-069,867. THE ROYAL BANK OF SCOTLAND GROUP PLC, EDINBURGH, UNITED KINGDOM, FILED 12-21-2006.

FXMICROPAY

THE MARK CONSISTS OF STANDARD CHARACTERS WITHOUT CLAIM TO ANY PARTICULAR FONT, STYLE, SIZE, OR COLOR.

OWNER OF UNITED KINGDOM REG. NO. 2417303D, DATED 4-27-2007, EXPIRES 3-22-2016.

CLASS 9—ELECTRICAL AND SCIENTIFIC APPARATUS

FOR COMPUTER SOFTWARE AND COMPUTER PROGRAMS FOR USE IN THE ESTABLISHMENT AND OPERATION OF AN E-COMMERCE FINANCIAL MARKETPLACE FEATURING A FOREIGN EXCHANGE MANAGEMENT TOOL; SOFTWARE PROVIDING FINANCIAL AND BANKING SOLUTIONS, NAMELY, FOR PROCESSING FOREIGN EXCHANGE TRANSACTIONS; DOWNLOADABLE AUDIO FILES/MULTIMEDIA FILES, TEXT FILES, EMAILS, WRITTEN DOCUMENTS, AUDIO MATERIAL AND VIDEO MATERIAL FEATURING INFORMATION IN THE FIELD OF FOREIGN EXCHANGE AND BANKING, AND FINANCIAL PRODUCTS SUPPLIED ON-LINE FROM A DATABASE OR FROM FACILITIES PROVIDED ON THE INTERNET OR OTHER NETWORK (U.S. CLS. 21, 23, 26, 36 AND 38).

CLASS 35—ADVERTISING AND BUSINESS

FOR PROVISION OF A SECURE INTERNET MARKETPLACE IN THE FIELD OF FINANCIAL PRODUCTS; BUSINESS INFORMATION AND CONSULTANCY SERVICES, INCLUDING SUCH SERVICES PROVIDED ONLINE OR FROM A COMPUTER DATABASE OR NETWORK, INCLUDING THE INTERNET; PROVISION OF SPACE ON WEBSITES FOR ADVERTISING GOODS AND SERVICES; RENTAL OF ADVERTISING SPACE (U.S. CLS. 100, 101 AND 102).

SN 77-086,937. THE INTERNATIONAL DOUGHNUT PLANT LLC, NEW YORK, NY. FILED 1-19-2007.

BLACKOUT CAKE DOUGHNUT

THE MARK CONSISTS OF STANDARD CHARACTERS WITHOUT CLAIM TO ANY PARTICULAR FONT, STYLE, SIZE, OR COLOR.

NO CLAIM IS MADE TO THE EXCLUSIVE RIGHT TO USE "CAKE DOUGHNUT", APART FROM THE MARK AS SHOWN.

CLASS 29—MEATS AND PROCESSED FOODS

FOR FRUIT, VEGETABLE, CHEESE, MILK, NUT, SEED, AND LEGUME BASED FILLINGS FOR DOUGHNUTS, COOKIES, CAKES, PASTRIES, PIES, PATTIES, CRUSTS, SWEET DOUGHS, SAVORY DOUGHS; EDIBLE OILS AND FATS; FRUIT, VEGETABLE, CHEESE, MILK, GRAIN, LEGUME, NUT, TOPPING, WHIPPED DAIRY TOPPING; SHORTENINGS; PATTIES MADE OF VEGETABLE, SOY, NUTS, SEEDS, AND BEANS (U.S. CL. 46).

FIRST USE 6-6-2006; IN COMMERCE 9-7-2006.

CLASS 30—STAPLE FOODS

FOR COOKIES, CAKES, PASTRIES, PIES, PATTIES MADE OF GRAINS, CRUSTS, SWEET DOUGHS, AND SAVORY DOUGHS; DOUGHNUTS; BAKERY PRODUCTS; SWEET DOUGH; SAVORY DOUGH; COFFEE; TEA; COOKIES MADE WITH FRUIT, VEGETABLES, LEGUMES, NUTS, SEEDS, DAIRY PRODUCTS, COCOA, SUGAR, AND/OR SALT; CAKES; ROLLS; BREADS; PIES; MUFFINS; PLAIN, SAVORY, GLAZED, COATED, FILLED, FIRED, BAKED, COOKED, STEAMED, AND BOILED CAKES; CAKE MIXES; PASTRIES; DOUGH-BASED POCKETS WITH FILLING CONSISTING PRIMARILY OF PASTA, RICE, VEGETABLES, FRUITS AND/OR CHEESES BAGELS; FILLINGS BASED ON GRAINS OR CHOCOLATE FOR DOUGHNUTS, CAKES, PIES, PASTRIES, PATTIES, COOKIES, CRUSTS, SWEET DOUGHS, AND SAVORY DOUGHS; CHOCOLATE TOP-PINGS; FLOUR; FLAVORING EXTRACTS; CONFECTIONERY CHIPS FOR BAKING; HONEY; YEAST; BAKING POWDER; HOT CHOCOLATE; HOT COCOA, GLAZES BASED ON FRUITS, VEGETABLES, CHEESE, MILK, GRAINS, LEGUME, NUTS AND SEEDS (U.S. CL. 46).

FIRST USE 6-6-2006; IN COMMERCE 9-7-2006.
LINDA M. KING, EXAMINING ATTORNEY

CLASS 41—EDUCATION AND ENTERTAINMENT

FOR ENTERTAINMENT SERVICES, NAMELY, ORGANIZING LIVE CONCERTS, BAND COMPETITIONS, DANCING EVENTS, FASHION SHOWS, AUTO SHOWS, BEAUTY COMPETITIONS, FITNESS COMPETITIONS, FIGHT COMPETITIONS, SURFING COMPETITIONS, BICYCLE COMPETITIONS, MOTORCYCLE COMPETITIONS, SKATEBOARD COMPETITIONS, AND POKER COMPETITIONS; ENTERTAINMENT SERVICES PROVIDED OVER A GLOBAL COMPUTER NETWORK, NAMELY, PROVIDING ON-LINE INTERACTIVE GAMES AND ON-LINE MULTI-PLAYER GAMES; ENTERTAINMENT SERVICES, NAMELY, PROVIDING ON-LINE WEB LOGS AND VIDEO WEB LOGS FEATURING SPORTS AND MUSIC; PROVIDING A WEBSITE FEATURING SPORTS, CURRENT EVENT NEWS, AND ENTERTAINMENT INFORMATION; PROVIDING ON-LINE INFORMATION IN THE FIELD OF SPORTS, SPORTS NEWS, MUSIC NEWS, ENTERTAINMENT NEWS, NATIONAL NEWS, AND INTERNATIONAL NEWS, AND ENTERTAINMENT FEATURING SPORTS, MUSIC, AND COMEDY; ON-LINE SWEEPSTAKES SERVICES (U.S. CLS. 100, 101 AND 107).

REBECCA POVARCHUK, EXAMINING ATTORNEY

SN 77-093,730. JACK9, INC., LAS VEGAS, NV. FILED 1-29-2007.

SN 77-098,817. TRANSURBAN LIMITED, MELBOURNE, AUSTRALIA, FILED 2-4-2007.

JACK9

THE MARK CONSISTS OF STANDARD CHARACTERS WITHOUT CLAIM TO ANY PARTICULAR FONT, STYLE, SIZE, OR COLOR.

CLASS 25—CLOTHING

FOR CLOTHING FOR MEN AND WOMEN, NAMELY, T-SHIRTS, SHIRTS, TANK TOPS, JERSEYS, SKIRTS, SHORTS, JEANS, PANTS, SWEAT SHIRTS, SWEAT PANTS, JACKETS, COATS, CAPS, HATS, AND UNIFORMS (U.S. CLS. 22 AND 39).

CLASS 35—ADVERTISING AND BUSINESS

FOR ADVERTISING SERVICES, NAMELY, PROMOTING THE GOODS AND SERVICES OF OTHERS AND PROMOTING THE GOODS AND SERVICES OF OTHERS OVER A GLOBAL COMPUTER NETWORK; ON-LINE RETAIL STORE SERVICES FEATURING SPORTING GOODS AND EQUIPMENT, CLOTHING, JEWELRY, GAMES, CDS, VIDEOTAPES, DVDS, ELECTRONICS, BOOKS AND MUSIC; PROMOTING THE GOODS AND SERVICES OF OTHERS THROUGH PROVIDING ON-LINE PROMOTIONS, GIVEAWAYS, COMPETITIONS, CONTESTS, AND REDEMPTION GAMES; PROMOTING THE LIVE SPORTS, MUSIC, AND ENTERTAINMENT EVENTS OF OTHERS (U.S. CLS. 100, 101 AND 102).



The logo for 'transurban' features the word in a bold, lowercase, sans-serif font. Below the text is a stylized graphic consisting of two curved lines that sweep upwards and to the right, resembling a wave or a swoosh.

OWNER OF AUSTRALIA REG. NO. 920701, DATED 7-23-2002, EXPIRES 7-23-2012.

THE MARK CONSISTS OF THE STYLIZED LETTERING OF "TRANSURBAN" WITH TWO SOLID WAVE DESIGNS APPEARING BELOW THE TEXT.

CLASS 6—METAL GOODS

FOR SIGNS, NAMELY, ROAD SIGNS OF METAL (U.S. CLS. 2, 12, 13, 14, 23, 25 AND 50).

CLASS 9—ELECTRICAL AND SCIENTIFIC APPARATUS

FOR COMPUTER HARDWARE AND SOFTWARE FOR ELECTRONIC ROAD, BRIDGE AND TUNNEL TOLL SYSTEMS OR FOR FACILITATING THE PAYMENT OF GOODS AND SERVICES; COMPUTER HARDWARE AND SOFTWARE THAT PROVIDES FUNCTIONALITY IN THE AREAS OF MANAGING CUSTOMER RELATIONSHIPS, FULFILLING CUSTOMER REQUIREMENTS, MANAGING RETAIL PRODUCTS AND SERVICES, CUSTOMER REVENUE MANAGEMENT, MANAGING RETAIL OPERATIONS, MANAGING DATA INTERCHANGE, MANAGING INTEROPERABILITY, IDENTIFYING/ CONSTRUCTING AND RATING ASSET USAGE, MANAGING ALARMS ASSOCIATED WITH ASSET EQUIPMENT, MANAGING ENFORCEMENT, MONITORING OF THE NETWORK THAT CONNECTS THE ROADSIDE EQUIPMENT TO THE CENTRAL SITE, FINANCIAL MANAGEMENT; ELECTRIC AND ELECTRONIC DEVICES AND APPARATUS FOR FACILITATING THE PAYMENT OF GOODS AND SERVICES, NAMELY, RADIO FREQUENCY IDENTIFICATION CREDENTIALS, NAMELY, CARDS AND TAGS, AND READERS FOR RADIO FREQUENCY IDENTIFICATION CREDENTIALS; ELECTRONIC DEVICES INSTALLED IN MOTOR VEHICLES OR ELSEWHERE WHICH TRANSMIT AND RECEIVE INFORMATION, THROUGH ELECTRONIC SIGNALS, RELATING TO VEHICLE IDENTIFICATION AND THE PAYMENT OF CHARGES AND FEES INCLUDING ROAD TOLLS; LUMINOUS OR MECHANICAL ELECTRONIC ROAD SIGNS; PUBLICATIONS IN ELECTRONIC FORM, NAMELY, MAGAZINES, NEWSLETTERS, AND MANUALS RELATING TO ROAD TOLL SYSTEMS, PAYMENT SYSTEMS, AND HIGHWAY INFRASTRUCTURE, RECORDED ON COMPUTER MEDIA (U.S. CLS. 21, 23, 26, 36 AND 38).

CLASS 16—PAPER GOODS AND PRINTED MATTER

FOR PRINTED MATTER AND PUBLICATIONS IN THE NATURE OF BROCHURES, PAMPHLETS, NEWSLETTERS, FLYERS, AND MANUALS IN THE FIELD OF ROAD TOLL SYSTEMS, HIGHWAY INFRASTRUCTURE, AND PAYMENT SYSTEMS; PRINTED SIGNS, POSTERS, BOOKS IN THE FIELD OF ROAD TOLL SYSTEMS, HIGHWAY INFRASTRUCTURE, AND PAYMENT SYSTEMS; MAPS, MEMBERS CARDS, NAMELY, PRINTED PAPER CARDS AND PRINTED APPLICATION FORMS (U.S. CLS. 2, 5, 22, 23, 29, 37, 38 AND 50).

CLASS 25—CLOTHING

FOR CLOTHING, NAMELY, SHIRTS, JACKETS AND TROUSERS; FOOTWEAR AND HEADGEAR, NAMELY, HATS, CAPS, AND VISORS (U.S. CLS. 22 AND 39).

CLASS 36—INSURANCE AND FINANCIAL

FOR FINANCIAL CONSULTANCY SERVICES CONCERNING ROAD TOLL SYSTEMS AND ELECTRONIC PAYMENT SYSTEMS; BILL PAYMENT SERVICES; HIGHWAY TOLL COLLECTION SERVICES; PROVIDING INFORMATION IN THE FIELD OF ROAD TOLL COLLECTION SYSTEMS (U.S. CLS. 100, 101 AND 102).

CLASS 37—CONSTRUCTION AND REPAIR

FOR ROAD CONSTRUCTION; MAINTENANCE AND REPAIR OF ROADS; MAINTENANCE AND REPAIR OF ROAD TOLL SYSTEMS; MAINTENANCE AND REPAIR SERVICES OF ROAD SIDE EQUIPMENT, SAFETY SYSTEMS, TRAFFIC FLOW SYSTEMS AND INCIDENT RESPONSE SYSTEMS; CONSTRUCTION CONSULTING SERVICES; PROVIDING INFORMATION IN THE FIELD OF CONSTRUCTION OF TOLL ROADS (U.S. CLS. 100, 103 AND 106).

CLASS 39—TRANSPORTATION AND STORAGE

FOR TRANSPORTATION SERVICES, NAMELY, PROVIDING A PRIVATE HIGHWAY FOR OTHERS; PROVIDING INFORMATION IN THE FIELD OF TRANSPORTATION; CONSULTATION SERVICES IN THE FIELD OF TRANSPORTATION INFRASTRUCTURE TRANSPORTATION, TRANSPORTATION, AND VEHICLE PARKING; VEHICLE PARKING SERVICES; PROVIDING VEHICLE PARKING FACILITIES (U.S. CLS. 100 AND 105).

JANET LEE, EXAMINING ATTORNEY

SN 77-103,659. CYTOSPORT, INC., BENICIA, CA. FILED 2-9-2007.

MIGHTY MILK N' OATS

THE MARK CONSISTS OF STANDARD CHARACTERS WITHOUT CLAIM TO ANY PARTICULAR FONT, STYLE, SIZE, OR COLOR.

OWNER OF U.S. REG. NO. 3,132,139.

NO CLAIM IS MADE TO THE EXCLUSIVE RIGHT TO USE "OATS", APART FROM THE MARK AS SHOWN.

CLASS 5—PHARMACEUTICALS

FOR DIETARY AND NUTRITIONAL SUPPLEMENT (U.S. CLS. 6, 18, 44, 46, 51 AND 52).

CLASS 30—STAPLE FOODS

FOR FORTIFIED FOOD, NAMELY, PROTEIN BASED, NUTRIENT-DENSE OATMEAL (U.S. CL. 46).
ELLEN PERKINS, EXAMINING ATTORNEY

SN 77-114,700. MOTO-LITA LIMITED, HAMPSHIRE, UNITED KINGDOM, FILED 2-23-2007.



PRIORITY CLAIMED UNDER SEC. 44(D) ON ERPN CMNTY TM OFC APPLICATION NO. 005419999, FILED 10-26-2006, REG. NO. 005419999, DATED 9-5-2007, EXPIRES 10-26-2016.

OWNER OF U.S. REG. NO. 954,914.

THE COLOR(S) GREEN IS/ARE CLAIMED AS A FEATURE OF THE MARK.

THE MARK CONSISTS OF THE COLOR GREEN ON THE RECTANGULAR DESIGN ELEMENT. THE COLOR WHITE APPEARS ON THE LETTERING IN THE MARK, BUT CONSTITUTES TRANSPARENT AREAS AND IS NOT PART OF THE MARK.

CLASS 25—CLOTHING

FOR ARTICLES OF CLOTHING, NAMELY, JACKETS, BLOUSON, SWEAT SHIRTS, T-SHIRTS, POLO SHIRTS, SWEATERS, CAPS, SUN VISORS, TIES, SCARVES, BELTS, HATS, GLOVES, BALACLAVA; FLIGHT SUITS, FLYING JACKETS, FLYING TROUSERS; VISORS (U.S. CLS. 22 AND 39).

CLASS 35—ADVERTISING AND BUSINESS

FOR RETAIL STORE SERVICES, ONLINE RETAIL STORE SERVICES, MAIL ORDER SERVICES AND CATALOGUE ORDERING SERVICES FEATURING CLOTHING (U.S. CLS. 100, 101 AND 102).

MARK RADEMACHER, EXAMINING ATTORNEY

SN 77-138,191. WHAM-O, INC., EMERYVILLE, CA. FILED 3-22-2007.

MONSTER MAGNET

THE MARK CONSISTS OF STANDARD CHARACTERS WITHOUT CLAIM TO ANY PARTICULAR FONT, STYLE, SIZE, OR COLOR.

NO CLAIM IS MADE TO THE EXCLUSIVE RIGHT TO USE "MAGNET" AS TO CLASS 28, APART FROM THE MARK AS SHOWN.

CLASS 16—PAPER GOODS AND PRINTED MATTER

FOR CHILDREN'S BOOKS; SERIES OF FICTION BOOKS FOR CHILDREN; CALENDARS; NOTE CARDS; STATIONERY; AUTOGRAPH BOOKS; PAPER BOOK MARKERS; CARDS BEARING UNIVERSAL GREETINGS; CHILDREN'S ACTIVITY BOOKS; COLORING BOOKS; DAILY PLANNERS; DATE BOOKS; GREETING CARDS; MUSICAL GREETING CARDS; NOTE BOOKS; NOTE CARDS; PAPER MACHE FIGURINES; PAPER WEIGHTS; PERSONAL ORGANIZERS; PHOTOGRAPH ALBUMS; PICTURE BOOKS; PICTURE POSTCARDS; POCKET CALENDARS; POSTCARDS; PRINTED GREETING CARDS WITH ELECTRONIC INFORMATION STORED THEREIN; SCRAPBOOKS; SKETCH BOOKS; SONG BOOKS; STICKER BOOKS; STICKERS; TEMPORARY TATTOOS; TRADING CARDS; TRIVIA CARDS (U.S. CLS. 2, 5, 22, 23, 29, 37, 38 AND 50).

CLASS 25—CLOTHING

FOR SHIRTS; HATS; ATHLETIC SHOES; BATHROBES; BELTS; BLOUSES; BOXER SHORTS; CAPS; CHILDREN'S FOOTWEAR; COATS; COSTUMES FOR USE IN ROLE PLAYING GAMES; DRESSES; FITNESS TOPS; GLOVES; HALLOWEEN COSTUMES; HEADBANDS; HOSIERY; JACKETS; JOGGING SUITS; JUMPSUITS; LONG UNDERWEAR; MASQUERADE COSTUMES AND MASQUERADE ACCESSORIES, NAMELY MASKS SOLD IN CONNECTION THEREWITH; MITTENS; NIGHTSHIRTS; NIGHTGOWNS; OVERALLS; PAJAMAS; PANTS; PARKAS; POLO SHIRTS; RAINWEAR; SCARVES; SHOES; SHORTS; SKIRTS; SLEEPWEAR; SLIPPERS; SOCKS; SUSPENDERS; SWEATERS; SWEATPANTS; SWEATSHIRTS; SWEAT SUITS; SWIM WEAR; TANK TOPS; TIES; TIGHTS; T-SHIRTS; UNDERWEAR; VISORS; WARM-UP SUITS; WIND-RESISTANT JACKETS; WRISTBANDS (U.S. CLS. 22 AND 39).

CLASS 28—TOYS AND SPORTING GOODS

FOR CHILDREN'S TOY MAGNETS (U.S. CLS. 22, 23, 38 AND 50).

JULIE VEPPUMTHARA, EXAMINING ATTORNEY

SN 77-139,530. SACHEM, INC., AUSTIN, TX. FILED 3-24-2007.



mobius system

NO CLAIM IS MADE TO THE EXCLUSIVE RIGHT TO USE "SYSTEM", APART FROM THE MARK AS SHOWN.

THE COLOR(S) GREEN, YELLOW-GREEN, DARK GREEN IS/ARE CLAIMED AS A FEATURE OF THE MARK.

THE MARK CONSISTS OF THE WORDS "MOBIUS SYSTEM" AND THE ROUNDED SYMBOL HAVING A MOBIUS STRIP APPEARANCE AND INCLUDING THE COLORS GREEN, YELLOW-GREEN AND DARK GREEN.

CLASS 1—CHEMICALS

FOR RECYCLED QUATERNARY AMMONIUM COMPOUNDS (U.S. CLS. 1, 5, 6, 10, 26 AND 46).

CLASS 7—MACHINERY

FOR MACHINERY FOR RECYCLING QUATERNARY AMMONIUM COMPOUNDS (U.S. CLS. 13, 19, 21, 23, 31, 34 AND 35).

CLASS 11—ENVIRONMENTAL CONTROL APPARATUS

FOR FILTERS AND PURIFIERS FOR REMOVING CONTAMINANTS FROM QUATERNARY AMMONIUM COMPOUNDS; SEPARATORS FOR THE CLEANING AND PURIFICATION OF QUATERNARY AMMONIUM COMPOUNDS (U.S. CLS. 13, 21, 23, 31 AND 34).

CLASS 40—MATERIAL TREATMENT

FOR RECYCLING, NAMELY, RECYCLING QUATERNARY AMMONIUM COMPOUNDS FOR REUSE; CHEMICAL TREATMENT OF QUATERNARY AMMONIUM COMPOUNDS FOR RECYCLING AND REUSE; CHEMICAL RECYCLING SERVICES FOR QUATERNARY AMMONIUM COMPOUNDS (U.S. CLS. 100, 103 AND 106).

CLASS 42—SCIENTIFIC AND COMPUTER SERVICES

FOR DEVELOPMENT AND TESTING OF RECYCLING PROCESSES FOR QUATERNARY AMMONIUM COMPOUNDS (U.S. CLS. 100 AND 101).

STEVEN JACKSON, EXAMINING ATTORNEY

SN 77-139,532. SACHEM, INC., AUSTIN, TX. FILED 3-24-2007.

MOBIUS SYSTEM

THE MARK CONSISTS OF STANDARD CHARACTERS WITHOUT CLAIM TO ANY PARTICULAR FONT, STYLE, SIZE, OR COLOR.

NO CLAIM IS MADE TO THE EXCLUSIVE RIGHT TO USE "SYSTEM", APART FROM THE MARK AS SHOWN.

CLASS 1—CHEMICALS

FOR RECYCLED QUATERNARY AMMONIUM COMPOUNDS (U.S. CLS. 1, 5, 6, 10, 26 AND 46).

CLASS 7—MACHINERY

FOR MACHINERY FOR RECYCLING QUATERNARY AMMONIUM COMPOUNDS (U.S. CLS. 13, 19, 21, 23, 31, 34 AND 35).

CLASS 11—ENVIRONMENTAL CONTROL APPARATUS

FOR FILTERS AND PURIFIERS FOR REMOVING CONTAMINANTS FROM QUATERNARY AMMONIUM COMPOUNDS; SEPARATORS FOR THE CLEANING AND PURIFICATION OF QUATERNARY AMMONIUM COMPOUNDS (U.S. CLS. 13, 21, 23, 31 AND 34).

CLASS 40—MATERIAL TREATMENT

FOR RECYCLING, NAMELY, RECYCLING QUATERNARY AMMONIUM COMPOUNDS FOR REUSE; CHEMICAL TREATMENT OF QUATERNARY AMMONIUM COMPOUNDS FOR RECYCLING AND REUSE; CHEMICAL RECYCLING SERVICES FOR QUATERNARY AMMONIUM COMPOUNDS (U.S. CLS. 100, 103 AND 106).

CLASS 42—SCIENTIFIC AND COMPUTER SERVICES

FOR DEVELOPMENT AND TESTING OF RECYCLING PROCESSES FOR QUATERNARY AMMONIUM COMPOUNDS (U.S. CLS. 100 AND 101).
STEVEN JACKSON, EXAMINING ATTORNEY

SN 77-142,793. BRANDDIMENSIONS INC., MISSISSAUGA, CANADA, FILED 3-28-2007.

ADVANCING THE SCIENCE OF
DECISION-MAKING

THE MARK CONSISTS OF STANDARD CHARACTERS WITHOUT CLAIM TO ANY PARTICULAR FONT, STYLE, SIZE, OR COLOR.

PRIORITY CLAIMED UNDER SEC. 44(D) ON CANADA APPLICATION NO. 1,339,334, FILED 3-14-2007, REG. NO. TMA712,243, DATED 4-17-2008, EXPIRES 4-17-2023.

CLASS 35—ADVERTISING AND BUSINESS

FOR BRAND ASSET AND TRADEMARK PROTECTION AND MANAGEMENT, NAMELY, TRADEMARK MONITORING; REPUTATION MANAGEMENT PROGRAMS, NAMELY, ASSISTING COMPANIES IN PROTECTING THEIR BRANDS AGAINST NEGATIVE PUBLICITY; PROVIDING MARKET INTELLIGENCE, NAMELY, PROVIDING BUSINESS MARKETING INFORMATION RELATING TO SPECIFIC SECTORS AND INDUSTRIES; BUSINESS RISK MANAGEMENT; PROVIDING BUSINESS INFORMATION TO BRAND OWNERS IN THE FIELD OF MARKET INTELLIGENCE, NAMELY, INFORMATION ON COMPETITIVE CHALLENGES IN THE MARKETPLACE; PUBLIC RELATIONS SERVICES, PUBLIC OPINION POLLING; CONSULTING SERVICES IN THE FIELD OF CUSTOMER RELATIONSHIP MANAGEMENT AND IN THE FIELD OF EXECUTIVE BUSINESS DECISION-MAKING; BUSINESS MARKETING SERVICES, NAMELY, CONSULTING SERVICES NAMELY PROVIDING MARKETING STRATEGIES TO THIRD PARTIES (U.S. CLS. 100, 101 AND 102).

CLASS 45—PERSONAL AND LEGAL SERVICES

FOR LEGAL SERVICES, NAMELY, TRADEMARK MAINTENANCE SERVICES AND TRADEMARK WATCH SERVICES; TRADEMARK WATCH SERVICES, NAMELY, IDENTIFICATION OF TRADEMARK INFRINGEMENT AND COUNTERFEIT ACTIVITIES; FRAUD DETECTION SERVICES IN THE FIELD OF UNAUTHORIZED USE OF TRADEMARKS (U.S. CLS. 100 AND 101).

RICHARD A. STRASER, EXAMINING ATTORNEY

SN 77-146,811. SEO GUY SERVICES LTD., NANAIMO, CANADA, FILED 4-2-2007.



REAL ESTATE
WEBMASTERS

PRIORITY CLAIMED UNDER SEC. 44(D) ON CANADA APPLICATION NO. 1325601, FILED 11-24-2006, REG. NO. TMA711,780, DATED 4-14-2008, EXPIRES 4-14-2023.

NO CLAIM IS MADE TO THE EXCLUSIVE RIGHT TO USE "REAL ESTATE WEBMASTERS" APART FROM THE MARK AS SHOWN IN RELATION TO WEB HOSTING SERVICES, WEB APPLICATION PROGRAMMING SERVICES AND WEBSITE DESIGN. NO CLAIM IS MADE TO THE EXCLUSIVE RIGHT TO USE "REAL ESTATE" APART FROM THE MARK AS SHOWN FOR ALL OTHER SERVICES., APART FROM THE MARK AS SHOWN.

THE MARK CONSISTS OF MISCELLANEOUS DESIGN.

CLASS 9—ELECTRICAL AND SCIENTIFIC APPARATUS

FOR COMPUTER SOFTWARE FOR USE IN DATABASE MANAGEMENT (U.S. CLS. 21, 23, 26, 36 AND 38).
FIRST USE 4-4-2004; IN COMMERCE 4-9-2004.

CLASS 35—ADVERTISING AND BUSINESS

FOR BUSINESS MARKETING CONSULTING SERVICES; COPYWRITING SERVICES (U.S. CLS. 100, 101 AND 102).
FIRST USE 4-4-2004; IN COMMERCE 4-4-2004.

CLASS 42—SCIENTIFIC AND COMPUTER SERVICES

FOR WEB HOSTING SERVICES; WEB APPLICATION PROGRAMMING SERVICES; GRAPHIC DESIGN SERVICES; WEBSITE DESIGN (U.S. CLS. 100 AND 101).
FIRST USE 4-4-2004; IN COMMERCE 4-4-2004.
PAUL E. FAHRENKOPF, EXAMINING ATTORNEY

SN 77-152,567, LIVING NATURE LIMITED, KERIKERI, NEW ZEALAND, FILED 4-10-2007.

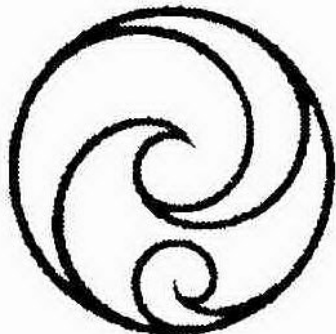

OWNER OF NEW ZEALAND REG. NO. 747070, DATED 4-28-2006, EXPIRES 4-28-2016.
THE MARK CONSISTS OF A ROUNDEL.

CLASS 3—COSMETICS AND CLEANING PREPARATIONS

FOR SOAPS FOR BODY CARE, PERFUMERY, ESSENTIAL OILS, COSMETICS, HAIR LOTIONS, DENTIFRICES, NON-MEDICATED TOILETRIES, NON-MEDICATED SKIN CARE PREPARATIONS (U.S. CLS. 1, 4, 6, 50, 51 AND 52).

CLASS 35—ADVERTISING AND BUSINESS

FOR WHOLESALE AND RETAIL STORES FEATURING SOAPS, PERFUMERY, ESSENTIAL OILS, COSMETICS, HAIR LOTIONS, DENTIFRICES, TOILETRIES, SKIN CARE PREPARATIONS (U.S. CLS. 100, 101 AND 102).
HANNO RITTNER, EXAMINING ATTORNEY

SN 77-166,812, OPTOTRACE TECHNOLOGIES, INC., SUNYVALE, CA. FILED 4-26-2007.

OptoTrace

THE MARK CONSISTS OF STANDARD CHARACTERS WITHOUT CLAIM TO ANY PARTICULAR FONT, STYLE, SIZE, OR COLOR.

CLASS 9—ELECTRICAL AND SCIENTIFIC APPARATUS

FOR SEMICONDUCTOR OR NANO-STRUCTURE BASED NON-MEDICAL ELECTRONIC SENSORS FOR SENSING CHEMICALS AND BIOLOGICAL AGENTS, AND FOR IDENTIFYING CHEMICAL COMPOUNDS IN AIR, LIQUID, POWDER, POLYMER, OR SOLID (U.S. CLS. 21, 23, 26, 36 AND 38).
FIRST USE 11-12-2003; IN COMMERCE 4-1-2006.

CLASS 10—MEDICAL APPARATUS

FOR SEMICONDUCTOR OR NANO-STRUCTURE BASED MEDICAL ELECTRONIC SENSORS FOR SENSING CHEMICALS AND BIOLOGICAL AGENTS FOR CLINICAL DIAGNOSIS OF CANCERS, HIV, DIABETES, ALZHEIMER'S DISEASE, AND PARKINSON'S DISEASE (U.S. CLS. 26, 39 AND 44).
FIRST USE 11-12-2003; IN COMMERCE 4-1-2006.
SIMON TENG, EXAMINING ATTORNEY

SN 77-166,888, COMBIPHOS CATALYSTS, INC., PRINCETON, NJ. FILED 4-26-2007.

COMBIPHOS CATALYSTS, INC.

THE MARK CONSISTS OF STANDARD CHARACTERS WITHOUT CLAIM TO ANY PARTICULAR FONT, STYLE, SIZE, OR COLOR.
NO CLAIM IS MADE TO THE EXCLUSIVE RIGHT TO USE "CATALYSTS, INC.", APART FROM THE MARK AS SHOWN.

CLASS 1—CHEMICALS

FOR CATALYSTS FOR CHEMICAL AND BIOCHEMICAL PROCESSES (U.S. CLS. 1, 5, 6, 10, 26 AND 46).
FIRST USE 6-14-2001; IN COMMERCE 6-14-2001.

CLASS 42—SCIENTIFIC AND COMPUTER SERVICES

FOR SCIENTIFIC RESEARCH AND DEVELOPMENT (U.S. CLS. 100 AND 101).
FIRST USE 6-14-2001; IN COMMERCE 6-14-2001.
ROBIN CHOSID, EXAMINING ATTORNEY

SN 77-167,590, ADNEXUS, A BRISTOL-MYERS SQUIBB R&D COMPANY, WALTHAM, MA. FILED 4-27-2007.

RESHAPING PROTEINS

THE MARK CONSISTS OF STANDARD CHARACTERS WITHOUT CLAIM TO ANY PARTICULAR FONT, STYLE, SIZE, OR COLOR.
NO CLAIM IS MADE TO THE EXCLUSIVE RIGHT TO USE "PROTEINS", APART FROM THE MARK AS SHOWN.

CLASS 5—PHARMACEUTICALS

FOR BIOTECHNOLOGY AND PHARMACEUTICAL PRODUCTS, NAMELY, THERAPEUTIC PROTEINS FOR HUMAN USE FOR THE TREATMENT AND PREVENTION OF OBESITY, DIABETES, INCONTINENCE, CARDIOVASCULAR DISEASES, CENTRAL NERVOUS SYSTEM DISEASES AND DISORDERS, METABOLIC DISORDERS, STROKE, CANCER, INFLAMMATION AND INFLAMMATORY DISEASES, RESPIRATORY AND INFECTIOUS DISEASES, AUTO-IMMUNE DISEASES, SOLID ORGAN TRANSPLANT REJECTION; PHARMACEUTICAL PREPARATIONS FOR HUMAN USE, NAMELY, ANTIBIOTICS, ANTI-FUNGALS, ANTI-VIRALS, IMMUNOSUPPRESSANTS AND PHARMACEUTICAL ANTIBODIES (U.S. CLS. 6, 18, 44, 46, 51 AND 52).

CLASS 42—SCIENTIFIC AND COMPUTER SERVICES

FOR BIOTECHNOLOGY RESEARCH AND CONSULTATION SERVICES (U.S. CLS. 100 AND 101).
ZACHARY BELLO, EXAMINING ATTORNEY

SN 77-170,025. BILLET SPECIALTIES, INC., BURR RIDGE, IL. FILED 5-1-2007.

BILLET SPECIALTIES

THE MARK CONSISTS OF STANDARD CHARACTERS WITHOUT CLAIM TO ANY PARTICULAR FONT, STYLE, SIZE, OR COLOR.

OWNER OF U.S. REG. NO. 2,420,655.

NO CLAIM IS MADE TO THE EXCLUSIVE RIGHT TO USE "SPECIALTIES", APART FROM THE MARK AS SHOWN.

CLASS 7—MACHINERY

FOR VEHICLE ENGINE PARTS, NAMELY, AIR CLEANERS, VALVE COVERS, VALVE COVER HOLD DOWNS, WIRE LOOM BRACKET KIT CONSISTING PRIMARILY OF BRACKETS TO MOUNT ENGINE WIRE LOOM TO HEADS, CRANKCASE BREATHERS, OIL TANK FILL CAPS AND OIL TANK FILL CAP COVERS, RADIATOR CAPS, FUEL FILTERS, ALTERNATOR BRACKETS, COMPRESSOR BRACKETS, PULLEYS, WATER PUMP PULLEYS, CRANKSHAFT PULLEYS, POWER STEERING PULLEYS, ALTERNATOR PULLEYS, UNDERDRIVE PULLEYS, IDLER PULLEYS, TENSIONER PULLEYS, VACUUM ADVANCE COVERS FOR VACUUM DIAPHRAGMS, MASTER CYLINDER COVERS FOR LAND VEHICLES, NOSE CONES TO COVER THE MOUNTING BOLTS OF A WATER PUMP PULLEY; EMISSION REDUCTION UNITS FOR MOTORS AND ENGINES, NAMELY, PCV BREATHERS AND VALVES; VEHICLE AIR CONDITIONING COMPRESSOR COMPONENT PARTS, NAMELY, AIR CONDITIONING COMPRESSOR COVERS; FUEL PUMP COMPONENT PARTS FOR LAND VEHICLES, NAMELY, FUEL BLOCK-OFFS FOR COVERING FUEL PUMP OPENING (U.S. CLS. 13, 19, 21, 23, 31, 34 AND 35).

FIRST USE 0-0-1985; IN COMMERCE 0-0-1985.

CLASS 9—ELECTRICAL AND SCIENTIFIC APPARATUS

FOR THERMOSTAT HOUSINGS; ELECTRIC RELAY COMPONENT PARTS, NAMELY, RELAY BOX COVERS; CRUISE CONTROL COMPONENT PARTS FOR MOTOR VEHICLES, NAMELY, CRUISE BOX COVERS (U.S. CLS. 21, 23, 26, 36 AND 38).

FIRST USE 0-0-1989; IN COMMERCE 0-0-1989.

CLASS 11—ENVIRONMENTAL CONTROL APPARATUS

FOR VEHICLE PARTS, NAMELY, AIR CONDITIONING MOUNTING BRACKETS; VEHICLE AIR CONDITIONING COMPONENT PARTS, NAMELY, AIR CONDITIONING VENTS (U.S. CLS. 13, 21, 23, 31 AND 34).

FIRST USE 0-0-1985; IN COMMERCE 0-0-1985.

CLASS 12—VEHICLES

FOR LAND VEHICLE PARTS, NAMELY, CUSTOM WHEELS, KNOCK-OFF WHEELS, AND WHEEL CAPS; VEHICLE PARTS, NAMELY, STEERING WHEELS; HORN FOR VEHICLE COMPONENT PARTS, NAMELY, HORN BUTTONS; VEHICLE STEERING WHEEL COMPONENT PARTS, NAMELY, STEERING WHEEL ADAPTERS, STEERING WHEEL RINGS, STEERING COLUMNS, STEERING COLUMN MOUNTS, STEERING COLUMN DROPS, SHIFT ARMS FOR STEERING COLUMNS, TILT LEVERS, TURN SIGNAL LEVERS, FLASHER KNOBS, SHIFTER KNOBS; AUTOMOTIVE INTERIOR DRESS-UP KITS COMPRISED PRIMARILY OF TILT SHIFT LEVERS, TURN SIGNAL LEVER, EMERGENCY FLASHER KNOB, SHIFTER KNOB, COVER FOR TURN SIGNAL AND CRUISE CONTROL ARM; AUTOMOTIVE FLOOR PEDALS AND PEDAL KITS COMPRISED PRIMARILY OF GAS PEDAL, BRAKE PEDAL AND EMERGENCY BRAKE PEDAL; AUTOMOTIVE VEHICLE FRONT DASH PANELS AND THEIR COMPONENT PARTS, NAMELY, DASH KNOBS, DASH INSERTS; WINDSHIELD WIPER BLADE COMPONENT PARTS FOR VEHICLES, NAMELY, WINDSHIELD WIPER BOX COVERS AND WINDSHIELD WIPER POST COVERS; CAR GRILL EMBLEM BADGES; STRUCTURAL PARTS FOR AUTOMOBILES, NAMELY, DOOR SILL PLATES; AUTOMOBILE BUMPER COMPONENT PARTS, NAMELY, STEP PLATES, LICENSE PLATE FRAMES CONSISTING OF VEHICLE LIGHTS; AUTOMOBILE DOOR HANDLES; VEHICLE WINDOW COMPONENT PARTS, NAMELY, WINDOW CRANKS; VEHICLE VENT COMPONENT PARTS, NAMELY, VENT CRANKS; VEHICLE MIRROR COMPONENT PARTS, NAMELY, REARVIEW MIRROR MOUNTS, MIRROR REARVIEW HEADS, MIRROR ARMS AND VEHICLE PARTS, NAMELY, REARVIEW MIRRORS; VEHICLE STEERING WHEEL COMPONENT PARTS, NAMELY, POWER STEERING RESERVOIR CAP COVERS; TRAILER HITCH RECEIVER COVERS; VEHICLE DIPSTICKS (U.S. CLS. 19, 21, 23, 31, 35 AND 44).

FIRST USE 0-0-1985; IN COMMERCE 0-0-1985.

SIMON TENG, EXAMINING ATTORNEY

SN 77-171,053. SOURCE MEDIA INC., NEW YORK, NY. FILED 5-2-2007.

The 25 MPWIB

THE MARK CONSISTS OF STANDARD CHARACTERS WITHOUT CLAIM TO ANY PARTICULAR FONT, STYLE, SIZE, OR COLOR.

SEC. 2(F).

THE 2(F) CLAIM IS RESTRICTED TO CLASS(ES) 16

CLASS 16—PAPER GOODS AND PRINTED MATTER

FOR PRINTED PUBLICATIONS, NAMELY, ANNUALLY PUBLISHED MAGAZINES, A SERIES OF MAGAZINE ARTICLES, LISTS AND REPORTS FEATURING WOMEN WHO HAVE DEMONSTRATED BUSINESS EXCELLENCE IN THE BANKING INDUSTRY (U.S. CLS. 2, 5, 22, 23, 29, 37, 38 AND 50).

FIRST USE 10-29-2003; IN COMMERCE 10-29-2003.

CLASS 41—EDUCATION AND ENTERTAINMENT

FOR EDUCATIONAL SERVICES, NAMELY, CONDUCTING ON-LINE EXHIBITIONS AND DISPLAYS AND INTERACTIVE EXHIBITS ABOUT WOMEN WHO HAVE DEMONSTRATED BUSINESS EXCELLENCE IN THE BANKING INDUSTRY; CONDUCTING RECOGNITION AND INCENTIVE AWARD PROGRAMS TO ACKNOWLEDGE WOMEN WHO HAVE DEMONSTRATED BUSINESS EXCELLENCE IN THE BANKING INDUSTRY; PROVIDING NON-DOWNLOADABLE ON-LINE PUBLICATIONS IN THE NATURE OF ANNUALLY PUBLISHED MAGAZINES, MAGAZINE ARTICLES, LISTS AND REPORTS FEATURING INFORMATION ABOUT WOMEN WHO HAVE DEMONSTRATED BUSINESS EXCELLENCE IN THE BANKING INDUSTRY (U.S. CLS. 100, 101 AND 107).

FIRST USE 10-29-2003; IN COMMERCE 10-29-2003.
HEATHER BIDDULPH, EXAMINING ATTORNEY

SN 77-172,019. FABASOFT AG, LINZ, AUSTRIA, FILED 5-3-2007.

EGOVDAY

THE MARK CONSISTS OF STANDARD CHARACTERS WITHOUT CLAIM TO ANY PARTICULAR FONT, STYLE, SIZE, OR COLOR.

PRIORITY CLAIMED UNDER SEC. 44(D) ON AUSTRIA APPLICATION NO. AM241/2007, FILED 1-12-2007, REG. NO. 237826, DATED 4-3-2007, EXPIRES 1-12-2017.

OWNER OF U.S. REG. NOS. 2,596,167, 3,086,962 AND OTHERS.

CLASS 9—ELECTRICAL AND SCIENTIFIC APPARATUS

FOR COMPUTER SOFTWARE, NAMELY, COMPUTER SERVER AND CLIENT SOFTWARE FOR BUSINESS PROCESS MANAGEMENT, WORKFLOW MANAGEMENT, PROCESS CONTROL, RECORDS MANAGEMENT, DOCUMENT MANAGEMENT, WEB CONTENT MANAGEMENT, ENTERPRISE CONTENT MANAGEMENT, KNOWLEDGE MANAGEMENT, INFORMATION MANAGEMENT, CUSTOMER RELATIONSHIP MANAGEMENT, INFORMATION RETRIEVAL, INFORMATION ACCESS, COMPLIANCE MANAGEMENT, FACILITY MANAGEMENT, AUTOMATION, BUSINESS INTELLIGENCE, ENTERPRISE RESOURCE PLANNING, ACCOUNTING, ARCHIVING; COMPUTER SOFTWARE FOR ELECTRONIC FORMS MANAGEMENT; COMPUTER SOFTWARE FOR ELECTRONIC DELIVERY; COMPUTER SOFTWARE FOR REPORT GENERATION; COMPUTER SOFTWARE FOR DATA ENCRYPTION AND DATA COMPRESSION; COMPUTER SOFTWARE FOR ADMINISTERING, MANAGING, MONITORING AND DIAGNOSING HARDWARE AND SOFTWARE INFRASTRUCTURES AND COMPONENTS IN A COMPUTER NETWORK; COMPUTER SOFTWARE FOR QUALITY ASSURANCE, QUALITY MANAGEMENT AND AUTOMATED TESTING; COMPUTER SOFTWARE FOR COMPUTER BASED TRAINING, WEB BASED TRAINING AND EDUCATION; COMPUTER E-COMMERCE SOFTWARE TO ALLOW USERS TO PERFORM ELECTRONIC BUSINESS TRANSACTIONS VIA GLOBAL COMPUTER NETWORK; SOFTWARE DEVELOPMENT TOOLS; SOFTWARE FOR DEVELOPING WEB SITES; COMPUTER SOFTWARE FOR SOFTWARE DISTRIBUTION AND SOFTWARE UPDATING SERVICES; COMPUTER SOFTWARE FOR APPLICATION AND DATA INTEGRATION; COMPILER SOFTWARE; COMPUTER SEARCH ENGINE SOFTWARE FOR SEARCHING, INDEXING, COMPILING AND ORGANIZING INFORMATION; COMPUTER SECURITY AND AUTHENTICATION SOFTWARE TO CONTROL ACCESS TO INFORMATION AND RESOURCES; COMPUTER

COMMUNICATION SOFTWARE FOR MANAGING THE EXCHANGE OF COMMUNICATION AND DATA; COMPUTER SOFTWARE FOR MOBILE PHONES AND PERSONAL DIGITAL ASSISTANTS (U.S. CLS. 21, 23, 26, 36 AND 38).

CLASS 41—EDUCATION AND ENTERTAINMENT

FOR EDUCATION SERVICES, NAMELY, HOLDING OF AND CARRYING OUT OF CLASSES, SEMINARS, CONFERENCES AND WORKSHOPS IN THE FIELD OF COMPUTER HARDWARE AND COMPUTER SOFTWARE TRAINING, WORD AND DATA PROCESSING (U.S. CLS. 100, 101 AND 107).

CLASS 42—SCIENTIFIC AND COMPUTER SERVICES

FOR PROFESSIONAL CONSULTATION IN THE FIELD OF COMPUTER HARDWARE AND COMPUTER SOFTWARE; COMPUTER AND TECHNICAL CONSULTING AND SUPPORT SERVICES, NAMELY, TROUBLESHOOTING OF COMPUTER HARDWARE, SOFTWARE AND NETWORK CONNECTION PROBLEMS; COMPUTER PROGRAMMING SERVICES; CONSULTING AND TECHNICAL SUPPORT SERVICES IN THE FIELD OF THE DESIGN AND USE OF COMPUTER PROGRAMS, COMPUTERS, COMPUTER HARDWARE AND COMPUTER SYSTEMS; PROFESSIONAL CONSULTATION IN THE FIELD OF INFORMATION TECHNOLOGY, COMPUTER HARDWARE, COMPUTER SOFTWARE AND COMPUTER PROGRAMMING FOR OTHERS (U.S. CLS. 100 AND 101).

MARIAM MAHMOUDI, EXAMINING ATTORNEY

SN 77-187,926. NINA MEEKS, CHICAGO, IL. FILED 5-23-2007.

Gigatt

THE MARK CONSISTS OF STANDARD CHARACTERS WITHOUT CLAIM TO ANY PARTICULAR FONT, STYLE, SIZE, OR COLOR.

CLASS 16—PAPER GOODS AND PRINTED MATTER

FOR GREETING CARDS, NAMELY, CARDS BEARING UNIVERSAL GREETINGS, BUSINESS CARDS, GREETING CARDS HAVING CHRISTIAN MESSAGES, GREETING CARD AND POST CARD HOLDERS SPECIALLY ADAPTED FOR HOLDING GREETING CARDS AND POSTCARDS, MUSICAL GREETING CARDS, PAPER BOXES FOR STORING GREETING CARDS, PRINTED GREETING CARDS WITH ELECTRONIC INFORMATION STORED THEREIN BEARING UNIVERSAL GREETINGS, DOCUMENT FOLDERS IN THE FORM OF WALLETS, FILING FOLDERS, PAPER LABELS AND PRINTED INSTRUCTIONAL MATERIALS FOR ORGANIZING PERSONAL FILES, FOLDERS FOR LETTERS, MECHANICAL BINDER SETS, COMPRISING RINGS, DIVIDERS, AND FOLDERS, PRESENTATION FOLDERS, SCHOOL SUPPLY KITS CONTAINING VARIOUS COMBINATIONS OF SELECTED SCHOOL SUPPLIES, NAMELY, WRITING INSTRUMENTS, PENS, PENCILS, MECHANICAL PENCILS, ERASERS, MARKERS, CRAYONS, HIGHLIGHTERS, FOLDERS, NOTEBOOKS, PAPER, PROTRACTORS, PAPER CLIPS, PENCIL SHARPENERS, WRITING GRIPS, GLUE AND BOOK MARKS, STATIONERY FOLDERS (U.S. CLS. 2, 5, 22, 23, 29, 37, 38 AND 50).

CLASS 25—CLOTHING

FOR CLOTHING, NAMELY, HATS, HAT BANDS, FUR HATS, SCARVES, HEAD SCARVES, SHOULDER SCARVES, JEANS, SHIRTS, BLOUSES, T-SHIRTS, SHORT SLEEVE, LONG SLEEVE, AND KNIT SHIRTS, DRESS SHIRTS, HOODED SWEAT SHIRTS, SHIRTS, BUTTON FRONT ALOHA SHIRTS, OPEN NECK SHIRTS, POLO SHIRTS, TEE SHIRTS, SPORT SHIRTS, SLEEP SHIRTS, PAJAMA BOTTOMS, TANK TOPS, JOGGING PANTS, CAPS, CASUAL SHOES, LEATHER SHOES, INFANT SHOES AND BOOTS, WOMEN'S SHOES, ATHLETIC SHOES, BOWLING SHOES, BASEBALL SHOES, TENNIS SHOES, TRACK AND FIELD SHOES, TRAINING SHOES, SKIING SHOES, DENIM PANTS, JOGGING PANTS, RAIN COATS, BASEBALL CAPS, BATHING CAPS, PANTS, LEATHER PANTS, CAPRI PANTS, PETTI-PANTS, BELTS, FABRIC BELTS, TRENCH COATS, DUST COATS, LEATHER COATS, RAIN COATS, SUIT COATS, SPORT COATS, OVERCOATS, GARTER BELTS, CAP VISORS, BODY SUITS, BATHING SUITS, GYM SUITS, MEN'S SUITS, WOMEN'S SUITS, SUSPENDER BELTS FOR WOMEN, GOLF CAPS, KNITTED HATS, SKIRTS, SUIT SKIRTS, SKIRTS AND DRESSES, SKULL CAPS, SWIM CAPS, WALKING SHORTS, SWEAT SHORTS, SLIDING SHORTS, SHORT TROUSERS, PANTIES, SHORTS AND BRIEFS, GYM SHORTS, BOXES SHORTS, BERMUDA SHORTS, SLIPS, SUSPENDER BELTS FOR MEN, TUXEDO BELTS, LEATHER BELTS, MONEY BELTS, TODDLER AND INFANT ONE PIECE CLOTHING, PANTIES, BRAS, SPORTS BRAS, MEN'S SOCKS, WOMEN'S SOCKS, ANKLETS, THERMAL SOCKS, STOCKINGS, BODY STOCKINGS, KNEE HIGH STOCKINGS, BOXER BRIEFS, BOXER SHORTS, CAMISOLES, GLOVES, BOOTS, FOOTWEAR, NAMELY, WORK BOOTS, INFANT SHOES AND BOOTS, LADIES' BOOTS, ANKLE BOOTS, DENIM JACKETS, DOWN JACKETS, HEAVY JACKETS, LEATHER JACKETS FOR MEN AND WOMEN, COATS, RAINPROOF JACKETS, REVERSIBLE JACKETS, SUEDE JACKETS, SPORTS JACKETS, SLEEVED OR SLEEVELESS JACKETS (U.S. CLS. 22 AND 39).
 NANCY CLARKE, EXAMINING ATTORNEY

CLASS 35—ADVERTISING AND BUSINESS

FOR ADVERTISING SERVICES, NAMELY, PROVIDING ADVERTISING SPACE IN NEWSLETTERS (U.S. CLS. 100, 101 AND 102).
 FIRST USE 4-29-2006; IN COMMERCE 4-29-2006.

CLASS 39—TRANSPORTATION AND STORAGE

FOR PACKAGING OF GOODS, NAMELY, PACKAGING NEWSLETTER KITS AND NEWSLETTERS FOR DISTRIBUTION AND TRANSPORTATION (U.S. CLS. 100 AND 105).

CLASS 41—EDUCATION AND ENTERTAINMENT

FOR NEWSLETTER PUBLICATION SERVICES (U.S. CLS. 100, 101 AND 107).
 FIRST USE 5-1-2007; IN COMMERCE 5-1-2007.

CLASS 42—SCIENTIFIC AND COMPUTER SERVICES

FOR APPLICATION SERVICE PROVIDER FEATURING SOFTWARE FOR USE IN PUBLISHING OF NEWSLETTERS, MAGAZINES, FLYERS AND OTHER PRINTED MATERIALS WHOSE CONTENT VARIES (U.S. CLS. 100 AND 101).
 FIRST USE 6-1-2000; IN COMMERCE 6-1-2000.

CLASS 45—PERSONAL AND LEGAL SERVICES

FOR SECURITY SERVICES, NAMELY, BACKGROUND INVESTIGATION AND BACKGROUND RESEARCH SERVICES (U.S. CLS. 100 AND 101).
 NORA BUCHANAN WILL, EXAMINING ATTORNEY

SN 77-190,891. UHLIG, LLC, OVERLAND PARK, KS. FILED 5-25-2007.



THE MARK CONSISTS OF A DESIGN USING SHORT HORIZONTAL LINES OF VARIABLE THICKNESS TO OUTLINE A VERTICAL RECTANGLE FOLLOWED BY THE WORD "UHLIG".

CLASS 9—ELECTRICAL AND SCIENTIFIC APPARATUS

FOR COMPUTER SOFTWARE FOR USE IN PUBLISHING OF MAGAZINES, NEWSLETTERS, FLYERS AND OTHER PRINTED MATERIALS WHOSE CONTENT VARIES (U.S. CLS. 21, 23, 26, 36 AND 38).

CLASS 16—PAPER GOODS AND PRINTED MATTER

FOR NEWSLETTERS FEATURING TOPICS OF GENERAL INTEREST, BUSINESS, LEGAL ADVICE, FICTIONAL STORIES, NEWS, CROSSWORD PUZZLES, WORD AND NUMBER GAMES, INFORMATION ABOUT COMMUNITY EVENTS, HOME OWNERSHIP, REAL ESTATE, HOME MAINTENANCE, RETIREMENT, GARDENING, ENTERTAINMENT, HEALTH, COOKING AND FITNESS; PAYMENT COUPON BOOKS FOR RESIDENTIAL COMMUNITY ASSESSMENTS AND FEES (U.S. CLS. 2, 5, 22, 23, 29, 37, 38 AND 50).
 FIRST USE 3-1-2007; IN COMMERCE 3-1-2007.

SN 77-214,972. WATER FOR OUR WORLD, PHOENIX, AZ. FILED 6-25-2007.



NO CLAIM IS MADE TO THE EXCLUSIVE RIGHT TO USE "WATER", APART FROM THE MARK AS SHOWN.
 THE APPLICANT CLAIMS COLOR AS A FEATURE OF THE MARK, NAMELY, DARK BLUE, GREEN, WHITE, AND AQUA BLUE.
 THE MARK CONSISTS OF AN IMAGE OF THE EARTH WITH DARK BLUE REPRESENTING THE WATER AND GREEN REPRESENTING THE LAND OF THE CONTINENTS. A DARK BLUE ARCH ABOVE THE EARTH, AND AN AQUA BLUE ARC ON EACH SIDE OF THE EARTH. THE WORDS, "WATER FOR OUR WORLD" ARE IN WHITE AND BORDERED BY A BLOCK OF AQUA BLUE.

CLASS 25—CLOTHING

FOR (BASED ON INTENT TO USE) BERMUDA SHORTS; BOARD SHORTS; BOXER SHORTS; BUTTON-FRONT ALOHA SHIRTS; CAMP SHIRTS; CAPRI PANTS; CARGO PANTS; DENIM JACKETS; DENIMS; DOWN JACKETS; DRESS SHIRTS; FISHERMEN'S JACKETS; FLEECE SHORTS; GOLF SHIRTS; GYM SHORTS; JACKETS; JOGGING PANTS; KNIT SHIRTS; LIGHT-REFLECTING JACKETS; LONG JACKETS; LOUNGE PANTS; NIGHT SHIRTS; OPEN-NECKED SHIRTS; PANTS; POLO SHIRTS; RAIN JACKETS; RUGBY SHORTS; SHORTS; SKI JACKETS; SKI PANTS; SLEEP SHIRTS; SNOW PANTS; SNOWBOARD PANTS; SWEAT PANTS; SWEAT SHORTS; TRACK PANTS; WALKING SHORTS; WATERPROOF JACKETS AND PANTS; WIND PANTS; WIND RESISTANT JACKETS; WIND SHIRTS; YOGA PANTS; YOGA SHIRTS; (BASED ON USE IN COMMERCE) SHIRTS; SHORT-SLEEVED OR LONG-SLEEVED T-SHIRTS; SHORT-SLEEVED SHIRTS; SPORT SHIRTS; SWEAT SHIRTS; T-SHIRTS (U.S. CLS. 22 AND 39).

FIRST USE 6-1-2007; IN COMMERCE 6-1-2007.

CLASS 32—LIGHT BEVERAGES

FOR BOTTLED DRINKING WATER; BOTTLED WATER; DRINKING WATER (U.S. CLS. 45, 46 AND 48).

FIRST USE 6-1-2007; IN COMMERCE 6-1-2007.

JUDITH HELFMAN, EXAMINING ATTORNEY

SN 77-219,566, YAMAHA MOTOR CORPORATION, U.S.A., CYPRESS, CA. FILED 6-29-2007.

PERFORMANCE IN A BOTTLE

THE MARK CONSISTS OF STANDARD CHARACTERS WITHOUT CLAIM TO ANY PARTICULAR FONT, STYLE, SIZE, OR COLOR.

CLASS 1—CHEMICALS

FOR ADHESIVES FOR THE MOTOR VEHICLE INDUSTRY AND FOR GENERAL INDUSTRIAL USE; THREAD LOCK, NAMELY, ADHESIVE FOR USE IN SEALING, FILLING, AND RETAINING MECHANICAL PARTS; SOLVENTS FOR INDUSTRIAL AND COMMERCIAL USE; DEGREASING AGENTS; LIQUID MATERIAL IN THE NATURE OF A PASTE USED TO PREVENT AND REMOVE STRIPPED SCREWS, BOLTS, AND FASTENERS; BRAKE FLUID; ANTIFREEZE; MOTOR VEHICLE GASKET CEMENT; CHEMICAL ADDITIVES FOR FUEL TREATMENT; CHEMICAL ENGINE TREATMENTS AND ADDITIVES FOR ENGINE OILS, GASOLINE, TRANSMISSION FLUIDS AND COOLING SYSTEMS; HYDRAULIC FLUID; POWER STEERING FLUID; TRANSMISSION FLUID; CHEMICAL PRODUCT FOR NEUTRALIZING BATTERY ACID, CORROSION, AND RUST; FABRIC PROTECTANT FOR MOTOR VEHICLE INTERIORS; ADHESIVE IN THE NATURE OF A GEL FOR USE IN MOTOR VEHICLE DETAILING; TRIM AND TILT FLUIDS, NAMELY, HYDRAULIC FLUIDS FOR MARINE ENGINES (U.S. CLS. 1, 5, 6, 10, 26 AND 46).

CLASS 2—PAINTS

FOR PRESERVATIVES IN THE NATURE OF SILICON COATING FOR THE PREVENTION OF RUST; CLEAR COATING PROTECTANT FOR MOTOR VEHICLES; CORROSION INHIBITANTS IN THE NATURE OF A COATING (U.S. CLS. 6, 11 AND 16).

CLASS 3—COSMETICS AND CLEANING PREPARATIONS

FOR ADHESIVE, GLUE, PAINT, AND VARNISH REMOVERS; LEATHER POLISHES AND CONDITIONERS; LEATHER PRESERVING OIL AND GREASE; SADDLE SOAP; CLEANERS FOR METAL, RUBBER AND SYNTHETIC SURFACES; BIODEGRADABLE HAND CLEANERS; ENVIRONMENTALLY FRIENDLY CLEANERS FOR MOTORCYCLES; DEGREASING PREPARATIONS FOR MOTORS, ENGINES AND BRAKES; POLISH FOR MOTORIZED VEHICLES; CHROME POLISHES; MINK OILS; CLEANING PREPARATIONS FOR MOTORS, ENGINES, CARBURETORS, CHOKES AND BRAKES; RUST REMOVING PREPARATIONS (U.S. CLS. 1, 4, 6, 50, 51 AND 52).

CLASS 4—LUBRICANTS AND FUELS

FOR LUBRICANTS FOR MOTORIZED VEHICLES, INDUSTRIAL LUBRICANTS, ALL-PURPOSE LUBRICANTS, AND LUBRICANTS FOR MARINE VEHICLES; MOTOR OILS, FUEL OILS, AIR FILTER OILS, LUBRICATING OILS FOR MARINE VEHICLES, AND OILS FOR WINTERIZATION OF MOTOR AND ENGINE COMPONENTS; GREASES FOR MOTORIZED VEHICLES; GREASES FOR MARINE VEHICLES; LEATHER PRESERVING OIL AND GREASE; NON-CHEMICAL ENGINE TREATMENTS AND ADDITIVES FOR ENGINE OILS, GASOLINE, TRANSMISSION FLUIDS AND COOLING SYSTEMS (U.S. CLS. 1, 6 AND 15).

CLASS 5—PHARMACEUTICALS

FOR AIR FRESHENERS; ODOR NEUTRALIZING PREPARATIONS FOR USE ON UPHOLSTERY, LEATHER AND MOTOR VEHICLES (U.S. CLS. 6, 18, 44, 46, 51 AND 52).

GIANCARLO CASTRO, EXAMINING ATTORNEY

SN 77-229,035, ZYWAVE, INC., WAUWATOSA, WI. FILED 7-13-2007.

MyWave Elements

THE MARK CONSISTS OF STANDARD CHARACTERS WITHOUT CLAIM TO ANY PARTICULAR FONT, STYLE, SIZE, OR COLOR.

OWNER OF U.S. REG. NOS. 2,571,896, 3,208,309 AND OTHERS.

NO CLAIM IS MADE TO THE EXCLUSIVE RIGHT TO USE "ELEMENTS" IN INTERNATIONAL CLASS 42, APART FROM THE MARK AS SHOWN.

CLASS 36—INSURANCE AND FINANCIAL

FOR PROVIDING INSURANCE INFORMATION OVER A GLOBAL COMPUTER NETWORK (U.S. CLS. 100, 101 AND 102).

FIRST USE 6-18-2007; IN COMMERCE 11-5-2007.

CLASS 42—SCIENTIFIC AND COMPUTER SERVICES

FOR WEB HOSTING SERVICES AND DESIGNING AND CREATING WEB PAGES FOR OTHERS (U.S. CLS. 100 AND 101).

FIRST USE 6-18-2007; IN COMMERCE 11-5-2007.

KAPIL BHANOT, EXAMINING ATTORNEY

SN 77-229,997. ARTAVANT, LLC, VIRGINIA BEACH, VA.
FILED 7-15-2007.

SN 77-229,998. ARTAVANT, LLC, VIRGINIA BEACH, VA.
FILED 7-15-2007.

ARTAVANT

The Ambient Network

THE MARK CONSISTS OF STANDARD CHARACTERS WITHOUT CLAIM TO ANY PARTICULAR FONT, STYLE, SIZE, OR COLOR.

CLASS 9—ELECTRICAL AND SCIENTIFIC APPARATUS

FOR PRERECORDED DVDS FEATURING ARTISTIC AND DRAMATIC PRESENTATIONS OF MUSIC OR SOUND ACCOMPANIED BY VISUAL ART, IMAGERY, GRAPHICS OR PHOTOGRAPHIC IMAGES; PRERECORDED COMPACT DISCS FEATURING MUSIC OR SOUNDS; COMPUTER SOFTWARE FEATURING PHOTOGRAPHIC IMAGES; MULTIMEDIA FILES CONTAINING TEXT, GRAPHICS, ELECTRONIC PHOTOGRAPHS AND GRAPHIC IMAGES, ALL RELATING TO MUSIC AND SOUND; RINGTONES, RING BACKS, ANIMATED RINGERS AND VIDEO RINGERS, ALL DOWNLOADABLE VIA THE INTERNET OR OTHER COMMUNICATIONS NETWORK, HELD IN ELECTRONIC PERSONAL COMPUTERS AND OTHER WIRELESS MOBILE COMMUNICATION DEVICES (U.S. CLS. 21, 23, 26, 36 AND 38).

CLASS 38—COMMUNICATION

FOR BROADCASTING SERVICES, NAMELY, BROADCASTING AUDIO AND VIDEO MATERIAL VIA CABLE, SATELLITE, INTERNET PROTOCOL TELEVISION (IPTV) TRANSMISSION AND FIBER OPTIC NETWORKS; SUBSCRIPTION TELEVISION BROADCASTING; VIDEO BROADCASTING SERVICES; INTERACTIVE TELEVISION BROADCASTING; VIDEO ON DEMAND TRANSMISSION SERVICE; STREAMING OF AUDIO AND VIDEO MATERIAL VIA THE INTERNET OR OTHER COMMUNICATIONS NETWORK; WIRELESS TRANSMISSION SERVICES, NAMELY, STREAMING OF AUDIO AND VIDEO MATERIAL TO MOBILE PHONES, AND OTHER WIRELESS MOBILE COMMUNICATION DEVICES (U.S. CLS. 100, 101 AND 104).

CLASS 41—EDUCATION AND ENTERTAINMENT

FOR ENTERTAINMENT SERVICES, NAMELY, TELEVISION PROGRAMMING AND PRODUCTION SERVICES; DISTRIBUTION OF TELEVISION PROGRAMS AND SCHEDULING OF TELEVISION PROGRAMMING FOR OTHERS; ONLINE SERVICES, NAMELY, PROVIDING A WEBSITE FEATURING INFORMATION REGARDING TELEVISION PROGRAMS AND THE DISTRIBUTION THEREOF; PROVIDING INTERACTIVE AUDIO AND VIDEO MATERIALS VIA THE INTERNET, NAMELY, NON-DOWNLOADABLE SOUND AND GRAPHICS FEATURING ARTISTIC AND DRAMATIC PRESENTATIONS OF MUSIC OR SOUND ACCOMPANIED BY VISUAL ART, IMAGERY, GRAPHICS OR PHOTOGRAPHIC IMAGES, AND MUSIC VIDEO RECORDINGS; ENTERTAINMENT IN THE NATURE OF ONGOING TELEVISION PROGRAMS IN THE FIELD OF MUSIC VIDEOS AND ARTISTIC AND DRAMATIC PRESENTATIONS OF MUSIC OR SOUND ACCOMPANIED BY VISUAL ART, IMAGERY, GRAPHICS OR PHOTOGRAPHIC IMAGES (U.S. CLS. 100, 101 AND 107).

JOHN GARTNER, EXAMINING ATTORNEY

THE MARK CONSISTS OF STANDARD CHARACTERS WITHOUT CLAIM TO ANY PARTICULAR FONT, STYLE, SIZE, OR COLOR.

NO CLAIM IS MADE TO THE EXCLUSIVE RIGHT TO USE "NETWORK", APART FROM THE MARK AS SHOWN.

CLASS 9—ELECTRICAL AND SCIENTIFIC APPARATUS

FOR COMPUTER SOFTWARE FEATURING PHOTOGRAPHIC IMAGES; MULTIMEDIA FILES CONTAINING TEXT, GRAPHICS, ELECTRONIC PHOTOGRAPHS AND GRAPHIC IMAGES, ALL RELATING TO MUSIC AND SOUND; RINGTONES, RING BACKS, ANIMATED RINGERS AND VIDEO RINGERS, ALL DOWNLOADABLE VIA THE INTERNET OR OTHER COMMUNICATIONS NETWORK, HELD IN ELECTRONIC PERSONAL COMPUTERS AND OTHER WIRELESS MOBILE COMMUNICATION DEVICES (U.S. CLS. 21, 23, 26, 36 AND 38).

CLASS 38—COMMUNICATION

FOR BROADCASTING SERVICES, NAMELY, BROADCASTING AUDIO AND VIDEO MATERIAL VIA CABLE, SATELLITE, INTERNET PROTOCOL TELEVISION (IPTV) TRANSMISSION AND FIBER OPTIC NETWORKS; SUBSCRIPTION TELEVISION BROADCASTING; VIDEO BROADCASTING SERVICES; INTERACTIVE TELEVISION BROADCASTING; VIDEO ON DEMAND TRANSMISSION SERVICE; STREAMING OF AUDIO AND VIDEO MATERIAL VIA THE INTERNET OR OTHER COMMUNICATIONS NETWORK; WIRELESS TRANSMISSION SERVICES, NAMELY, STREAMING OF AUDIO AND VIDEO MATERIAL TO MOBILE PHONES, AND OTHER WIRELESS MOBILE COMMUNICATION DEVICES (U.S. CLS. 100, 101 AND 104).

CLASS 41—EDUCATION AND ENTERTAINMENT

FOR ENTERTAINMENT SERVICES, NAMELY, TELEVISION PROGRAMMING AND PRODUCTION SERVICES; DISTRIBUTION OF TELEVISION PROGRAMS AND SCHEDULING OF TELEVISION PROGRAMMING FOR OTHERS; ONLINE SERVICES, NAMELY, PROVIDING A WEBSITE FEATURING INFORMATION REGARDING TELEVISION PROGRAMS AND THE DISTRIBUTION THEREOF; PROVIDING INTERACTIVE AUDIO AND VIDEO MATERIALS VIA THE INTERNET, NAMELY, NON-DOWNLOADABLE SOUND AND GRAPHICS FEATURING ARTISTIC AND DRAMATIC PRESENTATIONS OF MUSIC OR SOUND ACCOMPANIED BY VISUAL ART, IMAGERY, GRAPHICS OR PHOTOGRAPHIC IMAGES, AND MUSIC VIDEO RECORDINGS; ENTERTAINMENT IN THE NATURE OF ONGOING TELEVISION PROGRAMS IN THE FIELD OF MUSIC VIDEOS AND ARTISTIC AND DRAMATIC PRESENTATIONS OF MUSIC OR SOUND ACCOMPANIED BY VISUAL ART, IMAGERY, GRAPHICS OR PHOTOGRAPHIC IMAGES (U.S. CLS. 100, 101 AND 107).

JOHN GARTNER, EXAMINING ATTORNEY

SN 77-233,718. SHADE IP LICENSING, INC., DALLAS, TX.
FILED 7-19-2007.

SN 77-237,341. TIMBERLAND SWITZERLAND GMBH, 8200
SCHAFFHAUSEN, SWITZERLAND, FILED 7-24-2007.



NO CLAIM IS MADE TO THE EXCLUSIVE RIGHT TO USE "USA" AND "SHADE & FABRIC STRUCTURES" AND "INC.", APART FROM THE MARK AS SHOWN.

THE MARK CONSISTS OF OVERLAPPING SAILS IN A STAR FORMATION NEXT TO THE WORDS "USA SHADE & FABRIC STRUCTURES, INC."

CLASS 6—METAL GOODS

FOR FREESTANDING SHADE STRUCTURES COMPRISED PRIMARILY OF STEEL; FIXED AND PORTABLE SHELTER STRUCTURES FOR USE AS CARPORTS, COMPRISED PRIMARILY OF METAL, BUT WITH A FABRIC COVER (U.S. CLS. 2, 12, 13, 14, 23, 25 AND 50).

CLASS 18—LEATHER GOODS

FOR UMBRELLAS; UMBRELLA PARTS, NAMELY, UMBRELLA BASES, UMBRELLA FRAMES, AND METAL PARTS OF UMBRELLAS; UMBRELLA COVERS (U.S. CLS. 1, 2, 3, 22 AND 41).

CLASS 22—CORDAGE AND FIBERS

FOR FREESTANDING AWNINGS MADE OF POLYETHYLENE; AWNINGS OF FABRIC, FIXED AND PORTABLE (U.S. CLS. 1, 2, 7, 19, 22, 42 AND 50).

CLASS 24—FABRICS

FOR HIGH-DENSITY POLYETHYLENE FABRIC USED TO COVER SHADE STRUCTURES (U.S. CLS. 42 AND 50).

CLASS 37—CONSTRUCTION AND REPAIR

FOR CONSTRUCTION AND INSTALLATION OF FREESTANDING SHADE STRUCTURES, NAMELY, AWNINGS MADE OF STEEL AND CLOTH (U.S. CLS. 100, 103 AND 106).

CLASS 40—MATERIAL TREATMENT

FOR CUSTOM MANUFACTURE AND CUSTOM FABRICATION OF FABRIC CANOPIES, AWNINGS, AND TENTS USED FOR SHADE (U.S. CLS. 100, 103 AND 106).

CLASS 41—EDUCATION AND ENTERTAINMENT

FOR EDUCATIONAL SERVICES, NAMELY, CONDUCTING LECTURES, COURSES, AND WORKSHOPS REGARDING THE EFFECTS OF ULTRA-VIOLET RAYS FROM THE SUN (U.S. CLS. 100, 101 AND 107).
STEVEN R. FOSTER, EXAMINING ATTORNEY

GREEN INDEX

THE MARK CONSISTS OF STANDARD CHARACTERS WITHOUT CLAIM TO ANY PARTICULAR FONT, STYLE, SIZE, OR COLOR.

CLASS 18—LEATHER GOODS

FOR UMBRELLAS; WALLETS; DUFFEL BAGS; BACKPACKS; DAYPACKS; WAIST PACKS; BRIEFCASES; LUGGAGE; COSMETIC CASES SOLD EMPTY; HANDBAGS; TEXTILE SHOPPING BAGS; COIN PURSES; MESSENGER BAGS; TOTE BAGS; AND GYM BAGS (U.S. CLS. 1, 2, 3, 22 AND 41).

CLASS 25—CLOTHING

FOR CLOTHING, NAMELY, COVERALLS, JACKETS, PANTS, SHIRTS, T-SHIRTS, SOCKS, HATS AND SWEATSHIRTS, FOOTWEAR, AND HEADGEAR, NAMELY, HATS, CAPS, VISORS, HEADBANDS, TOQUES, AND BANDANAS (U.S. CLS. 22 AND 39).

MICHAEL WIENER, EXAMINING ATTORNEY

SN 77-238,785. RIND, BONNIE, WALTHAM, MA. FILED 7-25-2007.

BONFIRE

THE MARK CONSISTS OF STANDARD CHARACTERS WITHOUT CLAIM TO ANY PARTICULAR FONT, STYLE, SIZE, OR COLOR.

CLASS 35—ADVERTISING AND BUSINESS

FOR BUSINESS CONSULTING SERVICES FOR OTHERS THAT TARGETS USERS AND BUYERS OF ANY PRODUCT; MARKET ANALYSIS FOR COMPANIES AND FOR INDIVIDUALS TO DEVELOP, TO BUILD, AND TO MARKET PRODUCTS MORE EFFECTIVELY (U.S. CLS. 100, 101 AND 102).

FIRST USE 6-1-2007; IN COMMERCE 6-12-2007.

CLASS 41—EDUCATION AND ENTERTAINMENT

FOR BUSINESS TRAINING, NAMELY, TRAINING OTHERS IN THE SKILLS OF DEVELOPING, BUILDING, AND MARKETING PRODUCTS MORE EFFECTIVELY (U.S. CLS. 100, 101 AND 107).

FIRST USE 6-1-2007; IN COMMERCE 6-12-2007.
BRENDAN REGAN, EXAMINING ATTORNEY

SN 77-243,572. Q.E.P. CO., INC., BOCA RATON, FL. FILED 7-31-2007.

CAPITOL NORTH AMERICA

THE MARK CONSISTS OF STANDARD CHARACTERS WITHOUT CLAIM TO ANY PARTICULAR FONT, STYLE, SIZE, OR COLOR.

NO CLAIM IS MADE TO THE EXCLUSIVE RIGHT TO USE "NORTH AMERICA", APART FROM THE MARK AS SHOWN.

CLASS 1—CHEMICALS

FOR ADHESIVES FOR USE IN THE FLOORING INDUSTRY (U.S. CLS. 1, 5, 6, 10, 26 AND 46).

CLASS 3—COSMETICS AND CLEANING PREPARATIONS

FOR FLOORING AND TILING REFINISHING AND CLEANING MATERIALS, NAMELY, FLOOR CLEANING PREPARATIONS AND SOLUTIONS, IMPREGNATED CLEANING CLOTHS AND CARPET CLEANING PREPARATIONS FOR REMOVING ADHESIVES (U.S. CLS. 1, 4, 6, 50, 51 AND 52).

CLASS 7—MACHINERY

FOR ELECTRIC TOOLS, NAMELY, POWER TILE CUTTERS, POWER SAWS AND BLADES THEREFOR, POWER TILE GRINDERS (U.S. CLS. 13, 19, 21, 23, 31, 34 AND 35).

CLASS 8—HAND TOOLS

FOR HAND TOOLS, NAMELY, UTILITY KNIVES, CARPET KNIVES, DRYWALL AND BRICK SAWS, TROWELS, PLIERS, NIPPERS, SCRAPERS, CARPET AND COVE BASE TRIMMERS, SANDERS, FILES, SPREADERS, FLOATS, MULTI-PURPOSE SHEARS, SNIPS, SEAM ROLLERS, TRIMMING KNIVES, SAWS, AND BLADES THEREFOR; FLOOR AND WALL TILE INSTALLATION AND REPAIR KITS CONSISTING PRIMARILY OF TROWELS, NIPPERS, TILE SPACERS, SAW BLADES, TILE PLIERS AND TILE CUTTERS (U.S. CLS. 23, 28 AND 44).

CLASS 9—ELECTRICAL AND SCIENTIFIC APPARATUS

FOR PROTECTIVE CLOTHING, NAMELY, KNEE PADS FOR WORKERS (U.S. CLS. 21, 23, 26, 36 AND 38).

CLASS 17—RUBBER GOODS

FOR CARPET SEAM TAPE; ADHESIVE BINDING TAPES FOR SECURING FLOOR COVERINGS; ADHESIVE SEALANTS AND CAULKING COMPOUND (U.S. CLS. 1, 5, 12, 13, 35 AND 50).

CLASS 19—NON-METALLIC BUILDING MATERIALS

FOR WOOD CARPET TACK STRIPS; FLOORING AND TILING PRODUCTS, NAMELY, NON-METAL TILES; FLOORING AND TILING INSTALLATION PROJECT KITS FOR INSTALLING, REFINISHING AND REPAIRING NON-METAL TILE AND FLOOR STRIPS, COMPRISING NON-METAL TILES, NON-METAL TILE STRIPS, GROUTS, HAND TOOLS FOR CUTTING AND SHAPING TILES, CLEANING MATERIALS AND WRITTEN INSTRUCTIONS, SOLD AS A UNIT; TILE GROUT INSTALLATION AND REPAIR KITS CONSISTING PRIMARILY OF GROUT, GROUT SAW, AND GROUT APPLICATOR, TILE ADHESIVE, SCRUBBING SPONGE AND DISPOSABLE GLOVES, EACH SOLD AS A UNIT (U.S. CLS. 1, 12, 33 AND 50).

CLASS 21—HOUSEWARES AND GLASS

FOR CLEANING CLOTHS AND CLEANING PADS (U.S. CLS. 2, 13, 23, 29, 30, 33, 40 AND 50).
KELLY MCCOY, EXAMINING ATTORNEY

SN 77-249,371. MY LIFESTYLE, INC., QUEENS VILLAGE, NY. FILED 8-7-2007.



NO CLAIM IS MADE TO THE EXCLUSIVE RIGHT TO USE "INC.", APART FROM THE MARK AS SHOWN.

THE MARK CONSISTS OF AN ANKH (CROSS), A STYLED HUMAN EYE, A SCALE ON WHICH IS BALANCED AN URN AND A FEATHER.

CLASS 25—CLOTHING

FOR CAMISOLES; SKIRT SUITS; SKIRTS; DENIM JACKETS; DOWN JACKETS; HEAVY JACKETS; JACKETS; LEATHER JACKETS; LONG PANTS; MEN AND WOMEN JACKETS, COATS, TROUSERS, VESTS; RAIN JACKETS; SPORTS JACKETS; SUEDE JACKETS; WIND RESISTANT JACKETS; BELTS; BELTS MADE OF LEATHER; FABRIC BELTS; LEATHER BELTS; SUSPENDER BELTS FOR MEN; SUSPENDER BELTS FOR WOMEN; TUXEDO BELTS; WAIST BELTS; BALLOON PANTS; CAPRI PANTS; CARGO PANTS; DENIM PANTS; JOGGING PANTS; LEATHER PANTS; LOUNGE PANTS; PANTS; SWEAT PANTS; TRACK PANTS; YOGA PANTS; JEANS; DENIM JACKETS; CAMP SHIRTS; DRESS SHIRTS; GOLF SHIRTS; KNIT SHIRTS; NIGHT SHIRTS; OPEN-NECKED SHIRTS; POLO SHIRTS; SHIRTS; SHIRTS FOR SUITS; SHOD-SLEEVED OR LONG-SLEEVED T-SHIRTS; SHORT-SLEEVED SHIRTS; SPORT SHIRTS; SWEAT SHIRTS; T-SHIRTS; YOGA SHIRTS; DRESS SUITS; DRESSES; DRESSES MADE FROM SKINS; DRESSING GOWNS; EVENING DRESSES; SKIRTS AND DRESSES; WEDDING DRESSES; WOMEN'S CEREMONIAL DRESSES (U.S. CLS. 22 AND 39).

CLASS 35—ADVERTISING AND BUSINESS

FOR ON-LINE RETAIL STORE SERVICES IN THE FIELDS OF CLOTHING, FOOTWEAR, HEADWEAR, AND ACCESSORIES; RETAIL STORE SERVICES IN THE FIELDS OF CLOTHING, FOOTWEAR, HEADWEAR AND ACCESSORIES (U.S. CLS. 100, 101 AND 102).

CLASS 45—PERSONAL AND LEGAL SERVICES

FOR CHARITABLE SERVICES, NAMELY, PROVIDING CLOTHING DONATIONS TO NEEDY PEOPLE (U.S. CLS. 100 AND 101).

LESLIE RICHARDS, EXAMINING ATTORNEY

SN 77-251,492. DONGSUNG LIM, LONG ISLAND CITY, NY. FILED 8-9-2007.



NO CLAIM IS MADE TO THE EXCLUSIVE RIGHT TO USE "KOREAN", APART FROM THE MARK AS SHOWN.

THE COLOR(S) BLACK, WHITE, YELLOW, RED, BRONZE, LIGHT BLUE AND GREEN IS/ARE CLAIMED AS A FEATURE OF THE MARK.

THE MARK CONSISTS OF A CARTOON-LIKE PROFILE OF A KOREAN MAN WEARING CLOTHES FROM THE EARLY MEDIEVAL ERA OF KOREAN HISTORY. HE'S CARRYING A BRASS DRUM AND GONG AS IF WALKING IN A MARCHING BAND AND WEARING LIGHT BLUE RICE PADDY SHOES ON HIS FEET AND LOOSE WHITE RICE PADDY PANTS. HIS TUNIC IS BLACK WITH RED AND YELLOW SASHES. HE'S FACING AWAY FROM THE AUDIENCE SO THAT YOU CAN ONLY SEE HIS ROSY PINK CHEEKS. HIS HAT IS ROUND WITH A LARGE BASE FOR SHADE AND BLACK WITH YELLOW TRIM. IN THE CENTER OF HIS HAT IS A LONG WHITE RIBBON CIRCLING AROUND HIM AND FLYING IN THE AIR. TO THE RIGHT AND LEVEL WITH THE MAN'S HAT IS THE KOREAN TEXT OF THE RESTAURANT'S NAME IN A DARK GREEN, WRITTEN IN MEDIEVAL KOREAN FONT AS IF HANDPAINTED WITH INK. UNDERNEATH THAT IS WRITTEN "KOREAN ARTS VILLAGE" IN A SLIGHTLY ELONGATED RED FONT WHICH IS THE DIRECT TRANSLATION OF THE KOREAN TEXT.

THE FOREIGN WORDING IN THE MARK TRANSLATES INTO ENGLISH AS "KOREAN ARTS VILLAGE".

THE NON-LATIN CHARACTER(S) IN THE MARK TRANSLITERATES INTO HAN KUK MIN SOK MAH EUL, AND THIS MEANS TRADITIONAL KOREAN VILLAGE IN ENGLISH.

CLASS 25—CLOTHING

FOR (BASED ON INTENT TO USE) PANTS; SKIRTS; SHIRTS; DRESSES; SWEAT SUITS; HATS; CAPS (U.S. CLS. 22 AND 39).

CLASS 43—HOTEL AND RESTAURANT SERVICES

FOR (BASED ON USE IN COMMERCE) RESTAURANT SERVICES (U.S. CLS. 100 AND 101).

FIRST USE 4-26-2007; IN COMMERCE 4-26-2007.
BRIAN NEVILLE, EXAMINING ATTORNEY

SN 77-252,441. HAYMARKET MEDIA, INC., NEW YORK, NY. FILED 8-10-2007.

DM NEWS

NO CLAIM IS MADE TO THE EXCLUSIVE RIGHT TO USE "NEWS", APART FROM THE MARK AS SHOWN. SEC. 2(F).

CLASS 9—ELECTRICAL AND SCIENTIFIC APPARATUS

FOR DOWNLOADABLE ELECTRONIC PUBLICATIONS IN THE NATURE OF ELECTRONIC MAGAZINES AND NEWSLETTERS IN THE FIELD OF ADVERTISING AND DIRECT, DATABASE AND INTERNET MARKETING (U.S. CLS. 21, 23, 26, 36 AND 38).

FIRST USE 12-31-1999; IN COMMERCE 12-31-1999.

CLASS 16—PAPER GOODS AND PRINTED MATTER

FOR PRINTED PUBLICATIONS, NAMELY, BROCHURES, BOOKLETS, AND TEACHING MATERIALS IN THE FIELD OF ADVERTISING AND DIRECT, DATABASE AND INTERNET MARKETING (U.S. CLS. 2, 5, 22, 23, 29, 37, 38 AND 50).

FIRST USE 10-1-1979; IN COMMERCE 10-1-1979.

CLASS 35—ADVERTISING AND BUSINESS

FOR PROVIDING DATABASES OF INFORMATION IN THE FIELDS OF ADVERTISING AND DIRECT, DATABASE AND INTERNET MARKETING (U.S. CLS. 100, 101 AND 102).

FIRST USE 10-1-1979; IN COMMERCE 10-1-1979.

CLASS 41—EDUCATION AND ENTERTAINMENT

FOR PUBLICATION OF PERIODICALS AND DIRECTORIES OF INFORMATION IN THE FIELDS OF ADVERTISING AND DIRECT, DATABASE, AND INTERNET MARKETING; PROVIDING ONLINE ELECTRONIC PUBLICATIONS IN THE NATURE OF ELECTRONIC MAGAZINES AND NEWSLETTERS IN THE FIELD OF ADVERTISING AND DIRECT, DATABASE AND INTERNET MARKETING (U.S. CLS. 100, 101 AND 107).

FIRST USE 10-1-1979; IN COMMERCE 10-1-1979.
TAMARA FRAZIER, EXAMINING ATTORNEY

SN 77-252,819. M-CHEM TECHNOLOGIES INC, DELTA, CANADA, FILED 8-10-2007.

CHEMECOLOGY

THE MARK CONSISTS OF STANDARD CHARACTERS WITHOUT CLAIM TO ANY PARTICULAR FONT, STYLE, SIZE, OR COLOR.

PRIORITY CLAIMED UNDER SEC. 44(D) ON CANADA APPLICATION NO. 1355052, FILED 7-10-2007, REG. NO. TMA723,318, DATED 9-10-2008, EXPIRES 9-10-2023.

CLASS 3—COSMETICS AND CLEANING PREPARATIONS

FOR INDUSTRIAL AND JANITORIAL CLEANING SUPPLIES, NAMELY, DEGREASING, POLISHING AND FINISHING PREPARATIONS AND CLEANING PREPARATIONS WITH DISINFECTING PROPERTIES FOR USE ON INANIMATE SURFACES, NAMELY, FLOOR CLEANING PREPARATIONS, FLOOR POLISHING PREPARATIONS, FLOOR FINISHING PREPARATIONS, FLOOR WAX AND POLISH REMOVING PREPARATIONS, NAMELY, STRIPPING PREPARATIONS FOR REMOVING WAX FROM FLOORS; FURNITURE AND GLASS CLEANING AND POLISHING PREPARATIONS; STAINLESS STEEL CLEANING PREPARATIONS; TILE CLEANING PREPARATIONS; HARDWOOD CLEANING PREPARATIONS; WAREWASH, NAMELY, DETERGENTS AND DISINFECTANTS, AND LAUNDRY SOAPS AND DETERGENTS; HAND SOAPS AND HAND LOTIONS FOR USE IN COMMERCIAL, INDUSTRIAL AND INSTITUTIONAL SETTINGS; CARPET CLEANING SOLUTIONS AND STAIN REMOVERS; CLEANING PREPARATIONS FOR USE ON FABRICS, UPHOLSTERY AND CARPETS, WITH AND WITHOUT DEODORANT PROPERTIES (U.S. CLS. 1, 4, 6, 50, 51 AND 52).

CLASS 16—PAPER GOODS AND PRINTED MATTER

FOR PRINTED MATERIALS, NAMELY, BOOKLETS, PAMPHLETS AND BROCHURES CONTAINING INFORMATION AND RESEARCH IN THE FIELDS OF CHEMISTRY, THE ENVIRONMENT, AND PROMOTING THE USE OF NATURAL PRODUCTS FOR CLEANING AND SANITATION PURPOSES (U.S. CLS. 2, 5, 22, 23, 29, 37, 38 AND 50).

CLASS 35—ADVERTISING AND BUSINESS

FOR OPERATION OF A BUSINESS FOR OTHERS, NAMELY, THE MANUFACTURE OF LIQUID AND POWDERED CHEMICALS, CLEANING EQUIPMENT, CLEANING SOLUTIONS AND CLEANING SYSTEMS (U.S. CLS. 100, 101 AND 102).

CLASS 42—SCIENTIFIC AND COMPUTER SERVICES

FOR PROVIDING SCIENTIFIC RESEARCH INFORMATION OVER A COMPUTER NETWORK IN THE FIELD OF THE ENVIRONMENT (U.S. CLS. 100 AND 101).

WILLIAM ROSSMAN, EXAMINING ATTORNEY

CLASS 3—COSMETICS AND CLEANING PREPARATIONS

FOR INDUSTRIAL AND JANITORIAL CLEANING SUPPLIES, NAMELY, DEGREASING, POLISHING AND FINISHING PREPARATIONS AND CLEANING PREPARATIONS WITH DISINFECTING PROPERTIES FOR USE ON INANIMATE SURFACES, NAMELY, FLOOR CLEANING PREPARATIONS, FLOOR POLISHING PREPARATIONS, FLOOR FINISHING PREPARATIONS, FLOOR WAX AND POLISH REMOVING PREPARATIONS, NAMELY, STRIPPING PREPARATIONS FOR REMOVING WAX FROM FLOORS; FURNITURE AND GLASS CLEANING AND POLISHING PREPARATIONS; STAINLESS STEEL CLEANING PREPARATIONS; TILE CLEANING PREPARATIONS; HARDWOOD CLEANING PREPARATIONS; WAREWASH, NAMELY, DETERGENTS AND DISINFECTANTS, AND LAUNDRY SOAPS AND DETERGENTS; HAND SOAPS AND HAND LOTIONS FOR USE IN COMMERCIAL, INDUSTRIAL AND INSTITUTIONAL SETTINGS; CARPET CLEANING SOLUTIONS AND STAIN REMOVERS; CLEANING PREPARATIONS FOR USE ON FABRICS, UPHOLSTERY AND CARPETS, WITH AND WITHOUT DEODORANT PROPERTIES (U.S. CLS. 1, 4, 6, 50, 51 AND 52).

CLASS 16—PAPER GOODS AND PRINTED MATTER

FOR PRINTED MATERIALS, NAMELY, BOOKLETS, PAMPHLETS AND BROCHURES CONTAINING INFORMATION AND RESEARCH IN THE FIELDS OF CHEMISTRY, THE ENVIRONMENT, AND PROMOTING THE USE OF NATURAL PRODUCTS FOR CLEANING AND SANITATION PURPOSES (U.S. CLS. 2, 5, 22, 23, 29, 37, 38 AND 50).

CLASS 35—ADVERTISING AND BUSINESS

FOR OPERATION OF A BUSINESS FOR OTHERS, NAMELY, THE MANUFACTURE OF LIQUID AND POWDERED CHEMICALS, CLEANING EQUIPMENT, CLEANING SOLUTIONS AND CLEANING SYSTEMS (U.S. CLS. 100, 101 AND 102).

CLASS 42—SCIENTIFIC AND COMPUTER SERVICES

FOR PROVIDING SCIENTIFIC RESEARCH INFORMATION OVER A COMPUTER NETWORK IN THE FIELD OF THE ENVIRONMENT (U.S. CLS. 100 AND 101).

WILLIAM ROSSMAN, EXAMINING ATTORNEY

SN 77-255,461. FSI FONTSHP INTERNATIONAL GMBH, BERLIN, FED REP GERMANY, FILED 8-15-2007.

SN 77-252,829. M-CHEM TECHNOLOGIES INC, DELTA, CANADA, FILED 8-10-2007.



PRIORITY CLAIMED UNDER SEC. 44(D) ON CANADA APPLICATION NO. 1355886, FILED 7-11-2007, REG. NO. TMA723,364, DATED 9-10-2008, EXPIRES 9-10-2023.

THE MARK CONSISTS OF A DROPLET, A LEAF DESIGN AND THE WORDS "CHEM ECOLOGY".

Neon

THE MARK CONSISTS OF STANDARD CHARACTERS WITHOUT CLAIM TO ANY PARTICULAR FONT, STYLE, SIZE, OR COLOR.

CLASS 9—ELECTRICAL AND SCIENTIFIC APPARATUS

FOR MULTIMEDIA SOFTWARE RECORDED ON CD-ROMS FEATURING SCANNED AND DIGITIZED IMAGES, PHOTOGRAPHS, ILLUSTRATIONS, DESIGN AND VIDEO CLIPS IN A WIDE VARIETY OF SUBJECTS, IN INTERNATIONAL CLASS 9 (U.S. CLS. 21, 23, 26, 36 AND 38).

CLASS 16—PAPER GOODS AND PRINTED MATTER

FOR PRINTED MATERIALS, NAMELY, CATALOGS AND BOOKS FEATURING DIGITIZED IMAGES, PHOTOGRAPHS, DESIGNS AND ILLUSTRATIONS (U.S. CLS. 2, 5, 22, 23, 29, 37, 38 AND 50).

CLASS 38—COMMUNICATION

FOR ELECTRONIC DELIVERY OF IMAGES, PHOTOGRAPHS, DESIGNS, ILLUSTRATIONS AND VIDEO CLIPS IN VARIOUS DIGITAL FORMATS OVER A WORLDWIDE COMPUTER NETWORK (U.S. CLS. 100, 101 AND 104).

FIRST USE 6-1-2007; IN COMMERCE 6-1-2007.
RENEE MCCRAY, EXAMINING ATTORNEY

SN 77-258,995. RAFFLES INTERNATIONAL LIMITED, SINGAPORE, SINGAPORE, FILED 8-20-2007.

RAFFLES RESIDENCES

THE MARK CONSISTS OF STANDARD CHARACTERS WITHOUT CLAIM TO ANY PARTICULAR FONT, STYLE, SIZE, OR COLOR.

NO CLAIM IS MADE TO THE EXCLUSIVE RIGHT TO USE "RESIDENCES", APART FROM THE MARK AS SHOWN.

CLASS 35—ADVERTISING AND BUSINESS

FOR BUSINESS MANAGEMENT AND ADMINISTRATION SERVICES; BUSINESS MANAGEMENT OF HOTELS, SERVICE APARTMENTS, FOOD OUTLETS, BEVERAGE OUTLETS, OFFICES, BUSINESS CENTERS, DEPARTMENTAL STORES, SHOPPING CENTERS, RETAIL AND WHOLESALE OUTLETS; BUSINESS MANAGEMENT CONSULTING SERVICES RELATING TO HOTELS, SERVICE APARTMENTS, FOOD OUTLETS, BEVERAGE OUTLETS, OFFICES, BUSINESS CENTERS, DEPARTMENTAL STORES, SHOPPING CENTERS, RETAIL AND WHOLESALE OUTLETS; BUSINESS ADVISORY SERVICES RELATING TO FRANCHISING; PROVIDING OFFICE FUNCTIONS; ORGANIZING MEETINGS, CONFERENCES, CONVENTIONS AND EXHIBITIONS FOR BUSINESS AND COMMERCIAL PURPOSES; RETAIL GIFT SHOPS; THE BRINGING TOGETHER, FOR THE BENEFIT OF OTHERS, OF A VARIETY OF GOODS, ENABLING CUSTOMERS TO CONVENIENTLY VIEW AND PURCHASE THOSE GOODS IN THE FIELD OF FOOD AND BEVERAGES; RETAIL FOOD AND BEVERAGE OUTLETS; RETAIL DEPARTMENT STORES; RETAIL AND WHOLESALE STORES FEATURING GENERAL MERCHANDISE AND GENERAL CONSUMER GOODS; MAIL ORDER CATALOG SERVICES FEATURING GENERAL MERCHANDISE AND GENERAL CONSUMER GOODS; COMPUTERIZED ON-LINE ORDERING FEATURING GENERAL MERCHANDISE AND GENERAL CONSUMER GOODS; PREPARING MAILING LISTS; DIRECT MAIL ADVERTISING; ADVERTISING SERVICES; RETAIL SHOP WINDOW DISPLAY ARRANGEMENT SERVICES; MARKETING, PROMOTION AND PUBLICITY SERVICES; MARKET ANALYSIS AND RESEARCH; GOODS IMPORT-EXPORT AGENCIES; PROCUREMENT, NAMELY, PURCHASING HOTEL AND RESORT FURNISHINGS, HOTEL AND RESORT FIXTURES, AND OPERATING SUPPLIES ON BEHALF OF A BUSINESS AND PURCHASING OFFICE FURNISHINGS, NAMELY, FURNITURE, OFFICE EQUIPMENT, AND DECORATIVE ITEMS ON BEHALF OF A BUSINESS; WINDOW DRESSING AND DISPLAY ARRANGEMENT SERVICES; ADVISORY AND CONSULTING SERVICES RELATING TO THE AFOREMENTIONED BUSINESS FIELDS (U.S. CLS. 100, 101 AND 102).

CLASS 36—INSURANCE AND FINANCIAL

FOR REAL ESTATE MANAGEMENT OF APARTMENTS, FLATS, CONDOMINIUMS, AND RESIDENTIAL ACCOMMODATIONS; REAL ESTATE SERVICES, NAMELY, RENTAL AND LEASING OF APARTMENTS, FLATS, CONDOMINIUMS, AND RESIDENTIAL ACCOMMODATIONS; PROVIDING SHORT-TERM RENTALS OF MEETING SPACES, OFFICE SPACES AND CONFERENCE ROOMS; MANAGEMENT AND OPERATION OF RESIDENTIAL ACCOMMODATIONS; REAL ESTATE MANAGEMENT SERVICES; PROVIDING RESIDENTIAL HOUSING; LEASING OF ACCOMMODATIONS, NAMELY, APARTMENTS, FLATS, CONDOMINIUMS, AND RESIDENTIAL ACCOMMODATIONS ON BEHALF OF OTHERS; AND ADVISORY AND CONSULTING SERVICES RELATED TO REAL ESTATE MANAGEMENT, RENTAL AND LEASING OF REAL ESTATE, SERVICED OFFICES, RESIDENTIAL ACCOMMODATIONS, REAL ESTATE MANAGEMENT SERVICES, AND LEASING OF ACCOMMODATIONS (U.S. CLS. 100, 101 AND 102).

JAY FLOWERS, EXAMINING ATTORNEY

SN 77-259,825. MEXICANS & AMERICANS THINKING TOGETHER-FOUNDATION, INC., SAN ANTONIO, TX. FILED 8-20-2007.



matt.org
Let's prosper together

THE MARK CONSISTS OF A STYLIZED BUBBLE DESIGN WITH THE TERMS "MATT.ORG LET'S PROSPER TOGETHER".

CLASS 35—ADVERTISING AND BUSINESS

FOR PROMOTING PUBLIC AWARENESS OF THE NEED TO ENCOURAGE MEXICANS AND AMERICANS TO UNDERSTAND, ADDRESS AND SOLVE PROBLEMS BETWEEN THE TWO NATIONS; ASSOCIATION SERVICES, NAMELY, PROMOTING THE INTERESTS OF MEXICANS AND AMERICANS TO UNDERSTAND, ADDRESS AND SOLVE PROBLEMS BETWEEN THE TWO NATIONS; PUBLIC ADVOCACY TO PROMOTE AWARENESS BETWEEN MEXICANS AND AMERICANS TO UNDERSTAND, ADDRESS AND SOLVE PROBLEMS BETWEEN THE TWO NATIONS; PROVIDING INFORMATION REGARDING POLITICAL ISSUES; KNOWING HOW TO VOTE AND KNOWING HOW TO REGISTER TO VOTE; PROMOTING THE ECONOMIC DEVELOPMENT IN THE COUNTRY OF MEXICO; PROVIDING ON-LINE INFORMATION AND NEWS IN PRINT AND VIDEO IN THE FIELDS OF GOVERNMENT AFFAIRS, ECONOMICS AND BUSINESS AND TRADE; PROVIDING ONLINE GOVERNMENTAL AFFAIRS INFORMATION IN THE FIELD OF IMMIGRATION; JOB PLACEMENT (U.S. CLS. 100, 101 AND 102).

CLASS 38—COMMUNICATION

FOR VIDEO BROADCASTING; TRANSMISSION OF INFORMATION THROUGH VIDEO COMMUNICATION SYSTEMS; ELECTRONIC TRANSMISSION OF VOICE, DATA AND IMAGES BY TELEVISION AND VIDEO BROADCASTING; AUDIO AND VIDEO BROADCASTING SERVICES OVER THE INTERNET; BROADCASTING PROGRAMS VIA A GLOBAL COMPUTER NETWORK (U.S. CLS. 100, 101 AND 104).

CLASS 41—EDUCATION AND ENTERTAINMENT

FOR PUBLICATION OF THE EDITORIAL CONTENT OF SITES ACCESSIBLE VIA A GLOBAL COMPUTER NETWORK; PROVIDING AN ONLINE NEWS MAGAZINE FEATURING PRINT AND VIDEO IN THE FIELDS OF GOVERNMENT AND DIPLOMATIC RELATIONS, CIVIC RESPONSIBILITY, JOBS, ECONOMY AND TRADE, IMMIGRATION AND SECURITY, ENERGY, ENVIRONMENT AND FREE TRADE; EDUCATIONAL SERVICES, NAMELY, PROVIDING CLASSES, SEMINARS AND WORKSHOPS IN THE FIELDS OF GOVERNMENT AND DIPLOMATIC RELATIONS, CIVIC RESPONSIBILITY, JOBS, ECONOMY AND TRADE, IMMIGRATION AND SECURITY, ENERGY, ENVIRONMENT AND FREE TRADE; PROVIDING ON-LINE PUBLICATIONS IN THE NATURE OF NEWSLETTERS, ARTICLES, REPORTS AND OTHER EDUCATIONAL AND REFERENCE MATERIALS IN THE FIELD OF GOVERNMENT AND DIPLOMATIC RELATIONS, CIVIC RESPONSIBILITY, JOBS, ECONOMY AND TRADE, IMMIGRATION AND SECURITY, ENERGY, ENVIRONMENT AND FREE TRADE; PUBLICATION OF THE EDITORIAL CONTENT OF SITES ACCESSIBLE VIA A GLOBAL COMPUTER NETWORK; ENTERTAINMENT SERVICES, NAMELY, PROVIDING A WEBSITE FEATURING PHOTOGRAPHIC, AUDIO, VIDEO AND PROSE PRESENTATIONS FEATURING GOVERNMENT AND DIPLOMATIC RELATIONS, CIVIC RESPONSIBILITY, JOBS, ECONOMY AND TRADE, IMMIGRATION AND SECURITY, ENERGY, ENVIRONMENT AND FREE TRADE (U.S. CLS. 100, 101 AND 107).

KAPIL BHANOT, EXAMINING ATTORNEY

CLASS 42—SCIENTIFIC AND COMPUTER SERVICES

FOR DEVELOPMENT OF ELECTRIC AND ELECTRONIC CIRCUITS, ELECTRONIC EQUIPMENT AND COMPUTER SOFTWARE FOR TELEMATIC SYSTEMS AND DATA LINK SYSTEMS (U.S. CLS. 100 AND 101).

FIRST USE 4-1-2004; IN COMMERCE 4-1-2004.

AISHA SALEM, EXAMINING ATTORNEY

SN 77-260,525. HUMANITIES FOR SCHOOLS, LLC, NEW YORK, NY. FILED 8-21-2007.

THE BETTER HOUR

THE MARK CONSISTS OF STANDARD CHARACTERS WITHOUT CLAIM TO ANY PARTICULAR FONT, STYLE, SIZE, OR COLOR.

CLASS 9—ELECTRICAL AND SCIENTIFIC APPARATUS

FOR (BASED ON INTENT TO USE) PRE-RECORDED AUDIO AND VIDEO TAPES, CASSETTES, CDS AND DVDS FEATURING HISTORICAL MATTERS (U.S. CLS. 21, 23, 26, 36 AND 38).

CLASS 16—PAPER GOODS AND PRINTED MATTER

FOR (BASED ON INTENT TO USE) PRINTED MATERIALS, NAMELY, BOOKS, MANUALS AND STUDY GUIDES FEATURING HISTORICAL MATTERS (U.S. CLS. 2, 5, 22, 23, 29, 37, 38 AND 50).

CLASS 35—ADVERTISING AND BUSINESS

FOR (BASED ON USE IN COMMERCE) PROVIDING AN INFORMATIONAL WEB SITE PROMOTING LITERACY; PROVIDING AN INFORMATIONAL WEB SITE PROMOTING CULTURAL PROGRAMS FOR CHILDREN AND ADULTS (U.S. CLS. 100, 101 AND 102).

FIRST USE 4-16-2007; IN COMMERCE 4-16-2007.

CLASS 41—EDUCATION AND ENTERTAINMENT

FOR (BASED ON USE IN COMMERCE) ARRANGING AND CONDUCTING CONTESTS; ENTERTAINMENT SERVICES, NAMELY, PROVIDING A TELEVISION PROGRAM FEATURING HISTORICAL MATTERS; EDUCATIONAL AND COMMUNITY SERVICES, NAMELY, LITERACY AND CULTURAL PROGRAMS FOR CHILDREN AND ADULTS (U.S. CLS. 100, 101 AND 107).

FIRST USE 4-16-2007; IN COMMERCE 4-16-2007.

ALLISON HOLTZ, EXAMINING ATTORNEY

SN 77-259,832. RM MICHAELIDES SOFTWARE & ELEKTRONIK GMBH, D-36043 FULDA, FED REP GERMANY, FILED 8-20-2007.

PROEMION

THE MARK CONSISTS OF STANDARD CHARACTERS WITHOUT CLAIM TO ANY PARTICULAR FONT, STYLE, SIZE, OR COLOR.

CLASS 9—ELECTRICAL AND SCIENTIFIC APPARATUS

FOR COMPUTER HARDWARE AND SOFTWARE FOR USE IN BI-DIRECTIONAL COMMUNICATION BETWEEN MACHINES, VEHICLES AND END USERS, ELECTRIC AND ELECTRONIC CIRCUITS AND ELECTRONIC EQUIPMENT FOR CONTROLLING AND MONITORING TELEMATIC SYSTEMS AND DATA LINK SYSTEMS (U.S. CLS. 21, 23, 26, 36 AND 38).

FIRST USE 4-1-2004; IN COMMERCE 4-1-2004.

CLASS 16—PAPER GOODS AND PRINTED MATTER

FOR PRINTED MATERIAL, NAMELY, BROCHURES, MANUALS OF OPERATION, USER GUIDES, CATALOGS AND SPECIFICATION DOCUMENTS RELATING TO COMPUTER HARDWARE AND SOFTWARE, ELECTRIC AND ELECTRONIC CIRCUITS, ELECTRONIC EQUIPMENT FOR TELEMATIC SYSTEMS AND DATA LINK SYSTEMS (U.S. CLS. 2, 5, 22, 23, 29, 37, 38 AND 50).

FIRST USE 4-1-2004; IN COMMERCE 4-1-2004.

SN 77-264,245. GROHE AG, D-58675 HEMER, FED REP GERMANY, FILED 8-24-2007.

Grohe WaterCare

THE MARK CONSISTS OF STANDARD CHARACTERS WITHOUT CLAIM TO ANY PARTICULAR FONT, STYLE, SIZE, OR COLOR.

OWNER OF ERPN CMNTY TM OFC REG. NO. 005661228, DATED 2-6-2008, EXPIRES 2-2-2017.

OWNER OF U.S. REG. NOS. 1,151,616, 1,902,412 AND 2,781,356.

NO CLAIM IS MADE TO THE EXCLUSIVE RIGHT TO USE "WATERCARE", APART FROM THE MARK AS SHOWN.

CLASS 9—ELECTRICAL AND SCIENTIFIC APPARATUS

FOR THERMOSTATS FOR CONTROL OF HOT WATER OF WATER MIXERS AND WATER FAUCETS; THERMOSTATICALLY, ELECTRICALLY OR ULTRASONICALLY, INFRARED OR RADAR ELECTRONIC CONTROLLED WATER MIXING VALVES; PARTS AND COMPONENTS THEREFOR (U.S. CLS. 21, 23, 26, 36 AND 38).

CLASS 11—ENVIRONMENTAL CONTROL APPARATUS

FOR WATER VALVES, WATER MIXING VALVES, WATER MIXERS, SELF CLOSING WATER VALVES AND WATER MIXERS AND WATER FAUCETS; SHOWERS, SHOWER SETS, HAND AND HEAD SHOWERS; LIGHTING FIXTURES AND COMPLETE LINES OF PLUMBING FITTINGS FOR SAID VALVES, MIXERS, FAUCETS AND SHOWERS FOR KITCHEN AND BATH; PARTS AND COMPONENTS THEREFOR (U.S. CLS. 13, 21, 23, 31 AND 34).

HEATHER THOMPSON, EXAMINING ATTORNEY

SN 77-268,222. SEEMAGE S.A, BIOT, FRANCE, FILED 8-30-2007.

SEEMAGE

THE MARK CONSISTS OF STANDARD CHARACTERS WITHOUT CLAIM TO ANY PARTICULAR FONT, STYLE, SIZE, OR COLOR.

OWNER OF FRANCE REG. NO. 023161729, DATED 4-26-2002, EXPIRES 4-26-2012.

CLASS 9—ELECTRICAL AND SCIENTIFIC APPARATUS

FOR SOFTWARE FOR THE CREATION OF CONTENT FOR CREATING, DISPLAYING AND CONVERTING LITERATURE OF PRODUCTS AND ANIMATIONS IN OTHER COMPUTER FORMATS IN THE FIELD OF TECHNICAL ILLUSTRATIONS IN 2D AND IN 3D; GAME SOFTWARE FOR THE CREATION OF CONTENT FOR CREATING, DISPLAYING AND CONVERTING LITERATURE OF PRODUCTS AND ANIMATIONS IN OTHER COMPUTER FORMATS IN THE FIELD OF TECHNICAL ILLUSTRATIONS IN 2D AND IN 3D; COMPUTER PROGRAMS FOR CREATING, DISPLAYING AND CONVERTING LITERATURE OF PRODUCTS AND ANIMATIONS IN OTHER COMPUTER FORMATS IN THE FIELD OF TECHNICAL ILLUSTRATIONS IN 2D AND IN 3D; DOWNLOADABLE SOFTWARE FOR CREATING, DISPLAYING AND CONVERTING LITERATURE OF PRODUCTS AND ANIMATIONS IN OTHER COMPUTER FORMATS IN THE FIELD OF TECHNICAL ILLUSTRATIONS IN 2D AND IN 3D (U.S. CLS. 21, 23, 26, 36 AND 38).

CLASS 38—COMMUNICATION

FOR COMPUTER-ASSISTED MESSAGE AND IMAGE TRANSMISSION COMMUNICATIONS VIA COMPUTER TERMINALS (U.S. CLS. 100, 101 AND 104).

CLASS 42—SCIENTIFIC AND COMPUTER SERVICES

FOR CREATION AND MAINTENANCE OF WEB SITES FOR OTHERS, CONVERSION OF COMPUTER DATA AND PROGRAMS, COMPUTER CONSULTING, COMPUTER PROGRAMMING, SOFTWARE DESIGN AND DEVELOPMENT, MAINTENANCE OF SOFTWARE, RENTAL OF COMPUTER SOFTWARE, RESEARCH AND DEVELOPMENT OF NEW PRODUCTS FOR THIRD PARTIES (U.S. CLS. 100 AND 101).

BRENDAN REGAN, EXAMINING ATTORNEY

SN 77-269,555. ENERFLOW INDUSTRIES INC., CALGARY, ALBERTA, CANADA, FILED 8-31-2007.

ECAMS

THE MARK CONSISTS OF STANDARD CHARACTERS WITHOUT CLAIM TO ANY PARTICULAR FONT, STYLE, SIZE, OR COLOR.

OWNER OF CANADA REG. NO. TMA704480, DATED 1-11-2008, EXPIRES 1-11-2023.

CLASS 7—MACHINERY

FOR OIL AND GAS EQUIPMENT, NAMELY, MACHINERY FOR MANUFACTURING FOR USE IN THE OIL AND GAS INDUSTRY, NAMELY, BLENDER UNITS; OIL AND GAS WELL MACHINERY, NAMELY, ELECTRIC PUMP UNITS, BLENDER UNITS, HYDRATION UNITS, CEMENTER UNITS, CARBON DIOXIDE PUMPER UNITS, MUD PUMPS, AIR COMPRESSORS, HELI-PORTABLE PUMP UNITS, HELI-PORTABLE NITROGEN UNITS, FRAC THROUGH COIL TUBING UNITS, LIQUID ADDITIVE UNITS, DRILLING CONTROL UNITS, NITROGEN PUMPING AND STORAGE UNITS, COIL DRILLING UNITS AND CONVENTIONAL TOP DRIVE DRILLING UNITS, SAND BIN UNITS, SAND CONVEYOR UNITS, HYDRAULIC POWER PACK UNITS, CEMENT BULK PLANT UNITS, FLUSH BY UNITS, HOT OILERS AND SERVICE RIGS (U.S. CLS. 13, 19, 21, 23, 31, 34 AND 35).

CLASS 9—ELECTRICAL AND SCIENTIFIC APPARATUS

FOR COMPUTER SOFTWARE, NAMELY, COMPUTER SOFTWARE FOR USE WITH OIL AND GAS EQUIPMENT, CONTROL SYSTEMS AND MACHINERY FOR USE IN THE OIL AND GAS INDUSTRY TO MONITOR, CONTROL AND ANALYZE DATA FROM OIL AND GAS EQUIPMENT, CONTROL SYSTEMS AND MACHINERY, INCLUDING FRAC PUMPER UNITS, BLENDER UNITS, DATA VANS, CHEMICAL VANS, HYDRATION UNITS, CEMENTER UNITS, CARBON DIOXIDE PUMPER UNITS, MUD PUMPS, AIR COMPRESSORS, HELI PORTABLE PUMPER UNITS, HELI PORTABLE NITROGEN UNITS, FRAC THROUGH COIL TUBING UNITS, LIQUID ADDITIVE UNITS, DRILLING CONTROL UNITS, NITROGEN PUMPING AND STORAGE UNITS, COIL DRILLING UNITS, CONVENTIONAL TOP DRIVE DRILLING UNITS, SAND BIN UNITS, SAND CONVEYOR UNITS, HYDRAULIC POWER PACK UNITS, CEMENT BULK PLANT UNITS, FLUSH BY UNITS, KILL TRUCKS, PUMP AND TANK TRUCKS, HOT OILERS AND SERVICE RIGS; OIL AND GAS EQUIPMENT, NAMELY ELECTRONIC CONTROL SYSTEMS FOR MANUFACTURING FOR USE IN THE OIL AND GAS INDUSTRY, NAMELY, BLENDER UNITS; ELECTRONIC PUBLICATIONS, NAMELY, INSTRUCTION AND USER MANUALS RELATING TO OIL AND GAS EQUIPMENT, CONTROL SYSTEMS AND MACHINERY FOR USE IN THE OIL AND GAS INDUSTRY, RECORDED ON COMPUTER MEDIA; DOWNLOADABLE ELECTRONIC PUBLICATIONS IN THE NATURE OF INSTRUCTION AND USER MANUALS RELATING TO OIL AND GAS EQUIPMENT, CONTROL SYSTEMS AND MACHINERY FOR USE IN THE OIL AND GAS INDUSTRY (U.S. CLS. 21, 23, 26, 36 AND 38).

CLASS 12—VEHICLES

FOR VEHICLES, NAMELY, CHEMICAL VANS, KILL TRUCKS, PUMP AND TANK TRUCKS (U.S. CLS. 19, 21, 23, 31, 35 AND 44).

CLASS 16—PAPER GOODS AND PRINTED MATTER

FOR PRINTED PUBLICATIONS, NAMELY, INSTRUCTION AND USER MANUALS RELATING TO OIL AND GAS EQUIPMENT, CONTROL SYSTEMS AND MACHINERY FOR USE IN THE OIL AND GAS INDUSTRY; WRITING PADS, PENS (U.S. CLS. 2, 5, 22, 23, 29, 37, 38 AND 50).

CLASS 21—HOUSEWARES AND GLASS

FOR MUGS (U.S. CLS. 2, 13, 23, 29, 30, 33, 40 AND 50).

CLASS 25—CLOTHING

FOR CLOTHING, NAMELY, T-SHIRTS, GOLF SHIRTS, SWEAT SHIRTS, HATS, JACKETS, VESTS (U.S. CLS. 22 AND 39).

CLASS 35—ADVERTISING AND BUSINESS

FOR BUSINESS CONSULTATION AND BUSINESS INFORMATION RELATING TO THE USE OF OIL AND GAS EQUIPMENT, CONTROL SYSTEMS AND MACHINERY FOR USE IN THE OIL AND GAS INDUSTRY, INCLUDING BLENDER UNITS (U.S. CLS. 100, 101 AND 102).

CLASS 37—CONSTRUCTION AND REPAIR

FOR INSTALLATION OF OIL AND GAS MACHINERY, NAMELY, BLENDER UNITS; TECHNICAL SUPPORT SERVICES, NAMELY, PROVIDING TECHNICAL ADVICE RELATED TO THE INSTALLATION OF OIL AND GAS EQUIPMENT, CONTROL SYSTEMS AND MACHINERY, INCLUDING BLENDER UNITS (U.S. CLS. 100, 103 AND 106).

CLASS 40—MATERIAL TREATMENT

FOR CUSTOM FABRICATION OF OIL AND GAS MACHINERY, NAMELY, BLENDER UNITS; CUSTOM MANUFACTURING OF OIL AND GAS MACHINERY, NAMELY, BLENDER UNITS; TECHNICAL SUPPORT SERVICES, NAMELY, PROVIDING TECHNICAL ADVICE RELATED TO THE MANUFACTURING OF OIL AND GAS EQUIPMENT, CONTROL SYSTEMS AND MACHINERY, INCLUDING BLENDER UNITS (U.S. CLS. 100, 103 AND 106).

CLASS 42—SCIENTIFIC AND COMPUTER SERVICES

FOR CONSULTATION AND DESIGN SERVICES RELATING TO THE USE OF OIL AND GAS EQUIPMENT, CONTROL SYSTEMS AND MACHINERY FOR USE IN THE OIL AND GAS INDUSTRY, INCLUDING BLENDER UNITS; PROVIDING TECHNOLOGY INFORMATION IN THE OIL AND GAS INDUSTRY (U.S. CLS. 100 AND 101).
CHERYL CLAYTON, EXAMINING ATTORNEY

SN 77-269,820. SYMPATHYFOOD.COM, LLC, BOWLING GREEN, VA. FILED 8-31-2007.

A COMFORTING ALTERNATIVE TO FLOWERS

THE MARK CONSISTS OF STANDARD CHARACTERS WITHOUT CLAIM TO ANY PARTICULAR FONT, STYLE, SIZE, OR COLOR.

CLASS 29—MEATS AND PROCESSED FOODS

FOR FROZEN, PREPARED AND PACKAGED ENTREES CONSISTING PRIMARILY OF MEAT, FISH, POULTRY OR VEGETABLES PROVIDED TO INDIVIDUALS FOR BEREAVED FRIENDS AND FAMILY (U.S. CL. 46).

FIRST USE 7-1-2007; IN COMMERCE 1-15-2008.

CLASS 30—STAPLE FOODS

FOR FROZEN, PREPARED AND PACKAGED ENTREES CONSISTING PRIMARILY OF PASTA OR RICE PROVIDED TO INDIVIDUALS FOR BEREAVED FRIENDS AND FAMILY (U.S. CL. 46).

FIRST USE 7-1-2007; IN COMMERCE 1-15-2008.

CLASS 31—NATURAL AGRICULTURAL PRODUCTS

FOR FRESH FRUITS, FRESH VEGETABLES, FRESH NUTS, FRUIT SEEDS AND UNPROCESSED GRAINS AND FRESH HERBS PROVIDED TO INDIVIDUALS FOR BEREAVED FRIENDS AND FAMILY (U.S. CLS. 1 AND 46).

FIRST USE 7-1-2007; IN COMMERCE 1-15-2008.

CLASS 35—ADVERTISING AND BUSINESS

FOR COMPUTERIZED ON-LINE RETAIL STORE SERVICES FEATURING FOOD AND GIFTS FOR BEREAVED INDIVIDUALS (U.S. CLS. 100, 101 AND 102).

FIRST USE 7-1-2007; IN COMMERCE 1-15-2008.
EVELYN BRADLEY, EXAMINING ATTORNEY

SN 77-269,946. BRIDGET E. MACTAVISH, ASPEN, CO.
FILED 8-31-2007.

BRIGI

THE MARK CONSISTS OF STANDARD CHARACTERS WITHOUT CLAIM TO ANY PARTICULAR FONT, STYLE, SIZE, OR COLOR.

CLASS 3—COSMETICS AND CLEANING PREPARATIONS

FOR COSMETICS (U.S. CLS. 1, 4, 6, 50, 51 AND 52).

CLASS 25—CLOTHING

FOR CLOTHING, NAMELY, INFANT WEAR, PAJAMAS, SLEEPWEAR, ROBES, T-SHIRTS, SWEATERS, PANTS, JEANS, HATS, SHOWER CAPS, SOCKS, STOCKINGS, LEGGINGS, HOSIERY, TIGHTS, SHORTS, BOXERS, CAPRIS, OVERALLS, TROUSERS, NIGHTGOWNS, NIGHT SHIRTS, DRESSES, GOWNS, SUITS, VESTS, SHIRTS, SKIRTS, JACKETS, WIND RESISTANT JACKETS, RAIN COATS, COATS, SKI JACKETS, LEATHER JACKETS, BLAZERS, HOODED SWEATSHIRTS, HOODED PULLOVERS, BIKINIS, LOUNGE PANTS, JOGGING SUITS, YOGA PANTS, BLOUSES, TANK TOPS, CAMISOLES, V-NECK SWEATERS, TUBE TOPS, LINGERIE, BRAS, PANTIES, GARTERS, SLIPS, CORSETS, BOY SHORTS, FOOTWEAR, CLOTH BIBS, PLASTIC BABY BIBS, APRONS, JUMPERS, MUFFS, SKI MASKS, SWIMMING CAPS, PONCHOS, SHAWLS, SLIPPERS; FASHION ACCESSORIES, NAMELY BELTS, SUSPENDERS, SCARVES, HEADBANDS, EAR MUFFS, WRIST BANDS, GLOVES, MITTENS, NECKTIES, AND BOW TIES (U.S. CLS. 22 AND 39).

CLASS 28—TOYS AND SPORTING GOODS

FOR TOYS, NAMELY, STUFFED AND PLUSH TOYS, STUFFED DOLLS AND ANIMALS, STUFFED TOY BEARS, TEDDY BEARS, DOLLS, DOLL ACCESSORIES, DOLL CLOTHING, PLAY FIGURES, MOLDED TOY FIGURES, TOY FIGURES AND ACCESSORIES THEREFOR, BALLS FOR GAMES, BALLS FOR SPORTS, TOY CARS, BOARD GAMES, BUBBLE MAKING WAND AND SOLUTION SETS, KITES (U.S. CLS. 22, 23, 38 AND 50).
SONYA STEPHENS, EXAMINING ATTORNEY

SN 77-270,544. TERRA NIGRA HOLDING B.V., AP KUDELSTAART, NETHERLANDS, FILED 9-4-2007.

GERFOLIA

THE MARK CONSISTS OF STANDARD CHARACTERS WITHOUT CLAIM TO ANY PARTICULAR FONT, STYLE, SIZE, OR COLOR.

PRIORITY CLAIMED UNDER SEC. 44(D) ON BENELUX APPLICATION NO. 1138824, FILED 7-6-2007, REG. NO. 0827229, DATED 10-5-2007, EXPIRES 7-6-2017.

CLASS 16—PAPER GOODS AND PRINTED MATTER

FOR PAPER, CARDBOARD AND GOODS MADE FROM THESE MATERIALS, NOT INCLUDED IN OTHER CLASSES, NAMELY, PAPER BOXES, CARDBOARD PACKAGING; PRINTED MATTER, NAMELY, CATALOGS, MAGAZINES, BROCHURES AND BOOKS IN THE FIELD OF HORTICULTURE, AGRICULTURE AND FLOWERS; BOOKBINDING MATERIAL; PHOTOGRAPHS; STATIONERY; ADHESIVES FOR STATIONERY AND HOUSEHOLD PURPOSES; ARTISTS' MATERIALS, NAMELY, PAINT BRUSHES; TYPEWRITERS; OFFICE REQUISITES, NAMELY, STAPLERS, RUBBER BANDS; PRINTED INSTRUCTIONAL AND TEACHING MATERIAL IN THE FIELD OF HORTICULTURE, AGRICULTURE AND FLOWERS; PLASTIC BUBBLE PACKS FOR WRAPPING AND PACKAGING; PRINTERS' TYPE; PRINTING BLOCKS (U.S. CLS. 2, 5, 22, 23, 29, 37, 38 AND 50).

CLASS 26—FANCY GOODS

FOR LACE AND EMBROIDERY, RIBBONS AND BRAID; BUTTONS, HOOKS AND EYES, SEWING AND SAFETY PINS AND NEEDLES; ARTIFICIAL FLOWERS (U.S. CLS. 37, 39, 40, 42 AND 50).

CLASS 31—NATURAL AGRICULTURAL PRODUCTS

FOR AGRICULTURAL, HORTICULTURAL AND FORESTRY PRODUCTS, NAMELY, UNPROCESSED GRAINS AND SEEDS NOT INCLUDED IN OTHER CLASSES; LIVE ANIMALS; FRESH FRUITS AND VEGETABLES; NATURAL PLANTS AND FLOWERS; ANIMAL FOODSTUFFS (U.S. CLS. 1 AND 46).
AISHA SALEM, EXAMINING ATTORNEY

SN 77-271,059. SHUBIZ LIMITED, LONDON, ENGLAND, FILED 9-4-2007.

SHUBIZ

THE MARK CONSISTS OF STANDARD CHARACTERS WITHOUT CLAIM TO ANY PARTICULAR FONT, STYLE, SIZE, OR COLOR.

CLASS 18—LEATHER GOODS

FOR LEATHER SHOPPING BAGS; LEATHER CASES FOR CALLING CARDS; HAT BOXES OF LEATHER; LEATHER BOXES FOR STORING GREETING CARDS; BACKPACKS FOR CLIMBERS AND CAMPERS; LEATHER LEADS AND LEATHER LEASHES FOR ANIMALS; UNFITTED VANITY CASES; LEATHER AND IMITATION LEATHER; TRAVELING BAGS; TRAVELING TRUNKS; SCHOOL BAGS; SATCHELS; BACKPACKS; RUCKSACKS; HAVERSACKS; BAGS OF LEATHER, FOR PACKING; BANDS OF LEATHER; BEACH BAGS; HANDBAG FRAMES OF LEATHER; SUITCASES; KEY CASES; POCKET WALLETTS; POUCHES OF LEATHER; PURSES; VALISES; ARTICLES OF LUGGAGE; HANDBAGS; BRIEFCASES AND WALLETTS (U.S. CLS. 1, 2, 3, 22 AND 41).

CLASS 25—CLOTHING

FOR CLOTH BIBS; SKI BIBS; BEACH CLOTHES, NAMELY, SWIMSUITS, SWIM TRUNKS, COVER-UPS, HATS; CLOTHING OF LEATHER, NAMELY, PANTS, JACKETS, GLOVES, HATS; KNITWEAR, NAMELY, SWEATERS, VESTS, JUMPERS, MITTENS, HATS; APRONS; BATH ROBES; BATHING SUITS; BERETS; BODICES; BRACES FOR CLOTHING; CAMISOLES; CAPS; COATS; CUFFS; DRESSING GOWNS; EAR MUFFS; GLOVES; GOWNS; HATS; HEADBANDS; JACKETS; JERSEYS; JUMPERS; MITTENS; NECKTIES; OVERALLS; PAJAMAS; UNDERWEAR; SCARVES; SHAWLS; SHIRTS; SKIRTS; SOCKS; SUITS; SWEATERS; T-SHIRTS; TROUSERS; UNDERGARMENTS; VESTS; WAISTCOATS; WRISTBANDS; FOOTWEAR; BOOTS, SHOES, SLIPPERS AND SANDALS; HOSIERY; BELTS (U.S. CLS. 22 AND 39).

CHRISTINE COOPER, EXAMINING ATTORNEY

SN 77-276,199. BRANDED MARKETING LLC, WEST MILFORD, NJ. FILED 9-11-2007.

PRIMACARD

THE MARK CONSISTS OF STANDARD CHARACTERS WITHOUT CLAIM TO ANY PARTICULAR FONT, STYLE, SIZE, OR COLOR.

CLASS 9—ELECTRICAL AND SCIENTIFIC APPARATUS

FOR MACHINE READABLE MAGNETICALLY ENCODED PREPAID DEBIT CARDS, STORED VALUE CARDS, AND PREPAID FINANCIAL CARDS WITH FREE INTERNATIONAL CALLING CAPABILITIES (U.S. CLS. 21, 23, 26, 36 AND 38).

CLASS 35—ADVERTISING AND BUSINESS

FOR BILLING SERVICES; COLLECTION OF BILLING INFORMATION AND MANAGEMENT OF DATABASES FOR CARRIERS OF ROAMING SERVICES; TELEPHONE-ORDER SERVICES AND ELECTRONIC ORDERING SERVICES FEATURING DEBIT CARDS, STORED VALUE CARDS, AND PREPAID FINANCIAL CARDS WITH FREE INTERNATIONAL CALLING CAPABILITIES (U.S. CLS. 100, 101 AND 102).

CLASS 36—INSURANCE AND FINANCIAL

FOR BANKING PAYMENT SERVICES, NAMELY, BILL PAYMENT SERVICES AND DEBIT CARD TRANSACTION PAYMENT PROCESSING SERVICES; COMPUTER SERVICES IN THE NATURE OF PROVIDING NEWS AND INFORMATION IN THE FIELD OF DEBIT CARDS VIA TELEPHONE AND VIA GLOBAL COMPUTER NETWORKS (U.S. CLS. 100, 101 AND 102).

CLASS 38—COMMUNICATION

FOR TELEPHONE VOICE MESSAGING SERVICES; PROVIDING MULTIPLE-USER ACCESS TO GLOBAL COMPUTER NETWORKS TO TRANSMIT, RECEIVE AND OTHERWISE ACCESS AND USE INFORMATION OF GENERAL INTEREST TO CONSUMERS (U.S. CLS. 100, 101 AND 104).

NATALIE POLZER, EXAMINING ATTORNEY

SN 77-276,941. BRIDGET E. MACTAVISH, ASPEN, CO. FILED 9-11-2007.

NEVER GET DRESSED

THE MARK CONSISTS OF STANDARD CHARACTERS WITHOUT CLAIM TO ANY PARTICULAR FONT, STYLE, SIZE, OR COLOR.

CLASS 3—COSMETICS AND CLEANING PREPARATIONS

FOR COSMETICS (U.S. CLS. 1, 4, 6, 50, 51 AND 52).

CLASS 24—FABRICS

FOR FABRIC, NAMELY, SILK, COTTON, POLYESTER, SPANDEX, WELLS SOFT, COTTON TERRY, COTTON KNIT, COTTON FLANNEL, WOVEN COTTON, SILK CHARMEUSE, FLEECE, POLY STRETCH SATIN, SATIN, COTTON DENIM, COTTON SPANDEX BLEND, SILK DUPIONI, CASHMERE, CHIFFON, POLY COTTON BLENDS, RAYON, RAYON SPANDEX BLENDS, POLY COTTON KNIT BLENDS, VELVET, VELOUR; BED BLANKETS; BEDDING, NAMELY, BED LINEN, BED SHEETS, PILLOW CASES, COMFORTERS, BEDSPREADS, PILLOW SHAMS, DUST RUFFLES (U.S. CLS. 42 AND 50).

CLASS 25—CLOTHING

FOR CLOTHING, NAMELY, INFANT WEAR, PAJAMAS, SLEEPWEAR, ROBES, T-SHIRTS, SWEATERS, PANTS, JEANS, HATS, SHOWER CAPS, SOCKS, STOCKINGS, LEGGINGS, HOSIERY, TIGHTS, SHORTS, BOXERS, CAPRIS, OVERALLS, TROUSERS, NIGHTGOWNS, NIGHT SHIRTS, DRESSES, GOWNS, SUITS, VESTS, SHIRTS, SKIRTS, JACKETS, WIND RESISTANT JACKETS, RAIN COATS, COATS, SKI JACKETS, LEATHER JACKETS, BLAZERS, HOODED SWEATSHIRTS, HOODED PULLOVERS, BIKINIS, LOUNGE PANTS, JOGGING SUITS, YOGA PANTS, BLOUSES, TANK TOPS, CAMISOLES, V-NECK SWEATERS, TUBE TOPS, LINGERIE, BRAS, PANTIES, GARTERS, SLIPS, CORSETS, BOY SHORTS, FOOTWEAR, CLOTH BIBS, PLASTIC BABY BIBS, APRONS, JUMPERS, MUFFS, SKI MASKS, SWIMMING CAPS, PONCHOS, SHAWLS, SLIPPERS; FASHION ACCESSORIES, NAMELY, BELTS, SUSPENDERS, SCARVES, HEADBANDS, EAR MUFFS, WRIST BANDS, GLOVES, MITTENS, NECKTIES, AND BOW TIES (U.S. CLS. 22 AND 39).

SONYA STEPHENS, EXAMINING ATTORNEY

SN 77-277,322. BIONOVIX, INC., SCOTTSDALE, AZ. FILED 9-12-2007.

Isonostix

THE MARK CONSISTS OF STANDARD CHARACTERS WITHOUT CLAIM TO ANY PARTICULAR FONT, STYLE, SIZE, OR COLOR.

CLASS 10—MEDICAL APPARATUS

FOR HOME URINE COLLECTION KIT CONSISTING OF TEST TUBES, PIPETTE, AND SELF-MAILER USED TO DETERMINE A PERSONS NUTRACEUTICAL NEEDS (U.S. CLS. 26, 39 AND 44).

CLASS 44—MEDICAL, BEAUTY AND AGRICULTURAL SERVICES

FOR METABOLIC TESTING FOR NUTRACEUTICAL NEEDS (U.S. CLS. 100 AND 101).
 JUDITH HELFMAN, EXAMINING ATTORNEY

CLASS 42—SCIENTIFIC AND COMPUTER SERVICES

FOR FOOD SAFETY TESTING IMPLEMENTED AT FOOD PROCESSING FACILITIES AND/OR FOOD DISTRIBUTION CHAINS FROM ORIGIN OF FOOD PRODUCT TO SALES POINT; FOOD SAFETY PROGRAMS AND SERVICES, NAMELY, FOOD SAFETY TESTING AND CONSULTATION SERVICES, PROVIDING ONLINE INFORMATION RELATING TO FOOD SAFETY AND FOOD SECURITY; FOOD SAFETY CONSULTATION SERVICES IMPLEMENTED AT FOOD PROCESSING FACILITIES AND/OR FOOD DISTRIBUTION CHAINS FROM ORIGIN OF FOOD PRODUCT TO SALES POINT; TESTING, CONSULTATION, ANALYSIS OF FOOD SAFETY IN FOOD PROCESSING AND DISTRIBUTION; SAFETY INSPECTION AUDITS TO IMPROVE FOOD SAFETY IN FOOD PROCESSING AND DISTRIBUTION; REMOTE AND ONSITE MONITORING SERVICES OF FOOD PROCESSING EQUIPMENT AND PRODUCTION SYSTEMS (U.S. CLS. 100 AND 101).
 KELLY BOULTON, EXAMINING ATTORNEY

SN 77-280,328. GLOBAL FOOD TECHNOLOGIES, INC., HANFORD, CA. FILED 9-14-2007.

SN 77-286,278. PLAYBOOX, INC., SAN FRANCISCO, CA. FILED 9-21-2007.



NO CLAIM IS MADE TO THE EXCLUSIVE RIGHT TO USE "THE HIGHEST STANDARD IN FOOD SAFETY", APART FROM THE MARK AS SHOWN.

THE MARK CONSISTS OF AN OVAL WITH WATER BACKGROUND AND WORDS "IPURA THE HIGHEST STANDARD IN FOOD SAFETY".

CLASS 29—MEATS AND PROCESSED FOODS

FOR FISH; MEAT; PORK; POULTRY; TURKEY (U.S. CL. 46).

CLASS 31—NATURAL AGRICULTURAL PRODUCTS

FOR FRESH FRUITS; FRESH VEGETABLES (U.S. CLS. 1 AND 46).

CLASS 40—MATERIAL TREATMENT

FOR FOOD PROCESSING SERVICES; FOOD PROCESSING THROUGH PROPRIETARY TECHNOLOGIES AND PROCESSING SYSTEMS DESIGNED TO ENHANCE FOOD SAFETY; CONSULTING IN THE FIELD OF FOOD PROCESSING; FOOD PROCESSING SERVICES USING SAFE FOOD HANDLING TECHNIQUES IMPLEMENTED AT FOOD PROCESSING FACILITIES AND/OR FOOD DISTRIBUTION CHAINS FROM ORIGIN OF FOOD PRODUCT TO SALES POINT (U.S. CLS. 100, 103 AND 106).

PLAYBOOX

THE MARK CONSISTS OF STANDARD CHARACTERS WITHOUT CLAIM TO ANY PARTICULAR FONT, STYLE, SIZE, OR COLOR.

CLASS 9—ELECTRICAL AND SCIENTIFIC APPARATUS

FOR BUSINESS PROCESS MANAGEMENT SOFTWARE, NAMELY, COMPUTER SOFTWARE FOR COLLECTING, ORGANIZING, TRANSMITTING, RECEIVING, SHARING, ANALYZING AND STORING ELECTRONIC DATA, TEXT, GRAPHICS, AUDIO AND VIDEO VIA COMMUNICATIONS NETWORKS AND MOBILE DEVICES; BUSINESS PROCESS MANAGEMENT SOFTWARE, NAMELY, COMPUTER SOFTWARE FOR MONITORING AND MANAGING ELECTRONIC DATA, TEXT, GRAPHICS, AUDIO AND VIDEO VIA COMMUNICATIONS NETWORKS AND MOBILE DEVICES; BUSINESS PROCESS MANAGEMENT SOFTWARE, NAMELY, COMPUTER SOFTWARE FOR USE IN GENERATING REPORTS, FOR USE IN DATABASE MANAGEMENT, FOR USE AS A SPREADSHEET, AND FOR DATABASE PROCESSING; BUSINESS PROCESS MANAGEMENT SOFTWARE, NAMELY, COMPUTER SOFTWARE FOR USE IN IMPROVING EMPLOYEE EFFICIENCY AND EFFECTIVENESS; BUSINESS PROCESS MANAGEMENT SOFTWARE, NAMELY, COMPUTER SOFTWARE FOR THE DELIVERY OF CUSTOMIZABLE BUSINESS METHODOLOGY (U.S. CLS. 21, 23, 26, 36 AND 38).

CLASS 35—ADVERTISING AND BUSINESS

FOR PROVIDING LINKS TO THE WEBSITES OF OTHERS FEATURING BUSINESS INFORMATION (U.S. CLS. 100, 101 AND 102).

CLASS 38—COMMUNICATION

FOR PROVIDING AN ONLINE FORUM FOR SHARING INFORMATION ON TOPICS OF BUSINESS AND EMPLOYEE EFFICIENCY (U.S. CLS. 100, 101 AND 104).

CLASS 41—EDUCATION AND ENTERTAINMENT

FOR PROVIDING ONLINE ARTICLES IN THE FIELD OF BUSINESS AND EMPLOYEE EFFICIENCY (U.S. CLS. 100, 101 AND 107).

CLASS 42—SCIENTIFIC AND COMPUTER SERVICES

FOR APPLICATION SERVICE PROVIDER (ASP) FEATURING SOFTWARE FOR COLLECTING, ORGANIZING, TRANSMITTING, RECEIVING, SHARING, ANALYZING AND STORING ELECTRONIC DATA, TEXT, GRAPHICS, AUDIO AND VIDEO VIA COMMUNICATIONS NETWORKS AND MOBILE DEVICES; APPLICATION SERVICE PROVIDER (ASP) FEATURING SOFTWARE FOR MONITORING AND MANAGING ELECTRONIC DATA, TEXT, GRAPHICS, AUDIO AND VIDEO VIA COMMUNICATIONS NETWORKS AND MOBILE DEVICES; APPLICATION SERVICE PROVIDER (ASP) FEATURING SOFTWARE FOR USE IN GENERATING REPORTS, FOR USE IN DATABASE MANAGEMENT, FOR USE AS A SPREADSHEET, AND FOR DATABASE PROCESSING; APPLICATION SERVICE PROVIDER (ASP) FEATURING SOFTWARE FOR USE IN IMPROVING EMPLOYEE EFFICIENCY AND EFFECTIVENESS; APPLICATION SERVICE PROVIDER (ASP) FEATURING SOFTWARE FOR THE DELIVERY OF CUSTOMIZABLE BUSINESS METHODOLOGY; TECHNICAL SUPPORT SERVICES, NAMELY, TROUBLESHOOTING OF COMPUTER HARDWARE AND SOFTWARE PROBLEMS; INSTALLATION OF COMPUTER SOFTWARE; COMPUTER CONSULTATION; COMPUTER SOFTWARE CONSULTATION (U.S. CLS. 100 AND 101).
SUSAN RICHARDS, EXAMINING ATTORNEY

SN 77-286,280. PLAYBOOX, INC., SAN FRANCISCO, CA. FILED 9-21-2007.

PREPARE TO WIN!

THE MARK CONSISTS OF STANDARD CHARACTERS WITHOUT CLAIM TO ANY PARTICULAR FONT, STYLE, SIZE, OR COLOR.

CLASS 9—ELECTRICAL AND SCIENTIFIC APPARATUS

FOR BUSINESS PROCESS MANAGEMENT SOFTWARE, NAMELY, COMPUTER SOFTWARE FOR COLLECTING, ORGANIZING, TRANSMITTING, RECEIVING, SHARING, ANALYZING AND STORING ELECTRONIC DATA, TEXT, GRAPHICS, AUDIO AND VIDEO VIA COMMUNICATIONS NETWORKS AND MOBILE DEVICES; BUSINESS PROCESS MANAGEMENT SOFTWARE, NAMELY, COMPUTER SOFTWARE FOR MONITORING AND MANAGING ELECTRONIC DATA, TEXT, GRAPHICS, AUDIO AND VIDEO VIA COMMUNICATIONS NETWORKS AND MOBILE DEVICES; BUSINESS PROCESS MANAGEMENT SOFTWARE, NAMELY, COMPUTER SOFTWARE FOR USE IN GENERATING REPORTS, FOR USE IN DATABASE MANAGEMENT, FOR USE AS A SPREADSHEET, AND FOR DATABASE PROCESSING; BUSINESS PROCESS MANAGEMENT SOFTWARE, NAMELY, COMPUTER SOFTWARE FOR USE IN IMPROVING EMPLOYEE EFFICIENCY AND EFFECTIVENESS; BUSINESS PROCESS MANAGEMENT SOFTWARE, NAMELY, COMPUTER SOFTWARE FOR THE DELIVERY OF CUSTOMIZABLE BUSINESS METHODOLOGY (U.S. CLS. 21, 23, 26, 36 AND 38).

CLASS 35—ADVERTISING AND BUSINESS

FOR PROVIDING LINKS TO THE WEBSITES OF OTHERS FEATURING BUSINESS INFORMATION (U.S. CLS. 100, 101 AND 102).

CLASS 38—COMMUNICATION

FOR PROVIDING AN ONLINE FORUM FOR SHARING INFORMATION ON TOPICS OF BUSINESS AND EMPLOYEE EFFICIENCY (U.S. CLS. 100, 101 AND 104).

CLASS 41—EDUCATION AND ENTERTAINMENT

FOR PROVIDING ONLINE ARTICLES IN THE FIELD OF BUSINESS AND EMPLOYEE EFFICIENCY (U.S. CLS. 100, 101 AND 107).

CLASS 42—SCIENTIFIC AND COMPUTER SERVICES

FOR APPLICATION SERVICE PROVIDER (ASP) FEATURING SOFTWARE FOR COLLECTING, ORGANIZING, TRANSMITTING, RECEIVING, SHARING, ANALYZING AND STORING ELECTRONIC DATA, TEXT, GRAPHICS, AUDIO AND VIDEO VIA COMMUNICATIONS NETWORKS AND MOBILE DEVICES; APPLICATION SERVICE PROVIDER (ASP) FEATURING SOFTWARE FOR MONITORING AND MANAGING ELECTRONIC DATA, TEXT, GRAPHICS, AUDIO AND VIDEO VIA COMMUNICATIONS NETWORKS AND MOBILE DEVICES; APPLICATION SERVICE PROVIDER (ASP) FEATURING SOFTWARE FOR USE IN GENERATING REPORTS, FOR USE IN DATABASE MANAGEMENT, FOR USE AS A SPREADSHEET, AND FOR DATABASE PROCESSING; APPLICATION SERVICE PROVIDER (ASP) FEATURING SOFTWARE FOR USE IN IMPROVING EMPLOYEE EFFICIENCY AND EFFECTIVENESS; APPLICATION SERVICE PROVIDER (ASP) FEATURING SOFTWARE FOR THE DELIVERY OF CUSTOMIZABLE BUSINESS METHODOLOGY; TECHNICAL SUPPORT SERVICES, NAMELY, TROUBLESHOOTING OF COMPUTER HARDWARE AND SOFTWARE PROBLEMS; INSTALLATION OF COMPUTER SOFTWARE; COMPUTER CONSULTATION; COMPUTER SOFTWARE CONSULTATION (U.S. CLS. 100 AND 101).
SUSAN RICHARDS, EXAMINING ATTORNEY

SN 77-290,236. WORLDWIDE DISCIPLESHIP ASSOCIATION, FAYETTEVILLE, GA. FILED 9-27-2007.

**CLASS 16—PAPER GOODS AND PRINTED MATTER**

FOR PRINTED INSTRUCTIONAL, EDUCATIONAL AND TEACHING MATERIALS ON THE SUBJECT OF CHRISTIAN DISCIPLE IDEALS (U.S. CLS. 2, 5, 22, 23, 29, 37, 38 AND 50).

FIRST USE 0-0-2004; IN COMMERCE 0-0-2004.

CLASS 41—EDUCATION AND ENTERTAINMENT

FOR EDUCATIONAL SERVICES, NAMELY, PROVIDING MENTORING, SEMINARS AND CONFERENCES IN THE FIELD OF CHRISTIAN DISCIPLE IDEALS AND DISTRIBUTING COURSE MATERIALS IN CONNECTION THEREWITH (U.S. CLS. 100, 101 AND 107).

FIRST USE 0-0-2004; IN COMMERCE 0-0-2004.

CLASS 45—PERSONAL AND LEGAL SERVICES

FOR MINISTERIAL SERVICES, NAMELY, HOLDING SPIRITUAL RETREATS TO ASSIST RELIGIOUS LEADERS, BOTH CLERGY AND LAY, TO DEVELOP AND ENHANCE THEIR SPIRITUAL LIVES (U.S. CLS. 100 AND 101).

FIRST USE 0-0-2004; IN COMMERCE 0-0-2004.
LESLEY LAMOTHE, EXAMINING ATTORNEY

SN 77-291,777. PROVIDENT SECURITY CORP., VANCOUVER, BRITISH COLUMBIA, CANADA, FILED 9-28-2007.



PRIORITY CLAIMED UNDER SEC. 44(D) ON CANADA APPLICATION NO. 1343882, FILED 4-18-2007, REG. NO. TMA709566, DATED 3-14-2008, EXPIRES 4-18-2023.

NO CLAIM IS MADE TO THE EXCLUSIVE RIGHT TO USE "SECURITY", APART FROM THE MARK AS SHOWN.

CLASS 37—CONSTRUCTION AND REPAIR

FOR CUSTOMIZED HOME WATCH PROGRAMS, NAMELY, REMOVING SNOW; RESIDENTIAL, COMMERCIAL AND INDUSTRIAL ALARM SERVICES, NAMELY, INSTALLING AND SERVICING SECURITY ALARM SYSTEMS, MEDICAL EMERGENCY PANIC ALARM SYSTEMS, WATER AND LEAK DETECTION ALARM SYSTEMS, CARBON MONOXIDE ALARM SYSTEMS, TEMPERATURE CONTROL ALARM SYSTEMS, VIDEO AND AUDIO VERIFICATION ALARM SYSTEMS, REMOTE VIDEO MONITORS, CLOSED CIRCUIT TELEVISION AND ACCESS CONTROL SYSTEMS (U.S. CLS. 100, 103 AND 106).

CLASS 41—EDUCATION AND ENTERTAINMENT

FOR EDUCATIONAL SERVICES, NAMELY, PROVIDING SEMINARS, ONLINE CLASSES AND IN-PERSON INSTRUCTION IN THE FIELD OF SECURITY (U.S. CLS. 100, 101 AND 107).

CLASS 42—SCIENTIFIC AND COMPUTER SERVICES

FOR RESIDENTIAL, COMMERCIAL AND INDUSTRIAL ALARM SERVICES, NAMELY, DESIGNING SECURITY ALARM SYSTEMS, MEDICAL EMERGENCY PANIC ALARM SYSTEMS, WATER AND LEAK DETECTION ALARM SYSTEMS, CARBON MONOXIDE ALARM SYSTEMS, TEMPERATURE CONTROL ALARM SYSTEMS, VIDEO AND AUDIO VERIFICATION ALARM SYSTEMS, REMOTE VIDEO MONITORS, CLOSED CIRCUIT TELEVISION AND ACCESS CONTROL SYSTEMS (U.S. CLS. 100 AND 101).

CLASS 45—PERSONAL AND LEGAL SERVICES

FOR RESIDENTIAL, COMMERCIAL, INDUSTRIAL AND SPECIAL EVENT SECURITY GUARD SERVICES, NAMELY, PROVIDING UNIFORMED SECURITY OFFICERS, UNIFORMED COMMUNITY PATROL OFFICERS, AND MOBILE PATROL OFFICER TEAMS; PERSONAL PROTECTION SECURITY SERVICES, NAMELY, PROVIDING UNIFORMED SECURITY OFFICERS AND PERSONAL BODYGUARDS; CUSTOMIZED HOME WATCH SECURITY PROGRAMS, NAMELY, HOME PATROLLING, PICKING UP NEWSPAPERS AND ALTERING LIGHTING; PRIVATE HOUSE PARTY CONCIERGE SERVICES, NAMELY, WELCOMING GUESTS AND MANAGING GUEST LISTS, COLLECTING VEHICLE KEYS AND PROCURING ALTERNATE TRANSPORTATION FOR GUESTS; PRIVATE HOUSE PARTY SECURITY SERVICES, NAMELY, PATROLLING THE PERIMETER OF A PROPERTY DURING AN EVENT; RESIDENTIAL, COMMERCIAL AND INDUSTRIAL SECURITY ALARM SERVICES, NAMELY, RESPONDING TO ALARMS, INSPECTING PREMISES AND RE-SECURING PROPERTIES AFTER AN INCIDENT; OPERATION OF A WEBSITE PROVIDING INFORMATION IN THE FIELD OF SECURITY; RESIDENTIAL, COMMERCIAL AND INDUSTRIAL ALARM SERVICES, NAMELY, MONITORING SECURITY ALARM SYSTEMS, MEDICAL EMERGENCY PANIC ALARM SYSTEMS, WATER AND LEAK DETECTION ALARM SYSTEMS, CARBON MONOXIDE ALARM SYSTEMS, TEMPERATURE CONTROL ALARM SYSTEMS, VIDEO AND AUDIO VERIFICATION ALARM SYSTEMS, REMOTE VIDEO MONITORS, CLOSED CIRCUIT TELEVISION AND ACCESS CONTROL SYSTEMS (U.S. CLS. 100 AND 101).

KATHERINE CHANG, EXAMINING ATTORNEY

SN 77-294,837. UNIVERSITY OF SHEFFIELD, SHEFFIELD, UNITED KINGDOM, FILED 10-3-2007.



PRIORITY CLAIMED UNDER SEC. 44(D) ON UNITED KINGDOM APPLICATION NO. 2451575, FILED 4-3-2007, REG. NO. 2451575, DATED 5-2-2008, EXPIRES 4-3-2017.

THE COLOR(S) BLUE AND BLACK IS/ARE CLAIMED AS A FEATURE OF THE MARK.

THE COLOR BLACK APPEARS IN THE STYLIZED TEXT "EPTEC". THE COLOR BLUE APPEARS IN A FLAME DESIGN OVER THE FIRST LETTER E IN "EPTEC". WHITE APPEARS IN THE DRAWING TO INDICATE A TRANSPARENT BACKGROUND.

CLASS 35—ADVERTISING AND BUSINESS

FOR COST AND PRICE ANALYSIS AND BUSINESS RESEARCH SERVICES FOR INDUSTRY IN FIELDS OF COMBUSTION TECHNOLOGY AND ENERGY RESEARCH (U.S. CLS. 100, 101 AND 102).

CLASS 36—INSURANCE AND FINANCIAL

FOR FINANCIAL ANALYSIS AND RESEARCH SERVICES FOR INDUSTRY IN THE FIELDS OF COMBUSTION TECHNOLOGY AND ENERGY RESEARCH (U.S. CLS. 100, 101 AND 102).

CLASS 42—SCIENTIFIC AND COMPUTER SERVICES

FOR SCIENTIFIC AND TECHNOLOGICAL SERVICES, NAMELY, SCIENTIFIC INVESTIGATION INTO ALTERNATIVE FUELS, AND RESEARCH AND DESIGN OF FUELS, ALTERNATIVE FUELS, AVIATION FUELS, LUBRICANTS, COMBUSTION ENGINES, RELATING THERETO, ALL IN THE FIELDS OF COMBUSTION TECHNOLOGY AND ENERGY RESEARCH; INDUSTRIAL CHEMICAL ANALYSIS AND RESEARCH SERVICES IN THE FIELDS OF COMBUSTION TECHNOLOGY AND ENERGY RESEARCH; DESIGN AND DEVELOPMENT OF COMPUTER HARDWARE AND SOFTWARE IN THE FIELDS OF COMBUSTION TECHNOLOGY AND ENERGY RESEARCH; COMPUTER SOFTWARE DESIGN, NAMELY, COMPUTER MODELING IN THE FIELDS OF COMBUSTION TECHNOLOGY AND ENERGY RESEARCH; COMPUTER MODELLING, NAMELY, ATMOSPHERIC SPRAY CHARACTERISATION, LUBRICANT THERMAL STABILITY MODELLING, CHEMICAL MODELLING OF COMBUSTION; TESTING SERVICES, NAMELY, THE TESTING OF MATERIALS, THE TESTING OF FUELS AND ALTERNATIVE FUELS, IGNITION AND FLAMMABILITY LIMIT TESTING, COMBUSTOR EMISSIONS MATERIALS COMPATIBILITY TESTING, IN THE FIELDS OF COMBUSTION TECHNOLOGY AND ENERGY RESEARCH; CONSULTANCY AND ADVISORY SERVICES IN THE FIELDS OF COMBUSTION TECHNOLOGY AND ENERGY RESEARCH (U.S. CLS. 100 AND 101).

REBECCA EISINGER, EXAMINING ATTORNEY

SN 77-295,321. SAVILLS PLC, LONDON, UNITED KINGDOM, FILED 10-3-2007.



OWNER OF U.S. REG. NOS. 2,790,021 AND 3,218,213. THE MARK CONSISTS OF THE WORDS "SAVILLS" AND "GRANITE" ON CONTRASTING BACKGROUNDS.

CLASS 35—ADVERTISING AND BUSINESS

FOR COMPUTERIZED DATABASE MANAGEMENT; ADVERTISING AND MEDIA CAMPAIGN PLANNING SERVICES, NAMELY, ADVERTISING CONSULTATION; ADVISORY SERVICES RELATING TO TAXATION ON REAL ESTATE, NAMELY, TAX CONSULTATION; BUSINESS AUDITING SERVICES RELATING TO PROPERTY; PLANNING OF MARKETING STRATEGIES, NAMELY, MARKETING CONSULTING; MARKETING PLAN DEVELOPMENT; PROPERTY MARKETING SERVICES, NAMELY, BUSINESS AND PRIVATE MARKETING SERVICES; AUCTIONEERING SERVICES; BUSINESS NEGOTIATION SERVICES, NAMELY, NEGOTIATION AND SETTLEMENT OF COMMERCIAL TRANSACTIONS FOR THIRD PARTIES, RENT AND LEASE NEGOTIATIONS, NAMELY, NEGOTIATION AND RENEGOTIATION OF LEASES AND SUBLEASES (U.S. CLS. 100, 101 AND 102).

CLASS 36—INSURANCE AND FINANCIAL

FOR REAL ESTATE AGENCY SERVICES; FINANCING SERVICES; REAL ESTATE SELECTION AND ACQUISITION; MORTGAGE BROKERAGE; STRUCTURED FINANCE INSURANCE, NAMELY, INSURANCE BROKERAGE; REAL ESTATE INVESTMENT SERVICES; REAL ESTATE LEASING AND ACQUISITION SERVICES; REAL ESTATE VALUATIONS; VALUATIONS RELATING TO THE SURVEYING OF BUILDINGS, NAMELY, LAND VALUATION; REAL ESTATE MANAGEMENT; FINANCIAL CONSULTATION; FINANCIAL PLANNING SERVICES; CAPITAL AND FINANCIAL INVESTMENT FUND MANAGEMENT SERVICES; DEBT BROKING AND LOAN BROKING, NAMELY, BROKERAGE IN THE FIELD OF BONDS AND OPTIONS; FIRE INSURANCE UNDERWRITING; PROPERTY AND CONTENTS INSURANCE SERVICES, NAMELY, INSURANCE UNDERWRITING IN THE FIELD OF ACCIDENT AND FIRE; REAL ESTATE MANAGEMENT; PROPERTY UNITISATION AND SECURITIZATION, NAMELY, LEASE SECURITIZATION; PERSONAL AUDITING SERVICES RELATING TO PROPERTY, NAMELY, REAL ESTATE APPRAISAL AND VALUATION (U.S. CLS. 100, 101 AND 102).

CLASS 37—CONSTRUCTION AND REPAIR

FOR REAL ESTATE DEVELOPMENT; SUPERVISION OF CONSTRUCTION; PIPELINE CONSTRUCTION AND MAINTENANCE; ADVISORY SERVICES RELATING TO RENOVATION AND PROPERTY DEVELOPMENT, NAMELY, CONSTRUCTION CONSULTATION; CONSTRUCTION, MAINTENANCE AND REPAIR OF COMMERCIAL AND RESIDENTIAL BUILDINGS IN ESTATES; WAYLEAVING, NAMELY, CONSTRUCTION OF UNDERGROUND UTILITIES (U.S. CLS. 100, 103 AND 106).

CLASS 42—SCIENTIFIC AND COMPUTER SERVICES

FOR SURVEYING SERVICES; ADVISORY SERVICES RELATING TO RENOVATION AND PROPERTY DEVELOPMENT, NAMELY, CONSULTING IN THE FIELDS OF ENGINEERING AND ARCHITECTURE (U.S. CLS. 100 AND 101).

ROBERT STRUCK, EXAMINING ATTORNEY

SN 77-296,593. PARTIZAN FILMS, LLC, HOLLYWOOD, CA, FILED 10-4-2007.

SWEDED

THE MARK CONSISTS OF STANDARD CHARACTERS WITHOUT CLAIM TO ANY PARTICULAR FONT, STYLE, SIZE, OR COLOR.

CLASS 9—ELECTRICAL AND SCIENTIFIC APPARATUS

FOR AUDIOVISUAL RECORDINGS, DVDS AND DOWNLOADABLE AUDIOVISUAL RECORDINGS ALL FEATURING CLIPS FROM MOVIES; SOUND RECORDINGS AND DOWNLOADABLE SOUND RECORDINGS FEATURING MUSIC FROM MOTION PICTURES; DOWNLOADABLE APPLICATIONS, NAMELY, RING TONES, GRAPHICS AND WALLPAPERS FOR USE IN MOBILE TELEPHONY DEVICES; MOTION PICTURE FILMS FEATURING COMEDY; RULERS, NAMELY, GRADUATED RULERS AND TAPE RULERS (U.S. CLS. 21, 23, 26, 36 AND 38).

CLASS 16—PAPER GOODS AND PRINTED MATTER

FOR PRINTED MATERIALS, NAMELY, CALENDARS, INSTRUCTIONAL MATERIALS IN THE FIELD OF HOW TO MAKE, PARODY OR MODIFY A MOVIE, STATIONERY, PHOTOGRAPHS, BOOKS IN THE FIELD OF MOTION PICTURE HISTORY, MOTION PICTURE TRIVIA, MAGAZINES FEATURING MOTION PICTURE TRIVIA, MOTION PICTURE HISTORY; POSTERS; PARTY SUPPLIES, NAMELY, PAPER PARTY DECORATIONS; DESK SUPPLIES, NAMELY, DESK CALENDARS, CALENDAR DESK PADS, CALENDAR DESK STANDS, DESK STANDS AND HOLDERS FOR PENS AND PENCILS, SCHOOL SUPPLIES, NAMELY, PENS, PENCILS, FOLDERS, NOTEBOOKS, BOOKMARKS; STICKERS, GREETING CARDS, CALENDARS (U.S. CLS. 2, 5, 22, 23, 29, 37, 38 AND 50).

CLASS 25—CLOTHING

FOR CLOTHING, NAMELY, T-SHIRTS, SWEAT-SHIRTS, TANK TOPS; HEADWEAR; FOOTWEAR; CLOTHING ACCESSORIES, NAMELY, BELTS, HEAD SCARVES (U.S. CLS. 22 AND 39).

CLASS 38—COMMUNICATION

FOR INTERNET SERVICES, NAMELY, STREAMING OF AUDIO AND VIDEO MATERIAL OVER THE INTERNET (U.S. CLS. 100, 101 AND 104).

CLASS 41—EDUCATION AND ENTERTAINMENT

FOR ENTERTAINMENT SERVICES, NAMELY, MOTION PICTURE FILM PRODUCTION; INTERNET BASED ENTERTAINMENT SERVICES, NAMELY, PROVIDING A WEBSITE FEATURING VIDEOS, RELATED FILM CLIPS, PHOTOGRAPHS AND OTHER MULTIMEDIA MATERIALS FEATURING PARODIES AND HOME MADE RECREATIONS OF MOVIES TELEVISION AND OTHER ENTERTAINMENT FORMATS; WEBSITE SERVICES, NAMELY, PROVIDING A WEBSITE FEATURING INFORMATION ON FILM CLIPS (U.S. CLS. 100, 101 AND 107).

RICHARD WHITE, EXAMINING ATTORNEY

CLASS 9—ELECTRICAL AND SCIENTIFIC APPARATUS

FOR MUSICAL SOUND RECORDINGS; AUDIO-VISUAL RECORDINGS, NAMELY, COMPACT DISCS, TAPE CASSETTES, AUDIO CASSETTES, AUDIO TAPES, AUDIO DISCS, RECORDS, CD-ROMS, VIDEO TAPES, VIDEO CASSETTES, VIDEO DISCS, DVDS, DATS, MP3S, AND LASER DISCS, ALL FEATURING MUSIC; DOWNLOADABLE MUSICAL SOUND RECORDINGS; DOWNLOADABLE VIDEO RECORDINGS FEATURING MUSIC; DOWNLOADABLE ELECTRONIC PUBLICATIONS IN THE NATURE OF BOOKS, BOOKLETS, MAGAZINES, JOURNALS, MANUALS, BROCHURES, LEAFLETS, PAMPHLETS AND NEWSLETTERS, ALL IN THE FIELD OF MUSIC, ENTERTAINMENT, BEAUTY, FASHION, LIFESTYLES, HOME DÉCOR, THE ARTS, CULTURE, POLITICS AND EDUCATION; ELECTRONIC PUBLICATIONS, NAMELY, BOOKS, BOOKLETS, MAGAZINES, JOURNALS, MANUALS, BROCHURES, LEAFLETS, PAMPHLETS AND NEWSLETTERS, ALL IN THE FIELD OF MUSIC, ENTERTAINMENT, BEAUTY, FASHION, LIFESTYLES, HOME DÉCOR, THE ARTS, CULTURE, POLITICS AND EDUCATION, ALL RECORDED ON CD-ROMS, DISKETTES, FLOPPY DISCS, VIDEO CASSETTES, AND MAGNETIC TAPES; MAGNETS; VIDEO GAME SOFTWARE, AND VIDEO GAME HARDWARE, NAMELY, VIDEO GAME MACHINES FOR USE WITH AN EXTERNAL MONITOR AND GAME CONTROLLERS FOR VIDEO GAMES (U.S. CLS. 21, 23, 26, 36 AND 38).

CLASS 25—CLOTHING

FOR CLOTHING, NAMELY, CAPS, HATS, JACKETS, T-SHIRTS, TANK TOPS, SHIRTS, SWEAT SHIRTS, SOCKS, TIES, SCARVES, SHORTS, SKIRTS, TROUSERS, UNDERWEAR, PULLOVERS, CARDIGANS, TRACK PANTS, BLOUSES, DRESSES; FOOTWEAR, NAMELY, BOOTS; SHOES, SANDALS, SLIPPERS (U.S. CLS. 22 AND 39).

CLASS 26—FANCY GOODS

FOR ORNAMENTAL NOVELTY CLOTH PATCHES, ORNAMENTAL NOVELTY BUTTONS, ORNAMENTAL NOVELTY BADGES, BROOCHES, ARMBANDS, BELT BUCKLES, AND ORNAMENTAL NOVELTY PINS (U.S. CLS. 37, 39, 40, 42 AND 50).

CLASS 28—TOYS AND SPORTING GOODS

FOR STAND ALONE VIDEO GAME MACHINES (U.S. CLS. 22, 23, 38 AND 50).

CLASS 41—EDUCATION AND ENTERTAINMENT

FOR ENTERTAINMENT SERVICES, NAMELY, RECORD PRODUCTION; MUSIC PRODUCTION; AUDIO RECORDING AND PRODUCTION; VIDEOTAPE PRODUCTION; MOTION PICTURE SONG PRODUCTION; PRODUCTION OF VIDEO DISCS FOR OTHERS; RECORDING STUDIOS; PRODUCING MUSICAL AUDIO AND VIDEO PROGRAMS; DISTRIBUTION OF TELEVISION AND RADIO PROGRAMS FOR OTHERS FEATURING MUSICAL PERFORMANCES; DISTRIBUTION OF MUSICAL AUDIO AND VIDEO RECORDINGS FOR BROADCAST; MUSIC COMPOSITION AND TRANSCRIPTION FOR OTHERS; SONG WRITING SERVICES; MUSIC PUBLISHING SERVICES; ENTERTAINMENT IN THE NATURE OF A LIVE MUSICAL PERFORMER, MUSICAL BAND AND MUSICAL GROUP; ENTERTAINMENT IN THE NATURE OF LIVE PERFORMANCES BY A MUSICAL ARTIST, MUSICAL GROUP AND MUSICAL BAND; ENTERTAINMENT IN THE NATURE OF VISUAL AND AUDIO PERFORMANCES BY A MUSICAL ARTIST, MUSICAL GROUP AND MUSICAL BAND; ENTERTAINMENT, NAMELY, LIVE MUSIC CONCERTS; ENTERTAINMENT, NAMELY, PERSONAL APPEARANCES BY A MUSICIAN, MUSICAL GROUP AND MUSICAL BAND; ENTERTAINMENT, NAMELY, PERSONAL APPEARANCES BY A TELEVISION STAR, MOVIE STAR, COMEDIAN AND RADIO PERSONALITY; ENTERTAINMENT SERVICES, NAMELY, PROVIDING A WEB SITE FEATURING MUSICAL

SN 77-297,222. MUSIDOR B.V., 1017 CH AMSTERDAM, NETHERLANDS, FILED 10-5-2007.



OWNER OF U.S. REG. NOS. 1,071,347, 1,632,418 AND 2,825,378.

THE MARK CONSISTS OF AN OUTLINE OF A STYLIZED PAIR OF LIPS AND PROTRUDING TONGUE.

PERFORMANCES, MUSICAL VIDEOS, RELATED FILM CLIPS, PHOTOGRAPHS, AND OTHER MULTIMEDIA MATERIALS; ENTERTAINMENT SERVICES, NAMELY, PROVIDING PRERECORDED MUSIC, INFORMATION IN THE FIELD OF MUSIC, COMMENTARY AND ARTICLES ABOUT MUSIC, ALL ONLINE VIA A GLOBAL COMPUTER NETWORK; TELEVISION AND RADIO PRODUCTION; TELEVISION SHOW PRODUCTION; CABLE TELEVISION SHOW PRODUCTION; RADIO ENTERTAINMENT PRODUCTION; MOTION PICTURE FILM PRODUCTION; FILM EDITING; PRODUCTION OF TELEVISION AND CABLE TELEVISION PROGRAMS; ENTERTAINMENT IN THE NATURE OF A VARIETY SHOW AND THEATRE PRODUCTIONS; ENTERTAINMENT IN THE NATURE OF TRAVELING TOURS FEATURING MUSIC; PROGRAMMING ON A GLOBAL COMPUTER NETWORK; DISTRIBUTION OF TELEVISION PROGRAMMING TO CABLE TELEVISION SYSTEMS; CABLE TELEVISION PROGRAMMING; TELEVISION AND RADIO PROGRAMMING; TELEVISION SCHEDULING; ENTERTAINMENT SERVICES, NAMELY, PROVIDING AN ON-LINE COMPUTER GAME; PROVIDING A COMPUTER GAME THAT MAY BE ACCESSED NETWORK-WIDE BY NETWORK USERS; MULTIMEDIA ENTERTAINMENT SOFTWARE PRODUCTION SERVICES; PROVIDING INFORMATION ONLINE RELATING TO COMPUTER GAMES AND COMPUTER ENHANCEMENTS FOR GAMES; ENTERTAINMENT SERVICES, NAMELY, PROVIDING PRERECORDED MUSIC VIA A GLOBAL COMPUTER NETWORK (U.S. CLS. 100, 101 AND 107).

MARGARET POWER, EXAMINING ATTORNEY

SN 77-297,531. REDGEAR TECHNOLOGIES, INC., KANSAS CITY, MO. FILED 10-5-2007.

TAXWORKS INSTITUTE

THE MARK CONSISTS OF STANDARD CHARACTERS WITHOUT CLAIM TO ANY PARTICULAR FONT, STYLE, SIZE, OR COLOR.

OWNER OF U.S. REG. NO. 2,700,202.

NO CLAIM IS MADE TO THE EXCLUSIVE RIGHT TO USE "INSTITUTE", APART FROM THE MARK AS SHOWN.

CLASS 35—ADVERTISING AND BUSINESS

FOR PROVIDING AN ONLINE SEARCHABLE DATABASE FEATURING INFORMATION IN THE FIELDS OF TAX PREPARATION AND PLANNING, ACCOUNTING AND BUSINESS; BUSINESS RESEARCH FOR OTHERS IN THE FIELDS OF TAX, TAX PLANNING, TAX PREPARATION AND ACCOUNTING; PROVIDING AN ONLINE SEARCHABLE DATABASE FEATURING INFORMATION IN THE FIELD OF TAX RESEARCH (U.S. CLS. 100, 101 AND 102).

CLASS 41—EDUCATION AND ENTERTAINMENT

FOR EDUCATIONAL SERVICES, NAMELY, PROVIDING AN ONLINE REFERENCE LIBRARY FEATURING INFORMATION AND MATERIALS IN THE FIELDS OF TAX, TAX LAW, ACCOUNTING, AND BUSINESS; PROVIDING ONLINE COURSES AND CONTINUING BUSINESS EDUCATION COURSES IN THE FIELDS OF TAX, TAX LAW, ACCOUNTING AND BUSINESS; PROVIDING ONLINE PUBLICATIONS IN THE NATURE OF ARTICLES IN THE FIELDS OF TAX, TAX LAW, ACCOUNTING AND BUSINESS (U.S. CLS. 100, 101 AND 107).

CLASS 42—SCIENTIFIC AND COMPUTER SERVICES

FOR APPLICATION SERVICES PROVIDER (ASP) FEATURING SOFTWARE FOR DATABASES FOR USE IN THE FIELDS OF TAX, TAX LAW, TAX RESEARCH, TAX PREPARATION, TAX PLANNING, ACCOUNTING AND BUSINESS; DEVELOPING, UPDATING AND MAINTAINING SOFTWARE AND DATABASES IN THE FIELDS OF TAX, TAX LAW, TAX RESEARCH, TAX PREPARATION, TAX PLANNING AND ACCOUNTING (U.S. CLS. 100 AND 101).

CLASS 45—PERSONAL AND LEGAL SERVICES

FOR PROVIDING AN ONLINE SEARCHABLE DATABASE FEATURING INFORMATION IN THE FIELD OF TAX LAW (U.S. CLS. 100 AND 101).

LINDA M. KING, EXAMINING ATTORNEY

SN 77-298,626. CUPA MATERIALES, S.A., MADRID, SPAIN, FILED 10-8-2007.



The logo for Stonepanel cupa features the word "stonepanel" in a bold, lowercase, orange sans-serif font. Below it, the word "cupa" is written in a smaller, lowercase, gray sans-serif font. The two words are centered and stacked vertically.

NO CLAIM IS MADE TO THE EXCLUSIVE RIGHT TO USE "STONEPANEL", APART FROM THE MARK AS SHOWN.

THE COLOR(S) ORANGE AND GRAY IS/ARE CLAIMED AS A FEATURE OF THE MARK.

THE MARK CONSISTS OF THE WORD "STONEPANEL" IN ORANGE AND "CUPA" IN GRAY.

CLASS 19—NON-METALLIC BUILDING MATERIALS

FOR NON-METALLIC BUILDING MATERIALS, NAMELY, PLASTIC PIPE SUPPORTS; RIGID PIPES, NOT OF METAL; ASPHALT, PITCH AND BITUMEN-BASED ROOFING SEALANTS, PORTABLE NON-METAL BUILDINGS; MONUMENTS OF STONE, MONUMENTS OF MARBLE (U.S. CLS. 1, 12, 33 AND 50).

CLASS 37—CONSTRUCTION AND REPAIR

FOR BUILDING CONSTRUCTION SERVICES, CONSTRUCTION AND REPAIR OF BUILDINGS, INSTALLATION SERVICES OF BUILDING SCAFFOLDS AND WORKING AND BUILDING PLATFORMS (U.S. CLS. 100, 103 AND 106).

CLASS 42—SCIENTIFIC AND COMPUTER SERVICES

FOR DESIGN FOR OTHERS IN THE FIELD OF LABELING, GRAPHIC DESIGN SERVICES, INTERIOR DECORATION CONSULTATION IN THE FIELD OF RESIDENTIAL AND COMMERCIAL BUILDINGS, INDUSTRIAL DESIGN, COMMERCIAL ART DESIGN, NAMELY DESIGNS OF CRYSTAL IN FACADES (U.S. CLS. 100 AND 101).

ROBERT C. CLARK JR., EXAMINING ATTORNEY

SN 77-300,028. RAPID REFILL CORP., CHANHASSEN, MN.
FILED 10-9-2007.



OWNER OF U.S. REG. NO. 2,918,486.
NO CLAIM IS MADE TO THE EXCLUSIVE RIGHT TO USE "REFILL INK" IN CLASSES 35 AND 40 AND "RAPID REFILL INK" IN CLASS 37, APART FROM THE MARK AS SHOWN.
THE MARK CONSISTS OF A STYLIZED GLOBE WITH THE WORDS "RAPID REFILL INK".

CLASS 35—ADVERTISING AND BUSINESS

FOR RETAIL STORE SERVICES FEATURING NEW AND RECYCLED OR REMANUFACTURED PRINTER CARTRIDGES AND TONER CARTRIDGES, PAPER, BLANK DIGITAL STORAGE MEDIA, AND SUPPLIES FOR PRINTERS, FAX MACHINES AND COPIERS (U.S. CLS. 100, 101 AND 102).
FIRST USE 9-24-2007; IN COMMERCE 9-24-2007.

CLASS 37—CONSTRUCTION AND REPAIR

FOR RECONDITIONING AND REFILLING OF PRINTER CARTRIDGES AND TONER CARTRIDGES (U.S. CLS. 100, 103 AND 106).
FIRST USE 9-24-2007; IN COMMERCE 9-24-2007.

CLASS 40—MATERIAL TREATMENT

FOR RECYCLING OF PRINTER CARTRIDGES AND TONER CARTRIDGES (U.S. CLS. 100, 103 AND 106).
FIRST USE 9-24-2007; IN COMMERCE 9-24-2007.
KELLY CHOE, EXAMINING ATTORNEY

SN 77-300,170. RAPID REFILL CORP., CHANHASSEN, MN.
FILED 10-10-2007.



OWNER OF U.S. REG. NO. 2,918,486.
NO CLAIM IS MADE TO THE EXCLUSIVE RIGHT TO USE "REFILL" IN CLASSES 2, 35 AND 40 AND "RAPID REFILL" IN CLASS 37, APART FROM THE MARK AS SHOWN.
THE MARK CONSISTS OF A STYLIZED GLOBE WITH THE WORDS "RAPID REFILL".

CLASS 2—PAINTS

FOR PRINTER INK CARTRIDGES AND TONER CARTRIDGES (U.S. CLS. 6, 11 AND 16).
FIRST USE 9-24-2007; IN COMMERCE 9-24-2007.

CLASS 35—ADVERTISING AND BUSINESS

FOR RETAIL STORE SERVICES FEATURING NEW AND RECYCLED OR REMANUFACTURED PRINTER CARTRIDGES AND TONER CARTRIDGES, PAPER, BLANK DIGITAL STORAGE MEDIA, AND SUPPLIES FOR PRINTERS, FAX MACHINES AND COPIERS (U.S. CLS. 100, 101 AND 102).
FIRST USE 9-24-2007; IN COMMERCE 9-24-2007.

CLASS 37—CONSTRUCTION AND REPAIR

FOR RECONDITIONING AND REFILLING OF PRINTER CARTRIDGES AND TONER CARTRIDGES (U.S. CLS. 100, 103 AND 106).
FIRST USE 9-24-2007; IN COMMERCE 9-24-2007.

CLASS 40—MATERIAL TREATMENT

FOR RECYCLING OF PRINTER CARTRIDGES AND TONER CARTRIDGES (U.S. CLS. 100, 103 AND 106).
FIRST USE 9-24-2007; IN COMMERCE 9-24-2007.
KELLY CHOE, EXAMINING ATTORNEY

SN 77-301,353. CHURCH & DWIGHT CO., INC., PRINCETON, NJ. FILED 10-11-2007.

VET'S CHOICE

THE MARK CONSISTS OF STANDARD CHARACTERS WITHOUT CLAIM TO ANY PARTICULAR FONT, STYLE, SIZE, OR COLOR.

CLASS 5—PHARMACEUTICALS

FOR REPELLANTS FOR HOUSEBREAKING DOMESTIC PETS (U.S. CLS. 6, 18, 44, 46, 51 AND 52).

CLASS 16—PAPER GOODS AND PRINTED MATTER

FOR DISPOSABLE TRAINING PADS FOR HOUSEBREAKING DOMESTIC PETS (U.S. CLS. 2, 5, 22, 23, 29, 37, 38 AND 50).
SHANNON TWOHIG, EXAMINING ATTORNEY

SN 77-305,718. RUSSELL DAVID ROSE, STATE COLLEGE, PA. FILED 10-17-2007.

HAPPY VOLLEY

THE MARK CONSISTS OF STANDARD CHARACTERS WITHOUT CLAIM TO ANY PARTICULAR FONT, STYLE, SIZE, OR COLOR.

CLASS 25—CLOTHING

FOR CLOTHING, NAMELY, SHIRTS, SHORTS, PANTS (U.S. CLS. 22 AND 39).

CLASS 41—EDUCATION AND ENTERTAINMENT

FOR ORGANIZING AND PROVIDING FACILITIES FOR VOLLEYBALL TOURNAMENTS (U.S. CLS. 100, 101 AND 107).
RICHARD WHITE, EXAMINING ATTORNEY

SN 77-306,027. DIREVO BIOTECH AG, KÖLN, FED REP GERMANY, FILED 10-17-2007.

SN 77-307,324. UNITED BUSINESS MEDIA LLC, MANHASSET, NY. FILED 10-18-2007.

therapase

THE MARK CONSISTS OF STANDARD CHARACTERS WITHOUT CLAIM TO ANY PARTICULAR FONT, STYLE, SIZE, OR COLOR.

PRIORITY CLAIMED UNDER SEC. 44(D) ON ERPN CMNTY TM OFC APPLICATION NO. 006311674, FILED 9-26-2007, REG. NO. 006311674, DATED 7-18-2008, EXPIRES 9-26-2017.

CLASS 1—CHEMICALS

FOR BIOCHEMICAL SUBSTANCES FOR SCIENTIFIC AND RESEARCH USE, NAMELY, PROTEINS AND NUCLEIC ACIDS WITH ENZYME AND RIBOZYME PROPERTIES; ASSAYS FOR MOLECULAR-BIOLOGICAL RESEARCH, NAMELY, KITS COMPOSED OF CHEMICAL REAGENTS FOR NON-MEDICAL PURPOSES (U.S. CLS. 1, 5, 6, 10, 26 AND 46).

CLASS 5—PHARMACEUTICALS

FOR PHARMACEUTICAL PRODUCTS BASED ON ACTIVE PROTEINS AND NUCLEIC ACIDS FOR USE IN TREATING AUTOIMMUNE AND INFLAMMATION DISEASES, DISEASES OF THE BLOOD AND LYMPHATIC SYSTEM, CANCER, CARDIOVASCULAR AND CIRCULATORY DISEASES, DISEASES OF THE CENTRAL NERVOUS SYSTEM, DENTAL DISEASES, DERMATOLOGY DISORDERS, DISEASES OF THE DIGESTIVE SYSTEM, GENETIC DISEASES, INFECTIONS, DISEASES OF THE KIDNEY AND GENITOURINARY SYSTEM, METABOLIC DISEASES, ENDOCRINOLOGY DISEASES, MUSCULOSKELETAL DISORDERS, OPHTHALMOLOGY DISEASES, RESPIRATORY AND PULMONARY DISEASES AND GYNECOLOGICAL DISEASES; DIAGNOSTIC PREPARATIONS FOR VETERINARY PURPOSES BASED ON ACTIVE PROTEINS AND NUCLEIC ACIDS; MEDICAL DIAGNOSTIC KITS PRIMARILY COMPOSED OF REAGENTS AND ASSAYS FOR TESTING AMNIOTIC FLUID, BLOOD AND BLOOD PLASMA, SERUM, SEMEN, URINE, CEREBROSPINAL FLUID AND INTRACELLULAR FLUID, SALIVA, SPUTUM, FECES, LYMPHATIC FLUID, WOUND EXUDATE AND SANIES (U.S. CLS. 6, 18, 44, 46, 51 AND 52).

CLASS 42—SCIENTIFIC AND COMPUTER SERVICES

FOR SCIENTIFIC RESEARCH AND DEVELOPMENT IN THE FIELD OF MOLECULAR BIOLOGY AND PROVIDING ADVICE ON A CONTRACTUAL BASES RELATING TO SCIENTIFIC DEVELOPMENTS IN MOLECULAR BIOLOGY; SCIENTIFIC RESEARCH AND DEVELOPMENT OF MOLECULAR-BIOLOGICAL ASSAYS; SCIENTIFIC RESEARCH AND DEVELOPMENT OF MEDICINE AND ENVIRONMENTAL ANALYSIS; SCIENTIFIC RESEARCH AND DEVELOPMENT IN THE FIELDS OF BIOLOGICAL ACTIVE SUBSTANCES AND BIOTECHNOLOGY (U.S. CLS. 100 AND 101).

BERYL GARDNER, EXAMINING ATTORNEY

MECHATROPOLIS

THE MARK CONSISTS OF STANDARD CHARACTERS WITHOUT CLAIM TO ANY PARTICULAR FONT, STYLE, SIZE, OR COLOR.

CLASS 41—EDUCATION AND ENTERTAINMENT

FOR PROVIDING EDUCATIONAL WORKSHOPS, SEMINARS AND WEB CASTS IN THE FIELD OF MECHATRONIC DESIGN FOR MICROCONTROLLER MECHANICS AND ELECTRICAL ENGINEERS VIA THE INTERNET (U.S. CLS. 100, 101 AND 107).

FIRST USE 3-26-2007; IN COMMERCE 3-26-2007.

CLASS 42—SCIENTIFIC AND COMPUTER SERVICES

FOR PROVIDING A WEB SITE FEATURING NEWS AND INFORMATION IN THE FIELD OF MECHATRONIC DESIGN, FOR MICROCONTROLLER MECHANICS AND ELECTRICAL ENGINEERS; PROVIDING ON-LINE EVALUATION SERVICES OF PRODUCTS FEATURING MECHATRONIC DESIGN FOR MICROCONTROLLER MECHANICS AND ELECTRICAL ENGINEERS (U.S. CLS. 100 AND 101).

FIRST USE 3-26-2007; IN COMMERCE 3-26-2007.

PAUL CROWLEY, EXAMINING ATTORNEY

SN 77-310,052. RADIANT INVESTMENTS LIMITED, TSMI SHA TSUI, HONG KONG, FILED 10-22-2007.



OWNER OF ERPN CMNTY TM OFC REG. NO. 5010772, DATED 2-21-2007, EXPIRES 4-10-2016.

NO CLAIM IS MADE TO THE EXCLUSIVE RIGHT TO USE "QUINTUPLE FILTRATION" WITH RESPECT TO CLASSES 032 AND 033, APART FROM THE MARK AS SHOWN.

THE COLOR(S) GOLD IS/ARE CLAIMED AS A FEATURE OF THE MARK.

THE MARK CONSISTS OF AN OVAL CONTAINING THE WORDS "QUINTUPLE FILTRATION" SURROUNDING THE STYLIZED LETTER "A". THE COLOR GOLD, IN VARIOUS SHADES, APPEARS IN THE DESIGN AND WORDING OF THE MARK.

CLASS 25—CLOTHING

FOR CLOTHING, NAMELY, TIES, GLOVES, SHIRTS, CASUAL SHIRTS, WORK AND GYM SHIRTS, COATS, SWEATERS, MEN'S AND BOY'S SUITS, HOUSECOATS, HOUSE JACKETS, SWIMSUITS, SWIMMING TRUNKS, SUNBATHING COSTUMES, SKIING WEAR, HATS, CAPS, BERETS, SCARVES AND HEADSCARVES (U.S. CLS. 22 AND 39).

CLASS 30—STAPLE FOODS

FOR COFFEE, TEA, VINEGAR, SAUCES AND ICE (U.S. CL. 46).

CLASS 32—LIGHT BEVERAGES

FOR BEERS; MINERAL AND AERATED WATERS; STILL AND SPARKLING WATERS; FRUIT DRINKS AND FRUIT JUICES; SYRUPS AND OTHER PREPARATIONS FOR MAKING BEVERAGES, NAMELY, BEERS AND FRUIT DRINKS (U.S. CLS. 45, 46 AND 48).

CLASS 33—WINES AND SPIRITS

FOR ALCOHOLIC BEVERAGES, NAMELY, VODKA, WHISKY, RUM, GIN, WINE, LIQUEURS, BRANDY (U.S. CLS. 47 AND 49).

CLASS 34—SMOKERS' ARTICLES

FOR TOBACCO; SMOKERS' ARTICLES, NAMELY, ASHTRAYS AND LIGHTERS; MATCHES (U.S. CLS. 2, 8, 9 AND 17).

CLASS 41—EDUCATION AND ENTERTAINMENT

FOR EDUCATIONAL SERVICES, NAMELY, CONDUCTING CLASSES, SEMINARS AND WORKSHOPS IN THE FIELD OF ALCOHOLIC BEVERAGES; PROVIDING TRAINING IN THE FIELD OF ALCOHOLIC BEVERAGES; ORGANISING COMMUNITY SPORTING AND CULTURAL EVENTS (U.S. CLS. 100, 101 AND 107).
VIVIAN MICZNIK FIRST, EXAMINING ATTORNEY

SN 77-317,113. MR. WILLS, INC., TORONTO, CANADA, FILED 10-30-2007.

ESTATETHERAPY

THE MARK CONSISTS OF STANDARD CHARACTERS WITHOUT CLAIM TO ANY PARTICULAR FONT, STYLE, SIZE, OR COLOR.

OWNER OF CANADA REG. NO. TMA675428, DATED 10-23-2006, EXPIRES 10-23-2021.

CLASS 9—ELECTRICAL AND SCIENTIFIC APPARATUS

FOR PRERECORDED AUDIOTAPES, CDS AND ELECTRONIC PUBLICATIONS, NAMELY, BOOKS RECORDED ON COMPUTER MEDIA, ALL FEATURING INFORMATION PERTAINING TO ESTATES, WILLS, ADMINISTRATION AND LITIGATION (U.S. CLS. 21, 23, 26, 36 AND 38).

CLASS 16—PAPER GOODS AND PRINTED MATTER

FOR BOOKS IN THE FIELD OF ESTATES, WILLS, ADMINISTRATION AND LITIGATION (U.S. CLS. 2, 5, 22, 23, 29, 37, 38 AND 50).

CLASS 41—EDUCATION AND ENTERTAINMENT

FOR EDUCATIONAL SERVICES, NAMELY, PROVIDING SEMINARS, TEACHING, AND COURSES AT THE COLLEGE, POST-GRADUATE, ADULT CONTINUING-EDUCATION, LEGAL CONTINUING-EDUCATION LEVEL, ALL RELATING TO ESTATES AND ESTATE PLANNING, WILLS, ESTATE ADMINISTRATION AND LITIGATION; PUBLICATION OF BOOKS AND PUBLISHING OF ELECTRONIC PUBLICATIONS, NAMELY, BOOKS CONTAINING INFORMATION PERTAINING TO WILLS, ESTATES, ESTATE PLANNING ADMINISTRATION AND LITIGATION; ELECTRONIC PUBLISHING SERVICES, NAMELY, PUBLICATION OF TEXT AND GRAPHIC WORKS OF OTHERS ON PRE-RECORDED TAPES AND COMPACT DISCS, ALL PERTAINING TO ESTATES, WILLS, ADMINISTRATION AND LITIGATION (U.S. CLS. 100, 101 AND 107).
REBECCA EISINGER, EXAMINING ATTORNEY

SN 77-319,851. STARPOINT SYSTEMS, INC., YELM, WA. FILED 11-2-2007.

FLY HIGH JOY

THE MARK CONSISTS OF STANDARD CHARACTERS WITHOUT CLAIM TO ANY PARTICULAR FONT, STYLE, SIZE, OR COLOR.

CLASS 16—PAPER GOODS AND PRINTED MATTER

FOR PAPER GOODS AND PRINTED MATTER, NAMELY, INSPIRATIONAL MESSAGE CARDS, CALENDARS, BUMPER STICKERS, STICKERS, GIFT CARDS, NOTEPADS, POSTERS, DECALS, CHILDREN'S BOOKS, PAPER BABY BIBS, NOTEPAPER, STATIONERY, ENVELOPES, NOTEBOOKS, BLANK JOURNALS FOR DIARY ENTRIES AND PAPER BANNERS (U.S. CLS. 2, 5, 22, 23, 29, 37, 38 AND 50).

CLASS 25—CLOTHING

FOR CLOTHING, NAMELY, SHIRTS, SHORT SLEEVE AND LONG SLEEVE T-SHIRTS, WOMEN'S MATERNITY SHIRTS, SWEAT SHIRTS, TANK TOPS, BASEBALL CAPS, SUN VISORS, SOCKS, UNDERCLOTHES, PANTS, DRESSES, SKIRTS, SWEATERS, BATHROBES, ROBES, SWEAT SUITS, WARM-UP SUITS, BATHING SUITS, BEACHWEAR, SHORTS, JACKETS, VESTS, COATS, FOOTWEAR, SLACKS, TURTLENECKS, OVERALLS, JUMP SUITS, GLOVES, EAR MUFFS, NECKWEAR, SCARVES, SHAWLS, BABY CLOTHES, NAMELY, T-SHIRTS, ONE-PIECE CLOTHING FOR BABIES, CLOTH DIAPERS, BABY BIBS NOT OF PAPER, PAJAMAS, SKI WEAR, DANCE CLOTHING, NAMELY, TOPS AND LEOTARDS, MASQUERADE COSTUMES, SUSPENDERS, BANDANAS, BELTS AND HEADWEAR (U.S. CLS. 22 AND 39).

INGA ERVIN, EXAMINING ATTORNEY

SN 77-323,706. BIONIC PRODUCTS PTY LTD, 4226 QUEENSLAND, AUSTRALIA, FILED 11-7-2007.

ELANRA AIR

THE MARK CONSISTS OF STANDARD CHARACTERS WITHOUT CLAIM TO ANY PARTICULAR FONT, STYLE, SIZE, OR COLOR.

OWNER OF AUSTRALIA REG. NO. 1201323, DATED 10-8-2007, EXPIRES 10-8-2017.

NO CLAIM IS MADE TO THE EXCLUSIVE RIGHT TO USE "AIR", APART FROM THE MARK AS SHOWN.

CLASS 10—MEDICAL APPARATUS

FOR ELECTRO-MEDICAL APPARATUS FOR PRODUCING SMALL BIOLOGICAL ACTIVE IONS FOR ASSISTING BREATHING, FOR RELIEF OF PAIN, FOR TRAINING BREATHING TECHNIQUES AND FOR USE IN RESPIRATION; ELECTRONIC MEDICAL APPARATUS FOR PRODUCING SMALL BIOLOGICAL ACTIVE IONS; MEDICAL APPARATUS FOR PRODUCING SMALL BIOLOGICAL ACTIVE IONS FOR ASSISTING BREATHING; MEDICAL APPARATUS FOR EXERCISE THAT PRODUCES SMALL BIOLOGICAL ACTIVE IONS; MEDICAL APPARATUS FOR PRODUCING SMALL BIOLOGICAL ACTIVE IONS FOR THE RELIEF OF PAIN; MEDICAL APPARATUS FOR PRODUCING SMALL BIOLOGICAL ACTIVE IONS FOR TRAINING BREATHING TECHNIQUES; MEDICAL APPARATUS FOR PRODUCING SMALL BIOLOGICAL ACTIVE IONS FOR USE IN RESPIRATION (U.S. CLS. 26, 39 AND 44).

CLASS 11—ENVIRONMENTAL CONTROL APPARATUS

FOR AIR IONIZATION APPARATUS FOR PRODUCING SMALL BIOLOGICAL ACTIVE IONS; ION GENERATING AIR PURIFICATION APPARATUS FOR PRODUCING SMALL BIOLOGICAL ACTIVE IONS; IONIZATION APPARATUS FOR PRODUCING SMALL BIOLOGICAL ACTIVE IONS FOR THE TREATMENT OF AIR; IONIZERS FOR AIR TREATMENT; IONIZATION APPARATUS FOR PRODUCING SMALL BIOLOGICAL ACTIVE IONS FOR THE TREATMENT OF AIR; IONIZERS FOR THE TREATMENT OF AIR (U.S. CLS. 13, 21, 23, 31 AND 34).

PAUL MORENO, EXAMINING ATTORNEY

SN 77-325,097. THE YARN LOUNGE, INC., RICHMOND, VA, FILED 11-8-2007.

THE YARN LOUNGE

THE MARK CONSISTS OF STANDARD CHARACTERS WITHOUT CLAIM TO ANY PARTICULAR FONT, STYLE, SIZE, OR COLOR.

NO CLAIM IS MADE TO THE EXCLUSIVE RIGHT TO USE "YARN", APART FROM THE MARK AS SHOWN.

CLASS 35—ADVERTISING AND BUSINESS

FOR RETAIL STORES FEATURING KNITTING YARN AND KNITTING ACCESSORIES (U.S. CLS. 100, 101 AND 102).

FIRST USE 3-12-2005; IN COMMERCE 3-12-2005.

CLASS 41—EDUCATION AND ENTERTAINMENT

FOR EDUCATION SERVICES, NAMELY, PROVIDING CLASSES, WORKSHOPS AND INSTRUCTION IN THE FIELD OF KNITTING (U.S. CLS. 100, 101 AND 107).

FIRST USE 4-24-2005; IN COMMERCE 4-24-2005.
WENDY GOODMAN, EXAMINING ATTORNEY

SN 77-325,921. CVS PHARMACY, INC., WOONSOCKET, RI, FILED 11-9-2007.

CAREPLUS CVS/PHARMACY

THE MARK CONSISTS OF STANDARD CHARACTERS WITHOUT CLAIM TO ANY PARTICULAR FONT, STYLE, SIZE, OR COLOR.

OWNER OF U.S. REG. NOS. 2,048,916, 3,211,443 AND OTHERS.

CLASS 35—ADVERTISING AND BUSINESS

FOR RETAIL STORE AND MAIL ORDER PHARMACY SERVICES IN THE FIELD OF PRESCRIPTION DRUGS (U.S. CLS. 100, 101 AND 102).

CLASS 44—MEDICAL, BEAUTY AND AGRICULTURAL SERVICES

FOR PROVIDING MEDICAL INFORMATION REGARDING PATIENTS, PRESCRIPTION DRUGS AND DRUG THERAPY (U.S. CLS. 100 AND 101).

ZACHARY BELLO, EXAMINING ATTORNEY

SN 77-326,859. SERIMAX HOLDINGS, 77290 MITRY MORY, FRANCE, FILED 11-12-2007.

SERIMAX

THE MARK CONSISTS OF STANDARD CHARACTERS WITHOUT CLAIM TO ANY PARTICULAR FONT, STYLE, SIZE, OR COLOR.

OWNER OF UNITED KINGDOM REG. NO. 2411490, DATED 1-19-2006, EXPIRES 1-19-2016.

THE MARK "SERIMAX" HAS NO MEANING IN A FOREIGN LANGUAGE.

CLASS 37—CONSTRUCTION AND REPAIR

FOR PIPELINE CONSTRUCTION SERVICES, PIPELINE INSTALLATION SERVICES, PIPELINE REPAIR SERVICES; UNDERWATER REPAIR SERVICES (U.S. CLS. 100, 103 AND 106).

FIRST USE 1-0-2007; IN COMMERCE 1-0-2007.

CLASS 40—MATERIAL TREATMENT

FOR WELDING SERVICES, NAMELY, WELDING, PIPELINE WELDING, MANUAL PIPELINE WELDING, AUTOMATIC PIPELINE WELDING; WELDING EQUIPMENT AND WELDING MACHINERY RENTAL, RENTAL OF ANCILLARY WELDING MACHINERY, NAMELY, MACHINERY FOR WELDING METAL COMPONENTS OF THE PIPELINE ANCILLARY TO THE MAIN PIPELINE (U.S. CLS. 100, 103 AND 106).

FIRST USE 1-0-2007; IN COMMERCE 1-0-2007.

CLASS 41—EDUCATION AND ENTERTAINMENT

FOR TRAINING IN THE USE OF WELDING EQUIPMENT AND IN THE WELDING OF PIPELINES; PROVISION OF QUALIFICATIONS, NAMELY, OFFERING OF CLASSROOM TRAINING FOR CERTIFICATION OF WELDERS IN THE USE OF WELDING EQUIPMENT AND IN THE WELDING OF PIPELINES (U.S. CLS. 100, 101 AND 107).

FIRST USE 1-0-2007; IN COMMERCE 1-0-2007.

MARY MUNSON, EXAMINING ATTORNEY

SN 77-327,846. RADCLIFFE DENIM LIMITED, LONDON, UNITED KINGDOM, FILED 11-13-2007.



designed by

SUZY RADCLIFFE

PRIORITY CLAIMED UNDER SEC. 44(D) ON ERPN CMNTY TM OFC APPLICATION NO. 006431456, FILED 11-13-2007, REG. NO. 6431456, DATED 10-23-2008, EXPIRES 11-13-2017.

NO CLAIM IS MADE TO THE EXCLUSIVE RIGHT TO USE "DESIGNED BY", APART FROM THE MARK AS SHOWN.

THE NAME "SUZY RADCLIFFE" IN THE MARK IDENTIFIES A LIVING INDIVIDUAL WHOSE CONSENT IS OF RECORD.

CLASS 9—ELECTRICAL AND SCIENTIFIC APPARATUS

FOR SUNGLASSES, EYE GLASSES, FRAMES FOR GLASSES, CASES FOR GLASSES, SUNGLASSES AND SPECTACLES, CORDS, RIBBONS AND CHAINS FOR RETAINING GLASSES, SUNGLASSES AND SPECTACLES IN POSITION (U.S. CLS. 21, 23, 26, 36 AND 38).

CLASS 14—JEWELRY

FOR WATCHES, CLOCKS, JEWELRY, IMITATION JEWELRY (U.S. CLS. 2, 27, 28 AND 50).

CLASS 18—LEATHER GOODS

FOR ARTICLES OF LEATHER AND IMITATIONS OF LEATHER, NAMELY, TRUNKS AND TRAVELLING BAGS; TRAVEL CASES; LUGGAGE; SUITCASES; HOLD ALLS; PORT MANTEAUX; VALISES; ATHLETIC BAGS; BEACH BAGS; HANDBAGS, SHOULDER BAGS; TOILETRY BAGS SOLD EMPTY; CARRIER BAGS; RUCKSACKS; BACKPACKS; SPORTS BAGS; CASUAL BAGS; BRIEFCASES; ATTACHÉ CASES; MUSIC CASES; SATCHELS; BEAUTY CASES SOLD EMPTY; CARRIERS FOR SUITS, SHIRTS AND DRESSES; TIE CASES; CREDIT CARD CASES AND HOLDERS; WALLET; PURSES; UMBRELLAS; PARASOLS; WALKING STICKS (U.S. CLS. 1, 2, 3, 22 AND 41).

CLASS 25—CLOTHING

FOR ARTICLES OF CLOTHING, NAMELY, DRESSES, JACKETS, SKIRTS, BLOUSES, SKIRTS, TROUSERS, SHORTS, EVENING DRESSES, SHIRTS, T-SHIRTS, JEANS, SWIMWEAR, UNDERWEAR, SUITS, SWEATERS, WAISTCOATS, SCARVES; GLOVES; MITTENS; BELTS; POLO SHIRTS, SPORTS SHIRTS, FOOTBALL AND RUGBY SHIRTS, SPORTS SHORTS, FOOTBALL SHORTS, RUGBY SHORTS; LINGERIE; TRACKSUITS; COATS, SKI JACKETS, CASUAL JACKETS, WATER-PROOF AND WEATHERPROOF JACKETS AND COATS; PARKAS, SKI WEAR; JUMPERS AND CARDIGANS; KNITWEAR, NAMELY, SWEATERS, SHIRTS, SKIRTS, DRESSES, VESTS; LEGGINGS, NECKTIES, PYJAMAS; HEADBANDS AND WRISTBANDS; SOCKS AND HOSIERY; FOOTWEAR, NAMELY, BATH SANDALS, BATH SLIPPERS, SPORTS SHOES, FLIP-FLOPS, SANDALS, SHOES, BOOTS; HEADGEAR, NAMELY, HATS AND CAPS (U.S. CLS. 22 AND 39).

LEIGH CAROLINE CASE, EXAMINING ATTORNEY

SN 77-330,536. PARRAGON BOOKS LIMITED, BATH, UNITED KINGDOM, FILED 11-15-2007.

READING HEROES

THE MARK CONSISTS OF STANDARD CHARACTERS WITHOUT CLAIM TO ANY PARTICULAR FONT, STYLE, SIZE, OR COLOR.

PRIORITY CLAIMED UNDER SEC. 44(D) ON UNITED KINGDOM APPLICATION NO. 2456528, FILED 5-24-2007, REG. NO. 2456528, DATED 11-23-2007, EXPIRES 5-24-2017.

NO CLAIM IS MADE TO THE EXCLUSIVE RIGHT TO USE "READING", APART FROM THE MARK AS SHOWN.

CLASS 9—ELECTRICAL AND SCIENTIFIC APPARATUS

FOR ELECTRONIC PUBLICATIONS, NAMELY, BOOKS, MAGAZINES, MANUALS IN THE FIELDS OF ENTERTAINMENT, PLAY, EDUCATION AND LEARNING IN ELECTRONICALLY, MAGNETICALLY OR OPTICALLY RECORDED AND RECORDABLE FORM; DOWNLOADABLE ELECTRONIC BOOKS IN THE FIELDS OF ENTERTAINMENT, PLAY, EDUCATION AND LEARNING; ELECTRONIC BOOKS IN THE FIELDS OF ENTERTAINMENT, PLAY, EDUCATION AND LEARNING RECORDED ON ELECTRONIC MEDIA; AUDIO BOOKS IN THE FIELDS OF ENTERTAINMENT, PLAY, EDUCATION AND LEARNING RECORDED ON AUDIO CASSETTES, COMPACT DISCS, DVDS, CD ROMS OR VIDEO TAPES; ELECTRONIC PUBLICATIONS, NAMELY, BOOKS, MAGAZINES, MANUALS IN THE FIELDS OF ENTERTAINMENT, PLAY, EDUCATION AND LEARNING BOTH DOWNLOADABLE AND RECORDED ON ELECTRONIC MEDIA; ELECTRONIC GAME PROGRAMMES; PRE-RECORDED AUDIO CASSETTES FEATURING BOOKS READ ALOUD; PRE-RECORDED MAGNETIC AND NON-MAGNETIC MATERIALS, NAMELY, TAPES, CARDS, DATA CARRIERS, CARTRIDGES AND PRE-RECORDED MEMORY DISCS ALL FEATURING THE FIELDS OF ENTERTAINMENT, PLAY, EDUCATION AND LEARNING; PRE-RECORDED COMPACT DISCS FEATURING BOOKS READ ALOUD; PRE-RECORDED DVDS FEATURING THE FIELDS OF ENTERTAINMENT, PLAY, EDUCATION AND LEARNING; PRE-RECORDED CD ROMS FEATURING THE FIELDS OF ENTERTAINMENT, PLAY, EDUCATION AND LEARNING; PRE-RECORDED VIDEO TAPES FEATURING THE FIELDS OF ENTERTAINMENT, PLAY, EDUCATION AND LEARNING; SOUND, VIDEO AND/OR DATA RECORDINGS OR A COMBINATION THEREOF FEATURING THE FIELDS OF ENTERTAINMENT, PLAY,

EDUCATION AND LEARNING; PARTS AND FITTINGS FOR ALL THE AFORESAID GOODS (U.S. CLS. 21, 23, 26, 36 AND 38).

CLASS 16—PAPER GOODS AND PRINTED MATTER

FOR BOOKS IN THE FIELDS OF ENTERTAINMENT, PLAY, EDUCATION AND LEARNING; PRINTED MATTER, NAMELY, BOOKS, BOOKLETS, PAMPHLETS, COMIC BOOKS, BROCHURES IN THE FIELDS OF ENTERTAINMENT, PLAY, EDUCATION AND LEARNING; PRINTED PUBLICATIONS, NAMELY, BOOKS, BOOKLETS, PAMPHLETS, COMIC BOOKS, BROCHURES IN THE FIELDS OF ENTERTAINMENT, PLAY, EDUCATION AND LEARNING; DIARIES; STATIONERY; MAGAZINES IN THE FIELDS OF ENTERTAINMENT, PLAY, EDUCATION AND LEARNING; COMICS, NAMELY, COMIC BOOKS; PERIODICALS IN THE FIELDS OF ENTERTAINMENT, PLAY, EDUCATION AND LEARNING; POSTERS; PRINTED INSTRUCTIONAL AND TEACHING MATERIALS IN THE FIELDS OF ENTERTAINMENT, PLAY, EDUCATION AND LEARNING; PAPER, CARDBOARD AND GOODS MADE FROM THESE MATERIALS, NAMELY, BAGS, BANNERS, BOARD, BOXES, FOLDERS, PARTY HATS, MATS; NEWSPAPERS; CALENDARS; ADDRESS BOOKS; APPOINTMENT BOOKS; GREETING CARDS; BOOK ENDS; WRAPPING PAPER; GIFT TAGS; TOYS IN THE NATURE OF BOOKS, NAMELY, TOYS CONSISTING OF A SERIES OF WOOD, PAPER, CLOTH, CARD OR PLASTIC PAGES OR ANY COMBINATION THEREOF ON WHICH PICTURES OR WORDS APPEAR, BEING BOUND ALONG ONE SIDE; BOOKS WHICH INCLUDE DVDS, CDS, OR CD ROMS SOLD AS A UNIT, FEATURING THE FIELDS OF ENTERTAINMENT, PLAY, EDUCATION AND LEARNING (U.S. CLS. 2, 5, 22, 23, 29, 37, 38 AND 50).

EUGENIA MARTIN, EXAMINING ATTORNEY

CLASS 9—ELECTRICAL AND SCIENTIFIC APPARATUS

FOR ELECTRONIC PUBLICATIONS, NAMELY, BOOKS, MAGAZINES, MANUALS IN THE FIELDS OF ENTERTAINMENT, PLAY, EDUCATION AND LEARNING IN ELECTRONICALLY, MAGNETICALLY OR OPTICALLY RECORDED AND RECORDABLE FORM; DOWNLOADABLE ELECTRONIC BOOKS IN THE FIELDS OF ENTERTAINMENT, PLAY, EDUCATION AND LEARNING; ELECTRONIC BOOKS IN THE FIELDS OF ENTERTAINMENT, PLAY, EDUCATION AND LEARNING RECORDED ON ELECTRONIC MEDIA; AUDIO BOOKS IN THE FIELDS OF ENTERTAINMENT, PLAY, EDUCATION AND LEARNING RECORDED ON AUDIO CASSETTES, COMPACT DISCS, DVDS, CD ROMS OR VIDEO TAPES; ELECTRONIC PUBLICATIONS, NAMELY, BOOKS, MAGAZINES, MANUALS IN THE FIELDS OF ENTERTAINMENT, PLAY, EDUCATION AND LEARNING BOTH DOWNLOADABLE AND RECORDED ON ELECTRONIC MEDIA; ELECTRONIC GAME PROGRAMMES; PRE-RECORDED AUDIO CASSETTES FEATURING BOOKS READ ALOUD; PRE-RECORDED MAGNETIC AND NON-MAGNETIC MATERIALS, NAMELY, TAPES, CARDS, DATA CARRIERS, CARTRIDGES AND PRE-RECORDED MEMORY DISCS ALL FEATURING THE FIELDS OF ENTERTAINMENT, PLAY, EDUCATION AND LEARNING; PRE-RECORDED COMPACT DISCS FEATURING BOOKS READ ALOUD; PRE-RECORDED DVDS FEATURING THE FIELDS OF ENTERTAINMENT, PLAY, EDUCATION AND LEARNING; PRE-RECORDED CD ROMS FEATURING THE FIELDS OF ENTERTAINMENT, PLAY, EDUCATION AND LEARNING; PRE-RECORDED VIDEO TAPES FEATURING THE FIELDS OF ENTERTAINMENT, PLAY, EDUCATION AND LEARNING; SOUND, VIDEO AND/OR DATA RECORDINGS OR A COMBINATION THEREOF FEATURING THE FIELDS OF ENTERTAINMENT, PLAY, EDUCATION AND LEARNING; PARTS AND FITTINGS FOR ALL THE AFORESAID GOODS (U.S. CLS. 21, 23, 26, 36 AND 38).

SN 77-330,568. PARRAGON BOOKS LIMITED, BATH, UNITED KINGDOM, FILED 11-15-2007.



PRIORITY CLAIMED UNDER SEC. 44(D) ON UNITED KINGDOM APPLICATION NO. 2458126, FILED 6-11-2007, REG. NO. 2458126, DATED 3-21-2008, EXPIRES 6-11-2017.

NO CLAIM IS MADE TO THE EXCLUSIVE RIGHT TO USE "READING", APART FROM THE MARK AS SHOWN.

THE MARK CONSISTS OF A STAR WITH A BANNER ON THE LOWER PART OF THE STAR. THE BANNER CONTAINS THE WORDS "READING HEROES".

CLASS 16—PAPER GOODS AND PRINTED MATTER

FOR BOOKS IN THE FIELDS OF ENTERTAINMENT, PLAY, EDUCATION AND LEARNING; PRINTED MATTER, NAMELY, BOOKS, BOOKLETS, PAMPHLETS, COMIC BOOKS, BROCHURES IN THE FIELDS OF ENTERTAINMENT, PLAY, EDUCATION AND LEARNING; PRINTED PUBLICATIONS, NAMELY, BOOKS, BOOKLETS, PAMPHLETS, COMIC BOOKS, BROCHURES IN THE FIELDS OF ENTERTAINMENT, PLAY, EDUCATION AND LEARNING; DIARIES; STATIONERY; MAGAZINES IN THE FIELDS OF ENTERTAINMENT, PLAY, EDUCATION AND LEARNING; COMICS, NAMELY, COMIC BOOKS; PERIODICALS IN THE FIELDS OF ENTERTAINMENT, PLAY, EDUCATION AND LEARNING; POSTERS; PRINTED INSTRUCTIONAL AND TEACHING MATERIALS IN THE FIELDS OF ENTERTAINMENT, PLAY, EDUCATION AND LEARNING; PAPER, CARDBOARD AND GOODS MADE FROM THESE MATERIALS, NAMELY, BAGS, BANNERS, BOARD, BOXES, FOLDERS, PARTY HATS, MATS; NEWSPAPERS; CALENDARS; ADDRESS BOOKS; APPOINTMENT BOOKS; GREETING CARDS; BOOK ENDS; WRAPPING PAPER; GIFT TAGS; TOYS IN THE NATURE OF BOOKS, NAMELY, TOYS CONSISTING OF A SERIES OF WOOD, PAPER, CLOTH, CARD OR PLASTIC PAGES OR ANY COMBINATION THEREOF ON WHICH PICTURES OR WORDS APPEAR, BEING BOUND ALONG ONE SIDE; BOOKS WHICH INCLUDE DVDS, CDS, OR CD ROMS SOLD AS A UNIT, FEATURING THE FIELDS OF ENTERTAINMENT, PLAY, EDUCATION AND LEARNING (U.S. CLS. 2, 5, 22, 23, 29, 37, 38 AND 50).

EUGENIA MARTIN, EXAMINING ATTORNEY

SN 77-330,609. PARRAGON BOOKS LIMITED, BATH, UNITED KINGDOM, FILED 11-15-2007.



PRIORITY CLAIMED UNDER SEC. 44(D) ON UNITED KINGDOM APPLICATION NO. 2458128, FILED 6-11-2007, REG. NO. 2458128, DATED 3-21-2008, EXPIRES 6-11-2017.

NO CLAIM IS MADE TO THE EXCLUSIVE RIGHT TO USE "READING", APART FROM THE MARK AS SHOWN.

THE MARK CONSISTS OF A STAR WITH A BANNER ON THE LOWER PART OF THE STAR. THE BANNER CONTAINS THE WORDS "READING HEROES" AND THE STAR CONTAINS PICTURES OF A RABBIT, FROG, DUCK, AND OWL.

CLASS 9—ELECTRICAL AND SCIENTIFIC APPARATUS

FOR ELECTRONIC PUBLICATIONS, NAMELY, BOOKS, MAGAZINES, MANUALS IN THE FIELDS OF ENTERTAINMENT, PLAY, EDUCATION AND LEARNING IN ELECTRONICALLY, MAGNETICALLY OR OPTICALLY RECORDED AND RECORDABLE FORM; DOWNLOADABLE ELECTRONIC BOOKS IN THE FIELDS OF ENTERTAINMENT, PLAY, EDUCATION AND LEARNING; ELECTRONIC BOOKS IN THE FIELDS OF ENTERTAINMENT, PLAY, EDUCATION AND LEARNING RECORDED ON ELECTRONIC MEDIA; AUDIO BOOKS IN THE FIELDS OF ENTERTAINMENT, PLAY, EDUCATION AND LEARNING RECORDED ON AUDIO CASSETTES, COMPACT DISCS, DVDS, CD ROMS OR VIDEO TAPES; ELECTRONIC PUBLICATIONS, NAMELY, BOOKS, MAGAZINES, MANUALS IN THE FIELDS OF ENTERTAINMENT, PLAY, EDUCATION AND LEARNING BOTH DOWNLOADABLE AND RECORDED ON ELECTRONIC MEDIA; ELECTRONIC GAME PROGRAMMES; PRE-RECORDED AUDIO CASSETTES FEATURING BOOKS READ ALOUD; PRE-RECORDED MAGNETIC AND NON-MAGNETIC MATERIALS, NAMELY, TAPES, CARDS, DATA CARRIERS, CARTRIDGES AND PRE-RECORDED MEMORY DISCS ALL FEATURING THE FIELDS OF ENTERTAINMENT, PLAY, EDUCATION AND LEARNING; PRE-RECORDED COMPACT DISCS FEATURING BOOKS READ ALOUD; PRE-RECORDED DVDS FEATURING THE FIELDS OF ENTERTAINMENT, PLAY, EDUCATION AND LEARNING; PRE-RECORDED CD ROMS FEATURING THE FIELDS OF ENTERTAINMENT, PLAY, EDUCATION AND LEARNING; PRE-RECORDED VIDEO TAPES FEATURING THE FIELDS OF ENTERTAINMENT, PLAY, EDUCATION AND LEARNING; SOUND, VIDEO AND/OR DATA RECORDINGS OR A COMBINATION THEREOF FEATURING THE FIELDS OF ENTERTAINMENT, PLAY, EDUCATION AND LEARNING; PARTS AND FITTINGS FOR ALL THE AFORESAID GOODS (U.S. CLS. 21, 23, 26, 36 AND 38).

CLASS 16—PAPER GOODS AND PRINTED MATTER

FOR BOOKS IN THE FIELDS OF ENTERTAINMENT, PLAY, EDUCATION AND LEARNING; PRINTED MATTER, NAMELY, BOOKS, BOOKLETS, PAMPHLETS, COMIC BOOKS, BROCHURES IN THE FIELDS OF ENTERTAINMENT, PLAY, EDUCATION AND LEARNING; PRINTED PUBLICATIONS, NAMELY, BOOKS, BOOKLETS, PAMPHLETS, COMIC BOOKS, BROCHURES IN THE FIELDS OF ENTERTAINMENT, PLAY, EDUCATION AND LEARNING; DIARIES; STATIONERY; MAGAZINES IN THE FIELDS OF ENTERTAINMENT, PLAY, EDUCATION AND LEARNING; COMICS, NAMELY, COMIC BOOKS; PERIODICALS IN THE FIELDS OF ENTERTAINMENT, PLAY, EDUCATION AND LEARNING; POSTERS; PRINTED INSTRUCTIONAL AND TEACHING MATERIALS IN THE FIELDS OF ENTERTAINMENT, PLAY, EDUCATION AND LEARNING; PAPER, CARDBOARD AND GOODS MADE FROM THESE MATERIALS, NAMELY, BAGS, BANNERS, BOARD, BOXES, FOLDERS, PARTY HATS, MATS; NEWSPAPERS; CALENDARS; ADDRESS BOOKS; APPOINTMENT BOOKS; GREETING CARDS; BOOK ENDS; WRAPPING PAPER; GIFT TAGS; TOYS IN THE NATURE OF BOOKS, NAMELY, TOYS CONSISTING OF A SERIES OF WOOD, PAPER, CLOTH, CARD OR PLASTIC PAGES OR ANY COMBINATION THEREOF ON WHICH PICTURES OR WORDS APPEAR, BEING BOUND ALONG ONE SIDE; BOOKS WHICH INCLUDE DVDS, CDS, OR CD ROMS SOLD AS A UNIT, FEATURING THE FIELDS OF ENTERTAINMENT, PLAY, EDUCATION AND LEARNING (U.S. CLS. 2, 5, 22, 23, 29, 37, 38 AND 50).

EUGENIA MARTIN, EXAMINING ATTORNEY

SN 77-330,719. SWEENEY STERLING FINLAYSON & CO ARCHITECTS INC., TORONTO, CANADA, FILED 11-15-2007.

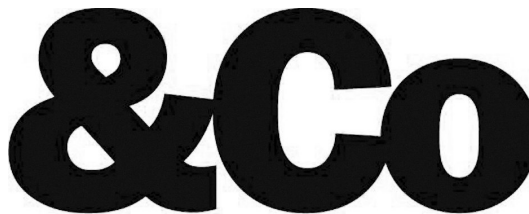

PRIORITY CLAIMED UNDER SEC. 44(D) ON CANADA APPLICATION NO. 1371221, FILED 11-8-2007, REG. NO. TMA726,576, DATED 10-22-2008, EXPIRES 10-22-2023.

THE MARK CONSISTS OF THE TERM "&CO" IN A STYLIZED FONT.

CLASS 37—CONSTRUCTION AND REPAIR

FOR REAL ESTATE DEVELOPMENT CONSULTATION (U.S. CLS. 100, 103 AND 106).

FIRST USE 10-31-2005; IN COMMERCE 10-31-2005.

CLASS 42—SCIENTIFIC AND COMPUTER SERVICES

FOR DESIGN SERVICES, NAMELY, ARCHITECTURAL, INTERIOR AND INDUSTRIAL DESIGN; URBAN DESIGN, NAMELY, THE DESIGN OF TOWNS AND CITIES; URBAN PLANNING; INFORMATION DESIGN, NAMELY, DESIGN OF DATA AND INFORMATION FOR VISUAL COMMUNICATION; BUILDING ASSESSMENTS, NAMELY, PRELIMINARY FEASIBILITY STUDIES UNDERTAKEN TO DETERMINE VIABILITY OF A REAL ESTATE DEVELOPMENT (U.S. CLS. 100 AND 101).

FIRST USE 10-31-2005; IN COMMERCE 10-31-2005.
CHRIS WELLS, EXAMINING ATTORNEY

SN 77-340,317. ALTICOR INC., ADA, MI. FILED 11-29-2007.

Amway Arena

NO CLAIM IS MADE TO THE EXCLUSIVE RIGHT TO USE "ARENA" AS TO THE SERVICES IN CLASS 41, APART FROM THE MARK AS SHOWN.

CLASS 9—ELECTRICAL AND SCIENTIFIC APPARATUS

FOR MAGNETICALLY ENCODED CREDIT CARDS (U.S. CLS. 21, 23, 26, 36 AND 38).

CLASS 14—JEWELRY

FOR JEWELRY AND WATCHES (U.S. CLS. 2, 27, 28 AND 50).

CLASS 16—PAPER GOODS AND PRINTED MATTER

FOR POSTERS, CALENDARS, TRADING CARDS, PHOTOGRAPHS, STATIONERY, BOOKS RELATING TO SPORTS, MAGAZINES RELATING TO SPORTS, NOTEPADS, STICKERS, BUMPER STICKERS, PENS, PENCILS, GREETING CARDS (U.S. CLS. 2, 5, 22, 23, 29, 37, 38 AND 50).

CLASS 18—LEATHER GOODS

FOR LUGGAGE ITEMS MADE OF LEATHER AND NON-LEATHER, NAMELY, SPORTS BAGS, SUITCASES, PULLMAN CASES, GARMENT BAGS, CARRY ON BAGS, DUFFLE BAGS, PURSES, BRIEF CASES, BACK PACKS, FANNY PACKS, LUGGAGE TAGS AND UMBRELLAS (U.S. CLS. 1, 2, 3, 22 AND 41).

CLASS 21—HOUSEWARES AND GLASS

FOR HOUSEWARES AND DRINKING GLASSES, NAMELY, PAPER CUPS, PLASTIC CUPS, GLASS CUPS, MUGS, BEVERAGE COOLERS AND SHOT GLASSES (U.S. CLS. 2, 13, 23, 29, 30, 33, 40 AND 50).

CLASS 25—CLOTHING

FOR MEN'S, WOMEN'S AND CHILDREN'S CLOTHING, NAMELY, FLEECE TOPS AND BOTTOMS, CAPS, T-SHIRTS, SWEATSHIRTS, SHORTS, TANK TOPS, SWEATERS, PANTS, JACKETS, TURTLENECKS, JUMPSUITS, JERSEYS, WARM UP SUITS, SWIMWEAR, WIND RESISTANT JACKETS AND PARKAS; SLEEPWEAR, NAMELY, ROBES AND PAJAMAS; GLOVES, SCARVES AND APRONS; FOOTWEAR, NAMELY, BOOTS, SNEAKERS AND ATHLETIC SHOES (U.S. CLS. 22 AND 39).

CLASS 28—TOYS AND SPORTING GOODS

FOR PLAYING CARDS, GOLF BALLS, GOLF BAGS, GOLF CLUB COVERS, BOWLING BALLS, BOWLING BAGS, BASKETBALLS, EXERCISE EQUIPMENT, NAMELY, STATIONARY EXERCISE BICYCLES, BAR BELLS AND FREE WEIGHTS (U.S. CLS. 22, 23, 38 AND 50).

CLASS 29—MEATS AND PROCESSED FOODS

FOR POTATO CHIPS, PROCESSED NUTS (U.S. CL. 46).

CLASS 30—STAPLE FOODS

FOR PREPARED FOODS, NAMELY, HAMBURGER SANDWICHES, HOT DOG SANDWICHES, PIZZA AND NACHOS; BEVERAGES, NAMELY, COFFEE, TEA AND COCOA; SNACK FOODS, NAMELY, CHEESE FLAVORED PUFFED CORN SNACKS, CORN TORTILLA SNACKS, PRETZELS, POPPED POPCORN; GRANOLA BASED SNACK BARS; CANDY AND CANDY BARS; VINEGAR, SAUCES; SPICES; ICE (U.S. CL. 46).

CLASS 32—LIGHT BEVERAGES

FOR LIGHT BEVERAGES, NAMELY, BEER, SOFT DRINKS, FRUIT JUICES AND BOTTLED WATER; SPORTS DRINKS AND ENERGY DRINKS (U.S. CLS. 45, 46 AND 48).

CLASS 41—EDUCATION AND ENTERTAINMENT

FOR ENTERTAINMENT IN THE NATURE OF BASKETBALL GAMES, BASEBALL GAMES, FOOTBALL GAMES, HOCKEY GAMES, SOCCER GAMES, SOFTBALL GAMES, GOLF GAMES, BOWLING, GYMNASTICS, WRESTLING MATCHES, FIGURE SKATING, SKATEBOARDING, BICYCLE AND FREESTYLE MOTORCROSS, CIRCUS PERFORMANCES, LIVE MUSICAL GROUPS, ICE SHOWS, AND BULL RIDING COMPETITIONS; ORGANIZING SPORTING AND CULTURAL ACTIVITIES; ENTERTAINMENT SERVICES, NAMELY, PROFESSIONAL BASKETBALL GAMES AND EXHIBITIONS (U.S. CLS. 100, 101 AND 107).

ELLEN BURNS, EXAMINING ATTORNEY

SN 77-341,037. SELA PRODUCTS, LLC, EDMOND, OK. FILED 11-30-2007.

The logo for 'Geek Gear' features the word 'Geek' in a large, bold, green font with a black outline, and the word 'Gear' in a smaller, bold, black font with a green outline, positioned below and to the right of 'Geek'.

THE COLOR(S) GREEN AND BLACK IS/ARE CLAIMED AS A FEATURE OF THE MARK.

THE COLOR GREEN APPEARS INSIDE THE LETTERS OF THE WORDING "GEEK GEAR." THE COLOR BLACK APPEARS IN THE OUTER EDGES OF THE LETTERS OF THE WORDING "GEEK GEAR."

CLASS 9—ELECTRICAL AND SCIENTIFIC APPARATUS

FOR PORTABLE MOTION DETECTORS; COMPUTER MICE; TRAVEL COMPUTER MICE; COMPUTER KEYPADS AND KEYBOARDS; TRAVEL COMPUTER KEYPADS AND KEYBOARDS; USB HUBS; USB COMPUTER PERIPHERALS; BATTERY CHARGERS; BATTERY TESTERS; PORTABLE BATTERY CHARGERS; SOLAR BATTERY CHARGES; EMERGENCY BATTERY CHARGERS; MOBILE PHONE BATTERY CHARGERS; BATTERIES; LAPTOP CARRYING CASE; BACKPACKS ESPECIALLY ADAPTED FOR HOLDING LAPTOP AND NOTEBOOK COMPUTERS; WEBCAMS; AUDIO SPEAKERS; COMPUTER SPEAKERS; PERSONAL AUDIO SPEAKERS AND AMPLIFIERS; FLASH MEMORY CARDS; BLANK SMART CARDS; BLANK MEDIA STORAGE DEVICES, NAMELY, FLASH DRIVES; BLANK MEDIA STORAGE DEVICES, NAMELY MEMORY CARDS; EARPHONES; HEADPHONES; PERSONAL EARPHONES AND HEADPHONES; MP3 PLAYERS; DIGITAL MEDIA PLAYERS; PROTECTIVE CARRYING CASES FOR PORTABLE LISTENING DEVICES, NAMELY, EARPHONES; SET TOP BOXES; PROGRAMMABLE DIGITAL TELEVISION RECORDERS; INPUT AND OUTPUT SCANNERS; DVRS; DISTRIBUTION AMPLIFIERS FOR AUDIO VISUAL SIGNALS; CONNECTION CABLES FOR AUDIO VISUAL EQUIPMENT; CONNECTION CABLES FOR DIGITAL MEDIA PLAYERS, MP3 PLAYERS, PORTABLE PERSONAL VIDEO DEVICES, AUDIO SPEAKERS, AMPLIFIERS, PERSONAL SPEAKERS, PERSONAL AMPLIFIERS, PERSONAL SETEROS, PERSONAL SOUND PROJECTORS, MOBILE RADIOS, TV TRANSMITTERS AND DECODERS (U.S. CLS. 21, 23, 26, 36 AND 38).

CLASS 11—ENVIRONMENTAL CONTROL APPARATUS

FOR LIGHT EMITTING DIODES (LED) BOOK LIGHTS; FLASHLIGHTS; LIGHT EMITTING DIODES (LED) TASK LIGHTS; PORTABLE ELECTRIC FANS (U.S. CLS. 13, 21, 23, 31 AND 34).

EVELYN BRADLEY, EXAMINING ATTORNEY

SN 77-342,764. CONSULTANT LUBRICANTS, INC., ST. CHARLES, MO. FILED 12-3-2007.

"The Solution is Science"

THE MARK CONSISTS OF STANDARD CHARACTERS WITHOUT CLAIM TO ANY PARTICULAR FONT, STYLE, SIZE, OR COLOR.

CLASS 1—CHEMICALS

FOR CHEMICAL COMPOUNDS USED IN MANUFACTURING OPERATIONS, NAMELY, CHEMICALS FOR INDUSTRIAL PURPOSES (U.S. CLS. 1, 5, 6, 10, 26 AND 46).

FIRST USE 1-10-2006; IN COMMERCE 1-10-2006.

CLASS 4—LUBRICANTS AND FUELS

FOR INDUSTRIAL OILS AND INDUSTRIAL LUBRICANTS (U.S. CLS. 1, 6 AND 15).

FIRST USE 1-10-2006; IN COMMERCE 1-10-2006.
BILL DAWE, EXAMINING ATTORNEY

SN 77-345,051. PALACE HOLDING, S.A. DE C.V., CANCUN, QUINTANA ROO, MEXICO, FILED 12-5-2007.



THE MARK CONSISTS OF A DOWNWARD CURVED ARC WITH A CROWN AT THE TOP OF THE CURVE.

CLASS 41—EDUCATION AND ENTERTAINMENT

FOR GOLF CLUB SERVICES; CASINOS; NIGHT CLUBS (U.S. CLS. 100, 101 AND 107).

FIRST USE 4-30-2005; IN COMMERCE 4-30-2005.

CLASS 43—HOTEL AND RESTAURANT SERVICES

FOR HOTEL, BAR AND RESTAURANT SERVICES; RESORT HOTELS (U.S. CLS. 100 AND 101).

FIRST USE 4-30-2005; IN COMMERCE 4-30-2005.

CLASS 44—MEDICAL, BEAUTY AND AGRICULTURAL SERVICES

FOR HEALTH SPA SERVICES FOR HEALTH AND WELLNESS OF THE BODY AND SPIRIT OFFERED AT A HEALTH RESORT; HEALTH SPA SERVICES, NAMELY, COSMETIC BODY CARE SERVICES (U.S. CLS. 100 AND 101).

FIRST USE 4-30-2005; IN COMMERCE 4-30-2005.

WENDY GOODMAN, EXAMINING ATTORNEY

SN 77-352,571. SPEEDO HOLDINGS BV, 1082 MD AMSTERDAM, NETHERLANDS, FILED 12-14-2007.

AQUABLADE

THE MARK CONSISTS OF STANDARD CHARACTERS WITHOUT CLAIM TO ANY PARTICULAR FONT, STYLE, SIZE, OR COLOR.

PRIORITY CLAIMED UNDER SEC. 44(D) ON ERPN CMNTY TM OFC APPLICATION NO. 006507818, FILED 12-12-2007, REG. NO. 006507818, DATED 11-13-2008, EXPIRES 12-12-2017.

CLASS 9—ELECTRICAL AND SCIENTIFIC APPARATUS

FOR LIFE-SAVING APPARATUS AND INSTRUMENTS, NAMELY, LIFE PRESERVERS AND LIFE SAVING RAFTS; DIVERS SUITS AND GLOVES; SWIMMERS AND DIVERS EARPLUGS, NOSE CLIPS; LIFE BUOYS; LIFE BELTS; UNDERWATER BREATHING APPARATUS; SWIMMING GOGGLES; PROTECTIVE EYEWEAR; SPECTACLES; SUNGLASSES; SNORKELS FOR USE IN SWIMMING, SWIMMING NOSE CLIPS, SWIMMING MASKS, GOGGLES AND PROTECTIVE GOGGLES FOR SPORTS ACTIVITIES, NAMELY, SWIMMING, SURFING, SAILING AND WINDSURFING AND STRAPS THEREFOR (U.S. CLS. 21, 23, 26, 36 AND 38).

CLASS 18—LEATHER GOODS

FOR LEATHER AND IMITATIONS OF LEATHER, AND GOODS MADE OF THESE MATERIALS, NAMELY, LEATHER AND IMITATION LEATHER BAGS AND PURSES; TRUNKS AND TRAVELLING BAGS; UMBRELLAS, PARASOLS AND WALKING STICKS; ALL-PURPOSE CARRYING BAGS; SATCHELS; HOLDALLS; WALLETS; PURSES; ATTACHE CASES; BRIEFCASES; BACKPACKS; GYM BAGS; SPORTS BAGS; TOTE BAGS; SUITCASES (U.S. CLS. 1, 2, 3, 22 AND 41).

SN 77-353,363. SOCCER UNITED MARKETING, LLC, NEW YORK, NY. FILED 12-17-2007.

**CLASS 25—CLOTHING**

FOR CLOTHING, NAMELY, SHIRTS, BLOUSES, SINGLETs, BATHING CAPS, VESTS, SKIRTS, DRESSES, TRACK SUITS, SWEATERS, WETSUITS FOR WATER SKIING, UNDERWEAR, T-SHIRTS, RUNNING SHORTS, WATER SHORTS, CROP TOPS, BRA TOPS, UNITARDS, LEOTARDS, BIKING SHORTS, ATHLETIC SHORTS, LEGGINGS, WARM-UP JACKETS, WARM-UP PANTS, SWEATSHIRTS, SWEATPANTS; FOOTWEAR; HEADGEAR, NAMELY, HATS AND CAPS; SWIMWEAR (U.S. CLS. 22 AND 39).

PATRICIA EVANKO, EXAMINING ATTORNEY

NO CLAIM IS MADE TO THE EXCLUSIVE RIGHT TO USE "MARKETING", APART FROM THE MARK AS SHOWN.

SEC. 2(F) AS TO "SOCCER UNITED".

SN 77-353,361. SOCCER UNITED MARKETING, LLC, NEW YORK, NY. FILED 12-17-2007.

CLASS 16—PAPER GOODS AND PRINTED MATTER

FOR PRINTED MEDIA GUIDES FEATURING INFORMATION ABOUT SOCCER; SOUVENIR PROGRAMS CONCERNING SOCCER; BOOKS REGARDING SOCCER (U.S. CLS. 2, 5, 22, 23, 29, 37, 38 AND 50).

FIRST USE 12-31-2002; IN COMMERCE 12-31-2002.

SOCCER UNITED MARKETING

CLASS 35—ADVERTISING AND BUSINESS

FOR PROMOTING SOCCER COMPETITIONS AND/OR EVENTS OF OTHERS (U.S. CLS. 100, 101 AND 102).

FIRST USE 12-31-2002; IN COMMERCE 12-31-2002.

THE MARK CONSISTS OF STANDARD CHARACTERS WITHOUT CLAIM TO ANY PARTICULAR FONT, STYLE, SIZE, OR COLOR.

NO CLAIM IS MADE TO THE EXCLUSIVE RIGHT TO USE "MARKETING", APART FROM THE MARK AS SHOWN.

SEC. 2(F) AS TO "SOCCER UNITED".

CLASS 41—EDUCATION AND ENTERTAINMENT

FOR ORGANIZING SPORTING EVENTS, NAMELY, SOCCER GAMES; CONDUCTING ENTERTAINMENT IN THE NATURE OF SOCCER EXHIBITIONS AND GAMES; PROVISION OF INFORMATION REGARDING SOCCER VIA THE INTERNET (U.S. CLS. 100, 101 AND 107).

FIRST USE 12-31-2002; IN COMMERCE 12-31-2002.

JAY FLOWERS, EXAMINING ATTORNEY

CLASS 16—PAPER GOODS AND PRINTED MATTER

FOR PRINTED MEDIA GUIDES FEATURING INFORMATION ABOUT SOCCER; SOUVENIR PROGRAMS CONCERNING SOCCER; BOOKS REGARDING SOCCER (U.S. CLS. 2, 5, 22, 23, 29, 37, 38 AND 50).

FIRST USE 12-31-2002; IN COMMERCE 12-31-2002.

SN 77-354,190. TRANSFRESH CORPORATION, SALINAS, CA. FILED 12-17-2007.

CLASS 35—ADVERTISING AND BUSINESS

FOR PROMOTING SOCCER COMPETITIONS AND/OR EVENTS OF OTHERS (U.S. CLS. 100, 101 AND 102).

FIRST USE 12-31-2002; IN COMMERCE 12-31-2002.

FRESH FLOWER SOLUTIONS

CLASS 41—EDUCATION AND ENTERTAINMENT

FOR ORGANIZING SPORTING EVENTS, NAMELY, SOCCER GAMES; CONDUCTING ENTERTAINMENT IN THE NATURE OF SOCCER EXHIBITIONS AND GAMES; PROVISION OF INFORMATION REGARDING SOCCER VIA THE INTERNET (U.S. CLS. 100, 101 AND 107).

FIRST USE 12-31-2002; IN COMMERCE 12-31-2002.

JAY FLOWERS, EXAMINING ATTORNEY

THE MARK CONSISTS OF STANDARD CHARACTERS WITHOUT CLAIM TO ANY PARTICULAR FONT, STYLE, SIZE, OR COLOR.

NO CLAIM IS MADE TO THE EXCLUSIVE RIGHT TO USE "FRESH FLOWER", APART FROM THE MARK AS SHOWN.

CLASS 39—TRANSPORTATION AND STORAGE

FOR PACKAGING OF LIVE PLANTS AND CUT FLOWERS FOR TRANSPORT, FOR THE PRESERVATION OF THEIR FRESHNESS, QUALITY AND APPEARANCE; TECHNICAL CONSULTATION IN THE FIELD OF PACKAGING OF PRODUCTS FOR TRANSPORT TO MAINTAIN THEIR FRESHNESS, QUALITY AND APPEARANCE (U.S. CLS. 100 AND 105).

CLASS 41—EDUCATION AND ENTERTAINMENT

FOR TRAINING IN THE PROPER USE OF EQUIPMENT AND MATERIALS FOR MONITORING, RECORDING, CONTROLLING AND ADJUSTING THE ATMOSPHERE IN CONTAINERS AND PACKAGES FOR ATMOSPHERE-CONTROLLED SHIPMENT OF LIVE PLANTS AND CUT FLOWERS (U.S. CLS. 100, 101 AND 107).

JAMES STEIN, EXAMINING ATTORNEY

SN 77-355,099. INTERGENERATIONAL WEALTH PRESERVATION, INC., NEW YORK, NY. FILED 12-18-2007.

CFPIT

THE MARK CONSISTS OF STANDARD CHARACTERS WITHOUT CLAIM TO ANY PARTICULAR FONT, STYLE, SIZE, OR COLOR.

CLASS 9—ELECTRICAL AND SCIENTIFIC APPARATUS

FOR (BASED ON INTENT TO USE IN COMMERCE) COMPUTER PROGRAMS AND COMPUTER SYSTEMS COMPRISED OF COMPUTER HARDWARE AND SOFTWARE, ALL FOR USE IN FINANCIAL ANALYSIS AND PLANNING FOR WEALTH PRESERVATION FOR BUSINESSES AND INDIVIDUALS WITH SUFFICIENT EXISTING ASSETS (U.S. CLS. 21, 23, 26, 36 AND 38).

CLASS 36—INSURANCE AND FINANCIAL

FOR (BASED ON USE IN COMMERCE) FINANCIAL CONSULTATION, NAMELY, CONSULTATION RELATING TO WEALTH PRESERVATION FOR BUSINESSES AND INDIVIDUALS WITH SUFFICIENT EXISTING ASSETS (U.S. CLS. 100, 101 AND 102).

FIRST USE 11-1-2007; IN COMMERCE 11-1-2007.
MARY CRAWFORD, EXAMINING ATTORNEY

SN 77-355,478. INFORS AG, BOTTMINGEN, SWITZERLAND, FILED 12-19-2007.

INFORS

OWNER OF SWITZERLAND REG. NO. 325330, DATED 11-30-1982, EXPIRES 11-30-2012.
THE WORDING "INFORS" HAS NO MEANING IN A FOREIGN LANGUAGE.

CLASS 7—MACHINERY

FOR PORTABLE AND STATIONARY SHAKING MACHINES; INCUBATOR SHAKING MACHINES (U.S. CLS. 13, 19, 21, 23, 31, 34 AND 35).

CLASS 9—ELECTRICAL AND SCIENTIFIC APPARATUS

FOR LABORATORY EQUIPMENT AND SUPPLIES, NAMELY, BIOGENERATORS AND INCUBATORS; FERMENTATION APPARATUSES FOR LABORATORY USE IN THE GROWTH OF CELLS IN BIOPHARMACEUTICAL RESEARCH AND BIOCHEMICAL MANUFACTURING; REGULATING AND CONTROL EQUIPMENT FOR LABORATORY USE FOR CARRYING OUT CHEMICAL PROCESSES, NAMELY, FOR CHEMICAL, PHARMACEUTICAL PRODUCTS AND LIQUID COMPONENTS; FERMENTATION APPARATUS FOR LABORATORY USE; ELECTROMECHANICAL FERMENTATION APPARATUS FOR CULTIVATING MICROORGANISMS FOR LABORATORY USE CONSISTING OF MECHANICAL MIXING ARMS, ELECTRIC MOTORS, HEAT SENSORS, PIPETTES AND AUTOMATIC VALVES, COMPUTER HARDWARE AND ASSOCIATED COMPUTER PERIPHERALS; CENTRIFUGAL METERING AND INFUSION PUMPS FOR LABORATORY USE (U.S. CLS. 21, 23, 26, 36 AND 38).

MARCIE MILONE, EXAMINING ATTORNEY

SN 77-355,735. JERRY GUZI & COMPANY, ROANOKE, VA. FILED 12-19-2007.

BURRIS COMPUTER FORMS

THE MARK CONSISTS OF STANDARD CHARACTERS WITHOUT CLAIM TO ANY PARTICULAR FONT, STYLE, SIZE, OR COLOR.

NO CLAIM IS MADE TO THE EXCLUSIVE RIGHT TO USE "COMPUTER FORMS", APART FROM THE MARK AS SHOWN.

SEC. 2(F).

CLASS 16—PAPER GOODS AND PRINTED MATTER

FOR BLANK FORMS FOR USE AS ACCOUNT STATEMENTS; BLANK INVOICE FORMS; ADHESIVE LABELS; BLANK BUSINESS FORMS; BLANK ADVERTISING PAMPHLETS AND BROCHURES; BLANK CARDS; BLANK NOTE CARDS; BLANK OR PARTIALLY PRINTED POSTCARDS; SHIPPING LABELS; BLANK BUSINESS FORMS AND BLANK PAPER DOOR KNOB HANGER SIGNS; BLANK OR PARTIALLY PRINTED IRS TAX FORMS; BLANK PAPER MAILERS WITH REPLY CARD, FEATURING BLANK TRI-FOLD BROCHURE PAPER AND BLANK REPLY CARD; AND BLANK ANNOUNCEMENT AND EVENT PROGRAMS, BLANK PAPER MENUS AND BLANK PAPER TABLE TENT CARDS; BLANK SHIPPING LABEL SHEETS AND BLANK PACKING SLIP FORMS (U.S. CLS. 2, 5, 22, 23, 29, 37, 38 AND 50).

FIRST USE 12-10-1992; IN COMMERCE 12-10-1992.

CLASS 35—ADVERTISING AND BUSINESS

FOR ONLINE ORDERING SERVICES FEATURING A FULL LINE OF PAPER, CARDBOARD, CARD MATERIAL, BLANK PRINTING FORMS, BLANK BUSINESS FORMS, BLANK ADVERTISING FORMS AND BLANK FORMS (U.S. CLS. 100, 101 AND 102).

FIRST USE 12-10-1992; IN COMMERCE 1-15-1997.
CARYN GLASSER, EXAMINING ATTORNEY

SN 77-357,749. BSH BOSCH UND SIEMENS HAUSGERAETE GMBH, MUNICH, FED REP GERMANY, FILED 12-21-2007.

BSH

THE MARK CONSISTS OF STANDARD CHARACTERS WITHOUT CLAIM TO ANY PARTICULAR FONT, STYLE, SIZE, OR COLOR.

PRIORITY CLAIMED UNDER SEC. 44(D) ON FED REP GERMANY APPLICATION NO. 30752113.3/0, FILED 8-8-2007, REG. NO. 30752113, DATED 9-19-2007, EXPIRES 8-31-2017.

OWNER OF FED REP GERMANY REG. NO. 30752113, DATED 9-19-2007, EXPIRES 8-31-2017.

CLASS 7—MACHINERY

FOR ELECTRIC KITCHEN MACHINES AND EQUIPMENT FOR FOOD PREPARATION AND PROCESSING, NAMELY, MINCING MACHINES, MIXING AND KNEADING MACHINES, PRESSING MACHINES, JUICE EXTRACTORS, JUICE CENTRIFUGES, GRINDING MACHINES, SLICING MACHINES, AND PARTS THEREFOR; ELECTRIC MOTOR DRIVEN TOOLS, NAMELY, ELECTRIC CAN OPENERS, KNIFE SHARPENERS AND PARTS THEREFOR; MACHINES WITH TAPS FOR DISPENSING COOLED BEVERAGES; WASTE DISPOSAL UNITS, NAMELY, WASTE MASTICATORS AND COMPRESSORS AND PARTS THEREFOR; DISHWASHERS AND PARTS THEREFOR; ELECTRICAL MACHINES AND APPLIANCES FOR TREATING LAUNDRY AND CLOTHING, NAMELY, WASHING MACHINES, LAUNDRY PRESSES, AND PARTS THEREFOR; ELECTRIC CLEANING EQUIPMENT FOR HOUSEHOLD USE, NAMELY, VACUUM CLEANERS, AND PARTS FOR VACUUM CLEANERS, NAMELY, VACUUM CLEANER NOZZLES, HOSES AND BRUSHES; ELECTRIC CLEANING EQUIPMENT FOR HOUSEHOLD USE, NAMELY, WINDOW CLEANING MACHINES; SHOE CLEANING MACHINES (U.S. CLS. 13, 19, 21, 23, 31, 34 AND 35).

CLASS 9—ELECTRICAL AND SCIENTIFIC APPARATUS

FOR ELECTRIC APPARATUS AND INSTRUMENTS, NAMELY, ELECTRIC IRONS, KITCHEN SCALES, PERSONAL SCALES, LASER WELDING DEVICES; REMOTE CONTROLS, SIGNALING DEVICES, CONTROLS AND MONITORING DEVICES FOR HOUSEHOLD AND KITCHEN MACHINES; BLANK MAGNETIC DATA CARRIERS; PRERECORDED MAGNETIC DATA CARRIERS FOR HOUSEHOLD APPLIANCES; VENDING MACHINES; DATA PROCESSORS; COMPUTER DATA PROCESSING PROGRAMS FOR CONTROLLING AND OPERATING HOUSEHOLD APPLIANCES; CLOTHES IRONING MACHINES AND PARTS THEREFOR (U.S. CLS. 21, 23, 26, 36 AND 38).

CLASS 11—ENVIRONMENTAL CONTROL APPARATUS

FOR ELECTRIC, ELECTRONIC, FUEL-OPERATED HOUSE AND KITCHEN APPARATUSES AND APPLIANCES FOR, COOKING, BAKING, FRYING, GRILLING, TOASTING, THAWING, AND HOT-KEEPING, NAMELY, ELECTRIC AND GAS RANGES, COOKING OVENS, ELECTRIC HOT PLATES, COOKING SURFACES WHICH HAVE ONE OR MORE ELECTRIC HOT PLATES OR GAS BURNERS COMBINED IN ONE APPLIANCE, COOKING SURFACES WITH COMMON GLASS CERAMIC SURFACES, IMMERSION HEATERS; ELECTRIC COOKING POTS, MICROWAVE OVENS FOR COOKING INDUCTION COOKING OVENS; WAFFLE IRONS; ELECTRIC EGG BOILERS; ELECTRIC DEEP FRYERS; ELECTRIC ESPRESSO MACHINES; ELECTRIC TEA AND COFFEE MAKING MACHINES; APPARATUS FOR PREPARING OR DISPENSING OF BEVERAGES OR

FOOD, NAMELY, REFRIGERATED BEVERAGE DISPENSING UNITS; REFRIGERATING AND DEEP FREEZING APPARATUS, NAMELY, ICE MAKING MACHINES; ICE CREAM MAKERS; HOT WATER HEATERS, NAMELY, STORAGE WATER HEATERS AND CONTINUOUS FLOW WATER HEATERS; SPIN CLOTHES DRYERS, CLOTHES DRYERS, AND ELECTRIC HOT AIR HAND DRIERS; VENTILATION DEVICES, NAMELY, VENTILATING FANS FOR COMMERCIAL USE, GREASE FILTER DEVICES AND EXTRACTOR DEVICES, NAMELY, AIR EXTRACTOR OR AIR FILTERING DEVICES FOR COOKING PLACES OR KITCHENS, NAMELY, EXTRACTOR HOODS; PORTABLE ELECTRIC HEATERS AND AIR CONDITIONING UNITS AND DEVICES TO IMPROVE AIR QUALITY, NAMELY, AIR HUMIDIFIERS, HEAT PUMPS; FITTINGS FOR STEAM, AIR AND WATER PIPING INSTALLATIONS; KITCHEN SINKS; ELECTRIC INSTRUMENTS FOR PERSONAL HYGIENE, HAIR AND BEAUTY CARE, NAMELY, HAND HELD AND STATIONARY HAIR DRIERS, HOT AIR SHOWERS (U.S. CLS. 13, 21, 23, 31 AND 34).

CLASS 37—CONSTRUCTION AND REPAIR

FOR INSTALLATION OF ELECTRIC AND/OR FUEL-OPERATED HOUSEHOLD APPARATUS AND HOUSEHOLD APPLIANCES AS WELL AS TELECOMMUNICATION APPARATUS (U.S. CLS. 100, 103 AND 106).

PAM WILLIS, EXAMINING ATTORNEY

SN 77-358,484. XYSTUS, COOPER CITY, FL. FILED 12-21-2007.

Alebrije Home Entertainment

THE MARK CONSISTS OF STANDARD CHARACTERS WITHOUT CLAIM TO ANY PARTICULAR FONT, STYLE, SIZE, OR COLOR.

NO CLAIM IS MADE TO THE EXCLUSIVE RIGHT TO USE "HOME ENTERTAINMENT", APART FROM THE MARK AS SHOWN.

CLASS 38—COMMUNICATION

FOR BROADCASTING OF RADIO AND TELEVISION PROGRAMMES (U.S. CLS. 100, 101 AND 104).

CLASS 41—EDUCATION AND ENTERTAINMENT

FOR PRODUCTION OF DVDS FOR ENTERTAINMENT PURPOSES FEATURING COMEDY MOTION PICTURES, THEATER PLAYS, MUSICALS, CARTOONS, GAME SHOWS, DOCUMENTARIES, SERIES, SOAP OPERAS, SCIENCE-FICTION AND FANTASY PROGRAMS (U.S. CLS. 100, 101 AND 107).

BARBARA BROWN, EXAMINING ATTORNEY

SN 77-361,416. MATHIAS, RANDALL S., BUTTE, MT. FILED 12-29-2007.

WINDOW FRAMES; WOODEN BEAMS; WOODEN FLOORING; WOODEN RAILINGS; WOODEN WAINSCOTING (U.S. CLS. 1, 12, 33 AND 50).



Mathias Woodcraft

NO CLAIM IS MADE TO THE EXCLUSIVE RIGHT TO USE THE WORD "WOODCRAFT", APART FROM THE MARK AS SHOWN.

THE MARK CONSISTS OF A CAPITAL "M" AS THOUGH FORMED OF THREE 3-DIMENSIONAL MEMBERS, WHICH ARE JOINED AS THOUGH BY A BUTTERFLY JOINT AND A LAP JOINT.

CLASS 19—NON-METALLIC BUILDING MATERIALS

FOR BALCONY ENCLOSURES; BALUSTRADES; BEAMS NOT OF METAL; BUILDING MATERIALS, NAMELY, SEMI-WORKED WOODS; BUILDING TIMBER; CEILING BOARDS OF WOOD; CEILING PANELS, NOT OF METAL; CONSTRUCTION TIMBER; DOOR CASINGS, NOT OF METAL; DOOR FRAMES, NOT OF METAL; DOOR JAMBS NOT OF METAL; DOOR PANELS, NOT OF METAL; FLOOR BOARDS; FLOOR PANELS NOT OF METAL; FLOOR TILES OF WOOD; HALVED TIMBER; INTERIOR NON-METAL WINDOW SHUTTERS; JAPANESE STYLE INDOOR SLIDING PARTITIONS (FUSUMA); LOGS; MANTELPIECES; MILLWORK, EXCLUSIVE OF CABINETS; NOISE BARRIERS MADE OF WOOD; NON-METAL BUILDING PRODUCTS, NAMELY, SHUTTERS, SHINGLES, SIDING, AND TRIM; NON-METAL DOOR FRAMES; NON-METAL DOOR PANELS; NON-METAL DOOR UNITS; NON-METAL DOOR KNOCKERS; NON-METAL DOORS; NON-METAL EXTERIOR BUILDING SHUTTERS; NON-METAL FENCE PANELS; NON-METAL FENCE POSTS; NON-METAL FENCE STAYS; NON-METAL FENCING PANELS; NON-METAL FENCING STAYS; NON-METAL FLOOR TILES; NON-METAL FLOORS; NON-METAL GARAGE DOORS; NON-METAL GATES; NON-METAL GATES AND FENCES; NON-METAL GATES AND FENCING; NON-METAL GATES AND FENCING PANELS; NON-METAL GIRDERS; NON-METAL GRATINGS; NON-METAL GREENHOUSE FRAMES; NON-METAL GUARD RAILS; NON-METAL JALOUSIES; NON-METAL LATHS; NON-METAL LATTICES; NON-METAL LINTELS; NON-METAL MANTELS FOR FIREPLACES; NON-METAL PATIO DOORS; NON-METAL PICKETS; NON-METAL POSTS; NON-METAL ROOF TRUSSES; NON-METAL ROOFING; NON-METAL ROOFING HIPPS; NON-METAL RUNNERS FOR SLIDING DOORS; NON-METAL SHINGLES; NON-METAL SKYLIGHTS; NON-METAL SLIDING DOORS; NON-METAL SPANDRELS; NON-METAL TRELLISES; NON-METAL WAINSCOTING; NON-METAL WINDOW CASEMENTS; NON-METAL WINDOW FRAMES; NON-METAL WINDOW SCREENS; NON-METAL WINDOW SHUTTERS; NON-METAL WINDOW SILLS; NON-METAL WINDOWS; NONMETAL CEILING MEDALLIONS; NONMETAL DIVING BOARDS; NONMETAL DOOR PARTS FOR BUILDINGS, NAMELY, ADJUSTERS FOR ADJUSTING THE HEIGHT OF A DOOR, FLOOR BOARDS, COLUMNS, BEAMS, PANELING BOARDS, SILLS, SLEEPERS, BACKINGS FOR CEILINGS OR WALLS, STILES, RAILS AND CEILING BOARDS; PARQUET FLOOR BOARDS; PARQUET FLOORING; PARQUET FLOORING AND PARQUET SLABS; PARQUET FLOORING MADE OF WOOD; PARQUET FLOORING OF WOOD; PARQUET WOOD FLOORING; ROOFING BOARDS; ROOFING, NOT OF METAL, INCORPORATING SOLAR CELLS; STAIR TREADS NOT OF METAL; STAIRCASES; STRUCTURAL TIMBER; TIMBER; WINDOW CASEMENTS NOT OF METAL; WOOD BEAMS; WOOD BLOCKS; WOOD BOARDS; WOOD DOOR FRAMES; WOOD JOINTS; WOOD JOISTS; WOOD MOLDINGS; WOOD PANELLING; WOOD POLES; WOOD POSTS; WOOD RAFTERS; WOOD SIDING; WOOD SPORTS FLOORS; WOOD TILE FLOORS; WOOD TRIM; WOOD

CLASS 20—FURNITURE AND ARTICLES NOT OTHERWISE CLASSIFIED

FOR ARMCHAIRS; ARMOIRES; BED FRAMES; BED HEADBOARDS; BED RAILS; BEDROOM FURNITURE; BEDS; BENCHES; BOOK STANDS; BOOKCASES; BOOK-SHELVES; BOTTLE RACKS; BREAKFRONTS; BUFFETS; BUNK BEDS; CABINETS; CABINETWORK; CHAIRS; CHAISE LONGUES; CHESTS OF DRAWERS; CLOSET ACCESSORIES, NAMELY, BELT RACKS; CLOSET ACCESSORIES, NAMELY, CLOTHES BARS; CLOSET ACCESSORIES, NAMELY, SHOE RACKS; COAT RACKS; COAT STANDS; COMPUTER FURNITURE; COUCHES; CRADLES; CREDENZAS; CRIBS; CUPBOARDS; CUPBOARDS FOR TEA-THINGS CABINETS (CHADANSU); CURTAIN RODS; DECORATIVE NONMETAL MAILBOX COVERS; DECORATIVE WOODEN WALL LETTERS FOR SPELLING NAMES AND WORDS; DESKS; DINING CHAIRS; DINING ROOM TABLES; DINING TABLES; DINNER WAGONS; DISPLAY BOARDS; DISPLAY CASES; DISPLAY CASES FOR MERCHANDISE; DISPLAY RACKS; DISPLAY STANDS; DISPLAY TABLES; DIVIDERS FOR DRAWERS; DOOR HANDLES, NOT OF METAL; DOOR STOPS OF WOOD; DOORS FOR FURNITURE; DRAWER ORGANIZERS FOR SILVERWARE; DRAWER PULLS OF PLASTIC OR WOOD, CORK, REED, CANE, WICKER, HORN, BONE, IVORY, WHALEBONE, SHELL, AMBER, MOTHER-OF-PEARL, MEERSCHAUM AND SUBSTITUTES FOR ALL THESE MATERIALS; DRAWERS; DRAWERS AND DIVIDERS THEREFOR; DRESSERS; DRESSING TABLES; EASY-CHAIRS; END TABLES; ENTERTAINMENT CENTERS; FIREGUARDS; FOOT RESTS; FOOT STOOLS; FOOTSTOOLS; FRAMES FOR OIL PAINTINGS; FRAMES FOR PAINTINGS; FURNITURE; FURNITURE CHESTS; FURNITURE FITTINGS, NOT OF METAL; FURNITURE FOR DISPLAYING GOODS; FURNITURE FOR HOUSE, OFFICE AND GARDEN; FURNITURE MADE FROM WOOD OR SUBSTITUTES OF WOOD; FURNITURE PARTS; FURNITURE, NAMELY, DISPLAY UNITS; FURNITURE, NAMELY, DRESSERS; FURNITURE, NAMELY, WALL UNITS; FURNITURE, NAMELY, WARDROBES; GUN CABINETS; HAT RACKS; HAT STANDS; HIGH CHAIRS; HIGH CHAIRS FOR BABIES; HUTCHES; IDENTITY PLATES, NOT OF METAL; INTERIOR WINDOW COVERINGS, NAMELY VERTICAL AND HORIZONTAL LOUVERS; KEY CABINETS; KITCHEN CABINETS; KITCHEN-TYPE CABINETS FOR OUTDOOR USE; LIVING ROOM FURNITURE; LOUNGE CHAIRS; LOVE SEATS; MAGAZINE RACKS; MEDICINE CABINETS; MIRROR FRAMES; MIRRORED CABINETS; MIRRORS; NIGHT TABLES; NIGHTSTANDS; NON-METAL CABINET DOOR CATCHES; NON-METAL DOOR HANDLES; NON-METAL DOOR TRIMS; NON-METAL HINGES; NON-METAL HOOKS; NON-METAL MAIL BOXES; NON-METAL STEP LADDERS; NON-METAL TRESTLES FOR SUPPORTING TABLES; NON-METALLIC CHESTS; OCCASIONAL TABLES; OFFICE ARMCHAIRS; OFFICE CHAIRS; OFFICE DESKS; OFFICE FURNITURE; OFFICE SEATS; OFFICE TABLES; OUTDOOR FURNITURE; PICTURE AND PHOTOGRAPH FRAMES; PICTURE FRAME MOLDINGS; PICTURE FRAMES; PLACARDS OF WOOD OR PLASTIC; PORCH SWINGS; ROCKING CHAIRS; SEATS; SETTEES; SHELVES; SHELVES FOR BOOKS; SHELVES FOR STORAGE; SHOE CABINETS; SHOWSHELVES; SIDEBOARDS; SOFAS; TABLE TOPS; TABLES; TEA TABLES; STORAGE AND ORGANIZATION SYSTEMS COMPRISING SHELVES, DRAWERS, CUPBOARDS, BASKETS AND CLOTHES RODS, SOLD AS A UNIT; TOWEL CLOSETS; TOWEL STANDS; TOY BOXES AND CHESTS; TRESTLE TABLES; WALL-MOUNTED GUN RACKS; WINDOW FITTINGS, NOT OF METAL; WINE RACKS; WOOD BEDSTEADS; WOOD BOXES; WOOD CARVINGS; WOOD CHOPPING BLOCK TABLES; WOOD DOOR-KNOBS; WOOD KNOBS; WOODEN BEDS; WOODEN HOLDERS FOR SIGNBOARDS; WORK BENCHES; WORK SURFACES; WORKTOPS; WRITING DESKS (U.S. CLS. 2, 13, 22, 25, 32 AND 50).

RUDY R. SINGLETON, EXAMINING ATTORNEY

SN 77-362,007. ADAMS, EUGENE E. III, BEVERLY HILLS, CA. FILED 12-31-2007.



OWNER OF U.S. REG. NO. 3,357,456.
 THE COLOR(S) RED WHITE BLACK AND BLUE IS/ARE CLAIMED AS A FEATURE OF THE MARK.
 THE MARK CONSISTS OF THE DESIGN OF A BLUE GRADUATION CAP OVER TWO RED "M'S" OUTLINED IN BLUE SEPARATED BY TWO CROSSING WHITE DIPLOMAS OUTLINED IN BLACK AND WITH A BLUE RIBBON TIED AROUND THEM THAT FORM THE LETTER "V". BELOW THE DESIGN AND LETTERS IS THE WORDING "MOST VALUABLE MAJORS" IN THE COLOR BLUE.

CLASS 16—PAPER GOODS AND PRINTED MATTER

FOR PRINTED AND RELATED MATTER, NAMELY, STATIONERY, GREETING CARDS, BOOKMARKS, MANUALS AND HANDBOOKS IN THE FIELD OF CAREER EXPLORATION AND LEADERSHIP FOR USE IN CLASSES, PRESENTATIONS, TRAINING, RETREATS, AND WORKSHOPS; POSTERS, CALENDARS, TEMPORARY TATTOOS, STICKERS, BUMPER STICKERS, DECALS, PASSPORT HOLDERS, NOTE CARDS, POSTCARDS, PLACE CARDS, RECORD CARDS, SCORE CARDS, TRADING CARDS, SCRAPBOOKS, GIFT WRAP PAPER, PAPER GIFT BAGS, NOTE PADS, PAPER NOTE TABLETS, WRITING TABLETS AND PAPER, NOTEBOOKS, FOLDERS, PAPER PENNANTS, BINDERS, ENVELOPES, APPOINTMENT BOOKS, ADDRESS BOOKS AND DESK PADS; PERSONAL ORGANIZERS, DESK TOP ORGANIZERS, ORGANIZERS FOR STATIONERY USE AND STATIONERY-TYPE PORTFOLIOS, PAPER FLAGS, MOUNTS FOR STAMPS, RUBBER STAMPS, RUBBER DOCUMENT STAMPS, STAMP ALBUMS, STAMP PAD INKS, STAMP PADS, SLEEVES FOR HOLDING AND PROTECTING STAMPS, PAPER BANNERS, HOLDERS FOR DESK ACCESSORIES, LETTER OPENERS, LETTER TRAYS, LETTER RACKS, PEN AND PENCIL CUPS HOLDERS, PENS, PENCILS, MARKERS, PEN AND PENCIL SETS COMPRISED OF PENS, PENCILS AND CARRYING CASES, STICK MARKERS, ERASERS, DRAWING AND DRAFTING RULERS, PENCIL SHARPENERS, BOOK ENDS, BOOK COVERS, CHECKBOOK COVERS, BOOK HOLDERS, PHOTOGRAPH AND COIN ALBUMS; PHOTOGRAPHIC AND ART MOUNTS; PHOTOGRAPHIC PRINTS; PHOTOGRAPHS; LITHOGRAPHS; DECORATIVE PAPER CENTERPIECES; DECORATIVE PENCIL-TOP ORNAMENTS; PICTURE BOOKS; PAPER AND CARDBOARD PICTURE MOUNTS; PAPERWEIGHTS; PAPER CLIP HOLDERS; PAPER SIGN HOLDERS; PRINTED PAPER SIGNS; TABLE CLOTHS OF PAPER; CATALOGS AND BROCHURES FEATURING CLOTHING, BAGS, SCHOOL SUPPLIES AND OFFICE SUPPLIES (U.S. CLS. 2, 5, 22, 23, 29, 37, 38 AND 50).

CLASS 25—CLOTHING

FOR CLOTHING, NAMELY, SHIRTS, JACKETS, COATS, BELTS; DENIMS; DRESS SHIRTS; HATS; CAPS; JOGGING PANTS; PANTS; POLO SHIRTS; SHOES; SHORT SETS; SHORT-SLEEVED OR LONG-SLEEVED T-SHIRTS; SPORT SHIRTS; SPORTS SHIRTS WITH SHORT SLEEVES; SWEAT SHIRTS; T-SHIRTS; TANK TOPS, TRACK PANTS; JERSEYS; JEANS (U.S. CLS. 22 AND 39).

CLASS 41—EDUCATION AND ENTERTAINMENT

FOR EDUCATIONAL AND ENTERTAINMENT SERVICES, NAMELY, PROVIDING INFORMATION ABOUT EDUCATION RELATED TO HIGH SCHOOLS AND COLLEGES, ENTERTAINMENT INFORMATION, AND INFORMATION ABOUT ACADEMIC COMPETITIONS AND CONTESTS VIA A GLOBAL COMPUTER NETWORK, AND WIRELESS AND MOBILE DEVICES; EDUCATIONAL AND ENTERTAINMENT SERVICES, NAMELY, PROVIDING A WEB SITE FEATURING VIDEO CLIPS OF ACADEMIC COMPETITIONS; PROVIDING INFORMATION ON EDUCATION VIA WEB CAM FEEDS; ENTERTAINMENT SERVICES, NAMELY, PROVIDING ON-LINE COMPUTER AND VIDEO GAMES, AND PROVIDING ENTERTAINMENT AND ACADEMIC COMPETITION RELATED NEWS VIA A GLOBAL COMPUTER NETWORK AND WIRELESS NETWORKS; ARRANGING AND CONDUCTING ACADEMIC COMPETITIONS; EDUCATIONAL AND TRAINING SERVICES, NAMELY CONDUCTING CLASSES, SEMINARS, CONFERENCES AND WORKSHOPS IN THE FIELD OF CAREER EXPLORATION AND LEADERSHIP, AND DISTRIBUTING COURSE MATERIALS, CONSISTING OF BOOKS, AUDIO COMPACT DISCS, VIDEO RECORDINGS IN CONNECTION THEREWITH (U.S. CLS. 100, 101 AND 107).

JEFFERY COWARD, EXAMINING ATTORNEY

SN 77-362,162. RICHARDSON, KEVIN MICHAEL, BECKLEY, WV. FILED 12-31-2007.



Bless ur Feet & Co.

THE COLOR(S) BLACK IS/ARE CLAIMED AS A FEATURE OF THE MARK.
 THE MARK CONSISTS OF THE WORDING "BLESS UR FEET CO." AND A STYLIZED AMPERSAND THAT APPEARS BETWEEN "FEET" AND "CO.", A STYLIZED LETTER "B" WITH A HALO ABOVE IT AND STYLIZED WINGS ATTACHED TO THE LETTER "B".

CLASS 18—LEATHER GOODS

FOR HANDBAGS, PURSES AND WALLETS (U.S. CLS. 1, 2, 3, 22 AND 41).

CLASS 25—CLOTHING

FOR CAPS; COATS FOR MEN AND WOMEN; FOOTWEAR FOR MEN AND WOMEN; SHIRTS; DRESSES; PANTS; JEANS (U.S. CLS. 22 AND 39).
 EDWARD NELSON, EXAMINING ATTORNEY

SN 77-364,086. DEBORAH POPELY & COMPANY, INC., DES PLAINES, IL. FILED 1-4-2008.

SN 77-366,217. ECKERD FAMILY FOUNDATION, CLEARWATER, FL. FILED 1-8-2008.

THE BAMBOOTH

THE MARK CONSISTS OF STANDARD CHARACTERS WITHOUT CLAIM TO ANY PARTICULAR FONT, STYLE, SIZE, OR COLOR.

CLASS 19—NON-METALLIC BUILDING MATERIALS

FOR PORTABLE TRADE SHOW DISPLAY BOOTH STRUCTURES, COMPOSED OF RENEWABLE BAMBOO AND RECYCLED METAL, PRIMARILY OF RENEWABLE BAMBOO FOR USE AT EXHIBITS (U.S. CLS. 1, 12, 33 AND 50).

CLASS 20—FURNITURE AND ARTICLES NOT OTHERWISE CLASSIFIED

FOR FREE-STANDING PANEL UNITS FOR EXHIBITIONS, DISPLAYS AND PARTITIONS, COMPOSED OF RENEWABLE BAMBOO AND RECYCLED METAL, PRIMARILY OF RENEWABLE BAMBOO (U.S. CLS. 2, 13, 22, 25, 32 AND 50).

ODESSA BIBBINS, EXAMINING ATTORNEY

SN 77-365,659. IMPORTADORA OCCIDENTAL, S.A., ZONA LIBRE DE COLON, PANAMA, FILED 1-7-2008.

AIR EXPRESS

THE MARK CONSISTS OF STANDARD CHARACTERS WITHOUT CLAIM TO ANY PARTICULAR FONT, STYLE, SIZE, OR COLOR.

OWNER OF U.S. REG. NO. 1,702,813.

CLASS 9—ELECTRICAL AND SCIENTIFIC APPARATUS

FOR BAGS, NAMELY, LAPTOP BAGS (U.S. CLS. 21, 23, 26, 36 AND 38).

CLASS 18—LEATHER GOODS

FOR BAGS, NAMELY, ALL PURPOSE ATHLETIC BAGS, BACKPACKS, HIKING BAGS, TROLLEY BAGS, NAMELY, WHEELED BAGS, BOOK BAGS, SCHOOL BAGS, BRIEFCASES, ALL PURPOSE CARRYING BAGS, DUFFEL BAGS, GYM BAGS, OVERNIGHT BAGS, SHOULDER BAGS, WAIST PACKS, PURSES, HANDBAGS, WALLETS, TOTE BAGS, TRAVEL BAGS, DIAPER BAGS AND GARMENT BAGS FOR TRAVEL, MADE OF LEATHER OR NON-LEATHER MATERIALS; MULTI-PURPOSE BAGS MADE OF LEATHER; AND LEATHER AND IMITATION LEATHER BAGS (U.S. CLS. 1, 2, 3, 22 AND 41).

GEORGE LORENZO, EXAMINING ATTORNEY

Cby25

THE MARK CONSISTS OF STANDARD CHARACTERS WITHOUT CLAIM TO ANY PARTICULAR FONT, STYLE, SIZE, OR COLOR.

CLASS 16—PAPER GOODS AND PRINTED MATTER

FOR PRINTED INSTRUCTIONAL AND TEACHING MATERIALS, ALL OF THE FOREGOING FEATURING EFFECTIVE STRATEGIES FOR THE IMPLEMENTATION OF LAWS AND POLICIES SERVING TRANSITIONING YOUTH IN FOSTER CARE AND JUVENILE JUSTICE SYSTEMS, AND FEATURING ASSESSMENT AND EVALUATION TOOLS TO REVIEW THE FEASIBILITY AND SUSTAINABILITY OF EXISTING PROGRAMS AND RESOURCES IN INDEPENDENT LIVING SERVICES AND TRANSITIONING YOUTH PROGRAMS (U.S. CLS. 2, 5, 22, 23, 29, 37, 38 AND 50).

CLASS 35—ADVERTISING AND BUSINESS

FOR PROMOTING THE INTERESTS OF PEOPLE INVOLVED AND CONCERNED WITH YOUTH PROGRAMS, NAMELY, NATIONAL, STATE AND LOCAL CHILD WELFARE AGENCIES, PROVIDERS OF FOSTER CARE SERVICES, PROVIDERS OF JUVENILE JUSTICE PROGRAMS, COMMUNITY BASED AGENCIES SERVING AT-RISK YOUTH, CHILD WELFARE GROUPS AND ORGANIZATIONS SERVING THE LEGAL INTERESTS OF AT-RISK YOUTH INCLUDING THOSE YOUTH INVOLVED IN THE FOSTER CARE SYSTEM AND JUVENILE JUSTICE SYSTEM; COUNSELING SERVICES TO COMMUNITY BASED YOUTH CARE AGENCIES, JUVENILE JUSTICE AND CHILD WELFARE STAFF, COURTS AND YOUTH-SERVING AGENCIES TO DEVELOP, DESIGN, IMPLEMENT, AND MANAGE PROGRAMS IN THE FIELD OF EMPLOYMENT RECRUITING FOR THE PURPOSE OF HELPING YOUTH TRANSITION FROM FOSTER CARE AND THE JUVENILE JUSTICE SYSTEM TO ADULTHOOD; COUNSELING SERVICES TO FOSTER CARE YOUTH AND YOUTH ADULTS TO ACHIEVE ECONOMIC SUCCESS AS THEY TRANSITION TO INDEPENDENCE, NAMELY, EMPLOYMENT COUNSELING (U.S. CLS. 100, 101 AND 102).

CLASS 36—INSURANCE AND FINANCIAL

FOR DEBIT COUNSELING; COUNSELING SERVICES TO COMMUNITY BASED YOUTH CARE AGENCIES, JUVENILE JUSTICE AND CHILD WELFARE STAFF, COURTS AND YOUTH-SERVING AGENCIES TO DEVELOP, DESIGN, IMPLEMENT, AND MANAGE PROGRAMS IN THE FIELD OF FINANCIAL PLANNING, NAMELY, THE CREATION OF PERSONALIZED STRATEGIES CONCERNING MONEY AND ASSET MANAGEMENT TO ACHIEVE FINANCIAL INDEPENDENCE AND PROVIDING DIRECT FINANCIAL ASSISTANCE TO JUVENILES THROUGH THE ESTABLISHMENT OF MATCHED SAVINGS ACCOUNTS FOR THE PURPOSE OF HELPING YOUTH TRANSITION FROM FOSTER CARE AND THE JUVENILE JUSTICE SYSTEM TO ADULTHOOD (U.S. CLS. 100, 101 AND 102).

CLASS 41—EDUCATION AND ENTERTAINMENT

FOR EDUCATIONAL SERVICES, NAMELY, PROVIDING LECTURES, CLASSES, SEMINARS AND WORKSHOPS TO COMMUNITY BASED YOUTH CARE AGENCIES, JUVENILE JUSTICE AND CHILD WELFARE STAFF, COURTS, CERTIFIED YOUTH TRAINERS, AND YOUTH-SERVING AGENCIES IN THE FIELD OF EFFECTIVE STRATEGIES FOR THE IMPLEMENTATION OF LAWS AND POLICIES SERVING TRANSITIONING YOUTH IN FOSTER CARE AND JUVENILE JUSTICE SYSTEMS; EDUCATIONAL SERVICES, NAMELY, PROVIDING CLASSES, WORKSHOPS, LECTURES, AND SEMINARS TO FOSTER CARE YOUTH AND YOUTH ADULTS IN THE FIELD OF FINANCIAL LITERACY; COUNSELING SERVICES TO FOSTER CARE YOUTH AND YOUTH ADULTS TO ACHIEVE ECONOMIC SUCCESS AS THEY TRANSITION TO INDEPENDENCE, NAMELY, JOB SKILLS COUNSELING, AND CAREER DEVELOPMENT COUNSELING; COUNSELING SERVICES TO COMMUNITY BASED YOUTH CARE AGENCIES, JUVENILE JUSTICE AND CHILD WELFARE STAFF, COURTS AND YOUTH-SERVING AGENCIES TO DEVELOP, DESIGN, IMPLEMENT, AND MANAGE EDUCATIONAL PROGRAMS IN THE FIELD OF FINANCIAL LITERACY (U.S. CLS. 100, 101 AND 107).

SN 77-366,939. SHAUNA BLYTHE BURKE INC., BROOKLYN, NY. FILED 1-8-2008.

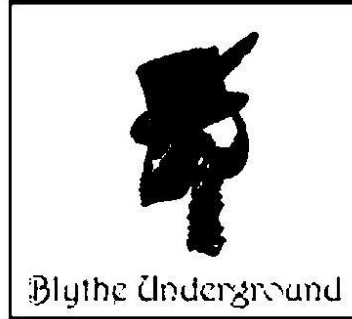

THE MARK CONSISTS OF A PROFILE OF A SKELETON HEAD WEARING A FEDORA WITH A FEATHER, AND THE STYLIZED TEXT "BLYTHE UNDERGROUND" INSIDE A RECTANGLE.

CLASS 14—JEWELRY

FOR JEWELRY (U.S. CLS. 2, 27, 28 AND 50).

CLASS 18—LEATHER GOODS

FOR WALLETS (U.S. CLS. 1, 2, 3, 22 AND 41).

CLASS 25—CLOTHING

FOR CLOTHING, NAMELY, SHIRTS, SHORTS, SWEATSHIRTS, DRESSES, TOPS, BOTTOMS, UNDERGARMENTS, PAJAMAS, BELTS, GLOVES, SCARVES, HATS, AND FOOTWEAR (U.S. CLS. 22 AND 39).

KATHERINE M. DUBRAY, EXAMINING ATTORNEY

CLASS 44—MEDICAL, BEAUTY AND AGRICULTURAL SERVICES

FOR PROVIDING WELLNESS SERVICES, NAMELY, PERSONAL ASSESSMENTS, PERSONALIZED ROUTINES, MAINTENANCE SCHEDULES AND PSYCHOLOGICAL COUNSELING (U.S. CLS. 100 AND 101).

SN 77-368,782. CSX IA, INC., JACKSONVILLE, FL. FILED 1-10-2008.



OWNER OF U.S. REG. NOS. 1,978,470 AND 2,754,408. NO CLAIM IS MADE TO THE EXCLUSIVE RIGHT TO USE "WHITE SULPHUR SPRINGS" AND "WEST VIRGINIA", APART FROM THE MARK AS SHOWN.

THE MARK CONSISTS OF THE "GREENBRIER" AND SPRINGHOUSE ENCIRCLED WITH THE WORDS "WHITE SULPHUR SPRINGS WEST VIRGINIA".

CLASS 45—PERSONAL AND LEGAL SERVICES

FOR REVIEWING STANDARDS AND PRACTICES TO ASSURE COMPLIANCE WITH FEDERAL, STATE AND LOCAL LAWS THAT GOVERN SERVICES TO YOUTH IDENTIFIED AS DEPENDENT OR DELINQUENT AND INVOLVED IN THE FOSTER CARE SYSTEM AND/OR THE JUVENILE JUSTICE SYSTEM; COUNSELING SERVICES TO COMMUNITY BASED YOUTH CARE AGENCIES, JUVENILE JUSTICE AND CHILD WELFARE STAFF, COURTS AND YOUTH-SERVING AGENCIES TO DEVELOP, DESIGN, IMPLEMENT, AND MANAGE PROGRAMS IN THE FIELD OF PROVIDING PERSONAL EMOTIONAL SUPPORT SERVICES FOR TROUBLED AND AT-RISK YOUTH TRANSITIONING FROM FOSTER CARE AND THE JUVENILE JUSTICE SYSTEM TO ADULTHOOD (U.S. CLS. 100 AND 101).

SUSAN STIGLITZ, EXAMINING ATTORNEY

CLASS 16—PAPER GOODS AND PRINTED MATTER

FOR PAPERWEIGHTS, DESKTOP BUSINESS CARD HOLDERS, LEATHER MONEY CLIPS (U.S. CLS. 2, 5, 22, 23, 29, 37, 38 AND 50).
FIRST USE 1-1-1986; IN COMMERCE 1-1-1986.

CLASS 18—LEATHER GOODS

FOR WALLETS, BUSINESS CARD CASES, LEATHER LUGGAGE TAGS, GOLF SHOE BAGS FOR TRAVEL (U.S. CLS. 1, 2, 3, 22 AND 41).
FIRST USE 1-1-1986; IN COMMERCE 1-1-1986.

CLASS 21—HOUSEWARES AND GLASS

FOR COASTERS NOT OF PAPER AND NOT BEING TABLE LINEN, WINE GLASSES, DRINKING GLASSES, MUGS (U.S. CLS. 2, 13, 23, 29, 30, 33, 40 AND 50).
FIRST USE 1-1-1986; IN COMMERCE 1-1-1986.

CLASS 28—TOYS AND SPORTING GOODS

FOR GOLF BALL MARKERS, GOLF DIVOT REPAIR TOOLS (U.S. CLS. 22, 23, 38 AND 50).
FIRST USE 1-1-1986; IN COMMERCE 1-1-1986.
TRACY CROSS, EXAMINING ATTORNEY

SN 77-384,317. ITG SOFTWARE SOLUTIONS, INC., CULVER CITY, CA. FILED 1-30-2008.



OWNER OF U.S. REG. NOS. 2,581,518, 3,039,653 AND OTHERS.

NO CLAIM IS MADE TO THE EXCLUSIVE RIGHT TO USE "GROUP", APART FROM THE MARK AS SHOWN.

THE MARK CONSISTS OF THE WORDING "ITG" WITH THE WORDS "INVESTMENT TECHNOLOGY GROUP" TO THE RIGHT. ABOVE THE "ITG" ARE TWO CURVED BANDS.

SEC. 2(F) AS TO "INVESTMENT TECHNOLOGY GROUP"..

CLASS 9—ELECTRICAL AND SCIENTIFIC APPARATUS

FOR COMPUTER PROGRAMS FOR USE IN MANAGING AND PROVIDING SECURITIES BROKERAGE, TRADING AND TRADING STRATEGIES; DOWNLOADABLE COMPUTER APPLICATIONS OFFERED VIA THE GLOBAL COMPUTER NETWORK FOR USE IN FORECASTING OF FINANCIAL COSTS; COMPUTER PROGRAMS THAT COLLECT AND ANALYZE SECURITIES TRADING DATA AND EXECUTE AUTOMATED SECURITIES TRADES FOR INSTITUTIONAL INVESTORS, MONEY MANAGERS, PENSION FUND MANAGERS, BROKER DEALERS AND INSTITUTIONS; DOWNLOADABLE COMPUTER PROGRAMS FOR USE BY PROFESSIONAL TRADERS, NAMELY, COMPUTER PROGRAMS THAT PROVIDE REAL-TIME AND HISTORICAL COST ANALYSIS OF THE TRADING PERFORMANCE OF SECURITIES BY COMPARING TRADING PRICES TO USER DEFINED INFORMATION (U.S. CLS. 21, 23, 26, 36 AND 38).

FIRST USE 9-12-2006; IN COMMERCE 9-12-2006.

CLASS 36—INSURANCE AND FINANCIAL

FOR FINANCIAL INVESTMENT SERVICES IN THE FIELD OF COMMODITIES, SECURITIES, STOCKS, AND BONDS RENDERED VIA A GLOBAL COMPUTER NETWORK; FINANCIAL SERVICES IN THE NATURE OF PROVIDING ELECTRONIC TRADING SERVICES FOR THE PURPOSE OF TRADING COMMODITIES, STOCKS, BONDS AND SECURITIES; PROVIDING AND MANAGING AUTOMATED SECURITIES BROKERAGE, TRADING AND TRADING STRATEGIES; INVESTMENT AND FINANCIAL MANAGEMENT CONSULTING SERVICES; COMPUTERIZED STOCK BROKERAGE SERVICES; FINANCIAL SERVICES, NAMELY, MANAGING FINANCIAL PORTFOLIO TRADES; TRADING SERVICES, NAMELY, ELECTRONIC TRADING IN EQUITIES, STOCKS, BONDS, OPTIONS, AND MUTUAL FUNDS FOR OTHERS, AND BROKERAGE SERVICES, NAMELY, INSURANCE BROKERAGE, INVESTMENT BROKERAGE, MUTUAL FUND BROKERAGE, SECURITY BROKERAGE (U.S. CLS. 100, 101 AND 102).

FIRST USE 9-12-2006; IN COMMERCE 9-12-2006.

CLASS 38—COMMUNICATION

FOR TELECOMMUNICATIONS SERVICES FOR THE SECURITIES INDUSTRY, NAMELY, ROUTING (U.S. CLS. 100, 101 AND 104).

FIRST USE 9-12-2006; IN COMMERCE 9-12-2006.
GIANCARLO CASTRO, EXAMINING ATTORNEY

SN 77-373,937. INSIDER PAGES, INC., SAN FRANCISCO, CA. FILED 1-17-2008.

INSIDER PAGES

THE MARK CONSISTS OF STANDARD CHARACTERS WITHOUT CLAIM TO ANY PARTICULAR FONT, STYLE, SIZE, OR COLOR.

OWNER OF U.S. REG. NO. 3,071,526.

NO CLAIM IS MADE TO THE EXCLUSIVE RIGHT TO USE "PAGES", APART FROM THE MARK AS SHOWN.

CLASS 35—ADVERTISING AND BUSINESS

FOR ONLINE BUSINESS DIRECTORIES FEATURING LISTINGS, DESCRIPTIONS, COUPONS AND REVIEWS FOR A WIDE RANGE OF BUSINESSES IN PARTICULAR GEOGRAPHIC AREAS (U.S. CLS. 100, 101 AND 102).
FIRST USE 3-16-2004; IN COMMERCE 3-16-2004.

CLASS 36—INSURANCE AND FINANCIAL

FOR PROVIDING CHARITABLE FUND RAISING PROGRAMS FOR USE BY OTHERS (U.S. CLS. 100, 101 AND 102).

FIRST USE 1-0-2006; IN COMMERCE 1-0-2006.
RAUL CORDOVA, EXAMINING ATTORNEY

SN 77-384,968. BUG REALTY, LLC, CORONADO, CA. FILED 1-31-2008.



The logo for "moxy SPORTS" features the word "moxy" in a lowercase, bold, black sans-serif font. To its right, the word "SPORTS" is in a white, uppercase, bold, sans-serif font, enclosed within a blue rounded rectangular background.

NO CLAIM IS MADE TO THE EXCLUSIVE RIGHT TO USE "SPORTS", APART FROM THE MARK AS SHOWN.

THE COLOR(S) GRAY, WHITE AND BLUE IS/ARE CLAIMED AS A FEATURE OF THE MARK.

THE MARK CONSISTS OF THE COLOR GRAY IN THE WORD "MOXY", THE COLOR WHITE IN THE WORD "SPORTS" AND THE COLOR BLUE IN THE SQUARE BACKGROUND OF THE WORD "SPORTS".

CLASS 25—CLOTHING

FOR CLOTHING, NAMELY, JACKETS, T-SHIRTS AND PANTS (U.S. CLS. 22 AND 39).

CLASS 38—COMMUNICATION

FOR BROADCASTING SERVICES, NAMELY, INTERNET BROADCASTING, TELEVISION BROADCASTING, AUDIO BROADCASTING AND VIDEO BROADCASTING (U.S. CLS. 100, 101 AND 104).

JENNY PARK, EXAMINING ATTORNEY

SN 77-386,590. ITG SOFTWARE SOLUTIONS, INC., CULVER CITY, CA. FILED 2-1-2008.



The logo for "ITG INVESTMENT TECHNOLOGY GROUP" features the letters "ITG" in a large, blue, serif font. Above the "ITG" are two curved bars, one green and one blue. To the right of "ITG" is the text "INVESTMENT TECHNOLOGY GROUP" in a smaller, blue, sans-serif font.

OWNER OF U.S. REG. NOS. 2,581,518, 3,039,653 AND OTHERS.

NO CLAIM IS MADE TO THE EXCLUSIVE RIGHT TO USE "GROUP", APART FROM THE MARK AS SHOWN.

THE COLOR(S) BLUE AND GREEN IS/ARE CLAIMED AS A FEATURE OF THE MARK.

THE MARK CONSISTS OF BLUE APPEARING IN THE WORDING "ITG" AND "INVESTMENT TECHNOLOGY GROUP". ABOVE "ITG" AND "INVESTMENT TECHNOLOGY GROUP" ARE CURVED BARS, ONE GREEN AND THE OTHER BAR IS BLUE.

SEC. 2(F) AS TO "INVESTMENT TECHNOLOGY GROUP".

CLASS 9—ELECTRICAL AND SCIENTIFIC APPARATUS

FOR COMPUTER PROGRAMS FOR USE IN MANAGING AND PROVIDING SECURITIES BROKERAGE, TRADING AND TRADING STRATEGIES; DOWNLOADABLE COMPUTER APPLICATIONS OFFERED VIA THE GLOBAL COMPUTER NETWORK FOR USE IN FORECASTING OF FINANCIAL COSTS; COMPUTER PROGRAMS THAT COLLECT AND ANALYZE SECURITIES TRADING DATA AND EXECUTE AUTOMATED SECURITIES TRADES FOR INSTITUTIONAL INVESTORS, MONEY MANAGERS, PENSION FUND MANAGERS, BROKER DEALERS AND INSTITUTIONS; DOWNLOADABLE COMPUTER PROGRAMS FOR USE BY PROFESSIONAL TRADERS, NAMELY, COMPUTER PROGRAMS THAT PROVIDE REAL-TIME AND HISTORICAL COST ANALYSIS OF THE TRADING PERFORMANCE OF SECURITIES BY COMPARING TRADING PRICES TO USER DEFINED INFORMATION (U.S. CLS. 21, 23, 26, 36 AND 38).

CLASS 36—INSURANCE AND FINANCIAL

FOR FINANCIAL INVESTMENT SERVICES IN THE FIELD OF COMMODITIES, SECURITIES, STOCKS, AND BONDS RENDERED VIA A GLOBAL COMPUTER NETWORK; FINANCIAL SERVICES IN THE NATURE OF PROVIDING ELECTRONIC TRADING SERVICES FOR THE PURPOSE OF TRADING COMMODITIES, STOCKS, BONDS AND SECURITIES; PROVIDING AND MANAGING AUTOMATED SECURITIES BROKERAGE, TRADING AND TRADING STRATEGIES; INVESTMENT AND FINANCIAL MANAGEMENT CONSULTING SERVICES; COMPUTERIZED STOCK BROKERAGE SERVICES; FINANCIAL SERVICES, NAMELY, MANAGING FINANCIAL PORTFOLIO TRADES; TRADING SERVICES, NAMELY, ELECTRONIC TRADING IN EQUITIES, STOCKS, BONDS, OPTIONS, AND MUTUAL FUNDS FOR OTHERS, AND BROKERAGE SERVICES, NAMELY, INSURANCE BROKERAGE, INVESTMENT BROKERAGE, MUTUAL FUND BROKERAGE, SECURITY BROKERAGE (U.S. CLS. 100, 101 AND 102).

CLASS 38—COMMUNICATION

FOR TELECOMMUNICATIONS SERVICES FOR THE SECURITIES INDUSTRY, NAMELY, ROUTING (U.S. CLS. 100, 101 AND 104).

GIANCARLO CASTRO, EXAMINING ATTORNEY

SN 77-386,929. BEST MADE DESIGNS, LLC, MONAHANS, TX. FILED 2-1-2008.



The logo for "T.H.E. The Hunter's Essential GEAR" features a stylized silhouette of a deer's antlers with a five-pointed star in the center. Below the antlers, the letters "T.H.E." are written in a large, bold, black, serif font. Underneath "T.H.E." is the text "The Hunter's Essential" in a smaller, black, sans-serif font. At the bottom, the word "GEAR" is written in a very large, bold, black, sans-serif font.

OWNER OF U.S. REG. NOS. 3,153,523 AND 3,192,067.

NO CLAIM IS MADE TO THE EXCLUSIVE RIGHT TO USE "HUNTER'S ESSENTIAL GEAR", APART FROM THE MARK AS SHOWN.

THE MARK CONSISTS OF THE STYLIZED LETTERS "T.H.E." ON A FIRST TEXT LINE, THE WORDS "THE HUNTER'S ESSENTIAL" ON A SECOND TEXT LINE CENTERED THEREBELOW, AND THE WORD "GEAR" ON A THIRD TEXT LINE CENTERED THEREBELOW. A DESIGN COMPRISING ANTLERS EXTENDS UPWARD FROM THE BARS OF THE LETTER "H" IN "T.H.E.", AND A SINGLE, FIVE-POINT STAR IS CENTERED BETWEEN THE ANTLERS ABOVE THE "H". A FIRST HORIZONTAL LINE SEPARATES THE FIRST TEXT LINE FROM THE SECOND, AND A SECOND HORIZONTAL LINE SEPARATES THE SECOND TEXT LINE FROM THE THIRD.

CLASS 11—ENVIRONMENTAL CONTROL APPARATUS

FOR HOLSTERS FOR FLASHLIGHTS (U.S. CLS. 13, 21, 23, 31 AND 34).

CLASS 13—FIREARMS

FOR GUN CASES; CASES FOR CARTRIDGES, AMMUNITION AND AMMUNITION MAGAZINES; POUCHES FOR GUNS, CARTRIDGES, AMMUNITION AND AMMUNITION MAGAZINES; PACKS FOR GUNS, CARTRIDGES, AMMUNITION AND AMMUNITION MAGAZINES; SLINGS FOR RIFLES AND FIREARMS; HOLSTERS (U.S. CLS. 2 AND 9).

CLASS 18—LEATHER GOODS

FOR BACKPACKS, WAIST PACKS, FANNY PACKS, AND RUCKSACKS; FABRIC TRAVEL BAGS, ALL-PURPOSE CARRYING BAGS AND LUGGAGE; SMALL, ALL-PURPOSE BAGS ALL SOLD EMPTY FOR ATTACHMENT TO PANTS, TO JACKETS, TO PACKS AND RUCKSACKS, TO BELTS AND TO VESTS, NAMELY, FABRIC POUCHES, ZIPPERED POUCHES, BUCKLED POUCHES, HOOK AND LOOP POUCHES; TOOL POUCHES SOLD EMPTY; DOCUMENT CASES; VERY SMALL, ALL-PURPOSE BAGS ALL SOLD EMPTY FOR ATTACHMENT TO PANTS, TO JACKETS, TO PACKS AND RUCKSACKS, TO BELTS AND TO VESTS, NAMELY, FABRIC POCKETS, ZIPPERED POCKETS, BUCKLED POCKETS AND HOOK AND LOOP POCKETS; ALL-PURPOSE CARRYING FABRIC PACKS, ACCESSORY ZIPPERED PACKS, ACCESSORY BUCKLED PACKS AND ACCESSORY HOOK AND LOOP PACKS; ADD-ON POUCHES FOR ATTACHMENT TO PACKS, PANTS, BELTS AND WEARABLE LOAD-CARRYING VESTS SOLD EMPTY; ADD-ON POCKETS IN THE NATURE OF SMALL CARRYING POUCHES FOR ATTACHMENT TO PACKS, PANTS, BELTS AND WEARABLE LOAD-CARRYING VESTS SOLD EMPTY; TOOL POUCHES SOLD EMPTY, NAMELY, ADD-ON CARGO POUCHES AND UTILITY POUCHES SOLD EMPTY FOR ATTACHMENT TO PACKS, BELTS AND WEARABLE LOAD-CARRYING VESTS; WALLETS (U.S. CLS. 1, 2, 3, 22 AND 41).

CLASS 25—CLOTHING

FOR CLOTHING, NAMELY, T-SHIRTS, SHIRTS, SWEATSHIRTS, SWEATERS, JACKETS, COATS, HATS, CAPS, SCARVES, SHORTS, PANTS, BELTS, UNDERWEAR AND SOCKS; FOOTWEAR, NAMELY, SHOES, SANDALS AND BOOTS; CARGO VESTS AND FABRIC COVERS FOR VESTS; VEST COVERS INCORPORATING CARRYING EQUIPMENT, NAMELY, CARGO CARRYING STRAPS MOUNTED TO A VEST COVER FOR ATTACHING DETACHABLE POCKETS AND POUCHES; CLOTHING IN THE NATURE OF VEST-LIKE MOLDED PLASTIC OR FABRIC LOAD BEARING PLATFORMS FOR ATTACHING DETACHABLE POCKETS AND POUCHES FOR USE BY HUNTERS, SPORTSMEN AND OUTDOORSMEN (U.S. CLS. 22 AND 39).
AMY HELLA, EXAMINING ATTORNEY

SN 77-387,144. JONES, DERIK T., BRIGHTON, MI. FILED 2-2-2008.

HELLS FOUNDRY

THE MARK CONSISTS OF STANDARD CHARACTERS WITHOUT CLAIM TO ANY PARTICULAR FONT, STYLE, SIZE, OR COLOR.

CLASS 9—ELECTRICAL AND SCIENTIFIC APPARATUS

FOR AUDIO ELECTRONIC EQUIPMENT AND COMPONENTS FOR MOTORCYCLES, NAMELY, AUDIO AMPLIFIERS, AUDIO SPEAKERS, ADAPTERS, ATTACHMENT RADIO TERMINALS, CROSSOVERS, SPEAKER HOUSINGS AND ELECTRICAL CABLES; ELECTRONIC AND COMPUTER DEVICES ENABLED FOR WIRELESS COMMUNICATION, NAMELY, REMOTE CONTROLS FOR LIGHTS AND ELECTRONIC DOOR OPENERS (U.S. CLS. 21, 23, 26, 36 AND 38).
FIRST USE 4-22-2005; IN COMMERCE 8-20-2005.

CLASS 12—VEHICLES

FOR MOTORCYCLE ACCESSORIES, PARTS AND STRUCTURAL AND REPLACEMENT PARTS, NAMELY, SHIFT LINKAGE CONNECTING RODS OTHER THAN PARTS OF MOTORS AND ENGINES, HANDLE BARS, HANDLEBAR RISERS AND STRUCTURAL PARTS THEREOF, CHROME INSTRUMENT FRONT DASH PANELS AS STRUCTURAL PARTS OF MOTORCYCLES, MOTORCYCLE EXTERIOR CHROME METAL DECORATIVE AND PROTECTIVE HEADLIGHT TRIM, MOTORCYCLE EXTERIOR PLASTIC EXTRUDED DECORATIVE AND PROTECTIVE VINYL STRIPE TRIM, SADDLEBAG BRACKET COVERS AS STRUCTURAL PARTS OF MOTORCYCLE SAGGLEBAGS AND FAIRING KITS PRIMARILY COMPRISED OF AERODYNAMIC FAIRINGS FOR MOTORCYCLES (U.S. CLS. 19, 21, 23, 31, 35 AND 44).
FIRST USE 4-22-2005; IN COMMERCE 8-20-2005.

CLASS 25—CLOTHING

FOR MOTORCYCLE CLOTHING, NAMELY, SHIRTS, HALTER TOPS, HATS AND BANDANAS (U.S. CLS. 22 AND 39).
FIRST USE 4-22-2005; IN COMMERCE 8-20-2005.

CLASS 35—ADVERTISING AND BUSINESS

FOR WEB-BASED, RETAIL AND WHOLESALE MAIL ORDER SERVICES FEATURING MOTORCYCLE ACCESSORIES, PARTS, STRUCTURAL AND REPLACEMENT PARTS, AUDIO EQUIPMENT, STORAGE RACKS AND CLOTHING; WEB-BASED AND MAIL ORDER RETAIL STORE AND WHOLESALE STORE SERVICES FEATURING MOTORCYCLE ACCESSORIES, PARTS, STRUCTURAL AND REPLACEMENT PARTS, AUDIO EQUIPMENT, STORAGE RACKS AND CLOTHING (U.S. CLS. 100, 101 AND 102).
FIRST USE 4-25-2005; IN COMMERCE 4-25-2005.
DAVID YONTEF, EXAMINING ATTORNEY

SN 77-387,814. MKD INTERIORS LIMITED, NEW YORK, NY. FILED 2-4-2008.

JAMIE DRAKE

THE MARK CONSISTS OF STANDARD CHARACTERS WITHOUT CLAIM TO ANY PARTICULAR FONT, STYLE, SIZE, OR COLOR.
"JAMIE DRAKE" IDENTIFIES A LIVING INDIVIDUAL WHOSE CONSENT IS OF RECORD.

CLASS 11—ENVIRONMENTAL CONTROL APPARATUS

FOR BATHROOM FIXTURES, NAMELY, FAUCETS AND SHOWER HEADS (U.S. CLS. 13, 21, 23, 31 AND 34).
FIRST USE 4-22-2006; IN COMMERCE 4-22-2006.

CLASS 20—FURNITURE AND ARTICLES NOT OTHERWISE CLASSIFIED

FOR TOWEL RACKS, PLASTIC TISSUE BOX COVERS, FURNITURE, NAMELY, TABLES, CHAIRS, SOFAS, CHESTS, MIRRORS AND ARMOIRES (U.S. CLS. 2, 13, 22, 25, 32 AND 50).

FIRST USE 5-18-2006; IN COMMERCE 5-18-2006.

CLASS 21—HOUSEWARES AND GLASS

FOR BATH ACCESSORIES, NAMELY, CERAMIC TISSUE BOX COVERS, WASTE BASKETS, SOAP DISHES, SOAP DISPENSERS, VANITY TRAYS AND BATH CUPS (U.S. CLS. 2, 13, 23, 29, 30, 33, 40 AND 50).

FIRST USE 5-18-2006; IN COMMERCE 5-18-2006.

CLASS 24—FABRICS

FOR FABRICS FOR TEXTILE USE (U.S. CLS. 42 AND 50).

FIRST USE 4-24-2007; IN COMMERCE 4-24-2007.

CLASS 26—FANCY GOODS

FOR BATH ACCESSORIES, NAMELY, FABRIC AND/OR TEXTILE TISSUE BOX COVERS (U.S. CLS. 37, 39, 40, 42 AND 50).

FIRST USE 5-18-2006; IN COMMERCE 5-18-2006.

CLASS 27—FLOOR COVERINGS

FOR RUGS AND CARPETS (U.S. CLS. 19, 20, 37, 42 AND 50).

FIRST USE 9-23-2003; IN COMMERCE 9-23-2003.

LINDA M. KING, EXAMINING ATTORNEY

SN 77-388,021. MKD INTERIORS LIMITED, NEW YORK, NY. FILED 2-4-2008.



THE MARK CONSISTS OF THE STYLIZED LETTERS J AND D.

CLASS 11—ENVIRONMENTAL CONTROL APPARATUS

FOR BATHROOM FIXTURES, NAMELY, FAUCETS AND SHOWER HEADS (U.S. CLS. 13, 21, 23, 31 AND 34).

FIRST USE 4-22-2006; IN COMMERCE 4-22-2006.

CLASS 20—FURNITURE AND ARTICLES NOT OTHERWISE CLASSIFIED

FOR TOWEL RACKS, PLASTIC TISSUE BOX COVERS, FURNITURE, NAMELY, TABLES, CHAIRS, SOFAS, CHESTS, MIRRORS AND ARMOIRES (U.S. CLS. 2, 13, 22, 25, 32 AND 50).

FIRST USE 5-18-2006; IN COMMERCE 5-18-2006.

CLASS 21—HOUSEWARES AND GLASS

FOR BATH ACCESSORIES, NAMELY, CERAMIC TISSUE BOX COVERS, WASTE BASKETS, SOAP DISHES, SOAP DISPENSERS, VANITY TRAYS AND BATH CUPS (U.S. CLS. 2, 13, 23, 29, 30, 33, 40 AND 50).

FIRST USE 5-18-2006; IN COMMERCE 5-18-2006.

CLASS 24—FABRICS

FOR FABRICS FOR TEXTILE USE (U.S. CLS. 42 AND 50).

FIRST USE 4-24-2007; IN COMMERCE 4-24-2007.

CLASS 26—FANCY GOODS

FOR BATH ACCESSORIES, NAMELY, FABRIC AND/OR TEXTILE TISSUE BOX COVERS (U.S. CLS. 37, 39, 40, 42 AND 50).

FIRST USE 5-18-2006; IN COMMERCE 5-18-2006.

CLASS 27—FLOOR COVERINGS

FOR RUGS AND CARPETS (U.S. CLS. 19, 20, 37, 42 AND 50).

FIRST USE 9-23-2003; IN COMMERCE 9-23-2003.

LINDA M. KING, EXAMINING ATTORNEY

SN 77-388,993. GAL PALS, LLC, PALM COAST, FL. FILED 2-5-2008.



THE COLOR(S) BLACK, WHITE, PINK, YELLOW, BLUE, LAVENDAR, GREY, LIGHT BROWN IS/ARE CLAIMED AS A FEATURE OF THE MARK.

THE MARK CONSISTS OF STYLIZED VISUALIZATION OF SEXY GIRL WITH PINK LIPS ON PINK BICYCLE WITH BLUE AND LAVENDAR WHEELS AND SPOKES; SEXY GIRL WITH LIGHT BROWN HAIR DRESSED IN PINK DRESS WITH LAVENDR BELT, WEARING YELLOW HAT WITH GREY BAND, PINK BRACELET, WHITE BRACELET AND WHITE RING AND WHITE STOCKINGS AND SHOES ALL OUTLINED IN BLACK.

CLASS 16—PAPER GOODS AND PRINTED MATTER

FOR PRINTED MATTER, NAMELY, A SERIES OF WRITTEN ARTICLES FOR RE-PUBLICATION BY OTHERS IN BOOKLETS, BROCHURES, CATALOGS AND DIRECTORIES FEATURING CULTURE, CURRENT EVENTS, HUMAN INTEREST, HUMOR, LIFESTYLE, RELATIONSHIPS AND SPIRITUALITY; MAGAZINES, MANUALS, NEWSLETTERS, NEWSPAPERS, PAMPHLETS AND PERIODICALS FEATURING CULTURE, CURRENT EVENTS, HUMAN INTEREST, HUMOR, LIFESTYLE, RELATIONSHIPS AND SPIRITUALITY; AGENDAS, ALBUMS FOR PHOTOS, STAMPS AND COINS, BUSINESS CARDS, BOOKMARKS, CALENDARS, DESK DIARIES; PHOTOGRAPHS; PRINTED GREETING CARDS; PRINTED EDUCATIONAL, INSTRUCTIONAL AND TEACHING MATERIALS FEATURING CULTURE, CURRENT EVENTS, HUMAN INTEREST, HUMOR, LIFESTYLE, RELATIONSHIPS AND SPIRITUALITY; PROMOTIONAL POSTCARDS AND POSTERS; SERIES OF NON-FICTION BOOKS FEATURING CULTURE, CURRENT EVENTS, HUMAN INTEREST, HUMOR, LIFESTYLE, RELATIONSHIPS AND SPIRITUALITY; STATIONERY, NAMELY, LETTERHEAD PAPER AND ENVELOPES, NOTE PADS, STATIONERY DOCUMENT COVERS, FOLDERS AND STICKERS; PENS AND PENCILS (U.S. CLS. 2, 5, 22, 23, 29, 37, 38 AND 50).

CLASS 35—ADVERTISING AND BUSINESS

FOR RETAIL STORE, WHOLESALE ORDERING, MAIL-ORDER CATALOG AND ONLINE RETAIL STORE SERVICES FEATURING A WIDE VARIETY OF CONSUMER GOODS OF OTHERS (U.S. CLS. 100, 101 AND 102).

SALLY SHIH, EXAMINING ATTORNEY

SN 77-389,133. CATAWBA LANDS CONSERVANCY, CHARLOTTE, NC. FILED 2-5-2008.



NO CLAIM IS MADE TO THE EXCLUSIVE RIGHT TO USE "CAROLINA" AND "TRAIL", APART FROM THE MARK AS SHOWN.

THE MARK CONSISTS OF A QUILT PATTERN IN A CIRCULAR DESIGN ABOVE THE WORDS "CAROLINA THREAD TRAIL".

CLASS 35—ADVERTISING AND BUSINESS

FOR ASSISTANCE, ADVISORY SERVICES, AND CONSULTANCY WITH REGARD TO PROMOTING PUBLIC AWARENESS OF GREENWAYS, TRAILS, AND WALKWAYS (U.S. CLS. 100, 101 AND 102).

FIRST USE 12-1-2007; IN COMMERCE 12-1-2007.

CLASS 36—INSURANCE AND FINANCIAL

FOR PROVIDING GRANTS RELATED TO GREENWAYS, TRAILS, AND WALKWAYS; CHARITABLE FUND RAISING RELATED TO GREENWAYS, TRAILS, AND WALKWAYS (U.S. CLS. 100, 101 AND 102).

FIRST USE 12-1-2007; IN COMMERCE 12-1-2007.

ANNE E. GUSTASON, EXAMINING ATTORNEY

SN 77-390,274. CITY NATIONAL BANK, BEVERLY HILLS, CA. FILED 2-6-2008.

CITY NATIONAL EXPRESS LEASING

THE MARK CONSISTS OF STANDARD CHARACTERS WITHOUT CLAIM TO ANY PARTICULAR FONT, STYLE, SIZE, OR COLOR.

OWNER OF U.S. REG. NOS. 2,974,985, 3,102,552 AND OTHERS.

NO CLAIM IS MADE TO THE EXCLUSIVE RIGHT TO USE "NATIONAL EXPRESS LEASING", APART FROM THE MARK AS SHOWN.

CLASS 35—ADVERTISING AND BUSINESS

FOR LEASING OF OFFICE EQUIPMENT (U.S. CLS. 100, 101 AND 102).

CLASS 36—INSURANCE AND FINANCIAL

FOR EQUIPMENT AND MACHINERY FINANCING SERVICES (U.S. CLS. 100, 101 AND 102).

CLASS 37—CONSTRUCTION AND REPAIR

FOR LEASING OF BUILDING MACHINERY; LEASING OF CONSTRUCTION EQUIPMENT AND MACHINERY; LEASING OF PAINT APPLICATION EQUIPMENT (U.S. CLS. 100, 103 AND 106).

CLASS 38—COMMUNICATION

FOR LEASING OF TELECOMMUNICATIONS EQUIPMENT AND MACHINERY (U.S. CLS. 100, 101 AND 104).

CLASS 39—TRANSPORTATION AND STORAGE

FOR LEASING OF VEHICLES; LEASING OF CONSTRUCTION AND AGRICULTURAL VEHICLES (U.S. CLS. 100 AND 105).

CLASS 40—MATERIAL TREATMENT

FOR LEASING OF PRINTING EQUIPMENT AND MACHINERY (U.S. CLS. 100, 103 AND 106).

CLASS 42—SCIENTIFIC AND COMPUTER SERVICES

FOR LEASING OF COMPUTERS AND COMPUTER EQUIPMENT, HARDWARE AND SOFTWARE (U.S. CLS. 100 AND 101).

CLASS 43—HOTEL AND RESTAURANT SERVICES

FOR LEASING OF KITCHEN APPLIANCES (U.S. CLS. 100 AND 101).

CLASS 44—MEDICAL, BEAUTY AND AGRICULTURAL SERVICES

FOR LEASING OF AGRICULTURAL EQUIPMENT AND MACHINERY; LEASING OF MEDICAL AND SKIN CARE EQUIPMENT AND RELATED HARDWARE AND SOFTWARE (U.S. CLS. 100 AND 101).

ALLISON SCHRODY, EXAMINING ATTORNEY

SN 77-391,201. MJM CREATIVE SERVICES, INC., NEW YORK, NY. FILED 2-7-2008.

SN 77-391,195. MJM CREATIVE SERVICES, INC., NEW YORK, NY. FILED 2-7-2008.

THE MARK CONSISTS OF LOWER CASE STYLIZED "MJM".

CLASS 35—ADVERTISING AND BUSINESS

FOR PREPARING AUDIO, AUDIO-VISUAL AND MULTI-MEDIA PRESENTATIONS FOR USE IN PRODUCT PROMOTION; PREPARING SPEECHES AND ORAL PRESENTATIONS FOR USE IN PRODUCT PROMOTION; CONDUCTING EXHIBITIONS IN THE NATURE OF COMEDY SHOWS, MUSICALS, PLAYS AND SKITS FOR PRODUCT PROMOTION OR OTHER PROMOTIONAL PURPOSES FOR BUSINESS AND INDUSTRY CONSUMERS (U.S. CLS. 100, 101 AND 102).

FIRST USE 6-7-2004; IN COMMERCE 6-7-2004.

THE MARK CONSISTS OF STANDARD CHARACTERS WITHOUT CLAIM TO ANY PARTICULAR FONT, STYLE, SIZE, OR COLOR.

CLASS 35—ADVERTISING AND BUSINESS

FOR PREPARING AUDIO, AUDIO-VISUAL AND MULTI-MEDIA PRESENTATIONS FOR USE IN PRODUCT PROMOTION; PREPARING SPEECHES AND ORAL PRESENTATIONS FOR USE IN PRODUCT PROMOTION; CONDUCTING EXHIBITIONS IN THE NATURE OF COMEDY SHOWS, MUSICALS, PLAYS AND SKITS FOR PRODUCT PROMOTION OR OTHER PROMOTIONAL PURPOSES FOR BUSINESS AND INDUSTRY CONSUMERS (U.S. CLS. 100, 101 AND 102).

FIRST USE 6-7-2004; IN COMMERCE 6-7-2004.

CLASS 41—EDUCATION AND ENTERTAINMENT

FOR PRODUCTION OF AUDIO, AUDIO-VISUAL AND MULTI-MEDIA PRESENTATIONS FOR OTHERS FOR USE AT BOTH LIVE AND VIRTUAL BUSINESS AND INDUSTRY MEETINGS, PROMOTIONAL EXHIBITIONS, PROMOTIONAL TOURS, PRODUCT EXHIBITIONS, AND OTHER PROMOTIONAL GATHERINGS AND EXPERIENCES; CONDUCTING ENTERTAINMENT EXHIBITIONS IN THE NATURE OF CONSUMER PRESENTATIONS, BUSINESS PROMOTIONAL PRESENTATIONS AND EXPERIENCES FEATURING AUDIO, AUDIO-VISUAL AND MULTI-MEDIA PRODUCTIONS; PREPARING SPEECHES AND ORAL PRESENTATIONS FOR EDUCATIONAL PURPOSES; CONDUCTING EXHIBITIONS IN THE NATURE OF COMEDY SHOWS, MUSICALS, PLAYS AND SKITS FOR ENTERTAINMENT PURPOSES FOR BUSINESS AND INDUSTRY CONSUMERS; EDUCATIONAL SERVICES, NAMELY, CONDUCTING BOTH LIVE AND VIRTUAL CLASSES AND SEMINARS FEATURING AUDIO AND VISUAL PRESENTATIONS FOR BUSINESS AND INDUSTRY CONSUMERS (U.S. CLS. 100, 101 AND 107).

FIRST USE 6-7-2004; IN COMMERCE 6-7-2004.

MICHAEL KEATING, EXAMINING ATTORNEY

CLASS 41—EDUCATION AND ENTERTAINMENT

FOR PRODUCTION OF AUDIO, AUDIO-VISUAL AND MULTI-MEDIA PRESENTATIONS FOR OTHERS FOR USE AT BOTH LIVE AND VIRTUAL BUSINESS AND INDUSTRY MEETINGS, PROMOTIONAL EXHIBITIONS, PROMOTIONAL TOURS, PRODUCT EXHIBITIONS, AND OTHER PROMOTIONAL GATHERINGS AND EXPERIENCES; CONDUCTING ENTERTAINMENT EXHIBITIONS IN THE NATURE OF CONSUMER PRESENTATIONS, BUSINESS PROMOTIONAL PRESENTATIONS AND EXPERIENCES FEATURING AUDIO, AUDIO-VISUAL AND MULTI-MEDIA PRODUCTIONS; PREPARING SPEECHES AND ORAL PRESENTATIONS FOR EDUCATIONAL PURPOSES; CONDUCTING EXHIBITIONS IN THE NATURE OF COMEDY SHOWS, MUSICALS, PLAYS AND SKITS FOR ENTERTAINMENT PURPOSES FOR BUSINESS AND INDUSTRY CONSUMERS; EDUCATIONAL SERVICES, NAMELY, CONDUCTING BOTH LIVE AND VIRTUAL CLASSES AND SEMINARS FEATURING AUDIO AND VISUAL PRESENTATIONS FOR BUSINESS AND INDUSTRY CONSUMERS (U.S. CLS. 100, 101 AND 107).

FIRST USE 6-7-2004; IN COMMERCE 6-7-2004.

MICHAEL KEATING, EXAMINING ATTORNEY

SN 77-391,210. ASKBEFORECOLLEGE, LLC, IRVINE, CA. FILED 2-7-2008.

THE MARK CONSISTS OF STANDARD CHARACTERS WITHOUT CLAIM TO ANY PARTICULAR FONT, STYLE, SIZE, OR COLOR.

NO CLAIM IS MADE TO THE EXCLUSIVE RIGHT TO USE "CAMPUS", APART FROM THE MARK AS SHOWN.

CLASS 38—COMMUNICATION

SN 77-391,637. SGS GROUP LTD., GRAND CAYMAN, CAYMAN ISLANDS, FILED 2-7-2008.

FOR PROVIDING ONLINE CHAT ROOMS AND ELECTRONIC BULLETIN BOARDS FOR TRANSMISSION OF MESSAGES AMONG COMPUTER USERS IN FIELDS OF GENERAL INTEREST, NAMELY, EDUCATION, FINANCE, CAREER PLANNING, TRAVEL, ENTERTAINMENT, RELATIONSHIPS, SPORTS, HOBBIES, HEALTH, THE USE OF COMPUTER HARDWARE AND SOFTWARE, AND USE OF THE INTERNET (U.S. CLS. 100, 101 AND 104).

CLASS 42—SCIENTIFIC AND COMPUTER SERVICES

FOR COMPUTER SERVICES, NAMELY, HOSTING AND MAINTAINING A WEB SITE ON AN ONLINE INTERACTIVE NETWORK FOR OTHERS TO EXCHANGE INFORMATION IN THE FORM OF QUESTIONS AND ANSWERS BASED ON VARIOUS SPECIFIC AREAS OF EXPERTISE, NAMELY, EDUCATION, FINANCE, CAREER PLANNING, TRAVEL, ENTERTAINMENT, RELATIONSHIPS, SPORTS, HOBBIES, HEALTH, THE USE OF COMPUTER HARDWARE AND SOFTWARE, AND USE OF THE INTERNET (U.S. CLS. 100 AND 101).

DORITT L. CARROLL, EXAMINING ATTORNEY



CLASS 35—ADVERTISING AND BUSINESS

FOR BUSINESS CONSULTING SERVICES; BUSINESS CONSULTING SERVICES RELATED TO THE DEVELOPMENT, SOURCING, MANUFACTURE, SALES AND DISTRIBUTION OF CONSUMER GOODS, AND TO THE COMMERCIALIZATION OF VARIOUS TECHNOLOGIES (U.S. CLS. 100, 101 AND 102).

FIRST USE 5-3-2006; IN COMMERCE 5-3-2006.

CLASS 36—INSURANCE AND FINANCIAL

FOR FINANCIAL AND INVESTMENT SERVICES, NAMELY, FINANCIAL PORTFOLIO AND ASSET MANAGEMENT; MONEY LENDING; INVESTMENT BANKING SERVICES; TRADE FINANCE SERVICES IN THE NATURE OF SOURCING AND STRUCTURING SHORT TERM, WORKING CAPITAL, AND LONG TERM FINANCING; REAL ESTATE INVESTMENT AND LENDING SERVICES; SECURITIZATION SERVICES IN THE NATURE OF CREATING AND MANAGING STRUCTURED SECURITIES OVERLYING ASSET POOLS, INCLUDING REAL ESTATE, MORTGAGES, CORPORATE DEBT OBLIGATIONS AND OTHER ASSET POOLS; PRIVATE EQUITY AND VENTURE CAPITAL CONSULTING, INVESTMENT AND FUNDING SERVICES; FINANCIAL ADVISORY AND CONSULTING SERVICES; FINANCIAL ANALYSIS AND RESEARCH SERVICES (U.S. CLS. 100, 101 AND 102).

FIRST USE 5-3-2006; IN COMMERCE 5-3-2006.

CAROLINE WOOD, EXAMINING ATTORNEY

SN 77-391,516. BRESNAN COMMUNICATIONS, LLC, PURCHASE, NY. FILED 2-7-2008.

THE SPOT

THE MARK CONSISTS OF STANDARD CHARACTERS WITHOUT CLAIM TO ANY PARTICULAR FONT, STYLE, SIZE, OR COLOR.

CLASS 9—ELECTRICAL AND SCIENTIFIC APPARATUS

FOR DOWNLOADABLE COMMERCIALS AND ADVERTISEMENTS PROVIDED VIA THE INTERNET AND TELEVISION, DIGITAL CABLE AND VIDEO-ON-DEMAND SERVICES (U.S. CLS. 21, 23, 26, 36 AND 38).

FIRST USE 9-0-2006; IN COMMERCE 9-0-2006.

CLASS 35—ADVERTISING AND BUSINESS

FOR ADVERTISING SERVICES, NAMELY, PROMOTING THE GOODS, SERVICES AND COMMERCIAL INFORMATION OF THIRD PARTIES THROUGH THE INTERNET AND TELEVISION, DIGITAL CABLE AND VIDEO-ON-DEMAND ADVERTISEMENTS AND COMMERCIALS (U.S. CLS. 100, 101 AND 102).

FIRST USE 9-0-2006; IN COMMERCE 9-0-2006.

SN 77-391,957. DATRON AG, MUEHLTAL, FED REP GERMANY, FILED 2-8-2008.

DATRON

THE MARK CONSISTS OF STANDARD CHARACTERS WITHOUT CLAIM TO ANY PARTICULAR FONT, STYLE, SIZE, OR COLOR.

CLASS 38—COMMUNICATION

FOR DIGITAL CABLE, TELEVISION AND VIDEO-ON-DEMAND TRANSMISSION SERVICES (U.S. CLS. 100, 101 AND 104).

FIRST USE 9-0-2006; IN COMMERCE 9-0-2006.

ADA HAN, EXAMINING ATTORNEY

CLASS 7—MACHINERY

FOR MACHINE TOOLS, NAMELY, DRILLING, MILLING AND ENGRAVING SYSTEMS; MACHINES FOR MACHINE OPERATIONS, NAMELY, METAL WORKING MACHINES, COMPUTER NUMERICAL CONTROLLED (CNC) METAL WORKING MACHINES, COMPUTER-CONTROLLED MACHINE TOOLS FOR METALWORKING, MILLING, AND DRILLING; METALWORKING MACHINE TOOLS, NAMELY, CUTTERS, DRILLS, THREAD MILLING TAPS, GRAVERS, END-MILLING CUTTERS, TOOLS BEING MACHINE PARTS FOR HIGH-SPEED SPINDLES, NAMELY, CUTTER HEADS AND MILLING HEADS (U.S. CLS. 13, 19, 21, 23, 31, 34 AND 35).

FIRST USE 5-9-1998; IN COMMERCE 5-9-1998.

CLASS 9—ELECTRICAL AND SCIENTIFIC APPARATUS

FOR DISPENSING MACHINES, NAMELY, DOSING SYSTEMS FOR PRECISE VOLUMETRIC DELIVERY OF FILLED OR UNFILLED SEALANTS AND ADHESIVES, AND PARTS THEREOF (U.S. CLS. 21, 23, 26, 36 AND 38).

FIRST USE 3-0-2005; IN COMMERCE 3-0-2005.

CLASS 41—EDUCATION AND ENTERTAINMENT

FOR PROVIDING CONTINUING EDUCATION COURSES AND TRAINING IN THE FIELD OF MACHINE TOOL OPERATION AND MAINTENANCE (U.S. CLS. 100, 101 AND 107).

FIRST USE 5-9-1998; IN COMMERCE 5-9-1998.

ELIZABETH HUGHITT, EXAMINING ATTORNEY

SN 77-392,129. BRESNAN COMMUNICATIONS, LLC, PURCHASE, NY. FILED 2-8-2008.



THE MARK CONSISTS OF THE WORDS "THE SPOT" AND DESIGN.

CLASS 9—ELECTRICAL AND SCIENTIFIC APPARATUS

FOR DOWNLOADABLE COMMERCIALS AND ADVERTISEMENTS PROVIDED VIA THE INTERNET AND TELEVISION, DIGITAL CABLE AND VIDEO-ON-DEMAND SERVICES (U.S. CLS. 21, 23, 26, 36 AND 38).

FIRST USE 9-0-2006; IN COMMERCE 9-0-2006.

CLASS 35—ADVERTISING AND BUSINESS

FOR ADVERTISING SERVICES, NAMELY, PROMOTING THE GOODS, SERVICES AND COMMERCIAL INFORMATION OF THIRD PARTIES THROUGH THE INTERNET AND TELEVISION, DIGITAL CABLE AND VIDEO-ON-DEMAND ADVERTISEMENTS AND COMMERCIALS (U.S. CLS. 100, 101 AND 102).

FIRST USE 9-0-2006; IN COMMERCE 9-0-2006.

CLASS 38—COMMUNICATION

FOR DIGITAL CABLE, TELEVISION AND VIDEO-ON-DEMAND TRANSMISSION SERVICES (U.S. CLS. 100, 101 AND 104).

FIRST USE 9-0-2006; IN COMMERCE 9-0-2006.

ADA HAN, EXAMINING ATTORNEY

SN 77-392,282. SENTRANA INC., BETHESDA, MD. FILED 2-8-2008.

THE SCIENCE TO MOVE MARKETS

THE MARK CONSISTS OF STANDARD CHARACTERS WITHOUT CLAIM TO ANY PARTICULAR FONT, STYLE, SIZE, OR COLOR.

CLASS 35—ADVERTISING AND BUSINESS

FOR BUSINESS CONSULTING SERVICES, NAMELY, BUSINESS MANAGEMENT, ANALYSIS AND MODELING TO HELP BUSINESSES DEVELOP OPTIMUM PRICING AND OTHER DEMAND MANAGEMENT STRATEGIES, CAPABILITIES AND OPERATIONAL EXECUTION TO ACHIEVE BEST PROFITABILITY AND REVENUE GROWTH (U.S. CLS. 100, 101 AND 102).

CLASS 42—SCIENTIFIC AND COMPUTER SERVICES

FOR APPLICATION SERVICE PROVIDER (ASP), NAMELY, HOSTING A COMPUTER SOFTWARE APPLICATION USED TO PREDICT PRODUCT/SERVICE DEMANDS THROUGH USE OF DATA MANAGEMENT, ANALYSIS AND MODELING AND TO HELP BUSINESSES DEVELOP OPTIMUM PRICING AND OTHER DEMAND MANAGEMENT STRATEGIES, CAPABILITIES AND OPERATIONAL EXECUTION TO ACHIEVE BEST PROFITABILITY AND REVENUE GROWTH AND RELATED COMPUTER SOFTWARE CONSULTANCY, DEVELOPMENT, MAINTENANCE, INSTALLATION, REPAIR AND UPDATING FOR OTHERS (U.S. CLS. 100 AND 101).

MARY BOAGNI, EXAMINING ATTORNEY

SN 77-392,421. CAT EAT CAT PRODUCTIONS INC., MIAMI, FL. FILED 2-8-2008.

VIRGIN VOTING

THE MARK CONSISTS OF STANDARD CHARACTERS WITHOUT CLAIM TO ANY PARTICULAR FONT, STYLE, SIZE, OR COLOR.

NO CLAIM IS MADE TO THE EXCLUSIVE RIGHT TO USE "VOTING", APART FROM THE MARK AS SHOWN.

CLASS 25—CLOTHING

FOR CLOTHING, NAMELY, T-SHIRTS, SWEAT-SHIRTS, SWEATPANTS, HATS, CAPS (U.S. CLS. 22 AND 39).

CLASS 35—ADVERTISING AND BUSINESS

FOR PRODUCING PROMOTIONAL VIDEOTAPES, VIDEO DISCS, AND AUDIO VISUAL RECORDINGS IN THE FIELDS OF POLITICS, ELECTIONS AND VOTING (U.S. CLS. 100, 101 AND 102).

CLASS 41—EDUCATION AND ENTERTAINMENT

FOR ENTERTAINMENT SERVICES, NAMELY, PROVIDING A SERIES OF NON-DOWNLOADABLE FILM DOCUMENTARIES IN THE FIELDS OF POLITICS, ELECTIONS AND VOTING VIA A WEBSITE ON THE GLOBAL NETWORK (U.S. CLS. 100, 101 AND 107).

FIRST USE 11-26-2007; IN COMMERCE 11-26-2007.
APRIL HESIK, EXAMINING ATTORNEY

SN 77-392,558. ELECTRONIC DIGITAL MEDIA CORPORATION, TAMPA, FL. FILED 2-8-2008.

EDEAN

THE MARK CONSISTS OF STANDARD CHARACTERS WITHOUT CLAIM TO ANY PARTICULAR FONT, STYLE, SIZE, OR COLOR.

CLASS 41—EDUCATION AND ENTERTAINMENT

FOR PROVIDING INFORMATION OVER AN ELECTRONIC NETWORK THROUGH DIGITAL MESSAGING AND DISPLAYS OF CAMPUS SPORTS EVENTS TO STUDENTS AND STAFF IN COLLEGES AND UNIVERSITIES (U.S. CLS. 100, 101 AND 107).

CLASS 44—MEDICAL, BEAUTY AND AGRICULTURAL SERVICES

FOR PROVIDING INFORMATION OVER AN ELECTRONIC NETWORK THROUGH DIGITAL MESSAGING AND DISPLAYS OF HEALTH INFORMATION TO STUDENTS AND STAFF IN COLLEGES AND UNIVERSITIES (U.S. CLS. 100 AND 101).

CLASS 45—PERSONAL AND LEGAL SERVICES

FOR PROVIDING INFORMATION OVER AN ELECTRONIC NETWORK THROUGH DIGITAL MESSAGING AND DISPLAYS OF EMERGENCY NOTICE AND RESPONSE TO STUDENTS AND STAFF IN COLLEGES AND UNIVERSITIES (U.S. CLS. 100 AND 101).
MICHAEL SOUDERS, EXAMINING ATTORNEY

SN 77-392,757. NATIONAL LAW ENFORCEMENT OFFICERS MEMORIAL FUND, INC., WASHINGTON, DC. FILED 2-8-2008.

NATIONAL LAW ENFORCEMENT OFFICERS MEMORIAL FUND

THE MARK CONSISTS OF STANDARD CHARACTERS WITHOUT CLAIM TO ANY PARTICULAR FONT, STYLE, SIZE, OR COLOR.

NO CLAIM IS MADE TO THE EXCLUSIVE RIGHT TO USE "MEMORIAL FUND", APART FROM THE MARK AS SHOWN.

SEC. 2(F).

CLASS 35—ADVERTISING AND BUSINESS

FOR PROMOTING PUBLIC AWARENESS OF THE NEED FOR INCREASED PUBLIC SUPPORT FOR THE LAW ENFORCEMENT PROFESSION BY PERMANENTLY RECORDING AND APPROPRIATELY COMMEMORATING THE SERVICE AND SACRIFICE OF LAW ENFORCEMENT OFFICERS (U.S. CLS. 100, 101 AND 102).

FIRST USE 6-29-1984; IN COMMERCE 6-29-1984.

CLASS 36—INSURANCE AND FINANCIAL

FOR CHARITABLE FUNDRAISING (U.S. CLS. 100, 101 AND 102).

FIRST USE 6-29-1984; IN COMMERCE 6-29-1984.

CLASS 41—EDUCATION AND ENTERTAINMENT

FOR OPERATING A MEMORIAL FOR SLAIN LAW ENFORCEMENT OFFICERS (U.S. CLS. 100, 101 AND 107).

FIRST USE 10-15-1991; IN COMMERCE 10-15-1991.

CLASS 45—PERSONAL AND LEGAL SERVICES

FOR PROVIDING INFORMATION TO THE PUBLIC AND TO LAW ENFORCEMENT OFFICERS AND AGENCIES REGARDING LAW ENFORCEMENT SAFETY (U.S. CLS. 100 AND 101).

FIRST USE 2-1-1988; IN COMMERCE 2-1-1988.

RUDY R. SINGLETON, EXAMINING ATTORNEY

SN 77-393,477. AMERICAN RELOCATION & LOGISTICS, INC., SANTE FE SPRINGS, CA. FILED 2-11-2008.

AMERICAN
RELOCATION & LOGISTICS

NO CLAIM IS MADE TO THE EXCLUSIVE RIGHT TO USE "RELOCATION AND LOGISTICS", APART FROM THE MARK AS SHOWN.

THE MARK CONSISTS OF THE WORDS "AMERICAN RELOCATION & LOGISTICS" WITH A STAR DESIGN.
SEC. 2(F).

CLASS 35—ADVERTISING AND BUSINESS

FOR MOVING AND RELOCATION SERVICES, NAMELY, PLANNING AND IMPLEMENTING MOVES OF HOMES AND OFFICES (U.S. CLS. 100, 101 AND 102).

FIRST USE 5-1-2003; IN COMMERCE 5-1-2003.

CLASS 39—TRANSPORTATION AND STORAGE

FOR WAREHOUSING SERVICES, NAMELY, STORAGE, DISTRIBUTION, PICK-UP, PACKING, AND SHIPPING OF HOUSEHOLD AND COMMERCIAL GOODS (U.S. CLS. 100 AND 105).

FIRST USE 5-1-2003; IN COMMERCE 5-1-2003.

KEVON CHISOLM, EXAMINING ATTORNEY

SN 77-394,872. EASTON SPORTS, INC., VAN NUYS, CA.
FILED 2-12-2008.

BUILT FOR EVERY SWING

THE MARK CONSISTS OF STANDARD CHARACTERS WITHOUT CLAIM TO ANY PARTICULAR FONT, STYLE, SIZE, OR COLOR.

CLASS 16—PAPER GOODS AND PRINTED MATTER

FOR PRINTED MATTER, NAMELY, ADVERTISING SIGNS AND DISPLAY POSTERS OF PAPER OR CARDBOARD FEATURING SELECTION OF BASEBALL AND SOFTBALL BATS (U.S. CLS. 2, 5, 22, 23, 29, 37, 38 AND 50).

CLASS 28—TOYS AND SPORTING GOODS

FOR BASEBALL BATS AND SOFTBALL BATS (U.S. CLS. 22, 23, 38 AND 50).
KEVIN CORWIN, EXAMINING ATTORNEY

SN 77-396,070. ANALYTICAL INSTRUMENTS CORPORATION, HOUSTON, TX. FILED 2-13-2008.

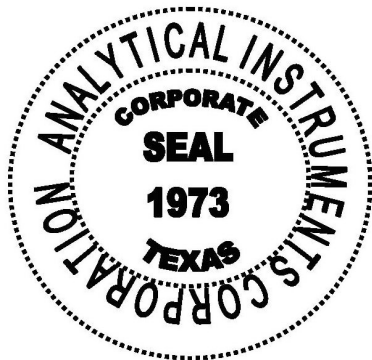

NO CLAIM IS MADE TO THE EXCLUSIVE RIGHT TO USE "ANALYTICAL INSTRUMENTS CORPORATION CORPORATE SEAL 1973 TEXAS", APART FROM THE MARK AS SHOWN.

THE MARK CONSISTS OF THE CORPORATE SEAL OF THE APPLICANT.

CLASS 9—ELECTRICAL AND SCIENTIFIC APPARATUS

FOR PIPELINE AND BRITISH THERMAL UNIT (BTU) ELECTRONIC ANALYSIS APPARATUS FOR MEASURING THE COMPOSITION OF LIQUIDS AND GASES IN A PIPELINE; THERMAL CONDUCTIVITY ANALYSIS APPARATUS FOR USE IN MEASURING MATERIALS BEING TRANSPORTED THEREIN; PROCESS ONLINE GAS CHROMATOGRAPHY APPARATUS; COMPUTERIZED CONTROL SYSTEMS COMPRISED OF COMPUTER HARDWARE AND SOFTWARE FOR OPERATION OF PROCESS, PIPELINE AND LABORATORY ELECTRONIC ANALYSIS APPARATUS (U.S. CLS. 21, 23, 26, 36 AND 38).

CLASS 37—CONSTRUCTION AND REPAIR

FOR INSTALLATION AND REPAIR OF PIPELINE AND BRITISH THERMAL UNIT (BTU) ANALYZERS, THERMAL CONDUCTIVITY ANALYZERS, PROCESS ONLINE CHROMATOGRAPHS, AND COMPUTERIZED CONTROL SYSTEMS FOR OPERATION OF ELECTRONIC PROCESS, PIPELINE AND LABORATORY ANALYSIS APPARATUS (U.S. CLS. 100, 103 AND 106).
NELSON SNYDER, EXAMINING ATTORNEY

SN 77-396,235. FAMILY DOLLAR STORES OF MICHIGAN, INC., MATTHEWS, NC. FILED 2-13-2008.

FAMILY CHEF

THE MARK CONSISTS OF STANDARD CHARACTERS WITHOUT CLAIM TO ANY PARTICULAR FONT, STYLE, SIZE, OR COLOR.

OWNER OF U.S. REG. NO. 3,323,649.

CLASS 7—MACHINERY

FOR ELECTRIC FOOD CHOPPERS, ELECTRIC STAND MIXERS, ELECTRIC HAND MIXERS, ELECTRIC BLENDERS, ELECTRIC CAN OPENERS (U.S. CLS. 13, 19, 21, 23, 31, 34 AND 35).

CLASS 11—ENVIRONMENTAL CONTROL APPARATUS

FOR SMALL KITCHEN APPLIANCES, NAMELY, ELECTRIC SKILLETS, ELECTRIC DEEP FRYERS, ELECTRIC RICE COOKERS, ELECTRIC COFFEE MAKERS, ELECTRIC TOASTER OVENS, ELECTRIC SLOW COOKERS, ELECTRIC TOASTERS (U.S. CLS. 13, 21, 23, 31 AND 34).

MARK RADEMACHER, EXAMINING ATTORNEY

SN 77-396,415. JEFF LEATHAM, INC., NEW YORK, NY.
FILED 2-13-2008.

JEFF LEATHAM FLOWERS BY DESIGN

THE MARK CONSISTS OF STANDARD CHARACTERS WITHOUT CLAIM TO ANY PARTICULAR FONT, STYLE, SIZE, OR COLOR.

NO CLAIM IS MADE TO THE EXCLUSIVE RIGHT TO USE "FLOWERS", APART FROM THE MARK AS SHOWN.

THE NAME(S), PORTRAIT(S), AND/OR SIGNATURE(S) SHOWN IN THE MARK IDENTIFIES "JEFF LEATHAM", WHOSE CONSENT(S) TO REGISTER OF RECORD.

CLASS 3—COSMETICS AND CLEANING PREPARATIONS

FOR FRAGRANCES FOR PERSONAL USE AND FOR ROOMS, POTPOURRI AND SCENTED ROCKS (U.S. CLS. 1, 4, 6, 50, 51 AND 52).

CLASS 4—LUBRICANTS AND FUELS

FOR SCENTED AND UNSCENTED CANDLES (U.S. CLS. 1, 6 AND 15).

SN 77-397,717. SANDISK CORPORATION, MILPITAS, CA. FILED 2-14-2008.

CLASS 26—FANCY GOODS

FOR ARTIFICIAL FLOWERS MADE OF SILK AND OTHER FABRICS (U.S. CLS. 37, 39, 40, 42 AND 50).

CLASS 31—NATURAL AGRICULTURAL PRODUCTS

FOR FLOWERS (U.S. CLS. 1 AND 46).

CLASS 42—SCIENTIFIC AND COMPUTER SERVICES

FOR INTERIOR DECORATING SERVICES (U.S. CLS. 100 AND 101).
FRED CARL, EXAMINING ATTORNEY

TIME TO PLAY

THE MARK CONSISTS OF STANDARD CHARACTERS WITHOUT CLAIM TO ANY PARTICULAR FONT, STYLE, SIZE, OR COLOR.

SN 77-397,133. OSMOND ENTERTAINMENT, LLC, BRANSON, MO. FILED 2-14-2008.

THE OSMONDS

THE MARK CONSISTS OF STANDARD CHARACTERS WITHOUT CLAIM TO ANY PARTICULAR FONT, STYLE, SIZE, OR COLOR.
SEC. 2(F).

CLASS 9—ELECTRICAL AND SCIENTIFIC APPARATUS

FOR SEMICONDUCTOR MEMORY DEVICES, NAMELY, INTEGRATED CIRCUITS, ELECTRONIC CIRCUIT CARDS AND CARTRIDGES, AND OTHER SEMICONDUCTOR DEVICES, NAMELY, FLASH MEMORY CARDS, MEMORY CARTRIDGES, MEMORY CARD ADAPTERS, MEMORY CARD CONVERTERS, MEMORY CARD CONTROLLERS, DIGITAL MEDIA PLAYERS, MEMORY CARD READERS, INTEGRATED CIRCUIT STORAGE MODULES, AND COMPUTER PERIPHERALS; DIGITAL PORTABLE AUDIO AND VIDEO PLAYERS AND RECORDERS WHICH USE SEMICONDUCTOR DEVICES AS RECORDING MEDIA; AND COMPUTER OPERATING PROGRAMS FOR SEMICONDUCTOR MEMORY DEVICES; DOWNLOADABLE SOFTWARE, NAMELY, COMPUTER OPERATING SOFTWARE; SOFTWARE FOR THE INTEGRATION OF DIGITAL FILES INTO AN INTERACTIVE DELIVERY PLATFORM FOR MULTIMEDIA APPLICATIONS; SOFTWARE FOR DOWNLOADING, VIEWING, LISTENING TO, AND RETRANSMITTING DIGITAL FILES FROM THE INTERNET; SOFTWARE FOR TRANSMISSION OF DIGITAL FILES AND DOWNLOADED CONTENT FROM ANY STORAGE DEVICE TO ANY ELECTRONIC COMMUNICATIONS INSTRUMENT AND BETWEEN SUCH INSTRUMENTS (U.S. CLS. 21, 23, 26, 36 AND 38).

CLASS 9—ELECTRICAL AND SCIENTIFIC APPARATUS

FOR PRE-RECORDED PHONOGRAPH RECORDS, AUDIO TAPES, AUDIO AND VIDEO CASSETTES, COMPACT DISCS AND DIGITAL VIDEO DISCS FEATURING MUSIC AND COMEDY (U.S. CLS. 21, 23, 26, 36 AND 38).
FIRST USE 12-31-1958; IN COMMERCE 12-31-1958.

CLASS 35—ADVERTISING AND BUSINESS

FOR COMPUTERIZED ON-LINE RETAIL STORE SERVICES FEATURING DOWNLOADABLE AUDIO AND VIDEO DIGITAL CONTENT, AS WELL AS AUDIO, VIDEO, FLASH AND NON-FLASH MEMORY STORAGE PRODUCTS, AND ELECTRONIC EQUIPMENT (U.S. CLS. 100, 101 AND 102).

CLASS 25—CLOTHING

FOR CLOTHING, NAMELY, TEE SHIRTS, SPORT SHIRTS, SWEATSHIRTS, JACKETS, HATS, VISORS AND CAPS (U.S. CLS. 22 AND 39).
FIRST USE 12-31-1958; IN COMMERCE 12-31-1958.

CLASS 38—COMMUNICATION

FOR AUDIO AND VIDEO TRANSMISSION AND BROADCASTING SERVICES; PROVIDING ACCESS TO NON-DOWNLOADABLE SOFTWARE FOR DOWNLOADING, TRANSMITTING AND VIEWING DIGITAL CONTENT (U.S. CLS. 100, 101 AND 104).

CLASS 41—EDUCATION AND ENTERTAINMENT

FOR ENTERTAINMENT SERVICES, NAMELY, A CONTINUING MUSICAL, VARIETY AND COMEDY SHOW BROADCAST OVER TELEVISION; ENTERTAINMENT SERVICES, NAMELY, THE PRESENTATION OF LIVE MUSICAL, VARIETY AND COMEDY SHOWS (U.S. CLS. 100, 101 AND 107).
FIRST USE 12-31-1958; IN COMMERCE 12-31-1958.
EDWARD NELSON, EXAMINING ATTORNEY

CLASS 42—SCIENTIFIC AND COMPUTER SERVICES

FOR PROVIDING ONLINE, NON-DOWNLOADABLE SOFTWARE, NAMELY, COMPUTER OPERATING SOFTWARE (U.S. CLS. 100 AND 101).
WILLIAM VERHOSEK, EXAMINING ATTORNEY

SN 77-398,606. ONWARD MULTI-CORP INC., WATERLOO, CANADA, FILED 2-15-2008.

SN 77-400,600. GREENWICH ASSOCIATION FOR RETARDED CITIZENS, DBA ARC, GREENWICH, CT. FILED 2-19-2008.

GRILLPRO

THE MARK CONSISTS OF STANDARD CHARACTERS WITHOUT CLAIM TO ANY PARTICULAR FONT, STYLE, SIZE, OR COLOR.

CLASS 4—LUBRICANTS AND FUELS

FOR WOOD CHIPS FOR SMOKING AND GRILLING; CHARCOAL LIGHTER FLUID; FIRE LIGHTERS; FUEL FOR LIGHTERS; LIGHTER FLUID (U.S. CLS. 1, 6 AND 15).

FIRST USE 12-31-1987; IN COMMERCE 6-23-1988.

CLASS 9—ELECTRICAL AND SCIENTIFIC APPARATUS

FOR FIRE RESISTANT GLOVES; THERMOMETERS (U.S. CLS. 21, 23, 26, 36 AND 38).

FIRST USE 12-31-1987; IN COMMERCE 6-23-1988.

CLASS 11—ENVIRONMENTAL CONTROL APPARATUS

FOR BARBECUE GRILLS; BARBECUE SMOKER ACCESSORIES, NAMELY, CONVECTION PLATES; BARBECUE SMOKERS; BARBECUES AND GRILLS; CERAMIC BRIQUETTES FOR USE IN BARBECUE GRILLS; FOLDING PORTABLE CHARCOAL, PROPANE AND GAS FIRED BARBECUES, STOVES, AND GRILLS; LAVA ROCK FOR USE IN BARBECUE GRILLS; GRILL ACCESSORIES, NAMELY, WARMING TRAYS; LIGHTERS PRIMARILY FOR LIGHTING GRILLS, FIREPLACES AND CANDLES; ELECTRIC ROTISSERIES; ROTISSERIES; ELECTRIC GRIDDLES; GAS GRILLS (U.S. CLS. 13, 21, 23, 31 AND 34).

FIRST USE 12-31-1987; IN COMMERCE 6-23-1988.

CLASS 21—HOUSEWARES AND GLASS

FOR UTENSILS FOR BARBECUES, NAMELY, FORKS, KNIVES, TONGS, TURNERS; COOKING UTENSILS, NAMELY, GRILL COVERS; COOKING UTENSILS, NAMELY, GRILLS; WOOD COOKING PLANKS FOR USE IN GRILLING; COOKING UTENSILS, NAMELY, WIRE BASKETS; HOUSEHOLD UTENSILS, NAMELY, SPATULAS; HOUSEHOLD UTENSILS, NAMELY, COOKING SKEWERS; TOPPERS, NAMELY, PERFORATED PLATES THAT ARE PLACED ON TOP OF A GRILL FOR PURPOSES OF COOKING FOOD AT REDUCED HEAT; COOKING UTENSILS, NAMELY, ROASTING RACKS; BASTING BRUSHES; BARBECUE AND GRILL CLEANING BRUSHES; SCRAPING BRUSHES; HOUSEHOLD GLOVES FOR GENERAL USE; RUBBER HOUSEHOLD GLOVES; GRIDDLES (U.S. CLS. 2, 13, 23, 29, 30, 33, 40 AND 50).

FIRST USE 12-31-1987; IN COMMERCE 6-23-1988.

CLASS 25—CLOTHING

FOR APRONS (U.S. CLS. 22 AND 39).

FIRST USE 12-31-1987; IN COMMERCE 6-23-1988.
JIM RINGLE, EXAMINING ATTORNEY

ABILIS

THE MARK CONSISTS OF STANDARD CHARACTERS WITHOUT CLAIM TO ANY PARTICULAR FONT, STYLE, SIZE, OR COLOR.

THE MARK "ABILIS" HAS NO MEANING IN A FOREIGN LANGUAGE.

CLASS 41—EDUCATION AND ENTERTAINMENT

FOR VOCATIONAL AND EDUCATIONAL SERVICES, NAMELY, PROVIDING SPECIAL PROGRAMS IN THE NATURE OF ADULT EMPLOYMENT AND INDEPENDENT LIVING SUPPORTS, FAMILY TRAINING AND SUPPORT, EARLY EDUCATION FOR INFANTS TODDLERS AND THEIR FAMILIES, CLASSES AND COURSES IN THE FIELD OF CAREERS TO CHILDREN AND ADULTS WITH SPECIAL NEEDS AND DISABILITIES IN THEIR FAMILIES; CAREER GUIDANCE AND CAREER COUNSELING; EDUCATIONAL TESTING, NAMELY, LEARNING ASSESSMENT, ASSESSMENT AND EVALUATION SERVICES OF DISABLED CHILDREN AND ADULTS TO CREATE AND DEVELOP INDIVIDUAL EDUCATIONAL SUPPORT PLANS; VOCATIONAL GUIDANCE COUNSELING; RESIDENTIAL, RECREATIONAL AND LEISURE ACTIVITIES, NAMELY, PROVIDING FACILITIES FOR RECREATION ACTIVITIES, GUIDED TOURS OF MUSEUMS, RECREATIONAL SERVICES IN THE NATURE OF POOLS, AND HEALTH CLUB SERVICES IN THE NATURE OF PROVIDING INSTRUCTION AND EQUIPMENT IN THE FIELD OF PHYSICAL EXERCISE (U.S. CLS. 100, 101 AND 107).

CLASS 43—HOTEL AND RESTAURANT SERVICES

FOR PROVIDING ASSISTED LIVING ACCOMMODATIONS, NAMELY, RESIDENCES FOR MENTALLY AND DEVELOPMENT DISABLED ADULTS (U.S. CLS. 100 AND 101).

CLASS 45—PERSONAL AND LEGAL SERVICES

FOR ORGANIZING AND CONDUCTING SUPPORT GROUPS FOR THE FAMILIES OF CHILDREN AND ADULTS WITH DISABILITIES; EMOTIONAL SUPPORT CONSULTATION SERVICES; GUIDANCE COUNSELING AND FAMILY COUNSELING SERVICES IN THE FIELD OF INTERVENTION, BEHAVIORAL, EMOTIONAL AND LIFE SKILLS, NAMELY, HELP WITH MEDICAL FORMS AND ACCESS TO EDUCATIONAL SERVICES AND GOVERNMENT SUPPORTS; EDUCATIONAL ADVOCACY SERVICES FOR DISABLED CHILDREN AND ADULTS AND THEIR FAMILIES, NAMELY, CASE MANAGEMENT COORDINATION OF LEGAL, SOCIAL, PSYCHOLOGICAL AND EDUCATIONAL SERVICES (U.S. CLS. 100 AND 101).

VIVIAN MICZNIK FIRST, EXAMINING ATTORNEY

SN 77-401,559. CANDLE SCIENCE, INC., DURHAM, NC. FILED 2-20-2008.

SN 77-401,567. FUHU, INC., EL SEGUNDO, CA. FILED 2-20-2008.

CandleScience

THE MARK CONSISTS OF STANDARD CHARACTERS WITHOUT CLAIM TO ANY PARTICULAR FONT, STYLE, SIZE, OR COLOR.

CLASS 16—PAPER GOODS AND PRINTED MATTER

FOR BOOKS FEATURING GENERAL, NON-SCIENTIFIC INFORMATION ABOUT CANDLES, CANDLE MAKING, AND THE CANDLE INDUSTRY (U.S. CLS. 2, 5, 22, 23, 29, 37, 38 AND 50).

FIRST USE 8-6-2002; IN COMMERCE 8-6-2002.

CLASS 35—ADVERTISING AND BUSINESS

FOR MARKETING SERVICES, NAMELY, PROMOTING THE CANDLE-RELATED AND SOAP-RELATED PRODUCTS OF CANDLE AND SOAP PRODUCERS; RETAIL STORE SERVICES FEATURING PRODUCTS FOR MAKING CANDLES AND SOAP; ON-LINE RETAIL STORE SERVICES FEATURING PRODUCTS FOR MAKING CANDLES AND SOAP; DISTRIBUTORSHIP SERVICES IN THE FIELD OF PRODUCTS FOR MAKING CANDLES AND SOAP (U.S. CLS. 100, 101 AND 102).

FIRST USE 8-6-2002; IN COMMERCE 8-6-2002.

CLASS 38—COMMUNICATION

FOR PROVIDING ON-LINE ELECTRONIC BULLETIN BOARDS FOR TRANSMISSION OF MESSAGES AMONG COMPUTER USERS CONCERNING GENERAL, NON-SCIENTIFIC INFORMATION ABOUT CANDLES, CANDLE MAKING, AND THE CANDLE INDUSTRY (U.S. CLS. 100, 101 AND 104).

FIRST USE 8-6-2002; IN COMMERCE 8-6-2002.

CLASS 41—EDUCATION AND ENTERTAINMENT

FOR ON-LINE JOURNALS, NAMELY, BLOGS FEATURING GENERAL, NON-SCIENTIFIC INFORMATION ABOUT CANDLES, CANDLE MAKING, AND THE CANDLE INDUSTRY; PROVIDING A WEB SITE FEATURING NON-DOWNLOADABLE INSTRUCTIONAL VIDEO PRESENTATIONS FEATURING GENERAL, NON-SCIENTIFIC INFORMATION IN THE FIELDS OF CANDLES, CANDLE MAKING, AND THE CANDLE INDUSTRY (U.S. CLS. 100, 101 AND 107).

FIRST USE 8-6-2002; IN COMMERCE 8-6-2002.
ROBERT LAVACHE, EXAMINING ATTORNEY



THE COLOR(S) ORANGE, WHITE AND GRAY IS/ARE CLAIMED AS A FEATURE OF THE MARK.

THE MARK CONSISTS OF AN ORANGE LETTER "S" AND AN ORANGE HOLE ABOVE THE "S" IN A WHITE FLOWER SHAPE WHICH FADES TO LIGHT ORANGE TOWARD THE BOTTOM OF THE FLOWER. THE FLOWER IS IN AN ORANGE CAPTION BOX, WITH A LIGHTER SHADE OF ORANGE ON THE TOP PORTION OF THE CAPTION BOX. THE ORANGE CAPTION BOX IS OUTLINED IN SHADES OF GRAY WITH THE WORDS "UR-SPIN" BESIDE IT IN DARK GRAY.

CLASS 9—ELECTRICAL AND SCIENTIFIC APPARATUS

FOR DOWNLOADABLE SOFTWARE THAT ALLOWS PERSONALIZED INTERACTION OVER NETWORKED MEDIA BY ENABLING THE USER TO ORGANIZE, ACCESS, AND SHARE WITH OTHERS A PERSONALIZED WEB PAGE WHICH FUNCTIONS AS A ONE-STOP ACCESS AND DISTRIBUTION POINT TO A USER'S FAVORITE NEWS, INFORMATION, INTERNET APPLICATIONS, AND MULTIMEDIA CONTENT (U.S. CLS. 21, 23, 26, 36 AND 38).

CLASS 42—SCIENTIFIC AND COMPUTER SERVICES

FOR PROVIDING TEMPORARY USE OF ON-LINE NON-DOWNLOADABLE SOFTWARE THAT ALLOWS PERSONALIZED INTERACTION OVER NETWORKED MEDIA BY ENABLING THE USER TO ORGANIZE, ACCESS, AND SHARE WITH OTHERS A PERSONALIZED WEB PAGE WHICH FUNCTIONS AS A ONE-STOP ACCESS AND DISTRIBUTION POINT TO A USER'S FAVORITE NEWS, INFORMATION, INTERNET APPLICATIONS, AND MULTIMEDIA CONTENT (U.S. CLS. 100 AND 101).

ELLEN B. AWRICH, EXAMINING ATTORNEY

SN 77-403,451. INFINITY SPORTS, LLC, CHANHASSEN, MN. FILED 2-22-2008.

NEXT GOAL WINS

THE MARK CONSISTS OF STANDARD CHARACTERS WITHOUT CLAIM TO ANY PARTICULAR FONT, STYLE, SIZE, OR COLOR.

CLASS 25—CLOTHING

FOR CLOTHING, NAMELY, HOCKEY PANTS, SUSPENDERS, BELTS, HOCKEY SHORTS, SOCKS, GLOVES, AND BREEZERS, NAMELY, HOCKEY PANTS (U.S. CLS. 22 AND 39).

CLASS 28—TOYS AND SPORTING GOODS

FOR FIGURE SKATES; HOCKEY SKATES; ICE HOCKEY EQUIPMENT, NAMELY, SHOULDER PADS, ELBOW PADS, SHIN PADS, GLOVES, WRIST GUARDS, PELVIC PROTECTORS, ICE SKATE BLADE GUARDS, GRIP TAPE FOR HOCKEY STICKS, HOCKEY BAGS, ATHLETIC SUPPORTS, NAMELY, JOCK STRAPS, AND ATHLETIC SUPPORTS, NAMELY, PROTECTIVE ATHLETIC CUPS AND ATHLETIC CUP SUPPORTERS SOLD AS A UNIT (U.S. CLS. 22, 23, 38 AND 50).

KIM MONINGHOFF, EXAMINING ATTORNEY

SN 77-404,045. TPI HOLDINGS, INC., NORFOLK, VA. FILED 2-22-2008.

COMMERCIAL TRUCK TRADER

THE MARK CONSISTS OF STANDARD CHARACTERS WITHOUT CLAIM TO ANY PARTICULAR FONT, STYLE, SIZE, OR COLOR.

OWNER OF U.S. REG. NOS. 2,817,176, 3,316,348 AND OTHERS.

NO CLAIM IS MADE TO THE EXCLUSIVE RIGHT TO USE "COMMERCIAL TRUCK", APART FROM THE MARK AS SHOWN.

CLASS 16—PAPER GOODS AND PRINTED MATTER

FOR PERIODIC PUBLICATIONS, NAMELY, MAGAZINES FEATURING CLASSIFIED AND DISPLAY ADVERTISING (U.S. CLS. 2, 5, 22, 23, 29, 37, 38 AND 50).

FIRST USE 10-1-2007; IN COMMERCE 10-1-2007.

CLASS 35—ADVERTISING AND BUSINESS

FOR ADVERTISING SERVICES, NAMELY, PREPARING AND DISSEMINATING ADVERTISING FOR OTHERS VIA AN ONLINE ELECTRONIC COMMUNICATIONS NETWORK; COMPUTER SERVICES, NAMELY, PROVIDING A DATABASE FEATURING VEHICLE SALES INFORMATION, VEHICLE DEALERSHIP SERVICES INFORMATION, AND VEHICLE CLASSIFIED AND DISPLAY ADVERTISING VIA AN ONLINE ELECTRONIC COMMUNICATIONS NETWORK (U.S. CLS. 100, 101 AND 102).

FIRST USE 8-1-2007; IN COMMERCE 8-1-2007.

KRISTIN CARLSON, EXAMINING ATTORNEY

SN 77-404,149. HUMANA INC., LOUISVILLE, KY. FILED 2-22-2008.

HUMANA PHARMACY SOLUTIONS

THE MARK CONSISTS OF STANDARD CHARACTERS WITHOUT CLAIM TO ANY PARTICULAR FONT, STYLE, SIZE, OR COLOR.

OWNER OF U.S. REG. NOS. 1,575,512, 2,186,854 AND OTHERS.

NO CLAIM IS MADE TO THE EXCLUSIVE RIGHT TO USE "PHARMACY SOLUTIONS", APART FROM THE MARK AS SHOWN.

CLASS 35—ADVERTISING AND BUSINESS

FOR COST MANAGEMENT FOR THE HEALTH BENEFIT PLANS OF OTHERS; HEALTHCARE COST CONTAINMENT; COST MANAGEMENT CONSULTATION REGARDING LOWER COST PRESCRIPTION ALTERNATIVES; PRESCRIPTION PURCHASING, NAMELY, RETAIL DRUG STORE SERVICES (U.S. CLS. 100, 101 AND 102).

CLASS 36—INSURANCE AND FINANCIAL

FOR INSURANCE SERVICES, NAMELY, PROVIDING PRESCRIPTION COVERAGE; INSURANCE SERVICES, NAMELY, SPECIALTY DRUG COVERAGE; INSURANCE ADMINISTRATION, NAMELY, ADMINISTRATION OF PRESCRIPTION DRUG PROGRAMS FOR DRUG COVERAGE INSURERS (U.S. CLS. 100, 101 AND 102).

CLASS 39—TRANSPORTATION AND STORAGE

FOR DELIVERY OF GOODS, NAMELY, PRESCRIPTION HOME DELIVERY (U.S. CLS. 100 AND 105).

CLASS 44—MEDICAL, BEAUTY AND AGRICULTURAL SERVICES

FOR PROVIDING HEALTHCARE INFORMATION; PROVIDING HEALTH INFORMATION, NAMELY, PROVIDING PRESCRIPTION MEDICATION INFORMATION; MEDICAL CONSULTING SERVICES, NAMELY, PROVIDING ASSISTANCE TO COVERAGE MEMBERS IN MANAGING THEIR PRESCRIPTIONS TO IMPROVE HEALTH OUTCOMES BY MAXIMIZING DRUG EFFICACY AND MINIMIZING DRUG INTERACTION ISSUES (U.S. CLS. 100 AND 101).

MEGHAN REINHART, EXAMINING ATTORNEY

SN 77-404,153. HUMANA INC., LOUISVILLE, KY. FILED 2-22-2008.

PHARMACY SOLUTIONS POWERED BY HUMANA

THE MARK CONSISTS OF STANDARD CHARACTERS WITHOUT CLAIM TO ANY PARTICULAR FONT, STYLE, SIZE, OR COLOR.

OWNER OF U.S. REG. NOS. 1,575,512, 2,186,854 AND OTHERS.

NO CLAIM IS MADE TO THE EXCLUSIVE RIGHT TO USE "PHARMACY SOLUTIONS", APART FROM THE MARK AS SHOWN.

CLASS 35—ADVERTISING AND BUSINESS

FOR COST MANAGEMENT FOR THE HEALTH BENEFIT PLANS OF OTHERS; HEALTHCARE COST CONTAINMENT; COST MANAGEMENT CONSULTATION REGARDING LOWER COST PRESCRIPTION ALTERNATIVES; PRESCRIPTION PURCHASING, NAMELY, RETAIL DRUG STORE SERVICES (U.S. CLS. 100, 101 AND 102).

CLASS 36—INSURANCE AND FINANCIAL

FOR INSURANCE SERVICES, NAMELY, PROVIDING PRESCRIPTION COVERAGE; INSURANCE SERVICES, NAMELY, SPECIALTY DRUG COVERAGE; INSURANCE ADMINISTRATION, NAMELY, ADMINISTRATION OF PRESCRIPTION DRUG PROGRAMS FOR DRUG COVERAGE INSURERS (U.S. CLS. 100, 101 AND 102).

CLASS 39—TRANSPORTATION AND STORAGE

FOR DELIVERY OF GOODS, NAMELY, PRESCRIPTION HOME DELIVERY (U.S. CLS. 100 AND 105).

SN 77-404,792. GREAT LAKES CENTER FOR AUTISM, TOLEDO, OH. FILED 2-25-2008.

CLASS 44—MEDICAL, BEAUTY AND AGRICULTURAL SERVICES

FOR PROVIDING HEALTHCARE INFORMATION; PROVIDING HEALTH INFORMATION, NAMELY, PROVIDING PRESCRIPTION MEDICATION INFORMATION; MEDICAL CONSULTING SERVICES, NAMELY, PROVIDING ASSISTANCE TO COVERAGE MEMBERS IN MANAGING THEIR PRESCRIPTIONS TO IMPROVE HEALTH OUTCOMES BY MAXIMIZING DRUG EFFICACY AND MINIMIZING DRUG INTERACTION ISSUES (U.S. CLS. 100 AND 101).
MEGHAN REINHART, EXAMINING ATTORNEY

GIVE AUTISM THE BOOT!

THE MARK CONSISTS OF STANDARD CHARACTERS WITHOUT CLAIM TO ANY PARTICULAR FONT, STYLE, SIZE, OR COLOR.

CLASS 35—ADVERTISING AND BUSINESS

FOR CHARITABLE SERVICES, NAMELY, ORGANIZING AND CONDUCTING VOLUNTEER PROGRAMS AND COMMUNITY SERVICE PROJECTS IN THE FIELD OF AUTISM (U.S. CLS. 100, 101 AND 102).
FIRST USE 4-0-2006; IN COMMERCE 4-0-2006.

CLASS 36—INSURANCE AND FINANCIAL

FOR CHARITABLE FUNDRAISING SERVICES IN THE FIELD OF AUTISM (U.S. CLS. 100, 101 AND 102).
FIRST USE 4-0-2006; IN COMMERCE 4-0-2006.
ANGELA GAW, EXAMINING ATTORNEY

SN 77-404,262. WAL-MART STORES, INC., BENTONVILLE, AR. FILED 2-22-2008.

COLOR FOR ALL

THE MARK CONSISTS OF STANDARD CHARACTERS WITHOUT CLAIM TO ANY PARTICULAR FONT, STYLE, SIZE, OR COLOR.

SN 77-405,006. INTERNATIONAL COMMODITIES EXPORT CORPORATION, THE WOODLANDS, TX. FILED 2-25-2008.



THE COLOR(S) GREEN AND WHITE IS/ARE CLAIMED AS A FEATURE OF THE MARK.

THE MARK CONSISTS OF WHITE "ICEC" LETTERS IN A WHITE CIRCLE CONNECTED TO A WHITE DRAWING OF A GLOBE SURROUNDED BY GREEN.

CLASS 3—COSMETICS AND CLEANING PREPARATIONS

FOR BABY WIPES; BABY LOTION; BATH SOAPS; BABY SHAMPOO; BABY OIL (U.S. CLS. 1, 4, 6, 50, 51 AND 52).

CLASS 18—LEATHER GOODS

FOR TOTE BAGS (U.S. CLS. 1, 2, 3, 22 AND 41).

CLASS 24—FABRICS

FOR BEDDING, NAMELY, RECEIVING BLANKETS (U.S. CLS. 42 AND 50).

CLASS 25—CLOTHING

FOR CLOTHING, NAMELY, TOPS, BOTTOMS, JACKETS, SLEEPWEAR, UNDERWEAR, HOSIERY, SOCKS, TIGHTS, HATS, GLOVES, SCARVES, LAYETTES, COVERALLS, JUMPERS, SLEEPERS, ROMPERS, CREEPERS, CLOTH BIBS, TEXTILE INFANT DIAPER COVERS, BABY MITTENS (U.S. CLS. 22 AND 39).
KIM MONINGHOFF, EXAMINING ATTORNEY

CLASS 35—ADVERTISING AND BUSINESS

FOR MARKETING SERVICES IN THE FIELD OF FERTILIZERS, SULPHUR AND SULPHURIC ACID; PROJECT MANAGEMENT SERVICES IN THE FIELD OF FERTILIZERS, SULPHUR AND SULPHURIC ACID; PLANNING, CONSULTING, AND BUSINESS AND PROJECT MANAGEMENT SERVICES IN THE FIELD OF TRANSPORT LOGISTICS FOR THE BENEFIT OF THIRD PARTIES (U.S. CLS. 100, 101 AND 102).
FIRST USE 12-0-1963; IN COMMERCE 12-0-1963.

CLASS 36—INSURANCE AND FINANCIAL

FOR FINANCING OF SALES AND PURCHASES OF FERTILIZERS, SULPHUR AND SULPHURIC ACID; FINANCING SERVICES RENDERED TO OTHERS IN THE FIELD OF TRANSPORTATION; BROKERAGE SERVICES IN THE FIELD OF FERTILIZERS, SULPHUR AND SULPHURIC ACID (U.S. CLS. 100, 101 AND 102).
FIRST USE 12-0-1963; IN COMMERCE 12-0-1963.

CLASS 37—CONSTRUCTION AND REPAIR

FOR CONSTRUCTION PLANNING AND CONSULTANCY SERVICES FOR FERTILIZER AND SULPHUR REMELTING FACILITIES, FERTILIZER AND SULPHUR TERMINAL AND STORAGE FACILITIES, AND FERTILIZER AND SULPHUR TRANSLOAD, CONTAINER AND BAGGING FACILITIES (U.S. CLS. 100, 103 AND 106).

FIRST USE 12-0-1963; IN COMMERCE 12-0-1963.

CLASS 39—TRANSPORTATION AND STORAGE

FOR TRANSPORTATION OF FERTILIZERS, SULPHUR AND SULPHURIC ACID BY RAIL, BARGE, TRUCK AND SHIP (U.S. CLS. 100 AND 105).

FIRST USE 12-0-1963; IN COMMERCE 12-0-1963.

CLASS 42—SCIENTIFIC AND COMPUTER SERVICES

FOR ENGINEERING SERVICES (U.S. CLS. 100 AND 101).

FIRST USE 12-0-1963; IN COMMERCE 12-0-1963.

MATTHEW PAPPAS, EXAMINING ATTORNEY

SN 77-406,241. TVBG LLC, PACIFIC PALISADES, CA. FILED 2-26-2008.

505 SOUTHWESTERN

THE MARK CONSISTS OF STANDARD CHARACTERS WITHOUT CLAIM TO ANY PARTICULAR FONT, STYLE, SIZE, OR COLOR.

OWNER OF U.S. REG. NO. 2,577,049.
SEC. 2(F) "SOUTHWESTERN".

CLASS 29—MEATS AND PROCESSED FOODS

FOR PROCESSED ROASTED CHILE PEPPERS (U.S. CL. 46).

CLASS 30—STAPLE FOODS

FOR CHILE SAUCES; SAUCES; SALSAS; MARINADES (U.S. CL. 46).

FIRST USE 10-19-1996; IN COMMERCE 4-4-1997.
MARY MUNSON, EXAMINING ATTORNEY

SN 77-405,981. HANSEN BEVERAGE COMPANY, CORONA, CA. FILED 2-26-2008.

SN 77-406,527. INSIGNIA HEALTH, LLC, PORTLAND, OR. FILED 2-26-2008.

INSIGNIA HEALTH**NUT UP**

THE MARK CONSISTS OF STANDARD CHARACTERS WITHOUT CLAIM TO ANY PARTICULAR FONT, STYLE, SIZE, OR COLOR.

NO CLAIM IS MADE TO THE EXCLUSIVE RIGHT TO USE "NUT", APART FROM THE MARK AS SHOWN.

CLASS 5—PHARMACEUTICALS

FOR NUTRITIONAL SUPPLEMENTS (U.S. CLS. 6, 18, 44, 46, 51 AND 52).

FIRST USE 12-31-2007; IN COMMERCE 12-31-2007.

CLASS 32—LIGHT BEVERAGES

FOR NON-ALCOHOLIC BEVERAGES, NAMELY, ENERGY DRINKS FLAVORED WITH COFFEE AND ENHANCED WITH VITAMINS, MINERALS, NUTRIENTS, AMINO ACIDS AND/OR HERBS (U.S. CLS. 45, 46 AND 48).

FIRST USE 12-31-2007; IN COMMERCE 12-31-2007.
MARY CRAWFORD, EXAMINING ATTORNEY

THE MARK CONSISTS OF STANDARD CHARACTERS WITHOUT CLAIM TO ANY PARTICULAR FONT, STYLE, SIZE, OR COLOR.

NO CLAIM IS MADE TO THE EXCLUSIVE RIGHT TO USE "HEALTH", APART FROM THE MARK AS SHOWN.

CLASS 9—ELECTRICAL AND SCIENTIFIC APPARATUS

FOR SOFTWARE FOR USE IN ASSESSMENT, MODIFICATION, AND MANAGEMENT OF PATIENT AND CONSUMER BEHAVIOR AND MEASURING PATIENT AND CONSUMER KNOWLEDGE, SKILL, AND CONFIDENCE OF SELF-MANAGEMENT OF HEALTH-RELATED BEHAVIOR; SOFTWARE FOR USE IN RECEIVING, COLLECTING, STORING, ORGANIZING, ANALYZING, EVALUATING, REPORTING, AND DISPLAYING PATIENT AND CONSUMER BEHAVIOR DATA AND INFORMATION; SOFTWARE FOR USE IN CONDUCTING PATIENT AND CONSUMER SURVEYS AND ASSESSMENTS (U.S. CLS. 21, 23, 26, 36 AND 38).

CLASS 16—PAPER GOODS AND PRINTED MATTER

FOR PRINTED MATERIALS, NAMELY, SURVEYS AND ASSESSMENTS IN THE FIELD OF PATIENT AND CONSUMER HEALTH CARE BEHAVIOR; PRINTED MATERIALS, NAMELY, TRAINING AND EDUCATIONAL GUIDES IN THE FIELDS OF PATIENT AND CONSUMER HEALTHCARE BEHAVIOR ASSESSMENT, MODIFICATION, AND MANAGEMENT (U.S. CLS. 2, 5, 22, 23, 29, 37, 38 AND 50).

CLASS 41—EDUCATION AND ENTERTAINMENT

FOR EDUCATIONAL SERVICES, NAMELY, PROVIDING TRAINING IN THE FIELDS OF PATIENT AND CONSUMER HEALTHCARE BEHAVIOR ASSESSMENT, MODIFICATION, AND MANAGEMENT (U.S. CLS. 100, 101 AND 107).

CLASS 42—SCIENTIFIC AND COMPUTER SERVICES

FOR PROVIDING ONLINE NONDOWNLOADABLE SOFTWARE FOR USE IN ASSESSMENT, MODIFICATION, AND MANAGEMENT OF PATIENT AND CONSUMER BEHAVIOR AND MEASURING PATIENT AND CONSUMER KNOWLEDGE, SKILL, AND CONFIDENCE OF SELF-MANAGEMENT OF HEALTH-RELATED BEHAVIOR; PROVIDING ONLINE NONDOWNLOADABLE SOFTWARE FOR USE IN RECEIVING, COLLECTING, STORING, ORGANIZING, ANALYZING, EVALUATING, REPORTING, AND DISPLAYING PATIENT AND CONSUMER BEHAVIOR DATA; PROVIDING ONLINE NONDOWNLOADABLE SOFTWARE FOR USE IN CONDUCTING PATIENT AND CONSUMER SURVEYS AND ASSESSMENTS (U.S. CLS. 100 AND 101).

CLASS 44—MEDICAL, BEAUTY AND AGRICULTURAL SERVICES

FOR CONSULTING SERVICES IN THE FIELD OF PATIENT AND CONSUMER HEALTH CARE BEHAVIOR ASSESSMENT, MODIFICATION, AND MANAGEMENT; PROVISION OF INFORMATION IN THE FIELD OF PATIENT AND CONSUMER HEALTH CARE BEHAVIOR (U.S. CLS. 100 AND 101).

MATTHEW PAPPAS, EXAMINING ATTORNEY

SN 77-406,535, INSIGNIA HEALTH, LLC, PORTLAND, OR. FILED 2-26-2008.



THE MARK CONSISTS OF A STYLIZED HUMAN FIGURE SET IN A PARTIAL SOLID CIRCLE IN TWO UNEQUAL PARTS.

CLASS 9—ELECTRICAL AND SCIENTIFIC APPARATUS

FOR SOFTWARE FOR USE IN ASSESSMENT, MODIFICATION, AND MANAGEMENT OF PATIENT AND CONSUMER BEHAVIOR AND MEASURING PATIENT AND CONSUMER KNOWLEDGE, SKILL, AND CONFIDENCE OF SELF-MANAGEMENT OF HEALTH-RELATED BEHAVIOR; SOFTWARE FOR USE IN RECEIVING, COLLECTING, STORING, ORGANIZING, ANALYZING, EVALUATING, REPORTING, AND DISPLAYING PATIENT AND CONSUMER BEHAVIOR DATA AND INFORMATION; SOFTWARE FOR USE IN CONDUCTING PATIENT AND CONSUMER SURVEYS AND ASSESSMENTS (U.S. CLS. 21, 23, 26, 36 AND 38).

CLASS 16—PAPER GOODS AND PRINTED MATTER

FOR PRINTED MATERIALS, NAMELY, SURVEYS AND ASSESSMENTS IN THE FIELD OF PATIENT AND CONSUMER HEALTH CARE BEHAVIOR; PRINTED MATERIALS, NAMELY, TRAINING AND EDUCATIONAL GUIDES IN THE FIELDS OF PATIENT AND CONSUMER HEALTHCARE BEHAVIOR ASSESSMENT, MODIFICATION, AND MANAGEMENT (U.S. CLS. 2, 5, 22, 23, 29, 37, 38 AND 50).

CLASS 41—EDUCATION AND ENTERTAINMENT

FOR EDUCATIONAL SERVICES, NAMELY, PROVIDING TRAINING IN THE FIELDS OF PATIENT AND CONSUMER HEALTHCARE BEHAVIOR ASSESSMENT, MODIFICATION, AND MANAGEMENT (U.S. CLS. 100, 101 AND 107).

CLASS 42—SCIENTIFIC AND COMPUTER SERVICES

FOR PROVIDING ONLINE NONDOWNLOADABLE SOFTWARE FOR USE IN ASSESSMENT, MODIFICATION, AND MANAGEMENT OF PATIENT AND CONSUMER BEHAVIOR AND MEASURING PATIENT AND CONSUMER KNOWLEDGE, SKILL, AND CONFIDENCE OF SELF-MANAGEMENT OF HEALTH-RELATED BEHAVIOR; PROVIDING ONLINE NONDOWNLOADABLE SOFTWARE FOR USE IN RECEIVING, COLLECTING, STORING, ORGANIZING, ANALYZING, EVALUATING, REPORTING, AND DISPLAYING PATIENT AND CONSUMER BEHAVIOR DATA; PROVIDING ONLINE NONDOWNLOADABLE SOFTWARE FOR USE IN CONDUCTING PATIENT AND CONSUMER SURVEYS AND ASSESSMENTS (U.S. CLS. 100 AND 101).

CLASS 44—MEDICAL, BEAUTY AND AGRICULTURAL SERVICES

FOR CONSULTING SERVICES IN THE FIELD OF PATIENT AND CONSUMER HEALTH CARE BEHAVIOR ASSESSMENT, MODIFICATION, AND MANAGEMENT; PROVISION OF INFORMATION IN THE FIELD OF PATIENT AND CONSUMER HEALTH CARE BEHAVIOR (U.S. CLS. 100 AND 101).

MATTHEW PAPPAS, EXAMINING ATTORNEY

SN 77-406,654, JED COMMUNICATIONS ASSOCIATES, INC., NEW YORK, NY. FILED 2-26-2008.

NTF

THE MARK CONSISTS OF STANDARD CHARACTERS WITHOUT CLAIM TO ANY PARTICULAR FONT, STYLE, SIZE, OR COLOR.

CLASS 5—PHARMACEUTICALS

FOR PREPARATION FOR RELIEF OF GASTROINTESTINAL DISORDERS (U.S. CLS. 6, 18, 44, 46, 51 AND 52).

CLASS 9—ELECTRICAL AND SCIENTIFIC APPARATUS

FOR EYE GLASS CASES (U.S. CLS. 21, 23, 26, 36 AND 38).

CLASS 16—PAPER GOODS AND PRINTED MATTER

FOR BUMPER STICKERS (U.S. CLS. 2, 5, 22, 23, 29, 37, 38 AND 50).

CLASS 18—LEATHER GOODS

FOR HANDBAGS, BRIEFCASES, BACKPACKS, CARRYING CASES, DUFFEL BAGS, LUGGAGE, SUITCASES, SATCHELS, SHOULDER BAGS, TOTE BAGS, WALLETS, VALISES, LEATHER AND IMITATION LEATHER KEY CHAINS AND UMBRELLAS (U.S. CLS. 1, 2, 3, 22 AND 41).

CLASS 21—HOUSEWARES AND GLASS

FOR MUGS (U.S. CLS. 2, 13, 23, 29, 30, 33, 40 AND 50).

CLASS 25—CLOTHING

FOR T-SHIRTS, TANK TOPS, SWEAT SHIRTS, JERSEYS, PANTS, SWEAT PANTS, SHORTS, WRISTBANDS, HEADBANDS, HEADWEAR, HATS, CAPS, SLEEPWEAR, PAJAMAS, LINGERIE, UNDERWEAR, UNDER GARMENTS, SOCKS, FOOTWEAR, SNEAKERS, SHOES, OUTERWEAR, NAMELY, COATS, JACKETS, RAIN JACKETS, SCARVES, GLOVES, HATS, EAR MUFFS, PARKAS, WIND RESISTANT JACKETS; BELTS (U.S. CLS. 22 AND 39).

CLASS 35—ADVERTISING AND BUSINESS

FOR ADVERTISING SERVICES (U.S. CLS. 100, 101 AND 102).
JOHN DWYER, EXAMINING ATTORNEY

CLASS 18—LEATHER GOODS

FOR HANDBAGS, BRIEFCASES, BACKPACKS, CARRYING CASES, DUFFEL BAGS, LUGGAGE, SUITCASES, SATCHELS, SHOULDER BAGS, TOTE BAGS, WALLETS, VALISES, LEATHER AND IMITATION LEATHER KEY CHAINS AND UMBRELLAS (U.S. CLS. 1, 2, 3, 22 AND 41).

CLASS 21—HOUSEWARES AND GLASS

FOR MUGS (U.S. CLS. 2, 13, 23, 29, 30, 33, 40 AND 50).

CLASS 25—CLOTHING

FOR T-SHIRTS, TANK TOPS, SWEAT SHIRTS, JERSEYS, PANTS, SWEAT PANTS, SHORTS, WRISTBANDS, HEADBANDS, HEADWEAR, HATS, CAPS, SLEEPWEAR, PAJAMAS, LINGERIE, UNDERWEAR, UNDERGARMENTS, SOCKS, FOOTWEAR, SNEAKERS, SHOES, OUTERWEAR, NAMELY, COATS, JACKETS, RAIN JACKETS, SCARVES, GLOVES, HATS, EAR MUFFS, PARKAS, WIND RESISTANT JACKETS; BELTS (U.S. CLS. 22 AND 39).

CLASS 35—ADVERTISING AND BUSINESS

FOR ADVERTISING SERVICES (U.S. CLS. 100, 101 AND 102).
JOHN DWYER, EXAMINING ATTORNEY

SN 77-406,679. JED COMMUNICATIONS ASSOCIATES, INC.,
NEW YORK, NY. FILED 2-26-2008.

SN 77-406,669. JED COMMUNICATIONS ASSOCIATES, INC.,
NEW YORK, NY. FILED 2-26-2008.

NTF "NEVER TRUST A FART"

THE MARK CONSISTS OF STANDARD CHARACTERS WITHOUT CLAIM TO ANY PARTICULAR FONT, STYLE, SIZE, OR COLOR.

CLASS 5—PHARMACEUTICALS

FOR PREPARATION FOR RELIEF OF GASTROINTESTINAL DISORDERS (U.S. CLS. 6, 18, 44, 46, 51 AND 52).

CLASS 9—ELECTRICAL AND SCIENTIFIC APPARATUS

FOR EYE GLASS CASES (U.S. CLS. 21, 23, 26, 36 AND 38).

CLASS 16—PAPER GOODS AND PRINTED MATTER

FOR BUMPER STICKERS (U.S. CLS. 2, 5, 22, 23, 29, 37, 38 AND 50).

NTAF

THE MARK CONSISTS OF STANDARD CHARACTERS WITHOUT CLAIM TO ANY PARTICULAR FONT, STYLE, SIZE, OR COLOR.

CLASS 5—PHARMACEUTICALS

FOR PREPARATION FOR RELIEF OF GASTROINTESTINAL DISORDERS (U.S. CLS. 6, 18, 44, 46, 51 AND 52).

CLASS 9—ELECTRICAL AND SCIENTIFIC APPARATUS

FOR EYE GLASS CASES (U.S. CLS. 21, 23, 26, 36 AND 38).

CLASS 16—PAPER GOODS AND PRINTED MATTER

FOR BUMPER STICKERS (U.S. CLS. 2, 5, 22, 23, 29, 37, 38 AND 50).

CLASS 18—LEATHER GOODS

FOR HANDBAGS, BRIEFCASES, BACKPACKS, CARRYING CASES, DUFFEL BAGS, LUGGAGE, SUITCASES, SATCHELS, SHOULDER BAGS, TOTE BAGS, WALLETS, VALISES, LEATHER AND IMITATION LEATHER KEY CHAINS AND UMBRELLAS (U.S. CLS. 1, 2, 3, 22 AND 41).

CLASS 21—HOUSEWARES AND GLASS

FOR MUGS (U.S. CLS. 2, 13, 23, 29, 30, 33, 40 AND 50).

CLASS 25—CLOTHING

FOR T-SHIRTS, TANK TOPS, SWEAT SHIRTS, JERSEYS, PANTS, SWEAT PANTS, SHORTS, WRISTBANDS, HEADBANDS, HEADWEAR, HATS, CAPS, SLEEPWEAR, PAJAMAS, LINGERIE, UNDERWEAR, UNDERGARMENTS, SOCKS, FOOTWEAR, SNEAKERS, SHOES, OUTERWEAR, NAMELY, COATS, JACKETS, RAIN JACKETS, SCARVES, GLOVES, HATS, EAR MUFFS, PARKAS, WIND RESISTANT JACKETS; BELTS (U.S. CLS. 22 AND 39).

CLASS 35—ADVERTISING AND BUSINESS

FOR ADVERTISING SERVICES (U.S. CLS. 100, 101 AND 102).
JOHN DWYER, EXAMINING ATTORNEY

CLASS 35—ADVERTISING AND BUSINESS

FOR ADVERTISING SERVICES (U.S. CLS. 100, 101 AND 102).
JOHN DWYER, EXAMINING ATTORNEY

SN 77-406,690. JED COMMUNICATIONS ASSOCIATES, INC., NEW YORK, NY. FILED 2-26-2008.

SN 77-406,912. PAYLOCITY CORPORATION, ARLINGTON HEIGHTS, IL. FILED 2-26-2008.

NTAF "NEVER TRUST A FART"

THE MARK CONSISTS OF STANDARD CHARACTERS WITHOUT CLAIM TO ANY PARTICULAR FONT, STYLE, SIZE, OR COLOR.



THE COLOR(S) ORANGE, RED AND GRAY IS/ARE CLAIMED AS A FEATURE OF THE MARK.
THE ORANGE DESIGN IS ORANGE, THE APPLE DESIGN IS RED, AND THE SHADING BENEATH IT IS GRAY.

CLASS 5—PHARMACEUTICALS

FOR PREPARATION FOR RELIEF OF GASTROINTESTINAL DISORDERS (U.S. CLS. 6, 18, 44, 46, 51 AND 52).

CLASS 35—ADVERTISING AND BUSINESS

FOR HUMAN RESOURCE SERVICES, NAMELY, SERVING AS A HUMAN RESOURCES DEPARTMENT FOR OTHERS, HUMAN RESOURCES MANAGEMENT, HUMAN RESOURCES CONSULTATION, PERSONNEL SELECTION FOR OTHERS; PAYROLL SERVICES FOR OTHERS, NAMELY, ADMINISTRATION OF BUSINESS PAYROLL FOR OTHERS, PAYROLL PREPARATION, PAYROLL PROCESSING SERVICES (U.S. CLS. 100, 101 AND 102).

CLASS 9—ELECTRICAL AND SCIENTIFIC APPARATUS

FOR EYE GLASS CASES (U.S. CLS. 21, 23, 26, 36 AND 38).

CLASS 36—INSURANCE AND FINANCIAL

FOR PAYROLL SERVICES FOR OTHERS, NAMELY, PAYROLL TAX DEBITING SERVICES (U.S. CLS. 100, 101 AND 102).

CLASS 16—PAPER GOODS AND PRINTED MATTER

FOR BUMPER STICKERS (U.S. CLS. 2, 5, 22, 23, 29, 37, 38 AND 50).

CLASS 42—SCIENTIFIC AND COMPUTER SERVICES

FOR COMPUTER SERVICES, NAMELY, PROVIDING TEMPORARY USE OF ONLINE NON-DOWNLOADABLE SOFTWARE FOR USE IN THE FIELDS OF PAYROLL AND HUMAN RESOURCES, NAMELY, FOR USE IN PAYROLL PREPARATION AND HUMAN RESOURCES MANAGEMENT; APPLICATION SERVICE PROVIDER (ASP) FEATURING SOFTWARE FOR USE IN THE FIELDS OF PAYROLL AND HUMAN RESOURCES, NAMELY, FOR USE IN PAYROLL PREPARATION AND HUMAN RESOURCES MANAGEMENT (U.S. CLS. 100 AND 101).
JOHN DWYER, EXAMINING ATTORNEY

CLASS 18—LEATHER GOODS

FOR HANDBAGS, BRIEFCASES, BACKPACKS, CARRYING CASES, DUFFEL BAGS, LUGGAGE, SUITCASES, SATCHELS, SHOULDER BAGS, TOTE BAGS, WALLETS, VALISES, LEATHER AND IMITATION LEATHER KEY CHAINS AND UMBRELLAS (U.S. CLS. 1, 2, 3, 22 AND 41).

CLASS 21—HOUSEWARES AND GLASS

FOR MUGS (U.S. CLS. 2, 13, 23, 29, 30, 33, 40 AND 50).

CLASS 25—CLOTHING

FOR T-SHIRTS, TANK TOPS, SWEAT SHIRTS, JERSEYS, PANTS, SWEAT PANTS, SHORTS, WRISTBANDS, HEADBANDS, HEADWEAR, HATS, CAPS, SLEEPWEAR, PAJAMAS, LINGERIE, UNDERWEAR, UNDERGARMENTS, SOCKS, FOOTWEAR, SNEAKERS, SHOES, OUTERWEAR, NAMELY, COATS, JACKETS, RAIN JACKETS, SCARVES, GLOVES, HATS, EAR MUFFS, PARKAS, WIND RESISTANT JACKETS; BELTS (U.S. CLS. 22 AND 39).

SN 77-406,927. ORGANIZATION FOR AUTISM RESEARCH, INC., ARLINGTON, VA. FILED 2-26-2008.

RUN FOR AUTISM

THE MARK CONSISTS OF STANDARD CHARACTERS WITHOUT CLAIM TO ANY PARTICULAR FONT, STYLE, SIZE, OR COLOR.

NO CLAIM IS MADE TO THE EXCLUSIVE RIGHT TO USE "AUTISM", APART FROM THE MARK AS SHOWN.

CLASS 35—ADVERTISING AND BUSINESS

FOR PROMOTING PUBLIC AWARENESS OF AUTISM (U.S. CLS. 100, 101 AND 102).
FIRST USE 10-26-2003; IN COMMERCE 10-26-2003.

CLASS 36—INSURANCE AND FINANCIAL

FOR CHARITABLE FUNDRAISING SERVICES (U.S. CLS. 100, 101 AND 102).
FIRST USE 10-26-2003; IN COMMERCE 10-26-2003.
MONIQUE MILLER, EXAMINING ATTORNEY

SN 77-406,931. PAYLOCITY CORPORATION, ARLINGTON HEIGHTS, IL. FILED 2-26-2008.



OWNER OF U.S. REG. NO. 3,326,870.

THE COLOR(S) BLACK, RED, ORANGE AND GRAY IS/ARE CLAIMED AS A FEATURE OF THE MARK.

THE MARK CONSISTS OF THE WORD "PAYLOCITY" ADJACENT AN ABSTRACT LOGO THAT IS AN AMALGAMATION OF AN ORANGE AND AN APPLE. THE WORDING "PAYLOCITY" IS BLACK. THE APPLE PORTION OF THE DESIGN IS RED. THE ORANGE PORTION OF THE DESIGN IS ORANGE. THE WAVY LINE THAT APPEARS ABOVE THE WORDING IS ORANGE AND THE WAVY LINE THAT APPEARS BELOW THE WORDING IS RED. THE SHADING BENEATH THE APPLE/ORANGE DESIGN IS GRAY.

CLASS 35—ADVERTISING AND BUSINESS

FOR HUMAN RESOURCE SERVICES, NAMELY, SERVING AS A HUMAN RESOURCES DEPARTMENT FOR OTHERS, HUMAN RESOURCES MANAGEMENT, HUMAN RESOURCES CONSULTATION, PERSONNEL SELECTION FOR OTHERS; PAYROLL SERVICES FOR OTHERS, NAMELY, ADMINISTRATION OF BUSINESS PAYROLL FOR OTHERS, PAYROLL PREPARATION, PAYROLL PROCESSING SERVICES (U.S. CLS. 100, 101 AND 102).

CLASS 36—INSURANCE AND FINANCIAL

FOR PAYROLL SERVICES FOR OTHERS, NAMELY, PAYROLL TAX DEBITING SERVICES (U.S. CLS. 100, 101 AND 102).

CLASS 42—SCIENTIFIC AND COMPUTER SERVICES

FOR COMPUTER SERVICES, NAMELY, PROVIDING TEMPORARY USE OF ONLINE NON-DOWNLOADABLE SOFTWARE FOR USE IN THE FIELDS OF PAYROLL AND HUMAN RESOURCES, NAMELY, FOR USE IN PAYROLL PREPARATION AND HUMAN RESOURCES MANAGEMENT; APPLICATION SERVICE PROVIDER (ASP) FEATURING SOFTWARE FOR USE IN THE FIELDS OF PAYROLL AND HUMAN RESOURCES, NAMELY, FOR USE IN PAYROLL PREPARATION AND HUMAN RESOURCES MANAGEMENT (U.S. CLS. 100 AND 101).

JOHN DWYER, EXAMINING ATTORNEY

SN 77-406,935. ORGANIZATION FOR AUTISM RESEARCH, INC., ARLINGTON, VA. FILED 2-26-2008.



NO CLAIM IS MADE TO THE EXCLUSIVE RIGHT TO USE "AUTISM", APART FROM THE MARK AS SHOWN.

THE COLOR(S) BLUE AND YELLOW IS/ARE CLAIMED AS A FEATURE OF THE MARK.

THE MARK CONSISTS OF THE STYLIZED TERM "OAR" IN YELLOW ABOVE THE WORDING "RUN FOR AUTISM" IN YELLOW WITH A BLUE SWOOSH IN BETWEEN AND ALONGSIDE THE BLUE SILHOUETTES OF A MALE AND FEMALE RUNNER.

CLASS 35—ADVERTISING AND BUSINESS

FOR PROMOTING PUBLIC AWARENESS OF AUTISM (U.S. CLS. 100, 101 AND 102).
FIRST USE 6-16-2005; IN COMMERCE 6-16-2005.

CLASS 36—INSURANCE AND FINANCIAL

FOR CHARITABLE FUNDRAISING SERVICES (U.S. CLS. 100, 101 AND 102).
FIRST USE 6-16-2005; IN COMMERCE 6-16-2005.
MONIQUE MILLER, EXAMINING ATTORNEY

SN 77-406,938. CONSUMERHEALTH, INC., NEWPORT BEACH, CA. FILED 2-26-2008.

NEWPORT DENTAL PLAN

THE MARK CONSISTS OF STANDARD CHARACTERS WITHOUT CLAIM TO ANY PARTICULAR FONT, STYLE, SIZE, OR COLOR.

NO CLAIM IS MADE TO THE EXCLUSIVE RIGHT TO USE "DENTAL PLAN", APART FROM THE MARK AS SHOWN.

CLASS 36—INSURANCE AND FINANCIAL

FOR DENTAL HEALTH INSURANCE UNDERWRITING AND ADMINISTRATION (U.S. CLS. 100, 101 AND 102).
FIRST USE 7-0-1985; IN COMMERCE 7-0-1985.

CLASS 44—MEDICAL, BEAUTY AND AGRICULTURAL SERVICES

FOR DENTIST SERVICES; DENTAL HYGIENIST SERVICES (U.S. CLS. 100 AND 101).
FIRST USE 7-0-1985; IN COMMERCE 7-0-1985.
MONIQUE MILLER, EXAMINING ATTORNEY

CLASS 42—SCIENTIFIC AND COMPUTER SERVICES

FOR COMPUTER SERVICES, NAMELY, PROVIDING TEMPORARY USE OF ONLINE NON-DOWNLOADABLE SOFTWARE FOR USE IN THE FIELDS OF PAYROLL AND HUMAN RESOURCES, NAMELY, FOR USE IN PAYROLL PREPARATION AND HUMAN RESOURCES MANAGEMENT; APPLICATION SERVICE PROVIDER (ASP) FEATURING SOFTWARE FOR USE IN THE FIELDS OF PAYROLL AND HUMAN RESOURCES, NAMELY, FOR USE IN PAYROLL PREPARATION AND HUMAN RESOURCES MANAGEMENT (U.S. CLS. 100 AND 101).
JOHN DWYER, EXAMINING ATTORNEY

SN 77-406,953. PAYLOCITY CORPORATION, ARLINGTON HEIGHTS, IL. FILED 2-26-2008.

SN 77-407,291. OMNICOMM SYSTEMS, INC., FORT LAUDERDALE, FL. FILED 2-27-2008.



REDEFINING THE WORLD OF PAYROLL + HR

OWNER OF U.S. REG. NO. 3,326,870.
NO CLAIM IS MADE TO THE EXCLUSIVE RIGHT TO USE "PAYROLL HR", APART FROM THE MARK AS SHOWN.
THE COLOR(S) BLACK, RED AND ORANGE AND GRAY IS/ARE CLAIMED AS A FEATURE OF THE MARK.
THE MARK CONSISTS OF THE WORD "PAYLOCITY" AND AN ABSTRACT AMALGAMATION MARK OF AN ORANGE AND AN APPLE WITH THE WORDS "REDEFINING THE WORLD OF PAYROLL + HR" UNDERNEATH THE MARK. THE WORDING "PAYLOCITY" AND "REDEFINING THE WORLD OF PAYROLL + HR", AND THE HORIZONTAL LINE ARE BLACK. THE APPLE PORTION OF THE DESIGN IS RED. THE ORANGE PORTION OF THE DESIGN IS ORANGE. THE WAVY LINE THAT APPEARS ABOVE THE WORDING "PAYLOCITY" IS ORANGE AND THE WAVY LINE THAT APPEARS BELOW THE WORDING "PAYLOCITY" IS RED. THE SHADING BENEATH THE APPLE/ORANGE DESIGN IS GRAY.

CLASS 35—ADVERTISING AND BUSINESS

FOR HUMAN RESOURCE SERVICES, NAMELY, SERVING AS A HUMAN RESOURCES DEPARTMENT FOR OTHERS, HUMAN RESOURCES MANAGEMENT, HUMAN RESOURCES CONSULTATION, PERSONNEL SELECTION FOR OTHERS; PAYROLL SERVICES FOR OTHERS, NAMELY, ADMINISTRATION OF BUSINESS PAYROLL FOR OTHERS, PAYROLL PREPARATION, PAYROLL PROCESSING SERVICES (U.S. CLS. 100, 101 AND 102).

CLASS 36—INSURANCE AND FINANCIAL

FOR PAYROLL SERVICES FOR OTHERS, NAMELY, PAYROLL TAX DEBITING SERVICES (U.S. CLS. 100, 101 AND 102).

OMNICOMM SYSTEMS

THE MARK CONSISTS OF STANDARD CHARACTERS WITHOUT CLAIM TO ANY PARTICULAR FONT, STYLE, SIZE, OR COLOR.
NO CLAIM IS MADE TO THE EXCLUSIVE RIGHT TO USE "SYSTEMS", APART FROM THE MARK AS SHOWN.

CLASS 35—ADVERTISING AND BUSINESS

FOR MARKETING SERVICES FOR DATABASE SOFTWARE THAT ALLOWS CLINICAL TRIAL SPONSORS TO SECURELY COLLECT CLINICAL TRIAL DATA VIA THE WEB, AND TRAINING, VALIDATION AND CONSULTING SERVICES RELATED THERETO (U.S. CLS. 100, 101 AND 102).
FIRST USE 0-0-1996; IN COMMERCE 0-0-1996.

CLASS 42—SCIENTIFIC AND COMPUTER SERVICES

FOR DEVELOPING DATABASE SOFTWARE THAT ALLOWS CLINICAL TRIAL SPONSORS TO SECURELY COLLECT CLINICAL TRIAL DATA VIA THE WEB, AND TRAINING, VALIDATION AND CONSULTING SERVICES RELATED THERETO (U.S. CLS. 100 AND 101).
FIRST USE 0-0-1996; IN COMMERCE 0-0-1996.
JOHN DALIER, EXAMINING ATTORNEY

SN 77-407,293. GBP HOLDINGS, INC., ST. PAUL, MN. FILED 2-27-2008.

THE POWER TO CHANGE THE WAY YOU SEND MONEY

THE MARK CONSISTS OF STANDARD CHARACTERS WITHOUT CLAIM TO ANY PARTICULAR FONT, STYLE, SIZE, OR COLOR.

CLASS 9—ELECTRICAL AND SCIENTIFIC APPARATUS

FOR POINT OF SALE (POS) EQUIPMENT FOR FINANCIAL SERVICES, NAMELY TERMINALS AND PRINTERS; COMPUTER SOFTWARE FOR TRANSMISSION, PROCESSING AND RECEIPT OF DATA FOR USE IN THE FINANCIAL SERVICES FIELD; MAGNETICALLY ENCODED BANKING CARDS AND DEBIT CARDS FOR BANKING AND DEBIT CARD SERVICES; MAGNETICALLY ENCODED CUSTOMER DISCOUNT CARDS (U.S. CLS. 21, 23, 26, 36 AND 38).

CLASS 36—INSURANCE AND FINANCIAL

FOR FINANCIAL SERVICES, NAMELY, CLEARING HOUSE SERVICES, BANKING, CREDIT INQUIRY AND CONSULTATION, CREDIT RECOVERY AND COLLECTION, CURRENCY EXCHANGE AND ADVICE, ELECTRONIC FUNDS TRANSFER; ELECTRONIC PAYMENT, NAMELY, ELECTRONIC PROCESSING AND TRANSMISSION OF BILL PAYMENT DATA, ELECTRONIC CREDIT AND DEBIT TRANSACTION PROCESSING, PROCESSING PAYMENTS TO THIRD PARTIES, MONEY ORDER SERVICES, CHECK PROCESSING, ELECTRONIC CHECK RE-PRESENTMENT SERVICES, ISSUANCE OF TRAVELERS' CHECKS, CHECK VERIFICATION, BILL PAYMENT SERVICES; FINANCIAL AGENCY SERVICES FOR ALL OF THE FOREGOING (U.S. CLS. 100, 101 AND 102).

CLASS 38—COMMUNICATION

FOR COMMUNICATIONS SERVICES, NAMELY ELECTRONIC TRANSMISSION OF VOICE AND DATA FOR FINANCIAL TRANSACTIONS (U.S. CLS. 100, 101 AND 104).

CARYN GLASSER, EXAMINING ATTORNEY

SN 77-407,376. OMNICOMM SYSTEMS, INC., FORT LAUDERDALE, FL. FILED 2-27-2008.

OMNIADVANCE

THE MARK CONSISTS OF STANDARD CHARACTERS WITHOUT CLAIM TO ANY PARTICULAR FONT, STYLE, SIZE, OR COLOR.

CLASS 37—CONSTRUCTION AND REPAIR

FOR INSTALLATION OF COMPUTER NETWORKS AND COMPUTER HARDWARE (U.S. CLS. 100, 103 AND 106).

CLASS 42—SCIENTIFIC AND COMPUTER SERVICES

FOR INSTALLATION AND MAINTENANCE OF COMPUTER SOFTWARE; COMPUTER SERVICES, NAMELY, DATABASE DEVELOPMENT SERVICES, NAMELY, CONFIGURATION OF COMPUTER DATABASES CONTAINING INFORMATION REGARDING CLINICAL TRIALS; COMPUTER TECHNOLOGY SUPPORT SERVICES, NAMELY, HELP DESK SERVICES (U.S. CLS. 100 AND 101).

JOHN DALIER, EXAMINING ATTORNEY

SN 77-407,682. SHARP EVENTS, LLC, SAN FRANCISCO, CA. FILED 2-27-2008.

SIGNAL EVENT GROUP

THE MARK CONSISTS OF STANDARD CHARACTERS WITHOUT CLAIM TO ANY PARTICULAR FONT, STYLE, SIZE, OR COLOR.

NO CLAIM IS MADE TO THE EXCLUSIVE RIGHT TO USE "EVENT GROUP", APART FROM THE MARK AS SHOWN.

CLASS 35—ADVERTISING AND BUSINESS

FOR ARRANGING OF BUSINESS EXPOSITIONS, EVENTS, MEETINGS, CONVENTIONS, TRADE SHOWS IN THE FIELDS OF AUTOMOBILES, COMPUTER DEVELOPMENT, CONSUMER ELECTRONICS, THE ENVIRONMENT, GAMING, HI-TECH PRODUCTS, HI-TECH USER GROUPS, INFORMATION SYSTEMS, MANUFACTURING, MEDICAL, PHARMACOLOGY, RETAIL, SECURITY, SOFTWARE, AND SPORTS EQUIPMENT, CONFERENCES AND PRODUCT PRESENTATIONS FOR OTHERS; ARRANGING AND CONDUCTING BUSINESS EXPOSITIONS, EVENTS, MEETINGS, CONVENTIONS, TRADE SHOWS IN THE FIELDS OF AUTOMOBILES, COMPUTER DEVELOPMENT, CONSUMER ELECTRONICS, THE ENVIRONMENT, GAMING, HI-TECH PRODUCTS, HI-TECH USER GROUPS, INFORMATION SYSTEMS, MANUFACTURING, MEDICAL, PHARMACOLOGY, RETAIL, SECURITY, SOFTWARE, AND SPORTS EQUIPMENT, CONFERENCES AND PRODUCT PRESENTATIONS FOR OTHERS; PREPARING AND PUBLICATION OF PROMOTIONAL MATERIALS FOR OTHERS; BUSINESS CONFERENCE MANAGEMENT; MANAGEMENT OF TRAINING SESSIONS FOR OTHERS (U.S. CLS. 100, 101 AND 102).

CLASS 40—MATERIAL TREATMENT

FOR CUSTOM CONSTRUCTION OF PROPS FOR BUSINESS EXPOSITIONS, EVENTS, MEETINGS, CONVENTIONS, TRADE SHOWS, CONFERENCES AND PRESENTATIONS; RENTAL OF POWER-GENERATING EQUIPMENT FOR BUSINESS EXPOSITIONS, EVENTS, MEETINGS, CONVENTIONS, TRADE SHOWS, CONFERENCES AND PRESENTATIONS (U.S. CLS. 100, 103 AND 106).

CLASS 41—EDUCATION AND ENTERTAINMENT

FOR FILM AND VIDEOTAPE PRODUCTION; PROVIDING LIVE, MULTIMEDIA AND OTHER FORMS OF ENTERTAINMENT, NAMELY, BOOKING LIVE MUSICAL PERFORMANCES PROVIDED BY OTHERS AND ARRANGING FOR PRERECORDED BACKGROUND MUSIC; SPECIAL EVENT PLANNING CONSULTATION; SPECIAL EVENT PLANNING SERVICES, NAMELY PROVIDING EVENT DESIGN, COORDINATION, ENTERTAINMENT, SITE SELECTION, LOGISTICAL SERVICES; RENTAL OF SCENERY, PROPS, AND SETS FOR THEATRICAL PRODUCTIONS AND ENTERTAINMENT AT CORPORATE EVENTS, POLITICAL EVENTS AND GOLF TOURNAMENTS; ENTERTAINMENT, NAMELY, LIGHTING PRODUCTION, OPERATION OF AUDIO EQUIPMENT, AND RENTAL OF AUDIO EQUIPMENT, ALL FOR BUSINESS EXPOSITIONS, EVENTS, MEETINGS, CONVENTIONS, TRADE SHOWS, CONFERENCES AND PRESENTATIONS (U.S. CLS. 100, 101 AND 107).

ROBIN MITTLER, EXAMINING ATTORNEY

SN 77-407,707. INSIGNIA HEALTH, LLC, PORTLAND, OR. FILED 2-27-2008.

PATIENT ACTIVATION MEASURE

THE MARK CONSISTS OF STANDARD CHARACTERS WITHOUT CLAIM TO ANY PARTICULAR FONT, STYLE, SIZE, OR COLOR.

NO CLAIM IS MADE TO THE EXCLUSIVE RIGHT TO USE "PATIENT" AND "MEASURE", APART FROM THE MARK AS SHOWN.

CLASS 9—ELECTRICAL AND SCIENTIFIC APPARATUS

FOR SOFTWARE FOR USE IN ASSESSMENT, MODIFICATION, AND MANAGEMENT OF PATIENT AND CONSUMER BEHAVIOR AND MEASURING PATIENT AND CONSUMER KNOWLEDGE, SKILL, AND CONFIDENCE OF SELF-MANAGEMENT OF HEALTH-RELATED BEHAVIOR; SOFTWARE FOR USE IN CONDUCTING PATIENT AND CONSUMER SURVEYS AND ASSESSMENTS (U.S. CLS. 21, 23, 26, 36 AND 38).

CLASS 16—PAPER GOODS AND PRINTED MATTER

FOR PRINTED MATERIALS, NAMELY, SURVEYS AND ASSESSMENTS IN THE FIELD OF PATIENT AND CONSUMER HEALTH CARE BEHAVIOR (U.S. CLS. 2, 5, 22, 23, 29, 37, 38 AND 50).

CLASS 42—SCIENTIFIC AND COMPUTER SERVICES

FOR PROVIDING ONLINE NONDOWNLOADABLE SOFTWARE FOR USE IN ASSESSMENT, MODIFICATION, AND MANAGEMENT OF PATIENT AND CONSUMER BEHAVIOR AND MEASURING PATIENT AND CONSUMER KNOWLEDGE, SKILL, AND CONFIDENCE OF SELF-MANAGEMENT OF HEALTH-RELATED BEHAVIOR; PROVIDING ONLINE NONDOWNLOADABLE SOFTWARE FOR USE IN CONDUCTING PATIENT AND CONSUMER SURVEYS AND ASSESSMENTS (U.S. CLS. 100 AND 101).

MATTHEW PAPPAS, EXAMINING ATTORNEY

SN 77-407,709. INSIGNIA HEALTH, LLC, PORTLAND, OR. FILED 2-27-2008.

COACHING FOR ACTIVATION

THE MARK CONSISTS OF STANDARD CHARACTERS WITHOUT CLAIM TO ANY PARTICULAR FONT, STYLE, SIZE, OR COLOR.

CLASS 9—ELECTRICAL AND SCIENTIFIC APPARATUS

FOR SOFTWARE FOR USE IN ASSESSMENT, MODIFICATION, AND MANAGEMENT OF PATIENT AND CONSUMER BEHAVIOR AND MEASURING PATIENT AND CONSUMER KNOWLEDGE, SKILL, AND CONFIDENCE OF SELF-MANAGEMENT OF HEALTH-RELATED BEHAVIOR (U.S. CLS. 21, 23, 26, 36 AND 38).

CLASS 41—EDUCATION AND ENTERTAINMENT

FOR EDUCATIONAL SERVICES, NAMELY, PROVIDING TRAINING IN THE FIELDS OF PATIENT AND CONSUMER HEALTHCARE BEHAVIOR ASSESSMENT, MODIFICATION, AND MANAGEMENT (U.S. CLS. 100, 101 AND 107).

CLASS 42—SCIENTIFIC AND COMPUTER SERVICES

FOR PROVIDING ONLINE NONDOWNLOADABLE SOFTWARE FOR USE IN ASSESSMENT, MODIFICATION, AND MANAGEMENT OF PATIENT AND CONSUMER BEHAVIOR AND MEASURING PATIENT AND CONSUMER KNOWLEDGE, SKILL, AND CONFIDENCE OF SELF-MANAGEMENT OF HEALTH-RELATED BEHAVIOR (U.S. CLS. 100 AND 101).

MATTHEW PAPPAS, EXAMINING ATTORNEY

SN 77-407,950. DICI, ABRAHAM, DANVILLE, CA. FILED 2-27-2008.

LOUDFARM

THE MARK CONSISTS OF STANDARD CHARACTERS WITHOUT CLAIM TO ANY PARTICULAR FONT, STYLE, SIZE, OR COLOR.

CLASS 35—ADVERTISING AND BUSINESS

FOR ONLINE ADVERTISING AND MARKETING SERVICES (U.S. CLS. 100, 101 AND 102).

CLASS 41—EDUCATION AND ENTERTAINMENT

FOR PROVIDING LINKS TO THE WEBSITES OF OTHERS FEATURING ONLINE ENTERTAINMENT TICKET AGENCY SERVICES; ENTERTAINMENT SERVICES, NAMELY, PROVIDING A WEBSITE FEATURING NEWS AND INFORMATION IN THE FIELDS OF MUSIC, MUSIC VENUE SCHEDULES, MUSIC ARTISTS, AND ENTERTAINMENT (U.S. CLS. 100, 101 AND 107).

SONYA STEPHENS, EXAMINING ATTORNEY

SN 77-407,970. CHAMPION FITNESS LLC, DBA FIVE POINTS FITNESS, NEW YORK, NY. FILED 2-27-2008.

Five Points Fitness

THE MARK CONSISTS OF STANDARD CHARACTERS WITHOUT CLAIM TO ANY PARTICULAR FONT, STYLE, SIZE, OR COLOR.

NO CLAIM IS MADE TO THE EXCLUSIVE RIGHT TO USE "FITNESS", APART FROM THE MARK AS SHOWN.

CLASS 28—TOYS AND SPORTING GOODS

FOR (BASED ON INTENT TO USE) BOXING GLOVES, KARATE SHIN PADS, SHIN GUARDS FOR ATHLETIC USE, KARATE HEAD GUARDS, AND KARATE KICK PADS (U.S. CLS. 22, 23, 38 AND 50).

CLASS 41—EDUCATION AND ENTERTAINMENT

FOR (BASED ON USE IN COMMERCE) PROVIDING FITNESS AND EXERCISE FACILITIES, MARTIAL ARTS INSTRUCTION, OPERATING OF MARTIAL ARTS' SCHOOLS, AND GYMNASIUMS (U.S. CLS. 100, 101 AND 107).

FIRST USE 4-28-2005; IN COMMERCE 9-1-2005.
WENDY GOODMAN, EXAMINING ATTORNEY

CLASS 1—CHEMICALS

FOR BIOCHEMICALS, NAMELY, MONOCLONAL ANTIBODIES FOR IN VITRO SCIENTIFIC OR RESEARCH USE; DIAGNOSTIC KITS CONSISTING PRIMARILY OF MONOCLONAL ANTIBODIES, BUFFERS, AND REAGENTS TO MONITOR TOXICITY OF DRUGS; LABORATORY CHEMICALS, NAMELY, AN ANTIBODY REAGENT USED FOR THE DETECTION OF ANTIGENS IN CELL AND TISSUE ANALYSIS FOR IN VITRO DIAGNOSTIC USE (U.S. CLS. 1, 5, 6, 10, 26 AND 46).

CLASS 5—PHARMACEUTICALS

FOR DIAGNOSTIC KITS CONSISTING PRIMARILY OF MONOCLONAL ANTIBODIES, BUFFERS, AND REAGENTS FOR USE IN DISEASE TESTING (U.S. CLS. 18, 44, 46, 51 AND 52).

ALYSSA STEEL, EXAMINING ATTORNEY

SN 77-408,106. EWINWIN, INC., TAMPA, FL. FILED 2-28-2008.

SN 77-408,853. WHITE LOTUS MEDIA LIMITED, KOWLOON, HONG KONG, FILED 2-28-2008.

Cojinga

THE MARK CONSISTS OF STANDARD CHARACTERS WITHOUT CLAIM TO ANY PARTICULAR FONT, STYLE, SIZE, OR COLOR.

THE WORDING "COJINGA" HAS NO MEANING IN ENGLISH.

CLASS 9—ELECTRICAL AND SCIENTIFIC APPARATUS

FOR ELECTRONICALLY ENCODED CARDS AND MAGNETICALLY ENCODED CARDS FOR USE IN CONNECTION WITH GROUP PURCHASING ACTIVITY (U.S. CLS. 21, 23, 26, 36 AND 38).

CLASS 35—ADVERTISING AND BUSINESS

FOR ADMINISTRATION OF A PROGRAM FOR ENABLING PARTICIPANTS TO OBTAIN DISCOUNTS, REWARDS, AND INCENTIVES ON GOODS AND SERVICES THROUGH USE OF AN ELECTRONICALLY ENCODED OR MAGNETICALLY ENCODED CARD (U.S. CLS. 100, 101 AND 102).

KIM MONINGHOFF, EXAMINING ATTORNEY

SN 77-408,125. BIOCARE MEDICAL LLC LTD, CONCORD, CA. FILED 2-28-2008.

PIN-4

THE MARK CONSISTS OF STANDARD CHARACTERS WITHOUT CLAIM TO ANY PARTICULAR FONT, STYLE, SIZE, OR COLOR.

AVENJ: ROYAL CULTURE SOCIETY

THE MARK CONSISTS OF STANDARD CHARACTERS WITHOUT CLAIM TO ANY PARTICULAR FONT, STYLE, SIZE, OR COLOR.

CLASS 18—LEATHER GOODS

FOR ALL-PURPOSE SPORT BAGS, ALL-PURPOSE ATHLETIC BAGS, BACKPACKS, BOOK BAGS, SPORTS BAGS, BUM BAGS, WALLETTS AND HANDBAGS (U.S. CLS. 1, 2, 3, 22 AND 41).

CLASS 25—CLOTHING

FOR T-SHIRTS, WOVEN SHIRTS, JEANS, JACKETS, BLAZERS, TIES, SWEATERS, SHORTS (U.S. CLS. 22 AND 39).

LINDA MICKLEBURGH, EXAMINING ATTORNEY

SN 77-408,909. WHITE LOTUS MEDIA LIMITED, KOWLOON, HONG KONG, FILED 2-28-2008.

SINARELLA: FLOATING WORLD COUTURE

THE MARK CONSISTS OF STANDARD CHARACTERS WITHOUT CLAIM TO ANY PARTICULAR FONT, STYLE, SIZE, OR COLOR.

NO CLAIM IS MADE TO THE EXCLUSIVE RIGHT TO USE "COUTURE", APART FROM THE MARK AS SHOWN.

CLASS 18—LEATHER GOODS

FOR ALL-PURPOSE SPORT BAGS, ALL-PURPOSE ATHLETIC BAGS, BACKPACKS, BOOK BAGS, SPORTS BAGS, BUM BAGS, WALLETTS AND HANDBAGS (U.S. CLS. 1, 2, 3, 22 AND 41).

CLASS 25—CLOTHING

FOR T-SHIRTS, LADIES CASUAL DRESSES, WOVEN BLOUSES, JEANS, CASUAL JACKETS (U.S. CLS. 22 AND 39).

LINDA MICKLEBURGH, EXAMINING ATTORNEY

SN 77-409,035. SEARS BRANDS, LLC, HOFFMAN ESTATES, IL. FILED 2-28-2008.

SN 77-409,028. SEARS BRANDS, LLC, HOFFMAN ESTATES, IL. FILED 2-28-2008.

WOODLAND YULE

TWILIGHT FROST

THE MARK CONSISTS OF STANDARD CHARACTERS WITHOUT CLAIM TO ANY PARTICULAR FONT, STYLE, SIZE, OR COLOR.

THE MARK CONSISTS OF STANDARD CHARACTERS WITHOUT CLAIM TO ANY PARTICULAR FONT, STYLE, SIZE, OR COLOR.

NO CLAIM IS MADE TO THE EXCLUSIVE RIGHT TO USE "YULE", APART FROM THE MARK AS SHOWN.

CLASS 4—LUBRICANTS AND FUELS

FOR CANDLES (U.S. CLS. 1, 6 AND 15).

CLASS 4—LUBRICANTS AND FUELS

FOR CANDLES (U.S. CLS. 1, 6 AND 15).

CLASS 11—ENVIRONMENTAL CONTROL APPARATUS

FOR ELECTRIC LIGHTS FOR CHRISTMAS TREES; OUTDOOR LIGHTED CHRISTMAS ORNAMENTS; ELECTRIC HOLIDAY LIGHTS; ELECTRIC HOLIDAY LIGHTS, NAMELY, ICICLE AND MESH LIGHTS AND LIGHT STRINGS; ELECTRIC LIGHT BULBS AND REPLACEMENT LIGHT BULBS; LIGHTED PARTY OR HOLIDAY-THEMED DECORATIONS; ELECTRIC LIGHT DECORATIVE STRINGS (U.S. CLS. 13, 21, 23, 31 AND 34).

CLASS 11—ENVIRONMENTAL CONTROL APPARATUS

FOR ELECTRIC LIGHTS FOR CHRISTMAS TREES; OUTDOOR LIGHTED CHRISTMAS ORNAMENTS; ELECTRIC HOLIDAY LIGHTS; ELECTRIC HOLIDAY LIGHTS, NAMELY, ICICLE AND MESH LIGHTS AND LIGHT STRINGS; ELECTRIC LIGHT BULBS AND REPLACEMENT LIGHT BULBS; LIGHTED PARTY OR HOLIDAY-THEMED DECORATIONS; ELECTRIC LIGHT DECORATIVE STRINGS (U.S. CLS. 13, 21, 23, 31 AND 34).

CLASS 21—HOUSEWARES AND GLASS

FOR CHRISTMAS, HOLIDAY OR SEASONAL DINNERWARE AND BEVERAGWARE; CHRISTMAS, HOLIDAY OR SEASONAL SERVINGWARE FOR SERVING FOOD (U.S. CLS. 2, 13, 23, 29, 30, 33, 40 AND 50).

CLASS 21—HOUSEWARES AND GLASS

FOR CHRISTMAS, HOLIDAY OR SEASONAL DINNERWARE AND BEVERAGWARE; CHRISTMAS, HOLIDAY OR SEASONAL SERVINGWARE FOR SERVING FOOD (U.S. CLS. 2, 13, 23, 29, 30, 33, 40 AND 50).

CLASS 24—FABRICS

FOR TABLE LINENS, NAMELY PLACEMATS AND NAPKINS MADE OF TEXTILES (U.S. CLS. 42 AND 50).

CLASS 24—FABRICS

FOR TABLE LINENS, NAMELY PLACEMATS AND NAPKINS MADE OF TEXTILES (U.S. CLS. 42 AND 50).

CLASS 27—FLOOR COVERINGS

FOR RUGS AND CHRISTMAS, HOLIDAY OR SEASONAL-THEMED RUGS (U.S. CLS. 19, 20, 37, 42 AND 50).

CLASS 27—FLOOR COVERINGS

FOR RUGS AND CHRISTMAS, HOLIDAY OR SEASONAL-THEMED RUGS (U.S. CLS. 19, 20, 37, 42 AND 50).

CLASS 28—TOYS AND SPORTING GOODS

FOR ARTIFICIAL CHRISTMAS TREES AND WREATHS (U.S. CLS. 22, 23, 38 AND 50).

CLASS 28—TOYS AND SPORTING GOODS

FOR ARTIFICIAL CHRISTMAS TREES AND WREATHS (U.S. CLS. 22, 23, 38 AND 50).

CLASS 35—ADVERTISING AND BUSINESS

FOR RETAIL DEPARTMENT STORE SERVICES FEATURING CHRISTMAS, HOLIDAY AND SEASONAL PRODUCTS (U.S. CLS. 100, 101 AND 102).
HANNO RITTNER, EXAMINING ATTORNEY

CLASS 35—ADVERTISING AND BUSINESS

FOR RETAIL DEPARTMENT STORE SERVICES FEATURING CHRISTMAS, HOLIDAY AND SEASONAL PRODUCTS (U.S. CLS. 100, 101 AND 102).
HANNO RITTNER, EXAMINING ATTORNEY

SN 77-409,043. CORTERA, INC., BOCA RATON, FL. FILED 2-28-2008.

CORTERA

THE MARK CONSISTS OF STANDARD CHARACTERS WITHOUT CLAIM TO ANY PARTICULAR FONT, STYLE, SIZE, OR COLOR.

CLASS 9—ELECTRICAL AND SCIENTIFIC APPARATUS

FOR COMPUTER SOFTWARE, NAMELY, CREDIT AND COLLECTIONS DECISIONS, ANALYSIS AND WORKFLOW AUTOMATION SOFTWARE IN THE FIELD OF FINANCE AND CREDIT; COMPUTER SOFTWARE TO PROVIDE AND FACILITATE OBTAINING CREDIT REPORTS AND INFORMATION REGARDING BUSINESSES AND FINANCIAL INSTITUTIONS AND ORGANIZATIONS, AND TO FACILITATE CREDIT DECISIONS AND MANAGEMENT OF ACCOUNTS RECEIVABLE (U.S. CLS. 21, 23, 26, 36 AND 38).

CLASS 36—INSURANCE AND FINANCIAL

FOR PROVIDING ON-LINE INFORMATION SERVICES IN THE FIELD OF CREDIT AND FINANCING FOR BUSINESSES AND FINANCIAL INSTITUTIONS AND ORGANIZATIONS; ONLINE SERVICE TO PROVIDE AND FACILITATE OBTAINING CREDIT REPORTS AND INFORMATION REGARDING BUSINESSES AND FINANCIAL INSTITUTIONS AND ORGANIZATIONS, AND TO FACILITATE CREDIT DECISIONS AND MANAGEMENT OF ACCOUNTS RECEIVABLE (U.S. CLS. 100, 101 AND 102).

CLASS 42—SCIENTIFIC AND COMPUTER SERVICES

FOR PROVIDING ONLINE NON-DOWNLOADABLE SOFTWARE WHICH ALLOWS USERS TO OBTAIN AND REVIEW BUSINESS INFORMATION IN THE NATURE OF CREDIT REPORTS AND FINANCIAL INFORMATION REGARDING BUSINESS AND FINANCIAL INSTITUTIONS AND ORGANIZATIONS, FOR USE IN FACILITATING CREDIT DECISIONS AND MANAGEMENT OF ACCOUNTS RECEIVABLE; PROVIDING ONLINE NON-DOWNLOADABLE SOFTWARE WHICH ALLOWS USERS TO CONDUCT BUSINESS RESEARCH TO GENERATE INFORMATION REGARDING BUSINESSES, FINANCIAL INSTITUTIONS AND ORGANIZATIONS (U.S. CLS. 100 AND 101).

DOMINICK J. SALEMI, EXAMINING ATTORNEY

SN 77-409,227. UNITED SUPPORT OF ARTISTS FOR AFRICA, DBA WE ARE THE WORLD II/ WE ARE THE WORLD 2, LOS ANGELES, CA. FILED 2-28-2008.

WE ARE THE WORLD 2

THE MARK CONSISTS OF STANDARD CHARACTERS WITHOUT CLAIM TO ANY PARTICULAR FONT, STYLE, SIZE, OR COLOR.

CLASS 9—ELECTRICAL AND SCIENTIFIC APPARATUS

FOR CDS, DVDS AND PRE-RECORDED VIDEO TAPES FEATURING MUSICAL PERFORMANCES AND EDUCATIONAL INFORMATION RELATING TO YOUTH VIOLENCE GLOBALLY; DOWNLOADABLE VIDEOS FEATURING MUSICAL PERFORMANCES (U.S. CLS. 21, 23, 26, 36 AND 38).

CLASS 25—CLOTHING

FOR APPAREL, NAMELY, T-SHIRTS, SWEATSHIRTS, CAPS, WRISTBANDS SOLD TO PROMOTE AND SUPPORT CHARITABLE FUNDING FOR PROGRAMS THAT WORK AGAINST AND RAISE PUBLIC AWARENESS OF YOUTH VIOLENCE GLOBALLY (U.S. CLS. 22 AND 39).

CLASS 36—INSURANCE AND FINANCIAL

FOR CHARITABLE FUNDING SERVICES TO SUPPORT PROJECTS AGAINST YOUTH VIOLENCE GLOBALLY, CHARITABLE SERVICES, NAMELY, PROVIDING GRANTS FOR PROGRAMS THAT WORK AGAINST YOUTH VIOLENCE; CHARITABLE FUNDRAISING TO SUPPORT EDUCATIONAL ACTIVITIES AND WORLDWIDE AWARENESS OF AND PROGRAMS AGAINST YOUTH VIOLENCE GLOBALLY (U.S. CLS. 100, 101 AND 102).

CLASS 41—EDUCATION AND ENTERTAINMENT

FOR WEB SITE FEATURING EDUCATIONAL INFORMATION REGARDING AND RAISING AWARENESS OF YOUTH VIOLENCE GLOBALLY (U.S. CLS. 100, 101 AND 107).

ESTHER A. BORSUK, EXAMINING ATTORNEY

SN 77-409,365. OMNICOMM SYSTEMS, INC., FORT LAUDERDALE, FL. FILED 2-29-2008.

FIRST IN FUNCTIONALITY

THE MARK CONSISTS OF STANDARD CHARACTERS WITHOUT CLAIM TO ANY PARTICULAR FONT, STYLE, SIZE, OR COLOR.

CLASS 35—ADVERTISING AND BUSINESS

FOR MARKETING SERVICES FOR DATABASE SOFTWARE THAT ALLOWS CLINICAL TRIAL SPONSORS TO SECURELY COLLECT CLINICAL TRIAL DATA VIA THE WEB, AND TRAINING, VALIDATION AND CONSULTING SERVICES RELATED THERETO (U.S. CLS. 100, 101 AND 102).

FIRST USE 4-0-2007; IN COMMERCE 4-0-2007.

CLASS 42—SCIENTIFIC AND COMPUTER SERVICES

FOR DEVELOPING DATABASE SOFTWARE THAT ALLOWS CLINICAL TRIAL SPONSORS TO SECURELY COLLECT CLINICAL TRIAL DATA VIA THE WEB, AND TRAINING, VALIDATION AND CONSULTING SERVICES RELATED THERETO (U.S. CLS. 100 AND 101).

FIRST USE 4-0-2007; IN COMMERCE 4-0-2007.
JOHN DALIER, EXAMINING ATTORNEY

SN 77-409,378. OMNICOMM SYSTEMS, INC., FORT LAUDERDALE, FL. FILED 2-29-2008.

SN 77-409,769. CATCHLIGHT ENERGY, LLC, SAN RAMON, CA. FILED 2-29-2008.

OMNIREPORT

THE MARK CONSISTS OF STANDARD CHARACTERS WITHOUT CLAIM TO ANY PARTICULAR FONT, STYLE, SIZE, OR COLOR.

CLASS 9—ELECTRICAL AND SCIENTIFIC APPARATUS

FOR COMPUTER HARDWARE, NAMELY, INTEGRATED CIRCUIT MODULES FOR COMPUTERS FOR USE WITH CLINICAL LABORATORY TESTING DATABASES AND USED IN FOR RAPID CUSTOM REPORT WRITING; SOFTWARE FOR USE WITH CLINICAL LABORATORY TESTING DATABASES AND USED IN FOR RAPID CUSTOM REPORT WRITING; DOWNLOADABLE SOFTWARE FOR USE WITH CLINICAL LABORATORY TESTING DATABASES AND USED IN FOR RAPID CUSTOM REPORT WRITING (U.S. CLS. 21, 23, 26, 36 AND 38).

CLASS 42—SCIENTIFIC AND COMPUTER SERVICES

FOR PROVIDING TEMPORARY USE OF NON-DOWNLOADABLE SOFTWARE FOR USE WITH CLINICAL LABORATORY TESTING DATABASES AND USED IN FOR RAPID CUSTOM REPORT WRITING (U.S. CLS. 100 AND 101).

JOHN DALIER, EXAMINING ATTORNEY

SN 77-409,573. WHITE LOTUS MEDIA LIMITED, KOWLOON, HONG KONG, FILED 2-29-2008.

NIKI PRETTY: KITTY CATURE

THE MARK CONSISTS OF STANDARD CHARACTERS WITHOUT CLAIM TO ANY PARTICULAR FONT, STYLE, SIZE, OR COLOR.

CLASS 18—LEATHER GOODS

FOR ALL-PURPOSE SPORT BAGS, ALL-PURPOSE ATHLETIC BAGS, BACKPACKS, BOOK BAGS, SPORTS BAGS, BUM BAGS, WALLETS AND HANDBAGS (U.S. CLS. 1, 2, 3, 22 AND 41).

CLASS 25—CLOTHING

FOR T-SHIRTS, LADIES CASUAL DRESSES, WOVEN BLOUSES, SHIRTS, CASUAL JACKETS (U.S. CLS. 22 AND 39).

LINDA MICKLEBURGH, EXAMINING ATTORNEY

CATCHLIGHT ENERGY

THE MARK CONSISTS OF STANDARD CHARACTERS WITHOUT CLAIM TO ANY PARTICULAR FONT, STYLE, SIZE, OR COLOR.

NO CLAIM IS MADE TO THE EXCLUSIVE RIGHT TO USE "ENERGY", APART FROM THE MARK AS SHOWN.

CLASS 1—CHEMICALS

FOR CHEMICAL GASOLINE ADDITIVE; FERTILIZERS; CHEMICALS AND CHEMICAL INTERMEDIATES FOR GENERAL USE IN THE INDUSTRIAL ARTS (U.S. CLS. 1, 5, 6, 10, 26 AND 46).

CLASS 4—LUBRICANTS AND FUELS

FOR FOSSIL FUEL SUBSTITUTES, NAMELY, BIO-FUELS AND CELLULOSIC ETHANOL; ETHANOL FUEL; ALCOHOL AND MIXED ALCOHOL FUEL; ARTIFICIAL PETROLEUM; BIODIESEL FUEL; FOSSIL FUEL SUBSTITUTE, NAMELY, BIODIESEL; FUELS DERIVED FROM RENEWABLE SOURCES; FUEL DERIVED FROM PLANTS, NON-FOOD CROPS; BIOMASS FUEL; FUELS FOR MOTOR VEHICLES; AVIATION FUELS; INDUSTRIAL FUELS; NON-CHEMICAL BIO-ADDITIVES FOR FUELS; NON-CHEMICAL ADDITIVES FOR FUELS AND OILS (U.S. CLS. 1, 6 AND 15).

CLASS 6—METAL GOODS

FOR METAL KEY CHAINS; OIL CANS, STORAGE DRUMS, GENERAL PURPOSE STORAGE CONTAINERS, RECYCLE BINS, ALL MADE OF METAL AND SOLD EMPTY (U.S. CLS. 2, 12, 13, 14, 23, 25 AND 50).

CLASS 7—MACHINERY

FOR RENEWABLE ENERGY MACHINES, NAMELY, MACHINES FOR CREATING FUEL FROM BIOLOGICAL MATERIAL, DRY ORGANIC MATTER, OR COMBUSTIBLE OILS (U.S. CLS. 13, 19, 21, 23, 31, 34 AND 35).

CLASS 11—ENVIRONMENTAL CONTROL APPARATUS

FOR BIOFUEL POWER PLANT; ETHANOL POWER PLANT; FERMENTATION VESSELS FOR THE PRODUCTION OF ETHANOL FUEL (U.S. CLS. 13, 21, 23, 31 AND 34).

CLASS 16—PAPER GOODS AND PRINTED MATTER

FOR DESK PADS, NOTEBOOKS, CALENDARS, POSTERS (U.S. CLS. 2, 5, 22, 23, 29, 37, 38 AND 50).

CLASS 18—LEATHER GOODS

FOR BAGS FOR TRAVEL; ATHLETIC BAGS; FANNY PACKS; BRIEF CASES; BRIEF CASE-TYPE PORTFOLIOS; LUGGAGE TAGS AND GARMENT BAGS FOR TRAVEL (U.S. CLS. 1, 2, 3, 22 AND 41).

CLASS 25—CLOTHING

FOR CLOTHING, NAMELY, T-SHIRTS, JACKETS, CAPS, HATS, KNIT SHIRTS AND SWEATSHIRTS (U.S. CLS. 22 AND 39).

CLASS 37—CONSTRUCTION AND REPAIR

FOR REAL ESTATE SITE SELECTION AND DEVELOPMENT, NAMELY, THE SELECTION OF SITES FOR AND DEVELOPMENT OF BIOFUEL PROPERTIES; AND BUILDING CONSTRUCTION, MAINTENANCE, AND REPAIR (U.S. CLS. 100, 103 AND 106).

CLASS 40—MATERIAL TREATMENT

FOR PROVIDING INFORMATION IN THE FIELDS OF ENERGY PRODUCTION AND BIOFUEL PRODUCTION; BIOFUEL REFINING SERVICES; CUSTOM MANUFACTURE OF BIOFUELS; TREATMENT OF MATERIALS, NAMELY, PRODUCTION OF FUELS AND ENERGY FROM BIOLOGICAL AND OTHER RENEWABLE SOURCES INCLUDING NON-FOOD CROPS; CONVERSION OF BIOMASS TO ETHANOL FUEL; FUEL TREATMENT SERVICES, NAMELY, PROCESSING OF BIOFUEL AND BIODIESEL FUEL; WASTE RECYCLING AND WASTE RECLAMATION (U.S. CLS. 100, 103 AND 106).

THEODORE MCBRIDE, EXAMINING ATTORNEY

SN 77-409,770, CATCHLIGHT ENERGY, LLC, SAN RAMON, CA. FILED 2-29-2008.



NO CLAIM IS MADE TO THE EXCLUSIVE RIGHT TO USE "ENERGY", APART FROM THE MARK AS SHOWN.

THE COLOR(S) BLUE, GREEN, YELLOW, BLACK AND WHITE IS/ARE CLAIMED AS A FEATURE OF THE MARK.

THE MARK CONSISTS OF TWO INTERSECTING HEXAGONS. THE COLOR YELLOW APPEARS IN THE UPPER-MOST HEXAGON, THE COLOR BLUE APPEARS IN THE LOWER HEXAGON, AND THE COLOR GREEN APPEARS IN THE OVERLAPPING SECTION OF THE TWO HEXAGONS. THE TERMS "CATCHLIGHT ENERGY" APPEAR IN THE COLOR BLACK TO THE LOWER LEFT OF THE DESIGN. THE LITERAL ELEMENT AND DESIGN APPEAR ON A FIELD OF WHITE.

CLASS 1—CHEMICALS

FOR CHEMICAL GASOLINE ADDITIVE; FERTILIZERS; CHEMICALS AND CHEMICAL INTERMEDIATES FOR GENERAL USE IN THE INDUSTRIAL ARTS (U.S. CLS. 1, 5, 6, 10, 26 AND 46).

CLASS 4—LUBRICANTS AND FUELS

FOR FOSSIL FUEL SUBSTITUTES, NAMELY, BIOFUELS AND CELLULOSIC ETHANOL; ETHANOL FUEL; ALCOHOL AND MIXED ALCOHOL FUEL; ARTIFICIAL PETROLEUM; BIODIESEL FUEL; FOSSIL FUEL SUBSTITUTE, NAMELY, BIODIESEL; FUELS DERIVED FROM RENEWABLE SOURCES; FUEL DERIVED FROM PLANTS, NON-FOOD CROPS; BIOMASS FUEL; FUELS FOR MOTOR VEHICLES; AVIATION FUELS; INDUSTRIAL FUELS; NON-CHEMICAL BIO-ADDITIVES FOR FUELS; NON-CHEMICAL ADDITIVES FOR FUELS AND OILS (U.S. CLS. 1, 6 AND 15).

CLASS 6—METAL GOODS

FOR METAL KEY CHAINS; OIL CANS, STORAGE DRUMS, GENERAL PURPOSE STORAGE CONTAINERS, RECYCLE BINS, ALL MADE OF METAL AND SOLD EMPTY (U.S. CLS. 2, 12, 13, 14, 23, 25 AND 50).

CLASS 7—MACHINERY

FOR RENEWABLE ENERGY MACHINES, NAMELY, MACHINES FOR CREATING FUEL FROM BIOLOGICAL MATERIAL, DRY ORGANIC MATTER, OR COMBUSTIBLE OILS (U.S. CLS. 13, 19, 21, 23, 31, 34 AND 35).

CLASS 11—ENVIRONMENTAL CONTROL APPARATUS

FOR BIOFUEL POWER PLANT; ETHANOL POWER PLANT; FERMENTATION VESSELS FOR THE PRODUCTION OF ETHANOL FUEL (U.S. CLS. 13, 21, 23, 31 AND 34).

CLASS 16—PAPER GOODS AND PRINTED MATTER

FOR DESK PADS, NOTEBOOKS, CALENDARS, POSTERS (U.S. CLS. 2, 5, 22, 23, 29, 37, 38 AND 50).

CLASS 18—LEATHER GOODS

FOR BAGS FOR TRAVEL; ATHLETIC BAGS; FANNY PACKS; BRIEF CASES; BRIEF CASE-TYPE PORTFOLIOS; LUGGAGE TAGS AND GARMENT BAGS FOR TRAVEL (U.S. CLS. 1, 2, 3, 22 AND 41).

CLASS 25—CLOTHING

FOR CLOTHING, NAMELY, T-SHIRTS, JACKETS, CAPS, HATS, KNIT SHIRTS AND SWEATSHIRTS (U.S. CLS. 22 AND 39).

CLASS 37—CONSTRUCTION AND REPAIR

FOR REAL ESTATE SITE SELECTION AND DEVELOPMENT, NAMELY, THE SELECTION OF SITES FOR AND DEVELOPMENT OF BIOFUEL PROPERTIES; AND BUILDING CONSTRUCTION, MAINTENANCE, AND REPAIR (U.S. CLS. 100, 103 AND 106).

CLASS 40—MATERIAL TREATMENT

FOR PROVIDING INFORMATION IN THE FIELDS OF ENERGY PRODUCTION AND BIOFUEL PRODUCTION; BIOFUEL REFINING SERVICES; CUSTOM MANUFACTURE OF BIOFUELS; TREATMENT OF MATERIALS, NAMELY, PRODUCTION OF FUELS AND ENERGY FROM BIOLOGICAL AND OTHER RENEWABLE SOURCES INCLUDING NON-FOOD CROPS; CONVERSION OF BIOMASS TO ETHANOL FUEL; FUEL TREATMENT SERVICES, NAMELY, PROCESSING OF BIOFUEL AND BIODIESEL FUEL; WASTE RECYCLING AND WASTE RECLAMATION (U.S. CLS. 100, 103 AND 106).

THEODORE MCBRIDE, EXAMINING ATTORNEY

SN 77-409,772. CATCHLIGHT ENERGY, LLC, SAN RAMON, CA. FILED 2-29-2008.



THE COLOR(S) BLUE, GREEN AND YELLOW IS/ARE CLAIMED AS A FEATURE OF THE MARK.

THE MARK CONSISTS OF TWO INTERSECTING HEXAGONS. THE COLOR YELLOW APPEARS IN THE UPPER-MOST HEXAGON, THE COLOR BLUE APPEARS IN THE LOWER HEXAGON, AND THE COLOR GREEN APPEARS IN THE OVERLAPPING SECTION OF THE TWO HEXAGONS.

CLASS 1—CHEMICALS

FOR CHEMICAL GASOLINE ADDITIVE; FERTILIZERS; CHEMICALS AND CHEMICAL INTERMEDIATES FOR GENERAL USE IN THE INDUSTRIAL ARTS (U.S. CLS. 1, 5, 6, 10, 26 AND 46).

CLASS 4—LUBRICANTS AND FUELS

FOR FOSSIL FUEL SUBSTITUTES, NAMELY, BIO-FUELS AND CELLULOSIC ETHANOL; ETHANOL FUEL; ALCOHOL AND MIXED ALCOHOL FUEL; ARTIFICIAL PETROLEUM; BIODIESEL FUEL; FOSSIL FUEL SUBSTITUTE, NAMELY, BIODIESEL; FUELS DERIVED FROM RENEWABLE SOURCES; FUEL DERIVED FROM PLANTS, NON-FOOD CROPS; BIOMASS FUEL; FUELS FOR MOTOR VEHICLES; AVIATION FUELS; INDUSTRIAL FUELS; NON-CHEMICAL BIO-ADDITIVES FOR FUELS; NON-CHEMICAL ADDITIVES FOR FUELS AND OILS (U.S. CLS. 1, 6 AND 15).

CLASS 6—METAL GOODS

FOR METAL KEY CHAINS; OIL CANS, STORAGE DRUMS, GENERAL PURPOSE STORAGE CONTAINERS, RECYCLE BINS, ALL MADE OF METAL AND SOLD EMPTY (U.S. CLS. 2, 12, 13, 14, 23, 25 AND 50).

CLASS 7—MACHINERY

FOR RENEWABLE ENERGY MACHINES, NAMELY, MACHINES FOR CREATING FUEL FROM BIOLOGICAL MATERIAL, DRY ORGANIC MATTER, OR COMBUSTIBLE OILS (U.S. CLS. 13, 19, 21, 23, 31, 34 AND 35).

CLASS 11—ENVIRONMENTAL CONTROL APPARATUS

FOR BIOFUEL POWER PLANT; ETHANOL POWER PLANT; FERMENTATION VESSELS FOR THE PRODUCTION OF ETHANOL FUEL (U.S. CLS. 13, 21, 23, 31 AND 34).

CLASS 16—PAPER GOODS AND PRINTED MATTER

FOR DESK PADS, NOTEBOOKS, CALENDARS, POSTERS (U.S. CLS. 2, 5, 22, 23, 29, 37, 38 AND 50).

CLASS 18—LEATHER GOODS

FOR BAGS FOR TRAVEL; ATHLETIC BAGS; FANNY PACKS; BRIEF CASES; BRIEF CASE-TYPE PORTFOLIOS; LUGGAGE TAGS AND GARMENT BAGS FOR TRAVEL (U.S. CLS. 1, 2, 3, 22 AND 41).

CLASS 25—CLOTHING

FOR CLOTHING, NAMELY, T-SHIRTS, JACKETS, CAPS, HATS, KNIT SHIRTS AND SWEATSHIRTS (U.S. CLS. 22 AND 39).

CLASS 37—CONSTRUCTION AND REPAIR

FOR REAL ESTATE SITE SELECTION AND DEVELOPMENT, NAMELY, THE SELECTION OF SITES FOR AND DEVELOPMENT OF BIOFUEL PROPERTIES; AND BUILDING CONSTRUCTION, MAINTENANCE, AND REPAIR (U.S. CLS. 100, 103 AND 106).

CLASS 40—MATERIAL TREATMENT

FOR PROVIDING INFORMATION IN THE FIELDS OF ENERGY PRODUCTION AND BIOFUEL PRODUCTION; BIOFUEL REFINING SERVICES; CUSTOM MANUFACTURE OF BIOFUELS; TREATMENT OF MATERIALS, NAMELY, PRODUCTION OF FUELS AND ENERGY FROM BIOLOGICAL AND OTHER RENEWABLE SOURCES INCLUDING NON-FOOD CROPS; CONVERSION OF BIOMASS TO ETHANOL FUEL; FUEL TREATMENT SERVICES, NAMELY, PROCESSING OF BIOFUEL AND BIODIESEL FUEL; WASTE RECYCLING AND WASTE RECLAMATION (U.S. CLS. 100, 103 AND 106).

THEODORE MCBRIDE, EXAMINING ATTORNEY

SN 77-409,879. SYN-ICE GROUP, LLC, IONIA, MI. FILED 2-29-2008.



NO CLAIM IS MADE TO THE EXCLUSIVE RIGHT TO USE "ICE", APART FROM THE MARK AS SHOWN.

THE MARK CONSISTS OF THE WORD "ICE" ABOVE THE TERM "SYN" WHERE THE "Y" IN THE TERM "SYN" IS A FLOWING "Y" IN THE GENERAL SHAPE OF A PERSON WITH HAND STRECHED UPWARD.

CLASS 28—TOYS AND SPORTING GOODS

FOR ARTIFICIAL ICE SKATING SURFACES THAT ARE NOT FROZEN (U.S. CLS. 22, 23, 38 AND 50).

CLASS 37—CONSTRUCTION AND REPAIR

FOR CONSULTING SERVICES IN THE FIELD OF ARTIFICIAL ICE RINK CONSTRUCTION AND RESURFACING (U.S. CLS. 100, 103 AND 106).

MICHAEL SOUDERS, EXAMINING ATTORNEY

SN 77-409,886. SYN-ICE GROUP, LLC, IONIA, MI. FILED 2-29-2008.

Syn-Ice

THE MARK CONSISTS OF STANDARD CHARACTERS WITHOUT CLAIM TO ANY PARTICULAR FONT, STYLE, SIZE, OR COLOR.

CLASS 28—TOYS AND SPORTING GOODS

FOR ARTIFICIAL ICE SKATING SURFACES THAT ARE NOT FROZEN (U.S. CLS. 22, 23, 38 AND 50).

CLASS 37—CONSTRUCTION AND REPAIR

FOR CONSULTING SERVICES IN THE FIELD OF ARTIFICIAL ICE RINK CONSTRUCTION AND RESURFACING (U.S. CLS. 100, 103 AND 106).

MICHAEL SOUDERS, EXAMINING ATTORNEY

SN 77-409,945. SHELLY STEFFEE INC., NEW YORK, NY. FILED 2-29-2008.

SHELLY STEFFEE

THE MARK CONSISTS OF STANDARD CHARACTERS WITHOUT CLAIM TO ANY PARTICULAR FONT, STYLE, SIZE, OR COLOR.

THE NAME "SHELLY STEFFEE" IDENTIFIES A LIVING INDIVIDUAL WHOSE CONSENT IS OF RECORD.

CLASS 18—LEATHER GOODS

FOR HANDBAGS (U.S. CLS. 1, 2, 3, 22 AND 41).
FIRST USE 8-15-1999; IN COMMERCE 8-15-1999.

CLASS 25—CLOTHING

FOR WOMEN'S CLOTHING, NAMELY, DRESSES, JUMPSUITS, COATS, JACKETS, VESTS, PANTS, SHORTS, SKIRTS, SWEATERS, KNITS, WOVEN TOPS, BELTS, HEADWEAR, SCARVES, HEADBANDS, WRAPS, GLOVES (U.S. CLS. 22 AND 39).

FIRST USE 8-15-1999; IN COMMERCE 8-15-1999.
FRANK LATTUCA, EXAMINING ATTORNEY

SN 77-410,237. HOWDINI, INC., MIDLOTHIAN, VA. FILED 2-29-2008.

HOWDINI

THE MARK CONSISTS OF STANDARD CHARACTERS WITHOUT CLAIM TO ANY PARTICULAR FONT, STYLE, SIZE, OR COLOR.

CLASS 9—ELECTRICAL AND SCIENTIFIC APPARATUS

FOR ELECTRONIC DOWNLOADABLE PUBLICATIONS IN THE NATURE OF MAGAZINES IN THE FIELD OF HOME, GARDEN, SEX, ROMANCE, STYLE, BEAUTY, FOOD, COOKING, ENTERTAINING, HEALTH AND WELL-BEING, WHEELS AND MOTORS, KIDS, GETTING ALONG WITH OTHERS, MONEY, PETS, TRAVEL, COMPUTERS, ELECTRONICS, BUSINESS, SMALL BUSINESS, WORK, CAREERS, GREEN LIVING, LEISURE & HOBBIES, CRAFTS, FUN, HUMOR, NEWS, CHARITY, GIVING, FITNESS AND SPORTS; AUDIO AND VIDEO RECORDINGS FEATURING CONTENT IN THE FIELD OF HOME, GARDEN, SEX, ROMANCE, STYLE, BEAUTY, FOOD, COOKING, ENTERTAINING, HEALTH AND WELL-BEING, WHEELS AND MOTORS, KIDS, GETTING ALONG WITH OTHERS, MONEY, PETS, TRAVEL, COMPUTERS AND ELECTRONICS, BUSINESS, SMALL BUSINESS, WORK, CAREERS, GREEN LIVING, LEISURE & HOBBIES, CRAFTS, FUN, HUMOR, NEWS, CHARITY, GIVING AND FITNESS AND SPORTS (U.S. CLS. 21, 23, 26, 36 AND 38).

FIRST USE 6-15-2007; IN COMMERCE 6-15-2007.

CLASS 35—ADVERTISING AND BUSINESS

FOR ADVERTISING SERVICES, PUBLIC RELATIONS AND MARKETING SERVICES, NAMELY, PROMOTING AND MARKETING THE GOODS AND SERVICES OF OTHERS THROUGH ALL PUBLIC COMMUNICATION CHANNELS (U.S. CLS. 100, 101 AND 102).

FIRST USE 6-15-2007; IN COMMERCE 6-15-2007.

CLASS 38—COMMUNICATION

FOR TELEVISION TRANSMISSION SERVICES, NAMELY, SATELLITE AND CABLE TRANSMISSION OF TELEVISION PROGRAMMING; WEBCASTING SERVICES; TRANSMITTING AND STREAMING ELECTRONIC AND DIGITAL AUDIO, VIDEO, GRAPHICS, TEXT, SIGNALS, MESSAGES, NEWS, DATA AND INFORMATION VIA GLOBAL COMPUTER NETWORKS, PORTABLE AND WIRELESS ELECTRONIC AND DIGITAL COMMUNICATION DEVICES; PROVIDING ON-LINE CHAT ROOMS AND ELECTRONIC BULLETIN BOARDS FOR TRANSMISSION OF MESSAGES AMONG USERS IN THE FIELD OF GENERAL INTEREST (U.S. CLS. 100, 101 AND 104).

FIRST USE 6-15-2007; IN COMMERCE 6-15-2007.

CLASS 41—EDUCATION AND ENTERTAINMENT

FOR ENTERTAINMENT SERVICES IN THE NATURE OF PROGRAMMING, PRODUCTION, AND DISTRIBUTION OF NEWS PROGRAMS, ENTERTAINMENT AND EDUCATIONAL SHORTS AND PROGRAMS, OVER THE INTERNET; ENTERTAINMENT SERVICES IN THE NATURE OF PROGRAMMING, PRODUCTION, AND DISTRIBUTION OF NEWS PROGRAMS, ENTERTAINMENT AND EDUCATIONAL SHORTS AND PROGRAMS FOR TELEVISION; ENTERTAINMENT SERVICES IN THE NATURE OF PROGRAMMING, PRODUCTION, AND DISTRIBUTION OF NEWS PROGRAMS, ENTERTAINMENT AND EDUCATIONAL SHORTS AND PROGRAMS, OVER MOBILE DEVICES; INTERACTIVE WEB SITE IN THE NATURE OF AN ONLINE CHANNEL PROVIDING EDUCATIONAL AND ENTERTAINMENT AUDIO AND VIDEO RECORDINGS IN THE FIELDS OF NEWS, SPORTS, ENTERTAINMENT, EDUCATION, AND MUSIC; PROVIDING ON-LINE PUBLICATIONS IN THE NATURE OF AN INTERACTIVE MAGAZINE IN THE FIELDS OF NEWS, SPORTS, ENTERTAINMENT, EDUCATION, AND MUSIC (U.S. CLS. 100, 101 AND 107).

FIRST USE 6-15-2007; IN COMMERCE 6-15-2007.
CHRISTINA SOBRAL, EXAMINING ATTORNEY

SN 77-410,327. WTS COMMUNICATION LTD, LONDON, UNITED KINGDOM, FILED 2-29-2008.

SN 77-411,044. SANDVIK INTELLECTUAL PROPERTY AB, SANDVIKEN, SWEDEN, FILED 3-3-2008.



CLASS 35—ADVERTISING AND BUSINESS

FOR ON-LINE ADVERTISING ON COMPUTER COMMUNICATION NETWORKS; ADVERTISING AND PUBLICITY SERVICES; RENTAL OF ADVERTISING TIME ON COMMUNICATION MEDIA; UPDATING OF ADVERTISING MATERIAL (U.S. CLS. 100, 101 AND 102).

CLASS 38—COMMUNICATION

FOR PROVIDING INTERNET CHATROOMS (U.S. CLS. 100, 101 AND 104).
BARNEY CHARLON, EXAMINING ATTORNEY

SN 77-410,385. LA HACIENDA MARKET, AUSTIN, TX. FILED 2-29-2008.

La Hacienda Market

THE MARK CONSISTS OF STANDARD CHARACTERS WITHOUT CLAIM TO ANY PARTICULAR FONT, STYLE, SIZE, OR COLOR.

NO CLAIM IS MADE TO THE EXCLUSIVE RIGHT TO USE "MARKET", APART FROM THE MARK AS SHOWN.

CLASS 29—MEATS AND PROCESSED FOODS

FOR DRIED FRUIT AND VEGETABLES (U.S. CL. 46).
FIRST USE 4-1-2007; IN COMMERCE 4-1-2007.

CLASS 30—STAPLE FOODS

FOR MEAT CURES; DRIED CHILI PEPPERS (U.S. CL. 46).
FIRST USE 4-1-2007; IN COMMERCE 4-1-2007.

CLASS 35—ADVERTISING AND BUSINESS

FOR RETAIL GROCERY STORES (U.S. CLS. 100, 101 AND 102).
FIRST USE 4-1-2007; IN COMMERCE 4-1-2007.
TASNEEM HUSSAIN, EXAMINING ATTORNEY

SANDVIK

THE MARK CONSISTS OF STANDARD CHARACTERS WITHOUT CLAIM TO ANY PARTICULAR FONT, STYLE, SIZE, OR COLOR.

OWNER OF SWEDEN REG. NO. 398651, DATED 11-7-2008, EXPIRES 11-7-2018.

OWNER OF U.S. REG. NOS. 1,097,910, 1,205,972 AND OTHERS.

THE FOREIGN WORDING IN THE MARK TRANSLATES INTO ENGLISH AS "SANDY BEACH".

CLASS 7—MACHINERY

FOR MACHINE PARTS, NAMELY, METAL NOZZLES WHICH ARE PARTS OF POWER-OPERATED SPRAYERS; PILE-EXTRACTORS FOR USE IN MINES; MINE BORERS; TUNNELING MACHINES FOR USE IN MINING; SIFTING MACHINES FOR SIFTING ROCKS AND GRAVEL; MACHINE PARTS, NAMELY, DRILL BITS FOR MACHINES; DRILLING MACHINES; MACHINE PARTS, NAMELY, DRILL CHUCKS; POWER DRILL PARTS, NAMELY, DRILL CHISELS, DRILL BUTTONS; DRILLING RIGS, FLOATING AND NOT FLOATING; MILLING MACHINES, GRINDING MACHINES, SHARPENING MACHINES; MACHINE PARTS, NAMELY, GRINDSTONES; FEEDERS FOR ROCK CRUSHING MACHINES; MACHINE PARTS, NAMELY, BELT CONVEYORS; PNEUMATIC TRANSPORTERS; CONVEYOR MACHINES; PULLEYS BEING PARTS OF MACHINES; HAMMERS BEING PARTS OF MACHINES; PNEUMATIC HAMMERS; PNEUMATIC CONTROLS FOR MACHINES, MOTORS AND ENGINES; MACHINES FOR INDUSTRIAL USE, NAMELY, PNEUMATIC VIBRATORS; CUTTING MACHINES; MACHINE PARTS, NAMELY, BLADES AND BLADE HOLDERS; HANDLING APPARATUS FOR LOADING AND UNLOADING, NAMELY, CONVEYOR BELTS; DIGGER AND EARTH MOVING MACHINES, NAMELY, EXCAVATORS; COAL LOADING MACHINES, ROCK LOADING MACHINES; POWER OPERATED DRILL PARTS, NAMELY, DRILL RODS AND DRILL BARS; EARTH MOVING MACHINES, NAMELY, LOADERS (U.S. CLS. 13, 19, 21, 23, 31, 34 AND 35).

CLASS 9—ELECTRICAL AND SCIENTIFIC APPARATUS

FOR COMPUTER PROGRAMS AND SOFTWARE FOR OPERATING AUTOMATED MACHINES IN MINES OPERATED BY A PERSON LOCATED OUTSIDE THE MINE AND ABOVE THE GROUND; COMPUTERS; COMPUTER PERIPHERAL EQUIPMENT; VEHICLE DRIVE TRAINING SIMULATORS FOR STEERING AND CONTROL OF DRILLING VEHICLES; ELECTRONIC APPARATUS FOR THE REMOTE CONTROL OF INDUSTRIAL OPERATIONS; ELECTRIC INSTALLATIONS FOR THE REMOTE CONTROL OF INDUSTRIAL OPERATIONS; CYCLIC MOTIONS, NAMELY, CIRCUIT BREAKERS; AUTOMATIC WATERING INSTALLATIONS, NAMELY, AUTOMATIC FIRE PROTECTION SPRINKLERS (U.S. CLS. 21, 23, 26, 36 AND 38).

CLASS 12—VEHICLES

FOR MINE CARTS; UNDERGROUND MINING HAULING APPARATUS FOR HAULING ROCK AND ORE, NAMELY, MINING CARTS (U.S. CLS. 19, 21, 23, 31, 35 AND 44).

CLASS 37—CONSTRUCTION AND REPAIR

FOR REPAIR OF MINING AND CONSTRUCTION EQUIPMENT; PROVIDING INFORMATION IN THE FIELD OF CONSTRUCTING MINES AND BUILDINGS (U.S. CLS. 100, 103 AND 106).

CLASS 38—COMMUNICATION

FOR TRANSFER AND TRANSMISSION OF DATABASE INFORMATION VIA TELECOMMUNICATIONS NETWORKS; PROVIDING INFORMATION ON ACCESS TO TELECOMMUNICATION NETWORKS VIA A PORTAL WEBSITE (U.S. CLS. 100, 101 AND 104).

APRIL HESIK, EXAMINING ATTORNEY

CLASS 9—ELECTRICAL AND SCIENTIFIC APPARATUS

FOR DIGITAL MEDIA, NAMELY, PRE-RECORDED DIGITAL MEDIA, DVDS, DOWNLOADABLE FILES AND OPTICAL AND MAGNETIC DISKS CONTAINING AUDIO, VIDEO, STILL AND MOVING IMAGES, AND DATA RECORDINGS IN COMPRESSED AND UNCOMPRESSED FORM, FEATURING ENTERTAINMENT IN THE NATURE OF ARTICLES, PHOTO GALLERIES AND VIDEOS, INFORMATION AND INSTRUCTION RELATING TO AUTOMOBILES FOR AUTOMOBILE ENTHUSIASTS; DOWNLOADABLE MULTIMEDIA FILES CONTAINING ARTWORK, TEXT, AUDIO, VIDEO, AND INTERNET WEB LINKS RELATING TO AUTOMOBILES AND FOR AUTOMOTIVE ENTHUSIASTS (U.S. CLS. 21, 23, 26, 36 AND 38).

SN 77-411,843. O'REILLY MEDIA, INC., SEBASTOPOL, CA. FILED 3-3-2008.

CLASS 35—ADVERTISING AND BUSINESS

FOR MAIL ORDER CATALOG AND ON-LINE RETAIL STORE SERVICES FEATURING CLOTHING, SOUND AND VIDEO RECORDINGS, BOOKS, MAGAZINES, GAMES AND TOYS, AND MERCHANDISE RELATED TO AUTOMOTIVE INTERESTS (U.S. CLS. 100, 101 AND 102).

MAKER SQUARE

THE MARK CONSISTS OF STANDARD CHARACTERS WITHOUT CLAIM TO ANY PARTICULAR FONT, STYLE, SIZE, OR COLOR.

OWNER OF U.S. REG. NO. 3,198,969.

CLASS 35—ADVERTISING AND BUSINESS

FOR RETAIL STORE SERVICES FEATURING MAGAZINES, BOOKS, CLOTHING, MUGS, CRAFT KITS, DO-IT-YOURSELF ELECTRONICS KITS, AND HOBBY KITS (U.S. CLS. 100, 101 AND 102).

CLASS 41—EDUCATION AND ENTERTAINMENT

FOR EDUCATIONAL SERVICES, NAMELY, CONDUCTING INTERACTIVE DEMONSTRATIONS AND WORKSHOPS IN THE FIELDS OF TECHNOLOGY, SCIENCE, MUSIC, CULTURE, TRANSPORTATION, INNOVATION, WEATHER, ARTS, CRAFTS, SEWING, KNITTING, FOOD, COOKING, TOYS, AND RECYCLING (U.S. CLS. 100, 101 AND 107).

SARA THOMAS, EXAMINING ATTORNEY

CLASS 38—COMMUNICATION

FOR RADIO, TELEVISION, CABLE TELEVISION, AND SATELLITE RADIO AND TELEVISION BROADCASTING AND TRANSMISSION; INTERACTIVE RADIO AND TELEVISION BROADCASTING AND TRANSMISSION; SUBSCRIPTION TELEVISION AND VIDEO-ON-DEMAND BROADCASTING AND TRANSMISSION; BROADCASTING AND TRANSMISSION OF RADIO AND TELEVISION PROGRAMS; DATA TRANSMISSION AND DATA BROADCASTING OVER HIGH SPEED TELEPHONE, CABLE TELEVISION, SATELLITE TELEVISION AND RADIO FREQUENCY NETWORKS; VIDEO AND AUDIO STREAMING VIA COMMUNICATION AND COMPUTER NETWORKS; ELECTRONIC TRANSMISSION OF TEXT, MESSAGES, INFORMATION, SOUND AND IMAGES VIA COMMUNICATION AND COMPUTER NETWORKS; BROADCASTING AND TRANSMISSION OF DIGITAL INFORMATION BY MEANS OF CABLE TELEVISION, SATELLITE TELEVISION RADIO, TELEPHONE AND COMPUTER; PROVIDING ONLINE FORUMS FOR THE TRANSMISSION OF MESSAGES AMONG COMPUTER USERS CONCERNING TOPICS OF INTEREST TO AUTOMOTIVE ENTHUSIASTS; MESSAGE SENDING VIA TELEPHONES, CELLULAR PHONES, FACSIMILE MACHINES, AND MODEMS; PROVIDING TELECOMMUNICATIONS CONNECTIONS TO A GLOBAL COMPUTER NETWORK; ELECTRONIC TRANSMISSION OF DATA CONTAINED IN DATABANKS, NAMELY, THE DISPLAY OF INFORMATION FROM A COMPUTER STORED DATA BANK; ELECTRONIC TRANSMISSION OF INFORMATION, MESSAGES, TEXT, IMAGES AND DATA (U.S. CLS. 100, 101 AND 104).

SN 77-412,531. MOTR, INC., ALISO VIEJO, CA. FILED 3-4-2008.

CLASS 41—EDUCATION AND ENTERTAINMENT

FOR ENTERTAINMENT SERVICES, NAMELY, ORGANIZING EXHIBITIONS, COMPETITIONS, CONTESTS, GAMES, QUIZZES, FUN DAYS, SHOWS, ROAD SHOWS, STAGE EVENTS, THEATRICAL PERFORMANCES, CONCERTS, LIVE PERFORMANCES, AND AUDIENCE PARTICIPATION EVENTS, PERTAINING TO OR FEATURING INSTRUCTION AND ENTERTAINMENT FOR AUTOMOTIVE ENTHUSIASTS; PROVIDING ENTERTAINMENT SERVICES CONCERNING TOPICS OF INTEREST FOR AUTOMOTIVE ENTHUSIASTS IN THE NATURE OF EXHIBITIONS, COMPETITIONS, CONTESTS, GAMES, QUIZZES, FUN DAYS, SHOWS, ROAD

ONCARS

THE MARK CONSISTS OF STANDARD CHARACTERS WITHOUT CLAIM TO ANY PARTICULAR FONT, STYLE, SIZE, OR COLOR.

SHOWS, STAGE EVENTS, THEATRICAL PERFORMANCES, CONCERTS, LIVE PERFORMANCES, AND AUDIENCE PARTICIPATION EVENTS; PROVIDING ONLINE INTERACTIVE ENTERTAINMENT, NAMELY, QUIZZES AND GAMES DESIGNED TO TEST GENERAL KNOWLEDGE RELATING TO AUTOMOBILES AND FOR AUTOMOTIVE ENTHUSIASTS; ENTERTAINMENT AND EDUCATIONAL SERVICES, NAMELY, PROVIDING A WEB SITE DEVOTED TO THE SUBJECT OF AUTOMOBILES AND TO AUTOMOTIVE ENTHUSIASTS FEATURING ARTICLES, PHOTO GALLERIES, AND VIDEOS (U.S. CLS. 100, 101 AND 107).

JULIE GUTTADAURO, EXAMINING ATTORNEY

CLASS 38—COMMUNICATION

FOR RADIO, TELEVISION, CABLE TELEVISION, AND SATELLITE RADIO AND TELEVISION BROADCASTING AND TRANSMISSION; INTERACTIVE RADIO AND TELEVISION BROADCASTING AND TRANSMISSION; SUBSCRIPTION TELEVISION AND VIDEO-ON-DEMAND BROADCASTING AND TRANSMISSION; BROADCASTING AND TRANSMISSION OF RADIO AND TELEVISION PROGRAMS; DATA TRANSMISSION AND DATA BROADCASTING OVER HIGH SPEED TELEPHONE, CABLE TELEVISION, SATELLITE TELEVISION AND RADIO FREQUENCY NETWORKS; VIDEO AND AUDIO STREAMING VIA COMMUNICATION AND COMPUTER NETWORKS; ELECTRONIC TRANSMISSION OF TEXT, MESSAGES, INFORMATION, SOUND AND IMAGES VIA COMMUNICATION AND COMPUTER NETWORKS; BROADCASTING AND TRANSMISSION OF DIGITAL INFORMATION BY MEANS OF CABLE TELEVISION, SATELLITE TELEVISION RADIO, TELEPHONE AND COMPUTER; PROVIDING ONLINE FORUMS FOR THE TRANSMISSION OF MESSAGES AMONG COMPUTER USERS CONCERNING TOPICS OF INTEREST TO AUTOMOTIVE ENTHUSIASTS; MESSAGE SENDING VIA TELEPHONES, CELLULAR PHONES, FACSIMILE MACHINES, AND MODEMS; PROVIDING TELECOMMUNICATIONS CONNECTIONS TO A GLOBAL COMPUTER NETWORK; ELECTRONIC TRANSMISSION OF DATA CONTAINED IN DATABANKS, NAMELY, THE DISPLAY OF INFORMATION FROM A COMPUTER STORED DATA BANK; ELECTRONIC TRANSMISSION OF INFORMATION, MESSAGES, TEXT, IMAGES AND DATA (U.S. CLS. 100, 101 AND 104).

SN 77-412,639. MOTR, INC., ALISO VIEJO, CA. FILED 3-4-2008.

ONCARS.COM

THE MARK CONSISTS OF STANDARD CHARACTERS WITHOUT CLAIM TO ANY PARTICULAR FONT, STYLE, SIZE, OR COLOR.

CLASS 9—ELECTRICAL AND SCIENTIFIC APPARATUS

FOR DIGITAL MEDIA, NAMELY, PRE-RECORDED DIGITAL MEDIA, DVDS, DOWNLOADABLE FILES AND OPTICAL AND MAGNETIC DISKS CONTAINING AUDIO, VIDEO, STILL AND MOVING IMAGES, AND DATA RECORDINGS IN COMPRESSED AND UNCOMPRESSED FORM, FEATURING ENTERTAINMENT IN THE NATURE OF ARTICLES, PHOTO GALLERIES AND VIDEOS, INFORMATION AND INSTRUCTION RELATING TO AUTOMOBILES FOR AUTOMOBILE ENTHUSIASTS; DOWNLOADABLE MULTIMEDIA FILES CONTAINING ARTWORK, TEXT, AUDIO, VIDEO, AND INTERNET WEB LINKS RELATING TO AUTOMOBILES AND FOR AUTOMOTIVE ENTHUSIASTS (U.S. CLS. 21, 23, 26, 36 AND 38).

CLASS 35—ADVERTISING AND BUSINESS

FOR MAIL ORDER CATALOG AND ON-LINE RETAIL STORE SERVICES FEATURING CLOTHING, SOUND AND VIDEO RECORDINGS, BOOKS, MAGAZINES, GAMES AND TOYS, AND MERCHANDISE RELATED TO AUTOMOTIVE INTERESTS (U.S. CLS. 100, 101 AND 102).

CLASS 41—EDUCATION AND ENTERTAINMENT

FOR ENTERTAINMENT SERVICES, NAMELY, ORGANIZING EXHIBITIONS, COMPETITIONS, CONTESTS, GAMES, QUIZZES, FUN DAYS, SHOWS, ROAD SHOWS, STAGE EVENTS, THEATRICAL PERFORMANCES, CONCERTS, LIVE PERFORMANCES, AND AUDIENCE PARTICIPATION EVENTS, PERTAINING TO OR FEATURING INSTRUCTION AND ENTERTAINMENT FOR AUTOMOTIVE ENTHUSIASTS; PROVIDING ENTERTAINMENT SERVICES CONCERNING TOPICS OF INTEREST FOR AUTOMOTIVE ENTHUSIASTS IN THE NATURE OF EXHIBITIONS, COMPETITIONS, CONTESTS, GAMES, QUIZZES, FUN DAYS, SHOWS, ROAD SHOWS, STAGE EVENTS, THEATRICAL PERFORMANCES, CONCERTS, LIVE PERFORMANCES, AND AUDIENCE PARTICIPATION EVENTS; PROVIDING ONLINE INTERACTIVE ENTERTAINMENT, NAMELY, QUIZZES AND GAMES DESIGNED TO TEST GENERAL KNOWLEDGE RELATING TO AUTOMOBILES AND FOR AUTOMOTIVE ENTHUSIASTS; ENTERTAINMENT AND EDUCATIONAL SERVICES, NAMELY, PROVIDING A WEB SITE DEVOTED TO THE SUBJECT OF AUTOMOBILES AND TO AUTOMOTIVE ENTHUSIASTS FEATURING ARTICLES, PHOTO GALLERIES, AND VIDEOS (U.S. CLS. 100, 101 AND 107).

JULIE GUTTADAURO, EXAMINING ATTORNEY

SN 77-412,692. FRANK THRIER, MARSTETTEN, SWITZERLAND, FILED 3-4-2008.



PRIORITY CLAIMED UNDER SEC. 44(D) ON SWITZERLAND APPLICATION NO. 64378/2007, FILED 12-18-2007, REG. NO. 573248, DATED 6-17-2008, EXPIRES 12-18-2017.

NO CLAIM IS MADE TO THE EXCLUSIVE RIGHT TO USE "SWISS NUTRITION", APART FROM THE MARK AS SHOWN.

THE COLOR(S) BLACK, WHITE, AND RED IS/ARE CLAIMED AS A FEATURE OF THE MARK.

THE MARK CONSISTS OF AN ILLUSTRATION OF A HISTORICAL PERSON, (NAMELY, WILHELM TELL) IN THE COLORS BLACK AND WHITE; THE DEPICTION OF THE HISTORICAL WILHELM (OR WILLIAM) TELL IS LOCATED NEXT TO A RED RECTANGULAR CARRIER ON WHICH WORDS "SWISS NUTRITION" IN WHITE LETTERS ARE LOCATED; THE LETTERS IN THE WORD "SWISS" ARE OUTLINED IN BLACK.

CLASS 5—PHARMACEUTICALS

FOR FOOD SUPPLEMENTS; DIETARY AND NUTRITIONAL SUPPLEMENTS; DIET PILLS; DIETARY SUPPLEMENTAL DRINKS; FOOD FOR DIABETICS; MINERAL FOOD SUPPLEMENTS; FOOD SUPPLEMENTS FOR MEDICAL PURPOSES; MEAL REPLACEMENT BARS; MEAL REPLACEMENT DRINKS; MEAL REPLACEMENT POWDERS; MEAL REPLACEMENT SHAKES; VITAMIN PREPARATIONS; VITAMINS; BIOLOGICAL PREPARATIONS FOR MEDICAL PURPOSES; DIETARY FOOD SUPPLEMENTS; ENZYMES FOR MEDICAL PURPOSES; ENZYME PREPARATIONS FOR MEDICAL PURPOSES; MEDICAL DRINKS; MEDICAL TEA; MEDICAL HERBS; MINERAL WATER FOR MEDICAL PURPOSES; MINERAL WATER SALTS FOR MEDICAL PURPOSES; ELECTROLYTES (U.S. CLS. 6, 18, 44, 46, 51 AND 52).

CLASS 32—LIGHT BEVERAGES

FOR BEER; MINERAL AND CARBONATED WATER AND OTHER NON-ALCOHOLIC BEVERAGES, NAMELY, FRUIT DRINKS, FRUIT JUICES, VEGETABLE JUICES, SOFT DRINKS, ENERGY DRINKS; SYRUPS AND OTHER PREPARATIONS FOR MAKING DRINKS, NAMELY, FRUIT DRINKS; ISOTONIC BEVERAGES; POWDERS USED IN THE PREPARATION OF ISOTONIC SPORTS DRINKS AND SPORTS BEVERAGES; WHEY BEVERAGES (U.S. CLS. 45, 46 AND 48).

MARK RADEMACHER, EXAMINING ATTORNEY

SN 77-412,710. ELX FUTURES, L.P., NEW YORK, NY. FILED 3-4-2008.

ELX

THE MARK CONSISTS OF STANDARD CHARACTERS WITHOUT CLAIM TO ANY PARTICULAR FONT, STYLE, SIZE, OR COLOR.

CLASS 36—INSURANCE AND FINANCIAL

FOR FINANCIAL SERVICES, NAMELY, PROVIDING FINANCIAL INFORMATION CONCERNING INVESTMENT SECURITIES, FINANCIAL INSTRUMENTS AND FUTURES CONTRACTS; FINANCIAL EXCHANGE; FUTURES EXCHANGE SERVICES, NAMELY, FINANCIAL TRADE EXECUTION, CONFIRMATION AND SETTLEMENT SERVICES IN THE FIELDS OF INVESTMENT SECURITIES, FINANCIAL INSTRUMENTS AND FUTURES CONTRACTS; FINANCIAL ANALYSIS AND CONSULTATION; FINANCIAL MANAGEMENT; FINANCIAL RESEARCH; INVESTMENT FUNDS TRANSFER AND TRANSACTION SERVICES; INVESTMENT BROKERAGE; FUTURES EXCHANGE SERVICES, NAMELY, TRANSACTING AND TRADING OF FINANCIAL INSTRUMENTS IN THE FIELDS OF INVESTMENT SECURITIES, FINANCIAL INSTRUMENTS AND FUTURES CONTRACTS; ORGANIZATION OF ELECTRONIC FUTURES EXCHANGE, NAMELY, PROVIDING AN ELECTRONIC MARKETPLACE FOR TRADING OF FINANCIAL INSTRUMENTS IN THE FIELDS OF INVESTMENT SECURITIES, FINANCIAL INSTRUMENTS AND FUTURES CONTRACTS; FUND INVESTMENT CONSULTATION; FINANCIAL INVESTMENT IN THE FIELD OF INVESTMENT SECURITIES, FINANCIAL INSTRUMENTS AND FUTURES CONTRACTS; FINANCIAL SERVICES IN THE NATURE OF AN INVESTMENT SECURITY; SECURITIES BROKERAGE; TRADING FINANCIAL INSTRUMENTS FOR OTHERS IN THE FIELDS OF INVESTMENT SECURITIES, FINANCIAL INSTRUMENTS AND FUTURES CONTRACTS; FUTURES EXCHANGE SERVICES, NAMELY, SETTLEMENT OF FINANCIAL AND SECURITIES TRANSACTIONS IN THE FIELDS OF INVESTMENT SECURITIES, FINANCIAL INSTRUMENTS AND FUTURES CONTRACTS; FINANCIAL CLEARING HOUSE SERVICES; PROVIDING AN ON-LINE COMPUTER DATABASE FEATURING FINANCIAL INFORMATION IN THE FIELD OF INVESTMENT SECURITIES, FINANCIAL INSTRUMENTS AND FUTURES CONTRACTS; PROVIDING A WEBSITE FEATURING FINANCIAL INFORMATION IN THE FIELD OF INVESTMENT SECURITIES, FINANCIAL INSTRUMENTS AND FUTURES CONTRACTS (U.S. CLS. 100, 101 AND 102).

CLASS 42—SCIENTIFIC AND COMPUTER SERVICES

FOR DESIGN AND DEVELOPMENT OF COMPUTER HARDWARE AND SOFTWARE; INSTALLATION, MAINTENANCE AND UPDATING SERVICES FOR COMPUTER SOFTWARE; CONSULTANCY RELATING TO COMPUTER HARDWARE AND SOFTWARE; CONSULTING SERVICES IN THE FIELD OF DESIGN, SELECTION, IMPLEMENTATION AND USE OF COMPUTER HARDWARE AND SOFTWARE SYSTEMS FOR OTHERS; CUSTOMIZATION OF COMPUTER HARDWARE AND SOFTWARE; PROVIDING ON-LINE NON-DOWNLOADABLE SOFTWARE FOR ACCESSING FINANCIAL INFORMATION AND TRADING OF FINANCIAL INSTRUMENTS, INVESTMENT SECURITIES, FUTURES CONTRACTS; TECHNICAL SUPPORT SERVICES, NAMELY, CONSULTANCY IN THE FIELD OF COMPUTER HARDWARE AND SOFTWARE PROBLEMS (U.S. CLS. 100 AND 101).

FRED MANDIR, EXAMINING ATTORNEY

SN 77-412,714. ELX FUTURES, L.P., NEW YORK, NY. FILED 3-4-2008.

SN 77-412,826. CAPITOL BROADCASTING COMPANY, INCORPORATED, RALEIGH, NC. FILED 3-4-2008.

ELX ELECTRONIC LIQUIDITY EXCHANGE

THE MARK CONSISTS OF STANDARD CHARACTERS WITHOUT CLAIM TO ANY PARTICULAR FONT, STYLE, SIZE, OR COLOR.

NO CLAIM IS MADE TO THE EXCLUSIVE RIGHT TO USE "ELECTRONIC LIQUIDITY EXCHANGE", APART FROM THE MARK AS SHOWN.

CLASS 36—INSURANCE AND FINANCIAL

FOR FINANCIAL SERVICES, NAMELY, PROVIDING FINANCIAL INFORMATION CONCERNING INVESTMENT SECURITIES, FINANCIAL INSTRUMENTS AND FUTURES CONTRACTS; FINANCIAL EXCHANGE; FUTURES EXCHANGE SERVICES, NAMELY, FINANCIAL TRADE EXECUTION, CONFIRMATION AND SETTLEMENT SERVICES IN THE FIELDS OF INVESTMENT SECURITIES, FINANCIAL INSTRUMENTS AND FUTURES CONTRACTS; FINANCIAL ANALYSIS AND CONSULTATION; FINANCIAL MANAGEMENT; FINANCIAL RESEARCH; INVESTMENT FUNDS TRANSFER AND TRANSACTION SERVICES; INVESTMENT BROKERAGE; FUTURES EXCHANGE SERVICES, NAMELY, TRANSACTING AND TRADING OF FINANCIAL INSTRUMENTS IN THE FIELDS OF INVESTMENT SECURITIES, FINANCIAL INSTRUMENTS AND FUTURES CONTRACTS; ORGANIZATION OF ELECTRONIC FUTURES EXCHANGE, NAMELY, PROVIDING AN ELECTRONIC MARKETPLACE FOR TRADING OF FINANCIAL INSTRUMENTS IN THE FIELDS OF INVESTMENT SECURITIES, FINANCIAL INSTRUMENTS AND FUTURES CONTRACTS; FUND INVESTMENT CONSULTATION; FINANCIAL INVESTMENT IN THE FIELD OF INVESTMENT SECURITIES, FINANCIAL INSTRUMENTS AND FUTURES CONTRACTS; FINANCIAL SERVICES IN THE NATURE OF AN INVESTMENT SECURITY; SECURITIES BROKERAGE; TRADING FINANCIAL INSTRUMENTS FOR OTHERS IN THE FIELDS OF INVESTMENT SECURITIES, FINANCIAL INSTRUMENTS AND FUTURES CONTRACTS; FUTURES EXCHANGE SERVICES, NAMELY, SETTLEMENT OF FINANCIAL AND SECURITIES TRANSACTIONS IN THE FIELDS OF INVESTMENT SECURITIES, FINANCIAL INSTRUMENTS AND FUTURES CONTRACTS; FINANCIAL CLEARING HOUSE SERVICES; PROVIDING AN ON-LINE COMPUTER DATABASE FEATURING FINANCIAL INFORMATION IN THE FIELD OF INVESTMENT SECURITIES, FINANCIAL INSTRUMENTS AND FUTURES CONTRACTS; PROVIDING A WEBSITE FEATURING FINANCIAL INFORMATION IN THE FIELD OF INVESTMENT SECURITIES, FINANCIAL INSTRUMENTS AND FUTURES CONTRACTS (U.S. CLS. 100, 101 AND 102).

CLASS 42—SCIENTIFIC AND COMPUTER SERVICES

FOR DESIGN AND DEVELOPMENT OF COMPUTER HARDWARE AND SOFTWARE; INSTALLATION, MAINTENANCE AND UPDATING SERVICES FOR COMPUTER SOFTWARE; CONSULTANCY RELATING TO COMPUTER HARDWARE AND SOFTWARE; CONSULTING SERVICES IN THE FIELD OF DESIGN, SELECTION, IMPLEMENTATION AND USE OF COMPUTER HARDWARE AND SOFTWARE SYSTEMS FOR OTHERS; CUSTOMIZATION OF COMPUTER HARDWARE AND SOFTWARE; PROVIDING ON-LINE NON-DOWNLOADABLE SOFTWARE FOR ACCESSING FINANCIAL INFORMATION AND TRADING OF FINANCIAL INSTRUMENTS, INVESTMENT SECURITIES, FUTURES CONTRACTS; TECHNICAL SUPPORT SERVICES, NAMELY, CONSULTANCY IN THE FIELD OF COMPUTER HARDWARE AND SOFTWARE PROBLEMS (U.S. CLS. 100 AND 101).
 FRED MANDIR, EXAMINING ATTORNEY

MY LOCAL TV

THE MARK CONSISTS OF STANDARD CHARACTERS WITHOUT CLAIM TO ANY PARTICULAR FONT, STYLE, SIZE, OR COLOR.

NO CLAIM IS MADE TO THE EXCLUSIVE RIGHT TO USE "LOCAL TV", APART FROM THE MARK AS SHOWN.

CLASS 9—ELECTRICAL AND SCIENTIFIC APPARATUS

FOR DOWNLOADABLE SOFTWARE FOR ACCESSING AUDIOVISUAL CONTENT FROM TELEVISION STATIONS AROUND THE COUNTRY VIA WIRELESS COMMUNICATION DEVICES (U.S. CLS. 21, 23, 26, 36 AND 38).
 FIRST USE 6-0-2006; IN COMMERCE 6-0-2006.

CLASS 38—COMMUNICATION

FOR MOBILE MEDIA COMMUNICATION SERVICES, NAMELY, WIRELESS TRANSMISSION OF TELEVISION STATION PROGRAMMING AROUND THE COUNTRY TO WIRELESS COMMUNICATIONS DEVICES; PROVIDING SUBSCRIPTION TELEVISION BROADCASTING VIA WIRELESS COMMUNICATION DEVICES (U.S. CLS. 100, 101 AND 104).
 FIRST USE 5-0-2006; IN COMMERCE 5-0-2006.

CLASS 41—EDUCATION AND ENTERTAINMENT

FOR DISTRIBUTION OF TELEVISION PROGRAMMING FOR OTHERS VIA WIRELESS COMMUNICATION DEVICES; ENTERTAINMENT SERVICES, NAMELY, PROVIDING AUDIOVISUAL CONTENT FROM TELEVISION STATIONS FEATURING GENERAL NEWS, CURRENT EVENTS, ENTERTAINMENT, SPORTS, WEATHER, TRAFFIC AND INFORMATION VIA WIRELESS COMMUNICATION DEVICES (U.S. CLS. 100, 101 AND 107).
 FIRST USE 1-0-2006; IN COMMERCE 1-0-2006.
 TASNEEM HUSSAIN, EXAMINING ATTORNEY

SN 77-413,308. U.S. NUTRACEUTICALS, L.L.C., EUSTIS, FL. FILED 3-5-2008.

ROSETTA NUTRITIONALS

THE MARK CONSISTS OF STANDARD CHARACTERS WITHOUT CLAIM TO ANY PARTICULAR FONT, STYLE, SIZE, OR COLOR.

NO CLAIM IS MADE TO THE EXCLUSIVE RIGHT TO USE "NUTRITIONALS", APART FROM THE MARK AS SHOWN.

CLASS 5—PHARMACEUTICALS

FOR VITAMINS AND NUTRITIONAL SUPPLEMENTS FOR HUMAN CONSUMPTION; NUTRITIONAL ADDITIVES FOR MEDICAL PURPOSES IN THE FORM OF GRAIN SEED MEAL FOR USE IN FOODS, VITAMINS AND DIETARY NUTRITIONAL SUPPLEMENTS FOR HUMAN CONSUMPTION; VITAMINS CONTAINING FISH OILS, FISH OIL NUTRITIONAL SUPPLEMENTS; MEDICINAL EDIBLE OIL EXTRACTS FOR USE IN VITAMINS AND NUTRITIONAL SUPPLEMENTS; AND NUTRITIONAL OILS NOT FOR FOOD OR COSMETIC PURPOSES FOR USE IN VITAMINS AND NUTRITIONAL SUPPLEMENTS (U.S. CLS. 6, 18, 44, 46, 51 AND 52).

CLASS 30—STAPLE FOODS

FOR PROCESSED GRAIN SEED MEAL; AND PROCESSED GRAIN SEED MEAL AS USED IN AN INGREDIENT IN VITAMINS, NUTRITIONAL SUPPLEMENTS AND FOOD PRODUCTS (U.S. CL. 46).

CLASS 31—NATURAL AGRICULTURAL PRODUCTS

FOR UNPROCESSED GRAIN SEED MEAL; AND UNPROCESSED GRAIN SEED MEAL AS USED IN AN INGREDIENT IN VITAMINS, NUTRITIONAL SUPPLEMENTS AND FOOD PRODUCTS (U.S. CLS. 1 AND 46).
CHRISTINE COOPER, EXAMINING ATTORNEY

SN 77-413,328. DOLCE INTERNATIONAL HOLDINGS, INC., MONTVALE, NJ. FILED 3-5-2008.



OWNER OF U.S. REG. NOS. 2,094,545, 3,001,442 AND OTHERS.

THE MARK CONSISTS OF THE LITERAL ELEMENT OF "DOLCE" WITH SEVERAL OVERLAPPING IMPRINTS OF THE LETTER "O" IN THE WORD.

THE FOREIGN WORDING IN THE MARK TRANSLATES INTO ENGLISH AS SWEET.

CLASS 35—ADVERTISING AND BUSINESS

FOR MANAGING AND OPERATING BUSINESS CONFERENCE CENTERS OF OTHERS (U.S. CLS. 100, 101 AND 102).

CLASS 43—HOTEL AND RESTAURANT SERVICES

FOR PROVIDING TEMPORARY LODGING SERVICES IN THE NATURE OF HOTELS, RESORTS AND CONFERENCE CENTERS (U.S. CLS. 100 AND 101).
ESTHER BELENKER, EXAMINING ATTORNEY

SN 77-413,506. ABT ASSOCIATES INC., CAMBRIDGE, MA. FILED 3-5-2008.



THE MARK CONSISTS OF A BLACK BOX WITH "ABT" WRITTEN IN WHITE IN THE CENTER OF THE BOX.

CLASS 35—ADVERTISING AND BUSINESS

FOR BUSINESS CONSULTATION; BUSINESS RESEARCH CONSULTATION; PUBLIC POLICY RESEARCH AND CONSULTATION SERVICES IN THE FIELDS OF SOCIAL, ECONOMIC, ENVIRONMENTAL AND HEALTH POLICY AND INTERNATIONAL DEVELOPMENT (U.S. CLS. 100, 101 AND 102).
FIRST USE 8-1-1990; IN COMMERCE 8-1-1990.

CLASS 41—EDUCATION AND ENTERTAINMENT

FOR EDUCATIONAL SERVICES, NAMELY, PROVIDING SEMINARS, WORKSHOPS AND CONFERENCES IN THE FIELDS OF SOCIAL, ECONOMIC, ENVIRONMENTAL AND HEALTH POLICY, INTERNATIONAL DEVELOPMENT, BUSINESS RESEARCH, AND CLINICAL RESEARCH (U.S. CLS. 100, 101 AND 107).
FIRST USE 8-1-1990; IN COMMERCE 8-1-1990.

CLASS 42—SCIENTIFIC AND COMPUTER SERVICES

FOR CONSULTATION SERVICES IN THE FIELD OF CLINICAL RESEARCH (U.S. CLS. 100 AND 101).
FIRST USE 11-9-1972; IN COMMERCE 11-9-1972.
JOHN GARTNER, EXAMINING ATTORNEY

SN 77-413,637. KOSMATKA, GREGORY R., GROSSE POINTE FARMS, MI. FILED 3-5-2008.



THE MARK CONSISTS OF STANDARD CHARACTERS WITHOUT CLAIM TO ANY PARTICULAR FONT, STYLE, SIZE, OR COLOR.

CLASS 32—LIGHT BEVERAGES

FOR BEER (U.S. CLS. 45, 46 AND 48).

CLASS 33—WINES AND SPIRITS

FOR WINE (U.S. CLS. 47 AND 49).
ODESSA BIBBINS, EXAMINING ATTORNEY

SN 77-414,279. GRANT THORNTON LLP, CHICAGO, IL.
FILED 3-5-2008.

CLASS 25—CLOTHING

FOR CLOTHING, NAMELY, JACKETS, JEANS, TROUSERS, PANTS, SHORTS, WRISTBANDS, SHIRTS, T-SHIRTS, BLOUSES, SKIRTS, VESTS, COATS, SWEATSHIRTS, TRACKSUITS, JUMP SUITS, DRESSES, SWEATERS, UNDERWEAR, SCARVES, TIES, SOCKS, BELTS, LEGWARMERS, LEGGINGS, STOCKINGS, TIGHTS; FOOTWEAR; HEADWEAR (U.S. CLS. 22 AND 39).
SIMON TENG, EXAMINING ATTORNEY

TAX SYMPHONY

SN 77-415,905. CONSTELLATION ENERGY GROUP, INC., BALTIMORE, MD. FILED 3-7-2008.

THE MARK CONSISTS OF STANDARD CHARACTERS WITHOUT CLAIM TO ANY PARTICULAR FONT, STYLE, SIZE, OR COLOR.
NO CLAIM IS MADE TO THE EXCLUSIVE RIGHT TO USE "TAX", APART FROM THE MARK AS SHOWN.

NEWRESPONSE

CLASS 35—ADVERTISING AND BUSINESS

FOR ACCOUNTING SERVICES, ACCOUNT AUDITING AND BUSINESS AUDITING SERVICES, AND TAX CONSULTATION SERVICES (U.S. CLS. 100, 101 AND 102).

THE MARK CONSISTS OF STANDARD CHARACTERS WITHOUT CLAIM TO ANY PARTICULAR FONT, STYLE, SIZE, OR COLOR.
OWNER OF U.S. REG. NOS. 2,493,274, 2,553,313 AND OTHERS.

CLASS 45—PERSONAL AND LEGAL SERVICES

FOR TAX COMPLIANCE SERVICES, NAMELY, REVIEWING STANDARDS AND PRACTICES TO DETERMINE COMPLIANCE WITH TAX LAWS AND REGULATIONS (U.S. CLS. 100 AND 101).
ELISSA GARBER KON, EXAMINING ATTORNEY

CLASS 37—CONSTRUCTION AND REPAIR

FOR INSTALLATION OF GAS AND ELECTRIC METERS; INSTALLATION OF COMPUTER HARDWARE (U.S. CLS. 100, 103 AND 106).
FIRST USE 9-1-2007; IN COMMERCE 9-1-2007.

SN 77-414,706. CLOT CO. LTD., CENTRAL, HONG KONG, FILED 3-6-2008.

CLASS 42—SCIENTIFIC AND COMPUTER SERVICES

FOR INSTALLATION OF COMPUTER SOFTWARE; PROVIDING ONLINE NON-DOWNLOADABLE COMPUTER SOFTWARE USED TO ANALYZE ENERGY USAGE, POTENTIAL FOR ENERGY LOAD REDUCTION AND ENERGY PRICES (U.S. CLS. 100 AND 101).
FIRST USE 9-1-2007; IN COMMERCE 9-1-2007.
KELLEY WELLS, EXAMINING ATTORNEY

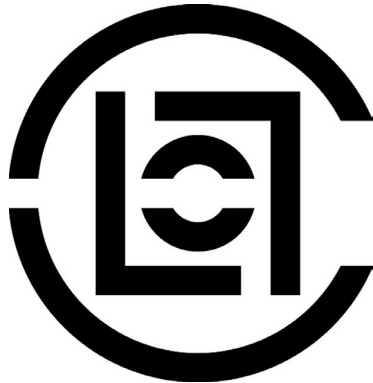

OWNER OF HONG KONG REG. NO. 300529100, DATED 3-24-2006, EXPIRES 11-11-2015.
THE MARK CONSISTS OF THE LETTER "C" WITH A GAP IN THE MIDDLE. IN THE CENTER IS THE LETTER "L" AND AN INCOMPLETE LETTER "T" FORMING AN INCOMPLETE SQUARE. IN THE CENTER OF THE SQUARE IS THE LETTER "O" DIVIDED IN HALF.

SN 77-416,073. CYTORI THERAPEUTICS, INC., SAN DIEGO, CA. FILED 3-7-2008.

CLASS 18—LEATHER GOODS

FOR ACCESSORIES MADE OF LEATHER AND IMITATIONS OF LEATHER, NAMELY, LEATHER BAGS, WALLETS, TRAVELING CASES; TRAVELING SUITCASES (U.S. CLS. 1, 2, 3, 22 AND 41).



OWNER OF U.S. REG. NO. 3,326,303.

CLASS 1—CHEMICALS

FOR CHEMICAL PREPARATIONS, NAMELY, BIOLOGICALLY COMPATIBLE CHEMICAL SUBSTANCES FOR SCIENTIFIC, LABORATORY, CLINICAL AND MEDICAL RESEARCH; BIOLOGICAL TISSUE, NAMELY, MAMMALIAN SOFT AND HARD TISSUES COMPRISING OR DERIVED FROM STEM CELLS OR PROGENITOR CELLS FOR SCIENTIFIC, LABORATORY, CLINICAL AND MEDICAL RESEARCH; THERAPEUTIC TISSUE, NAMELY, THERAPEUTIC TISSUE COMPRISING OR DERIVED FROM STEM CELLS OR PROGENITOR CELLS, AND COMPOSITIONS COMPRISING OR DERIVED FROM THE THERAPEUTIC TISSUES FOR SCIENTIFIC, LABORATORY, CLINICAL AND MEDICAL RESEARCH (U.S. CLS. 1, 5, 6, 10, 26 AND 46).

CLASS 3—COSMETICS AND CLEANING PREPARATIONS

FOR CHEMICAL PREPARATIONS AND REAGENTS FOR PLACEMENT INTO CONTACT WITH THE MAMMALIAN BODY FOR COSMETIC PURPOSES, NAMELY, COSMETIC PREPARATIONS (U.S. CLS. 1, 4, 6, 50, 51 AND 52).

CLASS 5—PHARMACEUTICALS

FOR PREPARATIONS COMPRISING LIVING CELLS AND NON-SYNTHETIC CELLULAR SOLIDS AND FLUIDS FOR PLACEMENT ON OR INTO THE MAMMALIAN BODY, FOR THE TREATMENT OF DISORDERS, DISEASES AND INJURIES AND FOR COSMETIC PURPOSES; BIOLOGICAL IMPLANTS, NAMELY, BIOLOGICAL IMPLANTS COMPRISING OR DERIVED FROM STEM CELLS OR PROGENITOR CELLS; SURGICAL IMPLANTS, NAMELY, SURGICAL IMPLANTS COMPRISING LIVING TISSUE; IMPLANTABLE, INJECTABLE AND OTHER BIOLOGICAL-USE PREPARATIONS COMPRISING OR DERIVED FROM STEM CELLS OR PROGENITOR CELLS FOR MEDICAL PURPOSES; CHEMICALS AND CHEMICAL PREPARATIONS AND REAGENTS COMPRISING NON-SYNTHETIC CELLULAR COMPOSITIONS FOR MEDICAL PURPOSES; THERAPEUTIC TISSUE, CELLULAR AND STEM CELL COMPOSITIONS FOR PLACEMENT ON OR INTO THE MAMMALIAN BODY FOR MEDICAL USE; TISSUE, CELL AND STEM CELL COMPOSITIONS FOR PLACEMENT ON OR INTO THE MAMMALIAN BODY FOR THE TREATMENT OF COSMETIC AND OTHER HUMAN CONDITIONS AND DISEASES; BIOLOGICAL PREPARATIONS AND REAGENTS FOR PLACEMENT INTO CONTACT WITH THE MAMMALIAN BODY FOR THE TREATMENT OF DISORDERS, DISEASES AND INJURIES (U.S. CLS. 6, 18, 44, 46, 51 AND 52).

CLASS 10—MEDICAL APPARATUS

FOR MEDICAL APPARATUS, INSTRUMENTS AND ARTICLES, NAMELY, MEDICAL INSTRUMENTS FOR PROCESSING, CONCENTRATING, AND IMPLANTING CELLS AND CELLULAR COMPOSITIONS; SURGICAL IMPLANTS COMPRISING NON-LIVING TISSUES AND NON-LIVING TISSUE REGENERATIVE PRODUCTS FOR THE TREATMENT OF COSMETIC AND OTHER HUMAN CONDITIONS AND DISEASES; MEDICAL INSTRUMENTS FOR TISSUE, CELL, CELLULAR COMPONENT AND STEM CELL EXTRACTION, PROCESSING AND APPLICATION; TISSUE AND CELL SEPARATION AND PURIFICATION DEVICES, NAMELY, MEDICAL DEVICES USED FOR THE ISOLATION OF CELLS AND CELLULAR COMPONENTS WITHIN ADIPOSE TISSUE; TISSUE AND CELL PROCESSING DEVICES, NAMELY, MEDICAL DEVICES USED FOR THE COLLECTION AND STORAGE OF ADIPOSE TISSUE AND ADIPOSE TISSUE DERIVED CELLS; BONE AND SOFT TISSUE

IMPLANTS COMPRISING NON-LIVING MATERIALS, NAMELY, POROUS AND NON-POROUS SHEETS OF MATERIAL, POROUS AND NON-POROUS SHEETS OF RESORBABLE MATERIAL, POROUS AND NON-POROUS SHEETS OF FLEXIBLE RESORBABLE MATERIAL, AND POROUS AND NON-POROUS SCAFFOLDS AND CELL CONTAINMENT DEVICES FOR USE IN REPAIRING VARIOUS PORTIONS OF THE MAMMALIAN SKELETAL SYSTEM AND OTHER ORGAN SYSTEMS; MEDICAL DEVICES FOR POSITIONING AND SECURING THE BONE AND SOFT TISSUE IMPLANTS (U.S. CLS. 26, 39 AND 44).

CLASS 39—TRANSPORTATION AND STORAGE

FOR TRANSPORT, TRANSPORT PACKAGING AND STORAGE OF GOODS FOR SCIENTIFIC AND MEDICAL PURPOSES; STORAGE OF TISSUE, CELLS AND CELLULAR COMPONENTS FOR SCIENTIFIC AND MEDICAL PURPOSES; STORAGE OF HUMAN TISSUE, CELLS AND CELLULAR COMPONENTS FOR USE IN CELL AND CELLULAR COMPONENT TRANSPLANTATIONS AND TREATMENTS; ARCHIVAL STORAGE SERVICES FOR SCIENTIFIC AND MEDICAL PURPOSES; ELECTRONIC STORAGE OF BIOLOGICAL DATA; PHYSICAL STORAGE OF BIOMEDICAL RESEARCH AND BIOLOGICAL MATERIALS (U.S. CLS. 100 AND 105).

CLASS 44—MEDICAL, BEAUTY AND AGRICULTURAL SERVICES

FOR MEDICAL SERVICES, NAMELY, HYGIENIC AND COSMETIC SERVICES FOR HUMAN BEINGS OR ANIMALS; MEDICAL SERVICES PROVIDED BY THE MEMBERS OF PROFESSIONS SUCH AS MEDICAL DOCTORS AND SURGEONS AND RELATED ENTITIES FOR THE ANALYSIS AND TREATMENT OF COSMETIC AND OTHER HUMAN CONDITIONS AND DISEASES; MEDICAL TREATMENT AND MEDICAL SERVICES USING TISSUE, CELLS, CELLULAR COMPONENTS AND STEM CELLS FOR COSMETIC PURPOSES AND THE TREATMENT OF DISORDERS, DISEASES AND INJURIES (U.S. CLS. 100 AND 101).

HEATHER BIDDULPH, EXAMINING ATTORNEY

SN 77-416.369. CASA SERENA S.R.O., 110 02 PRAGUE 1, CZECH REPUBLIC, FILED 3-7-2008.



THE COLORS BLACK, WHITE, AND GRAY REPRESENT BACKGROUND, OUTLINING, SHADING, AND TRANSPARENT AREAS OF THE MARK AND ARE NOT PART OF THE MARK.

THE MARK CONSISTS OF THE WORDING "CASA SERENA" AND A GOLF BALL DESIGN FEATURING CHINESE LETTERING, WHICH TRANSLITERATES INTO THE ENGLISH LETTERS "RU" AND MEANS "AS (IF); SUCH AS".

THE FOREIGN WORDING IN THE MARK TRANSLATES INTO ENGLISH AS "HOUSE SERENA".

CLASS 39—TRANSPORTATION AND STORAGE

FOR ARRANGING OF TOURS AND TRAVEL AGENCY SERVICES, NAMELY, MAKING RESERVATIONS AND BOOKINGS FOR TRANSPORTATION AND TRAVEL AND TOUR TICKET RESERVATION SERVICE (U.S. CLS. 100 AND 105).

CLASS 41—EDUCATION AND ENTERTAINMENT

FOR ORGANIZATION OF SPORTS COMPETITIONS; PROVIDING SPORTS FACILITIES; PROVIDING GOLF FACILITIES (U.S. CLS. 100, 101 AND 107).

CLASS 43—HOTEL AND RESTAURANT SERVICES

FOR RESTAURANTS; ACCOMMODATION BUREAUS, NAMELY, ARRANGING TEMPORARY HOUSING ACCOMMODATIONS; HOTEL AND RESTAURANT RESERVATION SERVICES; PROVIDING TEMPORARY ACCOMMODATIONS (U.S. CLS. 100 AND 101).
KATHERINE STOIDES, EXAMINING ATTORNEY

SN 77-416,400. CASA SERENA S.R.O., 110 02 PRAGUE 1, CZECH REPUBLIC, FILED 3-7-2008.



THE COLORS BLACK, WHITE, AND GRAY REPRESENT BACKGROUND, OUTLINING, SHADING, AND TRANSPARENT AREAS OF THE MARK AND ARE NOT PART OF THE MARK.

THE PHRASE "CASA SERENA" TRANSLATES INTO ENGLISH AS "HOUSE SERENA". THE WORD "CHATEAU" TRANSLATES TO "CASTLE" IN ENGLISH. THE WORD "ROZTEZ" HAS NO MEANING IN A FOREIGN LANGUAGE.

SN 77-416,379. CASA SERENA S.R.O., 110 02 PRAGUE 1, CZECH REPUBLIC, FILED 3-7-2008.



THE COLORS BLACK, WHITE, AND GRAY REPRESENT BACKGROUND, OUTLINING, SHADING, AND TRANSPARENT AREAS OF THE MARK AND ARE NOT PART OF THE MARK.

THE MARK CONSISTS OF THE WORDING "CHATEAU ROZTEZ" AND A CROWN DESIGN WITH CHINESE LETTERING ABOVE THE CROWN. THE CHINESE LETTERING TRANSLITERATES INTO THE ENGLISH LETTERS "RU" AND MEANS "AS (IF); SUCH AS".

THE FRENCH WORD "CHATEAU" IN THE MARK TRANSLATES TO "CASTLE" IN ENGLISH. THE WORD "ROZTEZ" HAS NO MEANING IN A FOREIGN LANGUAGE.

CLASS 39—TRANSPORTATION AND STORAGE

FOR ARRANGING OF TOURS AND TRAVEL AGENCY SERVICES, NAMELY, MAKING RESERVATIONS AND BOOKINGS FOR TRANSPORTATION AND TRAVEL AND TOUR TICKET RESERVATION SERVICE (U.S. CLS. 100 AND 105).

CLASS 41—EDUCATION AND ENTERTAINMENT

FOR ORGANIZATION OF SPORTS COMPETITIONS; PROVIDING SPORTS FACILITIES; PROVIDING GOLF FACILITIES (U.S. CLS. 100, 101 AND 107).

CLASS 43—HOTEL AND RESTAURANT SERVICES

FOR RESTAURANTS; ACCOMMODATION BUREAUS, NAMELY, ARRANGING TEMPORARY HOUSING ACCOMMODATIONS; HOTEL AND RESTAURANT RESERVATION SERVICES; PROVIDING TEMPORARY ACCOMMODATIONS (U.S. CLS. 100 AND 101).
KATHERINE STOIDES, EXAMINING ATTORNEY

CLASS 39—TRANSPORTATION AND STORAGE

FOR ARRANGING OF TOURS AND TRAVEL AGENCY SERVICES, NAMELY, MAKING RESERVATIONS AND BOOKINGS FOR TRANSPORTATION AND TRAVEL AND TOUR TICKET RESERVATION SERVICE (U.S. CLS. 100 AND 105).

CLASS 41—EDUCATION AND ENTERTAINMENT

FOR ORGANIZATION OF SPORTS COMPETITIONS; PROVIDING SPORTS FACILITIES; PROVIDING GOLF FACILITIES (U.S. CLS. 100, 101 AND 107).

CLASS 43—HOTEL AND RESTAURANT SERVICES

FOR RESTAURANTS; ACCOMMODATION BUREAUS, NAMELY, ARRANGING TEMPORARY HOUSING ACCOMMODATIONS; HOTEL AND RESTAURANT RESERVATION SERVICES; PROVIDING TEMPORARY ACCOMMODATIONS (U.S. CLS. 100 AND 101).
KATHERINE STOIDES, EXAMINING ATTORNEY

SN 77-416,963. BLUE PILLAR, INC., ALPHARETTA, GA. FILED 3-8-2008.

BLUE PILLAR

THE MARK CONSISTS OF STANDARD CHARACTERS WITHOUT CLAIM TO ANY PARTICULAR FONT, STYLE, SIZE, OR COLOR.

CLASS 9—ELECTRICAL AND SCIENTIFIC APPARATUS

FOR COMPUTER SOFTWARE FOR USE AS AN EMERGENCY POWER MANAGEMENT SYSTEM SOLUTION THAT PROVIDES COORDINATION, COMPLIANCE AND CRITICAL INSIGHT IN TIMES OF UTILITY POWER LOSS (U.S. CLS. 21, 23, 26, 36 AND 38).
FIRST USE 3-0-2006; IN COMMERCE 6-0-2007.

CLASS 35—ADVERTISING AND BUSINESS

FOR BUSINESS CONSULTATION IN THE FIELD OF POWER MANAGEMENT SOLUTIONS, NAMELY, PROVIDING COORDINATION, COMPLIANCE AND CRITICAL INSIGHT IN TIMES OF UTILITY POWER LOSS (U.S. CLS. 100, 101 AND 102).

FIRST USE 6-0-2007; IN COMMERCE 6-0-2007.

VIVIAN MICZNIK FIRST, EXAMINING ATTORNEY

SN 77-417,030. BLUE PILLAR, INC., ALPHARETTA, GA. FILED 3-9-2008.



THE COLOR(S) BLUE, WHITE AND BLACK IS/ARE CLAIMED AS A FEATURE OF THE MARK.

THE MARK CONSISTS OF FOUR WHITE PILLARS AND ONE BLUE PILLAR HOLDING UP A ROOF, WITH A CIRCLE SURROUNDING THE DESIGN, SHADED IN BLUE, WITH BLACK BETWEEN THE PILLARS.

CLASS 9—ELECTRICAL AND SCIENTIFIC APPARATUS

FOR COMPUTER SOFTWARE FOR USE AS AN EMERGENCY POWER MANAGEMENT SYSTEM SOLUTION THAT PROVIDES COORDINATION, COMPLIANCE AND CRITICAL INSIGHT IN TIMES OF UTILITY POWER LOSS (U.S. CLS. 21, 23, 26, 36 AND 38).

FIRST USE 6-0-2007; IN COMMERCE 11-0-2007.

CLASS 35—ADVERTISING AND BUSINESS

FOR BUSINESS CONSULTATION IN THE FIELD OF POWER MANAGEMENT SOLUTIONS, NAMELY, PROVIDING COORDINATION, COMPLIANCE AND CRITICAL INSIGHT IN TIMES OF UTILITY POWER LOSS (U.S. CLS. 100, 101 AND 102).

FIRST USE 6-0-2007; IN COMMERCE 6-0-2007.

VIVIAN MICZNIK FIRST, EXAMINING ATTORNEY

SN 77-417,041. CREDIT SUISSE SECURITIES (USA) LLC, NEW YORK, NY. FILED 3-9-2008.

INTELLIGENT ACCESS

THE MARK CONSISTS OF STANDARD CHARACTERS WITHOUT CLAIM TO ANY PARTICULAR FONT, STYLE, SIZE, OR COLOR.

NO CLAIM IS MADE TO THE EXCLUSIVE RIGHT TO USE "ACCESS", APART FROM THE MARK AS SHOWN.

CLASS 16—PAPER GOODS AND PRINTED MATTER

FOR PRINTED MATERIALS, NAMELY, NEWSLETTERS, PAMPHLETS AND REPORTS ADDRESSING INVESTMENT OPPORTUNITIES AND FINANCIAL ANALYSIS (U.S. CLS. 2, 5, 22, 23, 29, 37, 38 AND 50).

CLASS 35—ADVERTISING AND BUSINESS

FOR BUSINESS SERVICES, NAMELY, MATCHING POTENTIAL INVESTORS WITH BUSINESSES NEEDING FUNDING AND SCHEDULING INVESTMENT OPPORTUNITIES BETWEEN INVESTORS AND BUSINESSES (U.S. CLS. 100, 101 AND 102).

CLASS 36—INSURANCE AND FINANCIAL

FOR FINANCIAL SERVICES, NAMELY, FINANCIAL CONSULTING AND INVESTMENT BROKERAGE SERVICES (U.S. CLS. 100, 101 AND 102).

PAUL E. FAHRENKOPF, EXAMINING ATTORNEY

SN 77-417,042. CREDIT SUISSE SECURITIES (USA) LLC, NEW YORK, NY. FILED 3-9-2008.

INTELLIGENT CORPORATE ACCESS NETWORK (ICAN)

THE MARK CONSISTS OF STANDARD CHARACTERS WITHOUT CLAIM TO ANY PARTICULAR FONT, STYLE, SIZE, OR COLOR.

NO CLAIM IS MADE TO THE EXCLUSIVE RIGHT TO USE "CORPORATE ACCESS NETWORK", APART FROM THE MARK AS SHOWN.

CLASS 16—PAPER GOODS AND PRINTED MATTER

FOR PRINTED MATERIALS, NAMELY, NEWSLETTERS, PAMPHLETS AND REPORTS ADDRESSING INVESTMENT OPPORTUNITIES AND FINANCIAL ANALYSIS (U.S. CLS. 2, 5, 22, 23, 29, 37, 38 AND 50).

CLASS 35—ADVERTISING AND BUSINESS

FOR BUSINESS SERVICES, NAMELY, MATCHING POTENTIAL INVESTORS WITH BUSINESSES NEEDING FUNDING AND SCHEDULING INVESTMENT OPPORTUNITIES BETWEEN INVESTORS AND BUSINESSES (U.S. CLS. 100, 101 AND 102).

CLASS 36—INSURANCE AND FINANCIAL

FOR FINANCIAL SERVICES, NAMELY, FINANCIAL CONSULTING AND INVESTMENT BROKERAGE SERVICES (U.S. CLS. 100, 101 AND 102).

CLASS 42—SCIENTIFIC AND COMPUTER SERVICES

FOR PROVIDING NON-DOWNLOADABLE COMPUTER SOFTWARE IN THE FIELD OF FINANCIAL INVESTMENT SERVICES FOR MATCHING INVESTORS WITH BUSINESSES OVER COMPUTER NETWORKS (U.S. CLS. 100 AND 101).

PAUL E. FAHRENKOPF, EXAMINING ATTORNEY

SN 77-417,189. MEAD JOHNSON & COMPANY, EVANSVILLE, IN. FILED 3-10-2008.

SN 77-417,779. MERCK KGAA, DARMSTADT, FED REP GERMANY, FILED 3-10-2008.

NOURISHING THEIR TOMORROWS

ISIPHOR

THE MARK CONSISTS OF STANDARD CHARACTERS WITHOUT CLAIM TO ANY PARTICULAR FONT, STYLE, SIZE, OR COLOR.

THE MARK CONSISTS OF STANDARD CHARACTERS WITHOUT CLAIM TO ANY PARTICULAR FONT, STYLE, SIZE, OR COLOR.

OWNER OF FED REP GERMANY REG. NO. 30763694, DATED 11-14-2007, EXPIRES 9-30-2017.

THE MARK "ISIPHOR" HAS NO MEANING IN A FOREIGN LANGUAGE.

CLASS 41—EDUCATION AND ENTERTAINMENT

FOR EDUCATIONAL SERVICES, NAMELY, CONDUCTING EDUCATIONAL SEMINARS AND WORKSHOPS IN THE FIELD OF INFANT NUTRITION AND DEVELOPMENT (U.S. CLS. 100, 101 AND 107).

CLASS 1—CHEMICALS

FOR CHEMICALS FOR USE IN INDUSTRY AND SCIENCE, NAMELY, CHEMICALS FOR THE GENERATION OF LIGHT AND TO ENCAPSULATE SUCH CHEMICALS IN LIGHT EMITTING DIODES CHEMICALS TO INFLUENCE AND TO ALIGN LIGHT RAYS IN LIGHT EMITTING DIODES (U.S. CLS. 1, 5, 6, 10, 26 AND 46).

CLASS 43—HOTEL AND RESTAURANT SERVICES

FOR CHARITABLE SERVICES, NAMELY, PROVIDING INFANT AND CHILDREN'S NUTRITIONAL PRODUCTS FOR THOSE IN NEED (U.S. CLS. 100 AND 101). MICHAEL ENGEL, EXAMINING ATTORNEY

CLASS 11—ENVIRONMENTAL CONTROL APPARATUS

FOR LIGHT EMITTING DIODES (U.S. CLS. 13, 21, 23, 31 AND 34). FRANK LATTUCA, EXAMINING ATTORNEY

SN 77-417,401. ANAPTYSBIO, INC., DBA ANAPTYS BIOSCIENCES, INC., LA JOLLA, CA. FILED 3-10-2008.

SN 77-418,393. OMNICOMM SYSTEMS, INC., FORT LAUDERDALE, FL. FILED 3-11-2008.

ANAPTYSBIO

OMNIBUILD

THE MARK CONSISTS OF STANDARD CHARACTERS WITHOUT CLAIM TO ANY PARTICULAR FONT, STYLE, SIZE, OR COLOR.

THE MARK CONSISTS OF STANDARD CHARACTERS WITHOUT CLAIM TO ANY PARTICULAR FONT, STYLE, SIZE, OR COLOR.

CLASS 5—PHARMACEUTICALS

FOR BIOLOGICAL PREPARATIONS AND REAGENTS FOR MEDICAL OR VETERINARY USE; CHEMICAL PREPARATIONS FOR MEDICAL OR VETERINARY PURPOSES (U.S. CLS. 6, 18, 44, 46, 51 AND 52).

CLASS 35—ADVERTISING AND BUSINESS

FOR BUSINESS CONSULTING SERVICES ASSISTING CLINICAL LABS IN THE DEVELOPMENT OF STANDARD OPERATING BUSINESS PROCEDURES (U.S. CLS. 100, 101 AND 102).

CLASS 42—SCIENTIFIC AND COMPUTER SERVICES

FOR PHARMACEUTICAL RESEARCH AND DEVELOPMENT; RESEARCH AND DEVELOPMENT IN THE FIELD OF MOLECULAR ENGINEERING OF COMPOUNDS FOR USE IN THERAPEUTIC, DIAGNOSTIC, INDUSTRIAL AND AGRICULTURAL PRODUCTS (U.S. CLS. 100 AND 101). THEODORE MCBRIDE, EXAMINING ATTORNEY

CLASS 44—MEDICAL, BEAUTY AND AGRICULTURAL SERVICES

FOR MEDICAL CONSULTING SERVICES ASSISTING CLINICAL LABS IN THE DEVELOPMENT OF STANDARD OPERATING CLINICAL MEDICAL LABORATORY PROCEDURES (U.S. CLS. 100 AND 101). JOHN DALIER, EXAMINING ATTORNEY

SN 77-418,568. JBA RESTAURANT CORPORATION, DBA JBA RESTAURANT GROUP LLC, SARATOGA SPRINGS, NY. FILED 3-11-2008.



OWNER OF U.S. REG. NOS. 1,983,391, 2,051,782 AND OTHERS.

THE NAME "HATTIE'S" DOES NOT IDENTIFY A LIVING INDIVIDUAL.

THE MARK CONSISTS OF STYLIZED CHICKEN AND STYLIZED WORDS "HATTIE'S".

CLASS 29—MEATS AND PROCESSED FOODS

FOR PREPARED MEALS CONSISTING PRIMARILY OF MEATS, NAMELY, CHICKEN, RIBS, STEAK, FISH AND CAJUN SPECIALTIES, NAMELY, FRIED CHICKEN, CREOLE JAMBALAYA, CATFISH, GUMBO AND BEANS AND RICE WITH SPICES, SEASONING AND NON-NUTRITIOUS FOOD ADDITIVES, INCLUDING CAJUN SPICES, SEASONINGS AND HOT SAUCE FOR CONSUMPTION ON OR OFF THE PREMISES (U.S. CL. 46).

FIRST USE 7-16-1993; IN COMMERCE 7-16-1993.

CLASS 30—STAPLE FOODS

FOR PREPARED AND PACKAGED MEALS CONSISTING PRIMARILY OF MACARONI AND CHEESE (U.S. CL. 46).

FIRST USE 7-16-1993; IN COMMERCE 7-16-1993.

CLASS 43—HOTEL AND RESTAURANT SERVICES

FOR FULL SERVICE RESTAURANT, TAKE OUT RESTAURANT, CATERING SERVICES FOR CONSUMPTION ON OR OFF THE PREMISES (U.S. CLS. 100 AND 101).

FIRST USE 7-16-1993; IN COMMERCE 7-16-1993.
CAROLYN GRAY, EXAMINING ATTORNEY

SN 77-419,089. ADVANCED FACIAL IMAGING, INC., DBA VIEWPOINT, FORT WASHINGTON, PA. FILED 3-11-2008.

Viewpoint

THE MARK CONSISTS OF STANDARD CHARACTERS WITHOUT CLAIM TO ANY PARTICULAR FONT, STYLE, SIZE, OR COLOR.

CLASS 43—HOTEL AND RESTAURANT SERVICES

FOR PROVIDING CONFERENCE, EXHIBITION, AND MEETING FACILITIES PRIMARILY IN THE FIELD OF DENTISTRY (U.S. CLS. 100 AND 101).

FIRST USE 12-1-2004; IN COMMERCE 12-1-2004.

CLASS 44—MEDICAL, BEAUTY AND AGRICULTURAL SERVICES

FOR PROVIDING MEDICAL SUITES IN THE NATURE OF SURGICAL SUITES PRIMARILY IN THE FIELD OF DENTISTRY (U.S. CLS. 100 AND 101).

FIRST USE 12-1-2004; IN COMMERCE 12-1-2004.
SUSAN RICHARDS, EXAMINING ATTORNEY

SN 77-419,118. ADVANCED FACIAL IMAGING, INC., DBA VIEWPOINT, FORT WASHINGTON, PA. FILED 3-11-2008.

THE MARK CONSISTS OF THE TERM "VIEWPOINT" BEGINNING WITH A SCRIPTED LETTER "V" WITH A STAR FOLLOWED BY THE REMAINING LETTERS IN TYPE ALL OF WHICH CAST A SHADOW ON THE BACKGROUND.

CLASS 43—HOTEL AND RESTAURANT SERVICES

FOR PROVIDING CONFERENCE, EXHIBITION, AND MEETING FACILITIES PRIMARILY IN THE FIELD OF DENTISTRY (U.S. CLS. 100 AND 101).

FIRST USE 12-1-2004; IN COMMERCE 12-1-2004.

CLASS 44—MEDICAL, BEAUTY AND AGRICULTURAL SERVICES

FOR PROVIDING MEDICAL SUITES IN THE NATURE OF SURGICAL SUITES PRIMARILY IN THE FIELD OF DENTISTRY (U.S. CLS. 100 AND 101).

FIRST USE 12-1-2004; IN COMMERCE 12-1-2004.
SUSAN RICHARDS, EXAMINING ATTORNEY

SN 77-419,231. GREEN PLUG, INC., SAN RAMON, CA. FILED 3-11-2008.

GREENTALK

THE MARK CONSISTS OF STANDARD CHARACTERS WITHOUT CLAIM TO ANY PARTICULAR FONT, STYLE, SIZE, OR COLOR.

CLASS 9—ELECTRICAL AND SCIENTIFIC APPARATUS

FOR POWER ADAPTERS; MICROCONTROLLERS FOR POWER ADAPTERS; COMPUTER SOFTWARE FOR ESTABLISHING PROTOCOLS FOR COMMUNICATION BETWEEN DEVICES AND POWER ADAPTERS; AND ELECTRIC CONNECTORS FOR POWER ADAPTERS (U.S. CLS. 21, 23, 26, 36 AND 38).

CLASS 42—SCIENTIFIC AND COMPUTER SERVICES

FOR DESIGN AND ENGINEERING OF POWER ADAPTERS, MICROCONTROLLERS FOR POWERS ADAPTERS, AND CONNECTORS FOR POWER ADAPTERS FOR OTHERS (U.S. CLS. 100 AND 101).

CLASS 45—PERSONAL AND LEGAL SERVICES

FOR LICENSING OF INTELLECTUAL PROPERTY AND PATENTED TECHNOLOGY TO OTHERS (U.S. CLS. 100 AND 101).
FIRST USE 0-0-2007; IN COMMERCE 0-0-2007.
JASON TURNER, EXAMINING ATTORNEY

CLASS 25—CLOTHING

FOR READY-MADE CLOTHES, NAMELY, CHEMISES; CLOTHING FOR GYMNASTICS, NAMELY, LEOTARDS, GYMNASTIC SHOES; COATS, DRESSES, DRESS SHIELDS, DRESSING GOWNS, JACKETS, JERSEYS, PULLOVERS, PYJAMAS, SHIRTS, POLO SHIRTS, T-SHIRTS, SKIRTS, TROUSERS, SHORTS, UNDERGARMENTS, UNDERWEAR, UNIFORMS, VESTS, SUITS, WAISTCOATS, BELTS, SNEAKERS, SANDALS, SHOES, BOOTS, SOCKS, STOCKINGS, FOOTWEAR AND HEADWEAR (U.S. CLS. 22 AND 39).
KATHERINE M. DUBRAY, EXAMINING ATTORNEY

SN 77-419,557. MONACO POLO, INC., EL MONTE, CA. FILED 3-12-2008.

SN 77-420,187. NEIGHBORHOOD REINVESTMENT CORP., WASHINGTON, DC. FILED 3-12-2008.



MONACO POLO

NO CLAIM IS MADE TO THE EXCLUSIVE RIGHT TO USE "MONACO POLO", APART FROM THE MARK AS SHOWN.

THE MARK CONSISTS OF THE IMAGE OF A POLO PLAYER ON HORSEBACK RAISING HIS Mallet TO SWING, UNDER WHICH APPEAR THE WORDS "MONACO POLO".

CLASS 3—COSMETICS AND CLEANING PREPARATIONS

FOR PERFUMES AND COLOGNES, AND COSMETICS, NAMELY, MASCARA, LIPSTICKS, EYE SHADOW, MAKE-UP POWDER, ROUGE, SKIN SOAPS, BODY SOAP, DEODORANT SOAP, SHAVING CREAMS, SHAVING LOTIONS, SHAVING GELS, SHAVING SOAPS, NON-MEDICATED HAIR OINTMENTS, HAIR OILS, HAIR SHAMPOOS, HAIR SPRAYS, SHOWER GELS, BODY LOTIONS, BODY OILS, SKIN CARE CREAMS, MAKE-UP, LIP GLOSS, SKIN LOTIONS, FACIAL LOTIONS, HAND CREAM, AFTER SHAVE LOTIONS AND DEODORANT FOR PERSONAL USE (U.S. CLS. 1, 4, 6, 50, 51 AND 52).

CLASS 18—LEATHER GOODS

FOR GOODS MADE OF LEATHER OR IMITATIONS OF LEATHER, NAMELY, ATHLETIC AND SHOULDER BAGS, SPORTS BAGS, HANDBAGS, TRUNKS AND TRAVELING BAGS; UMBRELLAS, SUITCASES, CLUTCH BAGS, VANITY CASES SOLD EMPTY, PURSES, BILLFOLDS, ATTACHE CASES, WALLETS, BRIEFCASES, KEY-CASES (U.S. CLS. 1, 2, 3, 22 AND 41).

STRENGTH MATTERS

THE MARK CONSISTS OF STANDARD CHARACTERS WITHOUT CLAIM TO ANY PARTICULAR FONT, STYLE, SIZE, OR COLOR.

CLASS 16—PAPER GOODS AND PRINTED MATTER

FOR PRINTED MATERIALS, NAMELY, REPORTS, NEWSLETTERS, SERIES OF JOURNAL ARTICLES AND EDUCATIONAL TRAINING MANUALS IN THE FIELD OF BUILDING PRODUCTIVITY AND PROFITABILITY, AND ATTRACTING CAPITAL, FOR AFFORDABLE HOUSING AND COMMUNITY DEVELOPMENT PROVIDERS (U.S. CLS. 2, 5, 22, 23, 29, 37, 38 AND 50).

CLASS 35—ADVERTISING AND BUSINESS

FOR PROVIDING INFORMATION IN THE FIELD OF PROFESSIONAL DEVELOPMENT; CONSULTING SERVICES FOR THE BENEFIT OF AFFORDABLE HOUSING AND COMMUNITY DEVELOPMENT PROVIDERS AND THEIR BUSINESS PARTNERS TO BUILD PRODUCTIVITY AND PROFITABILITY (U.S. CLS. 100, 101 AND 102).

CLASS 36—INSURANCE AND FINANCIAL

FOR FINANCIAL RESEARCH AND CONSULTING FOR THE BENEFIT OF AFFORDABLE HOUSING AND COMMUNITY DEVELOPMENT PROVIDERS AND THEIR BUSINESS PARTNERS IN THE FIELD OF ATTRACTING CAPITAL FROM PRIVATE, PUBLIC AND PHILANTHROPIC SECTORS (U.S. CLS. 100, 101 AND 102).

CLASS 41—EDUCATION AND ENTERTAINMENT

FOR PROVIDING A WEB SITE FEATURING NON-DOWNLOADABLE INSTRUCTIONAL VIDEOS IN THE FIELD OF FINANCE; AND ONLINE EDUCATIONAL COURSES IN THE FIELD OF COMMUNITY DEVELOPMENT (U.S. CLS. 100, 101 AND 107).
ROBIN CHOSID, EXAMINING ATTORNEY

SN 77-420,661. TOMKORP COMPUTER SOLUTIONS INC., WINNIPEG, CANADA, FILED 3-13-2008.



THE COLOR(S) BLUE, WHITE, BLACK AND GRAY IS/ ARE CLAIMED AS A FEATURE OF THE MARK.

THE MARK CONSISTS OF AN IMAGE OF LITTLE CHARACTER WITH ANTENNA IN THE COLORS BLACK AND WHITE AND GRAY WITH BLUE EYES.

CLASS 9—ELECTRICAL AND SCIENTIFIC APPARATUS

FOR INTERACTIVE VIDEO GAME PROGRAMS; VIDEO GAME CARTRIDGES AND DISCS; VIDEO GAME DISCS; VIDEO GAME SOFTWARE (U.S. CLS. 21, 23, 26, 36 AND 38).

CLASS 41—EDUCATION AND ENTERTAINMENT

FOR ENTERTAINMENT SERVICES, NAMELY, PROVIDING AN ON-LINE COMPUTER GAME; PRODUCTION OF VIDEO AND COMPUTER GAME SOFTWARE; PROVIDING A COMPUTER GAME THAT MAY BE ACCESSED NETWORK-WIDE BY NETWORK USERS; PROVIDING AN INTERACTIVE MULTI-USER COMPUTER GAME THAT MAY BE ACCESSED VIA THE INTERNET (U.S. CLS. 100, 101 AND 107).

DEZMONA MIZELLE, EXAMINING ATTORNEY

SN 77-422,677. PLUMCHOICE, INC., BILLERICA, MA. FILED 3-14-2008.

PLUMCHOICE

THE MARK CONSISTS OF STANDARD CHARACTERS WITHOUT CLAIM TO ANY PARTICULAR FONT, STYLE, SIZE, OR COLOR.

CLASS 37—CONSTRUCTION AND REPAIR

FOR COMPUTER MAINTENANCE AND REPAIR; INSTALLATION, REPAIR AND MAINTENANCE OF WIRELESS NETWORKS AND WIRELESS SECURITY NETWORKS (U.S. CLS. 100, 103 AND 106).

FIRST USE 12-31-2001; IN COMMERCE 12-31-2001.

CLASS 41—EDUCATION AND ENTERTAINMENT

FOR COMPUTER TRAINING IN THE FIELD OF PERIPHERAL DEVICES (U.S. CLS. 100, 101 AND 107).

FIRST USE 12-31-2001; IN COMMERCE 12-31-2001.

CLASS 42—SCIENTIFIC AND COMPUTER SERVICES

FOR COMPUTER SOFTWARE INSTALLATION, MAINTENANCE AND REPAIR; COMPUTER SERVICES, NAMELY, REMOTE COMPUTER MONITORING FOR TECHNICAL PURPOSES; TECHNICAL SUPPORT, NAMELY, TROUBLESHOOTING OF COMPUTERS; MAINTENANCE OF COMPUTER SOFTWARE, NAMELY, COMPUTER DESKTOP ISSUES, SECURITY SOFTWARE, AND VIRUS IDENTIFICATION AND REMOVAL SOFTWARE; COMPUTER DIAGNOSTIC SERVICES (U.S. CLS. 100 AND 101).

FIRST USE 12-31-2001; IN COMMERCE 12-31-2001.

ANNE MADDEN, EXAMINING ATTORNEY

SN 77-423,655. MERCK KGAA, 64293 DARMSTADT, FED REP GERMANY, FILED 3-17-2008.

METAFOLIN

THE MARK CONSISTS OF STANDARD CHARACTERS WITHOUT CLAIM TO ANY PARTICULAR FONT, STYLE, SIZE, OR COLOR.

PRIORITY CLAIMED UNDER SEC. 44(D) ON FED REP GERMANY APPLICATION NO. 30761415.8, FILED 9-19-2007, REG. NO. 30761415, DATED 10-29-2007, EXPIRES 9-30-2017.

OWNER OF U.S. REG. NOS. 2,526,532 AND 3,001,087.

CLASS 1—CHEMICALS

FOR CHEMICAL PREPARATIONS AND RAW MATERIALS FOR USE IN THE PHARMACEUTICAL, MEDICAL AND NUTRITIONAL INDUSTRIES; CHEMICALS FOR USE IN INDUSTRY AND SCIENCE; CHEMICALS FOR USE IN THE PHARMACEUTICAL, NUTRITIONAL AND DIETARY INDUSTRIES (U.S. CLS. 1, 5, 6, 10, 26 AND 46).

CLASS 5—PHARMACEUTICALS

FOR PHARMACEUTICAL PREPARATIONS FOR THE TREATMENT AND PREVENTION OF DISEASES AND DISORDERS OF THE RESPIRATORY SYSTEM, GASTROINTESTINAL SYSTEM, ENDOCRINE SYSTEM, CARDIOVASCULAR SYSTEM, NERVOUS SYSTEM, MUSCULOSKELETAL SYSTEM, URINARY SYSTEM, INTEGUMENTARY SYSTEM AND REPRODUCTIVE SYSTEM; PHARMACEUTICAL PREPARATIONS FOR TREATMENT OF BLOOD DISEASE AND DISORDER; DERMATOLOGIC PHARMACEUTICAL PREPARATIONS; HORMONE THERAPY PREPARATIONS; PHARMACEUTICAL PREPARATIONS FOR THE TREATMENTS OF COLDS, COUGHS AND INFLUENZA; PHARMACEUTICAL PREPARATIONS FOR OPHTHALMIC USE; PHARMACEUTICAL PREPARATIONS FOR TREATING DANDRUFF; LAXATIVES; ANALGESICS; CONTRACEPTIVES; ANTISEPTICS; PHARMACEUTICAL PREPARATIONS FOR TREATMENT OF HYPERTENSION; PHARMACEUTICAL PREPARATIONS FOR TREATMENT OF OBESITY; ANTI ALLERGIC PHARMACEUTICAL PREPARATIONS; PHARMACEUTICAL PREPARATIONS FOR TREATMENT OF GOUT; ANTI-INFLAMMATORY PHARMACEUTICALS; ANTIBIOTICS; PHARMACEUTICAL PREPARATIONS FOR TREATMENT OF CANCER; NUTRITIONAL SUPPLEMENTS; DIETARY SUPPLEMENTS; DIETETIC FOODS ADAPTED FOR MEDICAL USE; FOOD FOR BABIES (U.S. CLS. 6, 18, 44, 46, 51 AND 52).

FRANK LATTUCA, EXAMINING ATTORNEY

SN 77-425,085. BLUE PILLAR, INC., ALPHARETTA, GA. FILED 3-18-2008.

DEPMS

THE MARK CONSISTS OF STANDARD CHARACTERS WITHOUT CLAIM TO ANY PARTICULAR FONT, STYLE, SIZE, OR COLOR.

CLASS 9—ELECTRICAL AND SCIENTIFIC APPARATUS

FOR INVENTORY MANAGEMENT TOOL, NAMELY, COMPUTER SOFTWARE THAT PROVIDES WEB BASED ACCESS TO APPLICATIONS AND SERVICES THROUGH A WEB OPERATING SYSTEM OR PORTAL INTERFACE FOR EMERGENCY POWER MANAGEMENT SYSTEMS; SOFTWARE FOR EMERGENCY POWER MANAGEMENT SYSTEM SOLUTION THAT PROVIDES COORDINATION, COMPLIANCE AND CRITICAL INSIGHT IN TIMES OF UTILITY POWER LOSS (U.S. CLS. 21, 23, 26, 36 AND 38).

CLASS 35—ADVERTISING AND BUSINESS

FOR BUSINESS CONSULTATION IN THE FIELD OF POWER MANAGEMENT SOLUTIONS, NAMELY, PROVIDING COORDINATION, COMPLIANCE AND CRITICAL INSIGHT IN TIMES OF UTILITY POWER LOSS (U.S. CLS. 100, 101 AND 102).

VIVIAN MICZNIK FIRST, EXAMINING ATTORNEY

SN 77-424,264. RED STAR HOLDINGS LTD., KOWLOON BAY, KOWLOON, HONG KONG, FILED 3-17-2008.



The logo for i-STUDIO features a stylized lowercase letter 'i' enclosed within a circle, followed by the word 'STUDIO' in a bold, uppercase, sans-serif font.

OWNER OF HONG KONG REG. NO. 301073321, DATED 3-17-2008, EXPIRES 3-17-2018.

THE MARK CONSISTS OF STYLIZED TEXT OF "I-STUDIO" WITH "I" INSIDE OF A CIRCLE.

CLASS 16—PAPER GOODS AND PRINTED MATTER

FOR STATIONERY (U.S. CLS. 2, 5, 22, 23, 29, 37, 38 AND 50).

CLASS 28—TOYS AND SPORTING GOODS

FOR TOYS, NAMELY, CHILDREN'S MULTIPLE ACTIVITY TOYS, INCLUDING DRAWING, COLORING, PAINTING, CRAFTING, GAMES, PUZZLES AND DO-IT-YOURSELF TO DEVELOP CREATIVITY OF KIDS BY PROVIDED COMPONENTS (U.S. CLS. 22, 23, 38 AND 50).

KEVON CHISOLM, EXAMINING ATTORNEY

SN 77-425,122. PIONEER KABUSHIKI KAISHA, DBA A/T/A PIONEER CORPORATION, MEGURO-KU, TOKYO., JAPAN, FILED 3-18-2008.

AVIC FEEDS

THE MARK CONSISTS OF STANDARD CHARACTERS WITHOUT CLAIM TO ANY PARTICULAR FONT, STYLE, SIZE, OR COLOR.

NO CLAIM IS MADE TO THE EXCLUSIVE RIGHT TO USE "FEEDS", APART FROM THE MARK AS SHOWN.

CLASS 9—ELECTRICAL AND SCIENTIFIC APPARATUS

FOR COMPUTER SOFTWARE USED FOR CONVERTING, IDENTIFYING AND MANAGING NAVIGATIONAL POSITION, FOR CALCULATING AND REROUTING ROUTES, DISTANCE AND TIME TO DESTINATION, FOR SELECTING, EDITING AND CONVERTING AUDIO AND VISUAL DATA, AND FOR TRANSFERRING AFORESAID DATA TO NAVIGATION HARDWARE; COMPUTER SOFTWARE FOR BROWSING, SEARCHING, SCROLLING, NAVIGATING, RETRIEVING AND PROCESSING ELECTRONIC DATA, AND FOR CONNECTING TO NETWORK SERVERS AND THE INTERNET FOR DOWNLOADING CONTENT AND DATA (U.S. CLS. 21, 23, 26, 36 AND 38).

CLASS 42—SCIENTIFIC AND COMPUTER SERVICES

FOR UPDATING OF COMPUTER SOFTWARE FOR OTHERS; COMPUTER PROGRAMMING; COMPUTER SOFTWARE SYSTEM DESIGN FOR OTHERS; COMPUTER SOFTWARE DESIGN FOR OTHERS; CONVERSION OF DATA OR DOCUMENTS FROM PHYSICAL TO ELECTRONIC MEDIA; DUPLICATION OF COMPUTER PROGRAMS; RESEARCH AND DEVELOPMENT AND CONSULTATION RELATED THERETO IN THE FIELD OF NAVIGATION HARDWARE AND SOFTWARE; INSTALLATION OF THE COMPUTER SOFTWARE; MAINTENANCE OF COMPUTER SOFTWARE; RENTAL OF COMPUTER SOFTWARE (U.S. CLS. 100 AND 101).
CHARLES L. JENKINS, EXAMINING ATTORNEY

SN 77-425,869. MKS UMETRICS AB, UMEÅ, SWEDEN, FILED 3-19-2008.

OPLS2

SN 77-425,563. M&S DISTRIBUTION, INC., BOSTON, MA. FILED 3-18-2008.

THE MARK CONSISTS OF STANDARD CHARACTERS WITHOUT CLAIM TO ANY PARTICULAR FONT, STYLE, SIZE, OR COLOR.

PRIORITY CLAIMED UNDER SEC. 44(D) ON ERPN CMNTY TM OFC APPLICATION NO. 006762603, FILED 3-18-2008, REG. NO. 006762603, DATED 11-14-2008, EXPIRES 11-14-2018.

OWNER OF U.S. REG. NOS. 3,301,655, 3,385,700 AND 3,385,701.

HEAVYLIFT

THE MARK CONSISTS OF STANDARD CHARACTERS WITHOUT CLAIM TO ANY PARTICULAR FONT, STYLE, SIZE, OR COLOR.

CLASS 25—CLOTHING

FOR ATHLETIC CLOTHING, NAMELY, SHIRTS, SHORTS, TANK TOPS, WARM UP SUITS, SWEAT SUITS, PANTS, JACKETS, POSING TRUNKS, SWIM WEAR, SLEEP WEAR, UNDERWEAR, SOCKS, SWEAT BANDS, HATS AND GLOVES (U.S. CLS. 22 AND 39).
FIRST USE 4-23-2007; IN COMMERCE 4-23-2007.

CLASS 28—TOYS AND SPORTING GOODS

FOR EXERCISE MACHINES AND MANUALLY OPERATED EXERCISE EQUIPMENT, NAMELY, MULTI-PURPOSE EXERCISE UNITS, STATIONARY EXERCISE BICYCLES, FREE STANDING CROSS OVER CABLES, EXERCISE PULLEYS IN THE NATURE OF A LONG PULL AND PULL DOWN COMBO, DOUBLE PULL DOWN STATION, LONG PULL, AND PULL DOWN MACHINE, BENCH PRESS BENCH, BARBELL INCLINE BENCH WITH SPOTTERS PLATFORM, WEIGHT PLATE HOLDER, SEATED CALF MACHINE, STANDING CALF MACHINE, ROWING MACHINE, COMBINATION SQUAT RACK AND BENCH PRESS BENCHES, ADJUSTABLE FLAT BENCH, ADJUSTABLE LOW-SEATED INCLINE BENCH, BEHIND THE NECK PRESS BENCH, HYPER-EXTENSION BENCH, LEG EXTENSION, LEG CURL, HYPER-EXTENSION MACHINE, SIT-UP BENCH, STANDING CURL BENCH, SEATED INCLINE BENCH, FREE STANDING LYING LEG PRESS, WEIGHT LIFTING GLOVES, WEIGHT LIFTING BELTS, WEIGHT BELT STRAPS AND WRIST STRAPS (U.S. CLS. 22, 23, 38 AND 50).

FIRST USE 4-23-2007; IN COMMERCE 4-23-2007.
GEOFFREY FOSDICK, EXAMINING ATTORNEY

CLASS 9—ELECTRICAL AND SCIENTIFIC APPARATUS

FOR APPARATUS FOR RECORDING, TRANSMISSION OR REPRODUCTION OF SOUNDS OR IMAGES; PRERECORDED MAGNETIC DATA CARRIERS HAVING COMPUTER SOFTWARE STORED THEREON FOR USE IN MULTIVARIATE DATA ANALYSIS, MODELING AND EXPERIMENTAL DESIGN; PRERECORDED RECORDING DISCS HAVING COMPUTER SOFTWARE STORED THEREON FOR USE IN MULTIVARIATE DATA ANALYSIS, MODELING AND EXPERIMENTAL DESIGN; AUTOMATIC VENDING MACHINES AND MECHANISMS FOR COIN-OPERATED APPARATUS; CASH REGISTERS; CALCULATING MACHINES; DATA PROCESSING EQUIPMENT, NAMELY, DATA PROCESSORS; FIRE-EXTINGUISHING APPARATUS, NAMELY, FIRE EXTINGUISHERS (U.S. CLS. 21, 23, 26, 36 AND 38).

CLASS 41—EDUCATION AND ENTERTAINMENT

FOR TEACHING AND EDUCATION, NAMELY, CLASSES, SEMINARS, CONFERENCES, COLLOQUIUMS AND WORKSHOPS, IN THE FIELD OF DESIGN OF EXPERIMENTS AND MULTIVARIATE DATA ANALYSIS AND MODELING; ARRANGING GUIDANCE AND INSTRUCTION, NAMELY, VOCATIONAL GUIDANCE AND INSTRUCTION IN THE FIELD OF MULTIVARIATE DATA ANALYSIS AND MODELING; ORGANIZING COMMUNITY CULTURAL ACTIVITIES AND EVENTS (U.S. CLS. 100, 101 AND 107).

CLASS 42—SCIENTIFIC AND COMPUTER SERVICES

FOR SCIENTIFIC RESEARCH, DEVELOPMENT AND INFORMATION IN THE FIELD OF MULTIVARIATE DATA ANALYSIS, DATA MODELING, AND EXPERIMENTAL DATA MODELING DESIGN; TECHNOLOGICAL INFORMATION ABOUT MULTIVARIATE DATA ANALYSIS, DATA MODELING, AND EXPERIMENTAL DATA MODELING DESIGN; INDUSTRIAL RESEARCH IN THE FIELD OF MULTIVARIATE DATA ANALYSIS, DATA MODELING, AND EXPERIMENTAL DATA MODELING DESIGN; DESIGN AND DEVELOPMENT OF COMPUTER HARDWARE AND SOFTWARE (U.S. CLS. 100 AND 101).

CHRISTINE COOPER, EXAMINING ATTORNEY

SN 77-425,888, MKS UMETRICS AB, UMEÅ, SWEDEN,
FILED 3-19-2008.

SN 77-425,916, MKS UMETRICS AB, UMEÅ, SWEDEN,
FILED 3-19-2008.

OPLS2-DA

O2PLS-DA

THE MARK CONSISTS OF STANDARD CHARACTERS WITHOUT CLAIM TO ANY PARTICULAR FONT, STYLE, SIZE, OR COLOR.

PRIORITY CLAIMED UNDER SEC. 44(D) ON ERP N CMNTY TM OFC APPLICATION NO. 006762785, FILED 3-18-2008, REG. NO. 006762785, DATED 11-14-2008, EXPIRES 11-14-2018.

OWNER OF U.S. REG. NOS. 3,301,655, 3,385,700 AND 3,385,701.

CLASS 9—ELECTRICAL AND SCIENTIFIC APPARATUS

FOR APPARATUS FOR RECORDING, TRANSMISSION OR REPRODUCTION OF SOUNDS OR IMAGES; PRERECORDED MAGNETIC DATA CARRIER HAVING COMPUTER SOFTWARE STORED THEREON FOR USE IN MULTIVARIATE DATA ANALYSIS, MODELING AND EXPERIMENTAL DESIGN; PRERECORDED RECORDING DISCS HAVING COMPUTER SOFTWARE STORED THEREON FOR USE IN MULTIVARIATE DATA ANALYSIS, MODELING AND EXPERIMENTAL DESIGN; AUTOMATIC VENDING MACHINES AND MECHANISMS FOR COIN-OPERATED APPARATUS; CASH REGISTERS; CALCULATING MACHINES; DATA PROCESSING EQUIPMENT, NAMELY, DATA PROCESSORS; FIRE-EXTINGUISHING APPARATUS, NAMELY, FIRE EXTINGUISHERS (U.S. CLS. 21, 23, 26, 36 AND 38).

CLASS 41—EDUCATION AND ENTERTAINMENT

FOR TEACHING AND EDUCATION, NAMELY, CLASSES, SEMINARS, CONFERENCES, COLLOQUIUMS AND WORKSHOPS, IN THE FIELD OF DESIGN OF EXPERIMENTS AND MULTIVARIATE DATA ANALYSIS AND MODELING; ARRANGING GUIDANCE AND INSTRUCTION, NAMELY, VOCATIONAL GUIDANCE AND INSTRUCTION IN THE FIELD OF MULTIVARIATE DATA ANALYSIS AND MODELING; ORGANIZING COMMUNITY CULTURAL ACTIVITIES AND EVENTS (U.S. CLS. 100, 101 AND 107).

CLASS 42—SCIENTIFIC AND COMPUTER SERVICES

FOR SCIENTIFIC RESEARCH, DEVELOPMENT AND INFORMATION IN THE FIELD OF MULTIVARIATE DATA ANALYSIS, DATA MODELING, AND EXPERIMENTAL DATA MODELING DESIGN; TECHNOLOGICAL INFORMATION ABOUT MULTIVARIATE DATA ANALYSIS, DATA MODELING, AND EXPERIMENTAL DATA MODELING DESIGN; INDUSTRIAL RESEARCH IN THE FIELD OF MULTIVARIATE DATA ANALYSIS, DATA MODELING, AND EXPERIMENTAL DATA MODELING DESIGN; DESIGN AND DEVELOPMENT OF COMPUTER HARDWARE AND SOFTWARE (U.S. CLS. 100 AND 101).

CHRISTINE COOPER, EXAMINING ATTORNEY

THE MARK CONSISTS OF STANDARD CHARACTERS WITHOUT CLAIM TO ANY PARTICULAR FONT, STYLE, SIZE, OR COLOR.

PRIORITY CLAIMED UNDER SEC. 44(D) ON ERP N CMNTY TM OFC APPLICATION NO. 006762694, FILED 3-18-2008, REG. NO. 006762694, DATED 11-14-2008, EXPIRES 11-14-2018.

OWNER OF U.S. REG. NOS. 3,301,655, 3,385,700 AND 3,385,701.

CLASS 9—ELECTRICAL AND SCIENTIFIC APPARATUS

FOR APPARATUS FOR RECORDING, TRANSMISSION OR REPRODUCTION OF SOUNDS OR IMAGES; PRERECORDED MAGNETIC DATA CARRIERS HAVING COMPUTER SOFTWARE STORED THEREON FOR USE IN MULTIVARIATE DATA ANALYSIS, MODELING AND EXPERIMENTAL DESIGN; PRERECORDED RECORDING DISCS HAVING COMPUTER SOFTWARE STORED THEREON FOR USE IN MULTIVARIATE DATA ANALYSIS, MODELING AND EXPERIMENTAL DESIGN; AUTOMATIC VENDING MACHINES AND MECHANISMS FOR COIN-OPERATED APPARATUS; CASH REGISTERS; CALCULATING MACHINES; DATA PROCESSING EQUIPMENT, NAMELY, DATA PROCESSORS; FIRE-EXTINGUISHING APPARATUS, NAMELY, FIRE EXTINGUISHERS (U.S. CLS. 21, 23, 26, 36 AND 38).

CLASS 41—EDUCATION AND ENTERTAINMENT

FOR TEACHING AND EDUCATION, NAMELY, CLASSES, SEMINARS, CONFERENCES, COLLOQUIUMS AND WORKSHOPS, IN THE FIELD OF DESIGN OF EXPERIMENTS AND MULTIVARIATE DATA ANALYSIS AND MODELING; ARRANGING GUIDANCE AND INSTRUCTION, NAMELY, VOCATIONAL GUIDANCE AND INSTRUCTION IN THE FIELD OF MULTIVARIATE DATA ANALYSIS AND MODELING; ORGANIZING COMMUNITY CULTURAL ACTIVITIES AND EVENTS (U.S. CLS. 100, 101 AND 107).

CLASS 42—SCIENTIFIC AND COMPUTER SERVICES

FOR SCIENTIFIC RESEARCH, DEVELOPMENT AND INFORMATION IN THE FIELD OF MULTIVARIATE DATA ANALYSIS, DATA MODELING, AND EXPERIMENTAL DATA MODELING DESIGN; TECHNOLOGICAL INFORMATION ABOUT MULTIVARIATE DATA ANALYSIS, DATA MODELING, AND EXPERIMENTAL DATA MODELING DESIGN; INDUSTRIAL RESEARCH IN THE FIELD OF MULTIVARIATE DATA ANALYSIS, DATA MODELING, AND EXPERIMENTAL DATA MODELING DESIGN; DESIGN AND DEVELOPMENT OF COMPUTER HARDWARE AND SOFTWARE (U.S. CLS. 100 AND 101).

CHRISTINE COOPER, EXAMINING ATTORNEY

SN 77-426.612. TATWEER DUBAI LLC, DUBAI, UNITED ARAB EMIR., FILED 3-19-2008.

SN 77-427.908. GARNETT, KEVIN, LOS ANGELES, CA. FILED 3-20-2008.

DUBAILAND

THE MARK CONSISTS OF STANDARD CHARACTERS WITHOUT CLAIM TO ANY PARTICULAR FONT, STYLE, SIZE, OR COLOR.

CLASS 35—ADVERTISING AND BUSINESS

FOR PROMOTING TRAVEL AND TOURISM TO AND IN THE VICINITY OF DUBAILAND LOCATED IN DUBAI, UNITED ARAB EMIRATES; TRAVEL MANAGEMENT (U.S. CLS. 100, 101 AND 102).

CLASS 39—TRANSPORTATION AND STORAGE

FOR ARRANGING OF TRAVEL TOURS; ORGANIZATION OF TRAVEL (U.S. CLS. 100 AND 105).
FRANK LATTUCA, EXAMINING ATTORNEY



SN 77-427.905. GARNETT, KEVIN, LOS ANGELES, CA. FILED 3-20-2008.

PLANET G55

THE MARK CONSISTS OF STANDARD CHARACTERS WITHOUT CLAIM TO ANY PARTICULAR FONT, STYLE, SIZE, OR COLOR.

CLASS 35—ADVERTISING AND BUSINESS

FOR ONLINE RETAIL STORE SERVICES IN THE FIELD OF CLOTHING, HEADWEAR, FOOTWEAR, AND ACCESSORIES THEREFORE (U.S. CLS. 100, 101 AND 102).

CLASS 41—EDUCATION AND ENTERTAINMENT

FOR PROVIDING AN INTERNET WEB SITE IN THE FIELDS OF SPORTS, SPORTS FIGURES, AND ENTERTAINMENT (U.S. CLS. 100, 101 AND 107).

CLASS 45—PERSONAL AND LEGAL SERVICES

FOR ONLINE SOCIAL NETWORKING (U.S. CLS. 100 AND 101).
DEZMONA MIZELLE, EXAMINING ATTORNEY

PLANET G5

THE MARK CONSISTS OF STANDARD CHARACTERS WITHOUT CLAIM TO ANY PARTICULAR FONT, STYLE, SIZE, OR COLOR.

CLASS 35—ADVERTISING AND BUSINESS

FOR ONLINE RETAIL STORE SERVICES IN THE FIELD OF CLOTHING, HEADWEAR, FOOTWEAR, AND ACCESSORIES THEREFORE (U.S. CLS. 100, 101 AND 102).

CLASS 41—EDUCATION AND ENTERTAINMENT

FOR PROVIDING AN INTERNET WEB SITE IN THE FIELDS OF SPORTS, SPORTS FIGURES, AND ENTERTAINMENT (U.S. CLS. 100, 101 AND 107).

CLASS 45—PERSONAL AND LEGAL SERVICES

FOR ONLINE SOCIAL NETWORKING (U.S. CLS. 100 AND 101).
DEZMONA MIZELLE, EXAMINING ATTORNEY



SN 77-427.911. GARNETT, KEVIN, LOS ANGELES, CA. FILED 3-20-2008.

PLANET GG55

THE MARK CONSISTS OF STANDARD CHARACTERS WITHOUT CLAIM TO ANY PARTICULAR FONT, STYLE, SIZE, OR COLOR.

CLASS 35—ADVERTISING AND BUSINESS

FOR ONLINE RETAIL STORE SERVICES IN THE FIELD OF CLOTHING, HEADWEAR, FOOTWEAR, AND ACCESSORIES THEREFORE (U.S. CLS. 100, 101 AND 102).

CLASS 41—EDUCATION AND ENTERTAINMENT

FOR PROVIDING AN INTERNET WEB SITE IN THE FIELDS OF SPORTS, SPORTS FIGURES, AND ENTERTAINMENT (U.S. CLS. 100, 101 AND 107).

CLASS 45—PERSONAL AND LEGAL SERVICES

FOR ONLINE SOCIAL NETWORKING (U.S. CLS. 100 AND 101).
DEZMONA MIZELLE, EXAMINING ATTORNEY

SN 77-427,915. HENDRICKSON, BRADLEY MARSHALL, DBA HENDRICKSON, B. MARSHALL, MANCHESTER, MO. FILED 3-20-2008.

SN 77-429,210. JOHNSON & JOHNSON, NEW BRUNSWICK, NJ. FILED 3-24-2008.

Precision Purchasing

THE MARK CONSISTS OF STANDARD CHARACTERS WITHOUT CLAIM TO ANY PARTICULAR FONT, STYLE, SIZE, OR COLOR.

NO CLAIM IS MADE TO THE EXCLUSIVE RIGHT TO USE "PURCHASING", APART FROM THE MARK AS SHOWN.

CLASS 35—ADVERTISING AND BUSINESS

FOR PROCUREMENT SERVICES, NAMELY, PURCHASING SERVICES FOR CONSUMERS, UTILIZING A TOTAL PROFILE DATABASE SYSTEM COMPRISED OF CONSUMER PURCHASING PREFERENCES, FOR PURCHASING GOODS AND SERVICES TO BE USED BY PARTICIPATING CONSUMERS OR GIFTED ON THEIR BEHALF TO OTHERS (U.S. CLS. 100, 101 AND 102).

CLASS 36—INSURANCE AND FINANCIAL

FOR ELECTRONIC FUNDS TRANSFER SERVICES (U.S. CLS. 100, 101 AND 102).

CLASS 39—TRANSPORTATION AND STORAGE

FOR TRANSPORTATION RESERVATION SERVICES (U.S. CLS. 100 AND 105).

CLASS 41—EDUCATION AND ENTERTAINMENT

FOR TICKET RESERVATION SERVICES FOR ENTERTAINMENT, SPORTING AND CULTURAL EVENTS (U.S. CLS. 100, 101 AND 107).

CLASS 43—HOTEL AND RESTAURANT SERVICES

FOR MAKING RESERVATIONS FOR OTHERS FOR TEMPORARY ACCOMMODATIONS AND MEALS (U.S. CLS. 100 AND 101).

CLASS 44—MEDICAL, BEAUTY AND AGRICULTURAL SERVICES

FOR MAKING RESERVATIONS FOR OTHERS FOR PHYSICAL AND BEAUTY TREATMENTS AT HEALTH SPAS AND BEAUTY SALONS (U.S. CLS. 100 AND 101).
NICHOLAS ALTREE, EXAMINING ATTORNEY

EVOLENCE STAR

THE MARK CONSISTS OF STANDARD CHARACTERS WITHOUT CLAIM TO ANY PARTICULAR FONT, STYLE, SIZE, OR COLOR.

OWNER OF U.S. REG. NO. 3,031,450.

THE WORDING "EVOLENCE" HAS NO MEANING IN A FOREIGN LANGUAGE.

CLASS 16—PAPER GOODS AND PRINTED MATTER

FOR PRINTED PUBLICATIONS, NAMELY, PAMPHLETS, BROCHURES AND MANUALS IN THE FIELD OF TRAINING HEALTHCARE PROVIDERS RELATING TO DERMATOLOGICAL PROCEDURES (U.S. CLS. 2, 5, 22, 23, 29, 37, 38 AND 50).

CLASS 41—EDUCATION AND ENTERTAINMENT

FOR EDUCATIONAL SERVICES, NAMELY, PROVIDING TRAINING TO HEALTHCARE PROVIDERS IN THE FIELD OF DERMATOLOGICAL PROCEDURES (U.S. CLS. 100, 101 AND 107).

EDWARD FENNESSY, EXAMINING ATTORNEY

SN 77-429,374. JOHNSON & JOHNSON, NEW BRUNSWICK, NJ. FILED 3-24-2008.

ARESTIN MDX

THE MARK CONSISTS OF STANDARD CHARACTERS WITHOUT CLAIM TO ANY PARTICULAR FONT, STYLE, SIZE, OR COLOR.

OWNER OF U.S. REG. NO. 2,601,899.

THE WORDING "MDX" HAS NO MEANING IN A FOREIGN LANGUAGE.

CLASS 5—PHARMACEUTICALS

FOR ANTIBIOTICS USED TO TREAT PERIODONTAL DISEASE (U.S. CLS. 6, 18, 44, 46, 51 AND 52).

CLASS 10—MEDICAL APPARATUS

FOR DENTAL INSTRUMENTS IN THE NATURE OF MEDICATION DISPENSING DEVICES (U.S. CLS. 26, 39 AND 44).

JERI J. FICKES, EXAMINING ATTORNEY

SN 77-430,551. WATER STANDARD COMPANY (MI), HOUSTON, TX. FILED 3-25-2008.

right for the ocean.
right for the
environment. right for
the world.

THE MARK CONSISTS OF STANDARD CHARACTERS WITHOUT CLAIM TO ANY PARTICULAR FONT, STYLE, SIZE, OR COLOR.

CLASS 11—ENVIRONMENTAL CONTROL APPARATUS

FOR WATER DESALINATION UNITS AND PLANTS; WATER TREATMENT UNITS AND PLANTS; WATER PURIFICATION UNITS AND PLANTS; AND PARTS AND FITTINGS FOR ALL OF THE AFORESAID GOODS, NAMELY, COMPONENT PARTS (U.S. CLS. 13, 21, 23, 31 AND 34).

CLASS 12—VEHICLES

FOR SHIPS (U.S. CLS. 19, 21, 23, 31, 35 AND 44).

CLASS 32—LIGHT BEVERAGES

FOR DRINKING WATER IN THE NATURE OF DESALINATED WATER, TREATED WATER, OR PURIFIED WATER; BOTTLED DRINKING WATER (U.S. CLS. 45, 46 AND 48).

CLASS 35—ADVERTISING AND BUSINESS

FOR BUSINESS MANAGEMENT AND CONSULTATION, AND MARKETING CONSULTATION, ALL IN THE FIELDS OF DESALINATION, TREATMENT, PURIFICATION, STORAGE, TRANSPORTATION, AND REGARDING THE SALE OF WATER; OPERATION AND MANAGEMENT OF DESALINATION UNITS AND PLANTS FOR OTHERS; OPERATION AND BUSINESS MANAGEMENT OF WATER TREATMENT UNITS AND PLANTS FOR OTHERS; OPERATION AND BUSINESS MANAGEMENT OF WATER PURIFICATION UNITS AND PLANTS FOR OTHERS; OPERATION AND BUSINESS MANAGEMENT OF SHIPS FOR OTHERS; AND DISTRIBUTORSHIPS IN THE FIELD OF DESALINATED WATER, TREATED WATER, AND PURIFIED WATER (U.S. CLS. 100, 101 AND 102).

CLASS 37—CONSTRUCTION AND REPAIR

FOR CONSTRUCTION, INSTALLATION, MAINTENANCE, REPAIR, AND SERVICING OF DESALINATION UNITS, DESALINATION PLANTS AND FACILITIES, WATER TREATMENT UNITS, WATER TREATMENT PLANTS AND FACILITIES, WATER PURIFICATION UNITS, WATER PURIFICATION PLANTS AND FACILITIES, WATER STORAGE UNITS, PIPELINES, BUOYS, AND DOCKS; MAINTENANCE, REPAIR, AND SERVICING OF SHIPS, NAMELY, MAINTENANCE, REPAIR AND SERVICING OF SHIP OPERATING EQUIPMENT FOR POWER PROPULSION, NAVIGATION, STEERING, AND CREW HABITATION OF A SHIP (U.S. CLS. 100, 103 AND 106).

CLASS 39—TRANSPORTATION AND STORAGE

FOR LEASING OF SHIPS; STORAGE OF DESALINATED WATER; STORAGE OF TREATED WATER; STORAGE OF PURIFIED WATER; TRANSPORTATION OF DESALINATED WATER BY PIPELINE OR BY SHIPS; BUNKERING OF SHIPS; AND DISTRIBUTION OF DESALINATED WATER, TREATED WATER, AND PURIFIED WATER (U.S. CLS. 100 AND 105).

CLASS 40—MATERIAL TREATMENT

FOR DESALINATION, TREATMENT, AND PURIFICATION OF WATER; LEASING OF DESALINATION UNITS AND PLANTS; LEASING OF WATER PURIFICATION UNITS AND PLANTS; AND LEASING OF WATER TREATMENT UNITS AND PLANTS (U.S. CLS. 100, 103 AND 106).

CLASS 42—SCIENTIFIC AND COMPUTER SERVICES

FOR ENGINEERING AND DESIGN SERVICES, AND TECHNICAL SUPPORT SERVICES, NAMELY, TECHNICAL ANALYSIS OF DESALINATION PROCESSES, TO DETERMINE HOW TO MAINTAIN THE PROCESSES, TO DETERMINE HOW TO IMPROVE THE PROCESS, TO FACILITATE IMPROVEMENT OF THE PROCESSES, TO DETERMINE HOW TO MAKE THE PROCESSES MORE ENVIRONMENTALLY SOUND, AND TO FACILITATE MAKING THE PROCESS ENVIRONMENTALLY SOUND, ALL FOR THE DESALINATION, TREATMENT, PURIFICATION, STORAGE, AND TRANSPORTATION OF WATER; TECHNICAL SUPPORT SERVICES, NAMELY, TECHNICAL CONSULTANCY IN THE FIELD OF DESALINATION TECHNOLOGY, TECHNICAL CONSULTANCY IN THE FIELD OF WATER TREATMENT TECHNOLOGY, TECHNICAL CONSULTANCY IN THE FIELD OF WATER PURIFICATION TECHNOLOGY, TECHNICAL CONSULTANCY IN THE FIELD OF WATER STORAGE TECHNOLOGY, AND TECHNICAL CONSULTANCY IN THE FIELD OF WATER TRANSPORTATION TECHNOLOGY, ALL FOR THE DESALINATION, TREATMENT, PURIFICATION, STORAGE, AND TRANSPORTATION OF WATER; TECHNICAL CONSULTATION, TECHNOLOGY SUPERVISION AND INSPECTION IN THE FIELD OF DESALINATION; TECHNOLOGY SUPERVISION AND INSPECTION IN THE FIELD OF WATER TREATMENT; TECHNOLOGY SUPERVISION AND INSPECTION IN THE FIELD OF WATER PURIFICATION TECHNOLOGY; TECHNOLOGY SUPERVISION AND INSPECTION IN THE FIELD OF WATER STORAGE TECHNOLOGY; AND TECHNOLOGY SUPERVISION AND INSPECTION IN THE FIELD OF WATER TRANSPORTATION TECHNOLOGY (U.S. CLS. 100 AND 101).

RUDY R. SINGLETON, EXAMINING ATTORNEY

SN 77-431,096. 911 RESTORATION ENTERPRISE, INC., VAN NUYS, CA. FILED 3-25-2008.

911 RESTORATION

THE MARK CONSISTS OF STANDARD CHARACTERS WITHOUT CLAIM TO ANY PARTICULAR FONT, STYLE, SIZE, OR COLOR.

NO CLAIM IS MADE TO THE EXCLUSIVE RIGHT TO USE "RESTORATION", APART FROM THE MARK AS SHOWN.

CLASS 37—CONSTRUCTION AND REPAIR

FOR CONSTRUCTION SERVICES, NAMELY, RESTORATION OF BUILDINGS AND RESTORATION OF BUILDINGS AFTER WATER DAMAGE (U.S. CLS. 100, 103 AND 106).

FIRST USE 3-8-2003; IN COMMERCE 3-8-2003.

CLASS 40—MATERIAL TREATMENT

FOR MOLD REMEDIATION SERVICES (U.S. CLS. 100, 103 AND 106).

FIRST USE 3-8-2003; IN COMMERCE 3-8-2003.

DOMINICK J. SALEMI, EXAMINING ATTORNEY

SN 77-431,118. DOT GMBH, ROSTOCK, FED REP GER-
MANY, FILED 3-25-2008.

BONIT

THE MARK CONSISTS OF STANDARD CHARACTERS WITHOUT CLAIM TO ANY PARTICULAR FONT, STYLE, SIZE, OR COLOR.
OWNER OF U.S. REG. NO. 2,552,073.

CLASS 1—CHEMICALS

FOR ELECTROCHEMICAL DEPOSITED CALCIUM PHOSPHATE PREPARATIONS FOR USE IN THE MANUFACTURE OF IMPLANTS, NAMELY, FOR USE IN THE MANUFACTURE OF ORTHOPEDIC, TRAUMATOLOGIC AND DENTAL IMPLANTS TO IMPROVE AND TO ACCELERATE THE INGROWING OF THE IMPLANT (U.S. CLS. 1, 5, 6, 10, 26 AND 46).

CLASS 10—MEDICAL APPARATUS

FOR OSSEOUS IMPLANTS AND ORTHOPEDIC JOINT IMPLANTS; SURGICAL IMPLANTS COMPRISING ARTIFICIAL MATERIAL FOR USE IN HUMAN AND VETERINARY MEDICINE (U.S. CLS. 26, 39 AND 44).

CLASS 40—MATERIAL TREATMENT

FOR APPLICATION OF COATINGS TO IMPLANTS FOR IMPROVING AND ACCELERATING THE INGROWING OF THE IMPLANT FOR USE IN HUMAN AND VETERINARY MEDICINE (U.S. CLS. 100, 103 AND 106).
TIMOTHY FINNEGAN, EXAMINING ATTORNEY

SN 77-431,469. DIGGS, ROBERT, NEW YORK, NY. FILED 3-25-2008.



THE MARK CONSISTS OF A HIGHLY STYLIZED VERSION OF THE LETTER "W" RESEMBLING A BAT.

CLASS 9—ELECTRICAL AND SCIENTIFIC APPARATUS

FOR COMPACT DISCS FEATURING MUSIC; DVDS FEATURING MUSIC; DIGITAL MEDIA, NAMELY, PRE-RECORDED VIDEO CASSETTES, DIGITAL VIDEO DISCS, DIGITAL VERSATILE DISCS, DOWNLOADABLE AUDIO AND VIDEO RECORDINGS, DVDS, AND HIGH DEFINITION DIGITAL DISKS FEATURING MUSIC; PRE-RECORDED CDS, VIDEO TAPES, LASER DISKS AND DVDS FEATURING MUSIC; AUDIO AND VIDEO RECORDINGS FEATURING MUSIC; AUDIO RECORDINGS FEATURING MUSIC; PRERECORDED DIGITAL AUDIO TAPE FEATURING MUSIC; DOWNLOADABLE MP3 FILES, MP3 RECORDINGS, ONLINE DISCUSSION BOARDS, WEBCASTS AND PODCASTS FEATURING MUSIC, AUDIO BOOKS AND NEWS BROADCASTS; DOWNLOADABLE MUSICAL SOUND RECORDINGS; DOWNLOADABLE RING TONES FOR MOBILE PHONES; DOWNLOADABLE RING TONES, GRAPHICS AND MUSIC VIA A GLOBAL COMPUTER NETWORK AND WIRELESS DEVICES; DOWNLOADABLE VIDEO RECORDINGS FEATURING MUSIC; MUSICAL SOUND RECORDINGS; MUSICAL VIDEO RECORDINGS; PRE-RECORDED DIGITAL MEDIA FEATURING MUSIC; PRE-RECORDED ELECTRONIC MEDIA MUSIC (U.S. CLS. 21, 23, 26, 36 AND 38).
FIRST USE 1-15-1993; IN COMMERCE 1-15-1993.

CLASS 25—CLOTHING

FOR BABY TOPS; HALTER TOPS; MUSCLE TOPS; TANK TOPS; CROP TOPS; INFANT AND TODDLER ONE PIECE CLOTHING; SHORT SETS; SHIRTS; SHORT-SLEEVED OR LONG-SLEEVED T-SHIRTS; SLEEP SHIRTS; SPORT SHIRTS; SWEAT SHIRTS; PANTS; CARGO PANTS; DENIMS; JOGGING PANTS; SWEAT PANTS; HEADGEAR, NAMELY, HATS AND CAPS; SHOES; SNEAKERS; SOCKS; BOXER SHORTS; GYM SHORTS; PANTIES, SHORTS AND BRIEFS; SWEAT SHORTS; PAJAMAS; COATS; JACKETS (U.S. CLS. 22 AND 39).
FIRST USE 1-15-1993; IN COMMERCE 1-15-1993.

CLASS 41—EDUCATION AND ENTERTAINMENT

FOR ENTERTAINMENT, NAMELY, LIVE MUSIC CONCERTS; ENTERTAINMENT, NAMELY, LIVE PERFORMANCES BY A MUSICAL BAND; MUSIC COMPOSITION FOR OTHERS; PRODUCTION OF SOUND AND MUSIC VIDEO RECORDINGS; ENTERTAINMENT SERVICES, NAMELY, PROVIDING A WEB SITE FEATURING MUSICAL PERFORMANCES, MUSICAL VIDEOS, RELATED FILM CLIPS, PHOTOGRAPHS, AND OTHER MULTIMEDIA MATERIALS (U.S. CLS. 100, 101 AND 107).
FIRST USE 1-15-1993; IN COMMERCE 1-15-1993.
PAULA MAHONEY, EXAMINING ATTORNEY

SN 77-433,003. UBICMEDIA, LYON, FRANCE, FILED 3-27-2008.

PUM

THE MARK CONSISTS OF STANDARD CHARACTERS WITHOUT CLAIM TO ANY PARTICULAR FONT, STYLE, SIZE, OR COLOR.
PRIORITY CLAIMED UNDER SEC. 44(D) ON ERPN CMNTY TM OFC APPLICATION NO. 006429666, FILED 10-31-2007, REG. NO. 006429666, DATED 10-23-2008, EXPIRES 10-31-2017.

CLASS 9—ELECTRICAL AND SCIENTIFIC APPARATUS

FOR COMPUTER SOFTWARE THAT ALLOWS THE CONTROL AND THE CIRCULATION OF MULTIMEDIA CONTENT THROUGH THE INTERNET (U.S. CLS. 21, 23, 26, 36 AND 38).

CLASS 38—COMMUNICATION

FOR COMMUNICATION BY COMPUTER TERMINALS AND FIBER OPTIC NETWORKS RELATED TO THE CONTROL AND THE CIRCULATION OF MULTIMEDIA CONTENT THROUGH THE INTERNET (U.S. CLS. 100, 101 AND 104).

CLASS 42—SCIENTIFIC AND COMPUTER SERVICES

FOR CONCEPTION AND DEVELOPMENT OF COMPUTER SOFTWARE THAT ALLOWS THE CONTROL AND THE CIRCULATION OF MULTIMEDIA CONTENT THROUGH THE INTERNET (U.S. CLS. 100 AND 101).
HEATHER THOMPSON, EXAMINING ATTORNEY

CLASS 41—EDUCATION AND ENTERTAINMENT

FOR PROVIDING SEMINARS IN THE FIELD OF MOTORCYCLE EDUCATION AND MOTORCYCLE MAINTENANCE GUIDANCE; PROVIDING EDUCATION SERVICES, NAMELY, LIVE AND ON-LINE SEMINARS IN THE FIELD OF MOTORCYCLE AWARENESS, MAINTENANCE AND REPAIR (U.S. CLS. 100, 101 AND 107).

LAURIE KAUFMAN, EXAMINING ATTORNEY

SN 77-435,675. AMERICAN AUTOMOBILE ASSOCIATION, INC., HEATHROW, FL. FILED 3-31-2008.

AAA AUTOMANAGER

THE MARK CONSISTS OF STANDARD CHARACTERS WITHOUT CLAIM TO ANY PARTICULAR FONT, STYLE, SIZE, OR COLOR.

OWNER OF U.S. REG. NOS. 829,265 AND 2,900,596.

NO CLAIM IS MADE TO THE EXCLUSIVE RIGHT TO USE "AUTO MANAGER", APART FROM THE MARK AS SHOWN.

CLASS 38—COMMUNICATION

FOR PROVIDING E-MAIL NOTIFICATION OF MOTOR VEHICLE SERVICE AND ASSOCIATED SERVICE DEADLINES, AUTOMAKER RECALLS AND SAFETY ALERTS, AND PAYMENT DEADLINES (U.S. CLS. 100, 101 AND 104).

CLASS 39—TRANSPORTATION AND STORAGE

FOR ELECTRONIC STORAGE OF DOCUMENTS REGARDING MOTOR VEHICLE MAINTENANCE, FINANCING, INSURANCE, AND WARRANTY INFORMATION (U.S. CLS. 100 AND 105).

MICHAEL GAAFAR, EXAMINING ATTORNEY

SN 77-438,077. SANDVIK INTELLECTUAL PROPERTY AB, SANDVIKEN, SWEDEN, FILED 4-2-2008.



OWNER OF SWEDEN REG. NO. 398334, DATED 10-24-2008, EXPIRES 10-24-2018.

THE MARK CONSISTS OF A RECTANGLE CONTAINING THE WORD "SANDVIK" ATOP A SMALLER RECTANGLE.

THE FOREIGN WORDING IN THE MARK TRANSLATES INTO ENGLISH AS "SANDY BEACH".

SN 77-433,890. LALIBERTE, SARA, ANN, DBA GARAGE-GIRLS, PITTSBURGH, PA. FILED 3-27-2008.



THE NAME(S), PORTRAIT(S), AND/OR SIGNATURE(S) SHOWN IN THE MARK IDENTIFIES SARA LIBERTE, WHOSE CONSENT(S) TO REGISTER IS SUBMITTED.

THE COLOR(S) ORANGE, BLACK, PINK, TEAL, GREEN, GRAY, WHITE, AND BROWN IS/ARE CLAIMED AS A FEATURE OF THE MARK.

THE MARK CONSISTS OF A WOMAN WEARING A T-SHIRT WITH A STAR ON IT AND A TOOL BOX. THE COLOR GREEN APPEARS IN THE WORDING "SARA LIBERTE'S" AND IN THE WOMAN'S SHOES. THE COLOR TEAL APPEARS IN THE WORDING "GARAGE GIRLS". THE COLOR ORANGE APPEARS ON THE WOMAN'S T-SHIRT. THE COLOR WHITE APPEARS ON THE STAR ON THE T-SHIRT AND THE WOMAN. THE COLOR BLACK APPEARS ON THE WOMAN AND THE TOOLBOX. THE COLOR GRAY APPEARS ON THE WOMAN'S GLASSES AND THE TOOLBOX. THE COLOR BROWN APPEARS ON THE TOOLBOX. THE COLOR PINK APPEARS IN THE WOMAN'S HAIR.

CLASS 18—LEATHER GOODS

FOR BACKPACKS, BOOK BAGS, SPORTS BAGS, BUM BAGS, WALLETS AND HANDBAGS; EVENING HANDBAGS; HANDBAGS; HANDBAGS, PURSES AND WALLETS (U.S. CLS. 1, 2, 3, 22 AND 41).

CLASS 37—CONSTRUCTION AND REPAIR

FOR WEBSITES FEATURING INFORMATION ABOUT MOTORCYCLE MAINTENANCE AND REPAIR (U.S. CLS. 100, 103 AND 106).

CLASS 7—MACHINERY

FOR MACHINE PARTS, NAMELY, METAL NOZZLES WHICH ARE PARTS OF POWER-OPERATED SPRAYERS; PILE-EXTRACTORS FOR USE IN MINES; MINE BORERS; TUNNELING MACHINES FOR USE IN MINING; SIFTING MACHINES FOR SIFTING ROCKS AND GRAVEL; MACHINE PARTS, NAMELY, DRILL BITS FOR MACHINES; DRILLING MACHINES; MACHINE PARTS, NAMELY, DRILL CHUCKS; POWER DRILL PARTS, NAMELY, DRILL CHISELS, DRILL BUTTONS; DRILLING RIGS, FLOATING AND NOT FLOATING; MILLING MACHINES, GRINDING MACHINES, SHARPENING MACHINES; MACHINE PARTS, NAMELY, GRINDSTONES; FEEDERS FOR ROCK CRUSHING MACHINES; MACHINE PARTS, NAMELY, BELT CONVEYORS; PNEUMATIC TRANSPORTERS; CONVEYOR MACHINES; PULLEYS BEING PARTS OF MACHINES; HAMMERS BEING PARTS OF MACHINES; PNEUMATIC HAMMERS, PNEUMATIC CONTROLS FOR MACHINES, MOTORS AND ENGINES; MACHINES FOR INDUSTRIAL USE, NAMELY, PNEUMATIC VIBRATORS; CUTTING MACHINES; MACHINE PARTS, NAMELY, BLADES AND BLADE HOLDERS; HANDLING APPARATUS FOR LOADING AND UNLOADING, NAMELY, CONVEYOR BELTS; DIGGER AND EARTH MOVING MACHINES, NAMELY, EXCAVATORS; COAL LOADING MACHINES, ROCK LOADING MACHINES; POWER OPERATED DRILL PARTS, NAMELY, DRILL RODS AND DRILL BARS; EARTH MOVING MACHINES, NAMELY, LOADERS (U.S. CLS. 13, 19, 21, 23, 31, 34 AND 35).

CLASS 9—ELECTRICAL AND SCIENTIFIC APPARATUS

FOR COMPUTER PROGRAMS AND SOFTWARE FOR OPERATING AUTOMATED MACHINES IN MINES OPERATED BY A PERSON LOCATED OUTSIDE THE MINE AND ABOVE THE GROUND; COMPUTERS; COMPUTER PERIPHERAL EQUIPMENT; VEHICLE DRIVE TRAINING SIMULATORS FOR STEERING AND CONTROL OF DRILLING VEHICLES; ELECTRONIC APPARATUS FOR THE REMOTE CONTROL OF INDUSTRIAL OPERATIONS; ELECTRIC INSTALLATIONS FOR THE REMOTE CONTROL OF INDUSTRIAL OPERATIONS; CYCLIC MOTIONS, NAMELY, CIRCUIT BREAKERS; AUTOMATIC WATERING INSTALLATIONS, NAMELY, AUTOMATIC FIRE PROTECTION SPRINKLERS (U.S. CLS. 21, 23, 26, 36 AND 38).

CLASS 12—VEHICLES

FOR MINE CARTS; UNDERGROUND MINING HAULING APPARATUS FOR HAULING ROCK AND ORE, NAMELY, MINING CARTS (U.S. CLS. 19, 21, 23, 31, 35 AND 44).

CLASS 37—CONSTRUCTION AND REPAIR

FOR REPAIR OF MINING AND CONSTRUCTION EQUIPMENT; PROVIDING INFORMATION IN THE FIELD OF CONSTRUCTING MINES AND BUILDINGS (U.S. CLS. 100, 103 AND 106).

CLASS 38—COMMUNICATION

FOR TRANSFER AND TRANSMISSION OF DATABASE INFORMATION VIA TELECOMMUNICATIONS NETWORKS; PROVIDING INFORMATION ON ACCESS TO TELECOMMUNICATION NETWORKS VIA A PORTAL WEBSITE (U.S. CLS. 100, 101 AND 104).
KIM MONINGHOFF, EXAMINING ATTORNEY

SN 77-438,583. BUNDLEPASS, LLC, KEY BISCAIYNE, FL.
FILED 4-3-2008.

BundlePass

THE MARK CONSISTS OF STANDARD CHARACTERS WITHOUT CLAIM TO ANY PARTICULAR FONT, STYLE, SIZE, OR COLOR.

CLASS 16—PAPER GOODS AND PRINTED MATTER

FOR NON-MAGNETICALLY ENCODED FIDELITY CARDS (U.S. CLS. 2, 5, 22, 23, 29, 37, 38 AND 50).

CLASS 17—RUBBER GOODS

FOR LAMINATES IN THE NATURE OF A PLASTIC SHEET COATING FOR USE ON CREDIT CARDS, IDENTIFICATION CARDS, MEMBERSHIP CARDS, DEBIT CARDS, AND CHECK CARDS (U.S. CLS. 1, 5, 12, 13, 35 AND 50).

CLASS 35—ADVERTISING AND BUSINESS

FOR CONSUMER LOYALTY SERVICES FOR COMMERCIAL, PROMOTIONAL, AND/OR ADVERTISING PURPOSES, NAMELY, ADMINISTRATION OF FREQUENT FLYER PROGRAM THAT ALLOWS MEMBERS TO REDEEM MILES FOR POINTS OR AWARDS OFFERED BY OTHER LOYALTY PROGRAMS; CUSTOMER LOYALTY SERVICES AND CUSTOMER CLUB SERVICES, FOR COMMERCIAL, PROMOTIONAL AND/OR ADVERTISING PURPOSES; PROVIDING INCENTIVE AWARD PROGRAMS FOR CUSTOMERS AND EMPLOYEES THROUGH THE DISTRIBUTION OF PREPAID STORED VALUE CARDS FOR THE PURPOSE OF PROMOTING AND REWARDING LOYALTY; ADMINISTRATION OF A DISCOUNT PROGRAM FOR ENABLING PARTICIPANTS TO OBTAIN DISCOUNTS ON GOODS AND SERVICES THROUGH USE OF A DISCOUNT MEMBERSHIP CARD; MEMBERSHIP CLUB SERVICES PROVIDING DISCOUNTS AND PROCESSING REBATES FOR THE SERVICES OF OTHERS; PROVIDING A WEB SITE FEATURING ONLINE REGISTRATION SERVICES FOR CAR CLUB MEMBERSHIP (U.S. CLS. 100, 101 AND 102).

CLASS 36—INSURANCE AND FINANCIAL

FOR PROVIDING CASH AND OTHER REBATES FOR CREDIT CARD USE AS PART OF A CUSTOMER LOYALTY PROGRAM; PROVIDING REBATES AT PARTICIPATING ESTABLISHMENTS OF OTHERS THROUGH USE OF A MEMBERSHIP CARD (U.S. CLS. 100, 101 AND 102).

CLASS 45—PERSONAL AND LEGAL SERVICES

FOR ASSIGNMENT OF MEMBERSHIP IDENTIFICATION NUMBERS TO AFFIX TO VALUABLES TO FACILITATE THEIR RECOVERY FOLLOWING LOSS OR THEFT (U.S. CLS. 100 AND 101).
JAMES A. RAUEN, EXAMINING ATTORNEY

SN 77-439,602. L'OREAL, PARIS, FRANCE, FILED 4-3-2008.

SN 77-441,702. NOVA SOUTHEASTERN UNIVERSITY, FORT LAUDERDALE, FL. FILED 4-7-2008.

RUBILANE

THE MARK CONSISTS OF STANDARD CHARACTERS WITHOUT CLAIM TO ANY PARTICULAR FONT, STYLE, SIZE, OR COLOR.

PRIORITY CLAIMED UNDER SEC. 44(D) ON FRANCE APPLICATION NO. 073532376, FILED 10-22-2007, REG. NO. 073532376, DATED 10-22-2007, EXPIRES 10-22-2017.

CLASS 1—CHEMICALS

FOR CHEMICALS USED IN THE COMPOSITION OF HAIR PRODUCTS (U.S. CLS. 1, 5, 6, 10, 26 AND 46).

CLASS 3—COSMETICS AND CLEANING PREPARATIONS

FOR HAIR COLORING PREPARATIONS FOR PROFESSIONAL USE SOLD IN THE HAIRDRESSING SALONS (U.S. CLS. 1, 4, 6, 50, 51 AND 52).

TINA L. SNAPP, EXAMINING ATTORNEY

SN 77-441,458. THE INTECH GROUP, INC., EXTON, PA. FILED 4-7-2008.

INTECH

THE MARK CONSISTS OF STANDARD CHARACTERS WITHOUT CLAIM TO ANY PARTICULAR FONT, STYLE, SIZE, OR COLOR.

CLASS 35—ADVERTISING AND BUSINESS

FOR OPERATION AND ADMINISTRATION OF TELECOMMUNICATION SYSTEMS AND NETWORKS FOR OTHERS (U.S. CLS. 100, 101 AND 102).

FIRST USE 0-0-1987; IN COMMERCE 0-0-1987.

CLASS 38—COMMUNICATION

FOR TELECOMMUNICATION CONSULTATION IN THE NATURE OF TECHNICAL CONSULTING IN THE FIELD OF VOICE, DATA, GRAPHICS, SOUND AND VIDEO TRANSMISSIONS AND COMMUNICATIONS; TELEPHONE COMMUNICATION SERVICES (U.S. CLS. 100, 101 AND 104).

FIRST USE 0-0-1987; IN COMMERCE 0-0-1987.

CLASS 42—SCIENTIFIC AND COMPUTER SERVICES

FOR PLANNING, DEVELOPMENT AND TECHNICAL SUPPORT OF COMMUNICATION SYSTEMS FOR OTHERS; COMPUTER SERVICES, NAMELY, INSTALLATION, MAINTENANCE AND REPAIR OF COMPUTER SOFTWARE FOR USE IN COMMUNICATION SYSTEMS; TROUBLESHOOTING OF COMMUNICATION SYSTEMS COMPUTER HARDWARE PROBLEMS (U.S. CLS. 100 AND 101).

FIRST USE 0-0-1987; IN COMMERCE 0-0-1987.
JOHN GARTNER, EXAMINING ATTORNEY

CAUSE AN EFFECT

THE MARK CONSISTS OF STANDARD CHARACTERS WITHOUT CLAIM TO ANY PARTICULAR FONT, STYLE, SIZE, OR COLOR.

CLASS 16—PAPER GOODS AND PRINTED MATTER

FOR PRINTED PUBLICATIONS, NAMELY, CATALOGS, STUDENT HANDBOOKS, BROCHURES, NEWS AND EVENTS ARTICLES, AND WRITTEN MATERIALS REGARDING EDUCATIONAL PROGRAMS, DEGREES, COURSES, CURRICULUMS, FACULTY AND STAFF, SCHOOL EVENTS AND NEWS, ADMISSIONS, FINANCIAL ASSISTANCE, AND CAMPUS INFORMATION (U.S. CLS. 2, 5, 22, 23, 29, 37, 38 AND 50).

FIRST USE 6-1-2006; IN COMMERCE 8-1-2006.

CLASS 36—INSURANCE AND FINANCIAL

FOR COMPUTER SERVICES, NAMELY, PROVIDING DATA BASES FEATURING FINANCIAL AID INFORMATION IN THE NATURE OF ASSISTING STUDENTS IN APPLYING FOR FINANCIAL AID (U.S. CLS. 100, 101 AND 102).

FIRST USE 6-1-2006; IN COMMERCE 8-1-2006.

CLASS 41—EDUCATION AND ENTERTAINMENT

FOR EDUCATIONAL SERVICES, NAMELY, PROVIDING COURSES OF INSTRUCTION AT THE UNIVERSITY LEVEL, INCLUDING THOSE IN THE FIELDS OF EDUCATION AND HUMAN SERVICES IN THE NATURE OF COURSES OF STUDY, CERTIFICATION AND ADVANCED DEGREE PROGRAMS, AND DISSEMINATION OF COURSE MATERIALS IN CONNECTION THEREWITH; EDUCATIONAL RESEARCH AND DEVELOPMENT, AND DISSEMINATION OF EDUCATIONAL MATERIALS THEREWITH IN THE FIELD OF EDUCATIONAL SYSTEMS AND TECHNIQUES, PROFESSIONAL GROWTH AND DEVELOPMENT; DESIGNING, ORGANIZING AND CONDUCTING PROFESSIONAL AND EDUCATIONAL WORKSHOPS AND SEMINARS IN THE FIELD OF EDUCATION; PROVIDING INFORMATION ABOUT EDUCATION VIA AN ON-LINE GLOBAL NETWORK; COMPUTER SERVICES, NAMELY, PROVIDING DATABASES FEATURING NEWS AND INFORMATION ABOUT EDUCATION; COMPUTER SERVICES, NAMELY PROVIDING DATABASES FEATURING CURRENT EVENT NEWS ABOUT EDUCATION FEATURING SOCIAL, ACADEMIC, AND ATHLETIC EVENTS AND CALENDARS THEREFORE, DEGREE PROGRAMS INFORMATION, ADMISSIONS INFORMATION, AND FACULTY AND STAFF BIOGRAPHIES (U.S. CLS. 100, 101 AND 107).

FIRST USE 6-1-2006; IN COMMERCE 8-1-2006.
FRED CARL, EXAMINING ATTORNEY

SN 77-441,763. THE INTECH GROUP, INC., EXTON, PA.
FILED 4-7-2008.

THE MARK CONSISTS OF A STYLIZED VERSION OF THE WORD INTECH.

CLASS 35—ADVERTISING AND BUSINESS

FOR OPERATION AND ADMINISTRATION OF TELECOMMUNICATION SYSTEMS AND NETWORKS FOR OTHERS (U.S. CLS. 100, 101 AND 102).
FIRST USE 0-0-1987; IN COMMERCE 0-0-1987.

CLASS 38—COMMUNICATION

FOR TELECOMMUNICATION CONSULTATION IN THE NATURE OF TECHNICAL CONSULTING IN THE FIELD OF VOICE, DATA, GRAPHICS, SOUND AND VIDEO TRANSMISSIONS AND COMMUNICATIONS; TELEPHONE COMMUNICATION SERVICES (U.S. CLS. 100, 101 AND 104).
FIRST USE 2-14-2008; IN COMMERCE 2-14-2008.

CLASS 42—SCIENTIFIC AND COMPUTER SERVICES

FOR PLANNING, DEVELOPMENT AND TECHICAL SUPPORT OF COMMUNICATION SYSTEMS FOR OTHERS; COMPUTER SERVICES, NAMELY, INSTALLATION, MAINTENANCE AND REPAIR OF COMPUTER SOFTWARE FOR USE IN COMMUNICATION SYSTEMS; TROUBLESHOOTING OF COMMUNICATIONS SYSTEMS COMPUTER HARDWARE PROBLEMS (U.S. CLS. 100 AND 101).
FIRST USE 2-14-2008; IN COMMERCE 2-14-2008.
JOHN GARTNER, EXAMINING ATTORNEY

SN 77-442,922. MEDICALERT FOUNDATION UNITED STATES, INC., TURLOCK, CA. FILED 4-8-2008.

MEDICALERT SAFELY EVER
AFTER

THE MARK CONSISTS OF STANDARD CHARACTERS WITHOUT CLAIM TO ANY PARTICULAR FONT, STYLE, SIZE, OR COLOR.
OWNER OF U.S. REG. NOS. 1,288,903, 3,334,545 AND OTHERS.

CLASS 9—ELECTRICAL AND SCIENTIFIC APPARATUS

FOR ELECTRONIC STORAGE DEVICES, NAMELY, FLASH DRIVES FOR THE COLLECTION, STORAGE, MANAGEMENT, RETRIEVAL, MONITORING AND COMMUNICATION OF PERSONAL AND/OR MEDICAL INFORMATION; SOFTWARE FOR THE COLLECTION, STORAGE, MANAGEMENT, RETRIEVAL, MONITORING AND COMMUNICATION OF PERSONAL AND/OR MEDICAL INFORMATION (U.S. CLS. 21, 23, 26, 36 AND 38).

CLASS 14—JEWELRY

FOR JEWELRY CONTAINING EMBLEMS WITH PERSONAL AND/OR MEDICAL INFORMATION THEREON (U.S. CLS. 2, 27, 28 AND 50).

CLASS 16—PAPER GOODS AND PRINTED MATTER

FOR PRINTED MATERIALS, NAMELY, PAMPHLETS, BROCHURES, BOOKLETS, POSTERS, AND MANUALS IN THE FIELDS OF HEALTH, PERSONAL SAFETY, AND HEALTH AND EMERGENCY RESPONSE PROCEDURES; MEMBERSHIP IDENTIFICATION CARDS, NOT MAGNETICALLY ENCODED, PROVIDING PERSONAL AND/OR MEDICAL INFORMATION THEREON (U.S. CLS. 2, 5, 22, 23, 29, 37, 38 AND 50).

CLASS 35—ADVERTISING AND BUSINESS

FOR DATA PROCESSING SERVICES, NAMELY, THE COLLECTION OF PERSONAL AND/OR MEDICAL INFORMATION IN A COMPUTER DATABASE; DATA AND INFORMATION MANAGEMENT, NAMELY, MANAGEMENT OF COMPUTERIZED FILES CONTAINING PERSONAL AND/OR MEDICAL INFORMATION (U.S. CLS. 100, 101 AND 102).

CLASS 38—COMMUNICATION

FOR COMMUNICATION, NAMELY, ELECTRONIC TRANSMISSION OF PERSONAL AND/OR MEDICAL INFORMATION (U.S. CLS. 100, 101 AND 104).

CLASS 39—TRANSPORTATION AND STORAGE

FOR ELECTRONIC STORAGE OF PERSONAL AND/OR MEDICAL INFORMATION (U.S. CLS. 100 AND 105).

CLASS 44—MEDICAL, BEAUTY AND AGRICULTURAL SERVICES

FOR PROVIDING MEDICAL INFORMATION TO EMERGENCY RESPONDERS, MEDICAL PERSONNEL, MEMBERS, AND DESIGNEES OF MEMBERS VIA A 24-HOUR MONITORING SERVICE; PROVIDING MEDICAL INFORMATION TO ALLOW MEMBERS TO UPDATE THEIR MEDICAL AND PERSONAL FILES (U.S. CLS. 100 AND 101).
MATTHEW EINSTEIN, EXAMINING ATTORNEY

SN 77-445,513. PLANET BINGO, INC., RANCHO MIRAGE, CA. FILED 4-10-2008.

PLANET BINGO

THE MARK CONSISTS OF STANDARD CHARACTERS WITHOUT CLAIM TO ANY PARTICULAR FONT, STYLE, SIZE, OR COLOR.

NO CLAIM IS MADE TO THE EXCLUSIVE RIGHT TO USE "BINGO", APART FROM THE MARK AS SHOWN.

CLASS 9—ELECTRICAL AND SCIENTIFIC APPARATUS

FOR COMPUTER GAME PROGRAMS; COMPUTER GAME SOFTWARE; COMPUTER HARDWARE; COMPUTER HARDWARE AND COMPUTER SOFTWARE PROGRAMS FOR THE INTEGRATION OF TEXT, AUDIO, GRAPHICS, STILL IMAGES AND MOVING PICTURES INTO AN INTERACTIVE DELIVERY FOR MULTIMEDIA APPLICATIONS; COMPUTER OPERATING SYSTEMS; COMPUTER HARDWARE AND SOFTWARE FOR OPERATING BINGO SLOT MACHINES, GAMING MACHINES, LEGAL GAMBLING DEVICES, BINGO ELECTRONICS, CASINO SLOT MACHINES, BINGO HALL AND CLUB SERVERS AND ELECTRONIC BINGO GAMES (U.S. CLS. 21, 23, 26, 36 AND 38).

FIRST USE 11-30-2005; IN COMMERCE 11-30-2005.

CLASS 35—ADVERTISING AND BUSINESS

FOR ADVERTISING AND MARKETING; ADVERTISING, MARKETING AND PROMOTION SERVICES; MARKETING CONSULTATION IN THE FIELD OF BINGO, CASINO AND LEGAL GAMBLING, HALL DESIGNS, GIVEAWAYS, SESSION PLANNING, FLOOR PLAN DESIGN PLAYER REWARDS, CASINO AND BINGO GAMES AND PROMOTIONS AND B2B SALES, LEGAL GAMBLING PROMOTIONS AND LEGAL ONLINE GAMING AND GAMBLING PROMOTIONS AND MARKETING; MARKETING CONSULTING; PROVIDING ADVERTISING, MARKETING AND PROMOTIONAL SERVICES, NAMELY, DEVELOPMENT OF ADVERTISING CAMPAIGNS FOR BINGO GAMING, LEGAL GAMBLING, ONLINE BINGO, GAMING AND LEGAL GAMBLING, PLAYER REWARDS CLUBS, PLAYER POINTS, DAUBERS, BINGO CHARMS, AND GAMBLING AND GAMING CHARMS; REAL ESTATE MARKETING SERVICES IN THE FIELD OF COMMERCIAL OFFICE BUILDINGS (U.S. CLS. 100, 101 AND 102).

FIRST USE 11-30-2005; IN COMMERCE 11-30-2005.
WILLIAM VERHOSEK, EXAMINING ATTORNEY

SN 77-446,938. YING LI-OSHRIN, NEW YORK, NY. FILED 4-13-2008.

Ying Li © New York Studio

NO CLAIM IS MADE TO THE EXCLUSIVE RIGHT TO USE "NEW YORK STUDIO", APART FROM THE MARK AS SHOWN.

THE MARK CONSISTS OF STYLIZED WORDS AND SYMBOLS "YING LI @ NEW YORK STUDIO".

CLASS 18—LEATHER GOODS

FOR HANDBAGS (U.S. CLS. 1, 2, 3, 22 AND 41).

CLASS 25—CLOTHING

FOR CLOTHING AND CLOTHING ACCESSORIES, NAMELY, WOMEN'S BLOUSES, TOPS, PANTS, DRESSES, SKIRTS, JACKETS, SWEATERS, SCARVES, SHIRTS, TANK TOPS AND HALTER TOPS; AND MEN'S TIES (U.S. CLS. 22 AND 39).

ALEXANDER L. POWERS, EXAMINING ATTORNEY

SN 77-447,559. WEST POINT THOROUGHBREDS, INC., MT. LAUREL, NJ. FILED 4-14-2008.

THE GOLD STANDARD IN RACING PARTNERSHIPS

THE MARK CONSISTS OF STANDARD CHARACTERS WITHOUT CLAIM TO ANY PARTICULAR FONT, STYLE, SIZE, OR COLOR.

CLASS 36—INSURANCE AND FINANCIAL

FOR FORMATION, ADMINISTRATION OF OFFERING AND MANAGEMENT OF HORSE RACING PARTNERSHIPS FOR OTHERS (U.S. CLS. 100, 101 AND 102).

FIRST USE 1-1-2007; IN COMMERCE 1-1-2007.

CLASS 41—EDUCATION AND ENTERTAINMENT

FOR ENTERTAINMENT SERVICES IN THE NATURE OF THOROUGHBRED HORSE RACING (U.S. CLS. 100, 101 AND 107).

FIRST USE 1-1-2007; IN COMMERCE 1-1-2007.

KATHERINE CHANG, EXAMINING ATTORNEY

SN 77-448,710. KAPITAL DEVELOPMENT, LLC, MIAMI, FL. FILED 4-15-2008.



NO CLAIM IS MADE TO THE EXCLUSIVE RIGHT TO USE "CITY", APART FROM THE MARK AS SHOWN. THE COLOR(S) LIGHT GREEN AND GREY IS/ARE CLAIMED AS A FEATURE OF THE MARK.

THE MARK CONSISTS OF THE COLOR GREY FOUND IN THE WORDING "CITY CLUB" AND THE STYLIZED FOUNTAIN IN LIGHT GREEN.

CLASS 35—ADVERTISING AND BUSINESS

FOR (BASED ON INTENT TO USE) REAL ESTATE MARKETING SERVICES IN THE FIELD OF CONDOMINIUMS, APARTMENTS, AND SENIOR LIVING (U.S. CLS. 100, 101 AND 102).

CLASS 36—INSURANCE AND FINANCIAL

FOR RENTAL OF APARTMENTS; RENTAL OF APARTMENTS IN AN APARTMENT COMMUNITY; REAL ESTATE SERVICES, NAMELY, RENTAL OF VACATION HOMES AND CONDOMINIUMS USING PAY PER CLICK ADVERTISING ON A GLOBAL COMPUTER NETWORK AND APARTMENT HOUSE MANAGEMENT (U.S. CLS. 100, 101 AND 102).

FIRST USE 3-27-2008; IN COMMERCE 3-27-2008.
WON TEAK OH, EXAMINING ATTORNEY

CLASS 26—FANCY GOODS

FOR FABRIC FRINGE; FABRIC TRIM IN THE NATURE OF BEADED FRINGE; DECORATIVE TRIM IN THE NATURE OF RIBBON FRINGE; FABRIC APPLIQUÉS; DECORATIVE FABRIC EMBELLISHMENTS, NAMELY, APPLIQUÉS; DECORATIVE EMBELLISHMENTS, NAMELY, FABRIC APPLIQUÉS; IRON-ON DECORATIVE PRESS STUDS (U.S. CLS. 37, 39, 40, 42 AND 50).

JASON LOTT, EXAMINING ATTORNEY

SN 77-449,323. HORIZON GROUP USA, INC., WARREN, NJ.
FILED 4-16-2008.

SN 77-452,426. 314321 ONTARIO LIMITED, DBA BULL INDUSTRIAL SUPPLY, SUDBURY, CANADA, FILED 4-18-2008.

NEXT STYLE

THE MARK CONSISTS OF STANDARD CHARACTERS WITHOUT CLAIM TO ANY PARTICULAR FONT, STYLE, SIZE, OR COLOR.

CLASS 14—JEWELRY

FOR COSTUME JEWELRY, NAMELY, IRON-ON RHINESTONES AND IRON-ON RHINESTONE TRANSFERS; SHIRT STUDS BEING DECORATIVE EMBELLISHMENTS; DECORATIVE COSTUME JEWELRY EMBELLISHMENTS, NAMELY, ACRYLIC JEWELS AND STONES; IRON-ON DECORATIVE SHIRT STUDS (U.S. CLS. 2, 27, 28 AND 50).

CLASS 16—PAPER GOODS AND PRINTED MATTER

FOR IRON-ON TRANSFERS; APPLIQUÉS IN THE FORM OF DECALS; TEMPORARY TATTOOS; IRON-ON SEQUIN TRANSFERS; IRON-ON GLITTER TRANSFERS; IRON-ON MESH TRANSFERS; IRON-ON TRANSFERS IN THE FORM OF DECALS; ACTIVITY KIT FOR DECORATING CLOTHING COMPRISED OF IRON-ON TRANSFERS; ACTIVITY KIT FOR DECORATING SKIN COMPRISED OF TEMPORARY TATTOOS, MARKERS, STENCILS, ADHESIVE BACKED ACRYLIC DECORATIVE JEWELS AND GEMSTONES, AND GLITTER; ACTIVITY KIT FOR DECORATING FABRIC COMPRISED OF IRON-ON APPLIQUÉS IN THE NATURE OF DECALS, GLUE, ACRYLIC DECORATIVE GEMSTONES AND STUDS, SEQUIN PAILLETES, AND PAINT (U.S. CLS. 2, 5, 22, 23, 29, 37, 38 AND 50).

CLASS 18—LEATHER GOODS

FOR TOTE BAGS; HANDBAGS; BACKPACKS; WRISTLET BAGS; WALLETS; COIN PURSES; ACTIVITY KIT FOR DECORATING A COSMETIC BAG SOLD EMPTY, SLEEP EYE MASK AND COSMETIC MIRROR COVER, COMPRISED OF COSMETIC BAG SOLD EMPTY, SLEEP EYE MASK, COSMETIC MIRROR WITH COVER, IRON-ON TRANSFERS AND RHINESTONES, GLUE AND ACRYLIC DECORATIVE GEMSTONES (U.S. CLS. 1, 2, 3, 22 AND 41).

CLASS 25—CLOTHING

FOR APRONS; ACTIVITY KIT FOR DECORATING FASHION ACCESSORIES COMPRISED OF A HEADBAND, BELT, BRACELET, NECKLACE, RIBBON, TAPE, GLUE, ACRYLIC DECORATIVE GEMSTONES AND BEADS; ACTIVITY KIT FOR DECORATING FASHION ACCESSORIES COMPRISED OF HAT, WALLET, IRON-ON APPLIQUÉS, TRANSFERS AND STUDS (U.S. CLS. 22 AND 39).

BULL POWERTRAIN

THE MARK CONSISTS OF STANDARD CHARACTERS WITHOUT CLAIM TO ANY PARTICULAR FONT, STYLE, SIZE, OR COLOR.

PRIORITY CLAIMED UNDER SEC. 44(D) ON CANADA APPLICATION NO. 1374449, FILED 12-3-2007, REG. NO. TMA730351, DATED 12-8-2008, EXPIRES 12-8-2023.

NO CLAIM IS MADE TO THE EXCLUSIVE RIGHT TO USE "POWERTRAIN", APART FROM THE MARK AS SHOWN.

CLASS 7—MACHINERY

FOR TRANSMISSION, TORQUE CONVERTERS, AXLES AND DIFFERENTIALS FOR MACHINES AND REPLACEMENT PARTS THEREOF FOR USE IN THE MINING, LOGGING AND CONSTRUCTION INDUSTRIES (U.S. CLS. 13, 19, 21, 23, 31, 34 AND 35).

CLASS 12—VEHICLES

FOR TRANSMISSION, TORQUE CONVERTERS, AXLES AND DIFFERENTIALS FOR LAND VEHICLES AND REPLACEMENT PARTS THEREOF FOR USE IN THE MINING, LOGGING AND CONSTRUCTION INDUSTRIES (U.S. CLS. 19, 21, 23, 31, 35 AND 44).

CLASS 37—CONSTRUCTION AND REPAIR

FOR MAINTENANCE AND REPAIR OF POWERTRAIN COMPONENTS AND RELATED PARTS FOR HEAVY VEHICLES, ALL FOR USE IN THE MINING, LOGGING AND CONSTRUCTION INDUSTRIES (U.S. CLS. 100, 103 AND 106).

BARBARA BROWN, EXAMINING ATTORNEY

SN 77-453,335. SEVEN W'S, LLC, SCARBOROUGH, NY.
FILED 4-21-2008.

SIOLONIM

THE MARK CONSISTS OF STANDARD CHARACTERS WITHOUT CLAIM TO ANY PARTICULAR FONT, STYLE, SIZE, OR COLOR.

CLASS 25—CLOTHING

FOR WOMEN'S APPAREL, NAMELY, SHIRTS AND SKIRTS (U.S. CLS. 22 AND 39).

CLASS 35—ADVERTISING AND BUSINESS

FOR RETAIL STORE SERVICES FEATURING WOMEN'S APPAREL (U.S. CLS. 100, 101 AND 102).
RENEE MCCRAY, EXAMINING ATTORNEY

CLASS 42—SCIENTIFIC AND COMPUTER SERVICES

FOR ACCREDITATION SERVICES, NAMELY, DEVELOPING, EVALUATING, AND TESTING STANDARDS FOR POWER ENGINEERS AND POWER ENGINEERING FOR THE PURPOSE OF ACCREDITATION (U.S. CLS. 100 AND 101).

FIRST USE 1-1-2003; IN COMMERCE 1-1-2003.
PRISCILLA MILTON, EXAMINING ATTORNEY

SN 77-454,625. AMERICAN SOCIETY OF POWER ENGINEERS, INC., AURORA, IN. FILED 4-22-2008.

SN 77-455,331. HAYES, TRUDIE, EAST HARTLAND, CT. FILED 4-22-2008.

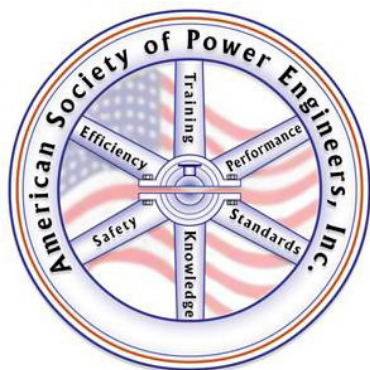

Love Your Me

THE MARK CONSISTS OF STANDARD CHARACTERS WITHOUT CLAIM TO ANY PARTICULAR FONT, STYLE, SIZE, OR COLOR.

NO CLAIM IS MADE TO THE EXCLUSIVE RIGHT TO USE "AMERICAN SOCIETY OF POWER ENGINEERS, INC." AND "SAFETY", "EFFICIENCY", "TRAINING", "PERFORMANCE", "STANDARDS" AND "KNOWLEDGE", APART FROM THE MARK AS SHOWN.

THE COLOR(S) BLACK, RED, WHITE AND BLUE IS/ARE CLAIMED AS A FEATURE OF THE MARK.

THE MARK CONSISTS OF SPOKED WHEEL IN WHITE, BOLTED IN THE MIDDLE WITH TWO OUTER BOLTS AND ONE CENTER BOLT, RED AND BLUE LINES TRIMMING THE INNER CIRCUMFERENCE OF THE WHEEL, "AMERICAN SOCIETY OF POWER ENGINEERS, INC." IN BLACK LETTERING AROUND INTERIOR OF WHEEL, THE WORDS "EFFICIENCY", "TRAINING", "PERFORMANCE", "STANDARDS", "KNOWLEDGE" AND "SAFETY" IN BLACK LETTERING IN THE SPOKES OF THE WHEEL, AND A STYLIZED REPRESENTATION OF THE AMERICAN FLAG IN RED WHITE AND BLUE WAVING IN BACKGROUND OF SPOKES.

CLASS 35—ADVERTISING AND BUSINESS

FOR ASSOCIATION SERVICES, NAMELY, PROMOTING THE INTERESTS OF POWER ENGINEERS (U.S. CLS. 100, 101 AND 102).

FIRST USE 1-1-2003; IN COMMERCE 1-1-2003.

CLASS 41—EDUCATION AND ENTERTAINMENT

FOR EDUCATION SERVICES, NAMELY, PROVIDING MENTORING, TUTORING, CLASSES, SEMINARS AND WORKSHOPS IN THE FIELD OF POWER ENGINEERING AND RELATED TOPICS (U.S. CLS. 100, 101 AND 107).

FIRST USE 1-1-2003; IN COMMERCE 1-1-2003.

CLASS 16—PAPER GOODS AND PRINTED MATTER

FOR PAPER AND PAPER GOODS, NAMELY, STATIONERY; PRINTED MATERIAL, NAMELY, STICKERS, POSTERS, AND PAPER LABELS (U.S. CLS. 2, 5, 22, 23, 29, 37, 38 AND 50).

CLASS 25—CLOTHING

FOR CHILDREN AND ADOLESCENT CLOTHING, NAMELY, T-SHIRTS AND SHORTS, SWEAT SHIRTS, SWEAT PANTS, SHIRTS, PANTS, UNDERWEAR, OUTERWEAR, NAMELY, JACKETS AND COATS; FOOTWEAR, NAMELY, CHILDREN AND ADOLESCENT SNEAKERS, SHOES AND BOOTS; CHILDREN AND ADOLESCENT HEADGEAR, NAMELY, HATS AND CAPS (U.S. CLS. 22 AND 39).

CLASS 28—TOYS AND SPORTING GOODS

FOR GAMES AND PLAYTHINGS, NAMELY, TOYS FOR CHILDREN AND ADOLESCENTS, NAMELY, DOLLS, STUFFED TOY ANIMALS, KITS FOR BUILDING PLAYHOUSES; TOY CONSTRUCTION SETS, PUZZLES, BOARD GAMES, CARD GAMES (U.S. CLS. 22, 23, 38 AND 50).

CLASS 41—EDUCATION AND ENTERTAINMENT

FOR EDUCATION AND ENTERTAINMENT SERVICES, NAMELY, CONDUCTING SEMINARS IN THE FIELD OF SELF AWARENESS AND SELF WORTH (U.S. CLS. 100, 101 AND 107).

EVELYN BRADLEY, EXAMINING ATTORNEY

SN 77-455,401, SONY CORPORATION, TOKYO, JAPAN, FILED 4-23-2008.

SOCRATTO

THE MARK CONSISTS OF STANDARD CHARACTERS WITHOUT CLAIM TO ANY PARTICULAR FONT, STYLE, SIZE, OR COLOR.

CLASS 9—ELECTRICAL AND SCIENTIFIC APPARATUS

FOR ELECTRONIC MACHINES, APPARATUS AND PARTS, NAMELY, COMPUTER SOFTWARE USED FOR BROWSING DATA STORED IN A COMPUTER; DOWNLOADABLE ELECTRONIC PUBLICATIONS, NAMELY, TELEVISION PROGRAM SCHEDULES AND INFORMATION CONCERNING THE CONTENT OF TELEVISION PROGRAMS (U.S. CLS. 21, 23, 26, 36 AND 38).

CLASS 35—ADVERTISING AND BUSINESS

FOR ADVERTISING AND PUBLICITY; ELECTRONIC COMMUNICATION SERVICES, NAMELY, PROVIDING INFORMATION ABOUT PRODUCTS VIA ELECTRONIC NETWORKS FOR ADVERTISING AND SALES PURPOSES (U.S. CLS. 100, 101 AND 102).

CLASS 38—COMMUNICATION

FOR TELEVISION BROADCASTING (U.S. CLS. 100, 101 AND 104).

CLASS 41—EDUCATION AND ENTERTAINMENT

FOR PUBLISHING OF ELECTRONIC PUBLICATIONS (U.S. CLS. 100, 101 AND 107).

CLASS 42—SCIENTIFIC AND COMPUTER SERVICES

FOR PROVIDING TEMPORARY USE OF ONLINE NON-DOWNLOADABLE SOFTWARE FOR USE IN ALLOWING INDIVIDUALS TO CREATE ADVERTISEMENTS (U.S. CLS. 100 AND 101).
DORITT L. CARROLL, EXAMINING ATTORNEY

SN 77-456,917, GEORGE J. GOSIESKI, JR., MIDLOTHIAN, VA. FILED 4-24-2008.

PEOPLE + PLACE + PLANET + PERFORMANCE = SUSTAINABLE GROWTH

THE MARK CONSISTS OF STANDARD CHARACTERS WITHOUT CLAIM TO ANY PARTICULAR FONT, STYLE, SIZE, OR COLOR.

CLASS 35—ADVERTISING AND BUSINESS

FOR BUSINESS MANAGEMENT CONSULTANCY AS WELL AS DEVELOPMENT OF PROCESSES FOR THE ANALYSIS AND THE IMPLEMENTATION OF STRATEGY PLANS AND MANAGEMENT PROJECTS; BUSINESS PROCESS ENGINEERING, RE-ENGINEERING AND OPTIMIZATION SERVICES; BUSINESS CONSULTING SERVICES IN THE FIELDS OF ORGANIZATIONAL CHANGE MANAGEMENT AND COMMERCIAL REAL ESTATE PORTFOLIO OPTIMIZATION; BUSINESS CONSULTING SERVICES IN THE FIELD OF ENVIRONMENTAL MANAGEMENT OF COMMERCIAL FACILITIES (U.S. CLS. 100, 101 AND 102).

CLASS 42—SCIENTIFIC AND COMPUTER SERVICES

FOR CONSULTING SERVICES IN THE FIELD OF ENVIRONMENTAL ASSESSMENT, COMPLIANCE, COST OF ENVIRONMENTAL TESTING AND PROTECTION, SUSTAINABILITY AND PLANNING; DESIGN OF SPECIALTY INTERIOR AND EXTERIOR ENVIRONMENT SETTINGS TO OPTIMIZE USE OF SPACE; ANALYSIS AND CONSULTATION PERTAINING TO THE FLEXIBLE USE OF SPACE AND TECHNOLOGY IN THE WORKPLACE (U.S. CLS. 100 AND 101).
DAVID MILLER, EXAMINING ATTORNEY

SN 77-458,303, GRINDSTONEMANAGEMENT, LLC, FORMERLY "ADA BLANCHE W. SCHREINER FAMILY LLC", GIG HARBOR, WA. FILED 4-25-2008.

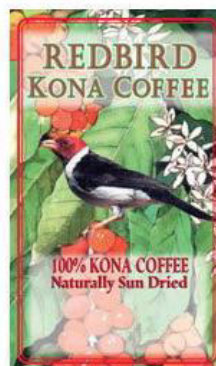

NO CLAIM IS MADE TO THE EXCLUSIVE RIGHT TO USE "KONA COFFEE" OR "100% KONA COFFEE NATURALLY SUN DRIED", APART FROM THE MARK AS SHOWN.

THE COLOR(S) RED, GREEN ORANGE, BLACK, WHITE, AND GRAY IS/ARE CLAIMED AS A FEATURE OF THE MARK.

THE MARK CONSISTS OF A RECTANGULAR SHAPED BACKGROUND OF VEGETATION CONSISTING OF GREEN COFFEE TREE LEAVES, RED COFFEE CHERRY FRUITS ON THE TREE, AND WHITE COFFEE CHERRY BLOSSOM FLOWERS, WITH RED AND BLACK DETAILING, ON THE TREE. THERE ARE TWO RED RECTANGULAR LINES JUST INSIDE THE OUTER EDGES OF THE MARK, ACTING AS AN OUTLINE OF THE INNER PORTIONS; THE INNER LINE IS THINNER THAN THE OUTER ONE. CENTERED ON THE LABEL PERCHED ON THE TREE ON A COFFEE CHERRY IS A BIRD, SHOWING ITS LEFT SIDE PROFILE, WITH A WHITE BEAK, RED HEAD, BLACK EYE, WHITE AND GRAY NECK AND BELLY, AND BLACK WINGS. ABOVE THE BIRD IS WORDING "REDBIRD KONA COFFEE", WITH "REDBIRD" APPEARING ABOVE "KONA COFFEE". ALL IN RED LETTERS WITH EACH LETTER BORDERED IN GREEN AND THEN IN WHITE. BELOW THE BIRD IS THE RED WORDING "100%

KONA COFFEE", AND JUST BELOW THAT PHRASE, THE RED WORDING "NATURALLY SUN DRIED". A RECTANGULAR SHAPED AREA ABOVE THE BIRD AND SURROUNDING THE WORDING "REDBIRD KONA COFFEE" HAS AN APPEARANCE OF A MISTY WHITE OVER THE BACKGROUND AND OTHER COLORS. A RECTANGULAR SHAPED AREA BELOW THE BIRD INCLUDING THE AREA AROUND THE WORDING "100% KONA COFFEE NATURALLY SUN DRIED" HAS THE SAME TYPE OF APPEARANCE.

SN 77-459,950. CANDLE LAMP COMPANY, LLC, RIVERSIDE, CA. FILED 4-28-2008.

CLASS 30—STAPLE FOODS

FOR COFFEE; COFFEE BEANS (U.S. CL. 46).
FIRST USE 4-3-2007; IN COMMERCE 4-3-2007.

CLASS 31—NATURAL AGRICULTURAL PRODUCTS

FOR UNPROCESSED COFFEE; UNROASTED COFFEE (U.S. CLS. 1 AND 46).
FIRST USE 4-3-2007; IN COMMERCE 4-3-2007.
LYDIA BELZER, EXAMINING ATTORNEY



THE MARK CONSISTS OF A FLAME ENCLOSED IN A SPHERE, WITH PART OF THE FLAME CASTING A SHADOW IN THE SPHERE.

SN 77-459,652. MTB5, LLC, AUSTIN, TX. FILED 4-28-2008.

CLASS 4—LUBRICANTS AND FUELS

FOR TABLE LIGHTING PRODUCTS, NAMELY, CANDLES; LIGHTING FUEL; WAX CARTRIDGES FOR USE AS FUEL IN LIGHTING FIXTURES; BUFFET EQUIPMENT AND ACCESSORIES, NAMELY, LIQUID OR GEL FUEL FOR WARMING TRAYS OR CHAFING DISHES (U.S. CLS. 1, 6 AND 15).

CLASS 11—ENVIRONMENTAL CONTROL APPARATUS

FOR TABLE LIGHTING FIXTURES IN THE NATURE OF LAMPS INCORPORATING CANDLES; TABLE LIGHTING FIXTURES, NAMELY, LAMP BASES, LAMP GLOBES, LAMP SHADES; BUFFET EQUIPMENT, NAMELY, WARMING TRAYS AND CHAFING DISHES (U.S. CLS. 13, 21, 23, 31 AND 34).
AMOS T. MATTHEWS, JR., EXAMINING ATTORNEY

mastering the big 5

THE MARK CONSISTS OF STANDARD CHARACTERS WITHOUT CLAIM TO ANY PARTICULAR FONT, STYLE, SIZE, OR COLOR.

SN 77-460,260. ADVANCED HEALTHCARE DISTRIBUTORS, LLC, WOONSOCKET, RI. FILED 4-29-2008.

CLASS 16—PAPER GOODS AND PRINTED MATTER

FOR PUBLICATIONS, NAMELY, BOOKS, MANUALS, AND GUIDES IN THE FIELD OF LEADERSHIP DEVELOPMENT IN THE WORKPLACE, SPECIALIZING IN THE CALL CENTER INDUSTRY (U.S. CLS. 2, 5, 22, 23, 29, 37, 38 AND 50).
FIRST USE 7-1-2007; IN COMMERCE 7-1-2007.

VICKERY & CLARKE NATURAL APOTHECARY

CLASS 41—EDUCATION AND ENTERTAINMENT

FOR EDUCATIONAL SERVICES, NAMELY, PROVIDING SEMINARS, CLASSES AND WORKSHOPS FOR LICENSED OWNERSHIP IN THE FIELD OF LEADERSHIP DEVELOPMENT IN THE WORKPLACE, SPECIALIZING IN THE CALL CENTER INDUSTRY (U.S. CLS. 100, 101 AND 107).
FIRST USE 7-1-2007; IN COMMERCE 7-1-2007.
SANJEEV VOHRA, EXAMINING ATTORNEY

THE MARK CONSISTS OF STANDARD CHARACTERS WITHOUT CLAIM TO ANY PARTICULAR FONT, STYLE, SIZE, OR COLOR.
NO CLAIM IS MADE TO THE EXCLUSIVE RIGHT TO USE "NATURAL APOTHECARY", APART FROM THE MARK AS SHOWN.

CLASS 3—COSMETICS AND CLEANING PREPARATIONS

FOR NON-MEDICATED COSMETICS AND SKIN CARE PRODUCTS, NAMELY, BATH MILK, BODY WASH, BODY SCRUB, BODY LOTION, HAND CREAM, EYE CREAM, DETOXIFYING FACIAL MASK, FACIAL SCRUB, FACIAL CLEANSER, FACIAL MOISTURIZER; ANTI-AGING OIL AND WAX BASED ANHYDROUS LIP TREATMENT; NON-MEDICATED BODY SOAK; BEAUTY SERUM, NAMELY, VITAMIN SERUM; NON-MEDICATED SKIN CARE PRODUCT, NAMELY, LIP TREATMENT CREAM AND LOTION; DETOXIFYING BATH SOAK IN SALT FORM; THERAPEUTIC BATH SOAK IN POWDER FORM; THERAPEUTIC BATH MILK IN LIQUID FORM; NON-MEDICATED COOLING SPRAY FOR FOOT AND LEG; NON-MEDICATED COOLING FOOT CREAM; AROMATICS OTHER THAN FOR MEDICAL PURPOSES; PULSE POINT BALM IN THE NATURE OF AROMATHERAPY LOTION; PILLOW MIST, NAMELY, AROMATHERAPY SPRAY (U.S. CLS. 1, 4, 6, 50, 51 AND 52).

CLASS 21—HOUSEWARES AND GLASS

FOR BATH PRODUCTS, NAMELY, NATURAL MESH BODY SPONGES (U.S. CLS. 2, 13, 23, 29, 30, 33, 40 AND 50).
NICHOLAS COLEMAN, EXAMINING ATTORNEY

CLASS 36—INSURANCE AND FINANCIAL

FOR INSURANCE UNDERWRITING IN THE FIELDS OF WORKER'S COMPENSATION, OCCUPATIONAL HEALTH, MENTAL HEALTH AND LIFE; UNDERWRITING INSURANCE FOR PRE-PAID DENTAL AND HEALTH CARE PROVIDED VIA HEALTH MAINTENANCE ORGANIZATIONS AND PREFERRED PROVIDER ORGANIZATIONS; PROVIDING HEALTH INSURANCE INFORMATION TO INSURANCE AGENTS AND INSURANCE BROKERS VIA THE INTERNET; INSURANCE BROKERAGE IN THE FIELDS OF HEALTH CARE AND WORKER'S COMPENSATION; ORGANIZATION AND ADMINISTRATION OF PRE-PAID HEALTH CARE PLANS; ORGANIZING PREFERRED PROVIDER PLANS IN THE FIELDS OF MENTAL HEALTH AND BEHAVIORAL HEALTH; ORGANIZING PREFERRED PROVIDER PLANS IN THE FIELD OF DENTAL HEALTH CARE (U.S. CLS. 100, 101 AND 102).

FIRST USE 0-0-1993; IN COMMERCE 0-0-1993.

CLASS 44—MEDICAL, BEAUTY AND AGRICULTURAL SERVICES

FOR PREVENTATIVE HEALTH CARE SERVICES; PROVIDING MEDICAL WELLNESS INFORMATION; MANAGED HEALTHCARE SERVICES (U.S. CLS. 100 AND 101).

FIRST USE 0-0-1993; IN COMMERCE 0-0-1993.
JIM RINGLE, EXAMINING ATTORNEY

SN 77-460,736. WELLPOINT, INC., INDIANAPOLIS, IN. FILED 4-29-2008.

SN 77-462,265. WAL-MART STORES, INC., BENTONVILLE, AR. FILED 4-30-2008.



EVERYDAY BETTER

THE MARK CONSISTS OF STANDARD CHARACTERS WITHOUT CLAIM TO ANY PARTICULAR FONT, STYLE, SIZE, OR COLOR.

OWNER OF U.S. REG. NOS. 2,147,247, 2,665,505 AND 2,927,116.

THE MARK CONSISTS OF THE WORD "WELLPOINT" WITH THREE WAVY LINES OVER THE WORD.

CLASS 35—ADVERTISING AND BUSINESS

FOR ADMINISTERING PHARMACY REIMBURSEMENT PROGRAMS AND SERVICES; COMPUTERIZED ONLINE ORDERING SERVICES FEATURING PRESCRIPTION DRUGS AND OVER THE COUNTER MEDICATION; PROVIDING ONLINE INFORMATION IN THE FIELDS OF RETAIL PHARMACY STORE LOCATIONS AND STATUS OF PHARMACY ORDERS (U.S. CLS. 100, 101 AND 102).

FIRST USE 0-0-1993; IN COMMERCE 0-0-1993.

CLASS 35—ADVERTISING AND BUSINESS

FOR PROMOTING PUBLIC AWARENESS OF THE NEED FOR EMPLOYEES AND INDIVIDUALS TO BE ENVIRONMENTALLY SENSITIVE IN THEIR DAILY LIVES (U.S. CLS. 100, 101 AND 102).

CLASS 41—EDUCATION AND ENTERTAINMENT

FOR EDUCATIONAL SERVICES, NAMELY, ARRANGING AND CONDUCTING WORKSHOPS, SEMINARS, SPECIAL EVENTS, TRAINING COURSES, CONFERENCES, AND ONLINE TRAINING TO EMPLOYEES AND INDIVIDUALS IN THE FIELD OF ENVIRONMENTAL AWARENESS (U.S. CLS. 100, 101 AND 107).

KIM MONINGHOFF, EXAMINING ATTORNEY

SN 77-465,922. INTERDESIGN, INC., SOLON, OH. FILED 5-5-2008.



OWNER OF U.S. REG. NOS. 2,858,689 AND 3,325,152.
THE MARK CONSISTS OF THE LETTER "I" WITHIN THE LETTER "D" AND THE WORD "IDESIGN" BELOW THE DRAWING.

CLASS 6—METAL GOODS

FOR METAL BASKETS; METAL TISSUE BOXES IN THE NATURE OF METAL BOUTIQUE AND TISSUE BOXES FOR HOLDING AND DISPENSING TISSUE PAPER; METAL SHOWER HOOKS; METAL SHOWER HOOKS WITH PLASTIC FINIAL (U.S. CLS. 2, 12, 13, 14, 23, 25 AND 50).

CLASS 20—FURNITURE AND ARTICLES NOT OTHERWISE CLASSIFIED

FOR SHELVES; METAL 2-TIER SHELVES; METAL 3-TIER SHELVES; METAL STACKABLE SHELVES (U.S. CLS. 2, 13, 22, 25, 32 AND 50).

CLASS 21—HOUSEWARES AND GLASS

FOR PLASTIC TISSUE BOX COVERS WITH METAL TRIM; CERAMIC TUMBLING DRINKING GLASSES;- CERAMIC CANISTERS; CERAMIC SOAP CANISTERS;- CERAMIC BOWL BRUSHES; CERAMIC CANISTERS WITH METAL TRIM; CERAMIC SOAP PUMPS WITH METAL TRIM; CERAMIC TUMBLERS WITH METAL TRIM; CERAMIC BOWL BRUSHES WITH METAL TRIM; WASTEBASKETS; GLASS CANISTERS WITH METAL LIDS (U.S. CLS. 2, 13, 23, 29, 30, 33, 40 AND 50).

CLASS 24—FABRICS

FOR SHOWER CURTAINS (U.S. CLS. 42 AND 50).
HENRY S. ZAK, EXAMINING ATTORNEY

SN 77-466,450. JOHNSON & JOHNSON, NEW BRUNSWICK, NJ. FILED 5-6-2008.

HIS+HERS

THE MARK CONSISTS OF STANDARD CHARACTERS WITHOUT CLAIM TO ANY PARTICULAR FONT, STYLE, SIZE, OR COLOR.

CLASS 3—COSMETICS AND CLEANING PREPARATIONS

FOR NON-MEDICATED TOPICAL PREPARATIONS, NAMELY, GELS FOR ENHANCING SEXUAL AROUSAL (U.S. CLS. 1, 4, 6, 50, 51 AND 52).

CLASS 5—PHARMACEUTICALS

FOR PERSONAL LUBRICANTS; VAGINAL MOISTURIZERS (U.S. CLS. 6, 18, 44, 46, 51 AND 52).
LEIGH LOWRY, EXAMINING ATTORNEY

SN 77-467,182. FARM BOY CO-OP & FEED CO., LLC, ST. PAUL, MN. FILED 5-6-2008.

FARM DOG

THE MARK CONSISTS OF STANDARD CHARACTERS WITHOUT CLAIM TO ANY PARTICULAR FONT, STYLE, SIZE, OR COLOR.

NO CLAIM IS MADE TO THE EXCLUSIVE RIGHT TO USE "DOG", APART FROM THE MARK AS SHOWN.

CLASS 18—LEATHER GOODS

FOR DOG LEASHES AND COLLARS (U.S. CLS. 1, 2, 3, 22 AND 41).

CLASS 21—HOUSEWARES AND GLASS

FOR DOG BOWLS (U.S. CLS. 2, 13, 23, 29, 30, 33, 40 AND 50).
LINDA M. KING, EXAMINING ATTORNEY

SN 77-467,191. FARM BOY CO-OP & FEED CO., LLC, ST. PAUL, MN. FILED 5-6-2008.

FARM CAT

THE MARK CONSISTS OF STANDARD CHARACTERS WITHOUT CLAIM TO ANY PARTICULAR FONT, STYLE, SIZE, OR COLOR.

NO CLAIM IS MADE TO THE EXCLUSIVE RIGHT TO USE "CAT", APART FROM THE MARK AS SHOWN.

CLASS 18—LEATHER GOODS

FOR CAT LEASHES AND COLLARS (U.S. CLS. 1, 2, 3, 22 AND 41).

CLASS 21—HOUSEWARES AND GLASS

FOR CAT BOWLS (U.S. CLS. 2, 13, 23, 29, 30, 33, 40 AND 50).
LINDA M. KING, EXAMINING ATTORNEY

SN 77-471,823. PHYSIOTHERAPY CORPORATION, EXTON, PA. FILED 5-12-2008.

SN 77-474,516. ELECTRONIC FIELD PRODUCTIONS, INC., ROCHESTER, NY. FILED 5-14-2008.

PHYSIOLINK

THE MARK CONSISTS OF STANDARD CHARACTERS WITHOUT CLAIM TO ANY PARTICULAR FONT, STYLE, SIZE, OR COLOR.

CLASS 35—ADVERTISING AND BUSINESS

FOR BUSINESS SERVICES, NAMELY, REGISTERING, SCREENING, CREDENTIALING, AND ORGANIZING THIRD-PARTY VENDORS, SUPPLIERS, AND CONTRACTORS, AND DOCUMENTATION AND INFORMATION ON BEHALF OF OTHERS IN THE FIELD OF PHYSICAL, OCCUPATIONAL AND SPEECH THERAPY; CONSULTING SERVICES IN THE COST AND PAYMENT MANAGEMENT OF HEALTH CARE; MEDICAL BILLING SUPPORT SERVICES (U.S. CLS. 100, 101 AND 102).

FIRST USE 4-27-2008; IN COMMERCE 4-27-2008.

CLASS 44—MEDICAL, BEAUTY AND AGRICULTURAL SERVICES

FOR PHYSICAL THERAPY AND PHYSICAL REHABILITATION SERVICES (U.S. CLS. 100 AND 101).

FIRST USE 4-27-2008; IN COMMERCE 4-27-2008.
JIM RINGLE, EXAMINING ATTORNEY

SN 77-473,204. FEDERAL RESERVE BANK OF ATLANTA, ATLANTA, GA. FILED 5-13-2008.

FRENSI

THE MARK CONSISTS OF STANDARD CHARACTERS WITHOUT CLAIM TO ANY PARTICULAR FONT, STYLE, SIZE, OR COLOR.

CLASS 35—ADVERTISING AND BUSINESS

FOR PROVIDING A REGISTRY OF FINANCIAL INSTITUTION REPRESENTATIVES THAT ALLOWS REPRESENTATIVES TO REGISTER AS CONTACTS TO RECEIVE EMERGENCY OPERATIONAL NOTIFICATIONS VIA TELEPHONE OR E-MAIL (U.S. CLS. 100, 101 AND 102).

FIRST USE 4-0-2007; IN COMMERCE 4-0-2007.

CLASS 38—COMMUNICATION

FOR EMERGENCY NOTIFICATION SERVICES, NAMELY, PROVIDING TELEPHONE OR EMAIL NOTIFICATION ALERTS OF BANKING AND FINANCIAL EMERGENCIES (U.S. CLS. 100, 101 AND 104).

FIRST USE 4-0-2007; IN COMMERCE 4-0-2007.
JAY FLOWERS, EXAMINING ATTORNEY



OWNER OF U.S. REG. NOS. 2,460,219 AND 3,368,960.
THE COLOR(S) BLACK, WHITE, RED, YELLOW, ORANGE AND BROWN IS/ARE CLAIMED AS A FEATURE OF THE MARK.

THE MARK CONSISTS OF THE COLOR(S) BLACK, WHITE, RED, YELLOW, ORANGE, AND BROWN, WITH THE LETTERS "EFP" APPEARING IN BLACK AGAINST A YELLOW, WHITE, AND ORANGE SHADED CIRCLE SURROUNDED BY BLACK CONCENTRIC CIRCLES, AND AN OUTER YELLOW, ORANGE, RED AND BROWN SHADED CIRCLE WITH A BLACK BORDER

CLASS 35—ADVERTISING AND BUSINESS

FOR PRODUCTION OF RADIO AND TELEVISION COMMERCIALS (U.S. CLS. 100, 101 AND 102).

FIRST USE 5-9-2006; IN COMMERCE 5-9-2006.

CLASS 41—EDUCATION AND ENTERTAINMENT

FOR VIDEO AND AUDIO RECORDING AND PRODUCTION; ENTERTAINMENT, NAMELY, PRODUCTION OF TELEVISION PROGRAMS AND PRODUCTION OF CORPORATE VIDEO PROGRAMS; ENTERTAINMENT SERVICES, NAMELY, PRODUCTION AND DISTRIBUTION OF A GAME SHOW; MEDIA PRODUCTION SERVICES, NAMELY, PRODUCTION OF VIDEO FOR DISTRIBUTION AND DISPLAY ON THE INTERNET; MOBILE MEDIA AND ENTERTAINMENT SERVICES IN THE NATURE OF CONTENT PREPARATION, POST-PRODUCTION; MOTION PICTURE FILM PRODUCTION; MOTION PICTURE SONG PRODUCTION; MULTIMEDIA ENTERTAINMENT SERVICES IN THE NATURE OF RECORDING, PRODUCTION AND POST-PRODUCTION SERVICES IN THE FIELDS OF MUSIC, VIDEO, AND FILMS; MULTIMEDIA ENTERTAINMENT SOFTWARE PRODUCTION SERVICES; MUSIC PRODUCTION SERVICES; OPERATION OF VIDEO EQUIPMENT OR AUDIO EQUIPMENT ETC FOR PRODUCTION OF RADIO OR TELEVISION PROGRAMS; POST-PRODUCTION EDITING SERVICES IN THE FIELD OF MUSIC, VIDEOS AND FILMS; PRODUCTION AND DISTRIBUTION OF INDEPENDENT MOTION PICTURES; PRODUCTION AND DISTRIBUTION OF MOTION PICTURES; PRODUCTION AND DISTRIBUTION OF RADIO PROGRAMS; PRODUCTION AND DISTRIBUTION OF TELEVISION SHOWS AND MOVIES; PRODUCTION OF DVDS, VIDEOTAPES AND TELEVISION PROGRAMS FOR OTHERS FEATURING CORPORATE INFORMATION, CORPORATE AWARENESS, CORPORATE TRAINING, MARKETING, SALES, CORPORATE EVENTS, AIR SHOWS, DOCUMENTARIES, NON-PROFIT FUNDRAISING INFORMATION, NON-PROFIT FUNDRAISING AWARENESS, NON-PROFIT FUNDRAISING TRAINING, PERSONAL PROFILES, INSTITUTIONAL PROFILES AND DEPOSITIONS; PRODUCTION OF CABLE TELEVISION PROGRAMS; PRODUCTION OF CLOSED CAPTION TELEVISION PROGRAMS; PRODUCTION OF FILM STUDIES; PRODUCTION OF RADIO AND TELEVISION PROGRAMS; PRODUCTION OF RADIO OR TELEVISION PROGRAMS; PRODUCTION OF SOUND AND MUSIC VIDEO RECORDINGS; PRODUCTION OF VIDEO AND COM-

PUTER GAME SOFTWARE; PRODUCTION OF VIDEO AND CREATION OF VISUAL EFFECTS FOR OTHERS FOR USE IN DVDS, TELEVISION PROGRAMS AND ON WEB SITES; PRODUCTION OF VIDEO CASSETTES; PRODUCTION OF VIDEO DISCS AND TAPES; PRODUCTION OF VIDEO DISCS FOR OTHERS; PRODUCTION OF VISUAL EFFECTS FOR VIDEOS, DVDS, TELEVISION AND FOR INTERNET WEB SITES; RADIO ENTERTAINMENT PRODUCTION; RECORD MASTER PRODUCTION; RECORD PRODUCTION; TELEVISION PRODUCTION; TELEVISION SHOW PRODUCTION; VIDEOTAPE PRODUCTION (U.S. CLS. 100, 101 AND 107).
FIRST USE 5-9-2006; IN COMMERCE 5-9-2006.
CHRISTINE BLOMQUIST, EXAMINING ATTORNEY

SN 77-476,181. EMAGINE LLC, SCOTTSDALE, AZ. FILED 5-16-2008.

SAVING THE WORLD ONE WORKSHOP AT A TIME

THE MARK CONSISTS OF STANDARD CHARACTERS WITHOUT CLAIM TO ANY PARTICULAR FONT, STYLE, SIZE, OR COLOR.

CLASS 16—PAPER GOODS AND PRINTED MATTER

FOR CATALOGS IN THE FIELD OF ENVIRONMENTALLY FRIENDLY METHODS AND PRODUCTS (U.S. CLS. 2, 5, 22, 23, 29, 37, 38 AND 50).

CLASS 18—LEATHER GOODS

FOR ALL PURPOSE CARRYING BAGS (U.S. CLS. 1, 2, 3, 22 AND 41).

CLASS 21—HOUSEWARES AND GLASS

FOR BOTTLES SOLD EMPTY (U.S. CLS. 2, 13, 23, 29, 30, 33, 40 AND 50).

CLASS 25—CLOTHING

FOR T-SHIRTS (U.S. CLS. 22 AND 39).

CLASS 35—ADVERTISING AND BUSINESS

FOR ONLINE RETAIL STORE SERVICES FEATURING ENVIRONMENTALLY FRIENDLY CONSUMER PRODUCTS (U.S. CLS. 100, 101 AND 102).

CLASS 41—EDUCATION AND ENTERTAINMENT

FOR CONDUCTING WORKSHOPS IN THE FIELDS OF ENVIRONMENTAL CONSCIOUSNESS AND ENVIRONMENTALLY FRIENDLY METHODS AND PRODUCTS; PROFESSIONAL COACHING SERVICES IN THE FIELD OF HOW TO BECOME ENVIRONMENTALLY FRIENDLY (U.S. CLS. 100, 101 AND 107).
LANA PHAM, EXAMINING ATTORNEY

SN 77-476,180. EMAGINE LLC, SCOTTSDALE, AZ. FILED 5-16-2008.

LISTEN TO YOUR MOTHER

THE MARK CONSISTS OF STANDARD CHARACTERS WITHOUT CLAIM TO ANY PARTICULAR FONT, STYLE, SIZE, OR COLOR.

CLASS 16—PAPER GOODS AND PRINTED MATTER

FOR CATALOGS IN THE FIELD OF ENVIRONMENTALLY FRIENDLY METHODS AND PRODUCTS (U.S. CLS. 2, 5, 22, 23, 29, 37, 38 AND 50).

CLASS 18—LEATHER GOODS

FOR ALL PURPOSE CARRYING BAGS (U.S. CLS. 1, 2, 3, 22 AND 41).

CLASS 21—HOUSEWARES AND GLASS

FOR BOTTLES SOLD EMPTY (U.S. CLS. 2, 13, 23, 29, 30, 33, 40 AND 50).

CLASS 25—CLOTHING

FOR T-SHIRTS (U.S. CLS. 22 AND 39).

CLASS 35—ADVERTISING AND BUSINESS

FOR ONLINE RETAIL STORE SERVICES FEATURING ENVIRONMENTALLY FRIENDLY CONSUMER PRODUCTS (U.S. CLS. 100, 101 AND 102).

CLASS 41—EDUCATION AND ENTERTAINMENT

FOR CONDUCTING WORKSHOPS IN THE FIELDS OF ENVIRONMENTAL CONSCIOUSNESS AND ENVIRONMENTALLY FRIENDLY METHODS AND PRODUCTS; PROFESSIONAL COACHING SERVICES IN THE FIELD OF HOW TO BECOME ENVIRONMENTALLY FRIENDLY (U.S. CLS. 100, 101 AND 107).
LANA PHAM, EXAMINING ATTORNEY

SN 77-476,223. NORTH AMERICAN DIVISION CORPORATION OF SEVENTH-DAY ADVENTISTS, SILVER SPRING, MD. FILED 5-16-2008.

Shabbat Shalom

THE MARK CONSISTS OF STANDARD CHARACTERS WITHOUT CLAIM TO ANY PARTICULAR FONT, STYLE, SIZE, OR COLOR.

THE FOREIGN WORDING IN THE MARK TRANSLATES INTO ENGLISH AS SABBATH PEACE.

CLASS 9—ELECTRICAL AND SCIENTIFIC APPARATUS

FOR ELECTRONIC PUBLICATIONS, NAMELY, A MAGAZINE FEATURING RELIGION RECORDED ON COMPUTER MEDIA (U.S. CLS. 21, 23, 26, 36 AND 38).
FIRST USE 12-19-1985; IN COMMERCE 12-19-1985.

CLASS 16—PAPER GOODS AND PRINTED MATTER

FOR MAGAZINES FEATURING RELIGION; LETTER-HEAD PAPER; BUSINESS CARDS; ENVELOPES (U.S. CLS. 2, 5, 22, 23, 29, 37, 38 AND 50).
FIRST USE 12-19-1985; IN COMMERCE 12-19-1985.
TARA PATE, EXAMINING ATTORNEY

CLASS 17—RUBBER GOODS

FOR RUBBER, GUTTA-PERCHA, ASBESTOS; PLASTICS IN EXTRUDED FORM FOR USE IN MANUFACTURE; PACKING AND INSULATING MATERIALS; STOPPING MATERIALS, NAMELY, ADHESIVE SEALANTS FOR GENERAL USE AND PIPE JOINT SEALANTS; FLEXIBLE PIPES NOT OF METAL; PLASTIC MATERIALS FOR PACKAGING, NAMELY, FILMS AND SHEETS (U.S. CLS. 1, 5, 12, 13, 35 AND 50).
SANI KHOURI, EXAMINING ATTORNEY

SN 77-478,646. LIVEOPS, INC., PALO ALTO, CA. FILED 5-19-2008.

SN 77-476,492. ARKEMA FRANCE, 92700 COLOMBES, FRANCE, FILED 5-16-2008.



PRIORITY CLAIMED UNDER SEC. 44(D) ON FRANCE APPLICATION NO. 73538544, FILED 11-21-2007, REG. NO. 073538544, DATED 11-21-2007, EXPIRES 11-21-2017.

OWNER OF U.S. REG. NOS. 3,082,057 AND 3,082,135.

NO CLAIM IS MADE TO THE EXCLUSIVE RIGHT TO USE "RENEWABLES", APART FROM THE MARK AS SHOWN.

THE MARK CONSISTS OF THE STYLIZED WORDING "ARKEMA RENEWABLES" CONTAINED WITHIN A STYLIZED LEAF DESIGN.

CLASS 1—CHEMICALS

FOR CHEMICALS USED IN INDUSTRY, SCIENCE AND PHOTOGRAPHY, AS WELL AS IN AGRICULTURE, HORTICULTURE AND FORESTRY EXCEPT FUNGICIDES, HERBICIDES, INSECTICIDES AND PARASITICIDES; UNPROCESSED ARTIFICIAL AND SYNTHETIC RESINS; UNPROCESSED PLASTICS; TEMPERING AND SOLDERING PREPARATIONS; CHEMICAL SUBSTANCES FOR PRESERVING FOODSTUFFS; TANNING SUBSTANCES, NAMELY, TANNING AGENTS FOR USE IN THE MANUFACTURE OF LEATHER; ADHESIVES USED IN INDUSTRY (U.S. CLS. 1, 5, 6, 10, 26 AND 46).

CLASS 16—PAPER GOODS AND PRINTED MATTER

FOR CARDBOARDS; BAGS, SACHETS, ENVELOPES, AND POUCHES OF PAPER FOR PACKAGING; CARDBOARD TUBES; PRINTED MATTER, NAMELY, BOOKS ON ENVIRONMENTAL SCIENCE AND POSTERS; BOOKBINDING MATERIAL; PHOTOGRAPHS; STATIONERY; ADHESIVES FOR STATIONERY OR HOUSEHOLD PURPOSES; PLASTIC MATERIALS FOR PACKAGING, NAMELY, BAGS AND SACHETS (U.S. CLS. 2, 5, 22, 23, 29, 37, 38 AND 50).

THE CALL CENTER HAS LEFT THE BUILDING

THE MARK CONSISTS OF STANDARD CHARACTERS WITHOUT CLAIM TO ANY PARTICULAR FONT, STYLE, SIZE, OR COLOR.

CLASS 35—ADVERTISING AND BUSINESS

FOR CALL CENTER SERVICES FOR OTHERS, NAMELY, OPERATING AND MANAGING CALL CENTERS FOR OTHERS AND ACCEPTING, PROCESSING, ANSWERING, RECORDING, TRACKING, EVALUATING, PROFILING, DISTRIBUTING, AUDITING, ADMINISTERING, RESPONDING, AND REPORTING TELEPHONE CALLS, ORDERS, AND INQUIRIES; PROMOTION OF GOODS AND SERVICES OF OTHERS BY TELEPHONE; BUSINESS MANAGEMENT SERVICES; BUSINESS AND MARKETING CONSULTATION SERVICES; BUSINESS SERVICES, NAMELY, RECRUITING CALL CENTER AGENTS, SCHEDULING CALL CENTER AGENTS TO HANDLE CALL CENTER DEMAND, AND PROVIDING INFORMATION AND ANALYSIS RELATED TO CALL CENTER AGENT PERFORMANCE FOR OTHERS; BUSINESS MANAGEMENT; OUTSOURCING SERVICES IN THE FIELD OF CUSTOMER SERVICE, MARKETING, AND SALES (U.S. CLS. 100, 101 AND 102).

FIRST USE 2-6-2008; IN COMMERCE 2-6-2008.

CLASS 38—COMMUNICATION

FOR INTERNET TELEPHONY SERVICES; TELECOMMUNICATION SERVICES, NAMELY, ROUTING AND QUEUING TELEPHONE CALLS (U.S. CLS. 100, 101 AND 104).

FIRST USE 2-6-2008; IN COMMERCE 2-6-2008.

CLASS 41—EDUCATION AND ENTERTAINMENT

FOR EDUCATIONAL SERVICES, NAMELY, PROVIDING ONLINE COURSES FOR CALL CENTER PERSONNEL FOR CERTIFYING FOR OTHERS; DEVELOPING EDUCATIONAL MATERIALS FOR OTHERS IN THE FIELD OF CALL CENTER OPERATION AND MANAGEMENT, TELESERVICE, AND CUSTOMER SERVICE; ONLINE PUBLICATION OF INSTRUCTIONAL PUBLICATIONS, NAMELY, MANUALS, GUIDES, BOOKLETS, NEWSLETTERS AND BULLETINS, AND DATA SHEETS, ALL IN THE FIELD OF CALL CENTER OPERATION AND MANAGEMENT, CUSTOMER SERVICE, AND TELESERVICE (U.S. CLS. 100, 101 AND 107).

FIRST USE 2-6-2008; IN COMMERCE 2-6-2008.

CLASS 42—SCIENTIFIC AND COMPUTER SERVICES

FOR PROVIDING A WEBSITE FEATURING TEMPORARY USE OF NON-DOWNLOADABLE SOFTWARE FOR HOSTING, MANAGING, ACCEPTING, PROCESSING, ANSWERING, TRACKING, EVALUATING, PROFILING, ROUTING, DISTRIBUTING, QUEUING, AUDITING, ADMINISTERING, RESPONDING, REPORTING, AND EVALUATING RESPONSES TO TELEPHONE CALLS, ORDERS, AND INQUIRIES; PROVIDING A WEBSITE FEATURING TEMPORARY USE OF NON-DOWNLOADABLE SOFTWARE FOR CUSTOMER AND DATABASE MANAGEMENT IN THE FIELD OF CALL CENTER SERVICES; CUSTOMER/CLIENT AND TECHNICAL SUPPORT SERVICES FOR OTHERS, NAMELY, PROVIDING TECHNICAL INFORMATION AND TROUBLESHOOTING PROBLEMS RELATED TO CALL CENTER TECHNOLOGY AND SYSTEMS (U.S. CLS. 100 AND 101).

FIRST USE 2-6-2008; IN COMMERCE 2-6-2008.
JILL PRATER, EXAMINING ATTORNEY

SN 77-480,534. BEECH-NUT NUTRITION CORPORATION, LATHAM, NY. FILED 5-21-2008.

TUMMY TRAYS

THE MARK CONSISTS OF STANDARD CHARACTERS WITHOUT CLAIM TO ANY PARTICULAR FONT, STYLE, SIZE, OR COLOR.

NO CLAIM IS MADE TO THE EXCLUSIVE RIGHT TO USE "TRAYS", APART FROM THE MARK AS SHOWN.

CLASS 29—MEATS AND PROCESSED FOODS

FOR MICROWAVEABLE MEALS IN A TRAY, CONSISTING PRIMARILY OF MEAT, FISH, POULTRY OR VEGETABLES (U.S. CL. 46).

CLASS 30—STAPLE FOODS

FOR MICROWAVEABLE MEALS IN A TRAY, CONSISTING PRIMARILY OF PASTA OR RICE (U.S. CL. 46).
SETH A. RAPPAPORT, EXAMINING ATTORNEY

SN 77-481,403. DELORT, KEVIN, PALO ALTO, CA. FILED 5-22-2008.

Dijoux Solar System

THE MARK CONSISTS OF STANDARD CHARACTERS WITHOUT CLAIM TO ANY PARTICULAR FONT, STYLE, SIZE, OR COLOR.

NO CLAIM IS MADE TO THE EXCLUSIVE RIGHT TO USE "SOLAR SYSTEM", APART FROM THE MARK AS SHOWN.

CLASS 9—ELECTRICAL AND SCIENTIFIC APPARATUS

FOR (BASED ON INTENT TO USE) APPARATUS FOR CONVERTING ELECTRONIC RADIATION TO ELECTRICAL ENERGY, NAMELY, PHOTOVOLTAIC SOLAR HYBRID MODULES; APPARATUS FOR CONVERTING ELECTRONIC RADIATION TO ELECTRICAL ENERGY, NAMELY, PHOTOVOLTAIC SOLAR MODULES; ELECTRICAL SENSORS FOR MEASURING SOLAR RADIATION; PHOTOVOLTAIC CELLS ALSO INCLUDING A SOLAR THERMAL COLLECTOR SOLD AS A UNIT; SOLAR CELLS (BASED ON 44(E)) APPARATUS FOR CONVERTING ELECTRONIC RADIATION TO ELECTRICAL ENERGY, NAMELY, PHOTOVOLTAIC SOLAR HYBRID MODULES; APPARATUS FOR CONVERTING ELECTRONIC RADIATION TO ELECTRICAL ENERGY, NAMELY, PHOTOVOLTAIC SOLAR MODULES; ELECTRICAL SENSORS FOR MEASURING SOLAR RADIATION; PHOTOVOLTAIC CELLS ALSO INCLUDING A SOLAR THERMAL COLLECTOR SOLD AS A UNIT; SOLAR CELLS (U.S. CLS. 21, 23, 26, 36 AND 38).

CLASS 11—ENVIRONMENTAL CONTROL APPARATUS

FOR (BASED ON INTENT TO USE) SOLAR COLLECTORS; SOLAR ENERGY BASED COOLING APPARATUS; SOLAR HEAT COLLECTION PANELS; SOLAR THERMAL AIR SYSTEMS FOR HEATING PURPOSES; SOLAR THERMAL INSTALLATIONS, NAMELY, SOLAR THERMAL MODULES; SOLAR WATER HEATERS (BASED ON 44(E)) SOLAR COLLECTORS; SOLAR ENERGY BASED COOLING APPARATUS; SOLAR HEAT COLLECTION PANELS; SOLAR THERMAL AIR SYSTEMS FOR HEATING PURPOSES; SOLAR THERMAL INSTALLATIONS, NAMELY, SOLAR THERMAL MODULES; SOLAR WATER HEATERS (U.S. CLS. 13, 21, 23, 31 AND 34).

CLASS 37—CONSTRUCTION AND REPAIR

FOR INSTALLATION AND MAINTENANCE OF PHOTOVOLTAIC/SOLAR THERMAL HYBRID INSTALLATIONS; INSTALLATION AND MAINTENANCE OF SOLAR THERMAL INSTALLATIONS; REPAIR AND INSTALLATION SERVICES, NAMELY, THE INSTALLATION OF HEATING, COOLING AND ENVIRONMENTAL CONTROL SYSTEMS PRIMARILY USING SOLAR ENERGY, RENEWABLE ENERGY RESOURCES AND RAINWATER (U.S. CLS. 100, 103 AND 106).

CLASS 42—SCIENTIFIC AND COMPUTER SERVICES

FOR TECHNICAL PLANNING OF PHOTOVOLTAIC/SOLAR THERMAL HYBRID INSTALLATIONS; TECHNICAL PLANNING OF SOLAR THERMAL INSTALLATIONS (U.S. CLS. 100 AND 101).
BENJAMIN OKEKE, EXAMINING ATTORNEY

SN 77-481,573. COUNCIL OF BETTER BUSINESS BUREAUS, INC., ARLINGTON, VA. FILED 5-22-2008.

BBB Air Force Line

THE MARK CONSISTS OF STANDARD CHARACTERS WITHOUT CLAIM TO ANY PARTICULAR FONT, STYLE, SIZE, OR COLOR.

OWNER OF U.S. REG. NOS. 2,314,197, 3,201,719 AND OTHERS.

NO CLAIM IS MADE TO THE EXCLUSIVE RIGHT TO USE "AIR FORCE LINE", APART FROM THE MARK AS SHOWN.

CLASS 35—ADVERTISING AND BUSINESS

FOR CONSUMER INFORMATION SERVICES RELATIVE TO BUSINESS AND TRADE PRACTICES FOR PROTECTING RESPONSIBLE BUSINESS AND THE PUBLIC AGAINST ABUSIVE BUSINESS PRACTICES AND FOR ESTABLISHING AND MAINTAINING LEGITIMATE ADVERTISING AND MERCHANDISING PRACTICES (U.S. CLS. 100, 101 AND 102).

FIRST USE 1-24-2005; IN COMMERCE 1-24-2005.

CLASS 45—PERSONAL AND LEGAL SERVICES

FOR CONCILIATION, MEDIATION AND ARBITRATION SERVICES FOR RESOLUTION OF DISPUTES BETWEEN AIR FORCE MILITARY PERSONNEL AND THEIR FAMILIES AND COMPANIES PROVIDING SERVICES TO THIS GROUP (U.S. CLS. 100 AND 101).

FIRST USE 1-24-2005; IN COMMERCE 1-24-2005.
COLLEEN DOMBROW, EXAMINING ATTORNEY

SN 77-483,517. ALTA INVESTMENTS, LLC, BALTIMORE, MD. FILED 5-27-2008.

THE BETTER WAY TO PAY.

THE MARK CONSISTS OF STANDARD CHARACTERS WITHOUT CLAIM TO ANY PARTICULAR FONT, STYLE, SIZE, OR COLOR.

CLASS 9—ELECTRICAL AND SCIENTIFIC APPARATUS

FOR ENCODED MAGNETIC CARDS FOR USE BY EMPLOYERS IN THE TRANSPORTATION FIELD TO TRANSFER FUNDS TO EMPLOYEES AND INDEPENDENT CONTRACTORS; MAGNETICALLY ENCODED DEBIT CARDS FOR USE BY EMPLOYERS IN THE TRANSPORTATION FIELD TO TRANSFER FUNDS TO EMPLOYEES AND INDEPENDENT CONTRACTORS (U.S. CLS. 21, 23, 26, 36 AND 38).

CLASS 36—INSURANCE AND FINANCIAL

FOR DEBIT CARD SERVICES, ELECTRONIC DEBIT TRANSACTIONS, AND ELECTRONIC FUNDS TRANSFER SERVICES PROVIDED TO EMPLOYERS IN THE TRANSPORTATION FIELD. NAMELY, ISSUANCE OF PAYROLL FUNDS TO EMPLOYEES AND INDEPENDENT CONTRACTORS AND DEPOSITS TO DEBIT CARDS WITH RESPECT TO PAYROLL (U.S. CLS. 100, 101 AND 102).

LOURDES AYALA, EXAMINING ATTORNEY

SN 77-482,065. COUNCIL OF BETTER BUSINESS BUREAUS, INC., ARLINGTON, VA. FILED 5-23-2008.

BBB Navy Line

THE MARK CONSISTS OF STANDARD CHARACTERS WITHOUT CLAIM TO ANY PARTICULAR FONT, STYLE, SIZE, OR COLOR.

OWNER OF U.S. REG. NOS. 2,314,197, 3,201,719 AND OTHERS.

NO CLAIM IS MADE TO THE EXCLUSIVE RIGHT TO USE "NAVY LINE", APART FROM THE MARK AS SHOWN.

CLASS 35—ADVERTISING AND BUSINESS

FOR CONSUMER INFORMATION SERVICES RELATIVE TO BUSINESS AND TRADE PRACTICES FOR PROTECTING RESPONSIBLE BUSINESS AND THE PUBLIC AGAINST ABUSIVE BUSINESS PRACTICES AND FOR ESTABLISHING AND MAINTAINING LEGITIMATE ADVERTISING AND MERCHANDISING PRACTICES (U.S. CLS. 100, 101 AND 102).

FIRST USE 1-24-2005; IN COMMERCE 1-24-2005.

CLASS 45—PERSONAL AND LEGAL SERVICES

FOR CONCILIATION, MEDIATION AND ARBITRATION SERVICES FOR RESOLUTION OF DISPUTES BETWEEN NAVY MILITARY PERSONNEL AND THEIR FAMILIES AND COMPANIES PROVIDING SERVICES TO THIS GROUP (U.S. CLS. 100 AND 101).

FIRST USE 1-24-2005; IN COMMERCE 1-24-2005.
COLLEEN DOMBROW, EXAMINING ATTORNEY

SN 77-483,638. RWFR FRANCHISE COMPANY, COUNCIL BLUFFS, IA. FILED 5-27-2008.



OWNER OF U.S. REG. NO. 1,668,682.

NO CLAIM IS MADE TO THE EXCLUSIVE RIGHT TO USE "FUNDRAISING", APART FROM THE MARK AS SHOWN.

THE MARK CONSISTS OF A CHEF PUSHING A CART WITH THE TERMS "RED WHEEL FUNDRAISING" ON A SIGN OF THE CART.

CLASS 30—STAPLE FOODS

FOR PIZZA, TACOS, BURRITOS, EGG ROLLS, SALSA, COFFEE, COCOA, CAKE, COOKIE DOUGH, CHEESE-CAKE, PIE, ROLLS, PASTRIES, BROWNIE BATTER, BREAD DOUGH, MUFFIN DOUGH (U.S. CL. 46).

FIRST USE 8-1-2005; IN COMMERCE 8-1-2005.

CLASS 36—INSURANCE AND FINANCIAL

FOR FUNDRAISING SERVICES, NAMELY, ORGANIZING, ARRANGING, AND CONDUCTING FUNDRAISING PROGRAMS FOR THE BENEFIT OF SCHOOLS AND NON-PROFIT ORGANIZATIONS, NAMELY, STUDENT ACTIVITY GROUPS, PARENT-TEACHER ASSOCIATIONS, ATHLETIC TEAMS, CHEERLEADING TEAMS, SCHOOL MUSIC GROUPS, SCHOOL LIBRARIES, CHURCHES, SYNAGOGUES, TEMPLES, MOSQUES, YOUTH MINISTRIES, CHURCH GROUPS, MISSION ACTIVITIES, SUMMER CAMPS, YOUTH INTEREST GROUPS AND CLUBS, SCOUTING GROUPS, COMMUNITY-WIDE CLUBS, CHARITABLE GROUPS, COMMUNITY SERVICE GROUPS (U.S. CLS. 100, 101 AND 102).

FIRST USE 8-1-2005; IN COMMERCE 8-1-2005.
JAMES STEIN, EXAMINING ATTORNEY

SN 77-483,644. RWFR FRANCHISE COMPANY, COUNCIL BLUFFS, IA. FILED 5-27-2008.

RED WHEEL

THE MARK CONSISTS OF STANDARD CHARACTERS WITHOUT CLAIM TO ANY PARTICULAR FONT, STYLE, SIZE, OR COLOR.

OWNER OF U.S. REG. NO. 1,668,682.

CLASS 30—STAPLE FOODS

FOR PIZZA, TACOS, BURRITOS, EGG ROLLS, SALSA, COFFEE, COCOA, CAKE, COOKIE DOUGH, CHEESE-CAKE, PIE, ROLLS, PASTRIES, BROWNIE BATTER, BREAD DOUGH, MUFFIN DOUGH (U.S. CL. 46).

FIRST USE 5-1-1989; IN COMMERCE 5-1-1989.

CLASS 36—INSURANCE AND FINANCIAL

FOR FUNDRAISING SERVICES, NAMELY, ORGANIZING, ARRANGING, AND CONDUCTING FUNDRAISING PROGRAMS FOR THE BENEFIT OF SCHOOLS AND NON-PROFIT ORGANIZATIONS, NAMELY, STUDENT ACTIVITY GROUPS, PARENT-TEACHER ASSOCIATIONS, ATHLETIC TEAMS, CHEERLEADING TEAMS, SCHOOL MUSIC GROUPS, SCHOOL LIBRARIES, CHURCHES, SYNAGOGUES, TEMPLES, MOSQUES, YOUTH MINISTRIES, CHURCH GROUPS, MISSION ACTIVITIES, SUMMER CAMPS, YOUTH INTEREST GROUPS AND CLUBS, SCOUTING GROUPS, COMMUNITY-WIDE CLUBS, CHARITABLE GROUPS, COMMUNITY SERVICE GROUPS (U.S. CLS. 100, 101 AND 102).

FIRST USE 5-1-1989; IN COMMERCE 5-1-1989.
JAMES STEIN, EXAMINING ATTORNEY

SN 77-485,135. PACIFIC CROSSROADS CHURCH, LOS ANGELES, CA. FILED 5-28-2008.

HOPE FOR LOS ANGELES

THE MARK CONSISTS OF STANDARD CHARACTERS WITHOUT CLAIM TO ANY PARTICULAR FONT, STYLE, SIZE, OR COLOR.

NO CLAIM IS MADE TO THE EXCLUSIVE RIGHT TO USE "LOS ANGELES", APART FROM THE MARK AS SHOWN.

CLASS 35—ADVERTISING AND BUSINESS

FOR CHARITABLE SERVICES, NAMELY, ORGANIZING AND CONDUCTING VOLUNTEER PROGRAMS AND COMMUNITY SERVICE PROJECTS DIRECTED TO IMPROVING THE CITY OF LOS ANGELES (U.S. CLS. 100, 101 AND 102).

FIRST USE 6-30-2004; IN COMMERCE 6-30-2004.

CLASS 36—INSURANCE AND FINANCIAL

FOR CHARITABLE FUND RAISING SERVICES DIRECTED TO IMPROVING THE CITY OF LOS ANGELES (U.S. CLS. 100, 101 AND 102).

FIRST USE 6-30-2004; IN COMMERCE 6-30-2004.
CIMMERIAN COLEMAN, EXAMINING ATTORNEY

SN 77-488,787. JOHNSON & JOHNSON, NEW BRUNSWICK, NJ. FILED 6-2-2008.

WHOLE MOUTH CLEAN

THE MARK CONSISTS OF STANDARD CHARACTERS WITHOUT CLAIM TO ANY PARTICULAR FONT, STYLE, SIZE, OR COLOR.

CLASS 3—COSMETICS AND CLEANING PREPARATIONS

FOR MOUTHWASH (U.S. CLS. 1, 4, 6, 50, 51 AND 52).
FIRST USE 5-31-2008; IN COMMERCE 5-31-2008.

CLASS 5—PHARMACEUTICALS

FOR ANTISEPTIC MOUTHWASH (U.S. CLS. 6, 18, 44, 46, 51 AND 52).
FIRST USE 5-31-2008; IN COMMERCE 5-31-2008.

CLASS 21—HOUSEWARES AND GLASS

FOR TOOTHBRUSHES AND DENTAL FLOSS (U.S. CLS. 2, 13, 23, 29, 30, 33, 40 AND 50).
FIRST USE 5-31-2008; IN COMMERCE 5-31-2008.
CHRISTINE COOPER, EXAMINING ATTORNEY

SN 77-488,887. WHITWORTH, RON, CAPISTRANO BEACH, CA. FILED 6-2-2008.

SN 77-489,268. HORIZON GROUP USA, INC., WARREN, NJ. FILED 6-3-2008.

VERSA FAB



THE MARK CONSISTS OF STANDARD CHARACTERS WITHOUT CLAIM TO ANY PARTICULAR FONT, STYLE, SIZE, OR COLOR.

NO CLAIM IS MADE TO THE EXCLUSIVE RIGHT TO USE "FAB", APART FROM THE MARK AS SHOWN.

CLASS 6—METAL GOODS

FOR ARCHITECTURAL METALWORK, NAMELY, METAL STAIRCASES, RAILINGS FOR FENCES, BALCONIES AND BRIDGES, WALL PARTITIONS AND INTERIOR AND EXTERNAL DETAILING IN THE NATURE OF MOLDING, WORKS OF ART OF COMMON METAL, METAL MOUNTING SUPPORTS FOR HOLDING WORKS OF ART OF COMMON METAL; METAL RAILINGS USED IN BUILDING CONSTRUCTIONS FOR DECKS, BALCONIES, PORCHES AND PATIOS; ORNAMENTAL CAPS OF METAL USED IN BUILDING CONSTRUCTIONS FOR FENCES, DECKS, BALCONIES, PORCHES, PATIOS, AND SIGNAGE; METAL CHAIN-LINK FENCING; METAL WIRE FENCING, METAL FENCING PANELS, METAL FENCING STAYS; METAL DECORATIVE COMPONENTS USED IN BUILDING CONSTRUCTIONS, NAMELY, DECORATIVE ARCHITECTURAL METALWORK FOR OUTDOOR ORNAMENTATION AND METAL CHESTS (U.S. CLS. 2, 12, 13, 14, 23, 25 AND 50).

CLASS 20—FURNITURE AND ARTICLES NOT OTHERWISE CLASSIFIED

FOR METAL FURNITURE, NAMELY, DESKS, CHAIRS, TABLES, SHELVES, BEDROOM FURNITURE, NAMELY, BEDS AND SIDE TABLES, AND HEADBOARDS, HAMPERS, STOOLS, STORAGE RACKS, HAT RACKS AND COAT RACKS, PICTURE FRAMES, OFFICE FURNITURE, LIVING ROOM FURNITURE, AND WALL UNITS (U.S. CLS. 2, 13, 22, 25, 32 AND 50).
ERIN FALK, EXAMINING ATTORNEY

THE COLOR(S) YELLOW, BLUE, PURPLE, WHITE AND PINK IS/ARE CLAIMED AS A FEATURE OF THE MARK.

THE MARK CONSISTS OF THE WORDS "JUST MY STYLE" IN PINK OUTLINED IN WHITE AND BLUE WRITTEN OVER A YELLOW STAR OUTLINED IN BLUE WITH A PURPLE STAR PROXIMATE THE YELLOW STAR AND A PURPLE STREAK TRAILING BEHIND THE PURPLE STAR.

CLASS 3—COSMETICS AND CLEANING PREPARATIONS

FOR KITS FOR PAINTING AND DECORATING FACES, SKIN, AND HAIR COMPRISED OF FACE, BODY AND HAIR GLITTER, TEMPORARY TATTOOS, MARKERS, STENCILS, NON-PRECIOUS AND ACRYLIC STONES AND PAINT AND INK STAMPS AND PADS (U.S. CLS. 1, 4, 6, 50, 51 AND 52).

CLASS 4—LUBRICANTS AND FUELS

FOR KITS FOR MAKING AND DECORATING CANDLES COMPRISED OF CANDLES, TEA LIGHTS, ACRYLIC STONES, PAINT, PAINT BRUSHES, AND RIBBON (U.S. CLS. 1, 6 AND 15).

CLASS 14—JEWELRY

FOR JEWELRY AND WATCH MAKING KITS COMPRISED OF WATCH FACES, CHARMS, EARRING HOOKS, BEADS, BEADING NEEDLES, SPRING RINGS AND CLASPS, HEMP, SPLIT RINGS, BEAD SCOOPS, BEADING CORDS AND CLASPS; PLASTIC CASES FOR STORAGE OF JEWELRY MAKING ITEMS; KITS FOR DECORATING AND PERSONALIZING NON-METAL JEWELRY BOXES COMPRISED OF NON-METAL JEWELRY BOXES, PAINT, PAINT BRUSHES, GLUE, ACRYLIC STONES, BEADS, CORD; KITS FOR DECORATING PICTURE FRAMES AND PICTURE BORDERS IN THE NATURE OF PICTURE FRAMES, COMPRISED OF PICTURE FRAMES, PICTURE BORDERS, PENS, MARKERS, CONSTRUCTION PAPER, STICKERS, STENCILS, GLITTER, SEQUINS AND RHINESTONES (U.S. CLS. 2, 27, 28 AND 50).

CLASS 16—PAPER GOODS AND PRINTED MATTER

FOR KITS FOR DECORATING AND PERSONALIZING SCRAP BOOKS AND JOURNALS COMPRISED OF NOTEPADS, JOURNALS, SCRAP BOOKS, PENS, SEQUINS, ACRYLIC STONES, GLUE, PRINTED PAPER, STICKERS, STENCILS, SCISSORS, GLITTER, AND RIBBON; KITS FOR DECORATING SCRAPBOOKS COMPRISED OF SCRAPBOOKS, PRINTED CARDS AND ENVELOPES, CONSTRUCTION PAPER, ADHESIVE STICKERS, RIBBON, SCISSORS, PENS, MARKERS, GLUE AND HOLDERS IN THE NATURE OF PHOTOGRAPH BORDERS FOR SECURING PICTURES, ACRYLIC STONES AND SEQUINS (U.S. CLS. 2, 5, 22, 23, 29, 37, 38 AND 50).

CLASS 18—LEATHER GOODS

FOR KITS FOR DECORATING AND PERSONALIZING BAGS, NAMELY, HANDBAGS AND CHANGE PURSES, COMPRISED OF HANDBAGS AND CHANGE PURSES, NON-METAL KEY CHAINS, BEADED FRINGE, SEQUINS, ACRYLIC STONES, FABRIC, PATCHES AND GLUE (U.S. CLS. 1, 2, 3, 22 AND 41).

CLASS 20—FURNITURE AND ARTICLES NOT OTHERWISE CLASSIFIED

FOR KITS FOR DECORATING AND PERSONALIZING NON-METAL JEWELRY BOXES COMPRISED OF NON-METAL JEWELRY BOXES, PAINT, PAINT BRUSHES, GLUE, ACRYLIC STONES, BEADS, CORD; KITS FOR DECORATING PICTURE FRAMES AND PICTURE BORDERS IN THE NATURE OF PICTURE FRAMES, COMPRISED OF PICTURE FRAMES, PICTURE BORDERS, PENS, MARKERS, CONSTRUCTION PAPER, STICKERS, STENCILS, GLITTER, SEQUINS, RHINESTONES (U.S. CLS. 2, 13, 22, 25, 32 AND 50).

CLASS 21—HOUSEWARES AND GLASS

FOR KITS FOR MAKING AND DECORATING LED CANDLE HOLDERS, COMPRISED OF CANDLE HOLDERS, TEA LIGHTS, ACRYLIC STONES, PAINT, PAINT BRUSHES AND RIBBON (U.S. CLS. 2, 13, 23, 29, 30, 33, 40 AND 50).

BONNIE LUKEN, EXAMINING ATTORNEY

SN 77-489,787. SLOPPY HOLES MUD'N CLUB, INC., MYAKKA CITY, FL. FILED 6-3-2008.

SLOPPY HOLES MUD'N CLUB

THE MARK CONSISTS OF STANDARD CHARACTERS WITHOUT CLAIM TO ANY PARTICULAR FONT, STYLE, SIZE, OR COLOR.

NO CLAIM IS MADE TO THE EXCLUSIVE RIGHT TO USE "MUDDING CLUB", APART FROM THE MARK AS SHOWN.

CLASS 35—ADVERTISING AND BUSINESS

FOR ON-LINE RETAIL STORE SERVICES FEATURING CLOTHING, HATS, MUGS, CUPS, CALENDARS, NOVELTY LICENSE PLATES, BUMPER STICKERS, DECALS, BATHING SUITS, AND CLOTH PATCHES FOR CLOTHING AND HATS (U.S. CLS. 100, 101 AND 102).

FIRST USE 8-1-2007; IN COMMERCE 8-1-2007.

CLASS 41—EDUCATION AND ENTERTAINMENT

FOR SOCIAL CLUB SERVICES, NAMELY, ARRANGING, ORGANIZING, AND HOSTING SOCIAL EVENTS, GET-TOGETHERS, AND PARTIES FOR CLUB MEMBERS; PROVIDING INFORMATION, NEWS AND COMMENTARY IN THE FIELD OF RECREATION AND LEISURE ACTIVITIES; INFORMATION RELATING TO ENTERTAINMENT, PROVIDED ON-LINE FROM A COMPUTER DATABASE OR THE INTERNET (U.S. CLS. 100, 101 AND 107).

FIRST USE 8-1-2007; IN COMMERCE 8-1-2007.

CYNTHIA TRIPI, EXAMINING ATTORNEY

SN 77-490,512. HORIZON GROUP USA, INC., WARREN, NJ. FILED 6-4-2008.



THE MARK CONSISTS OF THE WORDS "NEXT STYLE" CONTAINED WITHIN AN OVAL.

CLASS 14—JEWELRY

FOR COSTUME JEWELRY, NAMELY, IRON-ON RHINESTONES AND IRON-ON RHINESTONE TRANSFERS; SHIRT STUDS BEING DECORATIVE EMBELLISHMENTS; DECORATIVE COSTUME JEWELRY EMBELLISHMENTS, NAMELY, ACRYLIC JEWELS AND STONES; IRON-ON DECORATIVE SHIRT STUDS (U.S. CLS. 2, 27, 28 AND 50).

CLASS 16—PAPER GOODS AND PRINTED MATTER

FOR IRON-ON TRANSFERS; APPLIQUÉS IN THE FORM OF DECALS; TEMPORARY TATTOOS; IRON-ON SEQUIN TRANSFERS; IRON-ON GLITTER TRANSFERS; IRON-ON MESH TRANSFERS; IRON-ON TRANSFERS IN THE FORM OF DECALS; ACTIVITY KIT FOR DECORATING CLOTHING COMPRISED OF IRON-ON TRANSFERS; ACTIVITY KIT FOR DECORATING SKIN COMPRISED OF TEMPORARY TATTOOS, MARKERS, STENCILS, ADHESIVE BACKED ACRYLIC DECORATIVE JEWELS AND GEMSTONES, AND GLITTER; ACTIVITY KIT FOR DECORATING FABRIC COMPRISED OF IRON-ON APPLIQUÉS IN THE NATURE OF DECALS, GLUE, ACRYLIC DECORATIVE GEMSTONES AND STUDS, SEQUIN PAILLETES, AND PAINT (U.S. CLS. 2, 5, 22, 23, 29, 37, 38 AND 50).

CLASS 18—LEATHER GOODS

FOR TOTE BAGS; HANDBAGS; BACKPACKS; WRISTLET BAGS; WALLETS; COIN PURSES; ACTIVITY KIT FOR DECORATING A COSMETIC BAG SOLD EMPTY, SLEEP EYE MASK AND COSMETIC MIRROR COVER, COMPRISED OF COSMETIC BAG SOLD EMPTY, SLEEP EYE MASK, COSMETIC MIRROR WITH COVER, IRON-ON TRANSFERS AND RHINESTONES, GLUE AND ACRYLIC DECORATIVE GEMSTONES (U.S. CLS. 1, 2, 3, 22 AND 41).

CLASS 25—CLOTHING

SN 77-492,288. HANNICO, LLC, NAPA, CA. FILED 6-5-2008.

FOR APRONS; ACTIVITY KIT FOR DECORATING FASHION ACCESSORIES COMPRISED OF A HEAD-BAND, BELT, BRACELET, NECKLACE, RIBBON, TAPE, GLUE, ACRYLIC DECORATIVE GEMSTONES AND BEADS; ACTIVITY KIT FOR DECORATING FASHION ACCESSORIES COMPRISED OF HAT, WALLET, IRON-ON APPLIQUES, TRANSFERS AND STUDS (U.S. CLS. 22 AND 39).

GET YOUR 'BUDS' DONE!**CLASS 26—FANCY GOODS**

FOR FABRIC FRINGE; FABRIC TRIM IN THE NATURE OF BEADED FRINGE; DECORATIVE TRIM IN THE NATURE OF RIBBON FRINGE; FABRIC APPLIQUES; DECORATIVE FABRIC EMBELLISHMENTS, NAMELY, APPLIQUES; DECORATIVE EMBELLISHMENTS, NAMELY, FABRIC APPLIQUES; IRON-ON DECORATIVE PRESS STUDS (U.S. CLS. 37, 39, 40, 42 AND 50).

THE MARK CONSISTS OF STANDARD CHARACTERS WITHOUT CLAIM TO ANY PARTICULAR FONT, STYLE, SIZE, OR COLOR.

MELISSA VALLILLO, EXAMINING ATTORNEY

CLASS 16—PAPER GOODS AND PRINTED MATTER

FOR PRINTED QUESTIONNAIRE USED TO DETERMINE FLAVOR AND TASTE PREFERENCES (U.S. CLS. 2, 5, 22, 23, 29, 37, 38 AND 50).

FIRST USE 1-19-2008; IN COMMERCE 1-19-2008.

CLASS 43—HOTEL AND RESTAURANT SERVICES

FOR ONLINE WEBSITE FEATURING INFORMATION ON FLAVOR AND TASTE PREFERENCES; ONLINE WEBSITE FEATURING A QUESTIONNAIRE USED TO DETERMINE FLAVOR AND TASTE PREFERENCES (U.S. CLS. 100 AND 101).

FIRST USE 1-19-2008; IN COMMERCE 1-19-2008.
SUNG IN, EXAMINING ATTORNEY

SN 77-491,896. BOCCHI HOLDING B.V., HONSELERSDIJK, NETHERLANDS, FILED 6-5-2008.

CAMPESITA

SN 77-493,890. BIRD BRAIN, INC., YPSILANTI, MI. FILED 6-9-2008.

THE MARK CONSISTS OF STANDARD CHARACTERS WITHOUT CLAIM TO ANY PARTICULAR FONT, STYLE, SIZE, OR COLOR.

THE TERM "CAMPESITA" IS FANCIFUL AND HAS NO MEANING IN A FOREIGN LANGUAGE.

FIREFOUNTAINS**CLASS 29—MEATS AND PROCESSED FOODS**

FOR DRIED, COOKED, DEEP-FROZEN, GRANULATED AND PULVERIZED FRUITS, NUTS AND VEGETABLES, NAMELY, CHESTNUTS, WALNUTS, HAZELNUTS, CASHEW NUTS, ALMONDS, PINE SEEDS, PISTACHIO NUTS, PEANUTS, RAISINS, FIGS, DATES AND RASPS OF COCONUTS, TROPICAL FRUITS AND BANANAS, RASPS OF COCONUTS (U.S. CL. 46).

FIRST USE 4-25-1997; IN COMMERCE 4-25-1997.

THE MARK CONSISTS OF STANDARD CHARACTERS WITHOUT CLAIM TO ANY PARTICULAR FONT, STYLE, SIZE, OR COLOR.

CLASS 31—NATURAL AGRICULTURAL PRODUCTS

FOR FRESH AND UNPROCESSED FRUITS, NUTS AND VEGETABLES, NAMELY, CHESTNUTS, WALNUTS, HAZELNUTS, CASHEW NUTS, ALMONDS, PINE SEEDS, PISTACHIO NUTS, PEANUTS, RAISINS, FIGS, DATES, TROPICAL FRESH FRUITS AND BANANAS (U.S. CLS. 1 AND 46).

FIRST USE 4-25-1997; IN COMMERCE 4-25-1997.
JOHN WILKE, EXAMINING ATTORNEY**CLASS 4—LUBRICANTS AND FUELS**

FOR CANDLE TORCHES; PATIO TORCHES (U.S. CLS. 1, 6 AND 15).

CLASS 11—ENVIRONMENTAL CONTROL APPARATUS

FOR DECORATIVE TABLE-TOP WATER FOUNTAINS; DECORATIVE WATER FOUNTAINS; ORNAMENTAL FOUNTAINS (U.S. CLS. 13, 21, 23, 31 AND 34).

FRED MANDIR, EXAMINING ATTORNEY

SN 77-494,055. OSIRIS INC., BRAMPTON, CANADA, FILED 6-9-2008.

SN 77-497,819. YOUNTVILLE PARTNERS, INC., NAPA, CA. FILED 6-12-2008.



OWNER OF CANADA REG. NO. TMA712,400, DATED 4-22-2008, EXPIRES 4-22-2023.

THE MARK CONSISTS OF THE WORD "QUANTUM" IN LOWER-CASE, STYLIZED CHARACTERS THAT ARE SURROUNDED BY A PENUMBRA, SAVE FOR THE INITIAL LETTER, WHICH IS UPPER CASE AND ENCIRCLED.

CLASS 9—ELECTRICAL AND SCIENTIFIC APPARATUS

FOR ELECTRIC HAIR STRAIGHTENER (U.S. CLS. 21, 23, 26, 36 AND 38).

CLASS 10—MEDICAL APPARATUS

FOR MASSAGE CHAIRS (U.S. CLS. 26, 39 AND 44).

CLASS 11—ENVIRONMENTAL CONTROL APPARATUS

FOR CHEMICALLY-ACTIVATED HEATING PACKS FOR PROVIDING WARMTH TO THE BODY NOT FOR MEDICAL PURPOSES (U.S. CLS. 13, 21, 23, 31 AND 34).
ESTHER BELENKER, EXAMINING ATTORNEY

SN 77-496,163. GEORGE P. JOHNSON COMPANY, AUBURN HILLS, MI. FILED 6-11-2008.

GEORGE P. JOHNSON

THE MARK CONSISTS OF STANDARD CHARACTERS WITHOUT CLAIM TO ANY PARTICULAR FONT, STYLE, SIZE, OR COLOR.

THE NAME "GEORGE P. JOHNSON" DOES NOT IDENTIFY A LIVING INDIVIDUAL.

CLASS 35—ADVERTISING AND BUSINESS

FOR ARRANGING, DESIGNING, AND CONDUCTING TRADE SHOW EXHIBITS FOR OTHERS IN ALL FIELDS; MANAGEMENT AND BUSINESS CONSULTING SERVICES IN THE FIELD OF EVENT PLANNING FOR OTHERS; PROVIDING MARKETING AND PROMOTION OF EVENTS FOR OTHERS; AND PROVIDING OFFICE SUPPORT STAFF SERVICES, NAMELY PROVIDING ADMINISTRATIVE AND BUSINESS SUPPORT SERVICES TO EVENT ORGANIZERS AND EXHIBITORS AT TRADE SHOWS (U.S. CLS. 100, 101 AND 102).

FIRST USE 12-31-1938; IN COMMERCE 12-31-1938.

CLASS 41—EDUCATION AND ENTERTAINMENT

FOR SPECIAL EVENT PLANNING CONSULTATION; ARRANGING AND CONDUCTING SPECIAL EVENTS (U.S. CLS. 100, 101 AND 107).

FIRST USE 12-31-1938; IN COMMERCE 12-31-1938.
SKYE YOUNG, EXAMINING ATTORNEY

25° BRIX

THE MARK CONSISTS OF STANDARD CHARACTERS WITHOUT CLAIM TO ANY PARTICULAR FONT, STYLE, SIZE, OR COLOR.

OWNER OF U.S. REG. NOS. 2,070,071, 2,857,741 AND 3,005,545.

CLASS 29—MEATS AND PROCESSED FOODS

FOR FRUIT PRESERVES; OLIVE OILS (U.S. CL. 46).

CLASS 30—STAPLE FOODS

FOR BAKERY GOODS; BAKERY PRODUCTS; BREAD; SALAD DRESSINGS (U.S. CL. 46).

CLASS 35—ADVERTISING AND BUSINESS

FOR RETAIL STORE SERVICES FEATURING WINES, WINE ACCESSORIES, CLOTHING, BOOKS, FOODS AND GIFTS; RETAIL GIFT SHOPS (U.S. CLS. 100, 101 AND 102).

CLASS 39—TRANSPORTATION AND STORAGE

FOR WINE CLUB SERVICES FEATURING PERIODIC SHIPMENTS OF WINE TO MEMBERS (U.S. CLS. 100 AND 105).

CLASS 43—HOTEL AND RESTAURANT SERVICES

FOR RESTAURANT SERVICES; TAKE-OUT RESTAURANT SERVICES; CATERING; BAR SERVICES (U.S. CLS. 100 AND 101).

THEODORE MCBRIDE, EXAMINING ATTORNEY

SN 77-498,153. SHERYL MCKANAS, MELROSE, MA. FILED 6-13-2008.

SHARINGMYLASTWORDS.COM

THE MARK CONSISTS OF STANDARD CHARACTERS WITHOUT CLAIM TO ANY PARTICULAR FONT, STYLE, SIZE, OR COLOR.

CLASS 38—COMMUNICATION

FOR ELECTRONIC DELIVERY OF SELF-WRITTEN EULOGIES, OBITUARIES, PERSONAL LETTERS, CARDS, PHOTOGRAPHS AND VIDEOS BY ELECTRONIC TRANSMISSION (U.S. CLS. 100, 101 AND 104).

CLASS 41—EDUCATION AND ENTERTAINMENT

FOR ON-LINE PUBLICATION SERVICES, NAMELY, BLOGS, PHOTOS AND VIDEOS FEATURING MEMORIALS AND OTHER MESSAGES RELATED TO PETS (U.S. CLS. 100, 101 AND 107).

CHRISTINA SOBRAL, EXAMINING ATTORNEY

SN 77-502,848. BEAMAX BVBA, OVERPELT, BELGIUM, FILED 6-19-2008.

BEAMAX

THE MARK CONSISTS OF STANDARD CHARACTERS WITHOUT CLAIM TO ANY PARTICULAR FONT, STYLE, SIZE, OR COLOR.

OWNER OF BELGIUM REG. NO. 0725014, DATED 9-12-2002, EXPIRES 9-12-2012.

THE MARK "BEAMAX" HAS NO MEANING IN A FOREIGN LANGUAGE.

CLASS 9—ELECTRICAL AND SCIENTIFIC APPARATUS

FOR PROJECTION SCREENS; PROJECTOR MOUNTS; PROJECTION SCREEN ACCESSORIES, NAMELY, REMOTE CONTROLS AND REMOTE CONTROL RECEIVERS (U.S. CLS. 21, 23, 26, 36 AND 38).

CLASS 35—ADVERTISING AND BUSINESS

FOR WHOLESALE AND RETAIL STORE SERVICES FEATURING PROJECTION SCREENS AND ACCESSORIES; WHOLESALE DISTRIBUTORSHIPS FEATURING PROJECTION SCREENS AND ACCESSORIES; ON-LINE WHOLESALE AND RETAIL STORE SERVICES FEATURING PROJECTION SCREENS AND ACCESSORIES (U.S. CLS. 100, 101 AND 102).

TRACY CROSS, EXAMINING ATTORNEY

SN 77-503,098. THE PARENTING GROUP, INC., WINTER PARK, FL. FILED 6-19-2008.



The Parenting Group

OWNER OF U.S. REG. NOS. 1,578,948, 2,026,010 AND 2,715,993.

THE COLOR(S) KELLY GREEN AND TEAL IS/ARE CLAIMED AS A FEATURE OF THE MARK.

THE MARK CONSISTS OF THE LETTERING "TPG", ABOVE THE WORDING "THE PARENTING GROUP". THE COLOR KELLY GREEN APPEARS IN THE LETTERS "T" AND "G". THE COLOR TEAL APPEARS IN THE LETTER "P" AND IN THE WORDING "THE PARENTING GROUP".

SEC. 2(F) "THE PARENTING GROUP" .

CLASS 41—EDUCATION AND ENTERTAINMENT

FOR PROVIDING INFORMATION IN THE FIELD OF EDUCATIONAL AND ENTERTAINMENT ACTIVITIES AND EVENTS FOR CHILDREN VIA A GLOBAL COMPUTER NETWORK; PROVIDING INFORMATION IN THE FIELD OF PHYSICAL EXERCISE VIA A GLOBAL COMPUTER NETWORK; ENTERTAINMENT IN THE NATURE OF ONGOING TELEVISION PROGRAMS IN THE FIELDS OF HEALTH, PREGNANCY, PRE-NATAL AND POST-NATAL CARE, CHILD BIRTH, BABY CARE, DIET, EXERCISE AND FEATURING OTHER INFORMATION FOR AND ABOUT PARENTS AND EXPECTANT PARENTS; PUBLICATION OF MARKET RESEARCH AND MARKETING STUDY RESULTS; ELECTRONIC PUBLISHING SERVICES, NAMELY, PUBLICATION OF MARKET RESEARCH AND MARKETING STUDY RESULTS ONLINE (U.S. CLS. 100, 101 AND 107).

CLASS 43—HOTEL AND RESTAURANT SERVICES

FOR PROVIDING INFORMATION ON CHILD CARE VIA A GLOBAL COMPUTER NETWORK (U.S. CLS. 100 AND 101).

CLASS 44—MEDICAL, BEAUTY AND AGRICULTURAL SERVICES

FOR PROVIDING INFORMATION VIA A GLOBAL COMPUTER NETWORK IN THE FIELDS OF HEALTH, DIETARY SUPPLEMENTS, NUTRITION, AND MEDICAL CARE RELATING TO PREGNANCY, CHILD BIRTH, BABY CARE, AND PRE-NATAL AND POST-NATAL CARE; PROVIDING PARENTING INFORMATION CONCERNING THE HEALTH OF CHILDREN VIA A GLOBAL COMPUTER NETWORK (U.S. CLS. 100 AND 101).

CLASS 45—PERSONAL AND LEGAL SERVICES

FOR PROVIDING INFORMATION VIA A GLOBAL COMPUTER NETWORK IN THE FIELD OF CHILD SAFETY; PROVIDING INFORMATION VIA A GLOBAL COMPUTER NETWORK IN THE FIELD OF PARENTING CONCERNING INTRAFAMILY RELATIONSHIPS (U.S. CLS. 100 AND 101).

KIM MONINGHOFF, EXAMINING ATTORNEY

SN 77-503,278. LELY PATENT N.V., 3147 PA MAASSLUIJ, NETHERLANDS, FILED 6-19-2008.

QWES

THE MARK CONSISTS OF STANDARD CHARACTERS WITHOUT CLAIM TO ANY PARTICULAR FONT, STYLE, SIZE, OR COLOR.

OWNER OF BENELUX REG. NO. 0809088, DATED 10-11-2006, EXPIRES 10-11-2016.

CLASS 9—ELECTRICAL AND SCIENTIFIC APPARATUS

FOR ACCELERATION SENSORS TO MEASURE THE RUMINATION OF THE COW TOGETHER WITH THEIR ACTIVITY; COMPUTER APPARATUS AND SOFTWARE RELATED TO AND AS PART OF A COW IDENTIFICATION SYSTEM (U.S. CLS. 21, 23, 26, 36 AND 38).

CLASS 18—LEATHER GOODS

FOR COLLARS FOR ANIMALS; COLLARS INCORPORATING ELECTRONIC IDENTIFICATION MEANS (U.S. CLS. 1, 2, 3, 22 AND 41).

DOMINIC J. FERRAIUOLO, EXAMINING ATTORNEY

SN 77-504,223. ABBOTT LABORATORIES, ABBOTT PARK, IL. FILED 6-20-2008.

SN 77-503,774. SUMMIT PLASTIC COMPANY, AKRON, OH. FILED 6-20-2008.

Eco360

THE MARK CONSISTS OF STANDARD CHARACTERS WITHOUT CLAIM TO ANY PARTICULAR FONT, STYLE, SIZE, OR COLOR.

CLASS 20—FURNITURE AND ARTICLES NOT OTHERWISE CLASSIFIED

FOR NON-METAL MULTI-PARTITIONED INSERTS FOR USE IN HORTICULTURAL FLATS AND HANDLERS (U.S. CLS. 2, 13, 22, 25, 32 AND 50).

CLASS 21—HOUSEWARES AND GLASS

FOR NON-METAL HORTICULTURAL TRAYS AND POTS (U.S. CLS. 2, 13, 23, 29, 30, 33, 40 AND 50).
REBECCA SMITH, EXAMINING ATTORNEY

SN 77-504,061. BOCHASANWASI SHRI AKSHAR PURUSHOTTAM SWAMINARAYAN SANSTHA, INC., PISCATAWAY, NJ. FILED 6-20-2008.

AKSHAR

THE MARK CONSISTS OF STANDARD CHARACTERS WITHOUT CLAIM TO ANY PARTICULAR FONT, STYLE, SIZE, OR COLOR.

CLASS 3—COSMETICS AND CLEANING PREPARATIONS

FOR HERBAL PRODUCTS FOR BODY AND BEAUTY CARE, NAMELY, SOAPS, HAIR OILS, HAIR SHAMPOOS AND CONDITIONERS, SKIN CREAMS, MOISTURIZERS, LOTIONS, COSMETICS, PERFUMES, PERSONAL DEODORANTS, ESSENTIAL OILS, SHOWER GELS, BATH OILS, MAKE-UP REMOVING PREPARATIONS, DENTIFRICES, TOOTHPASTES, BEAUTY MASKS AND FACIAL SCRUBS (U.S. CLS. 1, 4, 6, 50, 51 AND 52).

CLASS 5—PHARMACEUTICALS

FOR DIETARY SUPPLEMENTS, MINERAL SUPPLEMENTS, NUTRITIONAL SUPPLEMENTS, HERBAL SUPPLEMENTS FOR MEDICINAL AND THERAPEUTIC PURPOSES; HERBAL TEAS FOR MEDICINAL PURPOSES; ALLOPATHIC, HOMEOPATHIC, NATUROPATHIC AND AYURVEDIC MEDICINES (U.S. CLS. 6, 18, 44, 46, 51 AND 52).
KELLY MCCOY, EXAMINING ATTORNEY

NOT IN MY HOUSE

THE MARK CONSISTS OF STANDARD CHARACTERS WITHOUT CLAIM TO ANY PARTICULAR FONT, STYLE, SIZE, OR COLOR.

CLASS 16—PAPER GOODS AND PRINTED MATTER

FOR PRINTED PUBLICATIONS, NAMELY, MAGAZINES, BROCHURES, LEAFLETS ON THE SUBJECT OF PRESCRIPTION DRUG ABUSE (U.S. CLS. 2, 5, 22, 23, 29, 37, 38 AND 50).

CLASS 41—EDUCATION AND ENTERTAINMENT

FOR EDUCATIONAL SERVICES, NAMELY, PROVIDING BOTH LIVE AND ON-LINE CLASSES, CONFERENCES, SEMINARS, WORKSHOPS ON THE TOPIC OF PRESCRIPTION DRUG ABUSE (U.S. CLS. 100, 101 AND 107).
MARTHA SANTOMARTINO, EXAMINING ATTORNEY

SN 77-507,970. YOOSTAR ENTERTAINMENT GROUP, INC., NEW YORK, NY. FILED 6-25-2008.

YOOSTAR

THE MARK CONSISTS OF STANDARD CHARACTERS WITHOUT CLAIM TO ANY PARTICULAR FONT, STYLE, SIZE, OR COLOR.

CLASS 9—ELECTRICAL AND SCIENTIFIC APPARATUS

FOR DIGITAL ENTERTAINMENT SYSTEM, NAMELY, A DIGITAL CAMERA, COMPUTER INTERFACE, AND COMPUTER SOFTWARE FOR USE IN PLACING A USER'S LIKENESS AND VOICE INTO SCENES FROM MOVIES, TELEVISION SHOWS, MUSIC VIDEOS, AND OTHER SOURCES (U.S. CLS. 21, 23, 26, 36 AND 38).

CLASS 35—ADVERTISING AND BUSINESS

FOR ONLINE RETAIL STORE SERVICES FEATURING SCENES FROM MOVIES, TELEVISION, MUSIC VIDEOS AND OTHER SOURCES FOR PURCHASE, AS WELL AS DVDS, AND MOVIE AND MUSIC RELATED MERCHANDISE (U.S. CLS. 100, 101 AND 102).

CLASS 42—SCIENTIFIC AND COMPUTER SERVICES

FOR PROVIDING AN INTERACTIVE COMPUTER WEB SITE WHEREBY USERS ARE PERMITTED TO SEARCH, SELECT, AND VIEW SCENES FROM MOVIES, TELEVISION, MUSIC VIDEOS AND OTHER SOURCES, DOWNLOAD SUPPORT SOFTWARE, CREATE, VIEW, SHARE, TRADE AND STORE USER-CREATED VIDEOS, AND TO COMMENT UPON AND SHARE COMMENTARY ON USER-CREATED VIDEOS AND GENERAL MOVIE OR VIDEO CONTENT (U.S. CLS. 100 AND 101).
KELLY MCCOY, EXAMINING ATTORNEY

CLASS 39—TRANSPORTATION AND STORAGE

FOR TRAVEL AGENCY SERVICES, NAMELY, MAKING RESERVATIONS AND BOOKINGS FOR TRANSPORTATION (U.S. CLS. 100 AND 105).
FIRST USE 6-1-2008; IN COMMERCE 6-1-2008.

CLASS 43—HOTEL AND RESTAURANT SERVICES

FOR TRAVEL AGENCY SERVICES, NAMELY, MAKING RESERVATIONS AND BOOKINGS FOR TEMPORARY LODGINGS (U.S. CLS. 100 AND 101).
FIRST USE 6-1-2008; IN COMMERCE 6-1-2008.
SUZANNE BLANE, EXAMINING ATTORNEY

SN 77-508,069. THE MARK TRAVEL CORPORATION, MILWAUKEE, WI. FILED 6-25-2008.



OWNER OF U.S. REG. NO. 3,506,133.
THE COLOR(S) RED, ORANGE, GREEN, YELLOW, BLUE, PURPLE, AND GREY IS/ARE CLAIMED AS A FEATURE OF THE MARK.
THE MARK CONSISTS OF OF A PERSON WITH A RED HEAD, GREEN BODY, YELLOW RIGHT ARM, ORANGE LEFT ARM, BLUE LEFT LEG, AND PURPLE RIGHT LEG OVER A CIRCLE WITH A GRID IN GREY. THE WORDING "FABUGO.COM" IN BLUE IS TO THE RIGHT OF THE CIRCLE AND THE WORDING "BOOK EASY, TRAVEL PROUD" IN ORANGE APPEARS BELOW THE WORDING "FABUGO.COM".

SN 77-508,439. SUMMIT PLASTIC COMPANY, AKRON, OH. FILED 6-26-2008.

CLASS 39—TRANSPORTATION AND STORAGE

FOR TRAVEL AGENCY SERVICES, NAMELY, MAKING RESERVATIONS AND BOOKINGS FOR TRANSPORTATION (U.S. CLS. 100 AND 105).
FIRST USE 6-1-2008; IN COMMERCE 6-1-2008.



CLASS 43—HOTEL AND RESTAURANT SERVICES

FOR TRAVEL AGENCY SERVICES, NAMELY, MAKING RESERVATIONS AND BOOKINGS FOR TEMPORARY LODGINGS (U.S. CLS. 100 AND 101).
FIRST USE 6-1-2008; IN COMMERCE 6-1-2008.
SUZANNE BLANE, EXAMINING ATTORNEY

SN 77-508,075. THE MARK TRAVEL CORPORATION, MILWAUKEE, WI. FILED 6-25-2008.



OWNER OF U.S. REG. NO. 3,506,133.
THE COLOR(S) RED, ORANGE, GREEN, YELLOW, BLUE, PURPLE, AND GREY IS/ARE CLAIMED AS A FEATURE OF THE MARK.
THE MARK CONSISTS OF A PERSON WITH A RED HEAD, GREEN BODY, YELLOW RIGHT ARM, ORANGE LEFT ARM, BLUE LEFT LEG, AND PURPLE RIGHT LEG OVER A CIRCLE WITH A GRID IN GREY. THE WORDING "FABUGO.COM" IN BLUE IS TO THE RIGHT OF THE CIRCLE.

NO CLAIM IS MADE TO THE EXCLUSIVE RIGHT TO USE "PLASTIC COMPANY", APART FROM THE MARK AS SHOWN.
THE MARK CONSISTS OF THE LETTERS "ECO" ABOVE THE NUMBER "360" INSIDE A SHADED CIRCLE THAT IS SPLIT IN HALF WITH THE WORDS "SUMMIT PLASTIC COMPANY" CURVED AROUND THE OUTSIDE OF THE CIRCLE ON THE BOTTOM RIGHT.

CLASS 20—FURNITURE AND ARTICLES NOT OTHERWISE CLASSIFIED

FOR NON-METAL MULTI-PARTITIONED INSERTS FOR USE IN HORTICULTURAL FLATS AND HANDLERS (U.S. CLS. 2, 13, 22, 25, 32 AND 50).

CLASS 21—HOUSEWARES AND GLASS

FOR NON-METAL HORTICULTURAL TRAYS AND POTS (U.S. CLS. 2, 13, 23, 29, 30, 33, 40 AND 50).
REBECCA SMITH, EXAMINING ATTORNEY

SN 77-508,929. INTEGRATED AMERICA, INC., PURCHASE, NY. FILED 6-26-2008.

SN 77-509,938. TABOR, AARON T., WINSTON-SALEM, NC. FILED 6-27-2008.

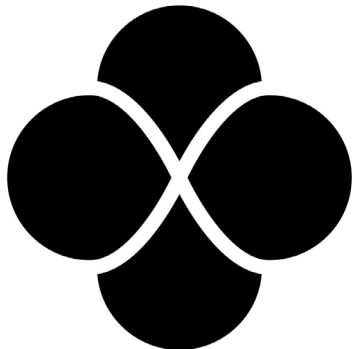

OWNER OF U.S. REG. NOS. 1,792,019 AND 3,219,516. THE MARK CONSISTS OF A HORIZONTAL INFINITY DESIGN OVERLAYING A VERTICAL OVAL DESIGN.

CLASS 35—ADVERTISING AND BUSINESS

FOR CONSULTING SERVICES IN THE FIELDS OF MEDICAL MARKETING, ADVERTISING, AND PROMOTION; BUSINESS CONSULTING SERVICES IN THE FIELD OF DEVELOPING MEDICAL PRACTICES; PROVIDING BUSINESS ADMINISTRATION, BUSINESS MANAGEMENT AND BUSINESS CONSULTATION FOR HEALTHCARE PROVIDERS IN VEIN DISEASE CLINICS, IN VITRO FERTILIZATION CLINICS AND LABORATORIES ASSOCIATED WITH SUCH CLINICS; BUSINESS DEVELOPMENT SERVICES FOR OTHERS, NAMELY, PROVIDING START-UP SUPPORT FOR HEALTHCARE PROVIDERS IN VEIN DISEASE CLINICS, IN VITRO FERTILIZATION CLINICS AND LABORATORIES ASSOCIATED WITH SUCH CLINICS; BUSINESS MARKETING CONSULTATION FOR IN VITRO FERTILIZATION CLINICS; BUSINESS MANAGEMENT CONSULTING SERVICES AND BUSINESS RISK MANAGEMENT CONSULTING SERVICES FOR IN VITRO FERTILIZATION CLINICS (U.S. CLS. 100, 101 AND 102).

FIRST USE 5-15-2008; IN COMMERCE 5-15-2008.

CLASS 36—INSURANCE AND FINANCIAL

FOR PROVIDING FINANCIAL MANAGEMENT REGARDING MEDICAL PRACTICES; FINANCIAL SERVICES FOR OTHERS, NAMELY, ADVISING REGARDING THE FINANCING OF MEDICAL SERVICES (U.S. CLS. 100, 101 AND 102).

FIRST USE 4-30-2008; IN COMMERCE 4-30-2008.

CLASS 42—SCIENTIFIC AND COMPUTER SERVICES

FOR COMPUTER CONSULTATION SERVICES FOR IN VITRO FERTILIZATION CLINICS (U.S. CLS. 100 AND 101).

FIRST USE 6-16-2008; IN COMMERCE 6-16-2008.

CLASS 44—MEDICAL, BEAUTY AND AGRICULTURAL SERVICES

FOR MEDICAL SERVICES IN THE FIELD OF HUMAN FERTILITY; MEDICAL SERVICES, NAMELY, DIAGNOSIS AND TREATMENT OF VEIN DISEASES AND DISORDERS (U.S. CLS. 100 AND 101).

FIRST USE 6-16-2008; IN COMMERCE 6-16-2008.
LANA PHAM, EXAMINING ATTORNEY

Dr. Tabor's Diet

THE MARK CONSISTS OF STANDARD CHARACTERS WITHOUT CLAIM TO ANY PARTICULAR FONT, STYLE, SIZE, OR COLOR.

NO CLAIM IS MADE TO THE EXCLUSIVE RIGHT TO USE "DIET", APART FROM THE MARK AS SHOWN.

THE NAME(S), PORTRAIT(S), AND/OR SIGNATURE(S) SHOWN IN THE MARK IDENTIFIES DR. AARON T. TABOR, WHOSE CONSENT(S) TO REGISTER IS MADE OF RECORD.

CLASS 5—PHARMACEUTICALS

FOR FOOD SUPPLEMENTS, VITAMINS, MINERAL SUPPLEMENTS, NUTRITIONAL SUPPLEMENTS, DIETARY SUPPLEMENTS, MEAL REPLACEMENT AND DIETARY SUPPLEMENT DRINK MIXES, AND MEAL REPLACEMENT POWDERS, SOME OF WHICH CONTAIN MILK, SOY AND/OR WHEY (U.S. CLS. 6, 18, 44, 46, 51 AND 52).

CLASS 16—PAPER GOODS AND PRINTED MATTER

FOR BOOKS, PRINTED GUIDES, COOKBOOKS AND BROCHURES FEATURING TOPICS RELATING TO WEIGHT LOSS, WEIGHT CONTROL, WEIGHT MAINTENANCE, NUTRITION, MENU PLANNING, RECIPES, FITNESS, DIET AND NUTRITION INFORMATION FOR THE PREVENTION OF CORONARY HEART DISEASES (U.S. CLS. 2, 5, 22, 23, 29, 37, 38 AND 50).

CLASS 29—MEATS AND PROCESSED FOODS

FOR PREPARED ENTREES, SIDE DISHES AND MEALS CONSISTING PRIMARILY OF MEAT, SEA-FOOD, POULTRY OR VEGETABLES; PREPARED DINNERS CONSISTING OF MEAT SUBSTITUTES; PROCESSED MEAT, NAMELY, HAM, POULTRY OR BEEF VEGETABLE BASED READY TO EAT FOOD BARS, PROTEIN BASED READY TO EAT FOOD BARS, PROTEIN BASED NUTRIENT DENSE SNACK BARS; SUGAR-FREE PEANUT BUTTER, BUTTER SUBSTITUTES; SUGAR-FREE AND LOW SUGAR JAMS, JELLIES, AND FRUIT SPREADS; FRUIT TOPPINGS, WHIPPED TOPPINGS, NUT TOPPINGS; COOKING OILS, OLIVE OIL, CANOLA OIL, VEGETABLE OIL, MAYONNAISE, SOUR CREAM, PROCESSED NUTS; SNACK MIX CONSISTING PRIMARILY OF PROCESSED FRUITS, PROCESSED NUTS AND/OR RAISINS; YOGURT, CHEESE, CHEESE SPREADS, CHEESE AND CRACKER COMBINATIONS; FOOD PACKAGE COMBINATIONS CONSISTING PRIMARILY OF CHEESE, MEAT AND/OR PROCESSED FRUIT; SOME OF WHICH FOOD PRODUCTS CONTAIN MILK, SOY AND/OR WHEY (U.S. CL. 46).

CLASS 30—STAPLE FOODS

FOR READY TO EAT FOOD BARS AND SNACKS FOODS MADE WITH WHOLE GRAINS; READY TO EAT CEREAL DERIVED FOOD BARS; GRANOLA BASED SNACK BARS; OATMEAL; WHOLE GRAIN PASTAS, WHOLE GRAIN BREAKFAST CEREALS, BREAKFAST CEREALS, PROCESSED CEREALS, WHOLE GRAIN MUFFIN MIXES, AND WHOLE GRAIN PANCAKE MIXES; SUGAR-FREE CHOCOLATE, CHOCOLATES, SUGAR-FREE CHOCOLATE POWDER, COCOA POWDER, SUGAR-FREE CANDY, SUGAR-FREE GUM, SUGAR-FREE FLAVORED GELATIN, SWEETENED FLAVORED GELATIN DESSERTS, FAT-FREE AND SUGAR-FREE PUDDING, PUDDINGS, CHEESECAKE, SUGAR SUBSTITUTES, SALAD DRESSINGS, SALSA, SAUCES, SEASONINGS, SPICES; SUGAR-FREE DESSERTS, NAMELY, SUGAR-FREE COOKIES, CARAMEL CORN, PIES, CAKES, CHEESECAKES, BROWNIES, MARSHMALLOW TOPPING, CHOCOLATE TOPPING, CHOCOLATE SYRUP, FLAVORING SYRUP, TOPPING SYRUP AND BAKERY DESSERTS; SUGAR-FREE FROZEN CONFECTIONS, MARSHMALLOW TOPPING, CHOCOLATE TOPPING, CHOCOLATE SYRUP, FLAVORING SYRUP, TOPPING SYRUP, COOKIES, CRACKERS, POPPED POPCORN, CARAMEL POPCORN, RICE CAKES, PRETZELS, CHEESE FLAVORED PUFFED CORN SNACKS; CHEESE FLAVORED SNACKS, NAMELY, CHEESE CURLS; SNACK MIX CONSISTING PRIMARILY OF CRACKERS, PRETZELS, CANDIED NUTS AND/OR POPPED CORN; PIZZA; AND SANDWICHES; SOME OF WHICH PRODUCTS CONTAIN MILK, SOY AND/OR WHEY (U.S. CL. 46).

CLASS 35—ADVERTISING AND BUSINESS

FOR TELEPHONE AND MAIL ORDER CATALOGUE SERVICES, ONLINE CATALOGUE ORDER SERVICES VIA THE INTERNET, ALL FEATURING BOOKS, COOKBOOKS, FOODS, DIETARY PREPARATIONS, NUTRITIONAL SUPPLEMENTS, FOOD AND DRINK MIXES AND VITAMINS (U.S. CLS. 100, 101 AND 102).

CLASS 44—MEDICAL, BEAUTY AND AGRICULTURAL SERVICES

FOR PROVIDING A WEB SITE FEATURING INFORMATION ABOUT WEIGHT LOSS, WEIGHT CONTROL AND MAINTENANCE, DIET, MEAL PLANNING, NUTRITION AND HEALTH (U.S. CLS. 100 AND 101).

RONALD AIKENS, EXAMINING ATTORNEY

SN 77-510,065. NETWORK ENVIRONMENTAL SYSTEMS, INCORPORATED, FOLSOM, CA. FILED 6-27-2008.



THE MARK CONSISTS OF THE LETTERS "NES" WITH GLOBAL GRIDLINES IN BACKGROUND.

CLASS 16—PAPER GOODS AND PRINTED MATTER

FOR NEWSLETTERS IN THE FIELDS OF HAZARDS, SAFETY EQUIPMENT, MANUFACTURING METHODS, ISSUES CONCERNING METHAMPHETAMINE AND ILLEGAL CLANDESTINE DRUG LABS AND LAW ENFORCEMENT AND FIRST RESPONDERS SAFETY (U.S. CLS. 2, 5, 22, 23, 29, 37, 38 AND 50).

CLASS 41—EDUCATION AND ENTERTAINMENT

FOR EDUCATIONAL SERVICES, NAMELY, THE OFFERING OF WEB BASED AND ON-SITE TRAINING IN ENVIRONMENTAL HEALTH AND SAFETY FOR PRIVATE INDUSTRY AND PUBLIC AGENCIES (U.S. CLS. 100, 101 AND 107).

CLASS 42—SCIENTIFIC AND COMPUTER SERVICES

FOR CONSULTING SERVICES IN THE FIELD OF ENVIRONMENTAL HEALTH AND SAFETY, NAMELY, ENVIRONMENTAL ASSESSMENT, COMPLIANCE AND PLANNING (U.S. CLS. 100 AND 101).

CLASS 45—PERSONAL AND LEGAL SERVICES

FOR CONSULTING SERVICES IN THE FIELD OF ENVIRONMENTAL HEALTH AND SAFETY, NAMELY, REVIEWING STANDARDS AND PRACTICES TO ASSURE COMPLIANCE WITH ENVIRONMENTAL LAWS AND REGULATIONS; LITIGATION SUPPORT AND EXPERT WITNESS SERVICES ON ENVIRONMENTAL ISSUES (U.S. CLS. 100 AND 101).

ANGELA GAW, EXAMINING ATTORNEY

SN 77-510,319. CYPRESS SYSTEMS CORPORATION, SAN JOSE, DE. FILED 6-27-2008.



THE MARK CONSISTS OF A LEAF DESIGN.

CLASS 9—ELECTRICAL AND SCIENTIFIC APPARATUS

FOR MOBILE COMPUTING AND OPERATING PLATFORMS CONSISTING OF DATA TRANSCEIVERS, WIRELESS NETWORKS AND GATEWAYS FOR COLLECTION AND MANAGEMENT OF DATA; WIRELESS CONTROLLER TO MONITOR AND CONTROL THE FUNCTIONALITY OF OTHER ELECTRICAL DEVICES; WIRELESS GAUGE READERS; WIRELESS DATA RECEIVERS; WIRELESS TRANSDUCER READERS; COMPUTER DATA SERVERS AND MODEMS (U.S. CLS. 21, 23, 26, 36 AND 38).

CLASS 37—CONSTRUCTION AND REPAIR

FOR INSTALLATION AND MAINTENANCE SERVICES FOR MOBILE COMPUTING AND OPERATING PLATFORMS, WIRELESS CONTROLLERS, WIRELESS GAUGE READERS, WIRELESS DATA RECEIVERS, WIRELESS TRANSDUCER READERS, DATA SERVERS AND MODEMS (U.S. CLS. 100, 103 AND 106).

EVELYN BRADLEY, EXAMINING ATTORNEY

SN 77-511,097. RICH PRODUCTS CORPORATION, BUFFALO, NY. FILED 6-30-2008.

ONE BODY, ONE PLANET, EAT
WELL

THE MARK CONSISTS OF STANDARD CHARACTERS WITHOUT CLAIM TO ANY PARTICULAR FONT, STYLE, SIZE, OR COLOR.

CLASS 29—MEATS AND PROCESSED FOODS

FOR HEMP MILK USED AS A MILK SUBSTITUTE (U.S. CL. 46).

CLASS 30—STAPLE FOODS

FOR BAKERY GOODS, NAMELY, BREADS, ROLLS, TORTILLAS, SANDWICH WRAPS, PASTRIES; DESSERTS; AND PAR-BAKED PIZZA CRUST (U.S. CL. 46). TRACY CROSS, EXAMINING ATTORNEY

SN 77-512,272. SALLY HERSHBERGER PROFESSIONAL HAIR CARE, LLC, NEW YORK, NY. FILED 7-1-2008.

SUPREME HEAD

THE MARK CONSISTS OF STANDARD CHARACTERS WITHOUT CLAIM TO ANY PARTICULAR FONT, STYLE, SIZE, OR COLOR.

OWNER OF U.S. REG. NO. 3,490,128.

CLASS 3—COSMETICS AND CLEANING PREPARATIONS

FOR COSMETICS, NAMELY, LIPSTICK, EYE MAKEUP, FACIAL MAKEUP, EYE CREAM, EYE MAKEUP REMOVER, EYE SHADOW, EYEBROW PENCILS, COSMETIC PENCILS, EYELINER, MASCARA, ROUGE, BLUSH, FOUNDATION, POWDER, CONCEALER, LIP GLOSS, LIP LINER, LIP PENCILS, LIP BALM, NAIL POLISH, NAIL POLISH REMOVER, AND SKIN CREAMS AND LOTIONS (U.S. CLS. 1, 4, 6, 50, 51 AND 52).

CLASS 16—PAPER GOODS AND PRINTED MATTER

FOR NON-FICTION BOOKS AND MAGAZINES IN THE FIELDS OF FASHION, HAIR CUTTING AND STYLING, MAKE-UP, SKIN CARE, DECORATING, RELATIONSHIPS, WOMEN'S ISSUES, HEALTH AND EXERCISE (U.S. CLS. 2, 5, 22, 23, 29, 37, 38 AND 50).

CLASS 21—HOUSEWARES AND GLASS

FOR HAIR BRUSHES, HAIR COMBS AND LIP BRUSHES (U.S. CLS. 2, 13, 23, 29, 30, 33, 40 AND 50).

CLASS 26—FANCY GOODS

FOR NON-ELECTRIC HAIR ROLLERS, HAIR BOWS, HAIR CLIPS, HAIR BANDS, HAIR TIES, HAIR GRIPS, HAIR NETS, HAIR PINS, HAIR RIBBONS, HAIR SLIDES AND HAIR ORNAMENTS (U.S. CLS. 37, 39, 40, 42 AND 50).

KARANENDRA S. CHHINA, EXAMINING ATTORNEY

SN 77-514,316. BLUE CROSS AND BLUE SHIELD OF SOUTH CAROLINA, COLUMBIA, SC. FILED 7-3-2008.

INSTIL HEALTH INCHOICE

THE MARK CONSISTS OF STANDARD CHARACTERS WITHOUT CLAIM TO ANY PARTICULAR FONT, STYLE, SIZE, OR COLOR.

OWNER OF U.S. REG. NOS. 3,143,408, 3,188,055 AND 3,442,268.

NO CLAIM IS MADE TO THE EXCLUSIVE RIGHT TO USE "HEALTH", APART FROM THE MARK AS SHOWN.

CLASS 35—ADVERTISING AND BUSINESS

FOR HEALTH CARE UTILIZATION MANAGEMENT AND UTILIZATION REVIEW SERVICES; COST MANAGEMENT FOR THE HEALTH CARE BENEFIT PLANS OF OTHERS; HEALTH CARE COST CONTAINMENT; HEALTH CARE COST REVIEW; MANAGED CARE SERVICES, NAMELY, ELECTRONIC PROCESSING OF HEALTH CARE INFORMATION (U.S. CLS. 100, 101 AND 102).

FIRST USE 5-31-2005; IN COMMERCE 5-31-2005.

CLASS 36—INSURANCE AND FINANCIAL

FOR HEALTH CARE AND PRESCRIPTION DRUG CLAIM ADMINISTRATION AND MANAGEMENT; HEALTH CARE AND PRESCRIPTION DRUG CLAIMS PROCESSING; PROVIDING HEALTH CARE AND PRESCRIPTION DRUG CLAIM INFORMATION; ADMINISTRATION OF PRE-PAID HEALTH CARE PLANS; UNDERWRITING HEALTH INSURANCE (U.S. CLS. 100, 101 AND 102).

FIRST USE 5-31-2005; IN COMMERCE 5-31-2008.

LINDA ESTRADA, EXAMINING ATTORNEY

SN 77-514,674. TRG THE RESPONSE GROUP LLC, HOUSTON, TX. FILED 7-3-2008.

DEVELOPED FOR RESPONDERS
BY RESPONDERS

THE MARK CONSISTS OF STANDARD CHARACTERS WITHOUT CLAIM TO ANY PARTICULAR FONT, STYLE, SIZE, OR COLOR.

NO CLAIM IS MADE TO THE EXCLUSIVE RIGHT TO USE "RESPONDERS", APART FROM THE MARK AS SHOWN.

CLASS 9—ELECTRICAL AND SCIENTIFIC APPARATUS

FOR COMPUTER SOFTWARE FOR USE IN CONNECTION WITH EMERGENCY RESPONSE PLANNING (U.S. CLS. 21, 23, 26, 36 AND 38).
FIRST USE 5-0-2007; IN COMMERCE 5-0-2007.

CLASS 42—SCIENTIFIC AND COMPUTER SERVICES

FOR APPLICATION SERVICE PROVIDER (ASP) FEATURING SOFTWARE FOR USE IN CONNECTION WITH EMERGENCY RESPONSE PLANNING (U.S. CLS. 100 AND 101).
FIRST USE 5-0-2007; IN COMMERCE 5-0-2007.
MARGARET POWER, EXAMINING ATTORNEY

SN 77-516,553. BIOBASED CHEMICALS, LLC, DBA BIO-BASED TECHNOLOGIES, LLC, FAYETTEVILLE, AR. FILED 7-8-2008.

BBT

THE MARK CONSISTS OF STANDARD CHARACTERS WITHOUT CLAIM TO ANY PARTICULAR FONT, STYLE, SIZE, OR COLOR.

CLASS 40—MATERIAL TREATMENT

FOR CUSTOM MANUFACTURE OF POLYOLS MADE FROM RENEWABLE RAW MATERIALS FOR OTHERS (U.S. CLS. 100, 103 AND 106).

CLASS 42—SCIENTIFIC AND COMPUTER SERVICES

FOR PRODUCT DEVELOPMENT FOR OTHERS IN THE FIELD OF POLYOLS MADE FROM RENEWABLE RAW MATERIALS (U.S. CLS. 100 AND 101).
TRACY CROSS, EXAMINING ATTORNEY

SN 77-517,247. STUDIO FRIDO, SAN ANTONIO, TX. FILED 7-8-2008.

**Art for the
Science-Inspired Mind**

THE MARK CONSISTS OF STANDARD CHARACTERS WITHOUT CLAIM TO ANY PARTICULAR FONT, STYLE, SIZE, OR COLOR.

CLASS 9—ELECTRICAL AND SCIENTIFIC APPARATUS

FOR DIGITAL MATERIALS, NAMELY, CDS, DVDS, AND ELECTRONIC MEMORY DEVICES FEATURING STILL IMAGES OF COMPUTED TOMOGRAPHY SCANS AND MOVIES ABOUT COMPUTED TOMOGRAPHY DERIVED IMAGES; DIGITAL PHOTO FRAMES FOR DISPLAYING DIGITAL PICTURES AND VIDEO CLIPS (U.S. CLS. 21, 23, 26, 36 AND 38).

CLASS 16—PAPER GOODS AND PRINTED MATTER

FOR PRINTED MATERIALS, NAMELY, DIGITALLY PRODUCED STILL IMAGE ART PRINTS, PICTORIAL PRINTS, PHOTOGRAPHIC PRINTS AND GRAPHIC PRINTS (U.S. CLS. 2, 5, 22, 23, 29, 37, 38 AND 50).
ANDREA K. NADELMAN, EXAMINING ATTORNEY

SN 77-517,430. RICK CONNOLLY, SCOTTSDALE, AZ. FILED 7-8-2008.



NO CLAIM IS MADE TO THE EXCLUSIVE RIGHT TO USE "RETROBOATS", APART FROM THE MARK AS SHOWN.
THE MARK CONSISTS OF THE WORD "RETROBOATS" INSIDE THE SHAPE OF A FIN.

CLASS 37—CONSTRUCTION AND REPAIR

FOR RESTORATION OF COMPOSITE WATERCRAFT FOR OTHERS (U.S. CLS. 100, 103 AND 106).

CLASS 40—MATERIAL TREATMENT

FOR CUSTOM MANUFACTURING FOR OTHERS IN THE FIELD OF COMPOSITE WATERCRAFTS (U.S. CLS. 100, 103 AND 106).
HELENE LIWINSKI, EXAMINING ATTORNEY

SN 77-517,474. CONNOLLY, RICK, SCOTTSDALE, AZ. FILED 7-8-2008.



NO CLAIM IS MADE TO THE EXCLUSIVE RIGHT TO USE "RETROBOATS", APART FROM THE MARK AS SHOWN.
THE MARK CONSISTS OF THE WORD "RETROBOATS" WITH A CRESCENT SHAPE OVER THE WORD "RETRO".

CLASS 37—CONSTRUCTION AND REPAIR

FOR PROVIDING INFORMATION IN THE FIELD OF BOAT RESTORATION VIA AN INTERNET WEBSITE (U.S. CLS. 100, 103 AND 106).
FIRST USE 6-1-2006; IN COMMERCE 6-1-2006.

CLASS 45—PERSONAL AND LEGAL SERVICES

FOR ONLINE SOCIAL NETWORKING SERVICE FOR BOATING ENTHUSIASTS (U.S. CLS. 100 AND 101).
FIRST USE 6-1-2006; IN COMMERCE 6-1-2006.
HELENE LIWINSKI, EXAMINING ATTORNEY

SN 77-518,522. PRETTY PLEASE PRESS, INC., NEW YORK, NY. FILED 7-9-2008.



OWNER OF U.S. REG. NO. 3,152,716.
NO CLAIM IS MADE TO THE EXCLUSIVE RIGHT TO USE "PRESS", APART FROM THE MARK AS SHOWN.

THE COLOR(S) TAN, BLUE, WHITE, ORANGE, BROWN, BLACK AND YELLOW IS/ARE CLAIMED AS A FEATURE OF THE MARK.

THE MARK CONSISTS OF THE TERMS "PRETTY PLEASE" IN BLACK SCRIPT LETTERS ABOVE A BLACK HORIZONTAL LINE. BELOW THE BLACK HORIZONTAL LINE IS THE TERM "PRESS" IN BLACK CAPITAL LETTERS. THE WORDING IS TO THE RIGHT OF THE DESIGN. THE DESIGN CONSISTS OF AN OLDER FEMALE READING TO A YOUNGER FEMALE IN A CHAIR. THE CHAIR IS ORANGE WITH BROWN LEGS. THE OLDER FEMALE IS TO THE LEFT OF THE YOUNGER FEMALE. THE OLDER FEMALE HAS TAN SKIN, BROWN HAIR, BROWN FACIAL FEATURES, AND A BLUE DRESS WITH WHITE TRIM AT THE BOTTOM AND BLACK AND WHITE SHOES. THE YOUNGER FEMALE IS TO THE RIGHT OF THE OLDER FEMALE AND HAS TAN SKIN, YELLOW HAIR, A BLUE HAIR BOW, BROWN FACIAL FEATURES AND WHITE SHOES. THE BOOK IS BLACK AND WHITE.

CLASS 9—ELECTRICAL AND SCIENTIFIC APPARATUS

FOR PRE-RECORDED CDS, VIDEO TAPES, LASER DISKS AND DVDS FEATURING CHILDREN'S BOOK CHARACTERS (U.S. CLS. 21, 23, 26, 36 AND 38).

CLASS 28—TOYS AND SPORTING GOODS

FOR PLUSH TOYS (U.S. CLS. 22, 23, 38 AND 50).
MARK T. MULLEN, EXAMINING ATTORNEY

SN 77-519,734. COASTAL DOG MAGAZINE, LLC, NAPLES, FL. FILED 7-11-2008.

COASTAL DOG MAGAZINE

THE MARK CONSISTS OF STANDARD CHARACTERS WITHOUT CLAIM TO ANY PARTICULAR FONT, STYLE, SIZE, OR COLOR.

NO CLAIM IS MADE TO THE EXCLUSIVE RIGHT TO USE "DOG MAGAZINE", APART FROM THE MARK AS SHOWN.

CLASS 16—PAPER GOODS AND PRINTED MATTER

FOR MAGAZINES AND BOOKS FEATURING INFORMATION ON PETS AND CONTAINING SUBJECTS OF INTEREST TO PET OWNERS (U.S. CLS. 2, 5, 22, 23, 29, 37, 38 AND 50).

CLASS 41—EDUCATION AND ENTERTAINMENT

FOR PUBLICATION OF MAGAZINES, TEXTS, BOOKS AND OTHER PRINTED MATTER (U.S. CLS. 100, 101 AND 107).

GIANCARLO CASTRO, EXAMINING ATTORNEY

SN 77-519,783. DAISHO CO., LTD., OSAKA-SHI, OSAKA, JAPAN, FILED 7-11-2008.



THE MARK CONSISTS OF A STYLIZED DESIGN OF A SHIELD CONTAINING INSCRIPTIONS OF A DESIGN OF THREE STARS, A STYLIZED DESIGN OF TWO LETTER "S"'S FACING AND TOUCHING, AND THE STYLIZED WORDING "SHAPE OF MY HEART".

CLASS 18—LEATHER GOODS

FOR BAGS, NAMELY, SPORTS BAGS, CARRYING BAGS AND BEACH BAGS, UMBRELLAS, LEATHER STRAPS, RAW SKINS, AND RAW FURSKINS (U.S. CLS. 1, 2, 3, 22 AND 41).

CLASS 25—CLOTHING

FOR SUITS, PANTS, SPATS, COATS, SWEATERS, VESTS, SHIRTS, SWIMSUITS, JEANS, BLOUSONS, BLAZERS, PARKAS, JACKETS, JUMPERS, SWEATSHIRTS, SWEATPANTS, POLO SHIRTS, PAJAMAS, TEE-SHIRTS, UNDERWEAR, APRONS, SOCKS, STOLE, SHAWLS, SCARVES, GLOVES, NECKTIES, NECKERCHIEFS, MUFFLERS, EAR MUFFS, HATS, WAISTBANDS, AND FOOTWEAR (U.S. CLS. 22 AND 39).

FRED MANDIR, EXAMINING ATTORNEY

SN 77-520,365. GIRLS JUST WANNA HAVE FUNDS, LLC, BOWIE, MD. FILED 7-11-2008.

Girls Just Wanna Have Funds

THE MARK CONSISTS OF STANDARD CHARACTERS WITHOUT CLAIM TO ANY PARTICULAR FONT, STYLE, SIZE, OR COLOR.

CLASS 25—CLOTHING

FOR CLOTHING FOR ADVERTISING AND PROMOTING SERVICES HAVING TO DO WITH THE FINANCIAL INDUSTRY, NAMELY, SHIRTS, SWEATSHIRTS, SWEATERS, JACKETS, PANTS, COATS, SHORTS, SOCKS, AND HATS (U.S. CLS. 22 AND 39).

CLASS 41—EDUCATION AND ENTERTAINMENT

FOR EDUCATION SERVICES, NAMELY, COURSES, SEMINARS, AND LECTURES IN THE FIELD OF EDUCATING WOMEN IN PERSONAL FINANCIAL MATTERS AND GENERALLY HELPING WOMEN BECOME FINANCIALLY LITERATE THROUGH EDUCATION SERVICES; AND DISTRIBUTION OF COURSE MATERIAL IN CONNECTION THEREWITH (U.S. CLS. 100, 101 AND 107).

WILLIAM BRECKENFELD, EXAMINING ATTORNEY

CLASS 35—ADVERTISING AND BUSINESS

FOR PROMOTING THE GOODS AND SERVICES OF OTHERS THROUGH THE ADMINISTRATION OF DISCOUNTS, REBATES, INCENTIVE AWARDS AND CUSTOMER LOYALTY PROGRAMS (U.S. CLS. 100, 101 AND 102).

FIRST USE 7-13-2008; IN COMMERCE 7-13-2008.

CLASS 41—EDUCATION AND ENTERTAINMENT

FOR SWEEPSTAKE SERVICES (U.S. CLS. 100, 101 AND 107).

FIRST USE 7-13-2008; IN COMMERCE 7-13-2008.

REBECCA SMITH, EXAMINING ATTORNEY

SN 77-520,522. KIDS ON BIKES, INC., COLORADO SPRINGS, CO. FILED 7-11-2008.

**CLASS 16—PAPER GOODS AND PRINTED MATTER**

FOR PRINTED MATERIAL, NAMELY, A CURRICULUM IN THE NATURE OF A TRAINING MANUAL FOR TEACHING NUTRITION, PHYSICAL FITNESS, GOAL-SETTING, AND CHARACTER DEVELOPMENT TO CHILDREN (U.S. CLS. 2, 5, 22, 23, 29, 37, 38 AND 50).

CLASS 39—TRANSPORTATION AND STORAGE

FOR CHARITABLE SERVICES, NAMELY, PROVIDING BICYCLES TO CHILDREN (U.S. CLS. 100 AND 105).

KATHERINE CHANG, EXAMINING ATTORNEY

SN 77-521,258. UPROMISE, INC., NEWTON, MA. FILED 7-14-2008.

Uppromise College Dream
Sweepstakes

THE MARK CONSISTS OF STANDARD CHARACTERS WITHOUT CLAIM TO ANY PARTICULAR FONT, STYLE, SIZE, OR COLOR.

OWNER OF U.S. REG. NOS. 2,618,696, 3,423,857 AND OTHERS.

NO CLAIM IS MADE TO THE EXCLUSIVE RIGHT TO USE "COLLEGE" AND "SWEEPSTAKES", APART FROM THE MARK AS SHOWN.

SN 77-522,566. BAND-IT-IDEX, INC., DENVER, CO. FILED 7-15-2008.



THE MARK CONSISTS OF A GLOBE DESIGN WITH A BAND WITH CLAMP WRAPPED AROUND IT.

CLASS 6—METAL GOODS

FOR METAL FITTINGS FOR PIPES, HOSES, METAL CONNECTORS AND PARTS OF AND ACCESSORIES THEREFOR, NAMELY, METAL BANDS, STRIPS, STRAPPING, CLIPS, CLAMPS, BUCKLES, HOSE FITTINGS, MENDERS, COUPLINGS, ADAPTER UNIONS, NIPPLES, YOKES, STEMS, NIPPLE PUSHERS, ADAPTERS, CUTTERS, BENCH MOUNTS, NUTS, BOLTS, SCREWS, RIVETS, BALL BEARINGS, LEVERS, HANDLES, SIGNAL MOUNTS, BRACKETS, SEALS, RACKS, METAL-BACKED PATCHES; KITS COMPRISING VARIOUS ASSORTMENTS OF THE ABOVE SOLD IN CONTAINERS (U.S. CLS. 2, 12, 13, 14, 23, 25 AND 50).

FIRST USE 3-30-1987; IN COMMERCE 3-30-1987.

CLASS 7—MACHINERY

FOR INDUSTRIAL MACHINES FOR APPLYING AND REMOVING BANDS AND CLAMPS AND COMPONENT PARTS THEREFOR (U.S. CLS. 13, 19, 21, 23, 31, 34 AND 35).

FIRST USE 3-30-1987; IN COMMERCE 3-30-1987.

CLASS 8—HAND TOOLS

FOR HAND TOOLS FOR APPLYING AND REMOVING METAL FITTINGS FOR PIPES AND HOSES, METAL CONNECTORS AND PARTS AND ACCESSORIES THEREFOR, FOR USE ON OR IN CONNECTION WITH METAL BANDS, STRIPS, STRAPPING, CLIPS, CLAMPS, BUCKLES, HOSE FITTINGS, MENDERS, COUPLINGS, ADAPTER UNIONS, NIPPLES, YOLKS, STEMS, NIPPLE PUSHERS, ADAPTERS, CUTTERS, BENCH MOUNTS, NUTS, BOLTS, SCREWS, RIVETS, LEVERS, HANDLES, SIGNAL MOUNTS, BRACKETS, SEALS, RACKS, METAL-BACKED PATCHES; KITS COMPRISING VARIOUS ASSORTMENTS OF THE ABOVE SOLD IN CONTAINERS (U.S. CLS. 23, 28 AND 44).

FIRST USE 3-30-1987; IN COMMERCE 3-30-1987.
ANDREA BUTLER, EXAMINING ATTORNEY

SN 77-522,953. DOG'S RULE RESORT K.Z.P., L.P., CARROLLTON, TX. FILED 7-15-2008.



THE MARK CONSISTS OF A SCHNAUZER DOG WEARING A ROBE AND SUNGLASSES, SITTING ON A CHAISE LOUNGE WITH A DRINK IN HAND.

CLASS 43—HOTEL AND RESTAURANT SERVICES

FOR PET BOARDING SERVICES AND PET DAY CARE SERVICES (U.S. CLS. 100 AND 101).

CLASS 44—MEDICAL, BEAUTY AND AGRICULTURAL SERVICES

FOR NON-MEDICATED PET GROOMING (U.S. CLS. 100 AND 101).

CHRISTOPHER BUONGIORNO, EXAMINING ATTORNEY

SN 77-524,656. ABI ANLAGENTECHNIK-BAUMASCHINEN-INDUSTRIEBEDARF MASCHINENFABRIK UND VERTRIEBSGESELLSCHAFT MBH, NIEDERNBERG, FED REP GERMANY, FILED 7-17-2008.

TRIPLEMIX

THE MARK CONSISTS OF STANDARD CHARACTERS WITHOUT CLAIM TO ANY PARTICULAR FONT, STYLE, SIZE, OR COLOR.

CLASS 7—MACHINERY

FOR CONSTRUCTION MACHINES AND EQUIPMENT FOR FOUNDATION AND SHORING, NAMELY, FOUNDATION DRILLING MACHINES, PILE DRIVERS AND PILE RAMMERS, SILENT PRESS-IN PILE DRIVING MACHINES, PILE EXTRACTION MACHINES (U.S. CLS. 13, 19, 21, 23, 31, 34 AND 35).

CLASS 16—PAPER GOODS AND PRINTED MATTER

FOR PLASTIC MATERIALS FOR PACKAGING, NAMELY, BAGS AND POUCHES OF PLASTIC FOR PACKAGING (U.S. CLS. 2, 5, 22, 23, 29, 37, 38 AND 50).

CLASS 42—SCIENTIFIC AND COMPUTER SERVICES

FOR RESEARCH AND DEVELOPMENT OF TECHNOLOGY IN THE FIELD OF CONSTRUCTION EQUIPMENT USED IN THE BUILDING OF FOUNDATIONS AND SHORING, NAMELY, FOUNDATION DRILLING MACHINES, PILE DRIVERS AND RAMMERS, PILING PRESSING MACHINES, PILE EXTRACTION MACHINES; CONSULTING IN THE FIELD OF RESEARCH AND DEVELOPMENT OF TECHNOLOGY IN THE FIELD OF CONSTRUCTION EQUIPMENT USED IN THE BUILDING OF FOUNDATIONS AND SHORING, NAMELY, FOUNDATION DRILLING MACHINES, PILE DRIVERS AND RAMMERS, PILING PRESSING MACHINES, PILE EXTRACTION MACHINES (U.S. CLS. 100 AND 101).

STEPHEN AQUILA, EXAMINING ATTORNEY

SN 77-525,700. ENTERGY CORPORATION, NEW ORLEANS, LA. FILED 7-18-2008.

CAREFREE 3

THE MARK CONSISTS OF STANDARD CHARACTERS WITHOUT CLAIM TO ANY PARTICULAR FONT, STYLE, SIZE, OR COLOR.

CLASS 35—ADVERTISING AND BUSINESS

FOR BILLING SERVICES, NAMELY, LEVEL MONTHLY BILLING FOR UTILITY CUSTOMERS (U.S. CLS. 100, 101 AND 102).

CLASS 36—INSURANCE AND FINANCIAL

FOR BILL PAYMENT SERVICES FOR UTILITY CUSTOMERS, NAMELY, AUTOMATIC BANK DRAFTS FOR BILL PAYMENTS AND A PROGRAM ALLOWING A CUSTOMER TO CHOOSE THE DAY OF THE MONTH ON WHICH A MONTHLY BILL IS RECEIVED (U.S. CLS. 100, 101 AND 102).

TARA PATE, EXAMINING ATTORNEY

SN 77-525,780. SUN TITLE AGENCY OF MICHIGAN LLC, GRAND RAPIDS, MI. FILED 7-18-2008.

SN 77-527,160. YZ STUDIO, INC., NEW YORK, NY. FILED 7-21-2008.

REMOTE TITLE

THE MARK CONSISTS OF STANDARD CHARACTERS WITHOUT CLAIM TO ANY PARTICULAR FONT, STYLE, SIZE, OR COLOR.

OWNER OF U.S. REG. NOS. 3,085,373, 3,241,841 AND 3,337,514.

NO CLAIM IS MADE TO THE EXCLUSIVE RIGHT TO USE "TITLE", APART FROM THE MARK AS SHOWN.

CLASS 36—INSURANCE AND FINANCIAL

FOR INSURANCE AGENCY SERVICES IN THE FIELD OF TITLE INSURANCE; REAL ESTATE TITLE INSURANCE UNDERWRITING SERVICES; AND REAL ESTATE ESCROW SERVICES (U.S. CLS. 100, 101 AND 102).

CLASS 45—PERSONAL AND LEGAL SERVICES

FOR REAL ESTATE CLOSING SERVICES; REAL ESTATE SETTLEMENT SERVICES; TITLE SEARCHING; LEGAL SERVICES IN THE FIELD OF REAL ESTATE; LEGAL RESEARCH IN THE FIELD OF REAL ESTATE (U.S. CLS. 100 AND 101).

TASNEEM HUSSAIN, EXAMINING ATTORNEY

SN 77-526,201. MAJOR GEOTHERMAL, INC., WHEAT RIDGE, CO. FILED 7-18-2008.

ENVIROPLATE

THE MARK CONSISTS OF STANDARD CHARACTERS WITHOUT CLAIM TO ANY PARTICULAR FONT, STYLE, SIZE, OR COLOR.

CLASS 7—MACHINERY

FOR GEOTHERMAL HEAT EXCHANGERS BEING PARTS OF MACHINES FOR BODIES OF WATER SUCH AS LAKES, PONDS, BAYS, RIVERS, AND CISTERNS (U.S. CLS. 13, 19, 21, 23, 31, 34 AND 35).

CLASS 11—ENVIRONMENTAL CONTROL APPARATUS

FOR GEOTHERMAL HEAT EXCHANGERS NOT BEING PARTS OF MACHINES FOR BODIES OF WATER SUCH AS LAKES, PONDS, BAYS, RIVERS, AND CISTERNS (U.S. CLS. 13, 21, 23, 31 AND 34).

PATRICIA EVANKO, EXAMINING ATTORNEY

YAMUNA BODY SUSTAINABILITY

THE MARK CONSISTS OF STANDARD CHARACTERS WITHOUT CLAIM TO ANY PARTICULAR FONT, STYLE, SIZE, OR COLOR.

OWNER OF U.S. REG. NOS. 2,470,182, 2,491,495 AND 3,197,118.

NO CLAIM IS MADE TO THE EXCLUSIVE RIGHT TO USE "BODY SUSTAINABILITY", APART FROM THE MARK AS SHOWN.

CLASS 3—COSMETICS AND CLEANING PREPARATIONS

FOR HEALTH CARE PRODUCTS, NAMELY, NON-MEDICATED BATH SALTS, BATH OILS, HAIR AND SCALP OILS, CLAYS FOR SKIN CARE (U.S. CLS. 1, 4, 6, 50, 51 AND 52).

CLASS 9—ELECTRICAL AND SCIENTIFIC APPARATUS

FOR PRE-RECORDED INSTRUCTIONAL VIDEO TAPES FEATURING PHYSICAL FITNESS, PHYSICAL THERAPY AND MASSAGE (U.S. CLS. 21, 23, 26, 36 AND 38).

CLASS 16—PAPER GOODS AND PRINTED MATTER

FOR EDUCATIONAL MANUALS AND OTHER PRINTED INSTRUCTIONAL MATERIALS IN THE FIELD OF PHYSICAL FITNESS, PHYSICAL THERAPY AND MASSAGE (U.S. CLS. 2, 5, 22, 23, 29, 37, 38 AND 50).

CLASS 25—CLOTHING

FOR CLOTHING, NAMELY, GYM SUITS, SWEAT PANTS, SWEAT SHIRTS, LEOTARDS, T-SHIRTS AND TANK TOPS (U.S. CLS. 22 AND 39).

CLASS 28—TOYS AND SPORTING GOODS

FOR EXERCISE THERAPY BALLS, AND PUMPS TO INFLATE THE BALLS (U.S. CLS. 22, 23, 38 AND 50).

CLASS 41—EDUCATION AND ENTERTAINMENT

FOR EDUCATIONAL SERVICES, NAMELY, CONDUCTING SEMINARS, LECTURES AND PERSONAL TRAINING FOR PHYSICAL FITNESS, PHYSICAL THERAPY AND MASSAGE (U.S. CLS. 100, 101 AND 107).

JULIE WATSON, EXAMINING ATTORNEY

SN 77-527,900. PEARSON EDUCATION, INC., UPPER SADDLE RIVER, NJ. FILED 7-22-2008.

The logo for enVisionMATH features the word "en" in a lowercase, sans-serif font, followed by "Vision" in a larger, bold, sans-serif font with a dot above the 'i', and "MATH" in a smaller, uppercase, sans-serif font.

THE MARK CONSISTS OF THE WORDS "ENVISION-MATH" WITH A SERIES OF CIRCLES CONNECTING THE FIRST AND LAST LETTER I.

CLASS 9—ELECTRICAL AND SCIENTIFIC APPARATUS

FOR DDS AND COMPUTER SOFTWARE FOR STUDENTS AND TEACHERS FEATURING EDUCATIONAL TOOLS, CONTENT, AND MATERIALS IN THE FIELD OF MATHEMATICS (U.S. CLS. 21, 23, 26, 36 AND 38).
FIRST USE 3-1-2007; IN COMMERCE 7-1-2007.

CLASS 16—PAPER GOODS AND PRINTED MATTER

FOR PRINTED MATERIALS, NAMELY, TEXTBOOKS, ACTIVITY BOOKS, ACTIVITY GUIDES, TEACHER'S GUIDES, WORKBOOKS AND MANUALS IN THE FIELD OF MATHEMATICS (U.S. CLS. 2, 5, 22, 23, 29, 37, 38 AND 50).
FIRST USE 3-1-2007; IN COMMERCE 7-1-2007.

CLASS 41—EDUCATION AND ENTERTAINMENT

FOR EDUCATIONAL SERVICES, NAMELY, PROVIDING A SUBSCRIPTION FOR AN ON-LINE INTERACTIVE WEB SITE OVER A GLOBAL COMPUTER INFORMATION NETWORK FOR TEACHING MATHEMATICS AT THE GRADE SCHOOL LEVEL (U.S. CLS. 100, 101 AND 107).
FIRST USE 3-1-2007; IN COMMERCE 7-1-2007.

NAAKWAMA ANKRAH, EXAMINING ATTORNEY

SN 77-528,163. IBLEU INC., MINNEAPOLIS, MN. FILED 7-22-2008.

IBLEU

THE MARK CONSISTS OF STANDARD CHARACTERS WITHOUT CLAIM TO ANY PARTICULAR FONT, STYLE, SIZE, OR COLOR.

CLASS 9—ELECTRICAL AND SCIENTIFIC APPARATUS

FOR APPARATUS, SOFTWARE AND ACCESSORIES FOR BILINGUAL COMMUNICATION INCLUDING SIGN LANGUAGE, NAMELY, APPARATUS FOR TRANSMISSION OF COMMUNICATION, COMMUNICATIONS SOFTWARE FOR CONNECTING APPARATUS FOR THE TRANSMISSION OF COMMUNICATION, AND ELECTRONIC COMMUNICATIONS INSTRUMENTS AND COMPONENTS, NAMELY, AUDIO-VISUAL TRANSMITTERS AND RECEIVERS (U.S. CLS. 21, 23, 26, 36 AND 38).

CLASS 38—COMMUNICATION

FOR INTERNET TELECOMMUNICATION SERVICES FOR BILINGUAL COMMUNICATION INCLUDING SIGN LANGUAGE, NAMELY, THE TRANSMISSION OF VOICE, AUDIO AND VIDEO BY MEANS OF THE INTERNET (U.S. CLS. 100, 101 AND 104).
LINDSEY RUBIN, EXAMINING ATTORNEY

SN 77-529,694. THE ARTHRITIS FOUNDATION, INC., ATLANTA, GA. FILED 7-23-2008.



THE MARK CONSISTS OF A DOT SIGNIFYING A HEAD WITH A LOOP BELOW SIGNIFYING ARMS AND A BODY.

CLASS 35—ADVERTISING AND BUSINESS

FOR PROMOTING PUBLIC AWARENESS OF ARTHRITIS (U.S. CLS. 100, 101 AND 102).
FIRST USE 4-0-2008; IN COMMERCE 4-0-2008.

CLASS 36—INSURANCE AND FINANCIAL

FOR CHARITABLE FUNDRAISING SERVICES (U.S. CLS. 100, 101 AND 102).
FIRST USE 4-0-2008; IN COMMERCE 4-0-2008.
CAROL SPILS, EXAMINING ATTORNEY

SN 77-529,914. NOSSAMAN LLP, LOS ANGELES, CA. FILED 7-23-2008.

NOSSAMAN LLP

NO CLAIM IS MADE TO THE EXCLUSIVE RIGHT TO USE "LLP", APART FROM THE MARK AS SHOWN.

THE COLOR(S) GREEN, BLACK AND WHITE IS/ARE CLAIMED AS A FEATURE OF THE MARK.

THE COLOR BLACK APPEARS IN THE WORDING "NOSSAMAN LLP" AND IN THE STYLIZED LETTER "N". THE COLOR WHITE APPEARS IN THE STYLIZED LETTER "N". THE COLOR GREEN APPEARS IN THE SQUARE DESIGN ELEMENT.

CLASS 35—ADVERTISING AND BUSINESS

FOR LOBBYING SERVICES, NAMELY, PROMOTING THE INTERESTS OF PUBLIC AND PRIVATE ENTITIES IN THE FIELDS OF LEGISLATION AND REGULATION (U.S. CLS. 100, 101 AND 102).
FIRST USE 7-1-2008; IN COMMERCE 7-1-2008.

CLASS 45—PERSONAL AND LEGAL SERVICES

FOR LEGAL SERVICES (U.S. CLS. 100 AND 101).
FIRST USE 7-1-2008; IN COMMERCE 7-1-2008.
JENNIFER HETU, EXAMINING ATTORNEY

SN 77-529,923. NOSSAMAN LLP, LOS ANGELES, CA. FILED 7-23-2008.



THE COLOR(S) GREEN, BLACK AND WHITE IS/ARE CLAIMED AS A FEATURE OF THE MARK.
 THE COLOR BLACK APPEARS IN THE STYLIZED LETTER "N". THE COLOR WHITE APPEARS IN THE STYLIZED LETTER "N". THE COLOR GREEN APPEARS IN THE SQUARE DESIGN ELEMENT.

CLASS 35—ADVERTISING AND BUSINESS
 FOR LOBBYING SERVICES, NAMELY, PROMOTING THE INTERESTS OF PUBLIC AND PRIVATE ENTITIES IN THE FIELDS OF LEGISLATION AND REGULATION (U.S. CLS. 100, 101 AND 102).
 FIRST USE 7-1-2008; IN COMMERCE 7-1-2008.

CLASS 45—PERSONAL AND LEGAL SERVICES
 FOR LEGAL SERVICES (U.S. CLS. 100 AND 101).
 FIRST USE 7-1-2008; IN COMMERCE 7-1-2008.
 JENNIFER HETU, EXAMINING ATTORNEY

SN 77-530,398. STUDIO INCOGNITO, CROMWELL, CT. FILED 7-24-2008.



THE MARK CONSISTS OF THE TERMS "DESIGN IS" WITH A STYLIZED HEART SYMBOL. THE TERM "IS" APPEARS HORIZONTALLY TO LOOK LIKE AN EQUAL SIGN BETWEEN THE TERM "DESIGN" AND THE HEART SYMBOL.

CLASS 16—PAPER GOODS AND PRINTED MATTER
 FOR PRINTED VISUALS IN THE NATURE OF PROMOTIONAL MATERIALS AND INFORMATIONAL GRAPHICS (U.S. CLS. 2, 5, 22, 23, 29, 37, 38 AND 50).

CLASS 25—CLOTHING
 FOR WEARABLE GARMENTS AND CLOTHING, NAMELY, SHIRTS (U.S. CLS. 22 AND 39).

CLASS 38—COMMUNICATION
 FOR WEB MESSAGING (U.S. CLS. 100, 101 AND 104).
 PAULA MAHONEY, EXAMINING ATTORNEY

SN 77-530,617. OAK STATE PRODUCTS, INC., WENONA, IL. FILED 7-24-2008.



NO CLAIM IS MADE TO THE EXCLUSIVE RIGHT TO USE "SLE A PRODUCT OF" AND "ALSO AVAILABLE IN NATURAL AND SUGAR-FREE", APART FROM THE MARK AS SHOWN.
 THE MARK CONSISTS OF THE WORDS "SLE A PRODUCT OF OAK STATE ALSO AVAILABLE IN NATURAL AND SUGAR-FREE" ALL WITHIN A CIRCLE BORDERED BY THREE CIRCULAR ARROWS, WITH AN OAK LEAF IMAGE AT RIGHT SIDE AND EXTENDING BEYOND SAID CIRCLE.

CLASS 1—CHEMICALS
 FOR GEL USED AS AN INGREDIENT IN THE MANUFACTURE OF HUMAN FOOD FOR USE AS A SHELF-LIFE EXTENDER (U.S. CLS. 1, 5, 6, 10, 26 AND 46).

CLASS 29—MEATS AND PROCESSED FOODS
 FOR FAT SUBSTITUTE FOR USE AS AN INGREDIENT IN BAKED GOODS (U.S. CL. 46).
 YAT SYE, LEE, EXAMINING ATTORNEY

SN 77-531,278. DRUCEGROVE LIMITED, WALTHAM ABBEY, ESSEX, UNITED KINGDOM, FILED 7-25-2008.



THE MARK CONSISTS OF STANDARD CHARACTERS WITHOUT CLAIM TO ANY PARTICULAR FONT, STYLE, SIZE, OR COLOR.

CLASS 7—MACHINERY
 FOR ELEVATOR EQUIPMENT, NAMELY, ELEVATORS AND PARTS THEREOF, ELEVATOR CABLE TENSIONING SYSTEMS COMPRISING METAL CABLES FOR ELEVATORS, ELEVATOR GEARS AND ELEVATOR MOTORS (U.S. CLS. 13, 19, 21, 23, 31, 34 AND 35).

CLASS 9—ELECTRICAL AND SCIENTIFIC APPARATUS

FOR ELEVATOR OPERATING EQUIPMENT, NAMELY, ELECTRONIC CONTROLLERS TO MANAGE THE POWER, MOVEMENT AND FUNCTIONS OF AN ELEVATOR, PUSHBUTTONS, SIGNAL FIXTURES AND EMERGENCY LIGHTING FOR ELEVATORS, AND ELEVATOR PERFORMANCE MONITORING SYSTEM, NAMELY, EMBEDDED SOFTWARE IN CONTROLLERS FOR MONITORING ELEVATOR FUNCTIONS (U.S. CLS. 21, 23, 26, 36 AND 38).

SN 77-533,993. NEOCUTIS, S.A., PULLY, SWITZERLAND, FILED 7-29-2008.

**BLANCHE
(HYDROQUINONE USP, 4%)
SKIN LIGHTENING CREAM**

CLASS 37—CONSTRUCTION AND REPAIR

FOR INSTALLATION AND REPAIR OF ELEVATORS AND ELEVATOR OPERATING EQUIPMENT INCLUDING ELEVATOR SENSORS AND ROPE TENSIONING SYSTEMS FOR ELEVATORS (U.S. CLS. 100, 103 AND 106).

STEVEN PEREZ, EXAMINING ATTORNEY

THE MARK CONSISTS OF STANDARD CHARACTERS WITHOUT CLAIM TO ANY PARTICULAR FONT, STYLE, SIZE, OR COLOR.

NO CLAIM IS MADE TO THE EXCLUSIVE RIGHT TO USE "HYDROQUINONE USP, 4% SKIN LIGHTENING CREAM", APART FROM THE MARK AS SHOWN.

THE FOREIGN WORDING IN THE MARK TRANSLATES INTO ENGLISH AS WHITE.

SN 77-531,670. DANA MEADOR, DALLAS, TX. FILED 7-25-2008.

WEALTH SHIFT

THE MARK CONSISTS OF STANDARD CHARACTERS WITHOUT CLAIM TO ANY PARTICULAR FONT, STYLE, SIZE, OR COLOR.

CLASS 16—PAPER GOODS AND PRINTED MATTER

FOR PRINTED PUBLICATIONS, NAMELY, BOOKS, PAMPHLETS, AND PROMOTIONAL MATERIALS, ALL IN THE FIELDS OF BUSINESS ETHICS, BUSINESS MANAGEMENT, AND ECONOMICS; CALENDARS; BUMPER STICKERS; DESKTOP ACCESSORIES, NAMELY, PENS, PENCILS, NOTEPADS, ADHESIVE NOTEPADS AND OFFICE SUPPLY DISPENSERS; PAPER WEIGHTS; PRINTED INSTRUCTIONAL, EDUCATIONAL AND TEACHING MATERIALS IN THE FIELDS OF BUSINESS ETHICS, BUSINESS MANAGEMENT, AND ECONOMICS (U.S. CLS. 2, 5, 22, 23, 29, 37, 38 AND 50).

CLASS 21—HOUSEWARES AND GLASS

FOR MUGS; CUPS; BEVERAGE GLASSWARE (U.S. CLS. 2, 13, 23, 29, 30, 33, 40 AND 50).

CLASS 25—CLOTHING

FOR T-SHIRTS; HATS (U.S. CLS. 22 AND 39).

CLASS 41—EDUCATION AND ENTERTAINMENT

FOR EDUCATIONAL AND ENTERTAINMENT SERVICES, NAMELY, PROVIDING MOTIVATIONAL AND EDUCATIONAL SPEAKING SERVICES IN THE FIELD OF BUSINESS ETHICS, BUSINESS MANAGEMENT, AND ECONOMICS (U.S. CLS. 100, 101 AND 107).

SANJEEV VOHRA, EXAMINING ATTORNEY

CLASS 3—COSMETICS AND CLEANING PREPARATIONS

FOR AGE SPOT REDUCING CREAMS; BEAUTY CREAMS; FACE CREAMS; FACIAL CREAM; SKIN CREAM; SKIN LIGHTENING CREAMS; SKIN WHITENING CREAMS (U.S. CLS. 1, 4, 6, 50, 51 AND 52).

CLASS 5—PHARMACEUTICALS

FOR GELS, CREAMS AND SOLUTIONS FOR DERMATOLOGICAL USE; MEDICATED SKIN CARE PREPARATIONS, NAMELY, CREAMS, LOTIONS, GELS, TONERS, CLEANERS AND PEELS; MEDICINAL CREAMS FOR SKIN CARE (U.S. CLS. 6, 18, 44, 46, 51 AND 52).

MARK SPARACINO, EXAMINING ATTORNEY

SN 77-534,085. ALCOA HOME EXTERIORS, INC., KANSAS CITY, MO. FILED 7-29-2008.

MASTIC HOME EXTERIORS

THE MARK CONSISTS OF STANDARD CHARACTERS WITHOUT CLAIM TO ANY PARTICULAR FONT, STYLE, SIZE, OR COLOR.

OWNER OF U.S. REG. NOS. 1,541,539, 2,044,947 AND 3,409,224.

NO CLAIM IS MADE TO THE EXCLUSIVE RIGHT TO USE "HOME EXTERIORS", APART FROM THE MARK AS SHOWN.

CLASS 6—METAL GOODS

FOR METAL SIDING (U.S. CLS. 2, 12, 13, 14, 23, 25 AND 50).

CLASS 19—NON-METALLIC BUILDING MATERIALS

FOR NON-METAL BUILDING PRODUCTS, NAMELY, SHUTTERS, SIDING, SKIRTING, AND TRIM (U.S. CLS. 1, 12, 33 AND 50).

DOMINIC J. FERRAIUOLO, EXAMINING ATTORNEY

SN 77-535,932. HI-TEX, INC., DBA CRYPTON, INC., WEST BLOOMFIELD, MI. FILED 7-31-2008.

CRYPTON CARE

THE MARK CONSISTS OF STANDARD CHARACTERS WITHOUT CLAIM TO ANY PARTICULAR FONT, STYLE, SIZE, OR COLOR.

OWNER OF U.S. REG. NOS. 1,927,329, 3,509,947 AND OTHERS.

NO CLAIM IS MADE TO THE EXCLUSIVE RIGHT TO USE "CARE", APART FROM THE MARK AS SHOWN.

CLASS 3—COSMETICS AND CLEANING PREPARATIONS

FOR FABRIC SOIL REMOVERS AND STAIN REMOVERS; CLEANERS, POLISH AND CONDITIONERS FOR FABRICS, NAMELY, CLOTH, LEATHER AND VINYL (U.S. CLS. 1, 4, 6, 50, 51 AND 52).

CLASS 5—PHARMACEUTICALS

FOR DEODORANTS FOR CLOTHING AND TEXTILES, NAMELY, FABRIC FRESHENERS (U.S. CLS. 6, 18, 44, 46, 51 AND 52).

CLASS 24—FABRICS

FOR LIQUID AND STAIN RESISTANT FABRICS FOR USE IN THE MANUFACTURING OF UMBRELLAS, RAIN GEAR, TENTS, TARPAULINS, AWNINGS, CLOTHING, APRONS, FURNITURE, UPHOLSTERY, TABLECLOTHS, WALL COVERINGS, AND COVERS FOR BOATS AND VEHICLES (U.S. CLS. 42 AND 50).

PAUL CROWLEY, EXAMINING ATTORNEY

SN 77-536,064. WILLIAMS, HANSFORD R., LAKEWOOD RANCH, FL. FILED 7-31-2008.

BIOTIZER

THE MARK CONSISTS OF STANDARD CHARACTERS WITHOUT CLAIM TO ANY PARTICULAR FONT, STYLE, SIZE, OR COLOR.

CLASS 3—COSMETICS AND CLEANING PREPARATIONS

FOR ALL PURPOSE CLEANING PREPARATIONS; BIOTECHNOLOGICAL CHEMICAL AND SPRAY CLEANERS FOR INDUSTRIAL AND HOUSEHOLD APPLICATIONS SUCH AS STAIN REMOVAL, ODOR ELIMINATION, AND BIOREMEDIATION OF MANY TYPES OF ORGANIC AND HYDROCARBON-BASED MATERIALS; BIOTECHNOLOGICAL CLEANING SOLUTION FOR ELIMINATING ODORS, BREAKING DOWN ORGANICS, AND REMOVING STAINS; CLEANING AGENTS AND PREPARATIONS; CLEANING PREPARATIONS; CLEANING PREPARATIONS FOR HOUSEHOLD PURPOSES (U.S. CLS. 1, 4, 6, 50, 51 AND 52).

FIRST USE 7-25-2008; IN COMMERCE 7-25-2008.

CLASS 21—HOUSEWARES AND GLASS

FOR DISPENSERS FOR CLEANING AND DISINFECTING SOLUTIONS; DISPENSERS FOR LIQUID SOAP (U.S. CLS. 2, 13, 23, 29, 30, 33, 40 AND 50).

FIRST USE 7-25-2008; IN COMMERCE 7-25-2008.

MARC LEIPZIG, EXAMINING ATTORNEY

SN 77-537,705. CAMP MAKEBELIEVE, INC., LAS VEGAS, NV. FILED 8-2-2008.



NO CLAIM IS MADE TO THE EXCLUSIVE RIGHT TO USE "KIDS", APART FROM THE MARK AS SHOWN.

THE COLOR(S) GOLD, ORANGE, BLACK IS/ARE CLAIMED AS A FEATURE OF THE MARK.

THE MARK CONSISTS OF FOUR STYLIZED CHILDREN ARM IN ARM WITH ARMS EXTENDED; THE WORDS "CAMP MAKEBELIEVE" IN AN ARC ABOVE AND THE WORD "KIDS!" BELOW IS A STRAIGHT LINE. ALL COLORED GOLD OR ORANGE WITH BLACK OUTLINE AND BLACK STYLIZED FEATURES OF CHILDREN.

CLASS 9—ELECTRICAL AND SCIENTIFIC APPARATUS

FOR CHILDREN'S EDUCATIONAL MUSIC CDS AND DVDS; CHILDREN'S EDUCATIONAL SOFTWARE (U.S. CLS. 21, 23, 26, 36 AND 38).

CLASS 16—PAPER GOODS AND PRINTED MATTER

FOR EDUCATIONAL BOOKS FEATURING STORIES AND ACTIVITIES TO PROMOTE EMOTIONAL COMPETENCE; EDUCATIONAL PUBLICATIONS, NAMELY, EDUCATIONAL LEARNING CARDS, FLASH CARDS, ACTIVITY CARDS, WORKBOOKS, TEXTBOOKS, ACTIVITY BOOKS, STORY BOOKS, PUZZLE BOOKS, PRINTED PUZZLES, TEACHER GUIDES, MANUALS, POSTERS AND EDUCATIONAL BOOKLETS IN THE FIELD OF MENTAL HEALTH, SPECIFICALLY DEVELOPMENT OF EMOTIONAL COMPETENCE; EDUCATIONAL PUBLICATIONS, NAMELY, WORKBOOKS, POSTERS, AND GUIDEBOOKS IN THE FIELDS OF MENTAL HEALTH, SPECIFICALLY DEVELOPING EMOTIONAL COMPETENCE; PRINTED INSTRUCTIONAL, EDUCATIONAL, AND TEACHING MATERIALS IN THE FIELD OF MENTAL HEALTH, SPECIFICALLY DEVELOPMENT OF EMOTIONAL COMPETENCE IN CHILDREN (U.S. CLS. 2, 5, 22, 23, 29, 37, 38 AND 50).

CLASS 28—TOYS AND SPORTING GOODS

FOR EDUCATIONAL CARD GAMES (U.S. CLS. 22, 23, 38 AND 50).

SETH A. RAPPAPORT, EXAMINING ATTORNEY

SN 77-538,224. PIZZAVITO FRANCHISE GROUP, LLC, GAINESVILLE, FL. FILED 8-4-2008.

SN 77-538,414. GV SOURCE, LLC, HOUSTON, TX. FILED 8-4-2008.

PIZZAVITUCCIO

THE MARK CONSISTS OF STANDARD CHARACTERS WITHOUT CLAIM TO ANY PARTICULAR FONT, STYLE, SIZE, OR COLOR.

CLASS 35—ADVERTISING AND BUSINESS

FOR RESTAURANT FRANCHISING (U.S. CLS. 100, 101 AND 102).

CLASS 43—HOTEL AND RESTAURANT SERVICES

FOR RESTAURANT SERVICES (U.S. CLS. 100 AND 101).
ALLISON HOLTZ, EXAMINING ATTORNEY

SN 77-538,277. THE TRUSTEES OF THE KITE REALTY GROUP TRUST, INDIANAPOLIS, IN. FILED 8-4-2008.

BRINGING LIFE AND CONVENIENCE TOGETHER IN ONE PLACE

THE MARK CONSISTS OF STANDARD CHARACTERS WITHOUT CLAIM TO ANY PARTICULAR FONT, STYLE, SIZE, OR COLOR.

CLASS 36—INSURANCE AND FINANCIAL

FOR LEASING OF REAL ESTATE (U.S. CLS. 100, 101 AND 102).
FIRST USE 8-8-2007; IN COMMERCE 8-8-2007.

CLASS 37—CONSTRUCTION AND REPAIR

FOR REAL ESTATE DEVELOPMENT (U.S. CLS. 100, 103 AND 106).
FIRST USE 8-8-2007; IN COMMERCE 8-8-2007.
KIM MONINGHOFF, EXAMINING ATTORNEY



NO CLAIM IS MADE TO THE EXCLUSIVE RIGHT TO USE "GLOBAL VALVE & CONTROLS", APART FROM THE MARK AS SHOWN.

THE MARK CONSISTS OF THE WORDS "GLOBAL VALVE & CONTROLS". THE G OF THE WORD "GLOBAL" CONTAINS AN ARROWHEAD AT EACH OF TWO TERMINATING ENDS OF THE LETTER. THE O OF THE WORD "GLOBAL" IS DEPICTED AS A GLOBE SHOWING BOTH CONTINENTS AND MERIDIANS AND PARALLELS THEREON.

CLASS 6—METAL GOODS

FOR METAL VALVES NOT BEING PARTS OF MACHINES, NAMELY, BALL VALVES, NEEDLE VALVES, GATE VALVES, GLOBE VALVES, BUTTERFLY VALVES, PISTON CHECK VALVES, SWING CHECK VALVES, AND PARTS THEREOF; MANUALLY OPERATED METAL VALVES (U.S. CLS. 2, 12, 13, 14, 23, 25 AND 50).
FIRST USE 5-0-2005; IN COMMERCE 5-0-2005.

CLASS 9—ELECTRICAL AND SCIENTIFIC APPARATUS

FOR AUTOMATICALLY OPERATED VALVES, NAMELY, BALL VALVES, NEEDLE VALVES, GATE VALVES, GLOBE VALVES, BUTTERFLY VALVES, AND PARTS THEREOF; AUTOMATIC VALVES (U.S. CLS. 21, 23, 26, 36 AND 38).

FIRST USE 5-0-2005; IN COMMERCE 5-0-2005.

ELIZABETH HUGHITT, EXAMINING ATTORNEY

SN 77-539,059. AL RASHIDI AL MEZAN SWEETS DEVELOPING FACTORY CO. S.A.E., EL SAIEDA ZAINAB CAIRO, EGYPT, FILED 8-5-2008.

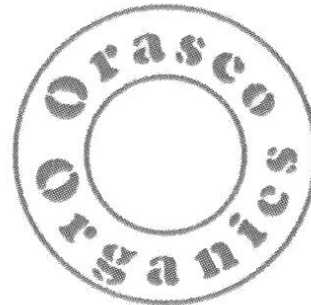

NO CLAIM IS MADE TO THE EXCLUSIVE RIGHT TO USE "ORGANICS", APART FROM THE MARK AS SHOWN. THE MARK CONSISTS OF THE WORDS "ORASCO ORGANICS" BETWEEN PARALLEL CIRCLES.

THE WORDING "ORASCO" HAS NO MEANING IN A FOREIGN LANGUAGE.

CLASS 29—MEATS AND PROCESSED FOODS

FOR ORGANIC TAHINI, NAMELY, ORGANIC SESAME SEED PASTE (U.S. CL. 46).

CLASS 30—STAPLE FOODS

FOR ORGANIC HALVAH (U.S. CL. 46).
WENDY JUN, EXAMINING ATTORNEY

CLASS 16—PAPER GOODS AND PRINTED MATTER

FOR ART AND PHOTOGRAPH PORTFOLIO CASES; MOUNTED AND UNMOUNTED PHOTOGRAPHS; PHOTOGRAPH ALBUM PAGES; PHOTOGRAPH ALBUMS; PHOTOGRAPH MOUNTS; PHOTOGRAPHIC ALBUMS; PHOTOGRAPHIC OR ART MOUNTS; PHOTOGRAPHS; PHOTOGRAPHS THAT HAVE BEEN COMPUTER MANIPULATED AND ENHANCED TO LOOK LIKE PAINTINGS (U.S. CLS. 2, 5, 22, 23, 29, 37, 38 AND 50).

CLASS 24—FABRICS

FOR BED AND TABLE LINEN; BED AND TABLE LINEN, WALL HANGINGS OF TEXTILE; BED BLANKETS; BED CANOPIES; BED COVERS; BED LINEN; BED LINEN AND TABLE LINEN; BED PADS; BED SHEETS; BED SHEETS OF PAPER; BED SHEETS, FITTED BED SHEET COVERS, BED FLAT SHEETS, AND PILLOW CASES USED IN THE BEDDING, HEALTH CARE, HOME-HEALTH CARE AND NURSING HOME INDUSTRIES MADE OF BIODEGRADABLE FILM CREATED FROM RENEWABLE BIO-POLYMER RESOURCES; BED SKIRTS; BED SPREADS; CONTOURED MATTRESS COVERS; COVERED RUBBER YARN FABRICS; COVERS FOR CUSHIONS; CUSHION COVERS; DUVET COVERS; EIDERDOWN COVERS; FABRIC COVERS FOR USE ON VARIOUS STRAPS; FEATHER BEDS; MATTRESS COVERS; PILLOW COVERS; SILK BED BLANKETS; UNFITTED FABRIC FURNITURE COVERS (U.S. CLS. 42 AND 50).

SN 77-541,702. DRAKE INTERNATIONAL MODELING & PERFORMING ARTS, INC., LONGWOOD, FL. FILED 8-7-2008.

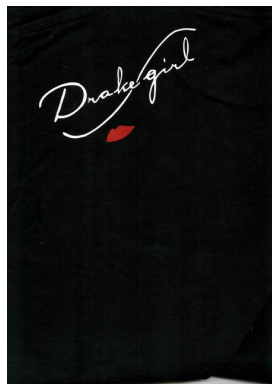

NO CLAIM IS MADE TO THE EXCLUSIVE RIGHT TO USE "GIRL", APART FROM THE MARK AS SHOWN. THE COLOR(S) BLACK, WHITE, RED IS/ARE CLAIMED AS A FEATURE OF THE MARK.

THE MARK CONSISTS OF THE MARK CONSISTS OF THE WORDS "DRAKE GIRL" WRITTEN AT A 20 DEGREE ANGLE IN WHITE COLOR ON A BLACK BACKGROUND; WITH A WHITE LINE IN S SHAPE THAT CROSSES IN BETWEEN WORDS AND RED LIPS BELOW THE WORD DRAKE.

CLASS 25—CLOTHING

FOR BELTS; CAPS; CLOTH BIBS FOR ADULT DINERS; CLOTHING, NAMELY, ARM WARMERS; CLOTHING, NAMELY, FOLK COSTUMES; CLOTHING, NAMELY, HAND-WARMERS; CLOTHING, NAMELY, KHAKIS; CLOTHING, NAMELY, KNEE WARMERS; CLOTHING, NAMELY, NECK TUBES; CLOTHING, NAMELY, THOBES; CLOTHING, NAMELY, WRAP-AROUNDS; CORSETS; FOULARDS; HOODS; JERSEYS; LEATHER BELTS; NON-DISPOSABLE CLOTH TRAINING PANTS; PAPER HATS FOR USE AS CLOTHING ITEMS; PARTS OF CLOTHING, NAMELY, GUSSETS FOR TIGHTS, GUSSETS FOR STOCKINGS, GUSSETS FOR BATHING SUITS, GUSSETS FOR UNDERWEAR, GUSSETS FOR LEOTARDS AND GUSSETS FOR FOOTLETS; SHORT SETS; SHOULDER WRAPS; SWADDLING CLOTHES; TIES; TOPS; TRAVEL CLOTHING CONTAINED IN A PACKAGE COMPRISING REVERSIBLE JACKETS, PANTS, SKIRTS, TOPS AND A BELT OR SCARF; UNDERARM CLOTHING SHIELDS; WEARABLE GARMENTS AND CLOTHING, NAMELY, SHIRTS; WRAPS (U.S. CLS. 22 AND 39).

CLASS 14—JEWELRY

FOR BEADS FOR USE IN THE MANUFACTURE OF JEWELRY; BRACELETS; BRONZE JEWELRY; BROOCHES; CHARMS; COSTUME JEWELRY; DIAMOND JEWELRY; GEMSTONE JEWELRY; IDENTIFICATION BRACELETS; JEWELRY; JEWELRY AND IMITATION JEWELRY; JEWELRY BOXES; JEWELRY BOXES NOT OF METAL; JEWELRY BOXES OF METAL; JEWELRY BOXES OF PRECIOUS METAL; JEWELRY CASES; JEWELRY CASES NOT OF PRECIOUS METAL; JEWELRY CASES OF PRECIOUS METAL; JEWELRY CASKETS; JEWELRY CASKETS OF PRECIOUS METAL; JEWELRY CHAINS; JEWELRY FINDINGS; JEWELRY FOR ATTACHMENT TO CLOTHING; JEWELRY FOR THE HEAD; JEWELRY IN THE NATURE OF ARMBANDS; JEWELRY ORGANIZERS; JEWELRY PINS FOR USE ON HATS; JEWELRY RING HOLDERS; JEWELRY TO BE AFFIXED TO BIKINIS; JEWELRY WATCHES; JEWELRY, NAMELY, AMULETS; JEWELRY, NAMELY, ANKLETS; JEWELRY, NAMELY, CROSSES; JEWELRY, NAMELY, PRECIOUS METAL PLATED REAL LEAVES AND FLOWERS; JEWELRY, NAMELY, STONE PENDANTS; LAPEL PINS; LEATHER JEWELRY AND ACCESSORY BOXES; METAL WIRE FOR USE IN THE MAKING OF JEWELRY, NAMELY, JEWELRY CABLE; PET JEWELRY; PINS BEING JEWELRY; PLASTIC BRACELETS IN THE NATURE OF JEWELRY; RINGS; RINGS BEING JEWELRY; WATCHES AND JEWELRY; WATCHES, CLOCKS, JEWELRY AND IMITATION JEWELRY (U.S. CLS. 2, 27, 28 AND 50).

CLASS 28—TOYS AND SPORTING GOODS

FOR BABY MULTIPLE ACTIVITY TOYS; BATH TOYS; BATHTUB TOYS; BATTERY OPERATED ACTION TOYS; BENDABLE TOYS; CAPS FOR TOY PISTOLS; CASES FOR TOY STRUCTURES; CASES FOR TOY VEHICLES; CAT TOYS; CHILDREN'S ACTIVITY TABLES CONTAINING MANIPULATIVE TOYS WHICH CONVERT TO EASELS; CHILDREN'S MULTIPLE ACTIVITY TOYS; CHILDREN'S MULTIPLE ACTIVITY TOYS SOLD AS A UNIT WITH PRINTED BOOKS; CHILDREN'S WIRE CONSTRUCTION AND ART ACTIVITY TOYS; CLOCKWORK TOYS; CLOCKWORK TOYS; COLLECTABLE TOY FIGURES; CONSTRUCTION TOYS; CRIB TOYS; DISC TOSS TOYS; DOG TOYS; DRAWING TOYS; INFLATABLE TOYS; INFLATABLE TOYS SHOWING DECORATIVE PICTURES; LEVER ACTION TOYS; MECHANICAL ACTION TOYS; MECHANICAL TOYS; MINIATURE TOY HELMETS; MODEL TOY STEAM ENGINES; MODEL TOY STEAM OPERATED TRACTION ENGINES; MODELED PLASTIC TOY FIGURINES; MOLDED TOY FIGURES; MUSIC BOX TOYS; MUSICAL TOYS; NON-ELECTRONIC TOY VEHICLES; NON-RIDING TRANSPORTATION TOYS; NOVELTY TOY ITEM IN THE NATURE OF A DISPENSER OF STREAM MATERIAL; PARTY FAVORS IN THE NATURE OF SMALL TOYS; PET TOYS; PET TOYS CONTAINING CATNIP; PET TOYS MADE OF ROPE; PLASTIC CHAR-

ACTER TOYS; PLASTIC TOY HOOPS; PLAY MATS CONTAINING INFANT TOYS; PLAY MATS FOR USE WITH TOY VEHICLES; PLUSH TOYS; POP UP TOYS; POSITIONABLE PRINTED TOY FIGURES FOR USE IN GAMES; POSITIONABLE PRINTED TOY FIGURES FOR USE IN PUZZLES; POSITIONABLE THREE DIMENSIONAL TOYS FOR USE IN GAMES; POSITIONABLE TOY FIGURES; POSITIONABLE TWO DIMENSIONAL TOYS FOR USE IN GAMES; PRINTED POSITIONABLE TOYS FOR USE IN CHILDREN'S BOARD GAMES; PRINTING TOYS; PULL TOYS; PUNCHING TOYS; PUSH TOYS; RADIO CONTROLLED TOY VEHICLES; RADIO TRANSMITTERS FOR USE WITH RADIO-CONTROLLED TOYS; RIDE-ON TOYS; RUBBER CHARACTER TOYS; SAND TOYS; SANDBOX TOYS; SKETCHING TOYS; SOFT SCULPTURE PLUSH TOYS; SOFT SCULPTURE TOYS; SQUEEZABLE SQUEAKING TOYS; SQUEEZE TOYS; STACKING TOYS; STUFFED AND PLUSH TOYS; STUFFED TOY ANIMALS; STUFFED TOY BEARS; STUFFED TOYS; TALKING ELECTRONIC PRESS-DOWN TOY; TALKING TOYS; TESSELATION TOYS; TOSSING DISC TOYS; TOY ACTION FIGURES; TOY ACTION FIGURES AND ACCESSORIES THEREFOR; TOY AIRPLANES; TOY AND NOVELTY FACE MASKS; TOY ANIMALS; TOY ANIMALS AND ACCESSORIES THEREFOR; TOY ARMOR; TOY ARTIFICIAL FINGERNAILS; TOY BAKEWARE AND COOKWARE; TOY BALLOONS; TOY BANKS; TOY BOWS AND ARROWS; TOY BOXES; TOY BUILDING BLOCKS; TOY BUILDING BLOCKS CAPABLE OF INTERCONNECTION; TOY BUILDING STRUCTURES AND TOY VEHICLE TRACKS; TOY BUILDINGS AND ACCESSORIES THEREFOR; TOY BUTTERFLY NETS; TOY CAP PISTOLS; TOY CARS; TOY CHRISTMAS TREES; TOY CLOCKS AND WATCHES; TOY CONSTRUCTION BLOCKS; TOY CONSTRUCTION SETS; TOY FIGURES; TOY FILM CARTRIDGES AND VIEWERS; TOY FURNITURE; TOY GLIDERS; TOY GLOCKENSPIELS; TOY GUNS; TOY HARMONICAS; TOY HOLSTERS; TOY HOOP SETS; TOY HOUSES; TOY MAILBOXES; TOY MASKS; TOY MOBILES; TOY MODEL CARS; TOY MODEL GUITARS; TOY MODEL HOBBYCRAFT KITS; TOY MODEL KIT CARS; TOY MODEL TRAIN SETS; TOY MODEL VEHICLES AND RELATED ACCESSORIES SOLD AS UNITS; TOY MODELING DOUGH; TOY MUSIC BOXES; TOY NOISEMAKERS; TOY PIANOS; TOY PIANOS, SOLD AS AS A UNIT WITH PRINTED BOOKS IN THE FIELD OF MUSIC EDUCATION; TOY PISTOLS; TOY PRISM GLASSES; TOY PUTTY; TOY RECORD PLAYERS; TOY ROBOTS; TOY ROCKETS; TOY SCOOTERS; TOY SETS OF CARPENTERS' TOOLS; TOY SNOW GLOBES; TOY STAMPS; TOY SWORDS; TOY TRAINS AND PARTS AND ACCESSORIES THEREFOR; TOY VEHICLE TRACK SETS AND ROADWAYS AND ACCESSORIES THEREFOR; TOY VEHICLES; TOY VEHICLES AND ACCESSORIES THEREFOR; TOY VEHICLES WITH TRANSFORMING PARTS; TOY WATCHES; TOY WATER GLOBES; TOY WEAPONS; TOY WHISTLES; TOY WIND SOCKS; TOY XYLOPHONES; TOY ZIP GUNS; TOY, NAMELY, BATTERY-POWERED COMPUTER GAME WITH LCD SCREEN WHICH FEATURES ANIMATION AND SOUND EFFECTS; TOYS FOR DOMESTIC PETS; TOYS, NAMELY, A DISK TO TOSS IN PLAYING A GAME WHEREIN OTHER DISKS ARE FLIPPED AND COLLECTED; TOYS, NAMELY, CHILDREN'S DRESS-UP ACCESSORIES; TRANSFORMING ROBOTIC TOY VEHICLES; TRANSFORMING ROBOTIC TOYS; TWO AND THREE DIMENSIONAL POSITIONABLE FIGURES SOLD AS AN INTEGRAL COMPONENT OF TOYS; TWO AND THREE DIMENSIONAL POSITIONABLE TOY FIGURES SOLD AS A UNIT WITH EDUCATIONAL BOOKS; TWO AND THREE DIMENSIONAL POSITIONABLE TOY FIGURES SOLD AS A UNIT WITH MEMORY TRAINING EQUIPMENT.; TWO AND THREE DIMENSIONAL POSITIONABLE TOY FIGURES SOLD AS A UNIT WITH OTHER TOYS; WATER SQUIRTING TOYS; WIND-UP TOYS; WIND-UP WALKING TOYS (U.S. CLS. 22, 23, 38 AND 50).

CLASS 41—EDUCATION AND ENTERTAINMENT

FOR ARRANGING AND CONDUCTING EDUCATIONAL CONFERENCES; CHILDREN'S EDUCATIONAL SERVICES, NAMELY, PROVIDING ACADEMIC PERFORMANCE EVALUATION, GUIDANCE AND MONITORING FOR CHILDREN PRE-KINDERGARTEN THROUGH GRADE 12 VIA THE INTERNET; COMPUTER EDUCATION TRAINING; COMPUTER EDUCATION TRAINING SERVICES; CONSULTATION IN THE FIELD OF K-12 EDUCATIONAL SYSTEMS; EDUCATION INFORMATION; EDUCATION SERVICES IN THE NATURE OF EARLY CHILDHOOD INSTRUCTION; EDUCATION SERVICES, NAMELY, A YEAR-LONG URBAN TEACHER PREPARATION PROGRAM FOR EMERGING TEACHERS; EDUCATION SERVICES, NAMELY, PROVIDING CLASSES, SEMINARS, WORKSHOPS, TUTORING, AND MENTORING IN THE FIELD OF MIDDLE AND HIGH SCHOOL REFORM; EDUCATIONAL AND ENTERTAINMENT SERVICES, NAMELY, PROVIDING MOTIVATIONAL AND EDUCATIONAL SPEAKERS; EDUCATIONAL AND ENTERTAINMENT SERVICES, NAMELY, PROVIDING MOTIVATIONAL AND EDUCATIONAL SPEAKERS IN THE FIELD OF SELF- AND PERSONAL IMPROVEMENT; EDUCATIONAL ASSESSMENT; EDUCATIONAL COURSE MONITORING, NAMELY, TRACKING STUDENT PERFORMANCE; EDUCATIONAL DEMONSTRATIONS; EDUCATIONAL EXAMINATION; EDUCATIONAL EXAMINATION SERVICES; EDUCATIONAL PROGRAMS, NAMELY, PRE-SCHOOLS; EDUCATIONAL RESEARCH; EDUCATIONAL RESEARCH SERVICES VIA INTERNET; EDUCATIONAL SERVICES IN THE NATURE OF BEAUTY SCHOOLS; EDUCATIONAL SERVICES IN THE NATURE OF CORRESPONDENCE SCHOOLS; EDUCATIONAL SERVICES, NAMELY LECTURES, SEMINARS, CONFERENCES AND UNIVERSITY COURSES CONCERNING WORLD WIDE HUNGER; EDUCATIONAL SERVICES, NAMELY, A LEARNING AND INNOVATION CENTER FEATURING FULLY CUSTOMIZED LEADERSHIP, MOTIVATIONAL, EDUCATIONAL, AND BRAINSTORMING TRAINING; EDUCATIONAL SERVICES, NAMELY, CONDUCTING CHESS CLASSES BY MEANS OF A CHESS CLUB; EDUCATIONAL SERVICES, NAMELY, CONDUCTING SEMINARS, LECTURES, TELESEMINARS, TELECLASSES, AND WORKSHOPS IN PERSONAL AWARENESS; EDUCATIONAL SERVICES, NAMELY, DEVELOPING AND CONDUCTING TRAINING COURSES AND DISTRIBUTION OF TRAINING MATERIALS IN CONNECTION THEREWITH FOR SUBJECT MATTERS AS REQUESTED BY CUSTOMERS; EDUCATIONAL SERVICES, NAMELY, DEVELOPING AND CONDUCTING WORKOUTS, WORKSHOPS, PRESENTATIONS, RETREATS, AND PERSONAL TRAINING IN RIGHT-BRAIN FITNESS; EDUCATIONAL SERVICES, NAMELY, PROVIDING DOLLS AND TOYS DESIGNED TO TEACH ABOUT AND PROMOTE DENTAL HEALTH; EDUCATIONAL SERVICES, NAMELY, THE OFFERING OF WEB BASED AND CLASSROOM TRAINING FOR CERTIFICATION OF TEACHERS AND CONTINUING EDUCATION FOR TEACHERS AND PRINCIPALS; ENTERTAINMENT AND EDUCATIONAL SERVICES, NAMELY, PROVIDING ADVICE AND INFORMATION FOR MUSIC, VIDEO AND FILM CONCEPT AND SCRIPT DEVELOPMENT; INFORMATION ABOUT EDUCATION; INFORMATION IN THE FIELD OF PARENTING CONCERNING EDUCATION OF CHILDREN; INFORMATION ON EDUCATION; INFORMATION RELATING TO ENTERTAINMENT AND EDUCATION, PROVIDED ON-LINE FROM A COMPUTER DATABASE OR THE INTERNET; ON-LINE EDUCATION CREDIT AND DEGREE EVALUATION AND COMPARISON SERVICES; ON-LINE EDUCATIONAL PARENTAL TRAINING CLASSES; ORGANISATION OF EXHIBITIONS FOR CULTURAL OR EDUCATIONAL PURPOSES; ORGANIZATION OF EXHIBITIONS FOR CULTURAL OR EDUCATIONAL PURPOSES; PROVIDING ADVICE AND INFORMATION IN THE FIELD OF EDUCATIONAL AND ENTERTAINMENT ACTIVITIES AND EVENTS FOR CHILDREN; PROVIDING AN INTERACTIVE WEB SITE FEATURING EDUCATIONAL INFORMATION AND TEST QUESTIONS IN THE FIELD OF MATHEMATICS; PROVIDING FACILITIES FOR MOVIES, SHOWS, PLAYS, MUSIC OR EDUCATIONAL TRAINING; PROVIDING INFORMATION AND NEWS IN THE FIELD OF TEACHING METHODOLOGY AND EDUCATION; PROVIDING ON-LINE RESOURCE GUIDES FOR

RELATIVES CONCERNING CHILDREN IN THE FIELDS OF EDUCATION, RECREATION, AND ENTERTAINMENT; PROVIDING SCIENCE EDUCATIONAL MENTORING SERVICES AND PROGRAMS; RENTAL OF ANATOMICAL MODELS FOR EDUCATIONAL PURPOSES (U.S. CLS. 100, 101 AND 107).

CLASS 44—MEDICAL, BEAUTY AND AGRICULTURAL SERVICES

FOR BEAUTY SALONS; BEAUTY SPA SERVICES, NAMELY, COSMETIC BODY CARE; CHARITABLE SERVICES, NAMELY, PROVIDING BEAUTY AND HAIR CARE SERVICES TO PERSONS SEEKING EMPLOYMENT; HYGIENIC AND BEAUTY CARE; MAKING RESERVATIONS AND BOOKINGS FOR OTHERS AT BEAUTY SALONS; MAKING RESERVATIONS AND BOOKINGS FOR OTHERS FOR PHYSICAL AND BEAUTY TREATMENTS AT HEALTH SPAS; MEDICAL, HYGIENIC AND BEAUTY CARE; PROVIDING INFORMATION ABOUT BEAUTY; PROVIDING NEWS AND INFORMATION IN THE FIELD OF PERSONAL BEAUTY (U.S. CLS. 100 AND 101).

HEATHER SAPP, EXAMINING ATTORNEY

SN 77-542.361. ILLINOIS INDUSTRIAL TOOL, INC., DBA MIDWEST TOOL DISTRIBUTORS, INC., BRIDGEVIEW, IL. FILED 8-8-2008.

ILLINOIS INDUSTRIAL TOOL

THE MARK CONSISTS OF STANDARD CHARACTERS WITHOUT CLAIM TO ANY PARTICULAR FONT, STYLE, SIZE, OR COLOR.

NO CLAIM IS MADE TO THE EXCLUSIVE RIGHT TO USE "INDUSTRIAL TOOL", APART FROM THE MARK AS SHOWN.

SEC. 2(F).

CLASS 6—METAL GOODS

FOR METAL CLAMPS; METAL HOSE FITTINGS; METAL PADLOCKS; SPRING-RETRACTED METAL HOSE REELS (U.S. CLS. 2, 12, 13, 14, 23, 25 AND 50).

FIRST USE 8-1-1994; IN COMMERCE 9-1-1994.

CLASS 7—MACHINERY

FOR AIR BRUSHES FOR APPLYING PAINT; AIR COMPRESSORS; AIR POWERED TOOLS, NAMELY, AIR BLOW GUNS; BLADES FOR POWER SAWS; CUTTING TORCHES; ELECTRIC SANDERS; HOISTS; HYDRAULIC JACKS; IMPACT WRENCHES; PORTABLE ELECTRIC POWER GENERATORS; POWER DRILL BITS; POWER DRILLS; POWER TOOLS, NAMELY, DRILL PRESSES; POWER-OPERATED GRINDING WHEELS; POWER-OPERATED SAWS; POWER-OPERATED TOOLS, NAMELY, GRINDERS; SAND-BLASTING APPARATUS; WASHING MACHINE FOR INDUSTRIAL PARTS; WINCHES (U.S. CLS. 13, 19, 21, 23, 31, 34 AND 35).

FIRST USE 8-1-1994; IN COMMERCE 9-1-1994.

CLASS 8—HAND TOOLS

FOR AXES; BLADES FOR HAND SAWS; BLADES FOR UTILITY KNIVES; CARPENTERS' PINNERS; EXTENSION BARS FOR HAND TOOLS; FILES; GARDENING TOOLS, NAMELY, SHOVELS, HOES, WEEDING FORKS AND SPADES; HAND OPERATED PLUMBING SNAKES; HAND SAWS, NAMELY, HACK SAWS; HAND SAWS, NAMELY, WOOD SAWS; HAND TOOLS, NAMELY, AUTOMOBILE SHEET METAL DENT REPAIR TOOL; HAND TOOLS, NAMELY, HAMMERS; HAND TOOLS, NAMELY, HEX KEYS WRENCHES; HAND TOOLS, NAMELY, NUT DRIVERS; HAND TOOLS, NAMELY, PICKS; HAND TOOLS, NAMELY, PUNCHES; HAND TOOLS, NAMELY, RASPS; HAND TOOLS, NAMELY, RATCHET WRENCHES; HAND TOOLS, NAMELY, SCRAPERS; HAND TOOLS, NAMELY, SOCKET SETS; HAND TOOLS, NAMELY, SOCKET WRENCHES; HAND TOOLS, NAMELY, TAPS; HAND TOOLS, NAMELY, WRENCHES; HAND TOOLS, NAMELY, BOLT CUTTERS, GEAR PULLERS, SUCTION CUP LIFTERS, PRY BARS, TUBING CUTTERS, TUBING FLARING TOOLS, AND PICK-UP TOOLS; HAND-OPERATED RIVETING TOOLS; HAND-OPERATED TOOLS, NAMELY, CHISELS; KNIVES; MALLET; PIPE WRENCHES; PLIERS; PUTTY KNIVES; SAFETY RAZORS; SAWS; SCREWDRIVERS; SNIPS; TWEEZERS; UTILITY KNIVES (U.S. CLS. 23, 28 AND 44).

FIRST USE 8-1-1994; IN COMMERCE 8-1-1994.

CLASS 9—ELECTRICAL AND SCIENTIFIC APPARATUS

FOR ADAPTERS; CIRCUIT TESTERS; ELECTRICAL CONNECTORS; MULTI-OUTLET SOCKET BLOCKS; TAPE MEASURES; WELDING HELMETS (U.S. CLS. 21, 23, 26, 36 AND 38).

FIRST USE 8-1-1994; IN COMMERCE 9-1-1994.

CLASS 17—RUBBER GOODS

FOR ADHESIVE TAPE FOR INDUSTRIAL AND COMMERCIAL USE; AIR HOSES; DUCT TAPE; ELECTRICAL TAPE; INSULATING SPLICE COVER FOR ELECTRICAL CABLE; PIPE JOINT TAPE (U.S. CLS. 1, 5, 12, 13, 35 AND 50).

FIRST USE 8-1-1994; IN COMMERCE 9-1-1994.

CLASS 22—CORDAGE AND FIBERS

FOR SHOCK CORDS NOT OF METAL; TARPULINS; TIE DOWN STRAPS (U.S. CLS. 1, 2, 7, 19, 22, 42 AND 50).

FIRST USE 8-1-1994; IN COMMERCE 8-1-1994.

ALYSSA STEEL, EXAMINING ATTORNEY

SN 77-542.506. MICHAEL'S MISSION, INC., NEW YORK, NY. FILED 8-8-2008.

MICHAEL'S MISSION

THE MARK CONSISTS OF STANDARD CHARACTERS WITHOUT CLAIM TO ANY PARTICULAR FONT, STYLE, SIZE, OR COLOR.

THE NAME "MICHAEL" WITHIN THE APPLICANT'S MARK DOES NOT IDENTIFY THE NAME OF A LIVING INDIVIDUAL.

CLASS 36—INSURANCE AND FINANCIAL

FOR CHARITABLE FUNDRAISING SERVICES FOR COLORECTAL CANCER AND OTHER INFLAMMATORY BOWEL DISEASES (U.S. CLS. 100, 101 AND 102).

CLASS 44—MEDICAL, BEAUTY AND AGRICULTURAL SERVICES

FOR PROVIDING HEALTH INFORMATION IN THE FIELDS OF COLORECTAL CANCER AND OTHER INFLAMMATORY BOWEL DISEASES (U.S. CLS. 100 AND 101).

JAY FLOWERS, EXAMINING ATTORNEY

SN 77-545,157. LYKES BROS. INC., TAMPA, FL. FILED 8-12-2008.



OWNER OF U.S. REG. NO. 2,850,186.
NO CLAIM IS MADE TO THE EXCLUSIVE RIGHT TO USE "BRANDS", APART FROM THE MARK AS SHOWN.
THE MARK CONSISTS OF THE NUMBER "7" AND THE LETTER "L" IN THE MIDDLE OF A CIRCLE WITH A LINE ENCIRCLING THE OUTSIDE OF THE CIRCLE AND THE WORD "BRANDS" UNDERNEATH THE CIRCLE.

CLASS 4—LUBRICANTS AND FUELS

FOR CHARCOAL BRIQUETTES (U.S. CLS. 1, 6 AND 15).

CLASS 31—NATURAL AGRICULTURAL PRODUCTS

FOR MULCH; PINE NEEDLES; SOD; LIVE LANDSCAPE TREES; AND TOP SOIL (U.S. CLS. 1 AND 46).

KATHERINE STOIDES, EXAMINING ATTORNEY

SN 77-545,665. ATRIUS HEALTH, INC., NEWTON, MA. FILED 8-13-2008.

HEALTHICIZE

THE MARK CONSISTS OF STANDARD CHARACTERS WITHOUT CLAIM TO ANY PARTICULAR FONT, STYLE, SIZE, OR COLOR.

CLASS 41—EDUCATION AND ENTERTAINMENT

FOR EDUCATIONAL SERVICES, NAMELY, CLASSES AND SEMINARS IN THE FIELD OF CPR AND FIRST AID, GENERAL HEALTH AND FITNESS, MIND/BODY, PARENTING, PREGNANCY AND CHILDBIRTH, SEXUALITY AND REPRODUCTION, SMOKING AND SUBSTANCE ABUSE, SPECIAL MEDICAL PROGRAMS, WOMEN'S HEALTH, MEN'S HEALTH, SUPPORT GROUPS, AND HEALTH, MEDICAL AND WELLNESS CLASSES FOR CHILDREN AND TEENS (U.S. CLS. 100, 101 AND 107).

CLASS 44—MEDICAL, BEAUTY AND AGRICULTURAL SERVICES

FOR MEDICAL SERVICES; HEALTH CARE SERVICES, NAMELY, WELLNESS PROGRAMS; DENTIST SERVICES; DENTAL HYGIENIST SERVICES; AND PROVIDING HEALTH, MEDICAL AND WELLNESS INFORMATION VIA THE INTERNET, NAMELY, PROVIDING INFORMATION AND LINKS TO WEBSITES AND COMPUTERIZED ONLINE DATABASES IN THE FIELDS OF CPR AND FIRST AID, GENERAL HEALTH AND FITNESS, MIND/BODY, PARENTING, PREGNANCY AND CHILDBIRTH, SEXUALITY AND REPRODUCTION, SMOKING AND SUBSTANCE ABUSE, WOMEN'S HEALTH, MEN'S HEALTH, SUPPORT GROUPS, AND HEALTH AND WELLNESS FOR CHILDREN AND TEENS (U.S. CLS. 100 AND 101).

JORDAN BAKER, EXAMINING ATTORNEY

SN 77-546,005. DR. SEUSS ENTERPRISES, L.P., LA JOLLA, CA. FILED 8-13-2008.

A PERSON'S A PERSON NO MATTER HOW SMALL

THE MARK CONSISTS OF STANDARD CHARACTERS WITHOUT CLAIM TO ANY PARTICULAR FONT, STYLE, SIZE, OR COLOR.

CLASS 16—PAPER GOODS AND PRINTED MATTER

FOR CHILDREN'S BOOKS, COLORING BOOKS, CRAYONS, REUSABLE STICKER BOOKS, PAINT BOX BOOKS, POSTERS (U.S. CLS. 2, 5, 22, 23, 29, 37, 38 AND 50).

FIRST USE 1-0-2008; IN COMMERCE 1-0-2008.

CLASS 25—CLOTHING

FOR CHILDREN'S CLOTHING, NAMELY, TOPS, BOTTOMS, ONE PIECE GARMENTS FOR INFANTS AND TODDLERS, T-SHIRTS (U.S. CLS. 22 AND 39).

FIRST USE 1-7-2008; IN COMMERCE 1-7-2008.

CLASS 28—TOYS AND SPORTING GOODS

FOR FINGER PUPPETS (U.S. CLS. 22, 23, 38 AND 50).
FIRST USE 1-0-2002; IN COMMERCE 1-0-2002.

SHAUNIA CARLYLE, EXAMINING ATTORNEY

SN 77-546,319. JOHN DERIAN COMPANY, INC., NEW YORK, NY. FILED 8-13-2008.



OWNER OF U.S. REG. NO. 3,292,871.
 THE NAME(S), PORTRAIT(S), AND/OR SIGNATURE(S) SHOWN IN THE MARK IDENTIFIES "JOHN DERIAN", WHOSE CONSENT(S) TO REGISTER IS MADE OF RECORD.
 THE MARK CONSISTS OF THE WORDS "JOHN DERIAN" IN SIGNATURE STYLE.

CLASS 11—ENVIRONMENTAL CONTROL APPARATUS

FOR LAMPS (U.S. CLS. 13, 21, 23, 31 AND 34).
 FIRST USE 1-1-1983; IN COMMERCE 1-1-1983.

CLASS 16—PAPER GOODS AND PRINTED MATTER

FOR PAPERWEIGHTS (U.S. CLS. 2, 5, 22, 23, 29, 37, 38 AND 50).
 FIRST USE 1-1-1983; IN COMMERCE 1-1-1983.

CLASS 21—HOUSEWARES AND GLASS

FOR BOWLS; CAKE DOMES; CAKE STANDS; COASTERS NOT OF PAPER AND NOT BEING TABLE LINEN; DECORATIVE PLATES; PLATES; TRAYS; VASES (U.S. CLS. 2, 13, 23, 29, 30, 33, 40 AND 50).
 FIRST USE 1-1-1983; IN COMMERCE 1-1-1983.
 ANDREA HACK, EXAMINING ATTORNEY

CLASS 9—ELECTRICAL AND SCIENTIFIC APPARATUS

FOR DOWNLOADABLE POD CASTS FEATURING ENTERTAINING VIDEO AND AUDIO IN THE FIELD OF PREGNANCY; DOWNLOADABLE MULTIMEDIA FILE CONTAINING ENTERTAINING AUDIO AND VIDEO IN THE FIELD OF PREGNANCY (U.S. CLS. 21, 23, 26, 36 AND 38).
 FIRST USE 3-0-2008; IN COMMERCE 3-0-2008.

CLASS 41—EDUCATION AND ENTERTAINMENT

FOR PROVIDING INFORMATION IN THE FIELD OF PARENTING CONCERNING EDUCATION AND ENTERTAINMENT OF CHILDREN; PROVIDING INFORMATION IN THE FIELD OF EXERCISE AND FITNESS DURING AND AFTER PREGNANCY (U.S. CLS. 100, 101 AND 107).
 FIRST USE 3-0-2008; IN COMMERCE 3-0-2008.

CLASS 44—MEDICAL, BEAUTY AND AGRICULTURAL SERVICES

FOR PROVIDING MEDICAL INFORMATION IN THE FIELDS OF PREGNANCY, PRENATAL CARE FOR EXPECTING PARENTS AND UNBORN BABY, FETUS DEVELOPMENT, INFANT DEVELOPMENT, CHILD BIRTHING PRACTICES, CHILD BIRTH, BREASTFEEDING, EARLY CHILDHOOD DEVELOPMENT; PROVIDING INFORMATION IN THE FIELD OF PARENTING CONCERNING THE HEALTH OF CHILDREN (U.S. CLS. 100 AND 101).
 FIRST USE 3-0-2008; IN COMMERCE 3-0-2008.
 LAURIE KAUFMAN, EXAMINING ATTORNEY

SN 77-547,214. BATTS, PEGGY, DBA HILLHOUSE NATURAL FARM, WICKLIFFE, KY. FILED 8-14-2008.

SN 77-547,055. HILDRETH MEDIA GROUP INC., SAN DIEGO, CA. FILED 8-14-2008.



THE COLOR(S) PINK, PEACH, ORANGE AND WHITE IS/ARE CLAIMED AS A FEATURE OF THE MARK.
 THE MARK CONSISTS OF A PREGNANT WOMEN'S PEACH TORSO AREA WITH THE IMAGE OF A WHITE SMILING FACE ON THE PEACH STOMACH, WEARING A PINK T-SHIRT AND PINK SWEATPANTS, WITH AN ORANGE WAISTBAND ON THE SWEATPANTS.

Hillhouse Natural Living

THE MARK CONSISTS OF STANDARD CHARACTERS WITHOUT CLAIM TO ANY PARTICULAR FONT, STYLE, SIZE, OR COLOR.
 NO CLAIM IS MADE TO THE EXCLUSIVE RIGHT TO USE "NATURAL", APART FROM THE MARK AS SHOWN.

CLASS 3—COSMETICS AND CLEANING PREPARATIONS

FOR BODY CREAM; FRAGRANCE EMITTING WICKS FOR ROOM FRAGRANCE; POTPOURRI; ROOM FRAGRANCES; SACHETS; SCENTED LINEN WATER (U.S. CLS. 1, 4, 6, 50, 51 AND 52).

CLASS 4—LUBRICANTS AND FUELS

FOR CANDLES; SCENTED CANDLES (U.S. CLS. 1, 6 AND 15).
 SIMON TENG, EXAMINING ATTORNEY

SN 77-548,436. NICOR, INC., ALBUQUERQUE, NM. FILED 8-15-2008.

SHINING BRIGHTER

THE MARK CONSISTS OF STANDARD CHARACTERS WITHOUT CLAIM TO ANY PARTICULAR FONT, STYLE, SIZE, OR COLOR.

CLASS 9—ELECTRICAL AND SCIENTIFIC APPARATUS

FOR ELECTRIC OUTLET COVERS; ELECTRICAL OUTLET PLATES; ELECTRICAL OUTLET TESTER; ELECTRICAL OUTLETS (U.S. CLS. 21, 23, 26, 36 AND 38).

FIRST USE 1-15-2006; IN COMMERCE 1-15-2006.

CLASS 11—ENVIRONMENTAL CONTROL APPARATUS

FOR CEILING FANS; CEILING LIGHTS; ELECTRIC LAMPS; ELECTRIC LIGHTING FIXTURES; FLUORESCENT LAMPS (U.S. CLS. 13, 21, 23, 31 AND 34).

FIRST USE 1-15-2006; IN COMMERCE 1-15-2006.
DAVID MILLER, EXAMINING ATTORNEY

SN 77-548,533. SOFA MART, LLC, DENVER, CO. FILED 8-15-2008.

SOFA SMART. MADE WITH YOU
AND THE ENVIRONMENT IN
MIND.

THE MARK CONSISTS OF STANDARD CHARACTERS WITHOUT CLAIM TO ANY PARTICULAR FONT, STYLE, SIZE, OR COLOR.

NO CLAIM IS MADE TO THE EXCLUSIVE RIGHT TO USE "SOFA", APART FROM THE MARK AS SHOWN.

CLASS 20—FURNITURE AND ARTICLES NOT OTHERWISE CLASSIFIED

FOR FURNITURE (U.S. CLS. 2, 13, 22, 25, 32 AND 50).

CLASS 35—ADVERTISING AND BUSINESS

FOR RETAIL FURNITURE STORE SERVICES; ONLINE RETAIL FURNITURE STORE SERVICES (U.S. CLS. 100, 101 AND 102).

KELLY CHOE, EXAMINING ATTORNEY

SN 77-549,270. TERRANCE BRENNAN, NEW YORK, NY. FILED 8-18-2008.

THE ARTISANAL TABLE

THE MARK CONSISTS OF STANDARD CHARACTERS WITHOUT CLAIM TO ANY PARTICULAR FONT, STYLE, SIZE, OR COLOR.

CLASS 35—ADVERTISING AND BUSINESS

FOR RETAIL STORES FEATURING GOURMET FOODS (U.S. CLS. 100, 101 AND 102).

CLASS 43—HOTEL AND RESTAURANT SERVICES

FOR RESTAURANTS (U.S. CLS. 100 AND 101).
LAKEISHA LEWIS, EXAMINING ATTORNEY

SN 77-549,763. RELIV' INTERNATIONAL, INC., CHESTERFIELD, MO. FILED 8-18-2008.

RELIVABLES

THE MARK CONSISTS OF STANDARD CHARACTERS WITHOUT CLAIM TO ANY PARTICULAR FONT, STYLE, SIZE, OR COLOR.

OWNER OF U.S. REG. NOS. 1,759,404, 3,015,586 AND OTHERS.

CLASS 3—COSMETICS AND CLEANING PREPARATIONS

FOR COSMETICS, CLEANING PREPARATIONS, FACIAL AND SKIN CREAMS; NON-MEDICATED TOILETRIES (U.S. CLS. 1, 4, 6, 50, 51 AND 52).

CLASS 5—PHARMACEUTICALS

FOR NUTRITIONAL, HERBAL, VITAMIN AND DIETARY SUPPLEMENTS; MEDICATED FACIAL CREAMS AND MEDICATED TOILETRIES, NAMELY, MEDICATED SKIN LOTIONS AND CREAMS, AND MEDICATED SKIN CLEANSING PREPARATIONS (U.S. CLS. 6, 18, 44, 46, 51 AND 52).

MELISSA VALLILLO, EXAMINING ATTORNEY

SN 77-550,964. ELIXIR GROUP LIMITED, CENTRAL, HONG KONG, FILED 8-19-2008.



NO CLAIM IS MADE TO THE EXCLUSIVE RIGHT TO USE "GAMING", APART FROM THE MARK AS SHOWN. THE COLOR(S) BLACK AND BLUE IS/ARE CLAIMED AS A FEATURE OF THE MARK.

THE MARK CONSISTS OF A FANCIFUL CIRCULAR DESIGN IN THE COLOR BLUE WITH THE WORDS "ELIXIR GAMING" IN STYLIZED LETTERS PLACED ADJACENT THERETO. THE LETTERS "E", "L", "I" AND "R" IN THE WORD "ELIXIR", AND THE WORD "GAMING" ARE IN THE COLOR BLACK. THE LETTER "X" IN THE WORD "ELIXIR" IS IN THE COLOR BLUE AND IS EMBEDDED IN THE FANCIFUL CIRCULAR DESIGN.

CLASS 9—ELECTRICAL AND SCIENTIFIC APPARATUS

FOR GAMBLING MACHINES; SLOT MACHINES; COIN CHANGERS; PRE-RECORDED DATA CARRIERS PROGRAMMED FOR ELECTRONIC VIDEO AND AUDIO DISPLAYS FOR PLAYING GAMING, GAMBLING AND LOTTERY MACHINES; COMPUTER SOFTWARE FOR OPERATING ELECTRIC AND ELECTRONIC MACHINES FOR GAMBLING, GAMING, LOTTERIES, AMUSEMENT AND ENTERTAINMENT PURPOSES (U.S. CLS. 21, 23, 26, 36 AND 38).

CLASS 37—CONSTRUCTION AND REPAIR

FOR INSTALLATION, REPAIR AND MAINTENANCE OF GAMBLING MACHINES; INSTALLATION, REPAIR AND MAINTENANCE OF COMPUTER HARDWARE FOR USE IN THE OPERATION OF AMUSEMENT GAMES, LOTTERIES, GAMBLING AND SLOT MACHINES, AND VIDEO GAMING MACHINES; DEVELOPMENT SERVICES, NAMELY, CONSTRUCTION OF AMUSEMENT ARCADES, CASINO, GAMING AND GAMBLING CENTERS, CAFES AND CAFETERIAS (U.S. CLS. 100, 103 AND 106).

CLASS 42—SCIENTIFIC AND COMPUTER SERVICES

FOR RESEARCH AND DEVELOPMENT SERVICES FOR GAMING AND GAMBLING MACHINES; SURVEYING; DEVELOPMENT OF NEW PRODUCTS FOR OTHERS; TECHNICAL CONSULTATION IN THE FIELD OF COMPUTER SOFTWARE AND HARDWARE FOR USE IN THE OPERATION OF AMUSEMENT GAMES, LOTTERIES, GAMBLING AND SLOT MACHINES; AND CONSTRUCTION, INSTALLATION, REPAIR AND MAINTENANCE OF COMPUTER SOFTWARE FOR USE IN THE OPERATION OF AMUSEMENT GAMES, LOTTERIES, GAMBLING AND SLOT MACHINES, AND VIDEO GAMING MACHINES (U.S. CLS. 100 AND 101).
EDWARD FENNESSY, EXAMINING ATTORNEY

CLASS 35—ADVERTISING AND BUSINESS

FOR BUSINESS MANAGEMENT CONSULTATION FOR EMERGENCY MEDICAL DEPARTMENTS, NAMELY, CONSULTATION IN THE FIELDS OF IMPROVING EMERGENCY DEPARTMENT PERFORMANCE, HANDLING OF MEDICAL RECORDS, DESIGNING MEDICAL RECORDS, DEPARTMENT STAFFING, AND CONDUCTING BUSINESS RESEARCH AND SURVEYS, NAMELY, PATIENT SATISFACTION SURVEYS FOR EMERGENCY DEPARTMENT; EMPLOYMENT STAFFING IN THE FIELD OF MEDICAL SERVICES; EMERGENCY MEDICAL ASSISTANCE SERVICES, NAMELY, PROVIDING EMERGENCY ROOM STAFFING FOR HOSPITALS; BUSINESS RISK MANAGEMENT SERVICES FOR OTHERS (U.S. CLS. 100, 101 AND 102).
FIRST USE 7-23-2008; IN COMMERCE 7-23-2008.

CLASS 36—INSURANCE AND FINANCIAL

FOR FINANCIAL RISK MANAGEMENT SERVICES FOR OTHERS (U.S. CLS. 100, 101 AND 102).
FIRST USE 7-23-2008; IN COMMERCE 7-23-2008.

CLASS 41—EDUCATION AND ENTERTAINMENT

FOR TRAINING SERVICES IN THE FIELD OF EMERGENCY DEPARTMENT CUSTOMER SERVICES; TRAINING SERVICES IN THE FIELD OF INTERPERSONAL SKILLS FOR PHYSICIANS; TRAINING SERVICES IN THE FIELD OF LEADERSHIP SKILLS; AND TRAINING PHYSICIANS IN THE FIELD OF COMPLIANCE WITH FEDERAL EMERGENCY MEDICAL TREATMENT AND ACTIVE LABOR ACT (U.S. CLS. 100, 101 AND 107).
FIRST USE 7-23-2008; IN COMMERCE 7-23-2008.
SUSAN RICHARDS, EXAMINING ATTORNEY

SN 77-551,659, THE SCHUMACHER GROUP OF DELAWARE, INC., LAFAYETTE, LA. FILED 8-20-2008.

SN 77-551,620, THE SCHUMACHER GROUP OF DELAWARE, INC., LAFAYETTE, LA. FILED 8-20-2008.

SCHUMACHER GROUP



THE MARK CONSISTS OF TWO BLACK SEMI-CIRCULAR BARS FORMING THE APPEARANCE OF THE LETTER "S" AGAINST A WHITE BACKGROUND.

THE MARK CONSISTS OF STANDARD CHARACTERS WITHOUT CLAIM TO ANY PARTICULAR FONT, STYLE, SIZE, OR COLOR.
OWNER OF U.S. REG. NOS. 2,450,978 AND 2,554,981.
NO CLAIM IS MADE TO THE EXCLUSIVE RIGHT TO USE "GROUP", APART FROM THE MARK AS SHOWN.
SEC. 2(F).

CLASS 35—ADVERTISING AND BUSINESS

FOR BUSINESS MANAGEMENT CONSULTATION FOR EMERGENCY MEDICAL DEPARTMENTS, NAMELY, CONSULTATION IN THE FIELDS OF IMPROVING EMERGENCY DEPARTMENT PERFORMANCE, HANDLING OF MEDICAL RECORDS, DESIGNING MEDICAL RECORDS, DEPARTMENT STAFFING, AND CONDUCTING BUSINESS RESEARCH AND SURVEYS, NAMELY, PATIENT SATISFACTION SURVEYS FOR EMERGENCY DEPARTMENT; EMPLOYMENT STAFFING IN THE FIELD OF MEDICAL SERVICES; EMERGENCY MEDICAL ASSISTANCE SERVICES, NAMELY, PROVIDING EMERGENCY ROOM STAFFING FOR HOSPITALS; BUSINESS RISK MANAGEMENT SERVICES FOR OTHERS (U.S. CLS. 100, 101 AND 102).
FIRST USE 7-23-2008; IN COMMERCE 7-23-2008.

CLASS 36—INSURANCE AND FINANCIAL

FOR FINANCIAL RISK MANAGEMENT SERVICES FOR OTHERS (U.S. CLS. 100, 101 AND 102).
FIRST USE 7-23-2008; IN COMMERCE 7-23-2008.

CLASS 41—EDUCATION AND ENTERTAINMENT

FOR TRAINING SERVICES IN THE FIELD OF EMERGENCY DEPARTMENT CUSTOMER SERVICES; TRAINING SERVICES IN THE FIELD OF INTERPERSONAL SKILLS FOR PHYSICIANS; TRAINING SERVICES IN THE FIELD OF LEADERSHIP SKILLS; AND TRAINING PHYSICIANS IN THE FIELD OF COMPLIANCE WITH FEDERAL EMERGENCY MEDICAL TREATMENT AND ACTIVE LABOR ACT (U.S. CLS. 100, 101 AND 107).
FIRST USE 7-23-2008; IN COMMERCE 7-23-2008.
SUSAN RICHARDS, EXAMINING ATTORNEY

CLASS 31—NATURAL AGRICULTURAL PRODUCTS

FOR AGRICULTURAL GRAINS FOR PLANTING; FOOD FOR ANIMALS; FRESH APPLES; FRESH FRUITS; FRESH POTATOES; FRESH VEGETABLES; SEEDS FOR AGRICULTURAL PURPOSES; UNPROCESSED BEETS; UNPROCESSED GRAINS FOR EATING; UNPROCESSED VEGETABLES (U.S. CLS. 1 AND 46).
FIRST USE 1-28-2008; IN COMMERCE 4-10-2008.
AMY ALFIERI, EXAMINING ATTORNEY

SN 77-552,385. SMARTFOODS, INC., PLANO, TX. FILED 8-21-2008.

SN 77-552,132. SAN'AN SCIENCE AND TECHNOLOGY CO. LTD, BEIJING., BEIJING, CHINA, FILED 8-21-2008.



NO CLAIM IS MADE TO THE EXCLUSIVE RIGHT TO USE "SUPERIOR ORGANIC FOOD AND THE CHINESE CHARACTERS THAT TRANSLITERATE TO CHAO YOU JI SHI PIN AND TRANSLATE TO SUPERIOR ORGANIC FOOD", APART FROM THE MARK AS SHOWN.

THE COLOR(S) GOLD, WHITE, BLACK AND GREEN IS/ARE CLAIMED AS A FEATURE OF THE MARK.

THE MARK CONSISTS OF CHINESE CHARACTERS AND ENGLISH WORDS IN WHITE WITH BLACK SHADING, PLACED ON A GREEN BACKGROUND ON THE GOLD LEAF SHAPED FIGURE.

THE TERMS "SAN" AND "AN" MEAN THREE AND PEACEFUL, RESPECTIVELY, BUT THE TERM "SAN'AN" HAS NO MEANING IN A FOREIGN LANGUAGE.

THE NON-LATIN CHARACTER(S) IN THE MARK TRANSLITERATE INTO "SAN AN CHAO YOU JI SHI PIN", AND THIS MEANS SAN AN SUPERIOR ORGANIC FOOD IN ENGLISH.

CLASS 29—MEATS AND PROCESSED FOODS

FOR CANNED FRUITS; CUT VEGETABLES; DRIED MEAT; EDIBLE FATS; FROZEN FRUITS; FRUIT CHIPS; MILK PRODUCTS EXCLUDING ICE CREAM, ICE MILK AND FROZEN YOGURT; PROCESSED EGGS; PROTEINS BEING FOODSTUFFS FOR HUMAN CONSUMPTION; VEGETABLE SALADS (U.S. CL. 46).
FIRST USE 1-28-2008; IN COMMERCE 4-10-2008.

CLASS 30—STAPLE FOODS

FOR BREAD; CEREAL BASED SNACK FOOD; CORN FLOUR; FLOUR FOR FOOD; HONEY; RICE; RICE FLOUR; ROYAL JELLY FOR FOOD PURPOSES; SPRING ROLLS; WHEAT FLOUR (U.S. CL. 46).
FIRST USE 1-28-2008; IN COMMERCE 4-10-2008.

SMARTFOOD

THE MARK CONSISTS OF STANDARD CHARACTERS WITHOUT CLAIM TO ANY PARTICULAR FONT, STYLE, SIZE, OR COLOR.

OWNER OF U.S. REG. NO. 1,367,966.

CLASS 29—MEATS AND PROCESSED FOODS

FOR POTATO BASED SNACK FOODS; FRUIT AND SOY BASED SNACK FOODS; FRUIT-BASED SNACK FOODS; NUT-BASED SNACK FOODS, NAMELY, NUT CRISPS; NUT-BASED SNACK FOODS, NAMELY, NUT CLUSTERS; CANDY COATED NUTS; VEGETABLE-BASED SNACK FOODS; PROCESSED EDIBLE SEEDS; SNACK MIXES CONSISTING PRIMARILY OF PROCESSED FRUITS, PROCESSED NUTS AND/OR RAISINS; SNACK MIXES CONSISTING PRIMARILY OF DEHYDRATED FRUIT AND PROCESSED NUTS (U.S. CL. 46).

CLASS 30—STAPLE FOODS

FOR CEREAL-BASED SNACK FOODS; CORN-BASED SNACK FOODS; GRAIN-BASED SNACK FOODS; RICE-BASED SNACK FOODS; WHEAT-BASED SNACK FOODS; CRACKERS; SNACK MIXES CONSISTING PRIMARILY OF CRACKERS, PRETZELS, CANDIED NUTS AND/OR POPPED POPCORN; CANDY COATED POPCORN; GLAZED POPCORN; CHOCOLATES AND CHOCOLATE BASED READY TO EAT CANDIES AND SNACKS; CANDY (U.S. CL. 46).

AISHA CLARKE, EXAMINING ATTORNEY

SN 77-552,528. SCHUYLKILL HEALTH SYSTEM, POTTSVILLE, PA. FILED 8-21-2008.

**THE ROAD TO EXCELLENCE
LEADS HERE**

THE MARK CONSISTS OF STANDARD CHARACTERS WITHOUT CLAIM TO ANY PARTICULAR FONT, STYLE, SIZE, OR COLOR.

CLASS 42—SCIENTIFIC AND COMPUTER SERVICES

FOR MEDICAL RESEARCH SERVICES (U.S. CLS. 100 AND 101).

CLASS 44—MEDICAL, BEAUTY AND AGRICULTURAL SERVICES

FOR HOSPITAL SERVICES, NAMELY, MEDICAL, SURGICAL AND PSYCHOLOGICAL COUNSELING, PHYSICAL REHABILITATION AND MEDICAL IMAGING SERVICES (U.S. CLS. 100 AND 101).

HEATHER BIDDULPH, EXAMINING ATTORNEY

CLASS 9—ELECTRICAL AND SCIENTIFIC APPARATUS

FOR DIGITAL MEDIA, NAMELY, PRE-RECORDED VIDEO CASSETTES, DIGITAL VIDEO DISCS, DIGITAL VERSATILE DISCS, DOWNLOADABLE AUDIO AND VIDEO RECORDINGS, DVDS AND HIGH DEFINITION DIGITAL DISKS FEATURING PHYSICAL FITNESS INSTRUCTION (U.S. CLS. 21, 23, 26, 36 AND 38).

FIRST USE 9-30-2007; IN COMMERCE 9-30-2007.

CLASS 41—EDUCATION AND ENTERTAINMENT

FOR PHYSICAL FITNESS CONSULTATION, PHYSICAL FITNESS INSTRUCTION, PHYSICAL FITNESS TRAINING SERVICES, PHYSICAL FITNESS CONDITIONING CLASSES, AND PROVIDING FITNESS AND EXERCISE FACILITIES (U.S. CLS. 100, 101 AND 107).

FIRST USE 9-30-2007; IN COMMERCE 9-30-2007.

SONYA STEPHENS, EXAMINING ATTORNEY

SN 77-552,670. CAR SPA, INC., DALLAS, TX. FILED 8-21-2008.

CAR SPA

THE MARK CONSISTS OF STANDARD CHARACTERS WITHOUT CLAIM TO ANY PARTICULAR FONT, STYLE, SIZE, OR COLOR.

OWNER OF U.S. REG. NOS. 2,749,101 AND 2,867,042.

NO CLAIM IS MADE TO THE EXCLUSIVE RIGHT TO USE "CAR", APART FROM THE MARK AS SHOWN.

CLASS 35—ADVERTISING AND BUSINESS

FOR RETAIL STORE SERVICES FEATURING CONVENIENCE STORE ITEMS AND GASOLINE (U.S. CLS. 100, 101 AND 102).

FIRST USE 9-1-1988; IN COMMERCE 9-1-1988.

CLASS 37—CONSTRUCTION AND REPAIR

FOR AUTOMOBILE SERVICE STATION SERVICES FEATURING GLASS AND UPHOLSTERY REPAIR AND REPLACEMENT SERVICES; CAR WASHING SERVICES AND AUTOMOBILE OIL AND LUBRICATION SERVICES (U.S. CLS. 100, 103 AND 106).

FIRST USE 9-1-1988; IN COMMERCE 9-1-1988.

CLASS 42—SCIENTIFIC AND COMPUTER SERVICES

FOR STATE INSPECTIONS FOR AUTOMOBILES (U.S. CLS. 100 AND 101).

FIRST USE 9-1-1988; IN COMMERCE 9-1-1988.

CHRIS WELLS, EXAMINING ATTORNEY

SN 77-554,610. STROLLERFIT INC., CINCINNATI, OH. FILED 8-25-2008.

RESTORE THE CORE

THE MARK CONSISTS OF STANDARD CHARACTERS WITHOUT CLAIM TO ANY PARTICULAR FONT, STYLE, SIZE, OR COLOR.

SN 77-554,817. UNIVERSAL PRODUCTORA, S.A. DE C.V., MEXICO, D.F., MEXICO, FILED 8-25-2008.



OWNER OF MEXICO REG. NO. 1064333, DATED 9-30-2008, EXPIRES 7-22-2018.

THE MARK CONSISTS OF THE WORD "MI", IN STYLIZED LETTERS. THE LETTER "M" IS CAPITALIZED, AND THE LETTER "I" APPEARS IN LOWER CASE. A SHADOW APPEARS BEHIND THE LETTERS.

THE FOREIGN WORDING IN THE MARK TRANSLATES INTO ENGLISH AS "MY".

CLASS 3—COSMETICS AND CLEANING PREPARATIONS

FOR COSMETIC PADS; COTTON FOR COSMETIC PURPOSES (U.S. CLS. 1, 4, 6, 50, 51 AND 52).

CLASS 5—PHARMACEUTICALS

FOR ANTIBACTERIAL HAND LOTIONS; COTTON FOR MEDICAL PURPOSES (U.S. CLS. 6, 18, 44, 46, 51 AND 52).

JILL PRATER, EXAMINING ATTORNEY

SN 77-554,972. WHICHBOX MEDIA LLC, DALLAS, TX. FILED 8-25-2008.

ORGANIC STORYTELLING

THE MARK CONSISTS OF STANDARD CHARACTERS WITHOUT CLAIM TO ANY PARTICULAR FONT, STYLE, SIZE, OR COLOR.

CLASS 35—ADVERTISING AND BUSINESS

FOR PROMOTING THE GOODS AND SERVICES OF OTHERS BY PROVIDING A WEB SITE AT WHICH USERS CAN LINK TO TRAVEL, FOOD, COOKING, HOME AND GARDEN, LIFESTYLE, ECOLOGICAL IMPACT, BUSINESS, FINANCE, NEWS, WEATHER, SPORTS, COMPUTING, COMPUTER SOFTWARE, GAMES, MUSIC, THEATER, MOVIES, SHOPPING, COMPUTER SUPPORT, HOBBIES, AND GENERAL INTEREST (U.S. CLS. 100, 101 AND 102).

CLASS 42—SCIENTIFIC AND COMPUTER SERVICES

FOR PROVIDING A WEB SITE THAT GIVES COMPUTER USERS THE ABILITY TO UPLOAD AND SHARE AUDIO RECORDINGS, VIDEOS, TEXT, AND MULTIMEDIA FILES ON THE SUBJECTS OF TRAVEL, FOOD, COOKING, HOME AND GARDEN, LIFESTYLE, ECOLOGICAL IMPACT, BUSINESS, FINANCE, NEWS, WEATHER, SPORTS, COMPUTING, COMPUTER SOFTWARE, GAMES, MUSIC, THEATER, MOVIES, SHOPPING, COMPUTER SUPPORT, HOBBIES, AND GENERAL INTEREST; HOSTING ON-LINE COMMUNITY WEB SITES FEATURING EDUCATIONAL AND ENTERTAINMENT CONTENT, USER COMMUNITIES, AUDIO, VIDEO, AND MULTIMEDIA CONTENT AND CLIPS IN THE FIELDS OF TRAVEL, FOOD, COOKING, HOME AND GARDEN, LIFESTYLE, ECOLOGICAL IMPACT, BUSINESS, FINANCE, NEWS, WEATHER, SPORTS, COMPUTING, COMPUTER SOFTWARE, GAMES, MUSIC, THEATER, MOVIES, SHOPPING, COMPUTER SUPPORT, HOBBIES, AND GENERAL INTEREST; COMPUTER SERVICES, NAMELY, CREATING AN ON-LINE COMMUNITY FOR REGISTERED USERS TO PARTICIPATE IN DISCUSSIONS, GET FEEDBACK FROM THEIR PEERS, FORM VIRTUAL COMMUNITIES, AND ENGAGE IN SOCIAL NETWORKING; PROVIDING ON-LINE NON-DOWNLOADABLE SOFTWARE APPLICATIONS FOR DESIGNING, DEVELOPING, AND HOSTING WEBSITES AND DIGITAL CONTENT OF OTHERS ON THE INTERNET; HOSTING OF DIGITAL CONTENT ON THE INTERNET; DESIGNING WEBSITES FOR ADVERTISING PURPOSES; COMPUTER SERVICES, NAMELY, SEARCHING AND RETRIEVING INFORMATION ON THE PRODUCTS AND SERVICES OF OTHERS, CREATING INDEXES OF INFORMATION AND WEB SITES FOR OTHERS AVAILABLE ON COMPUTER NETWORKS, AND PROVIDING SEARCH ENGINES FOR LOCATING INFORMATION ON THE PRODUCTS AND SERVICES OF OTHERS (U.S. CLS. 100 AND 101).

ANDREA BUTLER, EXAMINING ATTORNEY

SN 77-556,309. HYPER BEAM TECH GROUP, LLC, DBA HYPERBEAM, STATEN ISLAND, NY. FILED 8-26-2008.

Hyper Beam

THE MARK CONSISTS OF STANDARD CHARACTERS WITHOUT CLAIM TO ANY PARTICULAR FONT, STYLE, SIZE, OR COLOR.

CLASS 9—ELECTRICAL AND SCIENTIFIC APPARATUS

FOR AN OPTICAL METROLOGY INSPECTION SYSTEM COMPRISED OF A LIGHT SOURCE, ONE OR MORE CAMERAS AND SENSORS IN COMMUNICATION WITH COMPUTER SOFTWARE AND HARDWARE; CINEMATOGRAPHIC PROJECTORS; ELECTRIC WARNING LIGHT SYSTEMS; ELECTRIC WARNING LIGHTS; EMERGENCY AUTO KITS COMPRISED OF A HAND HELD SPOTLIGHT AND BATTERY CHARGER; EMERGENCY WARNING LIGHTS; FIBER OPTIC CABLES; FIBER OPTIC LIGHT AND IMAGE CONDUITS; FIBER OPTICS; FLASHING SAFETY LIGHT IN THE FORM OF A PENDANT FOR PROVIDING VISIBILITY FOR PEOPLE, INANIMATE ARTICLES, OR ANIMALS; FLASHING SAFETY LIGHTS; FLASHLIGHTS WITH LIGHT EMITTING DIODES FOR USE IN PHOTOGRAPHY; HAND-HELD SECURITY DEVICE THAT DISABLES ASSAILANTS USING FLASHING LIGHT EMITTING DIODES; LABORATORY INSTRUMENTS, NAMELY, RADIATION DEVICES IN THE NATURE OF ULTRAVIOLET, VISIBLE, OR INFRA-RED LIGHT BOXES FOR THE ANALYSIS OF BODILY FLUIDS; LCD PROJECTORS USED TO DISPLAY ADVERTISEMENTS; LED AND HID LIGHT CONTROLS; LIGHT CONDUCTING FILAMENTS; LIGHT DIODES; LIGHT DIRECTORS AND PHOTOGRAPHIC LIGHTING TENTS, ALL FOR USE WITH PHOTOGRAPHIC LIGHTING EQUIPMENT FOR PROFESSIONAL AND HIGH-END PHOTOGRAPHY; LIGHT EMITTING DIODE (LED) DISPLAYS; LIGHT EMITTING DIODES (LEDS); LIGHTING DEVICES FOR TAKING PICTURES; LIGHTS FOR USE ON VIDEO CAMERAS; LIQUID CRYSTAL DISPLAY (LCD) PROJECTORS; LUMINOUS VARIABLE/DYNAMIC SIGNS USING LIGHT EMITTING DIODES AND ELECTRONIC CONTROLLERS TO PRODUCE REAL-TIME AND PROGRAMMABLE MESSAGES AND INFORMATION DISPLAYS; MOTION SENSITIVE SECURITY LIGHTS; MOVIE EDITING PROJECTORS; MOVIE PROJECTORS; MULTIMEDIA PROJECTORS; OPTICAL CABLES; OPTICAL FIBER CABLES; OPTICAL FILTERS FOR SCREENS; OPTICAL GLASSES; OPTICAL INSPECTION APPARATUS FOR INDUSTRIAL USE; OPTICAL INSPECTION APPARATUS FOR INSPECTION OF SEMICONDUCTOR MATERIALS, NAMELY, SEMICONDUCTOR WAFERS, RETICLES, AND PHOTOMASKS; OPTICAL LENS SIGHTS; OPTICAL LENSES; OPTICAL OR TELESCOPIC LENS SIGHTS; OPTICAL READERS; OPTICAL REFLECTORS; OPTICAL SCANNERS; PHOTOGRAPHIC PROJECTORS; PICTURE PROJECTORS; PLANETARIUM PROJECTORS; PORTABLE DETECTION AND IDENTIFICATION INSTRUMENTS USING LIGHT SOURCES AND LIGHT DETECTORS FOR DETECTING AND IDENTIFYING CHEMICAL AND BIOLOGICAL SUBSTANCES NOT FOR MEDICAL PURPOSES; PORTABLE PHOTOGRAPHY EQUIPMENT, NAMELY, REFLECTORS, TRIPODS, LIGHT STANDS AND SUPPORTS AND BAGS SPECIALLY ADAPTED FOR THESE GOODS; POWER SUPPLIES FOR LIGHTS, SIRENS AND PUBLIC ADDRESS SYSTEMS; PROJECTOR LAMPS; PROJECTORS PARTICULARLY PROJECTORS FOR THE ENTERTAINMENT INDUSTRY; ROTATING LIGHTS; SAFETY EQUIPMENT, NAMELY, BEACON LIGHTS; SECURITY LIGHTING SYSTEM FOR VEHICLES USING RADIO FREQUENCY DEVICE; SELF-ACTING FOCUSING PROJECTORS; SLIDE PROJECTORS; STROBE LIGHT APPARATUS FOR USE IN PROFESSIONAL QUALITY PHOTOGRAPHY; VIDEO PROJECTORS (U.S. CLS. 21, 23, 26, 36 AND 38).

CLASS 11—ENVIRONMENTAL CONTROL APPARATUS

FOR AIRCRAFT LANDING LIGHTS; BACKUP LIGHTS FOR LAND VEHICLES; BICYCLE LIGHTS; CEILING LIGHTS; DIVING LIGHTS; ELECTRIC HOLIDAY LIGHTS; ELECTRIC LIGHTING FIXTURES; ELECTRIC LIGHTING FIXTURES, NAMELY, SCONCES; ELECTRIC TORCHES FOR LIGHTING; ELECTRIC TRACK LIGHTING UNITS; ELECTRICAL MAGNIFYING LIGHT FIXTURES; FIBER OPTIC LIGHTING FIXTURES USED IN CONJUNCTION WITH ELECTRICAL ILLUMINATORS; FILTERS FOR PHOTOGRAPHIC, CINEMATOGRAPHIC, VIDEO AND PERFORMING ARTS LIGHTING; FLASHING STROBE LIGHT APPARATUS; FLASHLIGHT HOLDERS; FLASHLIGHT POINTERS;

FLASHLIGHTS; HIGH INTENSITY SEARCH LIGHTS; INFRARED LIGHTING FIXTURES; LAMP WHOSE LIGHT CAN BE TURNED IN ALL DIRECTIONS; LASER LIGHT PROJECTORS; LED (LIGHT EMITTING DIODE) LIGHTING FIXTURES; LED (LIGHT EMITTING DIODES) LIGHTING FIXTURES FOR USE IN DISPLAY, COMMERCIAL, INDUSTRIAL, RESIDENTIAL, AND ARCHITECTURAL ACCENT LIGHTING APPLICATIONS; LED AND HID LIGHT FIXTURES; LED LIGHT ASSEMBLIES FOR STREET LIGHTS, SIGNS, COMMERCIAL LIGHTING, AUTOMOBILES, BUILDINGS, AND OTHER ARCHITECTURAL USES; LED LIGHT BULBS; LED LIGHTING FIXTURES FOR INDOOR AND OUTDOOR LIGHTING APPLICATIONS; LIGHT DIFFUSERS; LIGHT POST LUMINAIRES; LIGHT REFLECTORS; LIGHTED DISCO BALLS; LIGHTED OUTDOOR HOLIDAY SCULPTURES AND WIRE FRAME STATUES; LIGHTED PARTY-THEMED DECORATIONS, ELECTRIC LIGHT DECORATIVE STRINGS; LIGHTING APPARATUS FOR VEHICLES; LIGHTING DEVICES FOR SHOWCASES; LIGHTING FIXTURES; LIGHTING FIXTURES FOR USE IN PARKING DECKS AND GARAGES; LIGHTING FIXTURES FOR USE IN PARKING LOTS AND WALKWAYS; LIGHTING FIXTURES THAT INTEGRATE NATURAL DAYLIGHT AND FLUORESCENT LIGHTING INTO THE FIXTURE; LIGHTING FIXTURES WITH MOTION DETECTION; LIGHTING SYSTEM FOR USE DURING SURGERY COMPRISING A LENS MODULE, AN ADJUSTABLE CONDUIT FOR SUPPORTING A FIBER OPTIC CABLE OPERATIVELY ATTACHED TO THE LENS MODULE AND A MOUNTING BRACKET; LIGHTING TRACKS; LIGHTS FOR FIREARMS; LIGHTS FOR ILLUMINATING STAIRS, DOORS AND OTHER PORTIONS OF BUILDINGS; LIGHTS FOR USE IN ILLUMINATING SIGNS AND DISPLAYS; LIGHTS FOR VEHICLES; MOBILE LIGHT TOWERS; OUTDOOR PORTABLE LIGHTING PRODUCTS, NAMELY, HEADLAMPS; POCKET SEARCH LIGHTS; PORTABLE BATTERY-OPERATED LIGHTS THAT CAN BE PLACED ON SURFACES WHERE OTHER LIGHT SOURCES ARE UNAVAILABLE; RED LED FLASHLIGHTS FOR ILLUMINATION PURPOSES; RUNNING LIGHTS FOR LAND VEHICLES; SEARCHLIGHTS; SEARCHLIGHTS FOR AIRCRAFT; SPOTLIGHTS; WALL LIGHTS (U.S. CLS. 13, 21, 23, 31 AND 34).

KATINA MISTER, EXAMINING ATTORNEY

SN 77-556,787. FUTURE US, INC., SOUTH SAN FRANCISCO, CA. FILED 8-27-2008.

MAXIMUM TECH

THE MARK CONSISTS OF STANDARD CHARACTERS WITHOUT CLAIM TO ANY PARTICULAR FONT, STYLE, SIZE, OR COLOR.

NO CLAIM IS MADE TO THE EXCLUSIVE RIGHT TO USE "TECH", APART FROM THE MARK AS SHOWN.

CLASS 16—PAPER GOODS AND PRINTED MATTER

FOR MAGAZINES FEATURING INFORMATION ON TECHNOLOGY, COMPUTERS AND CONSUMER ELECTRONICS; MAGAZINE SECTIONS IN THE FIELD OF TECHNOLOGY, COMPUTERS AND CONSUMER ELECTRONICS; MAGAZINE COLUMNS ABOUT TECHNOLOGY, COMPUTERS AND CONSUMER ELECTRONICS (U.S. CLS. 2, 5, 22, 23, 29, 37, 38 AND 50).

CLASS 42—SCIENTIFIC AND COMPUTER SERVICES

FOR PROVIDING INFORMATION IN THE FIELD OF COMPUTER TECHNOLOGY, COMPUTERS AND BUSINESS AND CONSUMER ELECTRONIC TECHNOLOGY VIA THE INTERNET (U.S. CLS. 100 AND 101).

KELLY MCCOY, EXAMINING ATTORNEY

SN 77-556,806. FUTURE US, INC., SOUTH SAN FRANCISCO, CA. FILED 8-27-2008.

MAXIMUM IT

THE MARK CONSISTS OF STANDARD CHARACTERS WITHOUT CLAIM TO ANY PARTICULAR FONT, STYLE, SIZE, OR COLOR.

NO CLAIM IS MADE TO THE EXCLUSIVE RIGHT TO USE "IT", APART FROM THE MARK AS SHOWN.

CLASS 16—PAPER GOODS AND PRINTED MATTER

FOR MAGAZINES FEATURING INFORMATION ON TECHNOLOGY, COMPUTERS AND CONSUMER ELECTRONICS; MAGAZINE SECTIONS IN THE FIELD OF TECHNOLOGY, COMPUTERS AND CONSUMER ELECTRONICS; MAGAZINE COLUMNS ABOUT TECHNOLOGY, COMPUTERS AND CONSUMER ELECTRONICS (U.S. CLS. 2, 5, 22, 23, 29, 37, 38 AND 50).

CLASS 42—SCIENTIFIC AND COMPUTER SERVICES

FOR PROVIDING INFORMATION IN THE FIELD OF COMPUTER TECHNOLOGY, COMPUTERS AND BUSINESS AND CONSUMER ELECTRONIC TECHNOLOGY VIA THE INTERNET (U.S. CLS. 100 AND 101).

KELLY MCCOY, EXAMINING ATTORNEY

SN 77-557,069. INJURED MARINE SEMPER FI FUND, OCEANSIDE, CA. FILED 8-27-2008.

TEAM SEMPER FI

THE MARK CONSISTS OF STANDARD CHARACTERS WITHOUT CLAIM TO ANY PARTICULAR FONT, STYLE, SIZE, OR COLOR.

THE FOREIGN WORDING IN THE MARK TRANSLATES INTO ENGLISH AS ALWAYS FAITHFUL.

CLASS 36—INSURANCE AND FINANCIAL

FOR ELEEMOSYNARY SERVICES IN THE FIELD OF PROVIDING FINANCIAL ASSISTANCE (U.S. CLS. 100, 101 AND 102).

FIRST USE 4-0-2007; IN COMMERCE 4-0-2007.

CLASS 41—EDUCATION AND ENTERTAINMENT

FOR ELEMOSYNARY SERVICES IN THE FIELD OF PROVIDING SPORTS EQUIPMENT (U.S. CLS. 100, 101 AND 107).

FIRST USE 4-0-2007; IN COMMERCE 4-0-2007.

CLASS 45—PERSONAL AND LEGAL SERVICES

FOR ELEMOSYNARY SERVICES IN THE FIELD OF PROVIDING SPORTS CLOTHING (U.S. CLS. 100 AND 101).

FIRST USE 4-0-2007; IN COMMERCE 4-0-2007.
NICHOLAS ALTREE, EXAMINING ATTORNEY

CLASS 44—MEDICAL, BEAUTY AND AGRICULTURAL SERVICES

FOR STUD AND BREEDING SERVICES FOR ALPACAS (U.S. CLS. 100 AND 101).

ELISSA GARBER KON, EXAMINING ATTORNEY

SN 77-557,687. XOOPII CORPORATION, LAGUNA BEACH, CA. FILED 8-28-2008.



THE MARK CONSISTS OF THE STYLIZED LETTER AND WORD "X XOOPII".

CLASS 18—LEATHER GOODS

FOR REUSABLE TEXTILE SHOPPING BAGS (U.S. CLS. 1, 2, 3, 22 AND 41).

CLASS 21—HOUSEWARES AND GLASS

FOR ALUMINUM DRINKING BOTTLES SOLD EMPTY (U.S. CLS. 2, 13, 23, 29, 30, 33, 40 AND 50).
JENNIFER VASQUEZ, EXAMINING ATTORNEY

SN 77-557,741. J. PRICE ENTERPRISES, LLC, SHAWNEE, OK. FILED 8-28-2008.

WEAR ALPACA

THE MARK CONSISTS OF STANDARD CHARACTERS WITHOUT CLAIM TO ANY PARTICULAR FONT, STYLE, SIZE, OR COLOR.

NO CLAIM IS MADE TO THE EXCLUSIVE RIGHT TO USE "ALPACA", APART FROM THE MARK AS SHOWN.

CLASS 35—ADVERTISING AND BUSINESS

FOR ON-LINE RETAIL STORE SERVICES FEATURING REGISTERED ALPACAS, RAW ALPACA FLEECE, PROCESSED ALPACA FLEECE IN THE FORM OF YARN, FABRIC, FLOOR RUGS, BLANKETS, TEDDY BEARS MADE WITH ALPACA FLEECE, AND CLOTHING, NAMELY, JEANS, SOCKS, HATS, GLOVES, SWEATERS, SEASONAL SHIRTS, AND SCARVES, MADE IN WHOLE OR IN PART FROM ALPACA (U.S. CLS. 100, 101 AND 102).

SN 77-558,551. IMMERSIVE TECHNOLOGIES INC., SANDY, UT. FILED 8-29-2008.

Tablit

THE MARK CONSISTS OF STANDARD CHARACTERS WITHOUT CLAIM TO ANY PARTICULAR FONT, STYLE, SIZE, OR COLOR.

CLASS 9—ELECTRICAL AND SCIENTIFIC APPARATUS

FOR FLIGHT SIMULATORS FOR AIRCRAFT; VEHICLE DRIVE TRAINING SIMULATORS (U.S. CLS. 21, 23, 26, 36 AND 38).

CLASS 41—EDUCATION AND ENTERTAINMENT

FOR TRAINING IN THE USE OF EQUIPMENT TRAINING SIMULATORS USED FOR MINING, HEAVY INDUSTRY, MILITARY AND MARINE (U.S. CLS. 100, 101 AND 107).

PAULA MAHONEY, EXAMINING ATTORNEY

SN 77-558,669. JADEN BIOSCIENCE INC., DBA JADEN BIOSCIENCE INC., SAN DIEGO, CA. FILED 8-29-2008.

ZIVA

THE MARK CONSISTS OF STANDARD CHARACTERS WITHOUT CLAIM TO ANY PARTICULAR FONT, STYLE, SIZE, OR COLOR.

CLASS 1—CHEMICALS

FOR ASSAYS AND REAGENTS FOR USE IN GENETIC RESEARCH; BIOCHEMICALS, NAMELY, MONOCLONAL ANTIBODIES FOR IN VITRO SCIENTIFIC OR RESEARCH USE; BIOMEDICAL COMPOUNDS, NAMELY, PEPTIDE SUBSTRATES USED IN ANALYZING AND DETECTING CERTAIN TOXINS FOR CLINICAL OR MEDICAL LABORATORY USE; BIOMEDICAL COMPOUNDS, NAMELY, PEPTIDE SUBSTRATES USED IN ANALYZING AND DETECTING CERTAIN TOXINS FOR LABORATORY OR RESEARCH USE; CHEMICAL REAGENTS FOR NON-MEDICAL PURPOSES; CHEMICAL REAGENTS FOR NON-MEDICAL PURPOSES, NAMELY, FOR USE IN EVALUATING CONTAMINANTS; CHEMICAL TEST KITS FOR IMMUNOLOGY, MALIGNANCY, OR CELL TREATMENTS FOR LABORATORY OR RESEARCH USE; DIAGNOSTIC KITS CONSISTING PRIMARILY OF MONOCLONAL ANTIBODIES, BUFFERS, AND REAGENTS TO MONITOR TOXICITY OF DRUGS; DIAGNOSTIC PREPARATIONS FOR SCIENTIFIC OR RESEARCH USE; DIAGNOSTIC PREPARATIONS FOR CLINICAL OR MEDICAL LABORATORY USE; DIAGNOSTIC PREPARATIONS FOR SCIENTIFIC USE; DIAGNOSTIC PREPARATIONS OTHER THAN FOR MEDICAL OR VETERINARY PURPOSES; DIAGNOSTIC PREPARATIONS USED IN SCIENCE; DIAGNOSTIC REAGENTS AND PREPARATIONS, EXCEPT FOR MEDICAL OR VETERINARY USE; DIAGNOSTIC REAGENTS FOR CLINICAL OR MEDICAL LABORATORY USE; DIAGNOSTIC REAGENTS FOR IN VITRO USE IN BIOCHEMISTRY, CLINICAL CHEMISTRY AND MICROBIOLOGY; GENETIC IDENTITY TESTS COMPRISED OF REAGENTS; LABORATORY CHEMICALS, NAMELY, AN ANTIBODY REAGENT USED FOR THE DETECTION OF ANTIGENS IN CELL AND TISSUE ANALYSIS FOR IN VITRO DIAGNOSTIC USE; NUCLEIC ACID ISOLATION AND PURIFICATION KIT CONSISTING PRIMARILY OF REAGENTS AND MAGNETIC BEADS FOR SCIENTIFIC RESEARCH PURPOSES; REAGENT FOR CHEMICAL ANALYSES; REAGENTS AND SUBSTRATES, NAMELY, CHEMICAL COMPOUNDS FOR USE IN PATTERNING AT NANO SCALE OR NEAR NANO SCALE; REAGENTS FOR RESEARCH PURPOSES; REAGENTS FOR SCIENTIFIC OR MEDICAL RESEARCH USE; REAGENTS FOR USE IN SCIENTIFIC APPARATUS FOR CHEMICAL OR BIOLOGICAL ANALYSIS; RESEARCH REAGENTS FOR INDUSTRIAL USE, NAMELY, FOR FOOD TESTING; TESTING KITS CONTAINING PEPTIDE SUBSTRATES USED IN ANALYZING AND DETECTING CERTAIN TOXINS FOR CLINICAL OR MEDICAL LABORATORY USE; TESTING KITS CONTAINING PEPTIDE SUBSTRATES USED IN ANALYZING AND DETECTING CERTAIN TOXINS FOR LABORATORY OR RESEARCH USE (U.S. CLS. 1, 5, 6, 10, 26 AND 46).

CLASS 5—PHARMACEUTICALS

FOR ALLOGRAFT TISSUE RECONSTITUTION SOLUTION KITS; CHEMICAL REAGENTS FOR MEDICAL OR VETERINARY PURPOSES; DIAGNOSTIC KITS CONSISTING PRIMARILY OF MONOCLONAL ANTIBODIES, BUFFERS, AND REAGENTS FOR USE IN DISEASE TESTING; DIAGNOSTIC PREPARATIONS FOR MEDICAL PURPOSES FOR DETECTING THE PRESENCE OF MALIGNANT, INFLAMMATORY AND AUTOIMMUNE DISORDERS AND CONDITIONS AND TISSUE TRAUMA IN HUMANS; DIAGNOSTIC REAGENTS FOR MEDICAL USE; DRUG TESTING KITS COMPRISED OF MEDICAL DIAGNOSTIC REAGENTS AND ASSAYS FOR TESTING BODY FLUIDS; MEDICAL DIAGNOSTIC REAGENTS; MEDICAL DIAGNOSTIC REAGENTS AND ASSAYS FOR TESTING OF BODY FLUIDS; MEDICAL DIAGNOSTIC TEST STRIPS FOR USE IN THE FIELD OF MALIGNANCY, IMMUNOLOGY, AND INFECTIOUS DISEASE; REAGENTS AND MEDIA FOR MEDICAL AND VETERINARY DIAGNOSTIC PURPOSES (U.S. CLS. 6, 18, 44, 46, 51 AND 52).

JOHN KELLY, EXAMINING ATTORNEY

SN 77-559,605. THE FORWARD GROUP, LLC, CHICAGO, IL.
FILED 8-31-2008.

THE FORWARD FACTOR

THE MARK CONSISTS OF STANDARD CHARACTERS WITHOUT CLAIM TO ANY PARTICULAR FONT, STYLE, SIZE, OR COLOR.

CLASS 16—PAPER GOODS AND PRINTED MATTER

FOR EDUCATIONAL PUBLICATIONS, NAMELY, BOOKS, MAGAZINES, BROCHURES, PAMPHLETS, NEWSLETTERS, HAND-OUTS IN THE FIELDS OF PERSONAL DEVELOPMENT AND SELF-HELP; PUBLICATIONS, NAMELY, BOOKS, MAGAZINES, BROCHURES, PAMPHLETS, NEWSLETTERS, HAND-OUTS IN THE FIELDS OF PERSONAL DEVELOPMENT AND SELF-HELP; SERIES OF NON-FICTION BOOKS IN THE FIELD OF PERSONAL DEVELOPMENT (U.S. CLS. 2, 5, 22, 23, 29, 37, 38 AND 50).

CLASS 41—EDUCATION AND ENTERTAINMENT

FOR DEVELOPING EDUCATIONAL MANUALS FOR OTHERS IN THE FIELD OF PERSONAL AND LEADERSHIP DEVELOPMENT AND SELF-HELP; DEVELOPMENT AND DISSEMINATION OF EDUCATIONAL MATERIALS OF OTHERS IN THE FIELD OF PERSONAL AND LEADERSHIP DEVELOPMENT AND SELF-HELP; EDUCATION SERVICES, NAMELY, PROVIDING LIVE AND ON-LINE SEMINARS, CLASSES, WORKSHOPS IN THE FIELD OF PERSONAL AND LEADERSHIP DEVELOPMENT AND SELF-HELP; EDUCATION SERVICES, NAMELY, PROVIDING SEMINARS, CLASSES, WORKSHOPS IN THE FIELD OF PERSONAL AND LEADERSHIP DEVELOPMENT AND SELF-HELP; EDUCATION SERVICES, NAMELY, PROVIDING SEMINARS, CLASSES, WORKSHOPS IN THE FIELDS OF PERSONAL AND LEADERSHIP DEVELOPMENT AND SELF-HELP; EDUCATIONAL SERVICES, NAMELY, CONDUCTING SEMINARS, CLASSES, WORKSHOPS IN THE FIELD OF PERSONAL AND LEADERSHIP DEVELOPMENT AND SELF-HELP AND DISTRIBUTION OF TRAINING MATERIAL IN CONNECTION THEREWITH; LIFE COACHING SERVICES IN THE FIELD OF PERSONAL AND LEADERSHIP DEVELOPMENT AND SELF-HELP; PERSONAL COACHING SERVICES IN THE FIELD OF PERSONAL AND LEADERSHIP DEVELOPMENT AND SELF-HELP; PROFESSIONAL COACHING SERVICES IN THE FIELD OF PERSONAL AND LEADERSHIP DEVELOPMENT AND SELF-HELP; PUBLICATION OF TEXTS, BOOKS, MAGAZINES AND OTHER PRINTED MATTER (U.S. CLS. 100, 101 AND 107).

MICHAEL LITZAU, EXAMINING ATTORNEY

SN 77-559,948. EXPRESSO FITNESS CORPORATION, SUNNYVALE, CA. FILED 9-2-2008.

EXPRESSO VIRTUAL RIDE-A-THON

THE MARK CONSISTS OF STANDARD CHARACTERS WITHOUT CLAIM TO ANY PARTICULAR FONT, STYLE, SIZE, OR COLOR.

OWNER OF U.S. REG. NO. 3,216,325.

NO CLAIM IS MADE TO THE EXCLUSIVE RIGHT TO USE "VIRTUAL RIDE-A-THON", APART FROM THE MARK AS SHOWN.

CLASS 28—TOYS AND SPORTING GOODS

FOR EXERCISE EQUIPMENT, NAMELY, STATIONARY EXERCISE CYCLES, ROWING MACHINES, ELLIPTICAL MACHINES, TREADMILLS, AND STEP MACHINES; STATIONARY EXERCISE MACHINES EQUIPPED WITH INTERACTIVE COMPUTER SYSTEMS (U.S. CLS. 22, 23, 38 AND 50).

CLASS 36—INSURANCE AND FINANCIAL

FOR CHARITABLE FUND RAISING SERVICES BY MEANS OF STATIONARY BICYCLE RACES; CHARITABLE FUND RAISING SERVICES (U.S. CLS. 100, 101 AND 102).

CLASS 42—SCIENTIFIC AND COMPUTER SERVICES

FOR COMPUTER SERVICES, NAMELY, PROVIDING A WEBSITE WHERE USERS OF EXERCISE EQUIPMENT CAN TRACK AND GENERATE REPORTS ON THEIR USAGE STATISTICS AND PARTICIPATE IN CHARITABLE FUNDRAISING EVENTS RELATED TO THE USE OF EXERCISE EQUIPMENT (U.S. CLS. 100 AND 101).

BONNIE LUKEN, EXAMINING ATTORNEY

SN 77-560,026. THE ZOEZA GROUP, LLC, PHILADELPHIA, PA. FILED 9-2-2008.

LEARN. DO. KNOW. TRANSFORM.

THE MARK CONSISTS OF STANDARD CHARACTERS WITHOUT CLAIM TO ANY PARTICULAR FONT, STYLE, SIZE, OR COLOR.

CLASS 35—ADVERTISING AND BUSINESS

FOR WRITING GRANT PROPOSALS FOR BUSINESS, EDUCATION, GOVERNMENT, AND NON-GOVERNMENTAL ORGANIZATIONS; BUSINESS CONSULTANCY RELATING TO EDUCATION, GOVERNMENT, AND NON-GOVERNMENTAL ORGANIZATIONS; MANAGEMENT CONSULTING, NAMELY, BUSINESS LEADERSHIP DEVELOPMENT, BUSINESS ORGANIZATIONAL STRATEGY AND BUSINESS PLANNING; RESEARCH AND EVALUATIONS RELATED TO THE COMMERCIAL AFFAIRS OF BUSINESS, EDUCATION, GOVERNMENT AND NON-GOVERNMENTAL ORGANIZATIONS; BUSINESS SERVICES, NAMELY, DESIGN, DEVELOPMENT AND ANALYSIS OF TESTS FOR TESTING PROFESSIONAL COMPETENCY FOR BUSINESS, EDUCATION, GOVERNMENT AND NON-GOVERNMENTAL ORGANIZATIONS; BUSINESS RELATED ORGANIZATIONAL RESEARCH AND EVALUATION IN THE FIELD OF CONTINUING PROFESSIONAL DEVELOPMENT RELATED TO BUSINESS, EDUCATION, GOVERNMENT AND NON-GOVERNMENTAL ORGANIZATIONS (U.S. CLS. 100, 101 AND 102).

FIRST USE 5-15-2006; IN COMMERCE 5-15-2006.

CLASS 41—EDUCATION AND ENTERTAINMENT

FOR EDUCATIONAL RESEARCH AND EVALUATION IN THE FIELD OF CONTINUING PROFESSIONAL DEVELOPMENT RELATED TO BUSINESS, EDUCATION, GOVERNMENT AND NON-GOVERNMENTAL ORGANIZATIONS; EDUCATIONAL SERVICES IN THE NATURE OF COORDINATING AND CONDUCTING PROFESSIONAL TRAINING COURSES AND PROGRAMS FOR BUSINESS, EDUCATION, GOVERNMENT AND NON-GOVERNMENTAL ORGANIZATIONS; INSTRUCTIONAL DESIGN, NAMELY, CURRICULUM DEVELOPMENT AND ASSESSMENT FOR BUSINESS, EDUCATION, GOVERNMENT AND NON-GOVERNMENTAL ORGANIZATIONS IN THE FIELD OF MANAGEMENT CONSULTING, ORGANIZATIONAL DEVELOPMENT, HUMAN RESOURCES, STRATEGIC PLANNING, PROFESSIONAL DEVELOPMENT, CONTINUING EDUCATION, LEADERSHIP DEVELOPMENT, EXECUTIVE COACHING, KEYNOTE ADDRESSES; EDUCATIONAL SERVICES, NAMELY ARRANGING AND CONDUCTING CLASSES, WORKSHOPS AND DELIVERING KEYNOTE ADDRESSES TO BUSINESS, EDUCATION, GOVERNMENT AND NON-GOVERNMENTAL ORGANIZATIONS IN THE FIELD OF MANAGEMENT CONSULTING, ORGANIZATIONAL DEVELOPMENT, HUMAN RESOURCES, STRATEGIC PLANNING, PROFESSIONAL DEVELOPMENT, CONTINUING EDUCATION, LEADERSHIP DEVELOPMENT, EXECUTIVE COACHING, KEYNOTE ADDRESSES; AUTHORIZING AND PUBLISHING, NAMELY, DEVELOPMENT AND DISSEMINATION OF EDUCATIONAL MATERIALS OF OTHERS IN THE FIELD OF MANAGEMENT CONSULTING, ORGANIZATIONAL DEVELOPMENT, HUMAN RESOURCES, STRATEGIC PLANNING, PROFESSIONAL DEVELOPMENT, CONTINUING EDUCATION, LEADERSHIP DEVELOPMENT, EXECUTIVE COACHING, KEYNOTE ADDRESSES RELATED TO BUSINESS, EDUCATION, GOVERNMENT AND NON-GOVERNMENTAL ORGANIZATIONS (U.S. CLS. 100, 101 AND 107).

FIRST USE 5-15-2006; IN COMMERCE 5-15-2006.
KELLEY WELLS, EXAMINING ATTORNEY

SN 77-560,230. BATH & BODY WORKS BRAND MANAGEMENT, INC., REYNOLDSBURG, OH. FILED 9-2-2008.



CLASS 3—COSMETICS AND CLEANING PREPARATIONS

FOR FRAGRANCE REFILLS FOR NON-ELECTRIC AND ELECTRIC ROOM AND CAR FRAGRANCE DISPENSERS, SCENTED ROOM SPRAYS, SPRAY MIST FOR FRAGRANCING PILLOWS, ROOM FRAGRANCE GELS, CAR FRAGRANCE GELS, SCENTED FABRIC REFRESHER SPRAY, ROOM FRAGRANCE OILS, FRAGRANCE EMITTING WICKS FOR ROOM FRAGRANCE (U.S. CLS. 1, 4, 6, 50, 51 AND 52).

CLASS 4—LUBRICANTS AND FUELS

FOR CANDLES, SCENTED WAX FOR USE IN CANDLE WARMERS (U.S. CLS. 1, 6 AND 15).

CLASS 5—PHARMACEUTICALS

FOR CAR DEODORIZER, ROOM FRESHENERS, ODOR NEUTRALIZING PREPARATIONS FOR USE IN ROOM FRAGRANCING (U.S. CLS. 6, 18, 44, 46, 51 AND 52).

CLASS 11—ENVIRONMENTAL CONTROL APPARATUS

FOR ELECTRIC DISPENSER FOR ROOM AND CAR AIR FRESHENER (U.S. CLS. 13, 21, 23, 31 AND 34).
DAVID I, EXAMINING ATTORNEY

SN 77-560,321. HELIOVOLT CORPORATION, AUSTIN, TX. FILED 9-2-2008.



OWNER OF U.S. REG. NO. 3,329,881.
THE MARK CONSISTS OF THE WORDING "HELIOVOLT" AND DESIGNS. A STYLIZED DESIGN OF A LIGHTNING BOLT FORMS THE INTERIOR OF THE LETTER "V" IN "VOLT", AND A DESIGN OF A STARBURST APPEARS ABOVE THE WORDING.

CLASS 6—METAL GOODS

FOR METAL ROOFING, ROOFING TILES, AND ROOFING PANELS; METAL CLADDING FOR CONSTRUCTION AND BUILDING; METAL EXTERIOR WINDOW SHADES AND SHUTTERS; METAL SKYLIGHTS; METAL WINDOWS; ALL CONTAINING PHOTOVOLTAIC INTEGRATED CIRCUITS (U.S. CLS. 2, 12, 13, 14, 23, 25 AND 50).

CLASS 9—ELECTRICAL AND SCIENTIFIC APPARATUS

FOR APPARATUS FOR CONVERTING ELECTRONIC RADIATION TO ELECTRICAL ENERGY FOR THE GENERATION OF ELECTRICAL ENERGY FROM PHOTOVOLTAIC AND/OR SOLAR SOURCES, NAMELY, PHOTOVOLTAIC CELLS, SOLAR MODULES, ARRAYS, AND SOLAR PANELS (U.S. CLS. 21, 23, 26, 36 AND 38).

CLASS 19—NON-METALLIC BUILDING MATERIALS

FOR NON-METAL ROOFING, ROOFING TILES, AND ROOFING PANELS; NON-METAL CLADDING FOR CONSTRUCTION AND BUILDING; NON-METAL EXTERIOR WINDOW SHADES AND SHUTTERS; GLASS PANELS FOR BUILDING CONSTRUCTION PURPOSES; GLASS WINDOWS; GLASS PANES; NON-METAL SKYLIGHTS; NON-METAL WINDOWS; ALL CONTAINING PHOTOVOLTAIC INTEGRATED CIRCUITS (U.S. CLS. 1, 12, 33 AND 50).

CORY BOONE, EXAMINING ATTORNEY

SN 77-560,343. HELIOVOLT CORPORATION, AUSTIN, TX. FILED 9-2-2008.



OWNER OF U.S. REG. NO. 3,329,881.
THE MARK CONSISTS OF THE WORDING "HELIOVOLT", AND A STYLIZED DESIGN OF A LIGHTNING BOLT FORMS THE INTERIOR OF THE LETTER "V" IN "VOLT".

CLASS 6—METAL GOODS

FOR METAL ROOFING, ROOFING TILES, AND ROOFING PANELS; METAL CLADDING FOR CONSTRUCTION AND BUILDING; METAL EXTERIOR WINDOW SHADES AND SHUTTERS; METAL SKYLIGHTS; METAL WINDOWS; ALL CONTAINING PHOTOVOLTAIC INTEGRATED CIRCUITS (U.S. CLS. 2, 12, 13, 14, 23, 25 AND 50).

CLASS 9—ELECTRICAL AND SCIENTIFIC APPARATUS

FOR APPARATUS FOR CONVERTING ELECTRONIC RADIATION TO ELECTRICAL ENERGY FOR THE GENERATION OF ELECTRICAL ENERGY FROM PHOTOVOLTAIC AND/OR SOLAR SOURCES, NAMELY, PHOTOVOLTAIC CELLS, SOLAR MODULES, ARRAYS, AND SOLAR PANELS (U.S. CLS. 21, 23, 26, 36 AND 38).

CLASS 19—NON-METALLIC BUILDING MATERIALS

FOR NON-METAL ROOFING, ROOFING TILES, AND ROOFING PANELS; NON-METAL CLADDING FOR CONSTRUCTION AND BUILDING; NON-METAL EXTERIOR WINDOW SHADES AND SHUTTERS; GLASS PANELS FOR BUILDING CONSTRUCTION PURPOSES; GLASS WINDOWS; GLASS PANES; NON-METAL SKYLIGHTS; NON-METAL WINDOWS; ALL CONTAINING PHOTOVOLTAIC INTEGRATED CIRCUITS (U.S. CLS. 1, 12, 33 AND 50).

CORY BOONE, EXAMINING ATTORNEY

SN 77-560,484. ALLIANCE FOR LUPUS RESEARCH, INC., NEW YORK, NY. FILED 9-2-2008.

FACES OF LUPUS

THE MARK CONSISTS OF STANDARD CHARACTERS WITHOUT CLAIM TO ANY PARTICULAR FONT, STYLE, SIZE, OR COLOR.

OWNER OF U.S. REG. NOS. 2,762,680 AND 2,823,882.

NO CLAIM IS MADE TO THE EXCLUSIVE RIGHT TO USE "LUPUS", APART FROM THE MARK AS SHOWN.

CLASS 16—PAPER GOODS AND PRINTED MATTER

FOR PUBLICATIONS, NAMELY, NEWSLETTERS, MAGAZINES AND PAMPHLETS ON LUPUS AND ON OTHER AUTO-IMMUNE DISEASES, ON CHARITABLE SERVICES, ON FUNDRAISING AND ON SCIENTIFIC AND MEDICAL RESEARCH (U.S. CLS. 2, 5, 22, 23, 29, 37, 38 AND 50).

FIRST USE 1-1-2007; IN COMMERCE 1-1-2007.

CLASS 36—INSURANCE AND FINANCIAL

FOR CHARITABLE FUND RAISING SERVICES; PROVIDING FUNDING AND GRANTS FOR RESEARCH AND DEVELOPMENT ACTIVITIES IN THE FIELD OF LUPUS RESEARCH; PROVIDING INFORMATION VIA A WEB SITE, NAMELY, PROVIDING INDIVIDUALS WITH THE INFORMATION AND OPPORTUNITY TO MAKE MONETARY DONATIONS TO THEIR FAVORITE CHARITY, CHARITABLE FUND RAISING AND PROVIDING FUNDING AND GRANTS FOR SCIENTIFIC AND MEDICAL RESEARCH (U.S. CLS. 100, 101 AND 102).

FIRST USE 12-31-2004; IN COMMERCE 12-31-2004.

CLASS 44—MEDICAL, BEAUTY AND AGRICULTURAL SERVICES

FOR PROVIDING A WEBSITE FEATURING MEDICAL INFORMATION, NEWS ARTICLES AND VIDEOS CONCERNING THE TREATMENT OF LUPUS AND OTHER AUTO-IMMUNE DISEASES (U.S. CLS. 100 AND 101).

FIRST USE 7-31-2006; IN COMMERCE 7-31-2006.

KATHLEEN M. VANSTON, EXAMINING ATTORNEY

SN 77-560,397. JONHAW PEI, DBA FRUITEALICIOUS, DALLAS, TX. FILED 9-2-2008.



THE COLOR(S) PINK, GREEN, WHITE AND ORANGE IS/ARE CLAIMED AS A FEATURE OF THE MARK.

THE MARK CONSISTS OF THE WORD "FRU" IS IN THE COLOR PINK, THE WORD "TEA" IN THE COLOR GREEN, AND "LICIOU'S" IN THE COLOR ORANGE. ALSO, THE LETTER "O" IN LICIOU'S HAS 2 GREEN LEAVES ON TOP OF IT. THE WORD FRUITEALICIOUS IS SURROUNDED BY A WHITE BORDER THAN AN ORANGE BORDER.

CLASS 30—STAPLE FOODS

FOR BEVERAGES MADE OF COFFEE; BEVERAGES MADE OF TEA; COFFEE BASED BEVERAGES; PREPARED COCOA AND COCOA-BASED BEVERAGES; PREPARED COFFEE AND COFFEE-BASED BEVERAGES; SCENTED WATER FOR FLAVORING BEVERAGES; TEA-BASED BEVERAGES WITH FRUIT FLAVORING (U.S. CL. 46).

CLASS 32—LIGHT BEVERAGES

FOR FROZEN FRUIT BEVERAGES; FROZEN FRUIT-BASED BEVERAGES; FRUIT BEVERAGES; FRUIT CONCENTRATES AND PUREES USED AS INGREDIENTS OF BEVERAGES; FRUIT-FLAVORED BEVERAGES; FRUIT-FLAVORED BEVERAGES; GRAPE JUICE BEVERAGES; ICED FRUIT BEVERAGES; NON-ALCOHOLIC FRUIT JUICE BEVERAGES; SMOOTHIES (U.S. CLS. 45, 46 AND 48).

KEVON CHISOLM, EXAMINING ATTORNEY

SN 77-560,500. UNLEASHED LIFE LLC, FORMERLY TAYLOR-MARTIN GROUP LLC UNLEASHED LIFE LLC, SPRINGFIELD, MO. FILED 9-2-2008.

STYLE ... NOT RESERVED FOR HUMANS

THE MARK CONSISTS OF STANDARD CHARACTERS WITHOUT CLAIM TO ANY PARTICULAR FONT, STYLE, SIZE, OR COLOR.

CLASS 20—FURNITURE AND ARTICLES NOT OTHERWISE CLASSIFIED

FOR DOG BEDS (U.S. CLS. 2, 13, 22, 25, 32 AND 50).

FIRST USE 9-17-2007; IN COMMERCE 10-1-2007.

CLASS 21—HOUSEWARES AND GLASS

FOR BASINS; BOWLS; CERAMIC SCULPTURES, VASES, VESSELS, BOWLS, PLATES AND POTS; EARTHENWARE BASINS; HOUSEHOLD CONTAINERS FOR FOODS (U.S. CLS. 2, 13, 23, 29, 30, 33, 40 AND 50).
FIRST USE 9-17-2007; IN COMMERCE 10-1-2007.
LINDA M. KING, EXAMINING ATTORNEY

CLASS 36—INSURANCE AND FINANCIAL

FOR CHARITABLE FUND RAISING; FINANCING MEDICAL RESEARCH; ACCEPTING AND ADMINISTERING MONETARY CHARITABLE CONTRIBUTIONS TO FUND MEDICAL RESEARCH; AND CHARITABLE FUND RAISING SERVICES FOR SENDING CHILDREN AND YOUNG ADULTS WITH DISABILITIES TO A SUMMER CAMP (U.S. CLS. 100, 101 AND 102).
FIRST USE 0-0-1987; IN COMMERCE 0-0-1987.

SN 77-560,600. VINI VICCI, INC., NASHVILLE, TN. FILED 9-2-2008.

CLASS 41—EDUCATION AND ENTERTAINMENT

FOR EDUCATION INFORMATION AND COURSES RELATING TO NEUROPSYCHOLOGY, SPINAL CORD INJURY MEDICINE AND BRAIN INJURY MEDICINE (U.S. CLS. 100, 101 AND 107).
FIRST USE 0-0-1987; IN COMMERCE 0-0-1987.

FEELGOODS

THE MARK CONSISTS OF STANDARD CHARACTERS WITHOUT CLAIM TO ANY PARTICULAR FONT, STYLE, SIZE, OR COLOR.

CLASS 44—MEDICAL, BEAUTY AND AGRICULTURAL SERVICES

FOR HOSPITAL AND MEDICAL SERVICES FOR PERSONS WITH PHYSICAL AND/OR COGNITIVE DISABILITIES OR IMPAIRMENTS; AND REHABILITATION PATIENT CARE SERVICES WHICH INCLUDES INPATIENT AND OUTPATIENT CARE ACTIVITIES (U.S. CLS. 100 AND 101).
FIRST USE 0-0-1987; IN COMMERCE 0-0-1987.
CHARLES L. JENKINS, EXAMINING ATTORNEY

CLASS 32—LIGHT BEVERAGES

FOR BEER, ALE AND LAGER (U.S. CLS. 45, 46 AND 48).

SN 77-560,720. WHOLESALE SUPPLY COMPANY, SPRINGFIELD, MO. FILED 9-2-2008.

CLASS 33—WINES AND SPIRITS

FOR ALCOHOLIC BEVERAGES, EXCEPT BEERS (U.S. CLS. 47 AND 49).

PROGUARD

THE MARK CONSISTS OF STANDARD CHARACTERS WITHOUT CLAIM TO ANY PARTICULAR FONT, STYLE, SIZE, OR COLOR.

CLASS 41—EDUCATION AND ENTERTAINMENT

FOR NIGHTCLUB SERVICES, DANCE CLUB SERVICES AND MUSIC HALLS (U.S. CLS. 100, 101 AND 107).

CLASS 43—HOTEL AND RESTAURANT SERVICES

FOR RESTAURANT, BAR AND TAVERN SERVICES (U.S. CLS. 100 AND 101).

CLASS 6—METAL GOODS

FOR METAL DOOR FRAMES; METAL DOOR UNITS; METAL DOORS (U.S. CLS. 2, 12, 13, 14, 23, 25 AND 50).

CLASS 44—MEDICAL, BEAUTY AND AGRICULTURAL SERVICES

FOR TATTOO SERVICES (U.S. CLS. 100 AND 101).
BRENDAN MCCAULEY, EXAMINING ATTORNEY

CLASS 19—NON-METALLIC BUILDING MATERIALS

FOR DOORS OF WOOD CLAD IN ALUMINUM; NON-METAL DOOR FRAMES; NON-METAL DOOR UNITS; NON-METAL DOORS (U.S. CLS. 1, 12, 33 AND 50).
JAY BESCH, EXAMINING ATTORNEY

SN 77-560,693. INSTITUTE FOR REHABILITATION AND RESEARCH FOUNDATION, THE, HOUSTON, TX. FILED 9-2-2008.

SN 77-560,725. LIKEMINDS, INC., DBA SAVEMYRATINGS, ATLANTA, GA. FILED 9-2-2008.

TIRR

THE MARK CONSISTS OF STANDARD CHARACTERS WITHOUT CLAIM TO ANY PARTICULAR FONT, STYLE, SIZE, OR COLOR.

SaveMyRatings

THE MARK CONSISTS OF STANDARD CHARACTERS WITHOUT CLAIM TO ANY PARTICULAR FONT, STYLE, SIZE, OR COLOR.

CLASS 38—COMMUNICATION

FOR COMPUTER SERVICES, NAMELY, PROVIDING ON-LINE FACILITIES FOR REAL-TIME INTERACTION WITH OTHER COMPUTER USERS CONCERNING TOPICS OF GENERAL INTEREST (U.S. CLS. 100, 101 AND 104).

CLASS 42—SCIENTIFIC AND COMPUTER SERVICES

FOR APPLICATION SERVICE PROVIDER (ASP) FEATURING SOFTWARE FOR USE IN UPLOADING, DOWNLOADING, AND STORING RATINGS OF PRODUCTS AND SERVICES, AND IN POSTING, DISPLAYING, TAGGING, SHARING OF RATINGS OF PRODUCTS AND SERVICES; AND APPLICATION SERVICE PROVIDER FEATURING SOFTWARE FOR USE IN DATA MINING AND RECOMMENDATION SYSTEMS BASED ON USER-DEFINED INFORMATION, RATINGS OF PRODUCTS AND SERVICES, PERSONAL PROFILE, AND OTHER GENERATED INFORMATION.; COMPUTER SERVICES, NAMELY, HOSTING AND MAINTAINING AN ON-LINE WEB SITE FOR OTHERS TO UPLOAD, DOWNLOAD, STORE, DISPLAY, SHARE, ORGANIZE THEIR REVIEWS, RATINGS AND FAVORITES OF ENTERTAINMENT SUBJECTS INCLUDING MOVIES, BOOKS, MUSIC, AND OTHER ENTERTAINMENT THEMES (U.S. CLS. 100 AND 101).

CIMMERIAN COLEMAN, EXAMINING ATTORNEY

SN 77-560,862. KATE'S PAPERIE LLC, NEW YORK, NY. FILED 9-2-2008.

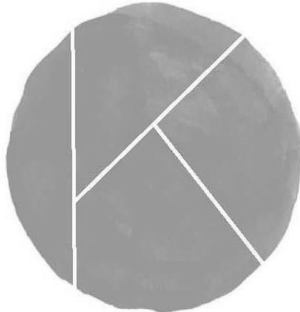

THE MARK CONSISTS OF STYLIZED LETTER "K" INSIDE A CIRCLE.

CLASS 16—PAPER GOODS AND PRINTED MATTER

FOR STATIONERY, PERSONALIZED STATIONERY, TISSUE PAPER FOR GIFT WRAPPING, COCKTAIL NAPKINS MADE OF PAPER, WRAPPING PAPER, COLLAGE BAGS CONSISTING OF PAPER FOR ORIGAMI AND BOOK COVERING, SKETCH BOOKS, PRESENTATION FOLDERS, BLANK WRITING JOURNALS, 3-RING BINDERS, ADDRESS BOOKS, GUEST BOOKS, CHILDREN BOOKS, GIFT BOXES, PHOTO STORAGE BOXES, FILE BOXES FOR STORAGE OF MAGAZINES, FILE BOXES FOR STORAGE OF BUSINESS AND PERSONAL RECORD, STORAGE CONTAINERS MADE OF PAPER, PAPER FOLDERS, STATIONARY FOLDERS, NOTEBOOKS, CALENDARS, STATIONERY WRITING PAPER AND ENVELOPES, CRAFT PAPER, BALLPOINT PENS, RUBBER STAMPS, ALBUMS FOR PHOTOGRAPHS, LUNCH BAGS, STICKERS, PAPER WEIGHTS, PASSPORT HOLDERS; INVITATION CARDS, PLACE CARDS, PERSONAL ORGANIZERS, MAPS, STAPLES (U.S. CLS. 2, 5, 22, 23, 29, 37, 38 AND 50).

CLASS 26—FANCY GOODS

FOR RIBBONS FOR GIFT WRAPPING (U.S. CLS. 37, 39, 40, 42 AND 50).

CLASS 35—ADVERTISING AND BUSINESS

FOR WHOLESALE STORES, RETAIL STORES, ON-LINE RETAIL STORES, AND MAIL ORDER CATALOG SERVICES FEATURING ALL OF THE FOLLOWING: PAPER AND FINE PAPER, NAMELY, STATIONERY; WRAPPING PAPER AND COCKTAIL NAPKINS MADE OF PAPER; INVITATION CARDS; PLACE CARDS; PERSONALIZED PAPER PRODUCTS; PERSONAL ORGANIZERS; ART SUPPLIES; WRITING AND ART ACCESSORIES; RECIPE BOXES; HARDCOVER AND SOFT COVER BOOKS, NAMELY, SKETCHBOOKS, JOURNALS, ADDRESS BOOKS, GUEST BOOKS, CHILDREN BOOKS, AND NEW YORK CITY AREA GUIDE BOOKS; PICTURE FRAMES; PHOTO ALBUMS; GIFT ACCESSORIES, NAMELY, RIBBONS FOR GIFT WRAPPING; WEDDING FAVORS; CUSTOM MADE BOXES OF CARDBOARD AND PAPER; ARCHIVAL UNITS AND STORAGE CABINETS FOR PAPER; MAPS; STAPLES; TOTE BAGS; BACKPACKS; TRAVEL CASES; LUGGAGE TAGS; APRONS; CARD GAMES; STUFFED TOYS (U.S. CLS. 100, 101 AND 102).

MARGARET POWER, EXAMINING ATTORNEY

SN 77-561,277. LEGENDARY SOUND INTERNATIONAL LTD., ROAD TOWN, TORTOLA, BR.VIRGIN ISLANDS, FILED 9-3-2008.



OWNER OF U.S. REG. NOS. 2,624,996 AND 3,458,642.

CLASS 15—MUSICAL INSTRUMENTS

FOR MUSICAL INSTRUMENTS (U.S. CLS. 2, 21 AND 36).

CLASS 28—TOYS AND SPORTING GOODS

FOR MUSICAL TOYS (U.S. CLS. 22, 23, 38 AND 50).
KATHERINE M. DUBRAY, EXAMINING ATTORNEY

SN 77-561,314. DIVERSIFIED MARKETING SOLUTIONS, LLC, OWASSO, OK. FILED 9-3-2008.

WILDROOTS

THE MARK CONSISTS OF STANDARD CHARACTERS WITHOUT CLAIM TO ANY PARTICULAR FONT, STYLE, SIZE, OR COLOR.

CLASS 29—MEATS AND PROCESSED FOODS

FOR ORGANIC AND NON-ORGANIC FOODS, NAMELY, DRIED FRUIT, DEHYDRATED FRUIT SNACKS, SNACK MIXES CONSISTING OF DEHYDRATED FRUIT AND PROCESSED NUTS, NUT AND SEED-BASED SNACK BARS (U.S. CL. 46).

CLASS 30—STAPLE FOODS

FOR ORGANIC AND NON-ORGANIC FOODS, NAMELY, PROCESSED CEREALS, READY TO EAT, CEREAL DERIVED FOOD BARS, GRANOLA-BASED SNACK BARS, COOKIES, CRACKERS, PREPACKAGED PASTA, PREPACKAGED RICE, AND SAUCES, NAMELY, SALAD DRESSINGS, BARBEQUE SAUCES, TOMATO SAUCES, PASTA SAUCES AND SPAGHETTI SAUCES (U.S. CL. 46).

COURTNEY MCCORMICK, EXAMINING ATTORNEY

SN 77-561,383. DOMINEUM GROUP LLC, NEW YORK, NY. FILED 9-3-2008.

DOMINEUM GLOBAL INDEX

THE MARK CONSISTS OF STANDARD CHARACTERS WITHOUT CLAIM TO ANY PARTICULAR FONT, STYLE, SIZE, OR COLOR.

NO CLAIM IS MADE TO THE EXCLUSIVE RIGHT TO USE "GLOBAL INDEX", APART FROM THE MARK AS SHOWN.

CLASS 35—ADVERTISING AND BUSINESS

FOR OPERATING ON-LINE MARKETPLACES FOR BUYERS AND SELLERS OF CONDOMINIUM DEVELOPMENTS, CONDOMINIUM HOTEL SUITES AND FRACTIONAL-CONDOMINIUM INTERESTS; PROVIDING AN ONLINE SEARCHABLE DATABASE FOR THE MARKETING OF CONDOMINIUM DEVELOPMENTS, CONDOMINIUM HOTEL SUITES AND FRACTIONAL-CONDOMINIUM INTERESTS FOR REAL ESTATE PURCHASERS, REAL ESTATE SELLERS, REAL ESTATE BROKERS, MORTGAGE BROKERS, REAL ESTATE ATTORNEYS, REAL ESTATE-MARKET RESEARCHERS, LENDERS, AND INVESTORS; REAL ESTATE-ADVERTISING SERVICES; PROVIDING A WEB SITE WHICH FEATURES ADVERTISEMENTS FOR THE GOODS AND SERVICES OF OTHERS ON A GLOBAL COMPUTER NETWORK; PROVIDING REAL ESTATE LEADS FOR PROSPECTIVE PURCHASERS AND SELLERS; REAL ESTATE-MARKETING SERVICES IN THE FIELD OF CONDOMINIUMS, LUXURY APARTMENTS, HOTEL SUITES AND HOMES (U.S. CLS. 100, 101 AND 102).

CLASS 36—INSURANCE AND FINANCIAL

FOR REAL-ESTATE-INVESTMENT SERVICES IN THE NATURE OF PURCHASING AND SELLING OF REAL ESTATE FOR OTHERS; ASSESSMENT OF REAL ESTATE; REAL-ESTATE PROCUREMENT FOR OTHERS; PROVIDING REAL-ESTATE LISTINGS AND REAL-ESTATE INFORMATION VIA THE INTERNET; REAL-ESTATE-ACQUISITION SERVICES; REAL-ESTATE-MANAGEMENT CONSULTATION; REAL-ESTATE SERVICES, NAMELY, RENTAL OF VACATION HOMES, CONDOMINIUMS AND VILLAS VIA THE INTERNET; FRACTIONAL-SHARE-EXCHANGE SERVICES FOR CONDOMINIUM INTERESTS AND CONDOMINIUM HOTEL SUITES (U.S. CLS. 100, 101 AND 102).

CLASS 38—COMMUNICATION

FOR PROVIDING ONLINE ELECTRONIC BULLETIN BOARDS AND FORUMS FOR TRANSMISSION OF MESSAGES AMONG COMPUTER USERS CONCERNING CONDOMINIUM DEVELOPMENTS, CONDOMINIUM HOTEL SUITES AND FRACTIONAL-CONDOMINIUM INTERESTS AND CONTENT RELEVANT TO REAL ESTATE PURCHASERS, REAL ESTATE SELLERS, REAL ESTATE BROKERS, MORTGAGE BROKERS, REAL ESTATE ATTORNEYS, REAL ESTATE-MARKET RESEARCHERS, LENDERS AND INVESTORS (U.S. CLS. 100, 101 AND 104).

CLASS 41—EDUCATION AND ENTERTAINMENT

FOR PROVIDING ONLINE INFORMATION AND NEWS IN THE FIELDS OF ART; WORKSHOPS, EDUCATIONAL FORUMS, AND SEMINARS IN THE FIELD OF RESEARCHING, BUYING, SELLING AND INVESTING IN CONDOMINIUM DEVELOPMENTS, CONDOMINIUM HOTEL SUITES AND FRACTIONAL-CONDOMINIUM INTERESTS; TRAINING REAL-ESTATE DEVELOPERS, MARKETERS AND SALES AGENTS IN THE FIELD OF BUYING, SELLING AND INVESTING IN CONDOMINIUM DEVELOPMENTS, CONDOMINIUM HOTEL SUITES AND FRACTIONAL-CONDOMINIUM INTERESTS (U.S. CLS. 100, 101 AND 107).

NICHOLAS COLEMAN, EXAMINING ATTORNEY

SN 77-561,794. YOSEMITE NATIONAL INSTITUTES, SAUSALITO, CA. FILED 9-3-2008.



THE MARK CONSISTS OF A STYLIZED LEAF SURROUNDED BY A CIRCLE.

CLASS 25—CLOTHING

FOR SHIRTS; HEADGEAR, NAMELY, HATS AND CAPS; CAMPSHIRTS; SWEAT SHIRTS; JACKETS (U.S. CLS. 22 AND 39).

CLASS 41—EDUCATION AND ENTERTAINMENT

FOR EDUCATIONAL SERVICES, NAMELY, PROVIDING CLASSES, SEMINARS, WORKSHOPS IN THE FIELDS OF WILDERNESS EDUCATION, FIELD SCIENCE EDUCATION, LEADERSHIP EDUCATION AND TEACHER TRAINING PROGRAMS IN THE SAME FIELDS; DAY CAMP SERVICES; SUMMER CAMPS (U.S. CLS. 100, 101 AND 107).

CLASS 43—HOTEL AND RESTAURANT SERVICES

FOR PROVISION OF CONFERENCE, EXHIBITION AND MEETING FACILITIES (U.S. CLS. 100 AND 101).

CIMMERIAN COLEMAN, EXAMINING ATTORNEY

SN 77-561,856. AVACORP, INC., NORCROSS, GA. FILED 9-3-2008.

SN 77-562,033. MILWAUKEE PHILANTHROPIC VENTURE FUND, INC., MILWAUKEE, WI. FILED 9-4-2008.

Avacorp

THE MARK CONSISTS OF STANDARD CHARACTERS WITHOUT CLAIM TO ANY PARTICULAR FONT, STYLE, SIZE, OR COLOR.

CLASS 35—ADVERTISING AND BUSINESS

FOR RETAIL STORE AND ON-LINE RETAIL STORE SERVICES FEATURING COMPUTER NETWORK SYSTEMS, CONSUMER ELECTRONICS, SECURITY CAMERAS, ACCESS CONTROL SYSTEMS, DATA COLLECTION, AND RFID (U.S. CLS. 100, 101 AND 102).
FIRST USE 1-0-2004; IN COMMERCE 1-0-2004.

CLASS 37—CONSTRUCTION AND REPAIR

FOR INSTALLATION, MAINTENANCE AND REPAIR OF COMPUTER NETWORK SYSTEMS, CONSUMER ELECTRONICS, SECURITY CAMERAS, ACCESS CONTROL SYSTEMS, DATA COLLECTION, AND RFID (U.S. CLS. 100, 103 AND 106).
FIRST USE 1-0-2004; IN COMMERCE 1-0-2004.
VERNA BETH RIRIE, EXAMINING ATTORNEY

SN 77-561,945. LIVELOCAL MEDIA GROUP, INC., FT. LAUDERDALE, FL. FILED 9-4-2008.

CONCIERGEVISION

THE MARK CONSISTS OF STANDARD CHARACTERS WITHOUT CLAIM TO ANY PARTICULAR FONT, STYLE, SIZE, OR COLOR.

CLASS 9—ELECTRICAL AND SCIENTIFIC APPARATUS

FOR VIDEO MONITORS (U.S. CLS. 21, 23, 26, 36 AND 38).

CLASS 38—COMMUNICATION

FOR TRANSMISSION OF INFORMATION THROUGH VIDEO COMMUNICATION SYSTEMS, NAMELY, PROVIDING A HOTEL LOBBY VIDEO SYSTEM THAT BROADCASTS VIDEO, NEWS AND ADVERTISING CONTENT TO HOTEL GUESTS (U.S. CLS. 100, 101 AND 104).
KOURTNEE HODGES, EXAMINING ATTORNEY

A NATION WITH A HEART

THE MARK CONSISTS OF STANDARD CHARACTERS WITHOUT CLAIM TO ANY PARTICULAR FONT, STYLE, SIZE, OR COLOR.

CLASS 35—ADVERTISING AND BUSINESS

FOR CHARITABLE SERVICES, NAMELY, PROMOTING PUBLIC AWARENESS IN THE FIELD OF POVERTY (U.S. CLS. 100, 101 AND 102).

CLASS 36—INSURANCE AND FINANCIAL

FOR PHILANTHROPIC SERVICES CONCERNING MONETARY DONATIONS; CHARITABLE FUNDRAISING SERVICES; CHARITABLE SERVICES, NAMELY PROVIDING FUNDS TO SUPPORT CHARITABLE PROJECTS; PROVIDING GRANTS TO SUPPORT CHARITABLE PROJECTS; PROVIDING GRANTS TO ORGANIZATIONS FOCUSING ON POVERTY, EDUCATION, THE ARTS AND THE ENVIRONMENT; ACCEPTING AND ADMINISTERING MONETARY CHARITABLE CONTRIBUTIONS (U.S. CLS. 100, 101 AND 102).

CLASS 41—EDUCATION AND ENTERTAINMENT

FOR EDUCATIONAL SERVICES, NAMELY, PROVIDING FORUMS AND PROGRAMS IN THE FIELD OF ERADICATING POVERTY AND PRINTABLE MATERIALS DISTRIBUTED THEREWITH (U.S. CLS. 100, 101 AND 107).
MIDGE BUTLER, EXAMINING ATTORNEY

SN 77-562,172. MIRAGE TILE, L.L.C., NEWPORT NEWS, VA. FILED 9-4-2008.

Baywatch Tile

THE MARK CONSISTS OF STANDARD CHARACTERS WITHOUT CLAIM TO ANY PARTICULAR FONT, STYLE, SIZE, OR COLOR.

NO CLAIM IS MADE TO THE EXCLUSIVE RIGHT TO USE "TILE", APART FROM THE MARK AS SHOWN.

CLASS 6—METAL GOODS

FOR TILES OF METAL FOR WALLS, FLOORS, AND CEILINGS (U.S. CLS. 2, 12, 13, 14, 23, 25 AND 50).

CLASS 19—NON-METALLIC BUILDING MATERIALS

FOR TILES OF GLASS, PORCELAIN, AND STONE FOR WALLS, FLOORS, AND CEILINGS (U.S. CLS. 1, 12, 33 AND 50).
LINDSEY RUBIN, EXAMINING ATTORNEY

SN 77-562,344. BREITBACH, DAVID R, WESTBY, WI. FILED 9-4-2008.

Activate Your Inner Brilliance

THE MARK CONSISTS OF STANDARD CHARACTERS WITHOUT CLAIM TO ANY PARTICULAR FONT, STYLE, SIZE, OR COLOR.

CLASS 9—ELECTRICAL AND SCIENTIFIC APPARATUS

FOR DIGITAL MEDIA, NAMELY, PRE-RECORDED AUDIO AND VIDEO CASSETTES, DOWNLOADABLE AUDIO AND VIDEO RECORDINGS, CDS, DVDS, AND HIGH DEFINITION DIGITAL DISKS FEATURING INFORMATION IN THE FIELD OF SELF-AWARENESS, PERSONAL AND COMMUNITY AWARENESS, PERSONAL AND COMMUNITY IMPROVEMENT, PERSONAL AND PROFESSIONAL SUCCESS, LIFE COACHING AND LIFE COACH TRAINING (U.S. CLS. 21, 23, 26, 36 AND 38).

CLASS 41—EDUCATION AND ENTERTAINMENT

FOR EDUCATION AND ENTERTAINMENT SERVICES, NAMELY, PROVIDING LIVE CLASSES, PROGRAMS, COURSES, EXAMINATION SERVICES, SEMINARS, WORKSHOPS, RETREATS, TUTORING, ONE-ON-ONE MENTORING, GROUP MENTORING AND MOTIVATIONAL AND EDUCATIONAL SPEAKERS IN THE FIELD OF SELF-AWARENESS, PERSONAL AND COMMUNITY AWARENESS, PERSONAL AND COMMUNITY IMPROVEMENT, PERSONAL AND PROFESSIONAL SUCCESS, LIFE COACHING AND LIFE COACH TRAINING, AND DISTRIBUTION OF PRINTED OR PRINTABLE MATERIAL IN CONNECTION THEREWITH, AND PROVIDING ON-LINE INFORMATION REGARDING SAME; PROVIDING ONLINE COMPUTER GAMES; PROVIDING INCENTIVE AWARD PROGRAMS DESIGNED TO REWARD PROGRAM PARTICIPANTS WHO ENGAGE IN PERSONAL AND COMMUNITY AWARENESS PROMOTING ACTIVITIES (U.S. CLS. 100, 101 AND 107).

FIRST USE 12-17-2007; IN COMMERCE 12-17-2007.
ARETHA SOMERVILLE, EXAMINING ATTORNEY

SN 77-562,412. OPTIMER, INC., WILMINGTON, DE. FILED 9-4-2008.



THE MARK CONSISTS OF A STYLIZED LETTER "N" INSIDE A BROKEN OVAL WITH A FILLED CIRCLE IN THE UPPER LEFT SIDE OF THE OVAL.

CLASS 10—MEDICAL APPARATUS

FOR SURGICAL DRAPES, SURGICAL SCRUB SUITS (U.S. CLS. 26, 39 AND 44).

CLASS 24—FABRICS

FOR BED SHEETS, TOWELS, FITTED BED SHEET COVERS, BED FLAT SHEETS, PILLOW CASES USED IN BEDDING (U.S. CLS. 42 AND 50).

CLASS 25—CLOTHING

FOR BOXER SHORTS, TEE SHIRTS, NIGHTWEAR, BRAS, UNDERWEAR BRIEFS, CLOTHING CAPS, GOLF SHIRTS, GYM SHORTS, GYM SUITS, JEANS, CLOTHING JERSEYS, JOGGING SUITS, KNIT SHIRTS, WARM-UP SUITS, SWEAT SHORTS, SWEATPANTS, SWEAT SHIRTS, SWEAT SUITS, SWEAT SOCKS, THERMAL UNDERWEAR, TENNIS WEAR, TANK TOPS, TRACK-SUITS, UNDERCLOTHES, UNDERGARMENTS, UNIFORMS, FLEECE TOPS, POLO SHIRTS, GOLF PANTS, MEN'S AND WOMEN'S DRESS SHIRTS, SPORTSBRAS, AND SOCKS (U.S. CLS. 22 AND 39).

DAVID YONTEF, EXAMINING ATTORNEY

SN 77-562,423. ABRAMS GENTILE ENTERTAINMENT, INC., NEW YORK, NY. FILED 9-4-2008.

PHAROID

THE MARK CONSISTS OF STANDARD CHARACTERS WITHOUT CLAIM TO ANY PARTICULAR FONT, STYLE, SIZE, OR COLOR.

CLASS 28—TOYS AND SPORTING GOODS

FOR TOY ACTION FIGURES AND VEHICLES, AND ACCESSORIES THEREFOR (U.S. CLS. 22, 23, 38 AND 50).

CLASS 41—EDUCATION AND ENTERTAINMENT

FOR ENTERTAINMENT SERVICES, NAMELY, PRODUCTION OF MOVIES, TELEVISION SHOWS AND PRERECORDED VIDEOS (U.S. CLS. 100, 101 AND 107).
LINDA ORNDORFF, EXAMINING ATTORNEY

SN 77-562,553. VIANI, ARTHUR, MIAMI, FL. FILED 9-4-2008.

GHOST INC

THE MARK CONSISTS OF STANDARD CHARACTERS WITHOUT CLAIM TO ANY PARTICULAR FONT, STYLE, SIZE, OR COLOR.

NO CLAIM IS MADE TO THE EXCLUSIVE RIGHT TO USE "INC", APART FROM THE MARK AS SHOWN.

CLASS 13—FIREARMS

FOR HOLSTERS (U.S. CLS. 2 AND 9).
FIRST USE 12-15-1999; IN COMMERCE 7-12-2003.

CLASS 35—ADVERTISING AND BUSINESS

FOR ON-LINE RETAIL STORE SERVICES FEATURING FIREARMS ACCESSORIES; WHOLESALE DISTRIBUTORSHIPS FEATURING FIREARMS ACCESSORIES (U.S. CLS. 100, 101 AND 102).

FIRST USE 12-15-1999; IN COMMERCE 12-15-1999.
HEATHER BIDDULPH, EXAMINING ATTORNEY

CLASS 25—CLOTHING

FOR ATHLETIC APPAREL, NAMELY, SHIRTS, PANTS, JACKETS, FOOTWEAR, HATS AND CAPS, ATHLETIC UNIFORMS (U.S. CLS. 22 AND 39).
LANA PHAM, EXAMINING ATTORNEY

SN 77-562,769. E-PARTNERS IN GIVING, LLC, FORTH WORTH, TX. FILED 9-4-2008.

E-PARTNERS IN GIVING

THE MARK CONSISTS OF STANDARD CHARACTERS WITHOUT CLAIM TO ANY PARTICULAR FONT, STYLE, SIZE, OR COLOR.

CLASS 36—INSURANCE AND FINANCIAL

FOR CHARITABLE FUNDRAISING SERVICES, NAMELY, BY PROVIDING INDIVIDUALS WITH THE INFORMATION AND OPPORTUNITY TO MAKE MONETARY DONATIONS TO THEIR FAVORITE CHARITY VIA A GLOBAL COMPUTER NETWORK (U.S. CLS. 100, 101 AND 102).

CLASS 38—COMMUNICATION

FOR TRANSMISSION OF DATA, DOCUMENTS, ELECTRONIC MAIL, ANNOUNCEMENTS, PHOTOGRAPHS AND GREETINGS VIA A GLOBAL COMPUTER NETWORK (U.S. CLS. 100, 101 AND 104).
ROBIN CHOSID, EXAMINING ATTORNEY

SN 77-562,832. TIRE'D WATCH CO., LLC, MANHASSET, NY. FILED 9-4-2008.

TIRE'D WATCH CO.

THE MARK CONSISTS OF STANDARD CHARACTERS WITHOUT CLAIM TO ANY PARTICULAR FONT, STYLE, SIZE, OR COLOR.

NO CLAIM IS MADE TO THE EXCLUSIVE RIGHT TO USE "WATCH CO.", APART FROM THE MARK AS SHOWN.

CLASS 14—JEWELRY

FOR WATCHES AND STRAPS FOR WATCHES (U.S. CLS. 2, 27, 28 AND 50).

CLASS 18—LEATHER GOODS

FOR BACKPACKS, BOOK BAGS, SPORTS BAGS, BUM BAGS, WALLETS AND HANDBAGS; GYM BAGS (U.S. CLS. 1, 2, 3, 22 AND 41).

SN 77-562,897. PREFAST CONCRETE WALL SYSTEMS, INC., SAN MATEO, CA. FILED 9-4-2008.

PREFAST

THE MARK CONSISTS OF STANDARD CHARACTERS WITHOUT CLAIM TO ANY PARTICULAR FONT, STYLE, SIZE, OR COLOR.

OWNER OF U.S. REG. NO. 2,351,716.

CLASS 19—NON-METALLIC BUILDING MATERIALS

FOR CONCRETE BUILDING PANELS; PREFABRICATED, PRIMARILY NON-METAL BUILDINGS (U.S. CLS. 1, 12, 33 AND 50).

FIRST USE 3-3-1999; IN COMMERCE 3-3-1999.

CLASS 37—CONSTRUCTION AND REPAIR

FOR INTALLATION OF MODULAR BUILDINGS; CONSTRUCTION OF BUILDINGS (U.S. CLS. 100, 103 AND 106).

FIRST USE 8-9-2006; IN COMMERCE 8-9-2006.

CLASS 40—MATERIAL TREATMENT

FOR CUSTOM FABRICATION OF MODULAR BUILDINGS (U.S. CLS. 100, 103 AND 106).

FIRST USE 8-9-2006; IN COMMERCE 8-9-2006.

CLASS 42—SCIENTIFIC AND COMPUTER SERVICES

FOR ARCHITECTURAL DESIGN (U.S. CLS. 100 AND 101).

FIRST USE 8-9-2006; IN COMMERCE 8-9-2006.

SAIMA MAKHDOOM, EXAMINING ATTORNEY

SN 77-562,901. PREFAST CONCRETE WALL SYSTEMS, INC., SAN MATEO, CA. FILED 9-4-2008.

PLANTCRAFTED BUILDINGS

THE MARK CONSISTS OF STANDARD CHARACTERS WITHOUT CLAIM TO ANY PARTICULAR FONT, STYLE, SIZE, OR COLOR.

NO CLAIM IS MADE TO THE EXCLUSIVE RIGHT TO USE "BUILDINGS", APART FROM THE MARK AS SHOWN.

CLASS 19—NON-METALLIC BUILDING MATERIALS

FOR CONCRETE BUILDING PANELS; PREFABRICATED, PRIMARILY NON-METAL BUILDINGS (U.S. CLS. 1, 12, 33 AND 50).

SN 77-563,091. AGSTAR FINANCIAL SERVICES, ACA, MANKATO, MN. FILED 9-5-2008.

CLASS 37—CONSTRUCTION AND REPAIR

FOR INTALLATION OF MODULAR BUILDINGS; CONSTRUCTION OF BUILDINGS (U.S. CLS. 100, 103 AND 106).

LOOKOUT RIDGE CONSULTING

CLASS 40—MATERIAL TREATMENT

FOR CUSTOM FABRICATION OF MODULAR BUILDINGS (U.S. CLS. 100, 103 AND 106).

THE MARK CONSISTS OF STANDARD CHARACTERS WITHOUT CLAIM TO ANY PARTICULAR FONT, STYLE, SIZE, OR COLOR.

NO CLAIM IS MADE TO THE EXCLUSIVE RIGHT TO USE "CONSULTING", APART FROM THE MARK AS SHOWN.

CLASS 42—SCIENTIFIC AND COMPUTER SERVICES

FOR ARCHITECTURAL DESIGN (U.S. CLS. 100 AND 101).
SAIMA MAKHDOOM, EXAMINING ATTORNEY

CLASS 35—ADVERTISING AND BUSINESS

FOR BUSINESS CONSULTING SERVICES IN THE FIELD OF AGRICULTURE (U.S. CLS. 100, 101 AND 102).

CLASS 36—INSURANCE AND FINANCIAL

FOR FINANCIAL CONSULTATION IN THE FIELD OF AGRICULTURE (U.S. CLS. 100, 101 AND 102).
DAVID COLLIER, EXAMINING ATTORNEY

SN 77-562,908. FIXNATION, INC., LOS ANGELES, CA. FILED 9-4-2008.

SN 77-563,169. GONHERMEX S.A. DE C.V., MONTERREY, NUEVO LEON, MEXICO, FILED 9-5-2008.



MORE THAN 55 YEARS
PROTECTING AMERICA'S MOTORS

THE MARK CONSISTS OF THE WORD "FIXNATION" AND THE OUTLINE OF A CAT WHICH FORMS A PART OF THE "N" IN "NATION".

THE MARK CONSISTS OF STANDARD CHARACTERS WITHOUT CLAIM TO ANY PARTICULAR FONT, STYLE, SIZE, OR COLOR.

CLASS 44—MEDICAL, BEAUTY AND AGRICULTURAL SERVICES

FOR VETERINARY SERVICES; VETERINARY SURGERY (U.S. CLS. 100 AND 101).
FIRST USE 7-1-2007; IN COMMERCE 7-1-2007.

CLASS 7—MACHINERY

FOR AIR FILTERS FOR VEHICLE MOTORS AND ENGINES; FUEL FILTERS; OIL FILTERS FOR MECHANICAL PURPOSES; OIL FILTERS FOR MOTORS AND ENGINES (U.S. CLS. 13, 19, 21, 23, 31, 34 AND 35).

CLASS 9—ELECTRICAL AND SCIENTIFIC APPARATUS

FOR ELECTRICAL STORAGE BATTERIES (U.S. CLS. 21, 23, 26, 36 AND 38).

CLASS 12—VEHICLES

FOR BRAKE PADS FOR LAND VEHICLES; DISC BRAKE PADS FOR VEHICLES; VEHICLE PARTS, NAMELY, SHOCK ABSORBERS (U.S. CLS. 19, 21, 23, 31, 35 AND 44).

CLASS 45—PERSONAL AND LEGAL SERVICES

FOR ADOPTION SERVICES FOR DOMESTIC ANIMALS (U.S. CLS. 100 AND 101).
FIRST USE 7-1-2007; IN COMMERCE 7-1-2007.
SAIMA MAKHDOOM, EXAMINING ATTORNEY

CLASS 35—ADVERTISING AND BUSINESS

FOR RETAIL AUTOMOBILE PARTS AND ACCESSORIES STORES (U.S. CLS. 100, 101 AND 102).
JEFF DEFORD, EXAMINING ATTORNEY

SN 77-563,190. WISCONSIN PUBLIC POWER INC., SUN PRAIRIE, WI. FILED 9-5-2008.

SN 77-563,335. MDG DEVELOPMENT GROUP LLC, BASKING RIDGE, NJ. FILED 9-5-2008.

Shared strength through WPPI Energy

THE MARK CONSISTS OF STANDARD CHARACTERS WITHOUT CLAIM TO ANY PARTICULAR FONT, STYLE, SIZE, OR COLOR.

CLASS 35—ADVERTISING AND BUSINESS

FOR ENERGY USAGE MANAGEMENT; INFORMATION IN THE FIELD OF ENERGY EFFICIENCY (U.S. CLS. 100, 101 AND 102).

CLASS 39—TRANSPORTATION AND STORAGE

FOR PUBLIC UTILITY SERVICES; PUBLIC UTILITY SERVICES IN THE NATURE OF ELECTRICITY DISTRIBUTION (U.S. CLS. 100 AND 105).

CLASS 40—MATERIAL TREATMENT

FOR PRODUCTION OF ENERGY (U.S. CLS. 100, 103 AND 106).
WILLIAM ROSSMAN, EXAMINING ATTORNEY

SN 77-563,332. SIQUEIROS, GLADYS ALEJANDRA AVILA, CHULA VISTA, CA. FILED 9-5-2008.

HACIENDA LA MENTIROSA

THE MARK CONSISTS OF STANDARD CHARACTERS WITHOUT CLAIM TO ANY PARTICULAR FONT, STYLE, SIZE, OR COLOR.

THE FOREIGN WORDING IN THE MARK TRANSLATES INTO ENGLISH AS "HOUSE OF THE LIAR."

CLASS 25—CLOTHING

FOR APRONS; CAPS; SHIRTS (U.S. CLS. 22 AND 39).

CLASS 43—HOTEL AND RESTAURANT SERVICES

FOR RESTAURANT SERVICES (U.S. CLS. 100 AND 101).
NATALIE POLZER, EXAMINING ATTORNEY

BLUESPARK

THE MARK CONSISTS OF STANDARD CHARACTERS WITHOUT CLAIM TO ANY PARTICULAR FONT, STYLE, SIZE, OR COLOR.

CLASS 35—ADVERTISING AND BUSINESS

FOR BUSINESS CONSULTATION IN THE FIELD OF MEDICINE; BUSINESS MANAGEMENT AND CONSULTATION IN THE FIELD OF MEDICINE; COMMERCIAL INFORMATION AGENCIES (U.S. CLS. 100, 101 AND 102).

CLASS 41—EDUCATION AND ENTERTAINMENT

FOR DEVELOPMENT AND DISSEMINATION OF EDUCATIONAL MATERIALS OF OTHERS IN THE FIELD OF MEDICINE; EDUCATIONAL SERVICES, NAMELY, DEVELOPING CURRICULUM FOR OTHERS IN THE FIELD OF MEDICINE; EDUCATIONAL SERVICES, NAMELY, PROVIDING CONTINUING PROFESSIONAL EDUCATION COURSES IN THE FIELD OF MEDICINE; ELECTRONIC PUBLISHING SERVICES, NAMELY, PUBLICATION OF TEXT AND GRAPHIC WORKS OF OTHERS ON CD, DVD, ON-LINE FEATURING MEDICINE, MEDICAL RESEARCH AND DEVELOPMENT, MEDICAL EDUCATION, CLINICAL MEDICAL RESEARCH, MEDICAL BUSINESS MANAGEMENT, MEDICAL BUSINESS MARKETING; MEDICAL TRAINING AND TEACHING; PROVIDING CONTINUING MEDICAL EDUCATION COURSES; PROVIDING ON-LINE TRAINING IN THE FORM OF COURSES, SEMINARS, AND WORKSHOPS IN THE FIELD OF MEDICINE; PUBLICATION OF TEXTS, BOOKS, MAGAZINES AND OTHER PRINTED MATTER; PUBLISHING AND ISSUING SCIENTIFIC PAPERS IN RELATION TO MEDICAL TECHNOLOGY; PUBLISHING OF JOURNALS, BOOKS AND HANDBOOKS IN THE FIELD OF MEDICINE (U.S. CLS. 100, 101 AND 107).

CLASS 42—SCIENTIFIC AND COMPUTER SERVICES

FOR MEDICAL RESEARCH; PROVIDING A WEB SITE FOR USE BY PHYSICIANS TO GENERATE, MANAGE AND EXCHANGE MEDICAL INFORMATION AND DOCUMENTS REGARDLESS OF MEDICAL ORGANIZATION OR GEOGRAPHIC LOCATION; PROVIDING MEDICAL AND SCIENTIFIC RESEARCH INFORMATION IN THE FIELD OF PHARMACEUTICALS AND CLINICAL TRIALS (U.S. CLS. 100 AND 101).
JACLYN KIDWELL, EXAMINING ATTORNEY

SN 77-563,342. NASH, TERIUS, ATLANTA, GA. FILED 9-5-2008.

MILLIONAIRE LOVE AFFAIR

THE MARK CONSISTS OF STANDARD CHARACTERS WITHOUT CLAIM TO ANY PARTICULAR FONT, STYLE, SIZE, OR COLOR.

CLASS 9—ELECTRICAL AND SCIENTIFIC APPARATUS

FOR SOUND RECORDINGS CONTAINING MUSIC (U.S. CLS. 21, 23, 26, 36 AND 38).

CLASS 25—CLOTHING

FOR CLOTHING, NAMELY, ANORAKS, ATHLETIC JERSEYS, BELTS, BLAZERS, BLOUSES, BOXER SHORTS, BRIEFS, CAMISOLES, COATS, DRESSES, EAR MUFFS, FOOTWEAR, GLOVES, HOSIERY, JACKETS, JEANS, JERSEYS, JOGGING SUITS, LEGGINGS, LINGERIE, MITTENS, NIGHTGOWNS, OVERALLS, PAJAMAS, PANTIES, PANTS, PARKAS, PONCHOS, RAINWEAR, ROBES, SCARVES, SHAWLS, SHIRTS, SHORTS, SHOES, SKIRTS, SKI SUITS, SLEEPWEAR, SLIPS, SOCKS, SUITS, SLACKS, SUSPENDERS, SWEAT BANDS, SWEAT PANTS, SWEATSHIRTS, SWEATERS, SWIMWEAR, TIES, TOPS, TROUSERS, TURTLENECKS, TUXEDOS, UNDERPANTS, UNDERSHIRTS, UNDERWEAR, VESTS, VISORS, WARM UP SUITS, WRIST BANDS (U.S. CLS. 22 AND 39).

CLASS 41—EDUCATION AND ENTERTAINMENT

FOR ENTERTAINMENT SERVICES IN THE NATURE OF LIVE MUSICAL PERFORMANCES (U.S. CLS. 100, 101 AND 107).
CYNTHIA SLOAN, EXAMINING ATTORNEY

SN 77-563,406. PROTIVITI INC., MENLO PARK, CA. FILED 9-5-2008.

POWERFUL INSIGHTS. PROVEN DELIVERY.

THE MARK CONSISTS OF STANDARD CHARACTERS WITHOUT CLAIM TO ANY PARTICULAR FONT, STYLE, SIZE, OR COLOR.

CLASS 35—ADVERTISING AND BUSINESS

FOR BUSINESS CONSULTATION SERVICES IN THE FIELDS OF BUSINESS OPERATIONS AND MANAGEMENT, INFORMATION TECHNOLOGY, OUTSOURCING, FINANCIAL MANAGEMENT AND INTERNAL AUDITING (U.S. CLS. 100, 101 AND 102).

CLASS 36—INSURANCE AND FINANCIAL

FOR FINANCIAL ANALYSIS AND CONSULTATION IN ASSESSING OPERATIONAL, INDUSTRY, REGULATORY FINANCIAL AND COMMODITY RISKS (U.S. CLS. 100, 101 AND 102).

CLASS 42—SCIENTIFIC AND COMPUTER SERVICES

FOR COMPUTER CONSULTATION SERVICES IN THE FIELDS OF ASSESSING TECHNOLOGY RISKS AND COMPUTER SYSTEMS AND NETWORK INTEGRATION (U.S. CLS. 100 AND 101).
EMILY CARLSEN, EXAMINING ATTORNEY

SN 77-563,452. MDG DEVELOPMENT GROUP LLC, BASKING RIDGE, NJ. FILED 9-5-2008.



NO CLAIM IS MADE TO THE EXCLUSIVE RIGHT TO USE "HEALTHCARE COMMUNICATIONS, INC.", APART FROM THE MARK AS SHOWN.

CLASS 35—ADVERTISING AND BUSINESS

FOR BUSINESS CONSULTATION IN THE FIELD OF MEDICINE; BUSINESS MANAGEMENT AND CONSULTATION IN THE FIELD OF MEDICINE; COMMERCIAL INFORMATION AGENCIES (U.S. CLS. 100, 101 AND 102).

CLASS 41—EDUCATION AND ENTERTAINMENT

FOR DEVELOPMENT AND DISSEMINATION OF EDUCATIONAL MATERIALS OF OTHERS IN THE FIELD OF MEDICINE; EDUCATIONAL SERVICES, NAMELY, DEVELOPING CURRICULUM FOR OTHERS IN THE FIELD OF MEDICINE; EDUCATIONAL SERVICES, NAMELY, PROVIDING CONTINUING PROFESSIONAL EDUCATION COURSES IN THE FIELD OF MEDICINE; ELECTRONIC PUBLISHING SERVICES, NAMELY, PUBLICATION OF TEXT AND GRAPHIC WORKS OF OTHERS ON CD, DVD, ON-LINE FEATURING MEDICINE, MEDICAL RESEARCH AND DEVELOPMENT, MEDICAL EDUCATION, CLINICAL MEDICAL RESEARCH, MEDICAL BUSINESS MANAGEMENT, MEDICAL BUSINESS MARKETING; MEDICAL TRAINING AND TEACHING; PROVIDING CONTINUING MEDICAL EDUCATION COURSES; PROVIDING ON-LINE TRAINING IN THE FORM OF COURSES, SEMINARS, AND WORKSHOPS IN THE FIELD OF MEDICINE; PUBLICATION OF TEXTS, BOOKS, MAGAZINES AND OTHER PRINTED MATTER; PUBLISHING AND ISSUING SCIENTIFIC PAPERS IN RELATION TO MEDICAL TECHNOLOGY; PUBLISHING OF JOURNALS, BOOKS AND HANDBOOKS IN THE FIELD OF MEDICINE (U.S. CLS. 100, 101 AND 107).

CLASS 42—SCIENTIFIC AND COMPUTER SERVICES

FOR MEDICAL RESEARCH; PROVIDING A WEB SITE FOR USE BY PHYSICIANS TO GENERATE, MANAGE AND EXCHANGE MEDICAL INFORMATION AND DOCUMENTS REGARDLESS OF MEDICAL ORGANIZATION OR GEOGRAPHIC LOCATION; PROVIDING MEDICAL AND SCIENTIFIC RESEARCH INFORMATION IN THE FIELD OF PHARMACEUTICALS AND CLINICAL TRIALS (U.S. CLS. 100 AND 101).
JACLYN KIDWELL, EXAMINING ATTORNEY

SN 77-563,504. MARS, INCORPORATED, MCLEAN, VA. FILED 9-5-2008.

THE FUN WAY TO PUMP UP YOUR DAY

THE MARK CONSISTS OF STANDARD CHARACTERS WITHOUT CLAIM TO ANY PARTICULAR FONT, STYLE, SIZE, OR COLOR.

CLASS 5—PHARMACEUTICALS

FOR NUTRITIONAL ENERGY BARS FOR USE AS A MEAL SUBSTITUTE (U.S. CLS. 6, 18, 44, 46, 51 AND 52).

CLASS 29—MEATS AND PROCESSED FOODS

FOR SOY-BASED SNACK FOODS; PROTEIN-BASED NUTRIENT DENSE SNACK BARS; FRUIT-BASED SNACK FOODS; FRUIT-BASED SNACK BARS; PROCESSED NUTS, PROCESSED FRUIT AND NUT-BASED FOOD BARS, FRUIT-BASED ORGANIC FOODS BARS ALSO CONTAINING FRUITS, DRIED FRUITS, FRUIT JUICE, GRAIN, VEGETABLES, NUTS, SEEDS, CHOCOLATE; CANDIED NUTS, ROASTED NUTS, SOY-BASED FOOD BARS ALSO CONTAINING GRAIN, DRIED FRUITS, CHOCOLATE, NUTS; SNACK MIX CONSISTING PRIMARILY OF PROCESSED FRUITS, PROCESSED NUTS AND/OR RAISINS; DAIRY-BASED BEVERAGES, YOGURT-BASED BEVERAGES, DEHYDRATED FRUIT SNACKS AND DEHYDRATED VEGETABLE SNACKS; AND POTATO-BASED SNACK FOODS (U.S. CL. 46).

CLASS 30—STAPLE FOODS

FOR CONFECTIONERY PRODUCTS, NAMELY, CANDY AND CHOCOLATE; CORN-BASED SNACK FOODS; WHEAT-BASED SNACK FOODS, RICE-BASED SNACK FOODS; GRANOLA BASED SNACK FOODS; GRANOLA BARS; COOKIES, PRETZELS, CAKES, BROWNIES, PIES AND TARTS; CHOCOLATE COVERED NUTS; SNACK MIX CONSISTING PRIMARILY OF CRACKERS, PRETZELS, CANDIED NUTS; GRAIN-BASED FOOD BARS ALSO CONTAINING SOY, DRIED FRUITS, CHOCOLATE AND NUTS; SNACK FOODS, NAMELY, GRANOLA-BASED SNACK BARS, RICE-BASED SNACK BARS, WHEAT-BASED SNACK BARS, CRACKERS, BROWNIE BARS (U.S. CL. 46).

CLASS 31—NATURAL AGRICULTURAL PRODUCTS

FOR FRESH FRUITS, VEGETABLES AND UNPROCESSED GRAINS (U.S. CLS. 1 AND 46).

CLASS 32—LIGHT BEVERAGES

FOR NONALCOHOLIC BEVERAGES, NAMELY, FRUIT DRINKS, FRUIT FLAVORED DRINKS, FRUIT JUICES, WATER, FLAVORED WATER DRINKS AND SPORTS DRINKS (U.S. CLS. 45, 46 AND 48).
VERNA BETH RIRIE, EXAMINING ATTORNEY

SN 77-563,548. GERMANTOWN TELEPHONE CO., INC., DBA GTEL, GERMANTOWN, NY. FILED 9-5-2008.

GTEL

THE MARK CONSISTS OF STANDARD CHARACTERS WITHOUT CLAIM TO ANY PARTICULAR FONT, STYLE, SIZE, OR COLOR.

CLASS 16—PAPER GOODS AND PRINTED MATTER

FOR NEWSLETTERS IN THE FIELD OF TELECOMMUNICATIONS AND INTERNET USAGE AS WELL AS GENERAL TECHNICAL SUPPORT AND ADVICE FOR TELECOMMUNICATIONS CUSTOMERS; TELEPHONE DIRECTORIES (U.S. CLS. 2, 5, 22, 23, 29, 37, 38 AND 50).
FIRST USE 10-1-2007; IN COMMERCE 10-1-2007.

CLASS 35—ADVERTISING AND BUSINESS

FOR ARRANGING SUBSCRIPTIONS TO TELECOMMUNICATION SERVICES; MANAGING TELECOMMUNICATIONS NETWORKS FOR OTHERS, NAMELY, MANAGING TELEPHONE SERVICE FOR OTHER CARRIERS; OPERATION AND ADMINISTRATION OF TELECOMMUNICATION SYSTEMS AND NETWORKS FOR OTHERS; RESELLER SERVICES, NAMELY, DISTRIBUTORSHIP SERVICES IN THE FIELD OF CABLE AND DSL TELEVISION AND INTERNET ENTERTAINMENT PRODUCTS AND SERVICES (U.S. CLS. 100, 101 AND 102).

FIRST USE 10-1-2007; IN COMMERCE 10-1-2007.

CLASS 36—INSURANCE AND FINANCIAL

FOR PREPAID TELECOMMUNICATIONS CALLING CARD SERVICES; TELECOMMUNICATIONS RESELLER SERVICES, NAMELY, TELECOMMUNICATIONS AIR TIME BROKERAGE SERVICES (U.S. CLS. 100, 101 AND 102).

FIRST USE 10-1-2007; IN COMMERCE 10-1-2007.

CLASS 37—CONSTRUCTION AND REPAIR

FOR INSTALLATION, MAINTENANCE AND REPAIR OF TELECOMMUNICATIONS SYSTEMS; MAINTENANCE AND REPAIR OF TELECOMMUNICATIONS NETWORKS, APPARATUS, AND INSTRUMENTS (U.S. CLS. 100, 103 AND 106).

FIRST USE 10-1-2007; IN COMMERCE 10-1-2007.

CLASS 38—COMMUNICATION

FOR LOCAL AND LONG DISTANCE TELEPHONE SERVICES; TELECOMMUNICATION SERVICES, NAMELY, LOCAL AND LONG DISTANCE TRANSMISSION OF VOICE, DATA, GRAPHICS AND VIDEO BY MEANS OF BROADBAND OPTICAL OR WIRELESS NETWORKS; TELECOMMUNICATIONS RESELLER SERVICES, NAMELY, PROVIDING LONG DISTANCE TELECOMMUNICATION SERVICES (U.S. CLS. 100, 101 AND 104).

FIRST USE 10-1-2007; IN COMMERCE 10-1-2007.

AARON BRODSKY, EXAMINING ATTORNEY

SN 77-563,602. THE READING FOUNDATION, DBA NATIONAL CHILDREN'S READING FOUNDATION, KENNEWICK, WA. FILED 9-5-2008.



THE MARK CONSISTS OF A STICK FORM HUMAN ADULT READING A BOOK TO A STICK FORM HUMAN CHILD.

CLASS 16—PAPER GOODS AND PRINTED MATTER

FOR PRINTED EDUCATIONAL PUBLICATIONS, NAMELY, BOOKS, BOOKLETS, MANUALS, PAMPHLETS, BROCHURES AND ARTICLES RELATING TO READING, READING PROFICIENCY, AND TECHNIQUES FOR TEACHING READING TO CHILDREN (U.S. CLS. 2, 5, 22, 23, 29, 37, 38 AND 50).

CLASS 41—EDUCATION AND ENTERTAINMENT

FOR PROVIDING INFORMATION IN THE FIELDS OF READING, READING PROFICIENCY, AND TECHNIQUES FOR TEACHING READING TO CHILDREN (U.S. CLS. 100, 101 AND 107).

KIM SAITO, EXAMINING ATTORNEY

SN 77-563,667. LEFTCHANNEL, INC., COLUMBUS, OH. FILED 9-5-2008.

LEFTCHANNEL

THE MARK CONSISTS OF STANDARD CHARACTERS WITHOUT CLAIM TO ANY PARTICULAR FONT, STYLE, SIZE, OR COLOR.

CLASS 41—EDUCATION AND ENTERTAINMENT

FOR PRODUCTION OF VIDEO AND CREATION OF VISUAL EFFECTS FOR OTHERS FOR USE IN DVDS, TELEVISION PROGRAMS AND ON WEB SITES (U.S. CLS. 100, 101 AND 107).

FIRST USE 8-1-2002; IN COMMERCE 8-1-2002.

CLASS 42—SCIENTIFIC AND COMPUTER SERVICES

FOR GRAPHIC DESIGN SERVICES (U.S. CLS. 100 AND 101).

FIRST USE 8-1-2002; IN COMMERCE 8-1-2002.
SIMON TENG, EXAMINING ATTORNEY

SN 77-563,705. MIDWEST ENERGY, INC., HAYS, KS. FILED 9-5-2008.

How\$mart

THE MARK CONSISTS OF STANDARD CHARACTERS WITHOUT CLAIM TO ANY PARTICULAR FONT, STYLE, SIZE, OR COLOR.

CLASS 35—ADVERTISING AND BUSINESS

FOR ENERGY AUDITING (U.S. CLS. 100, 101 AND 102).

FIRST USE 2-27-2007; IN COMMERCE 2-27-2007.

CLASS 36—INSURANCE AND FINANCIAL

FOR FINANCIAL SERVICES, NAMELY, MONEY LENDING (U.S. CLS. 100, 101 AND 102).

FIRST USE 2-27-2007; IN COMMERCE 2-27-2007.
JOHN DWYER, EXAMINING ATTORNEY

SN 77-563,934. RIVERS-JAMES, LATEEFAH JAMALA, DBA THE AQUILA AND PRISCILLA GROUP, MONTGOMERY, AL. FILED 9-6-2008.

Aquila and Priscilla

THE MARK CONSISTS OF STANDARD CHARACTERS WITHOUT CLAIM TO ANY PARTICULAR FONT, STYLE, SIZE, OR COLOR.

THE NAMES "AQUILA" AND "PRISCILLA" DO NOT IDENTIFY ANY LIVING INDIVIDUALS.

THE ENGLISH TRANSLATION OF "AQUILA" IN THE MARK IS EAGLE.

CLASS 16—PAPER GOODS AND PRINTED MATTER

FOR HOTEL DIRECTORIES (U.S. CLS. 2, 5, 22, 23, 29, 37, 38 AND 50).

CLASS 35—ADVERTISING AND BUSINESS

FOR ADMINISTRATIVE HOTEL MANAGEMENT; ASSOCIATION SERVICES, NAMELY, PROMOTING DIVERSITY IN THE RESTAURANT AND HOTEL INDUSTRIES ON BEHALF OF EMPLOYEES, VENDORS, MANAGEMENT, AND OWNERS; BUSINESS MANAGEMENT OF HOTELS FOR OTHERS; HOTEL MANAGEMENT FOR OTHERS; MANAGEMENT OF HOTEL INCENTIVE PROGRAMS OF OTHERS; MANAGING AND OPERATING RESORT HOTELS AND BUSINESS CONFERENCE CENTERS OF OTHERS; PROVIDING HOTEL RATE COMPARISON INFORMATION (U.S. CLS. 100, 101 AND 102).

CLASS 42—SCIENTIFIC AND COMPUTER SERVICES

FOR HOSTING THE DIGITAL AUDIO AND VIDEO CONTENT OF OTHERS FOR THE PURPOSE OF ENABLING HOTEL, INN, AND OTHER LODGING ESTABLISHMENT GUESTS TO DOWNLOAD THE CONTENT ON A PAY PER VIEW BASIS; INTERIOR DESIGN SERVICES IN THE NATURE OF AROMA CONSULTING SERVICES IN THE SELECTION AND USE OF AROMAS FOR HOTELS, CASINOS, RESORTS, CONFERENCE FACILITIES, RETAIL STORES, SPORTS AND FITNESS CENTERS, SPAS, HEALTH CARE FACILITIES, RESIDENTIAL BUILDINGS AND PRIVATE RESIDENCES (U.S. CLS. 100 AND 101).

CLASS 43—HOTEL AND RESTAURANT SERVICES

FOR EXTENDED-STAY HOTELS; HOTEL AND RESTAURANT RESERVATION SERVICES; HOTEL SERVICES FOR PREFERRED CUSTOMERS; HOTEL, MOTEL, RESTAURANT, BAR AND CATERING SERVICES; MAKING HOTEL RESERVATIONS FOR OTHERS; PROVIDING ADVICE TO TOURISTS AND BUSINESS TRAVELERS ON HOTEL AND RESTAURANT DESTINATIONS; PROVIDING HOTEL ACCOMMODATION; PROVIDING ON-LINE REVIEWS OF RESTAURANTS AND HOTELS; PROVIDING PERSONALIZED INFORMATION ABOUT HOTELS AND TEMPORARY ACCOMMODATIONS FOR TRAVEL VIA THE INTERNET; PROVIDING TEMPORARY LODGING SERVICES IN THE NATURE OF A CONDOMINIUM HOTEL; RESERVATION OF HOTEL ROOMS FOR TRAVELERS; RESIDENTIAL HOTELS; RESORT HOTELS (U.S. CLS. 100 AND 101).

CLASS 45—PERSONAL AND LEGAL SERVICES

FOR HOTEL CONCIERGE SERVICES; PERSONAL CONCIERGE SERVICES FOR OTHERS COMPRISING MAKING REQUESTED PERSONAL ARRANGEMENTS AND RESERVATIONS, RUNNING ERRANDS AND PROVIDING CUSTOMER SPECIFIC INFORMATION TO MEET INDIVIDUAL NEEDS, ALL RENDERED IN BUSINESS ESTABLISHMENTS, OFFICE BUILDINGS, HOTELS, RESIDENTIAL COMPLEXES AND HOMES (U.S. CLS. 100 AND 101).

ANDREW RHIM, EXAMINING ATTORNEY

SN 77-563,959. ADRIAN E. MCCRAY, NEW BEDFORD, MA. FILED 9-6-2008.

gateways2paydays

SN 77-563,939. ENDGAME ENTERPRISES, WESTMINSTER, CO. FILED 9-6-2008.



THE MARK CONSISTS OF THE WORDS "LETTERS FROM US" IN STYLIZED FORM WITHIN A POSTAGE STAMP AND TWO DOGS.

CLASS 16—PAPER GOODS AND PRINTED MATTER

FOR STICKERS (U.S. CLS. 2, 5, 22, 23, 29, 37, 38 AND 50).

FIRST USE 8-20-2008; IN COMMERCE 8-20-2008.

CLASS 20—FURNITURE AND ARTICLES NOT OTHERWISE CLASSIFIED

FOR PLASTIC KEY CHAINS (U.S. CLS. 2, 13, 22, 25, 32 AND 50).

FIRST USE 8-20-2008; IN COMMERCE 8-20-2008.

CLASS 21—HOUSEWARES AND GLASS

FOR MUGS (U.S. CLS. 2, 13, 23, 29, 30, 33, 40 AND 50).

FIRST USE 8-20-2008; IN COMMERCE 8-20-2008.

CLASS 25—CLOTHING

FOR SHORT-SLEEVED OR LONG-SLEEVED T-SHIRTS; T-SHIRTS; TEE SHIRTS (U.S. CLS. 22 AND 39).

FIRST USE 8-20-2008; IN COMMERCE 8-20-2008.

CLASS 26—FANCY GOODS

FOR NOVELTY BUTTONS (U.S. CLS. 37, 39, 40, 42 AND 50).

FIRST USE 8-20-2008; IN COMMERCE 8-20-2008.

MEGHAN REINHART, EXAMINING ATTORNEY

THE MARK CONSISTS OF STANDARD CHARACTERS WITHOUT CLAIM TO ANY PARTICULAR FONT, STYLE, SIZE, OR COLOR.

CLASS 9—ELECTRICAL AND SCIENTIFIC APPARATUS

FOR DIGITAL MATERIALS, NAMELY, CDS, DVDS, BOOKS FEATURING PERSONAL DEVELOPMENT; DIGITAL MEDIA, NAMELY, CDS, DVD,S, BOOKS FEATURING PERSONAL DEVELOPMENT; ELECTRONIC PUBLICATIONS, NAMELY, CDS, DVDS, BOOKS FEATURING PERSONAL DEVELOPMENT RECORDED ON COMPUTER MEDIA; PRE-RECORDED CDS FEATURING PERSONAL DEVELOPMENT; PRE-RECORDED CDS, VIDEO TAPES, LASER DISKS AND DVDS FEATURING PERSONAL DEVELOPMENT (U.S. CLS. 21, 23, 26, 36 AND 38).

CLASS 41—EDUCATION AND ENTERTAINMENT

FOR CONDUCTING WORKSHOPS AND SEMINARS IN PERSONAL AWARENESS; CONDUCTING WORKSHOPS AND SEMINARS IN SELF AWARENESS; EDUCATION SERVICES, NAMELY, PROVIDING MENTORING, TUTORING, CLASSES, SEMINARS AND WORKSHOPS IN THE FIELD OF PERSONAL DEVELOPMENT; EDUCATIONAL SERVICES, NAMELY, CONDUCTING SEMINARS, LECTURES, TELESEMINARS, TELECLASSES, AND WORKSHOPS IN PERSONAL AWARENESS (U.S. CLS. 100, 101 AND 107).

THOMAS MANOR, EXAMINING ATTORNEY

SN 77-564,013. LOYALTY LEADER INC., MILWAUKEE, WI. FILED 9-6-2008.

Service With a Smile

THE MARK CONSISTS OF STANDARD CHARACTERS WITHOUT CLAIM TO ANY PARTICULAR FONT, STYLE, SIZE, OR COLOR.

CLASS 9—ELECTRICAL AND SCIENTIFIC APPARATUS

FOR DIGITAL MATERIALS, NAMELY, CDS, DVDS, DOWNLOADABLE AUDIO FILES FEATURING CUSTOMER SERVICE, CUSTOMER LOYALTY, MANAGEMENT TRAINING; DIGITAL MEDIA, NAMELY, PRE-RECORDED VIDEO CASSETTES, DIGITAL VIDEO DISCS, DIGITAL VERSATILE DISCS, DOWNLOADABLE AUDIO AND VIDEO RECORDINGS, DVDS, AND HIGH DEFINITION DIGITAL DISKS FEATURING CUSTOMER SERVICE, CUSTOMER LOYALTY AND MANAGEMENT TRAINING; DVD SLEEVES; MULTIMEDIA SOFTWARE RECORDED ON CD-ROM FEATURING CUSTOMERS SERVICE AND MANAGEMENT TRAINING; PRE-RECORDED CDS FEATURING CUSTOMER SERVICE, CUSTOMER LOYALTY, MANAGEMENT TRAINING; PRE-RECORDED CDS, VIDEO TAPES, LASER DISKS AND DVDS FEATURING CUSTOMER SERVICE, CUSTOMER LOYALTY, MANAGEMENT TRAINING (U.S. CLS. 21, 23, 26, 36 AND 38).

CLASS 16—PAPER GOODS AND PRINTED MATTER

FOR A SERIES OF BOOKS, WRITTEN ARTICLES, HANDOUTS AND WORKSHEETS IN THE FIELD OF CUSTOMER SERVICE AND MANAGEMENT; PRINTED SEMINAR NOTES (U.S. CLS. 2, 5, 22, 23, 29, 37, 38 AND 50).

CLASS 41—EDUCATION AND ENTERTAINMENT

FOR EDUCATIONAL SERVICES, NAMELY, CONDUCTING CLASSES, SEMINARS, CONFERENCES, WORKSHOPS AND TELESEMINARS IN THE FIELD OF CUSTOMER SERVICE AND MANAGEMENT (U.S. CLS. 100, 101 AND 107).
ANGELA M. MICHELL, EXAMINING ATTORNEY

SN 77-564,043. HUMANEYES TECHNOLOGIES LTD., JERUSALEM, ISRAEL, FILED 9-7-2008.

SNAPILY

THE MARK CONSISTS OF STANDARD CHARACTERS WITHOUT CLAIM TO ANY PARTICULAR FONT, STYLE, SIZE, OR COLOR.

CLASS 9—ELECTRICAL AND SCIENTIFIC APPARATUS

FOR COMPUTER PROGRAMS FOR EDITING IMAGES, SOUND AND VIDEO; COMPUTER SOFTWARE FOR ORGANIZING AND VIEWING DIGITAL IMAGES AND PHOTOGRAPHS; COMPUTER SOFTWARE FOR USE IN RELATION TO DIGITAL ANIMATION AND SPECIAL EFFECTS OF IMAGES; SOFTWARE FOR PROCESSING IMAGES, GRAPHICS AND TEXT (U.S. CLS. 21, 23, 26, 36 AND 38).
FIRST USE 9-4-2008; IN COMMERCE 9-4-2008.

CLASS 35—ADVERTISING AND BUSINESS

FOR ON-LINE ORDERING SERVICES FEATURING PRINTING OF IMAGES; ON-LINE ORDERING SERVICES FEATURING CREATION OF DIGITAL IMAGES (U.S. CLS. 100, 101 AND 102).
FIRST USE 9-4-2008; IN COMMERCE 9-4-2008.

CLASS 40—MATERIAL TREATMENT

FOR PHOTOGRAPHIC COMPUTER IMAGING; PRINTING OF PHOTOGRAPHIC IMAGES FROM DIGITAL MEDIA (U.S. CLS. 100, 103 AND 106).
FIRST USE 9-4-2008; IN COMMERCE 9-4-2008.

CLASS 42—SCIENTIFIC AND COMPUTER SERVICES

FOR PROVIDING A WEBSITE FEATURING ON-LINE NON-DOWNLOADABLE SOFTWARE TOOLS FOR IMAGE EDITING (U.S. CLS. 100 AND 101).
FIRST USE 9-4-2008; IN COMMERCE 9-4-2008.
CAROLYN GRAY, EXAMINING ATTORNEY

SN 77-564,061. WEB DEVENTIONS, LLC, MONROVIA, CA. FILED 9-7-2008.

TwoCan

THE MARK CONSISTS OF STANDARD CHARACTERS WITHOUT CLAIM TO ANY PARTICULAR FONT, STYLE, SIZE, OR COLOR.

CLASS 9—ELECTRICAL AND SCIENTIFIC APPARATUS

FOR COMMUNICATION SOFTWARE FOR PROVIDING ACCESS TO THE INTERNET; COMPUTER PROGRAMS FOR USING THE INTERNET AND THE WORLD WIDE WEB (U.S. CLS. 21, 23, 26, 36 AND 38).

CLASS 41—EDUCATION AND ENTERTAINMENT

FOR ENTERTAINMENT SERVICES, NAMELY, CONDUCTING PARTIES FOR THE PURPOSE OF DATING AND SOCIAL INTRODUCTION FOR ADULTS (U.S. CLS. 100, 101 AND 107).
GIANCARLO CASTRO, EXAMINING ATTORNEY

SN 77-564,063. WEB DEVENTIONS, LLC, MONROVIA, CA. FILED 9-7-2008.

twocan.com

THE MARK CONSISTS OF STANDARD CHARACTERS WITHOUT CLAIM TO ANY PARTICULAR FONT, STYLE, SIZE, OR COLOR.

CLASS 9—ELECTRICAL AND SCIENTIFIC APPARATUS

FOR COMMUNICATION SOFTWARE FOR PROVIDING ACCESS TO THE INTERNET; COMPUTER PROGRAMS FOR USING THE INTERNET AND THE WORLD WIDE WEB (U.S. CLS. 21, 23, 26, 36 AND 38).

CLASS 41—EDUCATION AND ENTERTAINMENT

FOR ENTERTAINMENT SERVICES, NAMELY, CONDUCTING PARTIES FOR THE PURPOSE OF DATING AND SOCIAL INTRODUCTION FOR ADULTS (U.S. CLS. 100, 101 AND 107).

GIANCARLO CASTRO, EXAMINING ATTORNEY

CLASS 45—PERSONAL AND LEGAL SERVICES

FOR INTERNET BASED SOCIAL NETWORKING, INTRODUCTION, AND DATING SERVICES (U.S. CLS. 100 AND 101).

SKYE YOUNG, EXAMINING ATTORNEY

SN 77-564,077. WINTER, SUSAN P., SANTA FE, NM. FILED 9-7-2008.

SN 77-564,152. SEARCH CAPITAL LTD, HONG KONG, HONG KONG, FILED 9-8-2008.

FLORA LUMINA

THE MARK CONSISTS OF STANDARD CHARACTERS WITHOUT CLAIM TO ANY PARTICULAR FONT, STYLE, SIZE, OR COLOR.

CLASS 5—PHARMACEUTICALS

FOR DIETARY SUPPLEMENTS; DIETARY SUPPLEMENTS FOR ANIMALS; DIETARY SUPPLEMENTS FOR HUMAN CONSUMPTION; DIETARY SUPPLEMENTS FOR PETS; HERBAL MUD PACKS FOR THERAPEUTIC PURPOSES; HERBAL SUPPLEMENTS; HERBAL TEAS FOR MEDICINAL PURPOSES; HERBAL TOPICAL CREAMS, GELS, SALVES, SPRAYS, POWDER, BALMS, LINIMENT AND OINTMENTS FOR THE RELIEF OF ACHES AND PAIN (U.S. CLS. 6, 18, 44, 46, 51 AND 52).

CLASS 44—MEDICAL, BEAUTY AND AGRICULTURAL SERVICES

FOR COUNSELING SERVICES IN THE FIELDS OF HEALTH, HERBALISM, AND LIFESTYLE WELLNESS (U.S. CLS. 100 AND 101).

KARANENDRA S. CHHINA, EXAMINING ATTORNEY

SN 77-564,098. ALTOCA LIMITED, LONDON, UNITED KINGDOM, FILED 9-7-2008.

ARTAcadabra

THE MARK CONSISTS OF STANDARD CHARACTERS WITHOUT CLAIM TO ANY PARTICULAR FONT, STYLE, SIZE, OR COLOR.

CLASS 42—SCIENTIFIC AND COMPUTER SERVICES

FOR PROVIDING A WEB SITE FEATURING TECHNOLOGY THAT ENABLES INTERNET USERS TO CREATE, BOOKMARK, ANNOTATE, AND PUBLICLY SHARE DATA; PROVIDING SPECIFIC INFORMATION AS REQUESTED BY CUSTOMERS VIA THE INTERNET (U.S. CLS. 100 AND 101).

get.MD

THE MARK CONSISTS OF STANDARD CHARACTERS WITHOUT CLAIM TO ANY PARTICULAR FONT, STYLE, SIZE, OR COLOR.

CLASS 9—ELECTRICAL AND SCIENTIFIC APPARATUS

FOR DOWNLOADABLE SCIENTIFIC AND MEDICAL DATA VIA THE INTERNET (U.S. CLS. 21, 23, 26, 36 AND 38).

FIRST USE 4-1-2006; IN COMMERCE 4-1-2006.

CLASS 35—ADVERTISING AND BUSINESS

FOR ADVERTISING AND COMMERCIAL INFORMATION SERVICES, VIA THE INTERNET (U.S. CLS. 100, 101 AND 102).

FIRST USE 4-1-2006; IN COMMERCE 4-1-2006.

CLASS 44—MEDICAL, BEAUTY AND AGRICULTURAL SERVICES

FOR PROVIDING HEALTH CARE INFORMATION BY TELEPHONE AND THE INTERNET (U.S. CLS. 100 AND 101).

FIRST USE 4-1-2006; IN COMMERCE 4-1-2006.

SUNG IN, EXAMINING ATTORNEY

SN 77-564,196. CYANIDE, NANTERRE, FRANCE, FILED 9-8-2008.

Front Page Sports

THE MARK CONSISTS OF STANDARD CHARACTERS WITHOUT CLAIM TO ANY PARTICULAR FONT, STYLE, SIZE, OR COLOR.

NO CLAIM IS MADE TO THE EXCLUSIVE RIGHT TO USE "SPORTS", APART FROM THE MARK AS SHOWN.

CLASS 9—ELECTRICAL AND SCIENTIFIC APPARATUS

FOR VIDEO AND COMPUTER GAME PROGRAMS (U.S. CLS. 21, 23, 26, 36 AND 38).

CLASS 28—TOYS AND SPORTING GOODS

FOR HAND-HELD GAMES WITH LIQUID CRYSTAL DISPLAYS (U.S. CLS. 22, 23, 38 AND 50).

CLASS 41—EDUCATION AND ENTERTAINMENT

FOR ENTERTAINMENT SERVICES, NAMELY, PROVIDING ON-LINE COMPUTER GAMES (U.S. CLS. 100, 101 AND 107).
 JACQUELINE A. LAVINE, EXAMINING ATTORNEY

CLASS 25—CLOTHING

FOR CLOTHING, NAMELY, SHORT SLEEVE AND LONG SLEEVE T-SHIRTS, HATS, VISORS, JACKETS AND SWEATSHIRTS (U.S. CLS. 22 AND 39).

CLASS 39—TRANSPORTATION AND STORAGE

FOR YACHT CHARTERING; ARRANGING EXCURSIONS AND TOURS ON SAILBOATS AND YACHTS (U.S. CLS. 100 AND 105).
 ROBIN CHOSID, EXAMINING ATTORNEY

SN 77-564,210. OXFORD DIAGNOSTICS LIMITED, OXFORD, UNITED KINGDOM, FILED 9-8-2008.

SN 77-564,282. ESPN, INC., BRISTOL, CT. FILED 9-8-2008.

Cognito Mode

THE MARK CONSISTS OF STANDARD CHARACTERS WITHOUT CLAIM TO ANY PARTICULAR FONT, STYLE, SIZE, OR COLOR.



CLASS 9—ELECTRICAL AND SCIENTIFIC APPARATUS

FOR COMPUTER APPLICATION SOFTWARE FOR MOBILE PHONES; COMPUTER SOFTWARE FOR ADMINISTRATION OF COMPUTER NETWORKS; COMPUTER SOFTWARE FOR CAPTURING, MONITORING AND REGULATING COMPUTER USAGE AND INTERNET ACCESS (U.S. CLS. 21, 23, 26, 36 AND 38).

OWNER OF U.S. REG. NOS. 1,345,096, 2,393,477 AND OTHERS.

THE MARK CONSISTS OF THE STYLIZED "ESPN" LOGO MARK SET ABOVE THE WORD "CLASSIC", WITHIN THE FIRST LETTER OF WHICH IS THE UPPER BODY OF A HUMAN WITH HANDS EXTENDED UPWARDS.
 SEC. 2(F) AS TO "CLASSIC".

CLASS 35—ADVERTISING AND BUSINESS

FOR SUBSCRIPTION TO A TELEMATICS, TELEPHONE OR COMPUTER SERVICE (U.S. CLS. 100, 101 AND 102).
 KELLEY WELLS, EXAMINING ATTORNEY

CLASS 38—COMMUNICATION

FOR TELEVISION BROADCASTING, CABLE TELEVISION BROADCASTING, AND CABLE TELEVISION TRANSMISSION (U.S. CLS. 100, 101 AND 104).
 FIRST USE 12-22-1998; IN COMMERCE 12-22-1998.

SN 77-564,230. ROSEBUD RACING, INC., FORT LAUDERDALE, FL. FILED 9-8-2008.

CLASS 41—EDUCATION AND ENTERTAINMENT

FOR TELEVISION PROGRAMMING, CABLE TELEVISION PROGRAMMING, PRODUCTION OF TELEVISION PROGRAMS AND CABLE TELEVISION PROGRAMS, DISTRIBUTION OF TELEVISION AND CABLE TELEVISION PROGRAMS FOR OTHERS, DISTRIBUTION OF TELEVISION PROGRAMMING TO CABLE SYSTEMS (U.S. CLS. 100, 101 AND 107).
 FIRST USE 12-22-1998; IN COMMERCE 12-22-1998.
 LANA PHAM, EXAMINING ATTORNEY



THE COLOR(S) RED, DARK PINK, LIGHT GREEN, AND DARK GREEN IS/ARE CLAIMED AS A FEATURE OF THE MARK.
 THE MARK CONSISTS OF A ROSE WITH RED AND DARK PINK PETALS, A DARK GREEN STEM AND LIGHT AND DARK GREEN LEAVES.

SN 77-564,285. FENTON, MICAH A., AUSTIN, TX. FILED 9-8-2008.

DON'T DALLAS MY AUSTIN.

THE MARK CONSISTS OF STANDARD CHARACTERS WITHOUT CLAIM TO ANY PARTICULAR FONT, STYLE, SIZE, OR COLOR.

CLASS 16—PAPER GOODS AND PRINTED MATTER

FOR BUMPER STICKERS; DECORATIVE STICKERS FOR HELMETS; STICKERS; STICKERS AND DECAL-COMANIAS; STICKERS AND TRANSFERS (U.S. CLS. 2, 5, 22, 23, 29, 37, 38 AND 50).

SN 77-564,405. HELEN OF TROY LIMITED, ST. MICHAEL, BARBADOS, FILED 9-8-2008.

CLASS 25—CLOTHING

FOR ATHLETIC APPAREL, NAMELY, SHIRTS, PANTS, JACKETS, FOOTWEAR, HATS AND CAPS, ATHLETIC UNIFORMS; DRESS SHIRTS; GOLF SHIRTS; HOODED SWEAT SHIRTS; KNIT SHIRTS; LONG-SLEEVED SHIRTS; MOISTURE-WICKING SPORTS SHIRTS; NIGHT SHIRTS; OPEN-NECKED SHIRTS; PIQUE SHIRTS; POLO SHIRTS; RUGBY SHIRTS; SCIENTIFIC AND TECHNOLOGICAL APPAREL, NAMELY, SHIRTS, PANTS, JACKETS, FOOTWEAR, HATS AND CAPS, UNIFORMS; SHIRT FRONTS; SHIRT YOKES; SHIRTS; SHIRTS FOR SUITS; SHORT-SLEEVED OR LONG-SLEEVED T-SHIRTS; SHORT-SLEEVED SHIRTS; SLEEP SHIRTS; SPORT SHIRTS; SPORTS SHIRTS; SPORTS SHIRTS WITH SHORT SLEEVES; SWEAT SHIRTS; T-SHIRTS; TEE SHIRTS; TRIATHLON CLOTHING, NAMELY, TRIATHLON TIGHTS, TRIATHLON SHORTS, TRIATHLON SINGLETS, TRIATHLON SHIRTS, TRIATHLON SUITS; WEARABLE GARMENTS AND CLOTHING, NAMELY, SHIRTS; WIND SHIRTS; YOGA SHIRTS (U.S. CLS. 22 AND 39).

Color Shield

THE MARK CONSISTS OF STANDARD CHARACTERS WITHOUT CLAIM TO ANY PARTICULAR FONT, STYLE, SIZE, OR COLOR.

CLASS 9—ELECTRICAL AND SCIENTIFIC APPARATUS

FOR ELECTRIC HAIR CURLING IRONS; ELECTRIC HAND-HELD HAIR STYLING IRONS (U.S. CLS. 21, 23, 26, 36 AND 38).

CLASS 40—MATERIAL TREATMENT

FOR IMPRINTING MESSAGES ON T-SHIRTS; IMPRINTING MESSAGES ON WEARING APPAREL, ACCESSORIES AND MUGS; T-SHIRT EMBROIDERING SERVICES (U.S. CLS. 100, 103 AND 106).

RUSS HERMAN, EXAMINING ATTORNEY

CLASS 11—ENVIRONMENTAL CONTROL APPARATUS

FOR HAND-HELD ELECTRIC HAIR DRYERS (U.S. CLS. 13, 21, 23, 31 AND 34).

CHERYL CLAYTON, EXAMINING ATTORNEY

SN 77-564,305. MANUFACTURERS EQUIPMENT & SUPPLY CO., FLINT, MI. FILED 9-8-2008.

SN 77-564,420. 2D PRODUCTIONS, LLC, DENVER, CO. FILED 9-8-2008.

MESCOPAK

THE MARK CONSISTS OF STANDARD CHARACTERS WITHOUT CLAIM TO ANY PARTICULAR FONT, STYLE, SIZE, OR COLOR.

CLASS 35—ADVERTISING AND BUSINESS

FOR DISTRIBUTORSHIP SERVICES IN THE FIELD OF INDUSTRIAL SUPPLIES (U.S. CLS. 100, 101 AND 102).

FIRST USE 6-24-2008; IN COMMERCE 8-1-2008.

CLASS 39—TRANSPORTATION AND STORAGE

FOR SUPPLY CHAIN, LOGISTICS AND REVERSE LOGISTICS SERVICES, NAMELY, STORAGE, SEQUENCING, PACKAGING, TRANSPORTATION AND DELIVERY OF INDUSTRIAL SUPPLIES FOR BUILDERS OF CUSTOM TOOLING AND SPECIALIZED MACHINERY (U.S. CLS. 100 AND 105).

FIRST USE 6-24-2008; IN COMMERCE 8-1-2008.

CAROLYN CATALDO, EXAMINING ATTORNEY

Field Day

THE MARK CONSISTS OF STANDARD CHARACTERS WITHOUT CLAIM TO ANY PARTICULAR FONT, STYLE, SIZE, OR COLOR.

CLASS 35—ADVERTISING AND BUSINESS

FOR REAL ESTATE ADVERTISING SERVICES (U.S. CLS. 100, 101 AND 102).

FIRST USE 7-20-2008; IN COMMERCE 7-20-2008.

CLASS 41—EDUCATION AND ENTERTAINMENT

FOR ENTERTAINMENT SERVICES, NAMELY, PERSONAL APPEARANCES BY A CELEBRITY (U.S. CLS. 100, 101 AND 107).

FIRST USE 7-20-2008; IN COMMERCE 7-20-2008.

CHERYL CLAYTON, EXAMINING ATTORNEY

SN 77-564,421. APCO GRAPHICS, INC., ATLANTA, GA. FILED 9-8-2008.

SN 77-564,457. FIGUEREDO, DOMINGO, ORANGE PARK, FL. FILED 9-8-2008.

HILITE

Scheduled Innovation

THE MARK CONSISTS OF STANDARD CHARACTERS WITHOUT CLAIM TO ANY PARTICULAR FONT, STYLE, SIZE, OR COLOR.

THE MARK CONSISTS OF STANDARD CHARACTERS WITHOUT CLAIM TO ANY PARTICULAR FONT, STYLE, SIZE, OR COLOR.

CLASS 9—ELECTRICAL AND SCIENTIFIC APPARATUS

FOR ARCHITECTURAL SIGNS AND COMPONENTS THEREOF, NAMELY, LUMINOUS DIRECTORY SIGNS, DISPLAY SIGNS, EXTERIOR SIGNS, AND INTERIOR SIGNS (U.S. CLS. 21, 23, 26, 36 AND 38).

CLASS 41—EDUCATION AND ENTERTAINMENT

FOR EDUCATION SERVICES, NAMELY, PROVIDING CLASSES, SEMINARS, WORKSHOPS IN THE FIELD OF HIGH TECHNOLOGY AND PRODUCT DEVELOPMENT (U.S. CLS. 100, 101 AND 107).

CLASS 19—NON-METALLIC BUILDING MATERIALS

FOR ARCHITECTURAL SIGNS AND COMPONENTS THEREOF, NAMELY, NON-LUMINOUS, NON-METALLIC, AND NON-MECHANICAL DIRECTORY SIGNS, DISPLAY SIGNS, EXTERIOR SIGNS, AND INTERIOR SIGNS (U.S. CLS. 1, 12, 33 AND 50).
ELIZABETH KAJUBI, EXAMINING ATTORNEY

CLASS 42—SCIENTIFIC AND COMPUTER SERVICES

FOR RESEARCH AND DEVELOPMENT FOR NEW PRODUCTS FOR OTHERS (U.S. CLS. 100 AND 101).
LEIGH CAROLINE CASE, EXAMINING ATTORNEY

SN 77-564,426. S. A. BENDHEIM LTD., PASSAIC, NJ. FILED 9-8-2008.

SN 77-564,535. TAPP, ERIC, WINCHESTER, KY. FILED 9-8-2008.

Pappy Tapps

SPIRIT COLLECTION

THE MARK CONSISTS OF STANDARD CHARACTERS WITHOUT CLAIM TO ANY PARTICULAR FONT, STYLE, SIZE, OR COLOR.

THE MARK CONSISTS OF STANDARD CHARACTERS WITHOUT CLAIM TO ANY PARTICULAR FONT, STYLE, SIZE, OR COLOR.

NO CLAIM IS MADE TO THE EXCLUSIVE RIGHT TO USE "COLLECTION", APART FROM THE MARK AS SHOWN.

CLASS 31—NATURAL AGRICULTURAL PRODUCTS

FOR FISH FARM RAISED LIVE FISH FOR FOOD PURPOSES (U.S. CLS. 1 AND 46).

CLASS 19—NON-METALLIC BUILDING MATERIALS

FOR BUILDING GLASS; DECORATIVE GLASS FOR BUILDING; LAMINATED GLASS FOR ARCHITECTURAL APPLICATIONS (U.S. CLS. 1, 12, 33 AND 50).
FIRST USE 8-29-2008; IN COMMERCE 8-29-2008.

CLASS 32—LIGHT BEVERAGES

FOR BEER (U.S. CLS. 45, 46 AND 48).

CLASS 20—FURNITURE AND ARTICLES NOT OTHERWISE CLASSIFIED

FOR DECORATIVE GLASS INSERTS FOR FURNITURE (U.S. CLS. 2, 13, 22, 25, 32 AND 50).
FIRST USE 8-29-2008; IN COMMERCE 8-29-2008.
LEIGH CAROLINE CASE, EXAMINING ATTORNEY

CLASS 35—ADVERTISING AND BUSINESS

FOR RETAIL FISH MARKET AND WHOLESALE FISH DISTRIBUTORSHIP SERVICES (U.S. CLS. 100, 101 AND 102).

CLASS 43—HOTEL AND RESTAURANT SERVICES

FOR RESTAURANT SERVICES (U.S. CLS. 100 AND 101).
JUDITH HELFMAN, EXAMINING ATTORNEY

SN 77-564,568. FOX, DONNA, WASHINGTON, NJ. FILED 9-8-2008.

SN 77-564,761. LEMUR INTERNATIONAL, RICHMOND, CA. FILED 9-8-2008.

Cinderooz

THE MARK CONSISTS OF STANDARD CHARACTERS WITHOUT CLAIM TO ANY PARTICULAR FONT, STYLE, SIZE, OR COLOR.

CLASS 18—LEATHER GOODS

FOR ANIMAL HARNESSSES; GARMENTS FOR PETS (U.S. CLS. 1, 2, 3, 22 AND 41).

CLASS 25—CLOTHING

FOR JACKET LINERS; JACKETS; SHIRTS; SWEAT JACKETS; SWEAT SHIRTS; VESTS; WEARABLE GARMENTS AND CLOTHING, NAMELY, SHIRTS (U.S. CLS. 22 AND 39).
BARBARA RUTLAND, EXAMINING ATTORNEY

SN 77-564,633. E COMPLETE, LLC, RENO, NV. FILED 9-8-2008.



NO CLAIM IS MADE TO THE EXCLUSIVE RIGHT TO USE "SHOE" AND "TM", APART FROM THE MARK AS SHOWN.

THE MARK CONSISTS OF THE WORD "SHOE" IN THE SHAPE OF A SHOE AND THE WORD "INN" IN THE SHAPE OF A BUILDING WITH A CHIMNEY FORMED FROM THE "TM" ABBREVIATION FOR TRADEMARK.

CLASS 6—METAL GOODS

FOR METAL DISPENSERS FOR SHOE COVERS (U.S. CLS. 2, 12, 13, 14, 23, 25 AND 50).
FIRST USE 9-0-2008; IN COMMERCE 9-0-2008.

CLASS 7—MACHINERY

FOR MECHANIZED SHOE COVER DISPENSER FEATURING POWERED COMPONENTS FOR COVERING A SHOE WITH A SHOE COVER (U.S. CLS. 13, 19, 21, 23, 31, 34 AND 35).
FIRST USE 9-0-2008; IN COMMERCE 9-0-2008.
CARYN GLASSER, EXAMINING ATTORNEY

ZOMA

THE MARK CONSISTS OF STANDARD CHARACTERS WITHOUT CLAIM TO ANY PARTICULAR FONT, STYLE, SIZE, OR COLOR.

CLASS 3—COSMETICS AND CLEANING PREPARATIONS

FOR ESSENTIAL OILS; ESSENTIAL OILS FOR FOOD FLAVORINGS (U.S. CLS. 1, 4, 6, 50, 51 AND 52).

CLASS 30—STAPLE FOODS

FOR BAKING SPICES; EDIBLE SPICES; EXTRACTS USED AS FLAVORING; SPICES (U.S. CL. 46).
MARK RADEMACHER, EXAMINING ATTORNEY

SN 77-564,832. KNOXVILLE NEWS-SENTINEL COMPANY, INC., KNOXVILLE, TN. FILED 9-8-2008.



THE MARK CONSISTS OF THE LETTERS "KNS" TO THE RIGHT OF A CHECKERED DESIGN.

CLASS 35—ADVERTISING AND BUSINESS

FOR PROMOTION AND ADVERTISING SERVICES AND RELATED CONSULTING (U.S. CLS. 100, 101 AND 102).
FIRST USE 7-25-2008; IN COMMERCE 7-25-2008.

CLASS 41—EDUCATION AND ENTERTAINMENT

FOR MULTIMEDIA PUBLISHING OF NEWSPAPERS, MAGAZINES AND ELECTRONIC PUBLICATIONS (U.S. CLS. 100, 101 AND 107).
FIRST USE 7-25-2008; IN COMMERCE 7-25-2008.
CHRISTINA SOBRAL, EXAMINING ATTORNEY

SN 77-564,884. SHRYK, LLC, EDMOND, OK. FILED 9-8-2008.

MYMOOLA

THE MARK CONSISTS OF STANDARD CHARACTERS WITHOUT CLAIM TO ANY PARTICULAR FONT, STYLE, SIZE, OR COLOR.

CLASS 9—ELECTRICAL AND SCIENTIFIC APPARATUS

FOR COMPUTER SOFTWARE FOR USE IN THE FIELD OF EDUCATION OF FINANCE AND ACCOUNTING; COMPUTER SOFTWARE THAT ALLOWS USERS TO LEARN ABOUT, CREATE AND ACCESS BANK ACCOUNT INFORMATION AND PERFORM BANK TRANSACTIONS (U.S. CLS. 21, 23, 26, 36 AND 38).

CLASS 35—ADVERTISING AND BUSINESS

FOR BUSINESS CONSULTATION SERVICES (U.S. CLS. 100, 101 AND 102).

CLASS 36—INSURANCE AND FINANCIAL

FOR FINANCIAL INFORMATION AND ADVISORY SERVICES (U.S. CLS. 100, 101 AND 102).

CLASS 38—COMMUNICATION

FOR PROVIDING ON-LINE CHAT ROOMS AND ELECTRONIC BULLETIN BOARDS FOR TRANSMISSION OF MESSAGES AMONG USERS IN THE FIELD OF FINANCE AND ACCOUNTING (U.S. CLS. 100, 101 AND 104).

CLASS 41—EDUCATION AND ENTERTAINMENT

FOR EDUCATION SERVICES, NAMELY, PROVIDING LIVE AND ON-LINE INSTRUCTION IN THE FIELDS OF FINANCE AND ACCOUNTING (U.S. CLS. 100, 101 AND 107).

CLASS 42—SCIENTIFIC AND COMPUTER SERVICES

FOR PROVIDING TEMPORARY USE OF NON-DOWNLOADABLE SOFTWARE FOR OTHERS TO CREATE AND ACCESS BANK ACCOUNT INFORMATION AND PERFORM BANK TRANSACTIONS (U.S. CLS. 100 AND 101).

CLASS 45—PERSONAL AND LEGAL SERVICES

FOR ON-LINE SOCIAL NETWORKING SERVICES (U.S. CLS. 100 AND 101).
DEZMONA MIZELLE, EXAMINING ATTORNEY

SN 77-564,889. OVOTT, LLC., PLEASANTON, CA. FILED 9-8-2008.

OVOTT

THE MARK CONSISTS OF STANDARD CHARACTERS WITHOUT CLAIM TO ANY PARTICULAR FONT, STYLE, SIZE, OR COLOR.

CLASS 9—ELECTRICAL AND SCIENTIFIC APPARATUS

FOR SOFTWARE USED FOR GATHERING, MANAGING AND ANALYZING BUSINESS INTELLIGENCE (U.S. CLS. 21, 23, 26, 36 AND 38).

CLASS 42—SCIENTIFIC AND COMPUTER SERVICES

FOR SOFTWARE CONSULTING SERVICES IN THE AREA OF BUSINESS INTELLIGENCE (U.S. CLS. 100 AND 101).
GRETCHEN ULRICH, EXAMINING ATTORNEY

SN 77-564,895. OVOTT, LLC., PLEASANTON, CA. FILED 9-8-2008.

ONE VERSION OF THE TRUTH

THE MARK CONSISTS OF STANDARD CHARACTERS WITHOUT CLAIM TO ANY PARTICULAR FONT, STYLE, SIZE, OR COLOR.

CLASS 9—ELECTRICAL AND SCIENTIFIC APPARATUS

FOR SOFTWARE USED FOR GATHERING, MANAGING AND ANALYZING BUSINESS INTELLIGENCE (U.S. CLS. 21, 23, 26, 36 AND 38).

CLASS 42—SCIENTIFIC AND COMPUTER SERVICES

FOR SOFTWARE CONSULTING SERVICES IN THE AREA OF BUSINESS INTELLIGENCE (U.S. CLS. 100 AND 101).
GRETCHEN ULRICH, EXAMINING ATTORNEY

SN 77-564,899. SHRYK, LLC, EDMOND, OK. FILED 9-8-2008.

WEPROSPER

THE MARK CONSISTS OF STANDARD CHARACTERS WITHOUT CLAIM TO ANY PARTICULAR FONT, STYLE, SIZE, OR COLOR.

CLASS 9—ELECTRICAL AND SCIENTIFIC APPARATUS

FOR COMPUTER SOFTWARE FOR USE IN THE FIELD OF EDUCATION OF FINANCE AND ACCOUNTING; COMPUTER SOFTWARE THAT ALLOWS USERS TO LEARN ABOUT, CREATE AND ACCESS BANK ACCOUNT INFORMATION AND PERFORM BANK TRANSACTIONS (U.S. CLS. 21, 23, 26, 36 AND 38).

CLASS 35—ADVERTISING AND BUSINESS

FOR BUSINESS CONSULTATION SERVICES (U.S. CLS. 100, 101 AND 102).

CLASS 41—EDUCATION AND ENTERTAINMENT

FOR EDUCATION SERVICES, NAMELY, PROVIDING LIVE AND ON-LINE INSTRUCTION IN THE FIELDS OF FINANCE AND ACCOUNTING (U.S. CLS. 100, 101 AND 107).

CLASS 45—PERSONAL AND LEGAL SERVICES

FOR ON-LINE SOCIAL NETWORKING SERVICES (U.S. CLS. 100 AND 101).
DEZMONA MIZELLE, EXAMINING ATTORNEY

SN 77-564,910. SHRYK, LLC, EDMOND, OK. FILED 9-8-2008.

ITHRYV

THE MARK CONSISTS OF STANDARD CHARACTERS WITHOUT CLAIM TO ANY PARTICULAR FONT, STYLE, SIZE, OR COLOR.

CLASS 9—ELECTRICAL AND SCIENTIFIC APPARATUS

FOR COMPUTER SOFTWARE FOR USE IN THE FIELD OF EDUCATION OF FINANCE AND ACCOUNTING; COMPUTER SOFTWARE THAT ALLOWS USERS TO LEARN ABOUT, CREATE AND ACCESS BANK ACCOUNT INFORMATION AND PERFORM BANK TRANSACTIONS (U.S. CLS. 21, 23, 26, 36 AND 38).

CLASS 35—ADVERTISING AND BUSINESS

FOR BUSINESS CONSULTATION SERVICES (U.S. CLS. 100, 101 AND 102).

CLASS 36—INSURANCE AND FINANCIAL

FOR FINANCIAL INFORMATION AND ADVISORY SERVICES (U.S. CLS. 100, 101 AND 102).

CLASS 42—SCIENTIFIC AND COMPUTER SERVICES

FOR PROVIDING TEMPORARY USE OF NON-DOWNLOADABLE SOFTWARE FOR OTHERS TO CREATE AND ACCESS BANK ACCOUNT INFORMATION AND PERFORM BANK TRANSACTIONS (U.S. CLS. 100 AND 101).

CLASS 45—PERSONAL AND LEGAL SERVICES

FOR ON-LINE SOCIAL NETWORKING SERVICES (U.S. CLS. 100 AND 101).
DEZMONA MIZELLE, EXAMINING ATTORNEY

SN 77-564,912. SHRYK, LLC, EDMOND, OK. FILED 9-8-2008.

SHRYK

THE MARK CONSISTS OF STANDARD CHARACTERS WITHOUT CLAIM TO ANY PARTICULAR FONT, STYLE, SIZE, OR COLOR.

CLASS 9—ELECTRICAL AND SCIENTIFIC APPARATUS

FOR COMPUTER SOFTWARE FOR USE IN THE FIELD OF EDUCATION OF FINANCE AND ACCOUNTING; COMPUTER SOFTWARE THAT ALLOWS USERS TO LEARN ABOUT, CREATE AND ACCESS BANK ACCOUNT INFORMATION AND PERFORM BANK TRANSACTIONS (U.S. CLS. 21, 23, 26, 36 AND 38).

CLASS 38—COMMUNICATION

FOR PROVIDING ON-LINE CHAT ROOMS AND ELECTRONIC BULLETIN BOARDS FOR TRANSMISSION OF MESSAGES AMONG USERS IN THE FIELD OF FINANCE AND ACCOUNTING (U.S. CLS. 100, 101 AND 104).

CLASS 41—EDUCATION AND ENTERTAINMENT

FOR EDUCATION SERVICES, NAMELY, PROVIDING LIVE AND ON-LINE INSTRUCTION IN THE FIELDS OF FINANCE AND ACCOUNTING (U.S. CLS. 100, 101 AND 107).

CLASS 42—SCIENTIFIC AND COMPUTER SERVICES

FOR PROVIDING TEMPORARY USE OF NON-DOWNLOADABLE SOFTWARE FOR OTHERS TO CREATE AND ACCESS BANK ACCOUNT INFORMATION AND PERFORM BANK TRANSACTIONS (U.S. CLS. 100 AND 101).

CLASS 45—PERSONAL AND LEGAL SERVICES

FOR ON-LINE SOCIAL NETWORKING SERVICES (U.S. CLS. 100 AND 101).
DEZMONA MIZELLE, EXAMINING ATTORNEY

SN 77-564,935. BEYOND WORDS PUBLISHING INCORPORATED, HILLSBORO, OR. FILED 9-8-2008.



THE MARK CONSISTS OF THREE CRESCENT SHAPES ALIGNED IN A CIRCULAR SHAPE.

CLASS 9—ELECTRICAL AND SCIENTIFIC APPARATUS

FOR DIGITAL MATERIALS, NAMELY, DVDS AND AUDIOBOOKS FEATURING A VARIETY OF TOPICS (U.S. CLS. 21, 23, 26, 36 AND 38).
FIRST USE 5-1-2008; IN COMMERCE 5-1-2008.

SN 77-564,950, ROSEARK, LLC., WEST HOLLYWOOD, CA. FILED 9-8-2008.

CLASS 16—PAPER GOODS AND PRINTED MATTER

FOR NON-FICTION BOOKS ON A VARIETY OF TOPICS (U.S. CLS. 2, 5, 22, 23, 29, 37, 38 AND 50).
FIRST USE 5-1-2008; IN COMMERCE 5-1-2008.
JOHN WILKE, EXAMINING ATTORNEY



THE MARK CONSISTS OF A ROSE AT BOTTOM WITH THE "O" CIRCLING TO THE TOP BUT NOT CONNECTING.

CLASS 14—JEWELRY

FOR JEWELRY (U.S. CLS. 2, 27, 28 AND 50).

CLASS 25—CLOTHING

FOR DRESS SHIRTS; DRESS SUITS; HOODED SWEAT SHIRTS; JACKETS; KNIT SHIRTS; LONG-SLEEVED SHIRTS; MEN'S SUITS, WOMEN'S SUITS; PANTS; PIQUE SHIRTS; POLO SHIRTS; SHIRTS; SHIRTS FOR SUITS; SHORT-SLEEVED SHIRTS; SUIT COATS; SUITS; SWEATERS; VESTS (U.S. CLS. 22 AND 39).
AMEETA JORDAN, EXAMINING ATTORNEY

Time for a Walk

SN 77-564,949, TIME FOR A WALK, LLC, ARLINGTON, VA. FILED 9-8-2008.

SN 77-565,009, G&C ENTERPRISES, INC., BEAUMONT, TX. FILED 9-8-2008.

THE MARK CONSISTS OF STANDARD CHARACTERS WITHOUT CLAIM TO ANY PARTICULAR FONT, STYLE, SIZE, OR COLOR.

CLASS 44—MEDICAL, BEAUTY AND AGRICULTURAL SERVICES

FOR (BASED ON USE IN COMMERCE) PET CARE SERVICES, NAMELY, ADMINISTRATION OF MEDICATION; PET CARE SERVICES, NAMELY, DOG WALKING, DOG BATHING AND NON-MEDICATED PET GROOMING; PET CARE SERVICES, NAMELY, DOG WALKING, DOG BATHING, NON-MEDICATED PET GROOMING AND IN-HOME MEDICAL CARE (BASED ON INTENT TO USE) PROVIDING SELF-SERVICE PET GROOMING FACILITIES; PROVIDING SELF-SERVICE PET WASHING FACILITIES (U.S. CLS. 100 AND 101).
FIRST USE 2-1-2007; IN COMMERCE 2-1-2007.

COACHING WOMEN 2 WEALTH

THE MARK CONSISTS OF STANDARD CHARACTERS WITHOUT CLAIM TO ANY PARTICULAR FONT, STYLE, SIZE, OR COLOR.

CLASS 45—PERSONAL AND LEGAL SERVICES

FOR PET SITTING (U.S. CLS. 100 AND 101).
FIRST USE 2-1-2007; IN COMMERCE 2-1-2007.
LINDA MICKLEBURGH, EXAMINING ATTORNEY

CLASS 35—ADVERTISING AND BUSINESS

FOR ON-LINE RETAIL STORE SERVICES FEATURING A WIDE VARIETY OF MERCHANDISE AND CONSUMER GOODS (U.S. CLS. 100, 101 AND 102).

CLASS 41—EDUCATION AND ENTERTAINMENT

FOR EDUCATIONAL SERVICES, NAMELY, PROVIDING SEMINARS, WORKSHOPS, MOTIVATIONAL SPEAKING AND COACHING IN THE FIELDS OF PERSONAL AND PROFESSIONAL DEVELOPMENT, FINANCES, INVESTMENTS, SELF-IMPROVEMENT, AND OTHER SELF-HELP TOPICS AND DISTRIBUTION OF COURSE MATERIAL IN CONNECTION THEREWITH; LIFE COACHING SERVICES IN THE FIELD OF PERSONAL AND PROFESSIONAL DEVELOPMENT, FINANCES, INVESTMENTS, SELF-IMPROVEMENT, AND OTHER SELF-HELP TOPICS; PROVIDING A WEB SITE THAT FEATURES INFORMAL INSTRUCTION ON PERSONAL AND PROFESSIONAL DEVELOPMENT, FINANCES, INVESTMENTS, SELF-IMPROVEMENT, AND OTHER SELF-HELP TOPICS; PUBLISHING OF ELECTRONIC PUBLICATIONS (U.S. CLS. 100, 101 AND 107).

FIRST USE 11-26-2007; IN COMMERCE 11-26-2007.
MARIA-VICTORIA SUAREZ, EXAMINING ATTORNEY

SN 77-565,062. FARHOOD, RYAN, AKA RYAN FARROW, LA JOLLA, CA. FILED 9-8-2008.



THE COLOR(S) SILVER, BLACK, AND GOLD IS/ARE CLAIMED AS A FEATURE OF THE MARK.

THE COLOR(S) SILVER APPEARS IN THE TERM "FARROW", WHICH IS STYLIZED WITH SPECIAL EMPHASIS ON THE "F," IN THE OUTLINE OF THE CIRCLE, AND IN THE WORD "TONE". THE COLOR BLACK APPEARS IN THE BACKGROUND. THE COLOR GOLD APPEARS IN THE OUTLINE OF THE WORD "TONE".

CLASS 9—ELECTRICAL AND SCIENTIFIC APPARATUS

FOR AUDIO RECORDINGS FEATURING MUSIC; DIGITAL MUSIC DOWNLOADABLE FROM THE INTERNET; DOWNLOADABLE MP3 FILES, MP3 RECORDINGS, ON-LINE DISCUSSION BOARDS, WEBCASTS AND PODCASTS FEATURING MUSIC, AUDIO BOOKS AND NEWS BROADCASTS; DOWNLOADABLE MUSICAL SOUND RECORDINGS; DOWNLOADABLE RING TONES, GRAPHICS AND MUSIC VIA A GLOBAL COMPUTER NETWORK AND WIRELESS DEVICES; DOWNLOADABLE VIDEO RECORDINGS FEATURING MUSIC AND VIDEO PERFORMANCES (U.S. CLS. 21, 23, 26, 36 AND 38).

CLASS 41—EDUCATION AND ENTERTAINMENT

FOR ENTERTAINMENT IN THE NATURE OF VISUAL AND AUDIO PERFORMANCES, NAMELY, MUSICAL BAND, ROCK GROUP, GYMNASTIC, DANCE, AND BALLET PERFORMANCES; ENTERTAINMENT IN THE NATURE OF MUSICAL PERFORMANCE BY A MUSICAL PERFORMER; ENTERTAINMENT SERVICES IN THE NATURE OF LIVE MUSICAL PERFORMANCES; ENTERTAINMENT, NAMELY, LIVE MUSIC CONCERTS; ENTERTAINMENT, NAMELY, LIVE PERFORMANCES BY A MUSICAL BAND; MULTIMEDIA ENTERTAINMENT SERVICES IN THE NATURE OF RECORDING, PRODUCTION AND POST-PRODUCTION SERVICES IN THE FIELDS OF MUSIC, VIDEO, AND FILMS; MULTIMEDIA PUBLISHING OF BOOKS, MAGAZINES, JOURNALS, SOFTWARE, GAMES, MUSIC, AND ELECTRONIC PUBLICATIONS; MUSIC COMPOSITION AND TRANSCRIPTION FOR OTHERS; MUSIC COMPOSITION FOR OTHERS; MUSIC PRODUCTION SERVICES; MUSIC PUBLISHING SERVICES; PRESENTATION OF MUSICAL PERFORMANCE; PRODUCTION OF SOUND AND MUSIC VIDEO RECORDINGS; SONG WRITING SERVICES (U.S. CLS. 100, 101 AND 107).

SHANNON TWOHIG, EXAMINING ATTORNEY

SN 77-565,075. HOME SOURCE INTERNATIONAL/TERRISOL CORP DIVISION OF HOME SOURCE INTERNATIONAL, NEW YORK, NY. FILED 9-8-2008.

ULTIMATE INDULGENCE

THE MARK CONSISTS OF STANDARD CHARACTERS WITHOUT CLAIM TO ANY PARTICULAR FONT, STYLE, SIZE, OR COLOR.

CLASS 24—FABRICS

FOR BATH TOWELS (U.S. CLS. 42 AND 50).

CLASS 25—CLOTHING

FOR BATHROBES (U.S. CLS. 22 AND 39).
JANICE L. MCMORROW, EXAMINING ATTORNEY

SN 77-565,170. TEAM AK, INC., DALLAS, TX. FILED 9-8-2008.

Team AK

THE MARK CONSISTS OF STANDARD CHARACTERS WITHOUT CLAIM TO ANY PARTICULAR FONT, STYLE, SIZE, OR COLOR.

CLASS 16—PAPER GOODS AND PRINTED MATTER

FOR ART PRINTS; CALENDARS; NOTEBOOKS; PENCILS; PENS; PHOTOGRAPHS; POSTERS; TRADING CARDS (U.S. CLS. 2, 5, 22, 23, 29, 37, 38 AND 50).

CLASS 25—CLOTHING

FOR ATHLETIC APPAREL, NAMELY, SHIRTS, PANTS, JACKETS, FOOTWEAR, HATS AND CAPS, ATHLETIC UNIFORMS; ATHLETIC FOOTWEAR; ATHLETIC SHOES (U.S. CLS. 22 AND 39).

CLASS 28—TOYS AND SPORTING GOODS

FOR COVERS FOR GOLF CLUBS; DIVOT REPAIR TOOLS; DRIVING PRACTICE MATS; FITTED COVERS FOR NON-MOTORIZED GOLF CARTS; FITTED HEAD COVERS FOR GOLF CLUBS; GOLF ACCESSORY POUCHES; GOLF ACCESSORY, NAMELY, SUPPORT FOR HOLDING A GOLF CLUB; GOLF BAG COVERS; GOLF BAG PEGS; GOLF BAG TAGS; GOLF BAGS; GOLF BAGS WITH OR WITHOUT WHEELS; GOLF BALL MARKERS; GOLF BALL RETRIEVERS; GOLF BALL SLEEVES; GOLF BALLS; GOLF CLUB BAGS; GOLF CLUB COVERS; GOLF CLUB GRIPS; GOLF CLUB HEADS; GOLF CLUB HOLDERS FOR USE ON A DRIVING RANGE OR GOLF COURSE; GOLF CLUB INSERTS; GOLF CLUB SHAFTS; GOLF CLUB SWING AIDS, NAMELY TARGET LASER AND LIGHTS; GOLF CLUB SWING AIDS, NAMELY, GOLF CLUB BALANCING SCALES AND SCALE PARTS THEREOF, TO ANALYZE, FIT AND/OR MAKE GOLF CLUBS; GOLF CLUBS; GOLF GLOVES; GOLF IRONS; GOLF PUTTER COVERS; GOLF PUTTERS; GOLF TEE MARKERS; GOLF TEES; GOLF TOWEL CLIPS FOR ATTACHMENT TO GOLF BAGS; GOLF TRAINING EQUIPMENT, NAMELY, A GOLF TRAINING CAGE; GRIP TAPES FOR GOLF CLUBS; HAND GRIPS FOR GOLF CLUBS; HEAD COVERS FOR GOLF CLUBS; IMPACT MARKERS IN THE NATURE OF PRESSURE SENSITIVE REUSABLE IMPACT LABELS FOR ATTACHMENT TO THE HEAD OF A GOLF CLUB TO INDICATE WHERE THE CLUB HITS THE BALL; MODULAR FOAM PREFABRICATED MINIATURE GOLF COURSES AND PUTTING SURFACES; NON-MOTORIZED GOLF CARTS; PUTTING PRACTICE MATS (U.S. CLS. 22, 23, 38 AND 50).

CLASS 41—EDUCATION AND ENTERTAINMENT

FOR ENCOURAGING AMATEUR SPORTS AND PHYSICAL EDUCATION BY ORGANIZING, SANCTIONING, CONDUCTING, REGULATING AND GOVERNING AMATEUR ATHLETIC PROGRAMS AND ACTIVITIES; ENTERTAINMENT IN THE NATURE OF GOLF TOURNAMENTS; GOLF COURSES; GOLF INSTRUCTION; PROVIDING A WEB SITE THROUGH WHICH GOLFERS LOCATE INFORMATION ABOUT GOLF COURSES AND GOLF TOURNAMENTS (U.S. CLS. 100, 101 AND 107).
WILLIAM VERHOSEK, EXAMINING ATTORNEY

SN 77-565,237. LOVE FROM AUSTRALIA, LLC, VENICE, CA. FILED 9-9-2008.

AUSTRALIA LOVE COLLECTIVE

THE MARK CONSISTS OF STANDARD CHARACTERS WITHOUT CLAIM TO ANY PARTICULAR FONT, STYLE, SIZE, OR COLOR.
NO CLAIM IS MADE TO THE EXCLUSIVE RIGHT TO USE "AUSTRALIA", APART FROM THE MARK AS SHOWN.

CLASS 9—ELECTRICAL AND SCIENTIFIC APPARATUS

FOR CASES FOR SPECTACLES AND SUNGLASSES; SUNGLASSES AND SPECTACLES (U.S. CLS. 21, 23, 26, 36 AND 38).

CLASS 18—LEATHER GOODS

FOR BEACH BAGS; PURSES; HANDBAGS; BRIEF-CASES; WALLETS (U.S. CLS. 1, 2, 3, 22 AND 41).

CLASS 25—CLOTHING

FOR FOOTWEAR; HEADWEAR; SHOES; BOOTS; BEACHWEAR; HATS; GLOVES; CROSS-COUNTRY MITTENS; SOCKS; TOPS; SHIRTS; PANTS; JEANS; SKIRTS; SWEATERS; BELTS; T-SHIRTS; JACKETS; BIKINIS; BEACH COVERUPS; BEACH FOOTWEAR; SCARVES; SANDALS; COATS; DRESSES (U.S. CLS. 22 AND 39).
IRA J. GOODSAD, EXAMINING ATTORNEY

SN 77-565,250. DEPARTMENT OF THE AIR FORCE, DAYTON, OH. FILED 9-9-2008.

National Museum of the US
Air Force

THE MARK CONSISTS OF STANDARD CHARACTERS WITHOUT CLAIM TO ANY PARTICULAR FONT, STYLE, SIZE, OR COLOR.

CLASS 14—JEWELRY

FOR COLLECTIBLE COINS; COMMEMORATIVE COINS (U.S. CLS. 2, 27, 28 AND 50).
FIRST USE 7-1-2004; IN COMMERCE 7-1-2004.

CLASS 18—LEATHER GOODS

FOR TOTE BAGS (U.S. CLS. 1, 2, 3, 22 AND 41).
FIRST USE 7-1-2004; IN COMMERCE 7-1-2004.

CLASS 21—HOUSEWARES AND GLASS

FOR COFFEE CUPS, TEA CUPS AND MUGS; CUPS AND MUGS (U.S. CLS. 2, 13, 23, 29, 30, 33, 40 AND 50).
FIRST USE 7-1-2004; IN COMMERCE 7-1-2004.
ERNEST SHOSHO, EXAMINING ATTORNEY

SN 77-565,295. CASUAL LIVING U.S.A., INC., TAMPA, FL. FILED 9-9-2008.

CASUAL LIVING

THE MARK CONSISTS OF STANDARD CHARACTERS WITHOUT CLAIM TO ANY PARTICULAR FONT, STYLE, SIZE, OR COLOR.
OWNER OF U.S. REG. NO. 1,647,767.
NO CLAIM IS MADE TO THE EXCLUSIVE RIGHT TO USE "CASUAL", APART FROM THE MARK AS SHOWN.

CLASS 25—CLOTHING

FOR CLOTHING, NAMELY, DRESSES, PANTSETS, CAPRI SETS, COVERUPS, SHOES, TOPS, SWEATERS, PANTS, SHORTS, SKIRTS, JACKETS, AND SWIM WEAR (U.S. CLS. 22 AND 39).

CLASS 35—ADVERTISING AND BUSINESS

FOR MAIL ORDER AND ELECTRONIC CATALOG SERVICES IN THE FIELD OF CLOTHING AND GIFT ITEMS (U.S. CLS. 100, 101 AND 102).

FIRST USE 6-30-2008; IN COMMERCE 6-30-2008.
H. M. FISHER, EXAMINING ATTORNEY

SN 77-565,411. ENVIROX, L.L.C., DANVILLE, IL. FILED 9-9-2008.

SN 77-565,361. ENVIROX, L.L.C., DANVILLE, IL. FILED 9-9-2008.

GNx2

THE MARK CONSISTS OF STANDARD CHARACTERS WITHOUT CLAIM TO ANY PARTICULAR FONT, STYLE, SIZE, OR COLOR.

CLASS 3—COSMETICS AND CLEANING PREPARATIONS

FOR ALL PURPOSE CLEANING PREPARATIONS (U.S. CLS. 1, 4, 6, 50, 51 AND 52).

FIRST USE 9-1-2008; IN COMMERCE 9-1-2008.

CLASS 41—EDUCATION AND ENTERTAINMENT

FOR EDUCATIONAL SERVICES, NAMELY, PROVIDING INSTRUCTION TO PEOPLE IN THE APPLICATION AND USE OF ENVIRONMENTALLY FRIENDLY CLEANING AGENTS (U.S. CLS. 100, 101 AND 107).

JOHN E. MICHOS, EXAMINING ATTORNEY

SN 77-565,380. ENVIROX, L.L.C., DANVILLE, IL. FILED 9-9-2008.

**Powered with GNx2
TECHNOLOGY**

THE MARK CONSISTS OF STANDARD CHARACTERS WITHOUT CLAIM TO ANY PARTICULAR FONT, STYLE, SIZE, OR COLOR.

NO CLAIM IS MADE TO THE EXCLUSIVE RIGHT TO USE "TECHNOLOGY", APART FROM THE MARK AS SHOWN.

CLASS 3—COSMETICS AND CLEANING PREPARATIONS

FOR ALL PURPOSE CLEANING PREPARATIONS (U.S. CLS. 1, 4, 6, 50, 51 AND 52).

FIRST USE 9-1-2008; IN COMMERCE 9-1-2008.

CLASS 41—EDUCATION AND ENTERTAINMENT

FOR EDUCATIONAL SERVICES, NAMELY, PROVIDING INSTRUCTION TO PEOPLE IN THE APPLICATION AND USE OF ENVIRONMENTALLY FRIENDLY CLEANING AGENTS (U.S. CLS. 100, 101 AND 107).

JOHN E. MICHOS, EXAMINING ATTORNEY

Floor Complete

THE MARK CONSISTS OF STANDARD CHARACTERS WITHOUT CLAIM TO ANY PARTICULAR FONT, STYLE, SIZE, OR COLOR.

NO CLAIM IS MADE TO THE EXCLUSIVE RIGHT TO USE FLOOR, APART FROM THE MARK AS SHOWN.

CLASS 3—COSMETICS AND CLEANING PREPARATIONS

FOR ALL PURPOSE CLEANING PREPARATIONS (U.S. CLS. 1, 4, 6, 50, 51 AND 52).

FIRST USE 9-1-2008; IN COMMERCE 9-1-2008.

CLASS 41—EDUCATION AND ENTERTAINMENT

FOR EDUCATIONAL SERVICES, NAMELY, PROVIDING INSTRUCTION TO PEOPLE IN THE APPLICATION AND USE OF ENVIRONMENTALLY FRIENDLY CLEANING AGENTS (U.S. CLS. 100, 101 AND 107).

JOHN E. MICHOS, EXAMINING ATTORNEY

SN 77-565,428. KRACKE INTERNATIONAL, INDIO, CA. FILED 9-9-2008.

**HAPPY DAISIES ARE HERE
AGAIN**

THE MARK CONSISTS OF STANDARD CHARACTERS WITHOUT CLAIM TO ANY PARTICULAR FONT, STYLE, SIZE, OR COLOR.

CLASS 12—VEHICLES

FOR BICYCLES; SMALL WAGONS FOR CHILDREN; TRICYCLES; WAGONS (U.S. CLS. 19, 21, 23, 31, 35 AND 44).

CLASS 16—PAPER GOODS AND PRINTED MATTER

FOR ADVERTISING SIGNS OF PAPER OR CARDBOARD; COASTERS MADE OF PAPER; DECALS; PAPER PLACE MATS; PERSONALIZED PAPER PLACE MATS; PRINTED PAPER SIGNS; PRINTED PAPER SIGNS, NAMELY, TABLE TENTS; STATIONERY; TEMPORARY TATTOOS (U.S. CLS. 2, 5, 22, 23, 29, 37, 38 AND 50).

CLASS 28—TOYS AND SPORTING GOODS

FOR BEAN BAG DOLLS; BOBBLEHEAD DOLLS; DOLLS; DOLLS FOR PLAYING; EUROPEAN STYLE DOLLS; PAPER DOLLS; PARTY GAMES; PLUSH DOLLS; PLUSH DOLLS CREATED FROM CHILDREN'S DRAWINGS; PORCELAIN DOLLS; RAG DOLLS; SAKURA DOLLS; SOFT SCULPTURE DOLLS; STUFFED DOLLS AND ANIMALS; TRADITIONALLY DRESSED WESTERN DOLLS; WATER SQUIRTING TOYS (U.S. CLS. 22, 23, 38 AND 50).

CLASS 30—STAPLE FOODS

FOR CAKE DOUGHS; CAKE MIXES; CAKES; CANDY; COOKIE DOUGH; COOKIE MIXES; COOKIES AND CRACKERS (U.S. CL. 46).
JULIE GUTTADAURO, EXAMINING ATTORNEY

SN 77-565,465. DOCTOR'S SIGNATURE SALES AND MARKETING INTERNATIONAL CORP., POWAY, CA. FILED 9-9-2008.

SN 77-565,442. ENVIROX, L.L.C., DANVILLE, IL. FILED 9-9-2008.

ReRite

THE MARK CONSISTS OF STANDARD CHARACTERS WITHOUT CLAIM TO ANY PARTICULAR FONT, STYLE, SIZE, OR COLOR.

CLASS 3—COSMETICS AND CLEANING PREPARATIONS

FOR ALL PURPOSE CLEANING PREPARATIONS (U.S. CLS. 1, 4, 6, 50, 51 AND 52).
FIRST USE 9-1-2008; IN COMMERCE 9-2-2008.

CLASS 41—EDUCATION AND ENTERTAINMENT

FOR EDUCATIONAL SERVICES, NAMELY, PROVIDING INSTRUCTION TO PEOPLE IN THE APPLICATION AND USE OF ENVIRONMENTALLY FRIENDLY CLEANING AGENTS (U.S. CLS. 100, 101 AND 107).
JOHN E. MICHOS, EXAMINING ATTORNEY

SN 77-565,455. ENVIROX, L.L.C., DANVILLE, IL. FILED 9-9-2008.

A Healthier Way to Clean

THE MARK CONSISTS OF STANDARD CHARACTERS WITHOUT CLAIM TO ANY PARTICULAR FONT, STYLE, SIZE, OR COLOR.
OWNER OF U.S. REG. NO. 3,245,840.

CLASS 3—COSMETICS AND CLEANING PREPARATIONS

FOR ALL PURPOSE CLEANING PREPARATIONS (U.S. CLS. 1, 4, 6, 50, 51 AND 52).
FIRST USE 9-1-2008; IN COMMERCE 9-1-2008.

CLASS 41—EDUCATION AND ENTERTAINMENT

FOR EDUCATIONAL SERVICES, NAMELY, PROVIDING INSTRUCTION TO PEOPLE IN THE APPLICATION AND USE OF ENVIRONMENTALLY FRIENDLY CLEANING AGENTS (U.S. CLS. 100, 101 AND 107).
FIRST USE 9-1-2008; IN COMMERCE 9-1-2008.
JOHN E. MICHOS, EXAMINING ATTORNEY

TRUBOOST

THE MARK CONSISTS OF STANDARD CHARACTERS WITHOUT CLAIM TO ANY PARTICULAR FONT, STYLE, SIZE, OR COLOR.

CLASS 5—PHARMACEUTICALS

FOR NUTRITIONALLY FORTIFIED BEVERAGES, VITAMIN FORTIFIED BEVERAGES, AND PRINTED PRODUCT INFORMATION MATERIALS DISTRIBUTED THEREWITH (U.S. CLS. 6, 18, 44, 46, 51 AND 52).

CLASS 32—LIGHT BEVERAGES

FOR ENERGY DRINKS, SPORT DRINKS, MINERAL AND CARBONATED WATERS, AND PRINTED PRODUCT INFORMATION MATERIALS DISTRIBUTED THEREWITH (U.S. CLS. 45, 46 AND 48).
KATHLEEN M. VANSTON, EXAMINING ATTORNEY

SN 77-565,498. ENVIROX, L.L.C., DANVILLE, IL. FILED 9-9-2008.



OWNER OF U.S. REG. NOS. 3,217,359 AND 3,245,839.
THE MARK CONSISTS OF THE WORD "ENVIROX" WHERE THE "O" HAS BEEN REPLACED BY AN IMAGE OF A GLOBE.

CLASS 3—COSMETICS AND CLEANING PREPARATIONS

FOR ALL PURPOSE CLEANING PREPARATIONS (U.S. CLS. 1, 4, 6, 50, 51 AND 52).
FIRST USE 9-1-2008; IN COMMERCE 9-1-2008.

CLASS 41—EDUCATION AND ENTERTAINMENT

FOR EDUCATIONAL SERVICES, NAMELY, PROVIDING INSTRUCTION TO PEOPLE IN THE APPLICATION AND USE OF ENVIRONMENTALLY FRIENDLY CLEANING AGENTS (U.S. CLS. 100, 101 AND 107).
FIRST USE 9-1-2001; IN COMMERCE 9-1-2008.
JOHN E. MICHOS, EXAMINING ATTORNEY

SN 77-565,507. STARZ MEDIA, LLC, BURBANK, CA. FILED 9-9-2008.



THE MARK CONSISTS OF A STYLIZED LETTER "A".

CLASS 9—ELECTRICAL AND SCIENTIFIC APPARATUS

FOR VIDEOS, DVDS, CDS, AND CD-ROMS FEATURING CONTENT IN THE FIELD OF FITNESS, HORROR, ANIMATION, AND CHILDREN'S EDUCATION (U.S. CLS. 21, 23, 26, 36 AND 38).

CLASS 16—PAPER GOODS AND PRINTED MATTER

FOR PAPER GOODS AND PRINTED MATERIAL, NAMELY, COMIC BOOKS, POSTERS, NOTEBOOKS, CALENDARS, PENS, TRADING CARDS, AND STICKERS (U.S. CLS. 2, 5, 22, 23, 29, 37, 38 AND 50).

CLASS 25—CLOTHING

FOR CLOTHING, NAMELY, BASEBALL HATS, T-SHIRTS, SWEATSHIRTS, SPORTS JERSEYS, AND JACKETS (U.S. CLS. 22 AND 39).

CLASS 35—ADVERTISING AND BUSINESS

FOR DISTRIBUTORSHIP SERVICES IN THE FIELD OF VIDEOS AND DVDS (U.S. CLS. 100, 101 AND 102).

CLASS 41—EDUCATION AND ENTERTAINMENT

FOR ENTERTAINMENT SERVICES, NAMELY, PRODUCTION AND DISTRIBUTION OF MOTION PICTURE FILMS AND TELEVISION PROGRAMS; AND PRODUCTION OF VIDEO DISCS (U.S. CLS. 100, 101 AND 107).
TIMOTHY FINNEGAN, EXAMINING ATTORNEY

SN 77-565,517. JALICO INDUSTRIES LTD, HONG KONG, HONG KONG, FILED 9-9-2008.



THE MARK CONSISTS OF "GEARFLAG" IN WHITE LETTERS ON A BLACK BACKGROUND.

CLASS 9—ELECTRICAL AND SCIENTIFIC APPARATUS

FOR CAR CASSETTE PLAYERS; CAR TELEVISIONS (U.S. CLS. 21, 23, 26, 36 AND 38).

CLASS 12—VEHICLES

FOR ANTI-THEFT DEVICES FOR MOTOR CARS; BACK-UP WARNING ALARMS FOR VEHICLES (U.S. CLS. 19, 21, 23, 31, 35 AND 44).

JACQUELINE A. LAVINE, EXAMINING ATTORNEY

SN 77-565,536. ENVIROX, L.L.C., DANVILLE, IL. FILED 9-9-2008.



NO CLAIM IS MADE TO THE EXCLUSIVE RIGHT TO USE "TECHNOLOGY", APART FROM THE MARK AS SHOWN.

THE COLOR(S) WHITE, BLACK, BLUE AND GREEN IS/ARE CLAIMED AS A FEATURE OF THE MARK.

THE MARK CONSISTS OF A BLUE AND GREEN YIN AND YANG SYMBOL OUTLINED IN WHITE WITH "GNx2 TECHNOLOGY" IN WHITE LETTERS OUTLINED IN BLUE AND BLACK SUPERIMPOSED THEREON.

CLASS 3—COSMETICS AND CLEANING PREPARATIONS

FOR ALL PURPOSE CLEANING PREPARATIONS (U.S. CLS. 1, 4, 6, 50, 51 AND 52).

FIRST USE 9-1-2008; IN COMMERCE 9-1-2008.

CLASS 41—EDUCATION AND ENTERTAINMENT

FOR EDUCATIONAL SERVICES, NAMELY, PROVIDING INSTRUCTION TO PEOPLE IN THE APPLICATION AND USE OF ENVIRONMENTALLY FRIENDLY CLEANING AGENTS (U.S. CLS. 100, 101 AND 107).

JOHN E. MICHOS, EXAMINING ATTORNEY

SN 77-565,559. ZAHARAKOS INC., COLUMBUS, IN. FILED 9-9-2008.



NO CLAIM IS MADE TO THE EXCLUSIVE RIGHT TO USE "SINCE 1900", APART FROM THE MARK AS SHOWN. THE NAME ZAHARAKOS DOES NOT IDENTIFY A LIVING INDIVIDUAL.

THE MARK CONSISTS OF A STYLIZED VERSION OF THE TERMS "ZAHARAKOS SINCE 1900".

CLASS 41—EDUCATION AND ENTERTAINMENT

FOR MUSEUMS (U.S. CLS. 100, 101 AND 107).

CLASS 43—HOTEL AND RESTAURANT SERVICES

FOR ICE CREAM SHOP SERVICES IN THE NATURE OF A RESTAURANT; RESTAURANT SERVICES (U.S. CLS. 100 AND 101).
EMILY CHUO, EXAMINING ATTORNEY

SN 77-565,569. ENVIROX, L.L.C., DANVILLE, IL. FILED 9-9-2008.



NO CLAIM IS MADE TO THE EXCLUSIVE RIGHT TO USE "TECHNOLOGY", APART FROM THE MARK AS SHOWN.

THE COLOR(S) WHITE, BLACK, BLUE AND GREEN IS/ARE CLAIMED AS A FEATURE OF THE MARK.

THE MARK CONSISTS OF A BLUE AND GREEN YIN AND YANG SYMBOL OUTLINED IN WHITE WITH "POWERED WITH" IN WHITE LETTERS AND "GNX2 TECHNOLOGY" IN WHITE LETTERS OUTLINED IN BLUE AND BLACK SUPERIMPOSED THEREON.

CLASS 3—COSMETICS AND CLEANING PREPARATIONS

FOR ALL PURPOSE CLEANING PREPARATIONS (U.S. CLS. 1, 4, 6, 50, 51 AND 52).
FIRST USE 9-1-2008; IN COMMERCE 9-1-2008.

CLASS 41—EDUCATION AND ENTERTAINMENT

FOR EDUCATIONAL SERVICES, NAMELY, PROVIDING INSTRUCTION TO PEOPLE IN THE APPLICATION AND USE OF ENVIRONMENTALLY FRIENDLY CLEANING AGENTS (U.S. CLS. 100, 101 AND 107).
JOHN E. MICHOS, EXAMINING ATTORNEY

SN 77-565,576. SMITH, SHAN, IRVINE, CA. FILED 9-9-2008.

MEET THE BINKS

THE MARK CONSISTS OF STANDARD CHARACTERS WITHOUT CLAIM TO ANY PARTICULAR FONT, STYLE, SIZE, OR COLOR.

CLASS 16—PAPER GOODS AND PRINTED MATTER

FOR CHILDREN'S BOOKS (U.S. CLS. 2, 5, 22, 23, 29, 37, 38 AND 50).

CLASS 28—TOYS AND SPORTING GOODS

FOR PUZZLES; STUFFED TOYS (U.S. CLS. 22, 23, 38 AND 50).
AARON BRODSKY, EXAMINING ATTORNEY

SN 77-565,578. RNC SYSTEMS INC., ANAHEIM, CA. FILED 9-9-2008.

SmartCoach

THE MARK CONSISTS OF STANDARD CHARACTERS WITHOUT CLAIM TO ANY PARTICULAR FONT, STYLE, SIZE, OR COLOR.

CLASS 9—ELECTRICAL AND SCIENTIFIC APPARATUS

FOR ELECTRONIC LOCATION AND IMMOBILIZATION DEVICES INSTALLED AFTER PURCHASE FOR USE WITH VEHICLES (U.S. CLS. 21, 23, 26, 36 AND 38).

CLASS 12—VEHICLES

FOR AUTOMOTIVE CONVERSIONS; LAND VEHICLE CONSOLE PARTS, NAMELY, WIRING HARNESSSES FOR CONTROL, MONITORING AND PROTECTION OF INDUSTRIAL GASOLINE AND DIESEL ENGINES (U.S. CLS. 19, 21, 23, 31, 35 AND 44).

CLASS 37—CONSTRUCTION AND REPAIR

FOR AUTOMOTIVE CONVERSION SERVICES, NAMELY, CONVERTING AUTOMOBILES AND TRUCKS TO ELECTRIC POWER; AUTOMOTIVE CONVERSION SERVICES, NAMELY, INSTALLING SPECIALTY AUTOMOTIVE EQUIPMENT (U.S. CLS. 100, 103 AND 106).
JENNY PARK, EXAMINING ATTORNEY

SN 77-565,608. ZAHARAKOS INC., COLUMBUS, IN. FILED 9-9-2008.

**ZAHARAKOS ONE
UNFORGETTABLE LOCATION
SINCE 1900**

THE MARK CONSISTS OF STANDARD CHARACTERS WITHOUT CLAIM TO ANY PARTICULAR FONT, STYLE, SIZE, OR COLOR.

NO CLAIM IS MADE TO THE EXCLUSIVE RIGHT TO USE "SINCE 1900", APART FROM THE MARK AS SHOWN. THE NAME ZAHARAKOS DOES NOT IDENTIFY A LIVING INDIVIDUAL.

CLASS 41—EDUCATION AND ENTERTAINMENT

FOR MUSEUMS (U.S. CLS. 100, 101 AND 107).

CLASS 43—HOTEL AND RESTAURANT SERVICES

FOR ICE CREAM SHOP SERVICES IN THE NATURE OF A RESTAURANT; RESTAURANTS (U.S. CLS. 100 AND 101).

EMILY CHUO, EXAMINING ATTORNEY

SN 77-565,639. ENVIROX, L.L.C., DANVILLE, IL. FILED 9-9-2008.



NO CLAIM IS MADE TO THE EXCLUSIVE RIGHT TO USE "TECHNOLOGY", APART FROM THE MARK AS SHOWN.

THE MARK CONSISTS OF A BOW SHAPE WITH A YIN YANG SYMBOL OVERLAPPING THE BOTTOM OF THE BOW AND CONTAINING THE STYLIZED PHRASE "POWERED WITH GNX2 TECHNOLOGY".

CLASS 3—COSMETICS AND CLEANING PREPARATIONS

FOR (BASED ON USE IN COMMERCE) ALL PURPOSE CLEANING PREPARATIONS (U.S. CLS. 1, 4, 6, 50, 51 AND 52).

FIRST USE 9-1-2008; IN COMMERCE 9-1-2008.

CLASS 41—EDUCATION AND ENTERTAINMENT

FOR (BASED ON INTENT TO USE) EDUCATIONAL SERVICES, NAMELY, PROVIDING INSTRUCTION TO PEOPLE IN THE APPLICATION AND USE OF ENVIRONMENTALLY FRIENDLY CLEANING AGENTS (U.S. CLS. 100, 101 AND 107).

JOHN E. MICHOS, EXAMINING ATTORNEY

SN 77-565,640. INTERLAM INC., CLAUDVILLE, VA. FILED 9-9-2008.

INTERLAM

THE MARK CONSISTS OF STANDARD CHARACTERS WITHOUT CLAIM TO ANY PARTICULAR FONT, STYLE, SIZE, OR COLOR.

CLASS 40—MATERIAL TREATMENT

FOR MANUFACTURE OF ARCHITECTURAL WALL PANELS TO ORDER AND/OR SPECIFICATION OF OTHERS (U.S. CLS. 100, 103 AND 106).

FIRST USE 0-0-2000; IN COMMERCE 0-0-2000.

CLASS 42—SCIENTIFIC AND COMPUTER SERVICES

FOR DESIGN FOR OTHERS IN THE FIELD OF ARCHITECTURAL AND DECORATIVE BUILDING COMPONENTS, NAMELY, TILES, PANELS, SHEETS AND CLADDING FOR USE ON SURFACES OF BUILDING INTERIORS AND BUILDING EXTERIORS (U.S. CLS. 100 AND 101).

FIRST USE 0-0-1995; IN COMMERCE 0-0-2000.
DAVID YONTEF, EXAMINING ATTORNEY

SN 77-565,678. PARTNERED BEVERAGES LLC, BILLINGS, MT. FILED 9-9-2008.

GREAT COFFEE, GREAT PEOPLE

THE MARK CONSISTS OF STANDARD CHARACTERS WITHOUT CLAIM TO ANY PARTICULAR FONT, STYLE, SIZE, OR COLOR.

CLASS 21—HOUSEWARES AND GLASS

FOR CERAMIC COFFEE MUGS, STEEL COFFEE MUGS, PLASTIC COFFEE MUGS, DRINKING GLASSES AND STEEL THERMAL INSULATED BEVERAGE CONTAINERS (U.S. CLS. 2, 13, 23, 29, 30, 33, 40 AND 50).

FIRST USE 3-17-1994; IN COMMERCE 3-17-1994.

CLASS 43—HOTEL AND RESTAURANT SERVICES

FOR MOBILE CAFE SERVICES FOR PROVIDING FOOD AND DRINK; CAFE SERVICES FOR PROVIDING FOOD AND DRINK (U.S. CLS. 100 AND 101).

FIRST USE 3-17-1994; IN COMMERCE 3-17-1994.
DANNEAN HETZEL, EXAMINING ATTORNEY

SN 77-565,691. MARCHBANKS, JACK R., COLUMBUS, OH. FILED 9-9-2008.

BIGdogged

THE MARK CONSISTS OF STANDARD CHARACTERS WITHOUT CLAIM TO ANY PARTICULAR FONT, STYLE, SIZE, OR COLOR.

CLASS 16—PAPER GOODS AND PRINTED MATTER

FOR PUBLICATIONS, NAMELY, BOOKS, MAGAZINES AND NEWSPAPERS IN THE FIELDS OF SOCIAL COMMENTARY (U.S. CLS. 2, 5, 22, 23, 29, 37, 38 AND 50).

CLASS 41—EDUCATION AND ENTERTAINMENT

FOR ENTERTAINMENT SERVICES, NAMELY, PROVIDING A WEB SITE FEATURING PHOTOGRAPHIC, AUDIO, VIDEO AND PROSE PRESENTATIONS FEATURING SOCIAL COMMENTARY AND PUBLIC COMMENTS (U.S. CLS. 100, 101 AND 107).

LYDIA BELZER, EXAMINING ATTORNEY

SN 77-565,859. HACH COMPANY, LOVELAND, CO. FILED 9-9-2008.

HACH HOMELAND SECURITY TECHNOLOGIES

THE MARK CONSISTS OF STANDARD CHARACTERS WITHOUT CLAIM TO ANY PARTICULAR FONT, STYLE, SIZE, OR COLOR.

OWNER OF U.S. REG. NOS. 1,376,743, 2,788,506 AND OTHERS.

NO CLAIM IS MADE TO THE EXCLUSIVE RIGHT TO USE "HOMELAND SECURITY TECHNOLOGIES", APART FROM THE MARK AS SHOWN.

CLASS 1—CHEMICALS

FOR TEST KITS COMPRISED OF CHEMICAL REAGENTS FOR NON-MEDICAL PURPOSES FOR USE FOR TESTING AND ANALYZING WATER AND OTHER AQUEOUS SOLUTIONS (U.S. CLS. 1, 5, 6, 10, 26 AND 46).

FIRST USE 3-0-2004; IN COMMERCE 3-0-2004.

CLASS 9—ELECTRICAL AND SCIENTIFIC APPARATUS

FOR ELECTRONIC WARNING SYSTEMS COMPRISED OF EVENT DETECTION INSTRUMENTATION, NAMELY AUTOMATIC LIQUID ANALYZERS, TURBIDIMETERS, PROBES FOR ANALYZING LIQUIDS, THERMOMETERS AND PRESSURE SENSORS, DIAGNOSTIC SOFTWARE FOR ANALYZING WATER AND OTHER AQUEOUS SOLUTIONS, AND ALARM SYSTEMS; TEST KITS COMPRISED OF PORTABLE ANALYZERS, MONITORS, PROBES, AND SAMPLERS FOR SAMPLING, TESTING, ANALYZING AND MONITORING THE SAFETY OF WATER AND OTHER AQUEOUS SOLUTIONS (U.S. CLS. 21, 23, 26, 36 AND 38).

FIRST USE 3-0-2004; IN COMMERCE 3-0-2004.
KELLY BOULTON, EXAMINING ATTORNEY

SN 77-565,926. HACH COMPANY, LOVELAND, CO. FILED 9-9-2008.

HACH HST

THE MARK CONSISTS OF STANDARD CHARACTERS WITHOUT CLAIM TO ANY PARTICULAR FONT, STYLE, SIZE, OR COLOR.

OWNER OF U.S. REG. NOS. 1,376,743, 2,788,506 AND OTHERS.

CLASS 1—CHEMICALS

FOR TEST KITS COMPRISED OF CHEMICAL REAGENTS FOR NON-MEDICAL PURPOSES FOR USE FOR TESTING AND ANALYZING WATER AND OTHER AQUEOUS SOLUTIONS (U.S. CLS. 1, 5, 6, 10, 26 AND 46).

CLASS 9—ELECTRICAL AND SCIENTIFIC APPARATUS

FOR ELECTRONIC WARNING SYSTEMS COMPRISED OF EVENT DETECTION INSTRUMENTATION, NAMELY AUTOMATIC LIQUID ANALYZERS, TURBIDIMETERS, PROBES FOR ANALYZING LIQUIDS, THERMOMETERS AND PRESSURE SENSORS, DIAGNOSTIC SOFTWARE FOR ANALYZING WATER AND OTHER AQUEOUS SOLUTIONS, AND ALARM SYSTEMS; TEST KITS COMPRISED OF PORTABLE ANALYZERS, MONITORS, PROBES, AND SAMPLERS FOR SAMPLING, TESTING, ANALYZING AND MONITORING THE SAFETY OF WATER AND OTHER AQUEOUS SOLUTIONS (U.S. CLS. 21, 23, 26, 36 AND 38).

KELLY BOULTON, EXAMINING ATTORNEY

SN 77-565,982. BLUE PARROT LLC, NEW YORK, NY. FILED 9-9-2008.

BLUE PARROT

THE MARK CONSISTS OF STANDARD CHARACTERS WITHOUT CLAIM TO ANY PARTICULAR FONT, STYLE, SIZE, OR COLOR.

CLASS 25—CLOTHING

FOR T-SHIRTS, SWEATSHIRTS, SWEATERS, JACKETS, HATS (U.S. CLS. 22 AND 39).

CLASS 33—WINES AND SPIRITS

FOR TEQUILA, VODKA, RUM; PREPARED ALCOHOLIC COCKTAILS AND ALCOHOLIC COCKTAIL MIXES (U.S. CLS. 47 AND 49).

SUSAN RICHARDS, EXAMINING ATTORNEY

SN 77-565,991. BLUE PARROT LLC, NEW YORK, NY. FILED 9-9-2008.

BLU PARROT

THE MARK CONSISTS OF STANDARD CHARACTERS WITHOUT CLAIM TO ANY PARTICULAR FONT, STYLE, SIZE, OR COLOR.

CLASS 25—CLOTHING

FOR T-SHIRTS, SWEATSHIRTS, SWEATERS, JACKETS, HATS (U.S. CLS. 22 AND 39).

CLASS 33—WINES AND SPIRITS

FOR TEQUILA, VODKA, RUM; PREPARED ALCOHOLIC COCKTAILS AND ALCOHOLIC COCKTAIL MIXES (U.S. CLS. 47 AND 49).

SUSAN RICHARDS, EXAMINING ATTORNEY

CLASS 41—EDUCATION AND ENTERTAINMENT

FOR PROVIDING A WEB SITE FEATURING INFORMATION ON EXERCISE AND FITNESS; PROVIDING A WEB SITE FEATURING SPORTING INFORMATION (U.S. CLS. 100, 101 AND 107).

FRED CARL, EXAMINING ATTORNEY

SN 77-565,997. KOHL'S ILLINOIS, INC., AURORA, IL. FILED 9-9-2008.

SN 77-566,198. COAST PRODUCE CO., LOS ANGELES, CA. FILED 9-9-2008.

APT. 9

THE MARK CONSISTS OF STANDARD CHARACTERS WITHOUT CLAIM TO ANY PARTICULAR FONT, STYLE, SIZE, OR COLOR.

OWNER OF U.S. REG. NOS. 3,124,979, 3,525,748 AND OTHERS.

COAST ORGANIC

CLASS 8—HAND TOOLS

FOR FLATWARE, NAMELY, FORKS, KNIVES, AND SPOONS (U.S. CLS. 23, 28 AND 44).

CLASS 21—HOUSEWARES AND GLASS

FOR BEVERAGEWARE; BOWLS; COASTERS, NOT OF PAPER AND OTHER THAN TABLE LINEN; CUPS; MUGS; NAPKIN RINGS; PLATES; SERVING PLATTERS; SERVING TRAYS (U.S. CLS. 2, 13, 23, 29, 30, 33, 40 AND 50).

CLASS 24—FABRICS

FOR TABLE LINEN, NAMELY, PLACE MATS, NAPKINS, TABLE CLOTHS, AND COASTERS (U.S. CLS. 42 AND 50).

SUSAN RICHARDS, EXAMINING ATTORNEY

THE MARK CONSISTS OF STANDARD CHARACTERS WITHOUT CLAIM TO ANY PARTICULAR FONT, STYLE, SIZE, OR COLOR.

OWNER OF U.S. REG. NOS. 2,543,011 AND 2,544,949.

NO CLAIM IS MADE TO THE EXCLUSIVE RIGHT TO USE "ORGANIC", APART FROM THE MARK AS SHOWN.

CLASS 31—NATURAL AGRICULTURAL PRODUCTS

FOR ORGANIC FRESH FRUITS, VEGETABLES, BEANS, NUTS AND UNPROCESSED GRAINS (U.S. CLS. 1 AND 46).

CLASS 35—ADVERTISING AND BUSINESS

FOR INVENTORY CONTROL SERVICES; INVENTORY MANAGEMENT SERVICES, NAMELY, BAR CODING FOR PRODUCT IDENTIFICATION, PRODUCT IDENTIFICATION LABELING, AND INVENTORY CONTROL LABELING; MERCHANDISE PACKAGING AND REPACKAGING; MERCHANDISING ORGANIC AGRICULTURAL PRODUCTS, GROCERIES, FOOD ITEMS; AND PROCUREMENT, NAMELY, PURCHASING ORGANIC AGRICULTURAL PRODUCTS, GROCERIES, FOOD ITEMS, FOR OTHERS (U.S. CLS. 100, 101 AND 102).

SN 77-566,156. YOU WANT GAME LLC, STRATFORD, CT. FILED 9-9-2008.

You Want Game

THE MARK CONSISTS OF STANDARD CHARACTERS WITHOUT CLAIM TO ANY PARTICULAR FONT, STYLE, SIZE, OR COLOR.

CLASS 35—ADVERTISING AND BUSINESS

FOR PROVIDING A WEB SITE AT WHICH FITNESS PROFESSIONALS AND FACILITIES CAN POST PROMOTIONAL PROFILES AND RESPOND TO ADVERTISEMENTS FOR THEIR SERVICES; PROVIDING A WEB SITE THAT PROVIDES SPORTS LEAGUE MANAGEMENT (U.S. CLS. 100, 101 AND 102).

CLASS 39—TRANSPORTATION AND STORAGE

FOR PACKAGING ARTICLES FOR TRANSPORTATION; TRANSPORTATION OF ORGANIC AGRICULTURAL PRODUCTS, GROCERIES, FOOD ITEMS, AND PACKAGED ITEMS BY TRUCKS, TRAIN, AND AIR; RENTAL OF WAREHOUSE SPACE AND STORAGE SPACE; STORAGE OF ARTICLES; AND REFRIGERATION STORAGE (U.S. CLS. 100 AND 105).

CLASS 45—PERSONAL AND LEGAL SERVICES

FOR TRACKING SERVICES FOR RETRIEVAL OF ENCODED PRODUCTS (U.S. CLS. 100 AND 101).

SUE LAWRENCE, EXAMINING ATTORNEY

SN 77-566,267. LIVENGGOOD ENGINEERING, INC., FORT COLLINS, CO. FILED 9-10-2008.

SN 77-566,323. STENGEL, ADAM M., NEW YORK, NY. FILED 9-10-2008.

Happy to be Alive

LIVENGGOOD

THE MARK CONSISTS OF STANDARD CHARACTERS WITHOUT CLAIM TO ANY PARTICULAR FONT, STYLE, SIZE, OR COLOR.

CLASS 16—PAPER GOODS AND PRINTED MATTER

FOR GIFT CARDS; GREETINGS CARDS AND POSTCARDS; INVITATION CARDS; MOTIVATIONAL CARDS (U.S. CLS. 2, 5, 22, 23, 29, 37, 38 AND 50).

CLASS 25—CLOTHING

FOR ATHLETIC APPAREL, NAMELY, SHIRTS, PANTS, JACKETS, FOOTWEAR, HATS AND CAPS, ATHLETIC UNIFORMS; HATS; PANTS; T-SHIRTS (U.S. CLS. 22 AND 39).
LINDA MICKLEBURGH, EXAMINING ATTORNEY

THE MARK CONSISTS OF "LIVENGGOOD" IN STYLIZED FORM.

CLASS 9—ELECTRICAL AND SCIENTIFIC APPARATUS

FOR COMPUTER STANDS SPECIALLY DESIGNED FOR HOLDING PATIENT-ASSOCIATED MEDICAL DEVICES, NAMELY, COMPUTERS, PRINTERS AND ACCESSORIES (U.S. CLS. 21, 23, 26, 36 AND 38).

CLASS 10—MEDICAL APPARATUS

FOR MEDICAL APPARATUS FOR FACILITATING PATIENT MOBILITY AND AMBULATION, NAMELY, ORTHOPEDIC WALKERS, WALKERS FOR USE BY MOBILITY-IMPAIRED INDIVIDUALS, WALKERS TO AID IN MOBILITY; WALKING AIDS FOR MEDICAL PURPOSES; SIT-TO-STAND ASSIST DEVICES, NAMELY, SUPPORT BARS FOR STANDING AND SITTING; ADAPTIVE ITEMS FOR PATIENTS WITH DISABILITY, NAMELY, PUSH AND SUPPORT PLATFORMS FOR PATIENTS WITH MISSING LIMBS OR LIMBS WITH TEMPORARY OR PERMANENT LIMITED FUNCTION; WHEELED IV STANDS (U.S. CLS. 26, 39 AND 44).

CLASS 12—VEHICLES

FOR MEDICAL APPARATUS FOR ORGANIZING AND TRANSPORTING PATIENT-ASSOCIATED MEDICAL DEVICES, NAMELY, HOSPITAL CARTS, HOSPITAL CARTS FOR DISPENSING MEDICATION AND MOBILE STORAGE CARTS; NON-MOTORIZED FOOD CARTS; WHEELED CABINETS FOR TRANSPORTING MEDICAL SUPPLIES; SMALL WAGONS FOR CHILDREN USED FOR PATIENT MOBILITY (U.S. CLS. 19, 21, 23, 31, 35 AND 44).

CLASS 20—FURNITURE AND ARTICLES NOT OTHERWISE CLASSIFIED

FOR BASSINETS; LOCKABLE MEDICATION DISPENSING CABINETS; LOCKABLE MEDICATION DISPENSING DRAWERS; MEDICAL GOODS SUPPLY CABINETS; OVERBED PATIENT TRAY TABLES; SITTING STOOLS; PATIENT BELONGINGS STORAGE, NAMELY, STORAGE CABINETS (U.S. CLS. 2, 13, 22, 25, 32 AND 50).
DAVID MURRAY, EXAMINING ATTORNEY

SN 77-566,337. STENGEL, ADAM M., NEW YORK, NY. FILED 9-10-2008.

Happy to be Alive Day

THE MARK CONSISTS OF STANDARD CHARACTERS WITHOUT CLAIM TO ANY PARTICULAR FONT, STYLE, SIZE, OR COLOR.

CLASS 16—PAPER GOODS AND PRINTED MATTER

FOR GREETING CARDS; GREETINGS CARDS AND POSTCARDS; HOLIDAY CARDS; INVITATION CARDS; MOTIVATIONAL CARDS; MUSICAL GREETING CARDS; NOTE CARDS; POSTCARDS AND GREETING CARDS (U.S. CLS. 2, 5, 22, 23, 29, 37, 38 AND 50).

CLASS 25—CLOTHING

FOR ATHLETIC APPAREL, NAMELY, SHIRTS, PANTS, JACKETS, FOOTWEAR, HATS AND CAPS, ATHLETIC UNIFORMS; HATS; PANTS; T-SHIRTS (U.S. CLS. 22 AND 39).
LINDA MICKLEBURGH, EXAMINING ATTORNEY

SN 77-566,388. ALASKA DUTY FREE, INC., DAVIE, FL 33314, FL. FILED 9-10-2008.

SN 77-566,453. MCCORD RESEARCH, INC., IOWA CITY, IA. FILED 9-10-2008.

GLACIER SPIRIT

THE MARK CONSISTS OF STANDARD CHARACTERS WITHOUT CLAIM TO ANY PARTICULAR FONT, STYLE, SIZE, OR COLOR.

NO CLAIM IS MADE TO THE EXCLUSIVE RIGHT TO USE "SPIRIT", APART FROM THE MARK AS SHOWN.

CLASS 3—COSMETICS AND CLEANING PREPARATIONS

FOR FRAGRANCES AND PERFUMERY (U.S. CLS. 1, 4, 6, 50, 51 AND 52).

CLASS 14—JEWELRY

FOR BRACELETS; BROOCHES; CUFFLINKS; EARRINGS; GOLD; NECKLACES; PENDANTS; PRECIOUS STONES; RINGS; SEMI-PRECIOUS STONES; SILVER (U.S. CLS. 2, 27, 28 AND 50).

CLASS 25—CLOTHING

FOR HATS; SWEAT SHIRTS; T-SHIRTS (U.S. CLS. 22 AND 39).

CLASS 33—WINES AND SPIRITS

FOR ALCOHOLIC BEVERAGES, NAMELY, WINE, ICE WINE; VODKA (U.S. CLS. 47 AND 49).
ALLISON HALL, EXAMINING ATTORNEY

SN 77-566,414. UHHS/CSAHS - CUYAHOGA, INC., DBA ST. JOHN WEST SHORE HOSPITAL, WESTLAKE, OH. FILED 9-10-2008.

INSPIRED BY FAITH... TO SERVE WITH COMPASSION

THE MARK CONSISTS OF STANDARD CHARACTERS WITHOUT CLAIM TO ANY PARTICULAR FONT, STYLE, SIZE, OR COLOR.

CLASS 41—EDUCATION AND ENTERTAINMENT

FOR MEDICAL EDUCATION SERVICES, NAMELY, PROVIDING A POST-GRADUATE OSTEOPATHIC MEDICAL EDUCATION PROGRAM (U.S. CLS. 100, 101 AND 107).

CLASS 44—MEDICAL, BEAUTY AND AGRICULTURAL SERVICES

FOR MEDICAL SERVICES (U.S. CLS. 100 AND 101).
ERNEST SHOSHO, EXAMINING ATTORNEY



THE MARK CONSISTS OF A BOX DEPICTING A PORTION OF THE MOLECULAR STRUCTURES OF THE "OLIVAMINE" INGREDIENTS WITH THE LETTER "O" AND THE SUBSCRIPT LETTER "V" IN THE LOWER RIGHT HAND CORNER AND THE WORD "OLIVAMINE" ADJACENT TO THE BOX.

CLASS 3—COSMETICS AND CLEANING PREPARATIONS

FOR NON-MEDICATED SKIN CARE PREPARATIONS (U.S. CLS. 1, 4, 6, 50, 51 AND 52).

CLASS 5—PHARMACEUTICALS

FOR MEDICATED SKIN CARE PREPARATIONS (U.S. CLS. 6, 18, 44, 46, 51 AND 52).
CARRIE GENOVESE, EXAMINING ATTORNEY

SN 77-566,525. MATTRESSLOGIX, LLC, FRISCO, TX. FILED 9-10-2008.

PRECISE COMFORT + LASTING
DURABILITY = BETTER SLEEP

THE MARK CONSISTS OF STANDARD CHARACTERS WITHOUT CLAIM TO ANY PARTICULAR FONT, STYLE, SIZE, OR COLOR.

CLASS 20—FURNITURE AND ARTICLES NOT OTHERWISE CLASSIFIED

FOR SLEEP PRODUCTS, NAMELY, MATTRESSES, SPRING MATTRESSES, BOX SPRINGS AND MATTRESS FOUNDATIONS (U.S. CLS. 2, 13, 22, 25, 32 AND 50).

CLASS 35—ADVERTISING AND BUSINESS

FOR RETAIL STORE SERVICES FEATURING MATTRESSES AND BEDDING PRODUCTS (U.S. CLS. 100, 101 AND 102).

SHARON MEIER, EXAMINING ATTORNEY

SN 77-566,540. MILLER, PEGGY A., YONKERS, NY. AND MURPHY, PATRICK, TEMECULA, CA. FILED 9-10-2008.

MYCHANGE

THE MARK CONSISTS OF STANDARD CHARACTERS WITHOUT CLAIM TO ANY PARTICULAR FONT, STYLE, SIZE, OR COLOR.

CLASS 35—ADVERTISING AND BUSINESS

FOR BUSINESS MANAGEMENT AND CONSULTATION IN THE FIELD OF CREDIT CARD INCENTIVE AND AFFINITY PROGRAMS; CREDIT CARD REGISTRATION; CREDIT CARD REGISTRATIONS SERVICES; PROMOTING THE SALE OF CREDIT CARD ACCOUNTS THROUGH THE ADMINISTRATION OF INCENTIVE AWARD PROGRAMS; PROMOTING THE SALE OF GOODS AND SERVICES OF OTHERS BY AWARDED PURCHASE POINTS FOR CREDIT CARD USE (U.S. CLS. 100, 101 AND 102).

SN 77-566,559. UNIVERSAL MINERALS INTERNATIONAL, INC., TUCSON, AZ. FILED 9-10-2008.

Shieldgrout

THE MARK CONSISTS OF STANDARD CHARACTERS WITHOUT CLAIM TO ANY PARTICULAR FONT, STYLE, SIZE, OR COLOR.

CLASS 36—INSURANCE AND FINANCIAL

FOR CHARITABLE FUNDRAISING SERVICES; CREDIT CARD SERVICES; CREDIT CARD VERIFICATION; ELECTRONIC PAYMENT, NAMELY, ELECTRONIC PROCESSING AND TRANSMISSION OF BILL PAYMENT DATA; ELECTRONIC TRANSFER OF FUNDS; ELEEMOSYNARY SERVICES IN THE FIELD OF MONETARY DONATIONS; PROVIDING CASH AND OTHER REBATES FOR CREDIT CARD USE AS PART OF A CUSTOMER LOYALTY PROGRAM (U.S. CLS. 100, 101 AND 102).

CLASS 17—RUBBER GOODS

FOR RAPID CURE, HIGH STRENGTH, POLYMER-BASED CONCRETE PATCHING COMPOUND; WALL SYSTEM CONSISTING OF INSULATED CONCRETE BLOCK (U.S. CLS. 1, 5, 12, 13, 35 AND 50).

CHERYL CLAYTON, EXAMINING ATTORNEY

CLASS 19—NON-METALLIC BUILDING MATERIALS

FOR BLOCKS OF CONCRETE; CONCRETE; CONCRETE BEAMS; CONCRETE BLOCKS; CONCRETE BUILDING MATERIALS, NAMELY, GROUT; CONCRETE FLOORS; CONCRETE PANELS; CONCRETE VAULTS; CONCRETE WALLS; CONCRETE WALLS FOR BUILDING; CONSTRUCTION MATERIALS, NAMELY, ENERGY CONSERVING PRECAST CONCRETE SLABS; CONSTRUCTION MATERIALS, NAMELY, CONCRETE SLABS DESIGNED TO INCREASE ENERGY EFFICIENCY AND ENERGY CONSERVATION; CONSTRUCTION MATERIALS, NAMELY, ENERGY CONSERVING CONCRETE SLABS; CRASH BARRIERS OF GROUT FOR ROADS; FLOOR PATCHING MATERIALS, NAMELY, CONCRETE SEALERS; GROUT; INDUSTRIAL CONCRETE FOR USE IN CIVIL ENGINEERING WORKS; SLABS OF CONCRETE DESIGNED TO CONSERVE ENERGY; SLABS OF GROUT; WALL SYSTEM CONSISTING OF REINFORCED, DRY-STACKED, ENGINEERED CONCRETE BLOCK WITH INSULATING CORE AND COATED WITH SURFACE BOND CEMENT (U.S. CLS. 1, 12, 33 AND 50).

SN 77-566,545. UNIVERSAL MINERALS INTERNATIONAL, INC., TUCSON, AZ. FILED 9-10-2008.

Shieldblock

THE MARK CONSISTS OF STANDARD CHARACTERS WITHOUT CLAIM TO ANY PARTICULAR FONT, STYLE, SIZE, OR COLOR.

CLASS 17—RUBBER GOODS

FOR WALL SYSTEM CONSISTING OF INSULATED CONCRETE BLOCK (U.S. CLS. 1, 5, 12, 13, 35 AND 50).

CLASS 19—NON-METALLIC BUILDING MATERIALS

FOR BLOCKS OF CONCRETE; BUILDING MATERIALS, NAMELY, CONCRETE-BASED SLABS MADE USING RECYCLED GLASS; CONCRETE; CONCRETE BEAMS; CONCRETE BLOCKS; CONCRETE BUILDING MATERIALS, NAMELY, CONCRETE; CONCRETE FLOORS; CONCRETE PANELS; CONCRETE RETAINING WALLS; CONCRETE VAULTS; CONCRETE WALLS; CONCRETE WALLS FOR BUILDING; CONSTRUCTION MATERIALS, NAMELY, ENERGY CONSERVING PRECAST CONCRETE SLABS; CONSTRUCTION MATERIALS, NAMELY, CONCRETE SLABS DESIGNED TO INCREASE ENERGY EFFICIENCY AND ENERGY CONSERVATION; CONSTRUCTION MATERIALS, NAMELY, ENERGY CONSERVING CONCRETE SLABS; CRASH BARRIERS OF CONCRETE FOR ROADS; INDUSTRIAL CONCRETE FOR USE IN CIVIL ENGINEERING WORKS; PAVING BLOCKS; REFRACTORY BLOCKS, NOT OF METAL; REFRACTORY CONCRETE; SLABS OF CONCRETE DESIGNED TO CONSERVE ENERGY; SLABS OF CONCRETE; WALL SYSTEM CONSISTING OF REINFORCED, DRY-STACKED, ENGINEERED CONCRETE BLOCK WITH INSULATING CORE AND COATED WITH SURFACE BOND CEMENT (U.S. CLS. 1, 12, 33 AND 50).

CLASS 37—CONSTRUCTION AND REPAIR

FOR SCAFFOLDING, EARTHWORKS OR CONCRETE CONSTRUCTION (U.S. CLS. 100, 103 AND 106).
TRACY FLETCHER, EXAMINING ATTORNEY

SN 77-566,562. APPLIED SYSTEMS, INC., UNIVERSITY PARK, IL. FILED 9-10-2008.

APPLIED SYSTEMS EPIC

THE MARK CONSISTS OF STANDARD CHARACTERS WITHOUT CLAIM TO ANY PARTICULAR FONT, STYLE, SIZE, OR COLOR.

OWNER OF U.S. REG. NOS. 2,377,187, 3,176,431 AND 3,408,717.

NO CLAIM IS MADE TO THE EXCLUSIVE RIGHT TO USE "SYSTEMS", APART FROM THE MARK AS SHOWN.

CLASS 37—CONSTRUCTION AND REPAIR

FOR SCAFFOLDING, EARTHWORKS OR CONCRETE CONSTRUCTION (U.S. CLS. 100, 103 AND 106).
TRACY FLETCHER, EXAMINING ATTORNEY

CLASS 9—ELECTRICAL AND SCIENTIFIC APPARATUS

FOR COMPUTER PROGRAMS USED FOR AUTOMATING INSURANCE ACCOUNTING, UNDERWRITING, POLICY ISSUANCE, POLICY PROTOCOL, BILLING AND INVOICING, RATE CALCULATION AND COMPARISON, CLAIMS MANAGEMENT, FORM GENERATION, REPORT GENERATION, ELECTRONIC INTERFACE, MARKETING ACTIVITIES, AND OTHER OFFICE MANAGEMENT FUNCTIONS IN THE INSURANCE AND FINANCIAL INDUSTRIES (U.S. CLS. 21, 23, 26, 36 AND 38).

CLASS 42—SCIENTIFIC AND COMPUTER SERVICES

FOR APPLICATION SERVICE PROVIDER (ASP) SERVICES FEATURING SOFTWARE FOR INSURANCE AND FINANCIAL INDUSTRIES THAT AUTOMATES ACCOUNTING, POLICY ISSUANCE, RATE CALCULATION AND COMPARISON, CLAIMS MANAGEMENT, FORM GENERATION, ELECTRONIC INTERFACE, MARKETING ACTIVITIES, INTEGRATED FAXING AND IMAGING, AND OTHER OFFICE MANAGEMENT FUNCTIONS (U.S. CLS. 100 AND 101).

BARBARA A. GOLD, EXAMINING ATTORNEY

SN 77-566,733. MILK, INC., WEST HOLLYWOOD, CA. FILED 9-10-2008.

PUDDING

THE MARK CONSISTS OF STANDARD CHARACTERS WITHOUT CLAIM TO ANY PARTICULAR FONT, STYLE, SIZE, OR COLOR.

CLASS 9—ELECTRICAL AND SCIENTIFIC APPARATUS

FOR PRE-RECORDED CDS, VIDEO TAPES, LASER DISKS AND DVDS FEATURING MUSIC AND MUSICAL ENTERTAINMENT (U.S. CLS. 21, 23, 26, 36 AND 38).

CLASS 41—EDUCATION AND ENTERTAINMENT

FOR RECORD PRODUCTION; PRODUCTION OF SOUND RECORDINGS; PRODUCTION OF MUSIC VIDEO RECORDINGS; MULTIMEDIA ENTERTAINMENT SERVICES IN THE NATURE OF RECORDING, PRODUCTION AND POST-PRODUCTION SERVICES IN THE FIELDS OF MUSIC, VIDEO, AND FILMS; ENTERTAINMENT SERVICES, NAMELY, PROVIDING LIVE MUSIC CONCERTS AND TELEVISION PROGRAMS IN THE FIELD OF MUSIC (U.S. CLS. 100, 101 AND 107).

ROBERT STRUCK, EXAMINING ATTORNEY

SN 77-566,568. APPLIED SYSTEMS, INC., UNIVERSITY PARK, IL. FILED 9-10-2008.

EPIC

THE MARK CONSISTS OF STANDARD CHARACTERS WITHOUT CLAIM TO ANY PARTICULAR FONT, STYLE, SIZE, OR COLOR.

CLASS 9—ELECTRICAL AND SCIENTIFIC APPARATUS

FOR COMPUTER PROGRAMS USED FOR AUTOMATING INSURANCE ACCOUNTING, UNDERWRITING, POLICY ISSUANCE, POLICY PROTOCOL, BILLING AND INVOICING, RATE CALCULATION AND COMPARISON, CLAIMS MANAGEMENT, FORM GENERATION, REPORT GENERATION, ELECTRONIC INTERFACE, MARKETING ACTIVITIES, AND OTHER OFFICE MANAGEMENT FUNCTIONS IN THE INSURANCE AND FINANCIAL INDUSTRIES (U.S. CLS. 21, 23, 26, 36 AND 38).

CLASS 42—SCIENTIFIC AND COMPUTER SERVICES

FOR APPLICATION SERVICE PROVIDER (ASP) SERVICES FEATURING SOFTWARE FOR INSURANCE AND FINANCIAL INDUSTRIES THAT AUTOMATES ACCOUNTING, POLICY ISSUANCE, RATE CALCULATION AND COMPARISON, CLAIMS MANAGEMENT, FORM GENERATION, ELECTRONIC INTERFACE, MARKETING ACTIVITIES, INTEGRATED FAXING AND IMAGING, AND OTHER OFFICE MANAGEMENT FUNCTIONS (U.S. CLS. 100 AND 101).

BARBARA A. GOLD, EXAMINING ATTORNEY

SN 77-566,856. FLAT BLACK, INC., RALEIGH, NC. FILED 9-10-2008.

The Long Road

THE MARK CONSISTS OF STANDARD CHARACTERS WITHOUT CLAIM TO ANY PARTICULAR FONT, STYLE, SIZE, OR COLOR.

CLASS 25—CLOTHING

FOR BELTS; FOOTWEAR; HATS; HEADWEAR; JACKETS; KNITTED CAPS; PANTS; SHORTS; SKULL CAPS; SKULLIES; SWEAT PANTS; SWEAT SHIRTS; SWEATERS; T-SHIRTS; WOOLLY HATS (U.S. CLS. 22 AND 39).

CLASS 41—EDUCATION AND ENTERTAINMENT

FOR ENTERTAINMENT SERVICES IN THE NATURE OF ORGANIZING, ARRANGING AND CONDUCTING MOTORCYCLE RIDING EXCURSIONS (U.S. CLS. 100, 101 AND 107).

ANDREA K. NADELMAN, EXAMINING ATTORNEY

SN 77-566,870. SPRUCE NATURALS, LLC, MILL VALLEY, CA. FILED 9-10-2008.

SN 77-567,006. VERTOCH, LYNETTE, CALABASAS, CA. FILED 9-10-2008.

MONTEBELLO ESTABLISHED 1388

THE MARK CONSISTS OF STANDARD CHARACTERS WITHOUT CLAIM TO ANY PARTICULAR FONT, STYLE, SIZE, OR COLOR.

OWNER OF U.S. REG. NO. 2,181,478.

NO CLAIM IS MADE TO THE EXCLUSIVE RIGHT TO USE "ESTABLISHED 1388", APART FROM THE MARK AS SHOWN.

THE FOREIGN WORDING IN THE MARK TRANSLATES INTO ENGLISH AS BEAUTIFUL MOUNTAIN.

CLASS 29—MEATS AND PROCESSED FOODS

FOR (BASED ON USE IN COMMERCE) OLIVE OIL(-BASED ON INTENT TO USE) EDIBLE OILS; JELLIES AND JAMS (U.S. CL. 46).

FIRST USE 1-25-2006; IN COMMERCE 1-25-2006.

CLASS 30—STAPLE FOODS

FOR (BASED ON USE IN COMMERCE) PASTA(BASED ON INTENT TO USE) BREAD; COCOA; HONEY; MUSTARD; PASTA SAUCE; PASTRY; RICE; SALT; SPICES; VINEGAR (U.S. CL. 46).

FIRST USE 6-30-1997; IN COMMERCE 6-1-1998. JAMES LOVELACE, EXAMINING ATTORNEY

SN 77-566,886. AMERICAN ACADEMY OF DERMATOLOGY, INC., SCHAUMBURG, IL. FILED 9-10-2008.

Indoor Tanning Is Out

THE MARK CONSISTS OF STANDARD CHARACTERS WITHOUT CLAIM TO ANY PARTICULAR FONT, STYLE, SIZE, OR COLOR.

CLASS 35—ADVERTISING AND BUSINESS

FOR PROMOTING PUBLIC AWARENESS OF DERMATOLOGY, DERMATOLOGICAL CONDITIONS AND THE HARMFUL EFFECTS OF INDOOR TANNING (U.S. CLS. 100, 101 AND 102).

FIRST USE 5-8-2008; IN COMMERCE 5-8-2008.

CLASS 44—MEDICAL, BEAUTY AND AGRICULTURAL SERVICES

FOR PROVIDING EDUCATIONAL INFORMATION IN THE FIELD OF DERMATOLOGICAL HEALTH VIA A GLOBAL COMPUTER NETWORK AND OTHER MEDIA FORMS (U.S. CLS. 100 AND 101).

FIRST USE 5-8-2008; IN COMMERCE 5-8-2008. MATTHEW EINSTEIN, EXAMINING ATTORNEY

West Third

THE MARK CONSISTS OF STANDARD CHARACTERS WITHOUT CLAIM TO ANY PARTICULAR FONT, STYLE, SIZE, OR COLOR.

CLASS 3—COSMETICS AND CLEANING PREPARATIONS

FOR HOME FRAGRANCE, PERSONAL FRAGRANCE (U.S. CLS. 1, 4, 6, 50, 51 AND 52).

CLASS 4—LUBRICANTS AND FUELS

FOR CANDLES (U.S. CLS. 1, 6 AND 15). GISELLE AGOSTO, EXAMINING ATTORNEY

SN 77-567,039. LITTLE AMERICAN BUSINESSES, INC., COSTA MESA, CA. FILED 9-10-2008.

LAB A DAB

THE MARK CONSISTS OF STANDARD CHARACTERS WITHOUT CLAIM TO ANY PARTICULAR FONT, STYLE, SIZE, OR COLOR.

CLASS 25—CLOTHING

FOR CLOTHING, NAMELY, T-SHIRTS, BELTS, SOCKS, SHORTS, PANTS, KNIT SHIRTS, WOVEN SHIRTS, JEANS, SWEATERS, SKIRTS, DRESSES, BLOUSES, TANK TOPS, SWEATSHIRTS, JACKETS AND COATS (U.S. CLS. 22 AND 39).

CLASS 36—INSURANCE AND FINANCIAL

FOR LEASING OF SHOPPING MALL SPACES (U.S. CLS. 100, 101 AND 102).

LAURA HAMMEL, EXAMINING ATTORNEY

SN 77-567,052. BIJOU, CAESAR J., LOS ANGELES, CA. AND POLICARD JR., KENOL, SHERMAN OAKS, CA. AND BUECHLER, JOHN C., SHERMAN OAKS, CA. FILED 9-10-2008.

TROLL

THE MARK CONSISTS OF STANDARD CHARACTERS WITHOUT CLAIM TO ANY PARTICULAR FONT, STYLE, SIZE, OR COLOR.

CLASS 5—PHARMACEUTICALS

FOR NUTRITIONALLY FORTIFIED BEVERAGES; VITAMIN FORTIFIED BEVERAGES (U.S. CLS. 6, 18, 44, 46, 51 AND 52).

CLASS 32—LIGHT BEVERAGES

FOR ENERGY DRINKS (U.S. CLS. 45, 46 AND 48).
CARYN GLASSER, EXAMINING ATTORNEY

CLASS 41—EDUCATION AND ENTERTAINMENT

FOR EDUCATIONAL SERVICES, NAMELY, CONDUCTING SEMINARS AND WORKSHOPS IN THE FIELD OF BUSINESS MANAGEMENT, BUSINESS MARKETING, BUSINESS TRAINING, BUSINESS ORGANIZATION AND BUSINESS CONSULTING, AND DISTRIBUTION OF TRAINING MATERIALS THEREWITH; EDUCATIONAL AND ENTERTAINMENT SERVICES, NAMELY, PROVIDING MOTIVATIONAL AND EDUCATIONAL SPEAKERS; EDUCATIONAL AND ENTERTAINMENT SERVICES, NAMELY, A CONTINUING PROGRAM ABOUT BUSINESS TRAINING, CONSULTING, MARKETING, ORGANIZATION AND PLANNING ACCESSIBLE BY RADIO, TELEVISION, SATELLITE, AUDIO, VIDEO AND COMPUTER NETWORKS; ENTERTAINMENT AND EDUCATION SERVICES IN THE NATURE OF A SERIES OF SHORT SHOWS FEATURING BUSINESS TRAINING, CONSULTING, MARKETING, ORGANIZATION AND PLANNING DISTRIBUTED TO MOBILE HANDSETS, WHICH MAY INCLUDE VIDEO, TEXT, PHOTOS, ILLUSTRATIONS OR HYPERTEXT; ENTERTAINMENT SERVICES, NAMELY, PROVIDING A RADIO PROGRAM IN THE FIELD OF BUSINESS TRAINING, CONSULTING, MARKETING, ORGANIZATION AND PLANNING VIA A GLOBAL COMPUTER NETWORK; ENTERTAINMENT SERVICES, NAMELY, PROVIDING A TELEVISION PROGRAM IN THE FIELD OF BUSINESS TRAINING, CONSULTING, MARKETING, ORGANIZATION AND PLANNING VIA A GLOBAL COMPUTER NETWORK; ENTERTAINMENT SERVICES, NAMELY, PROVIDING PODCASTS IN THE FIELD OF BUSINESS TRAINING, CONSULTING, MARKETING, ORGANIZATION AND PLANNING; ENTERTAINMENT SERVICES, NAMELY, PROVIDING WEBCASTS IN THE FIELD OF BUSINESS TRAINING, CONSULTING, MARKETING, ORGANIZATION AND PLANNING; ENTERTAINMENT SERVICES, NAMELY, AN ON-GOING SERIES FEATURING BUSINESS TRAINING, CONSULTING, MARKETING, ORGANIZATION AND PLANNING PROVIDED THROUGH CABLE TELEVISION, WEBCASTS, RADIO BROADCASTS; ENTERTAINMENT SERVICES, NAMELY, PROVIDING AN ON-GOING RADIO PROGRAM IN THE FIELD OF BUSINESS TRAINING, CONSULTING, MARKETING, ORGANIZATION AND PLANNING; ENTERTAINMENT, NAMELY, A CONTINUING EDUCATIONAL SHOW BROADCAST OVER TELEVISION, SATELLITE, AUDIO, AND VIDEO MEDIA; BUSINESS TRAINING SERVICES (U.S. CLS. 100, 101 AND 107).

MICHAEL WEBSTER, EXAMINING ATTORNEY

SN 77-567,125. JUMPBACKIN, LLC, CENTENNIAL, CO.
FILED 9-10-2008.

JUMPBACKIN

SN 77-567,166. NATURESYNERGY, INC., NAPLES, FL.
FILED 9-10-2008.

ICE ELEMENTS

THE MARK CONSISTS OF STANDARD CHARACTERS WITHOUT CLAIM TO ANY PARTICULAR FONT, STYLE, SIZE, OR COLOR.

CLASS 9—ELECTRICAL AND SCIENTIFIC APPARATUS

FOR DIGITAL MEDIA, NAMELY, PRE-RECORDED VIDEO CASSETTES, DIGITAL VIDEO DISCS, DIGITAL VERSATILE DISCS, DOWNLOADABLE AUDIO AND VIDEO RECORDINGS, DVDS, AND HIGH DEFINITION DIGITAL DISKS FEATURING BUSINESS TRAINING, CONSULTING, MARKETING, ORGANIZATION AND PLANNING (U.S. CLS. 21, 23, 26, 36 AND 38).

THE MARK CONSISTS OF STANDARD CHARACTERS WITHOUT CLAIM TO ANY PARTICULAR FONT, STYLE, SIZE, OR COLOR.

CLASS 35—ADVERTISING AND BUSINESS

FOR BUSINESS MANAGEMENT CONSULTING SERVICES; BUSINESS MARKETING CONSULTING SERVICES FOCUSED ON DIRECT MARKETING AND E-BUSINESS; BUSINESS ORGANIZATION CONSULTING; BUSINESS PLANNING SERVICES (U.S. CLS. 100, 101 AND 102).

CLASS 3—COSMETICS AND CLEANING PREPARATIONS

FOR SKIN AND BODY CARE PREPARATIONS, NAMELY, SKIN CLEANSERS, SKIN MOISTURIZERS, SKIN TONERS, SKIN LOTIONS, SKIN SOAPS, COSMETICS, NON-MEDICATED SKIN CARE PREPARATIONS (U.S. CLS. 1, 4, 6, 50, 51 AND 52).

FIRST USE 7-1-2004; IN COMMERCE 7-1-2004.

CLASS 5—PHARMACEUTICALS

FOR ACNE TREATMENT PREPARATIONS, MEDICATED HAIR CARE PREPARATIONS (U.S. CLS. 6, 18, 44, 46, 51 AND 52).
FIRST USE 7-1-2004; IN COMMERCE 7-1-2004.
DAVID TAYLOR, EXAMINING ATTORNEY

SN 77-567,318. SUSAN VOSBEIN, GULF BREEZE, FL. FILED 9-11-2008.

SN 77-567,226. MILLER, NICHOLAS GUSZ, LOS ANGELES, CA. FILED 9-10-2008.

THE GUSZ

THE MARK CONSISTS OF STANDARD CHARACTERS WITHOUT CLAIM TO ANY PARTICULAR FONT, STYLE, SIZE, OR COLOR.

CLASS 16—PAPER GOODS AND PRINTED MATTER

FOR PAINTINGS; PAINTINGS AND THEIR REPRODUCTIONS (U.S. CLS. 2, 5, 22, 23, 29, 37, 38 AND 50).

CLASS 25—CLOTHING

FOR HOODED SWEAT SHIRTS; PANTS; SCARVES; SHIRTS; TANK TOPS (U.S. CLS. 22 AND 39).
MIDGE BUTLER, EXAMINING ATTORNEY

SN 77-567,243. MAGPIE CRAFTS LLC, LOS ANGELES, CA. FILED 9-10-2008.

MAGPIE TIME

THE MARK CONSISTS OF STANDARD CHARACTERS WITHOUT CLAIM TO ANY PARTICULAR FONT, STYLE, SIZE, OR COLOR.

CLASS 9—ELECTRICAL AND SCIENTIFIC APPARATUS

FOR DIGITAL MEDIA, NAMELY, PRE-RECORDED VIDEO CASSETTES, DIGITAL VIDEO DISCS, DIGITAL VERSATILE DISCS, DOWNLOADABLE AUDIO AND VIDEO RECORDINGS, DVDS, AND HIGH DEFINITION DIGITAL DISKS FEATURING ENTERTAINMENT AND EDUCATION FOR CHILDREN (U.S. CLS. 21, 23, 26, 36 AND 38).

CLASS 41—EDUCATION AND ENTERTAINMENT

FOR ENTERTAINMENT SERVICES IN THE NATURE OF ON-GOING TELEVISION PROGRAMS IN THE FIELD OF CHILDREN'S ENTERTAINMENT (U.S. CLS. 100, 101 AND 107).
JESSICA A. POWERS, EXAMINING ATTORNEY

SWEET PEA

THE MARK CONSISTS OF STANDARD CHARACTERS WITHOUT CLAIM TO ANY PARTICULAR FONT, STYLE, SIZE, OR COLOR.

CLASS 11—ENVIRONMENTAL CONTROL APPARATUS

FOR PORTABLE URINALS FOR OUTDOOR ACTIVITIES (U.S. CLS. 13, 21, 23, 31 AND 34).

CLASS 20—FURNITURE AND ARTICLES NOT OTHERWISE CLASSIFIED

FOR PLASTIC URINARY DEVICE ENABLING USERS TO STAND WHILE URINATING (U.S. CLS. 2, 13, 22, 25, 32 AND 50).
HOWARD B. LEVINE, EXAMINING ATTORNEY

SN 77-567,412. BENNETT, CELESTE, JACKSONVILLE, FL. FILED 9-11-2008.

Our Mission Is Your Future

THE MARK CONSISTS OF STANDARD CHARACTERS WITHOUT CLAIM TO ANY PARTICULAR FONT, STYLE, SIZE, OR COLOR.

CLASS 35—ADVERTISING AND BUSINESS

FOR EMPLOYMENT HIRING, RECRUITING, PLACEMENT, STAFFING AND CAREER NETWORKING SERVICES (U.S. CLS. 100, 101 AND 102).

CLASS 41—EDUCATION AND ENTERTAINMENT

FOR PROVIDING ON-LINE INFORMATION AND NEWS IN THE FIELD OF EMPLOYMENT TRAINING; PROVIDING ON-LINE TRAINING COURSES, SEMINARS, WORKSHOPS IN THE FIELD OF EMPLOYMENT (U.S. CLS. 100, 101 AND 107).
GISELLE AGOSTO, EXAMINING ATTORNEY

SN 77-567,424. SUSTAINABLE SPACES INC., SAN FRANCISCO, CA. FILED 9-11-2008.

SN 77-567,454. SUN-RICH INTERNATIONAL, INC., WOODRIDGE, IL. FILED 9-11-2008.

We've Got Home Performance
Down to a Science

THE MARK CONSISTS OF STANDARD CHARACTERS WITHOUT CLAIM TO ANY PARTICULAR FONT, STYLE, SIZE, OR COLOR.

CLASS 35—ADVERTISING AND BUSINESS

FOR ENERGY EFFICIENCY AUDITING (U.S. CLS. 100, 101 AND 102).
FIRST USE 1-15-2008; IN COMMERCE 1-15-2008.

CLASS 37—CONSTRUCTION AND REPAIR

FOR INSTALLATION, MAINTENANCE AND REPAIR OF EFFICIENT LIGHTING, HVAC, SOLAR PANELS, WATER HEATERS, INSULATION, WEATHERIZATION (U.S. CLS. 100, 103 AND 106).
FIRST USE 1-15-2008; IN COMMERCE 1-15-2008.
ANNE E. GUSTASON, EXAMINING ATTORNEY

SN 77-567,438. ALICE IN WATER LAND, INC., DACULA, GA. FILED 9-11-2008.

ALICE IN WATER LAND, INC.

THE MARK CONSISTS OF STANDARD CHARACTERS WITHOUT CLAIM TO ANY PARTICULAR FONT, STYLE, SIZE, OR COLOR.

NO CLAIM IS MADE TO THE EXCLUSIVE RIGHT TO USE "WATER" AND "INC.", APART FROM THE MARK AS SHOWN.

CLASS 35—ADVERTISING AND BUSINESS

FOR RETAIL STORE AND ON-LINE RETAIL STORE SERVICES FEATURING WATER DISPENSERS, WATER COOLERS, CUP DISPENSERS, WATER FILTERS CERAMIC CROCKS AND WOODEN STANDS (U.S. CLS. 100, 101 AND 102).
FIRST USE 6-15-2004; IN COMMERCE 6-15-2004.

CLASS 43—HOTEL AND RESTAURANT SERVICES

FOR RENTAL OF DRINKING WATER EQUIPMENT, NAMELY, COOLERS AND HOT AND COLD DISPENSING CONSOLES (U.S. CLS. 100 AND 101).
FIRST USE 6-15-2004; IN COMMERCE 6-15-2004.
YAT SYE, LEE, EXAMINING ATTORNEY



THE MARK CONSISTS OF THE WORDS "LA NEECE" IN FRONT OF A BACKGROUND WITH A GLOBE WITHIN A SUNBURST.

CLASS 29—MEATS AND PROCESSED FOODS

FOR CHEESE; FRUIT TOPPING; JELLIES AND JAMS; OLIVE OIL; PREPARED NUTS; PRESERVED, DRIED AND COOKED OLIVES; PROCESSED NUTS; PROCESSED OLIVES; ROASTED NUTS; SHELLS NUTS (U.S. CL. 46).

CLASS 30—STAPLE FOODS

FOR CANDY; CHOCOLATE TOPPING; COFFEE AND TEA; HONEY; HOT CHOCOLATE; HOT SAUCE; MUSTARD; RICE; SALT; SPICES; VINEGAR (U.S. CL. 46).
MELVIN AXILBUND, EXAMINING ATTORNEY

SN 77-567,465. REVOLUTION LLC, WASHINGTON, DC. FILED 9-11-2008.

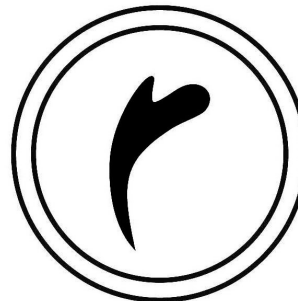

THE MARK CONSISTS OF A STYLIZED LETTER "R" AT THE CENTER OF TWO CIRCLES.

CLASS 9—ELECTRICAL AND SCIENTIFIC APPARATUSSN 77-567,467. REVOLUTION LLC, WASHINGTON, DC.
FILED 9-11-2008.

FOR COMPUTER HARDWARE, COMPUTER PERIPHERALS AND SOFTWARE FOR USE IN POINT-OF-SALE TRANSACTIONS, ONLINE SALES TRANSACTIONS AND FOR PROCESSING SUCH TRANSACTIONS; ELECTRONIC MACHINES FOR READING CREDIT, PRE-PAID, STORED VALUE AND DEBIT CARDS AND RECORDING FINANCIAL OPERATIONS; APPARATUS FOR PROCESSING POINT-OF-SALE TRANSACTIONS, NAMELY, MAGNETICALLY-ENCODED CREDIT, PRE-PAID, STORED VALUE AND DEBIT CARDS, MACHINE-READABLE BAR-CODED CREDIT, PRE-PAID, STORED VALUE AND DEBIT CARDS, ENCODED SMART CARDS CONTAINING PROGRAMMING USED FOR POINT-OF-SALE TRANSACTIONS AND FOR PROCESSING SUCH TRANSACTIONS, ELECTRONIC CARD READERS, CARD READERS FOR CREDIT, PREPAID, STORED VALUE AND DEBIT CARDS, ELECTRONIC PAYMENT TERMINALS, POINT-OF-SALE TERMINALS, AND BAR CODE READERS; MAGNETICALLY ENCODED IDENTIFYING CARDS; MAGNETICALLY-ENCODED CARDS BEARING MACHINE-READABLE INFORMATION USED TO SECURELY ACCESS PERSONAL INFORMATION, IDENTIFICATION, INFORMATION FOR USE IN EMERGENCIES, MEDICAL INFORMATION, INSURANCE POLICY DETAILS, NAMES AND CONTACT DETAILS; COMPUTER HARDWARE, COMPUTER PERIPHERALS AND SOFTWARE USED TO ACCESS A DATA REPOSITORY OF PERSONAL INFORMATION INCLUDING IDENTIFICATION, INFORMATION FOR USE IN EMERGENCIES, MEDICAL INFORMATION, INSURANCE POLICY DETAILS, NAMES AND CONTACT DETAILS; AND USER MANUALS SOLD AS A UNIT THEREWITH (U.S. CLS. 21, 23, 26, 36 AND 38).

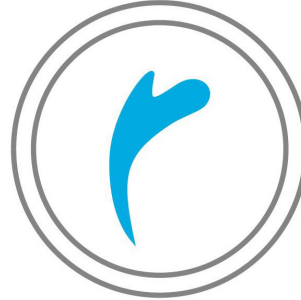

THE COLOR(S) GRAY AND BLUE IS/ARE CLAIMED AS A FEATURE OF THE MARK.

THE MARK CONSISTS OF A STYLIZED LETTER "R" IN THE COLOR BLUE AT THE CENTER OF TWO CIRCLES IN THE COLOR GRAY.

CLASS 9—ELECTRICAL AND SCIENTIFIC APPARATUS

FOR COMPUTER HARDWARE, COMPUTER PERIPHERALS AND SOFTWARE FOR USE IN POINT-OF-SALE TRANSACTIONS, ONLINE SALES TRANSACTIONS AND FOR PROCESSING SUCH TRANSACTIONS; ELECTRONIC MACHINES FOR READING CREDIT, PRE-PAID, STORED VALUE AND DEBIT CARDS AND RECORDING FINANCIAL OPERATIONS; APPARATUS FOR PROCESSING POINT-OF-SALE TRANSACTIONS, NAMELY, MAGNETICALLY-ENCODED CREDIT, PRE-PAID, STORED VALUE AND DEBIT CARDS, MACHINE-READABLE BAR-CODED CREDIT, PRE-PAID, STORED VALUE AND DEBIT CARDS, ENCODED SMART CARDS CONTAINING PROGRAMMING USED FOR POINT-OF-SALE TRANSACTIONS AND FOR PROCESSING SUCH TRANSACTIONS, ELECTRONIC CARD READERS, CARD READERS FOR CREDIT, PREPAID, STORED VALUE AND DEBIT CARDS, ELECTRONIC PAYMENT TERMINALS, POINT-OF-SALE TERMINALS, AND BAR CODE READERS; MAGNETICALLY ENCODED IDENTIFYING CARDS; MAGNETICALLY-ENCODED CARDS BEARING MACHINE-READABLE INFORMATION USED TO SECURELY ACCESS PERSONAL INFORMATION, IDENTIFICATION, INFORMATION FOR USE IN EMERGENCIES, MEDICAL INFORMATION, INSURANCE POLICY DETAILS, NAMES AND CONTACT DETAILS; COMPUTER HARDWARE, COMPUTER PERIPHERALS AND SOFTWARE USED TO ACCESS A DATA REPOSITORY OF PERSONAL INFORMATION INCLUDING IDENTIFICATION, INFORMATION FOR USE IN EMERGENCIES, MEDICAL INFORMATION, INSURANCE POLICY DETAILS, NAMES AND CONTACT DETAILS; AND USER MANUALS SOLD AS A UNIT THEREWITH (U.S. CLS. 21, 23, 26, 36 AND 38).

CLASS 36—INSURANCE AND FINANCIAL

FOR FINANCIAL SERVICES, NAMELY, CONSUMER CREDIT LENDING SERVICES, AND CREDIT, PRE-PAID, STORED VALUE AND DEBIT CARD TRANSACTION PROCESSING SERVICES; PROVIDING ELECTRONIC PROCESSING OF CREDIT, PRE-PAID, STORED VALUE AND DEBIT CARD TRANSACTIONS AND ELECTRONIC PAYMENTS VIA A GLOBAL COMPUTER NETWORK; FINANCIAL SERVICES, NAMELY, ELECTRONIC PROCESSING, VERIFICATION, AND SETTLEMENT OF SALES TRANSACTIONS USING ONLINE ACCOUNTS; CREDIT, PRE-PAID, STORED VALUE AND DEBIT CARD TRANSACTION VERIFICATION AND SETTLEMENT SERVICES, ELECTRONIC PAYMENT PROCESSING SERVICES, NAMELY, ELECTRONIC PROCESSING AND TRANSMISSION OF CREDIT, PRE-PAID, STORED VALUE AND DEBIT CARD AND ONLINE ACCOUNT PAYMENT DATA; CREDIT, PRE-PAID, STORED VALUE AND DEBIT CARD SERVICES; PROVIDING FINANCIAL INFORMATION VIA A GLOBAL COMPUTER NETWORK; AND CONSULTATION SERVICES RELATED TO THE FOREGOING (U.S. CLS. 100, 101 AND 102).

CHARLOTTE CORWIN, EXAMINING ATTORNEY

CLASS 36—INSURANCE AND FINANCIAL

FOR FINANCIAL SERVICES, NAMELY, CONSUMER CREDIT LENDING SERVICES, AND CREDIT, PRE-PAID, STORED VALUE AND DEBIT CARD TRANSACTION PROCESSING SERVICES; PROVIDING ELECTRONIC PROCESSING OF CREDIT, PRE-PAID, STORED VALUE AND DEBIT CARD TRANSACTIONS AND ELECTRONIC PAYMENTS VIA A GLOBAL COMPUTER NETWORK; FINANCIAL SERVICES, NAMELY, ELECTRONIC PROCESSING, VERIFICATION, AND SETTLEMENT OF SALES TRANSACTIONS USING ONLINE ACCOUNTS; CREDIT, PRE-PAID, STORED VALUE AND DEBIT CARD TRANSACTION VERIFICATION AND SETTLEMENT SERVICES, ELECTRONIC PAYMENT PROCESSING SERVICES, NAMELY, ELECTRONIC PROCESSING AND TRANSMISSION OF CREDIT, PRE-PAID, STORED VALUE AND DEBIT CARD AND ONLINE ACCOUNT PAYMENT DATA; CREDIT, PRE-PAID, STORED VALUE AND DEBIT CARD SERVICES; PROVIDING FINANCIAL INFORMATION VIA A GLOBAL COMPUTER NETWORK; AND CONSULTATION SERVICES RELATED TO THE FOREGOING (U.S. CLS. 100, 101 AND 102).

CHARLOTTE CORWIN, EXAMINING ATTORNEY

SN 77-567,674. PARAZUL, LLC, WILMINGTON, DE. FILED 9-11-2008.



SN 77-567,648. SCHWARTZ, JANE A, RANCHO SANTA MARGARITA, CA. FILED 9-11-2008.



NO CLAIM IS MADE TO THE EXCLUSIVE RIGHT TO USE "BABY", APART FROM THE MARK AS SHOWN.

THE COLOR(S) LIGHT BLUE, WHITE, ORANGE, YELLOW, VIOLET, BLACK IS/ARE CLAIMED AS A FEATURE OF THE MARK.

THE MARK CONSISTS OF A BEE OUTLINED IN BLACK WITH ORANGE AND YELLOW MARKINGS ON ITS BODY, VIOLET AND BLUE TINGED WINGS, EYES CLOSED, BLACK LASHES, BLACK ANTENNA ON A WHITE BACKGROUND AND WITH BLACK STYLIZED LETTERING BELOW SPELLING "JELLIBEE BABY", AND LIGHT BLUE BORDER AROUND THE ENTIRE IMAGE.

CLASS 3—COSMETICS AND CLEANING PREPARATIONS

FOR BABY WIPES (U.S. CLS. 1, 4, 6, 50, 51 AND 52).

CLASS 25—CLOTHING

FOR BABY BIBS NOT OF PAPER; BABY BODYSUITS; BABY BOTTOMS; BABY BUNTING; BABY TOPS; CHILDREN'S AND INFANTS' CLOTH BIBS; PLASTIC BABY BIBS (U.S. CLS. 22 AND 39).

JOHN E. MICHOS, EXAMINING ATTORNEY

THE MARK CONSISTS OF THE LETTER "P" INSIDE A CIRCLE INSIDE ANOTHER CIRCLE WITH 8 POINTS INSIDE ANOTHER CIRCLE.

CLASS 3—COSMETICS AND CLEANING PREPARATIONS

FOR PERFUME (U.S. CLS. 1, 4, 6, 50, 51 AND 52).

CLASS 6—METAL GOODS

FOR PURSE-HANGING HOOK OF METAL (U.S. CLS. 2, 12, 13, 14, 23, 25 AND 50).

CLASS 9—ELECTRICAL AND SCIENTIFIC APPARATUS

FOR SUNGLASSES (U.S. CLS. 21, 23, 26, 36 AND 38).

CLASS 14—JEWELRY

FOR JEWELRY AND CUFFLINKS (U.S. CLS. 2, 27, 28 AND 50).

CLASS 18—LEATHER GOODS

FOR BEACH BAGS, HANDBAGS, LUGGAGE, LUGGAGE TAGS, UMBRELLAS, AND WALLETS (U.S. CLS. 1, 2, 3, 22 AND 41).

CLASS 24—FABRICS

FOR BEACH TOWELS (U.S. CLS. 42 AND 50).

CLASS 25—CLOTHING

FOR CLOTHING, NAMELY, TIES, SHOES, SCARVES, BELTS, AND HATS (U.S. CLS. 22 AND 39).

CAROLYN GRAY, EXAMINING ATTORNEY

SN 77-567,682. THE MOUNTAIN CORPORATION, KEENE, NH. FILED 9-11-2008.

LIFE IS WINE

THE MARK CONSISTS OF STANDARD CHARACTERS WITHOUT CLAIM TO ANY PARTICULAR FONT, STYLE, SIZE, OR COLOR.

CLASS 21—HOUSEWARES AND GLASS

FOR CUPS AND MUGS (U.S. CLS. 2, 13, 23, 29, 30, 33, 40 AND 50).

CLASS 25—CLOTHING

FOR HEADGEAR, NAMELY, HATS AND CAPS; JACKETS; POLO SHIRTS; RUGBY SHIRTS; SHORT-SLEEVED OR LONG-SLEEVED T-SHIRTS; SPORTS SHIRTS; SWEAT SHIRTS (U.S. CLS. 22 AND 39).

EDWARD NELSON, EXAMINING ATTORNEY

SN 77-567,848. VAL-MATIC VALVE AND MANUFACTURING CORPORATION, ELMHURST, IL. FILED 9-11-2008.

FLOTROL

THE MARK CONSISTS OF STANDARD CHARACTERS WITHOUT CLAIM TO ANY PARTICULAR FONT, STYLE, SIZE, OR COLOR.

CLASS 7—MACHINERY

FOR PNEUMATIC VALVE ACTUATORS; HYDRAULIC VALVE ACTUATORS (U.S. CLS. 13, 19, 21, 23, 31, 34 AND 35).

CLASS 9—ELECTRICAL AND SCIENTIFIC APPARATUS

FOR ELECTRIC VALVE ACTUATORS (U.S. CLS. 21, 23, 26, 36 AND 38).

MARY CRAWFORD, EXAMINING ATTORNEY

SN 77-567,866. BLAYCHON PRODUCTS, LLC, FORT COLLINS, CO. FILED 9-11-2008.

Blaychon

THE MARK CONSISTS OF STANDARD CHARACTERS WITHOUT CLAIM TO ANY PARTICULAR FONT, STYLE, SIZE, OR COLOR.

CLASS 14—JEWELRY

FOR JEWELRY BOXES NOT OF METAL (U.S. CLS. 2, 27, 28 AND 50).
FIRST USE 1-3-2003; IN COMMERCE 6-2-2005.

CLASS 28—TOYS AND SPORTING GOODS

FOR PLUSH TOYS (U.S. CLS. 22, 23, 38 AND 50).
FIRST USE 1-3-2003; IN COMMERCE 1-15-2006.

CLASS 41—EDUCATION AND ENTERTAINMENT

FOR ENTERTAINMENT SERVICES, NAMELY, PROVIDING ON-LINE COMPUTER GAMES (U.S. CLS. 100, 101 AND 107).

FIRST USE 1-1-2003; IN COMMERCE 8-10-2008.
SUSAN STIGLITZ, EXAMINING ATTORNEY

SN 77-567,869. VAL-MATIC VALVE AND MANUFACTURING CORPORATION, ELMHURST, IL. FILED 9-11-2008.

MEGA-TROL

THE MARK CONSISTS OF STANDARD CHARACTERS WITHOUT CLAIM TO ANY PARTICULAR FONT, STYLE, SIZE, OR COLOR.

CLASS 7—MACHINERY

FOR PNEUMATIC VALVE ACTUATORS; HYDRAULIC VALVE ACTUATORS (U.S. CLS. 13, 19, 21, 23, 31, 34 AND 35).

CLASS 9—ELECTRICAL AND SCIENTIFIC APPARATUS

FOR ELECTRIC VALVE ACTUATORS (U.S. CLS. 21, 23, 26, 36 AND 38).

MARY CRAWFORD, EXAMINING ATTORNEY

SN 77-567,900. MORTGAGE INDUSTRY ADVISORY CORPORATION, NEW YORK, NY. FILED 9-11-2008.

MarketShield

THE MARK CONSISTS OF STANDARD CHARACTERS WITHOUT CLAIM TO ANY PARTICULAR FONT, STYLE, SIZE, OR COLOR.

CLASS 9—ELECTRICAL AND SCIENTIFIC APPARATUS

FOR COMPUTER SOFTWARE FOR SECONDARY MORTGAGE ANALYSIS (U.S. CLS. 21, 23, 26, 36 AND 38).

FIRST USE 5-13-1998; IN COMMERCE 5-13-1998.

CLASS 35—ADVERTISING AND BUSINESS

FOR ANALYZING AND COMPILING DATA FOR MEASURING THE PERFORMANCE OF FINANCIAL MARKETS; PREPARING FINANCIAL REPORTS FOR OTHERS; PROVIDING STATISTICAL INFORMATION AND INDEXES OF MORTGAGES, INTERESTS, AND PRICES FOR OTHERS (U.S. CLS. 100, 101 AND 102).

FIRST USE 5-13-1998; IN COMMERCE 5-13-1998.
ARETHA SOMERVILLE, EXAMINING ATTORNEY

CLASS 42—SCIENTIFIC AND COMPUTER SERVICES

FOR APPLICATION SERVICE PROVIDER, NAMELY, PROVIDING HOSTING, MANAGING, DEVELOPING, AND MAINTAINING INTERACTIVE COMMUNICATION APPLICATIONS, SOFTWARE, WEB SITES, AND DATABASES IN THE FIELDS OF PERSONAL PRODUCTIVITY, WIRELESS COMMUNICATION, MOBILE INFORMATION ACCESS, AND REMOTE DATA MANAGEMENT FOR WIRELESS DELIVERY OF CONTENT TO HANDHELD COMPUTERS, LAPTOPS, AND MOBILE ELECTRONIC DEVICES (U.S. CLS. 100 AND 101).

GILBERT SWIFT, EXAMINING ATTORNEY

SN 77-567,971. GREIF & CO., LOS ANGELES, CA. FILED 9-11-2008.

DETERMINED. AGGRESSIVE.
RELENTLESS.

SN 77-568,041. LEMUR INTERNATIONAL INC., RICHMOND, CA. FILED 9-11-2008.

THE MARK CONSISTS OF STANDARD CHARACTERS WITHOUT CLAIM TO ANY PARTICULAR FONT, STYLE, SIZE, OR COLOR.

CLASS 35—ADVERTISING AND BUSINESS

FOR BUSINESS ACQUISITION AND MERGER CONSULTATION (U.S. CLS. 100, 101 AND 102).

FIRST USE 2-26-2007; IN COMMERCE 2-26-2007.

CLASS 36—INSURANCE AND FINANCIAL

FOR FINANCIAL MANAGEMENT, BANKING SERVICES, INVESTMENT BROKERAGE, CORPORATE FINANCING AND FINANCIAL ANALYSIS AND CONSULTATION (U.S. CLS. 100, 101 AND 102).

FIRST USE 2-26-2007; IN COMMERCE 2-26-2007.
MARTHA SANTOMARTINO, EXAMINING ATTORNEY



SN 77-568,027. CONDUCTOR GLOBAL CORPORATION, DEER PARK, NY. FILED 9-11-2008.

THE COLOR(S) RED IS/ARE CLAIMED AS A FEATURE OF THE MARK.

THE MARK CONSISTS OF SWIRL OF OVERLAPPING CIRCULAR LINES WITH A VANILLA FLOWER IN THE CENTER.

Skoop

CLASS 3—COSMETICS AND CLEANING PREPARATIONS

FOR COSMETIC OILS; COSMETICS; ESSENTIAL OILS; ESSENTIAL OILS FOR USE IN THE MANUFACTURE OF SCENTED PRODUCTS (U.S. CLS. 1, 4, 6, 50, 51 AND 52).

CLASS 30—STAPLE FOODS

FOR BAKING SPICES; CINNAMON; CINNAMON POWDER; CRYSTALLIZED GINGER; EDIBLE SPICES; EXTRACTS USED AS FLAVORING; FLAVOURINGS FOR FOODS; FOOD SEASONINGS; GINGER; GINGER PASTE FOR USE AS A SEASONING; NUTMEG; PEPPER; PEPPER POWDER; PEPPER SPICE; SEASONINGS; SPICE RUBS; SPICES; VANILLA (U.S. CL. 46).

FIRST USE 3-1-2008; IN COMMERCE 3-1-2008.
KEVON CHISOLM, EXAMINING ATTORNEY

THE MARK CONSISTS OF STANDARD CHARACTERS WITHOUT CLAIM TO ANY PARTICULAR FONT, STYLE, SIZE, OR COLOR.

CLASS 38—COMMUNICATION

FOR PROVIDING E-MAIL AND INSTANT MESSAGING SERVICES (U.S. CLS. 100, 101 AND 104).

SN 77-568,229. PLUSHY FEELY CORP., SAN ANSELMO, CA.
FILED 9-11-2008.

KOKORO

THE MARK CONSISTS OF STANDARD CHARACTERS WITHOUT CLAIM TO ANY PARTICULAR FONT, STYLE, SIZE, OR COLOR.

THE FOREIGN WORDING IN THE MARK TRANSLATES INTO ENGLISH AS HEART OF THINGS.

CLASS 9—ELECTRICAL AND SCIENTIFIC APPARATUS

FOR DOWNLOADABLE MULTIMEDIA FILE CONTAINING ARTWORK, TEXT, AUDIO, VIDEO, GAMES, AND INTERNET WEB LINKS RELATING TO FEELINGS AND EMOTIONS; DOWNLOADABLE RING TONES, GRAPHICS AND MUSIC VIA A GLOBAL COMPUTER NETWORK AND WIRELESS DEVICES; ELECTRONIC GAME SOFTWARE FOR WIRELESS DEVICES (U.S. CLS. 21, 23, 26, 36 AND 38).

CLASS 28—TOYS AND SPORTING GOODS

FOR ELECTRONIC LEARNING TOYS; PLASTIC CHARACTER TOYS (U.S. CLS. 22, 23, 38 AND 50).
ESTHER BELENKER, EXAMINING ATTORNEY

SN 77-568,317. EAGLEVISIONS, ST. LOUIS PARK, MN.
FILED 9-11-2008.



THE MARK CONSISTS OF THE ARCHED WORD "EAGLEVISIONS" OVER A STYLIZED EYEBROW AND EYE WITH AN EAGLE AS THE IRIS AND PUPIL.

CLASS 35—ADVERTISING AND BUSINESS

FOR ASSISTANCE, ADVISORY SERVICES AND CONSULTANCY WITH REGARD TO BUSINESS PLANNING, BUSINESS ANALYSIS, BUSINESS MANAGEMENT, AND BUSINESS ORGANIZATION RELATING TO MICRO CREDITS, MICRO FINANCE AND ENERGY PRODUCTS; BUSINESS VENTURE DEVELOPMENT AND FORMATION CONSULTING SERVICES FOR THE RENEWABLE ENERGY INDUSTRY; CONSULTATION IN THE FIELD OF ENERGY EFFICIENCY; ENERGY AUDITING; ENERGY MANAGEMENT SERVICES, NAMELY, PROVIDING A SERVICE THAT ALLOWS CUSTOMERS TO PURCHASE ENERGY, NAMELY, ELECTRICITY, NATURAL GAS AND RENEWABLE ENERGY, AT A FIXED PRICE; ENERGY PRICE COMPARISON SERVICES; ENERGY USAGE MANAGEMENT; ENERGY USAGE MANAGEMENT INFORMATION SERVICES; INFORMATION IN THE FIELD OF ENERGY EFFICIENCY; PROMOTING THE BENEFITS OF ENERGY EFFICIENT LIGHTING TECHNOLOGIES TO PROFESSIONALS IN THE LIGHTING FIELD; UTILITY BILL MANAGEMENT SERVICES, NAMELY, TRACKING, REPORTING, ANALYZING AND DELIVERING ENERGY INFORMATION IN THE FORM OF UTILITY BILLS AND UTILITY METER DATA RATE SCHEDULES (U.S. CLS. 100, 101 AND 102).

CLASS 36—INSURANCE AND FINANCIAL

FOR BROKERAGE OF ENERGY, NAMELY, GAS AND ELECTRICITY; CONSULTANCY CONCERNING FINANCING OF ENERGY PROJECTS; ENERGY BROKERAGE SERVICES; FINANCIAL ADVISORY AND CONSULTANCY SERVICES RELATING TO MICRO CREDITS, MICRO FINANCE AND ENERGY PRODUCTS (U.S. CLS. 100, 101 AND 102).

ROBERT LAVACHE, EXAMINING ATTORNEY

SN 77-568,371. FRITO-LAY NORTH AMERICA, INC., PLANO, TX. FILED 9-12-2008.

3D'S

THE MARK CONSISTS OF STANDARD CHARACTERS WITHOUT CLAIM TO ANY PARTICULAR FONT, STYLE, SIZE, OR COLOR.

OWNER OF U.S. REG. NOS. 2,511,845, 2,678,988 AND OTHERS.

CLASS 29—MEATS AND PROCESSED FOODS

FOR POTATO CHIPS; POTATO CRISPS; POTATO-BASED SNACK FOODS (U.S. CL. 46).

CLASS 30—STAPLE FOODS

FOR CORN CHIPS; CORN-BASED SNACK FOODS; TORTILLAS (U.S. CL. 46).

SANJEEV VOHRA, EXAMINING ATTORNEY

SN 77-568,469. SPEEDREADING PEOPLE, LLC, HARTFORD, CT. FILED 9-12-2008.

SN 77-569,637. SIGH YOGA, MINNEAPOLIS, MN. FILED 9-15-2008.

SPEEDREACHING PEOPLE

THE MARK CONSISTS OF STANDARD CHARACTERS WITHOUT CLAIM TO ANY PARTICULAR FONT, STYLE, SIZE, OR COLOR.

OWNER OF U.S. REG. NO. 2,177,192.

CLASS 9—ELECTRICAL AND SCIENTIFIC APPARATUS

FOR PRE-RECORDED AUDIO AND VIDEO TRAINING TAPES AND DVDS IN THE FIELD OF PERSONALITY-TYPE ANALYSIS (U.S. CLS. 21, 23, 26, 36 AND 38).

CLASS 16—PAPER GOODS AND PRINTED MATTER

FOR WORKBOOKS AND TRAINING GUIDES COMPRISING EDUCATIONAL MATERIALS IN THE FIELD OF PERSONALITY-TYPE ANALYSIS (U.S. CLS. 2, 5, 22, 23, 29, 37, 38 AND 50).

CLASS 41—EDUCATION AND ENTERTAINMENT

FOR EDUCATIONAL SERVICES, NAMELY, CONDUCTING WORKSHOPS AND INDIVIDUAL TRAINING IN THE FIELD OF PERSONALITY-TYPE ANALYSIS AND DISTRIBUTING COURSE MATERIALS IN CONNECTION THEREWITH; ONLINE TRAINING TUTORIALS IN THE FIELD OF PERSONALITY-TYPE ANALYSIS (U.S. CLS. 100, 101 AND 107).

HAI-LY LAM, EXAMINING ATTORNEY

SN 77-569,018. MCCAIN FOODS USA, INC., LISLE, IL. FILED 9-12-2008.

BETTER FOR YOU HAS NEVER
TASTED SO GREAT.

THE MARK CONSISTS OF STANDARD CHARACTERS WITHOUT CLAIM TO ANY PARTICULAR FONT, STYLE, SIZE, OR COLOR.

CLASS 29—MEATS AND PROCESSED FOODS

FOR PREPARED APPETIZERS CONSISTING PRIMARILY OF MEAT, POULTRY, VEGETABLES, FRUITS AND/OR CHEESE; PROCESSED POTATOES; PROCESSED VEGETABLES (U.S. CL. 46).

CLASS 30—STAPLE FOODS

FOR PREPARED FOODS CONSISTING OF A DOUGH EXTERIOR FILLED WITH MEAT, POULTRY, VEGETABLES, CHEESE, FRUIT AND/OR SAUCE; BAKERY PRODUCTS AND BAKERY DESSERTS (U.S. CL. 46).

JAMES A. RAUEN, EXAMINING ATTORNEY



THE MARK CONSISTS OF A FLOWER ALONG SIDE THE TEXT "SIGH".

CLASS 25—CLOTHING

FOR HEADBANDS (U.S. CLS. 22 AND 39).

CLASS 41—EDUCATION AND ENTERTAINMENT

FOR YOGA INSTRUCTION (U.S. CLS. 100, 101 AND 107).

STEPHEN AQUILA, EXAMINING ATTORNEY

SN 77-570,361. WALTER PYLYPIAK, TRENTON, NJ. FILED 9-15-2008.



THE MARK CONSISTS OF A WINGED BIRD CARRYING A GEMSTONE IN ITS CLAWS WITH FLAMES SURROUNDING THE GEMSTONE AND THE LETTERS "JE" FOLLOWED BY A TILDE, FOLLOWED BY THE LETTERS "IS" FOLLOWED BY A TILDE, FOLLOWED BY THE LETTERS "US" BELOW THE BIRD'S LEFT WING.

CLASS 14—JEWELRY

FOR JEWELRY (U.S. CLS. 2, 27, 28 AND 50).

CLASS 25—CLOTHING

FOR WEARABLE GARMENTS AND CLOTHING, NAMELY, SHIRTS, T-SHIRTS, TOPS, TIES, BELTS, HATS, CAPS, PANTS, SHORTS, PAJAMAS, SHOES AND SNEAKERS (U.S. CLS. 22 AND 39).

JEFF DEFORD, EXAMINING ATTORNEY

SN 77-572,445. OUI THE CORPORATION, ATLANTA, GA. FILED 9-17-2008.

Just watch what Oui do next

THE MARK CONSISTS OF STANDARD CHARACTERS WITHOUT CLAIM TO ANY PARTICULAR FONT, STYLE, SIZE, OR COLOR.

THE ENGLISH TRANSLATION OF THE WORD "OUI" IN THE MARK IS "YES".

CLASS 9—ELECTRICAL AND SCIENTIFIC APPARATUS

FOR COMPUTERS; DESKTOP COMPUTERS; NOTE-BOOK COMPUTERS; LAPTOP COMPUTERS; PORTABLE COMPUTERS; HANDHELD COMPUTERS; PERSONAL DIGITAL ASSISTANTS (PDAS); ELECTRONIC PERSONAL ORGANIZERS; ELECTRONIC NOTEPADS, NAMELY, POCKET COMPUTERS FOR NOTE-TAKING; MOBILE TELEPHONES; SMART PHONES; DIGITAL CAMERAS; DIGITAL AUDIO RECORDERS, DIGITAL AUDIO PLAYBACK DEVICES, MP3 PLAYERS AND MP4 PLAYERS; HANDHELD CARRYING CASES, KEYBOARDS, MONITORS, MOUSE, PRINTERS, SCANNERS, FACSIMILE DEVICES, REMOTE CONTROL DEVICES, DOCKING STATIONS, BATTERY CHARGERS, SPEAKERS, HEADPHONES, CABLES AND CONNECTORS, ALL FOR USE WITH COMPUTERS; COMPUTER SOFTWARE FOR USE IN ORGANIZING, TRANSMITTING, MANIPULATING, AND REVIEWING TEXT, DATA, AND AUDIO FILES ON A PORTABLE AND HANDHELD DIGITAL ELECTRONIC DEVICE; AND SMART PHONES ADAPTED FOR WEAR ON THE WRIST AND FEATURING A WATCH FUNCTION, SOFTWARE AND HARDWARE FOR USE IN SENDING AND RECEIVING TELEPHONE CALLS, ELECTRONIC MAIL, AND OTHER DIGITAL DATA, AND FOR USE IN ACCESSING, BROWSING AND SEARCHING THE INTERNET, A DIGITAL FORMAT AUDIO PLAYER, A HANDHELD COMPUTER, A PERSONAL DIGITAL ASSISTANT, AN ELECTRONIC PERSONAL ORGANIZER, AN ELECTRONIC NOTEPAD, AND A CAMERA (U.S. CLS. 21, 23, 26, 36 AND 38).

CLASS 14—JEWELRY

FOR WATCHES (U.S. CLS. 2, 27, 28 AND 50). MARTHA FROMM, EXAMINING ATTORNEY

SN 77-572,582. THE DANNON COMPANY, INC., WHITE PLAINS, NY. FILED 9-17-2008.

DANNON, TODAY IS TOMORROW

THE MARK CONSISTS OF STANDARD CHARACTERS WITHOUT CLAIM TO ANY PARTICULAR FONT, STYLE, SIZE, OR COLOR.

OWNER OF U.S. REG. NOS. 1,265,165, 2,027,744 AND 3,412,771.

CLASS 16—PAPER GOODS AND PRINTED MATTER

FOR PUBLICATIONS, NAMELY, BOOKS, JOURNALS, BROCHURES AND NEWSLETTERS PERTAINING TO THE FIELD OF NUTRITION AND HEALTH (U.S. CLS. 2, 5, 22, 23, 29, 37, 38 AND 50).

CLASS 25—CLOTHING

FOR CLOTHING, NAMELY, T-SHIRTS, SHIRTS, TOPS, SHORTS, PANTS, SKIRTS, SWEATPANTS, SWEAT SHIRTS, JACKETS, COATS, DRESSES, BLAZERS, VESTS, HEADWEAR, WRIST BANDS, SOCKS, FOOTWEAR (U.S. CLS. 22 AND 39).

CLASS 29—MEATS AND PROCESSED FOODS

FOR YOGURT, YOGURT-BASED BEVERAGES; DAIRY-BASED SNACK FOODS EXCLUDING ICE CREAM, ICE MILK AND FROZEN YOGURT; DAIRY-BASED BEVERAGES; DAIRY PRODUCTS EXCLUDING ICE CREAM, ICE MILK AND FROZEN YOGURT (U.S. CL. 46).

CLASS 32—LIGHT BEVERAGES

FOR FRUIT JUICES AND FRUIT DRINKS; FRUIT-BASED BEVERAGES WITH YOGURT; SMOOTHIES; SOFT DRINKS (U.S. CLS. 45, 46 AND 48). WENDY GOODMAN, EXAMINING ATTORNEY

SN 77-572,588. THE DANNON COMPANY, INC., WHITE PLAINS, NY. FILED 9-17-2008.

TODAY IS TOMORROW

THE MARK CONSISTS OF STANDARD CHARACTERS WITHOUT CLAIM TO ANY PARTICULAR FONT, STYLE, SIZE, OR COLOR.

CLASS 16—PAPER GOODS AND PRINTED MATTER

FOR PUBLICATIONS, NAMELY, BOOKS, JOURNALS, BROCHURES AND NEWSLETTERS PERTAINING TO THE FIELD OF NUTRITION AND HEALTH (U.S. CLS. 2, 5, 22, 23, 29, 37, 38 AND 50).

CLASS 25—CLOTHING

FOR CLOTHING, NAMELY, T-SHIRTS, SHIRTS, TOPS, SHORTS, PANTS, SKIRTS, SWEATPANTS, SWEAT SHIRTS, JACKETS, COATS, DRESSES, BLAZERS, VESTS, HEADWEAR, WRIST BANDS, SOCKS, FOOTWEAR (U.S. CLS. 22 AND 39).

CLASS 29—MEATS AND PROCESSED FOODS

FOR YOGURT, YOGURT-BASED BEVERAGES; DAIRY-BASED SNACK FOODS EXCLUDING ICE CREAM, ICE MILK AND FROZEN YOGURT; DAIRY-BASED BEVERAGES; DAIRY PRODUCTS EXCLUDING ICE CREAM, ICE MILK AND FROZEN YOGURT (U.S. CL. 46).

CLASS 32—LIGHT BEVERAGES

FOR FRUIT JUICES AND FRUIT DRINKS; FRUIT-BASED BEVERAGES WITH YOGURT; SMOOTHIES; SOFT DRINKS (U.S. CLS. 45, 46 AND 48).

WENDY GOODMAN, EXAMINING ATTORNEY

SN 77-573,599. BARNEY'S, INC., NEW YORK, NY. FILED 9-18-2008.

SN 77-572,896. ARKEMA FRANCE, 92700 COLOMBES, FRANCE, FILED 9-18-2008.

ODORFLEX

THE MARK CONSISTS OF STANDARD CHARACTERS WITHOUT CLAIM TO ANY PARTICULAR FONT, STYLE, SIZE, OR COLOR.

CLASS 37—CONSTRUCTION AND REPAIR

FOR SERVICING OF ODORIZING EQUIPMENT (U.S. CLS. 100, 103 AND 106).

CLASS 39—TRANSPORTATION AND STORAGE

FOR DELIVERY OF ODORANTS (U.S. CLS. 100 AND 105).

RONALD AIKENS, EXAMINING ATTORNEY

SN 77-573,037. UNIVERSAL MINERALS INTERNATIONAL, INC., TUCSON, AZ. FILED 9-18-2008.

ShieldDoor

THE MARK CONSISTS OF STANDARD CHARACTERS WITHOUT CLAIM TO ANY PARTICULAR FONT, STYLE, SIZE, OR COLOR.

CLASS 6—METAL GOODS

FOR DOOR CASINGS OF METAL; DOOR FRAMES OF METAL; DOOR PANELS OF METAL; DOORS AND WINDOWS OF METAL; DOORS OF METAL; DOORS OF METAL FOR INDOOR USE; METAL DOOR FRAMES; METAL DOOR PANELS; METAL DOOR UNITS; METAL DOORS; METAL SAFETY DOORS; METAL SLIDING DOORS; METALLIC DOORS, WINDOWS, SHUTTERS, SLATTED SHUTTERS; METALLIC FRAMES FOR SLIDING DOORS; REVOLVING DOORS OF METAL (U.S. CLS. 2, 12, 13, 14, 23, 25 AND 50).

CLASS 9—ELECTRICAL AND SCIENTIFIC APPARATUS

FOR SECURITY PRODUCTS, NAMELY, ENTRY DOOR SYSTEMS COMPRISING TOUCH PADS AND SECURITY DOORS (U.S. CLS. 21, 23, 26, 36 AND 38).

TRACY FLETCHER, EXAMINING ATTORNEY

CO-OP BARNEYS NEW YORK

THE MARK CONSISTS OF STANDARD CHARACTERS WITHOUT CLAIM TO ANY PARTICULAR FONT, STYLE, SIZE, OR COLOR.

OWNER OF U.S. REG. NOS. 2,766,664, 2,802,702 AND 2,847,733.

SEC. 2(F) AS TO NEW YORK.

CLASS 3—COSMETICS AND CLEANING PREPARATIONS

FOR COSMETICS, NAMELY, SKIN CLEANING AND MOISTURIZING CREAMS AND LOTIONS; FRESHENERS FOR THE SKIN, NAMELY, LIQUIDS, LOTIONS AND GELS FOR FRESHENING THE SKIN; FACIAL MASQUES AND PEELS; ASTRINGENT LOTIONS FOR COSMETIC USE; LIQUID AND POWDERED MAKEUP FOUNDATIONS; BLUSHERS AND ROUGE; BLEMISHING CONCEALING CREAMS; LIPSTICKS, LIP GLOSS, LIP LINERS AND LIP MOISTURIZERS; EYE SHADOWS, EYELINERS, MASCARA; PERSONAL DEODORANTS; BATH POWDER; COLOGNE, TOILET WATER AND PERFUME; NAIL POLISHES AND NAIL POLISH REMOVER; BATH OILS, BATH SOAPS AND BODY WASHES; HAIR CARE PRODUCTS, NAMELY, SHAMPOO, CONDITIONERS, STYLING MOUSSE AND GELS, AND HAIR SPRAY; SUNTAN LOTIONS AND BRONZING GELS; PETROLEUM JELLY FOR COSMETIC USE; COTTON BALLS AND COTTON SWABS FOR COSMETIC USE (U.S. CLS. 1, 4, 6, 50, 51 AND 52).

CLASS 18—LEATHER GOODS

FOR WALLETS, HANDBAGS, FANNY PACKS, ATTACHE CASES, BACKPACKS, PORTFOLIO CASES AND UMBRELLA (U.S. CLS. 1, 2, 3, 22 AND 41).

CLASS 25—CLOTHING

FOR WOMEN'S CLOTHING, NAMELY, JACKETS COATS, BLAZERS, VESTS, SWEATERS, SWEAT SHIRTS, SWEAT PANTS; SUITS; SLACKS, PANTS, SHORTS, JUMPSUITS; BLOUSES, SHIRTS, T-SHIRTS, POLO SHIRTS; DRESSES, SKIRTS, SKORTS AND CULOTTES; SLEEPWEAR, NAMELY, PAJAMAS, NIGHTGOWNS, NIGHTSHIRTS AND ROBES; LINGERIE; UNDERWEAR, SWIMWEAR; SHOES, SANDALS, BOOTS, AND SLIPPERS; SOCKS, TIGHTS, STOCKINGS; GLOVES, HATS, CAPS, BELTS AND SCARVES; MEN'S CLOTHING, NAMELY, SUITS, RAINCOATS, TUXEDOS, SPORT COATS, SWEATSHIRTS, VESTS; SLACKS, DRESS SHIRTS, UNDERWEAR, PAJAMAS, NIGHTSHIRTS, ROBES, TIES AND SCARVES; SOCKS (U.S. CLS. 22 AND 39).

HEATHER SAPP, EXAMINING ATTORNEY

SN 77-573,849. BLACK RAVEN ENERGY, DENVER, CO. FILED 9-18-2008.



**BLACK RAVEN
ENERGY**

NO CLAIM IS MADE TO THE EXCLUSIVE RIGHT TO USE "ENERGY", APART FROM THE MARK AS SHOWN.
THE COLOR(S) BLACK, GREY AND RED IS/ARE CLAIMED AS A FEATURE OF THE MARK.
THE MARK CONSISTS OF A BLACK RAVEN WITH A GREY BEAK AND FEET, AND A RED EYE, ABOVE THE WORDING "BLACK RAVEN ENERGY" IN BLACK.

CLASS 4—LUBRICANTS AND FUELS
FOR CRUDE OIL; NATURAL GAS (U.S. CLS. 1, 6 AND 15).

CLASS 40—MATERIAL TREATMENT
FOR GAS PRODUCTION SERVICES; OIL PRODUCTION SERVICES (U.S. CLS. 100, 103 AND 106).

CLASS 42—SCIENTIFIC AND COMPUTER SERVICES
FOR EXPLORATION AND SEARCHING OF OIL AND GAS (U.S. CLS. 100 AND 101).
SHANNON TWOHIG, EXAMINING ATTORNEY

SN 77-574,811. PREFAST CONCRETE WALL SYSTEMS, INC., SAN MATEO, CA. FILED 9-19-2008.



OWNER OF U.S. REG. NO. 2,351,716.
NO CLAIM IS MADE TO THE EXCLUSIVE RIGHT TO USE "BUILDINGS", APART FROM THE MARK AS SHOWN.
THE MARK CONSISTS OF A BUILDING, SHOWN IN PERSPECTIVE. THE WORD "PREFAST" APPEARS INSIDE A RECTANGLE CARRIER WHICH IS PLACED ON THE BUILDING. THE WORDS "PLANTCRAFTED BUILDINGS" APPEAR CENTERED ACROSS THE FRONT OF THE DESIGN OF THE BUILDING.

CLASS 19—NON-METALLIC BUILDING MATERIALS
FOR CONCRETE BUILDING PANELS; PREFABRICATED, PRIMARILY NON-METAL BUILDINGS (U.S. CLS. 1, 12, 33 AND 50).

CLASS 37—CONSTRUCTION AND REPAIR
FOR INTALLATION OF MODULAR BUILDINGS; CONSTRUCTION OF BUILDINGS (U.S. CLS. 100, 103 AND 106).

CLASS 40—MATERIAL TREATMENT
FOR CUSTOM FABRICATION OF MODULAR BUILDINGS (U.S. CLS. 100, 103 AND 106).

CLASS 42—SCIENTIFIC AND COMPUTER SERVICES
FOR ARCHITECTURAL DESIGN (U.S. CLS. 100 AND 101).
SAIMA MAKHDOOM, EXAMINING ATTORNEY

SN 77-574,879. WARREN, CHRISTIAN, OCOEE, FL. FILED 9-19-2008.

DO YOU OWN YOUR TIME

THE MARK CONSISTS OF STANDARD CHARACTERS WITHOUT CLAIM TO ANY PARTICULAR FONT, STYLE, SIZE, OR COLOR.

CLASS 35—ADVERTISING AND BUSINESS
FOR BUSINESS MANAGEMENT CONSULTATION SERVICES IN THE FIELD OF EXECUTIVE AND LEADERSHIP DEVELOPMENT; BUSINESS ADVICE, ADVERTISING, MARKETING, AND ONLINE MARKETING IN THE FIELD OF ECOMMERCE (U.S. CLS. 100, 101 AND 102).
FIRST USE 10-5-2006; IN COMMERCE 1-1-2007.

CLASS 45—PERSONAL AND LEGAL SERVICES
FOR PROVIDING ON-LINE INFORMATION IN THE FIELD OF SPIRITUALITY, SELF-HELP, AND PERSONAL EMPOWERMENT SUBJECT MATTERS AS WELL AS PERSONAL GROWTH AND MOTIVATION CONSULTING SERVICES (U.S. CLS. 100 AND 101).
FIRST USE 10-5-2006; IN COMMERCE 1-1-2007.
GINA FINK, EXAMINING ATTORNEY

SN 77-577,067. PELLHAM, BRIAN L., DBA KHEPER GAMES, INC., SEATTLE, WA. FILED 9-23-2008.

SN 77-577,211. SHRYK, LLC, EDMOND, OK. FILED 9-23-2008.

Guilty Pleasures

THE MARK CONSISTS OF STANDARD CHARACTERS WITHOUT CLAIM TO ANY PARTICULAR FONT, STYLE, SIZE, OR COLOR.

CLASS 28—TOYS AND SPORTING GOODS

FOR TRIVIA GAME PLAYED WITH CARDS AND GAME COMPONENTS (U.S. CLS. 22, 23, 38 AND 50).

CLASS 41—EDUCATION AND ENTERTAINMENT

FOR ENTERTAINMENT SERVICES IN THE NATURE OF AN ON-GOING REALITY BASED TELEVISION PROGRAM (U.S. CLS. 100, 101 AND 107).

MARIAM MAHMOUDI, EXAMINING ATTORNEY

SN 77-577,210. SHRYK, LLC, EDMOND, OK. FILED 9-23-2008.

WEPROSPER

THE MARK CONSISTS OF STANDARD CHARACTERS WITHOUT CLAIM TO ANY PARTICULAR FONT, STYLE, SIZE, OR COLOR.

CLASS 36—INSURANCE AND FINANCIAL

FOR FINANCIAL INFORMATION AND ADVISORY SERVICES (U.S. CLS. 100, 101 AND 102).

CLASS 38—COMMUNICATION

FOR PROVIDING ON-LINE CHAT ROOMS AND ELECTRONIC BULLETIN BOARDS FOR TRANSMISSION OF MESSAGES AMONG USERS IN THE FIELD OF FINANCE AND ACCOUNTING (U.S. CLS. 100, 101 AND 104).

CLASS 42—SCIENTIFIC AND COMPUTER SERVICES

FOR PROVIDING TEMPORARY USE OF NON-DOWNLOADABLE SOFTWARE FOR OTHERS TO CREATE AND ACCESS BANK ACCOUNT INFORMATION AND PERFORM BANK TRANSACTIONS (U.S. CLS. 100 AND 101).

DEZMONA MIZELLE, EXAMINING ATTORNEY

SHRYK

THE MARK CONSISTS OF STANDARD CHARACTERS WITHOUT CLAIM TO ANY PARTICULAR FONT, STYLE, SIZE, OR COLOR.

CLASS 35—ADVERTISING AND BUSINESS

FOR BUSINESS CONSULTATION SERVICES (U.S. CLS. 100, 101 AND 102).

CLASS 36—INSURANCE AND FINANCIAL

FOR FINANCIAL INFORMATION AND ADVISORY SERVICES (U.S. CLS. 100, 101 AND 102).

DEZMONA MIZELLE, EXAMINING ATTORNEY

SN 77-577,552. MAX CREDIT UNION, MONTGOMERY, AL. FILED 9-24-2008.



NO CLAIM IS MADE TO THE EXCLUSIVE RIGHT TO USE "LEASING USA", APART FROM THE MARK AS SHOWN.

THE COLOR(S) BLUE, BLACK AND WHITE IS/ARE CLAIMED AS A FEATURE OF THE MARK.

THE MARK CONSISTS OF THE STYLIZED WORD "MAX" IN WHITE LETTERING CONTAINED WITHIN A BLUE SQUARE, PLACED TO THE LEFT OF THE WORD "LEASING" IN BLACK, WITH THE BLACK LETTERS, "USA", BELOW "LEASING".

CLASS 35—ADVERTISING AND BUSINESS

FOR LEASING OF OFFICE EQUIPMENT (U.S. CLS. 100, 101 AND 102).

FIRST USE 8-1-2008; IN COMMERCE 8-1-2008.

CLASS 37—CONSTRUCTION AND REPAIR

FOR LEASING OF CONSTRUCTION EQUIPMENT AND BUILDING MACHINERY (U.S. CLS. 100, 103 AND 106).

FIRST USE 8-1-2008; IN COMMERCE 8-1-2008.

CLASS 38—COMMUNICATION

FOR LEASING OF TELECOMMUNICATION EQUIPMENT (U.S. CLS. 100, 101 AND 104).

FIRST USE 8-1-2008; IN COMMERCE 8-1-2008.

CLASS 44—MEDICAL, BEAUTY AND AGRICULTURAL SERVICES

FOR LEASING OF MEDICAL EQUIPMENT (U.S. CLS. 100 AND 101).
FIRST USE 8-1-2008; IN COMMERCE 8-1-2008.
ODESSA BIBBINS, EXAMINING ATTORNEY

SN 77-579,493. BATH & BODY WORKS BRAND MANAGEMENT, INC., REYNOLDSBURG, OH. FILED 9-26-2008.

GLOBAL GOOD

THE MARK CONSISTS OF STANDARD CHARACTERS WITHOUT CLAIM TO ANY PARTICULAR FONT, STYLE, SIZE, OR COLOR.

CLASS 11—ENVIRONMENTAL CONTROL APPARATUS

FOR BATH TUBS AND SHOWER TRAYS (U.S. CLS. 13, 21, 23, 31 AND 34).

CLASS 14—JEWELRY

FOR JEWELRY (U.S. CLS. 2, 27, 28 AND 50).

CLASS 18—LEATHER GOODS

FOR COSMETIC BAGS SOLD EMPTY; TOILETRY BAGS SOLD EMPTY; TOILETRY CASES SOLD EMPTY; TOTE BAGS (U.S. CLS. 1, 2, 3, 22 AND 41).

CLASS 21—HOUSEWARES AND GLASS

FOR BATH PRODUCTS, NAMELY, LOOFAH SPONGES; BATH SPONGES; PLASTIC WATER BOTTLES SOLD EMPTY; SOAP DISHES; SOAP DISPENSERS; WASHING CLOTHS (U.S. CLS. 2, 13, 23, 29, 30, 33, 40 AND 50).

CLASS 24—FABRICS

FOR BATH TOWELS (U.S. CLS. 42 AND 50).

CLASS 25—CLOTHING

FOR HATS; PANTS; ROBES; SHORTS; T-SHIRTS; VISORS (U.S. CLS. 22 AND 39).
JILL PRATER, EXAMINING ATTORNEY

SN 77-581,120. MCCAIN FOODS USA, INC., LISLE, IL. FILED 9-29-2008.

PUB CITY

THE MARK CONSISTS OF STANDARD CHARACTERS WITHOUT CLAIM TO ANY PARTICULAR FONT, STYLE, SIZE, OR COLOR.

CLASS 29—MEATS AND PROCESSED FOODS

FOR APPETIZERS CONSISTING PRIMARILY OF MEAT, SEAFOOD, POULTRY, VEGETABLES AND CHEESE (U.S. CL. 46).

CLASS 30—STAPLE FOODS

FOR APPETIZERS CONSISTING PRIMARILY OF PASTRY AND DOUGHS; FROZEN BAKERY DESSERTS (U.S. CL. 46).
JAMES A. RAUEN, EXAMINING ATTORNEY

SN 77-582,275. STANISLAUS PARTNERS, MODESTO, CA. FILED 9-30-2008.

TONDINI

THE MARK CONSISTS OF STANDARD CHARACTERS WITHOUT CLAIM TO ANY PARTICULAR FONT, STYLE, SIZE, OR COLOR.

THE FOREIGN WORDING IN THE MARK TRANSLATES INTO ENGLISH AS SMALL PLATE, DISH, SAUCER.

CLASS 29—MEATS AND PROCESSED FOODS

FOR PROCESSED VEGETABLES; CANNED VEGETABLES; CANNED TOMATOES; VEGETABLE PASTE; VEGETABLE PUREE; TOMATO PASTE; TOMATO PUREE (U.S. CL. 46).

CLASS 30—STAPLE FOODS

FOR SAUCES; TOMATO-BASED SAUCES; READY-MADE SAUCES; TOMATO SAUCE; CANNED TOMATO SAUCE; PIZZA SAUCE; SPAGHETTI AND PASTA SAUCE; MARINARA SAUCE; SALSA (U.S. CL. 46).
ALLISON HALL, EXAMINING ATTORNEY

SN 77-582,290. STANISLAUS PARTNERS, MODESTO, CA. FILED 9-30-2008.

TONDINO

THE MARK CONSISTS OF STANDARD CHARACTERS WITHOUT CLAIM TO ANY PARTICULAR FONT, STYLE, SIZE, OR COLOR.

THE FOREIGN WORDING IN THE MARK TRANSLATES INTO ENGLISH AS SMALL PLATE, DISH, SAUCER.

CLASS 29—MEATS AND PROCESSED FOODS

FOR PROCESSED VEGETABLES; CANNED VEGETABLES; CANNED TOMATOES; VEGETABLE PASTE; VEGETABLE PUREE; TOMATO PASTE; TOMATO PUREE (U.S. CL. 46).

CLASS 30—STAPLE FOODS

FOR SAUCES; TOMATO-BASED SAUCES; READY-MADE SAUCES; TOMATO SAUCE; CANNED TOMATO SAUCE; PIZZA SAUCE; SPAGHETTI AND PASTA SAUCE; MARINARA SAUCE; SALSA (U.S. CL. 46).
ALLISON HALL, EXAMINING ATTORNEY

SN 77-585,023. STARKEY LABORATORIES, INC., EDEN PRAIRIE, MN. FILED 10-3-2008.

Think

SN 77-583,458. WESTERN HOLDINGS, LLC, CHEYENNE, WY. FILED 10-1-2008.

TRIM GUM

THE MARK CONSISTS OF STANDARD CHARACTERS WITHOUT CLAIM TO ANY PARTICULAR FONT, STYLE, SIZE, OR COLOR.

NO CLAIM IS MADE TO THE EXCLUSIVE RIGHT TO USE "GUM", APART FROM THE MARK AS SHOWN.

THE MARK CONSISTS OF STANDARD CHARACTERS WITHOUT CLAIM TO ANY PARTICULAR FONT, STYLE, SIZE, OR COLOR.

CLASS 9—ELECTRICAL AND SCIENTIFIC APPARATUS

FOR SOFTWARE FOR HEARING AIDS, FOR CUSTOM FITTING AND ADJUSTMENT OF ACOUSTIC PROPERTIES OF HEARING AIDS (U.S. CLS. 21, 23, 26, 36 AND 38).

CLASS 10—MEDICAL APPARATUS

FOR HEARING AIDS AND REPLACEMENT PARTS THEREOF (U.S. CLS. 26, 39 AND 44).
KATHERINE CONNOLLY, EXAMINING ATTORNEY

CLASS 5—PHARMACEUTICALS

FOR DIETARY SUPPLEMENTS (U.S. CLS. 6, 18, 44, 46, 51 AND 52).

SN 77-585,024. STARKEY LABORATORIES, INC., EDEN PRAIRIE, MN. FILED 10-3-2008.

CLASS 30—STAPLE FOODS

FOR CHEWING GUM (U.S. CL. 46).
JENNIFER MARTIN, EXAMINING ATTORNEY

IntelliFlex

THE MARK CONSISTS OF STANDARD CHARACTERS WITHOUT CLAIM TO ANY PARTICULAR FONT, STYLE, SIZE, OR COLOR.

SN 77-585,019. STARKEY LABORATORIES, INC., EDEN PRAIRIE, MN. FILED 10-3-2008.

Drive Architecture

THE MARK CONSISTS OF STANDARD CHARACTERS WITHOUT CLAIM TO ANY PARTICULAR FONT, STYLE, SIZE, OR COLOR.

CLASS 9—ELECTRICAL AND SCIENTIFIC APPARATUS

FOR SOFTWARE FOR HEARING AIDS, FOR CUSTOM FITTING AND ADJUSTMENT OF ACOUSTIC PROPERTIES OF HEARING AIDS (U.S. CLS. 21, 23, 26, 36 AND 38).

CLASS 10—MEDICAL APPARATUS

FOR HEARING AIDS AND REPLACEMENT PARTS THEREOF (U.S. CLS. 26, 39 AND 44).
KATHERINE CONNOLLY, EXAMINING ATTORNEY

CLASS 9—ELECTRICAL AND SCIENTIFIC APPARATUS

FOR SOFTWARE FOR HEARING AIDS, FOR CUSTOM FITTING AND ADJUSTMENT OF ACOUSTIC PROPERTIES OF HEARING AIDS (U.S. CLS. 21, 23, 26, 36 AND 38).

SN 77-585,028. STARKEY LABORATORIES, INC., EDEN PRAIRIE, MN. FILED 10-3-2008.

CLASS 10—MEDICAL APPARATUS

FOR HEARING AIDS AND REPLACEMENT PARTS THEREOF (U.S. CLS. 26, 39 AND 44).
KATHERINE CONNOLLY, EXAMINING ATTORNEY

Synergy

THE MARK CONSISTS OF STANDARD CHARACTERS WITHOUT CLAIM TO ANY PARTICULAR FONT, STYLE, SIZE, OR COLOR.

CLASS 9—ELECTRICAL AND SCIENTIFIC APPARATUS

FOR SOFTWARE FOR HEARING AIDS, FOR CUSTOM FITTING AND ADJUSTMENT OF ACOUSTIC PROPERTIES OF HEARING AIDS (U.S. CLS. 21, 23, 26, 36 AND 38).

SN 77-585,035. STARKEY LABORATORIES, INC., EDEN PRAIRIE, MN. FILED 10-3-2008.

CLASS 10—MEDICAL APPARATUS

FOR HEARING AIDS AND REPLACEMENT PARTS THEREOF (U.S. CLS. 26, 39 AND 44).
KATHERINE CONNOLLY, EXAMINING ATTORNEY

Imagine

THE MARK CONSISTS OF STANDARD CHARACTERS WITHOUT CLAIM TO ANY PARTICULAR FONT, STYLE, SIZE, OR COLOR.

SN 77-585,030. STARKEY LABORATORIES, INC., EDEN PRAIRIE, MN. FILED 10-3-2008.

CLASS 9—ELECTRICAL AND SCIENTIFIC APPARATUS

FOR SOFTWARE FOR HEARING AIDS, FOR CUSTOM FITTING AND ADJUSTMENT OF ACOUSTIC PROPERTIES OF HEARING AIDS (U.S. CLS. 21, 23, 26, 36 AND 38).

Anthem

THE MARK CONSISTS OF STANDARD CHARACTERS WITHOUT CLAIM TO ANY PARTICULAR FONT, STYLE, SIZE, OR COLOR.

CLASS 10—MEDICAL APPARATUS

FOR HEARING AIDS AND REPLACEMENT PARTS THEREOF (U.S. CLS. 26, 39 AND 44).
KATHERINE CONNOLLY, EXAMINING ATTORNEY

CLASS 9—ELECTRICAL AND SCIENTIFIC APPARATUS

FOR SOFTWARE FOR HEARING AIDS, FOR CUSTOM FITTING AND ADJUSTMENT OF ACOUSTIC PROPERTIES OF HEARING AIDS (U.S. CLS. 21, 23, 26, 36 AND 38).

SN 77-585,230. DILLENBACK, SCOTT, DBA DRUNKARD'S DREAM, PORTLAND, ME. FILED 10-3-2008.

CLASS 10—MEDICAL APPARATUS

FOR HEARING AIDS AND REPLACEMENT PARTS THEREOF (U.S. CLS. 26, 39 AND 44).
KATHERINE CONNOLLY, EXAMINING ATTORNEY

SN 77-585,033. STARKEY LABORATORIES, INC., EDEN PRAIRIE, MN. FILED 10-3-2008.

Vector

THE MARK CONSISTS OF STANDARD CHARACTERS WITHOUT CLAIM TO ANY PARTICULAR FONT, STYLE, SIZE, OR COLOR.



THE MARK CONSISTS OF CARTOON PROFILE OF A MAN'S FACE.

CLASS 9—ELECTRICAL AND SCIENTIFIC APPARATUS

FOR SOFTWARE FOR HEARING AIDS, FOR CUSTOM FITTING AND ADJUSTMENT OF ACOUSTIC PROPERTIES OF HEARING AIDS (U.S. CLS. 21, 23, 26, 36 AND 38).

CLASS 14—JEWELRY

FOR NECKLACES (U.S. CLS. 2, 27, 28 AND 50).
FIRST USE 10-1-2008; IN COMMERCE 10-1-2008.

CLASS 10—MEDICAL APPARATUS

FOR HEARING AIDS AND REPLACEMENT PARTS THEREOF (U.S. CLS. 26, 39 AND 44).
KATHERINE CONNOLLY, EXAMINING ATTORNEY

CLASS 25—CLOTHING

FOR BASEBALL CAPS; SUN VISORS; T-SHIRTS (U.S. CLS. 22 AND 39).
SKYE YOUNG, EXAMINING ATTORNEY

SN 77-586,886. AUTOLIV DEVELOPMENT AB, VARGARDA, SWEDEN, FILED 10-7-2008.

SN 77-590,014. C.B. FLEET INVESTMENT CORPORATION, WILMINGTON, DE. FILED 10-10-2008.

BEGIN. BELIEVE. BE LEAN.

THE MARK CONSISTS OF STANDARD CHARACTERS WITHOUT CLAIM TO ANY PARTICULAR FONT, STYLE, SIZE, OR COLOR.

CLASS 35—ADVERTISING AND BUSINESS

FOR BUSINESS CONSULTING, NAMELY, EXECUTIVE AND BUSINESS COACHING; BUSINESS MANAGEMENT AND CONSULTING SERVICES IN THE FIELDS OF LEAN MANUFACTURING, PRODUCTIVITY, AND PERFORMANCE AND PROCESS IMPROVEMENT (U.S. CLS. 100, 101 AND 102).

CLASS 41—EDUCATION AND ENTERTAINMENT

FOR EDUCATION SERVICES, NAMELY, PROVIDING WORKSHOPS IN THE FIELDS OF LEAN MANUFACTURING, PRODUCTIVITY, AND PERFORMANCE AND PROCESS IMPROVEMENT (U.S. CLS. 100, 101 AND 107).
PAUL E. FAHRENKOPF, EXAMINING ATTORNEY

SN 77-588,079. JONATHAN J. JACOBOWITZ, BRATTLEBORO, VT. FILED 10-8-2008.

NATURAL INSIGHTS FOR WELL
BEING

THE MARK CONSISTS OF STANDARD CHARACTERS WITHOUT CLAIM TO ANY PARTICULAR FONT, STYLE, SIZE, OR COLOR.

CLASS 9—ELECTRICAL AND SCIENTIFIC APPARATUS

FOR DOWNLOADABLE ELECTRONIC NEWSLETTERS IN THE FIELD OF HEALTH, NUTRITION, AND NATURAL HEALTH PRODUCTS (U.S. CLS. 21, 23, 26, 36 AND 38).

CLASS 16—PAPER GOODS AND PRINTED MATTER

FOR NEWSLETTERS IN THE FIELD OF HEALTH, NUTRITION, AND NATURAL PRODUCTS; RESEARCH REPORTS AND COMMENTARY IN THE FIELD OF HEALTH, NUTRITION AND NATURAL PRODUCTS; PRINTED ADVERTISING BOARDS OF PAPER OR CARDBOARD, POSTCARDS, PRINTED MATERIALS, NAMELY, PRESS RELEASES FEATURING INFORMATION IN THE FIELDS OF HEALTH NUTRITION AND NATURAL PRODUCTS (U.S. CLS. 2, 5, 22, 23, 29, 37, 38 AND 50).

DAVID MURRAY, EXAMINING ATTORNEY

WHOOSH

THE MARK CONSISTS OF STANDARD CHARACTERS WITHOUT CLAIM TO ANY PARTICULAR FONT, STYLE, SIZE, OR COLOR.

CLASS 3—COSMETICS AND CLEANING PREPARATIONS

FOR PRE-MOISTENED NON-MEDICATED RECTAL CLEANSING WIPES; NON-MEDICATED LIQUID SOLUTION FOR RECTAL CLEANSING (U.S. CLS. 1, 4, 6, 50, 51 AND 52).

CLASS 5—PHARMACEUTICALS

FOR ENEMA APPARATUS CONSISTING OF A PLASTIC BOTTLE CONTAINING A SOLUTION OF SODIUM CHLORIDE AND WATER AND AN APPLICATOR NOZZLE FOR THE PURPOSE OF CLEANSING (U.S. CLS. 6, 18, 44, 46, 51 AND 52).

ROBIN CHOSID, EXAMINING ATTORNEY

SN 77-590,616. STARKEY LABORATORIES, INC., EDEN PRAIRIE, MN. FILED 10-10-2008.

S CLASS

THE MARK CONSISTS OF STANDARD CHARACTERS WITHOUT CLAIM TO ANY PARTICULAR FONT, STYLE, SIZE, OR COLOR.

CLASS 9—ELECTRICAL AND SCIENTIFIC APPARATUS

FOR SOFTWARE FOR HEARING AIDS, FOR CUSTOM FITTING AND ADJUSTMENT OF ACOUSTIC PROPERTIES OF HEARING AIDS (U.S. CLS. 21, 23, 26, 36 AND 38).

CLASS 10—MEDICAL APPARATUS

FOR HEARING AIDS AND REPLACEMENT PARTS THEREOF (U.S. CLS. 26, 39 AND 44).

KATHERINE CONNOLLY, EXAMINING ATTORNEY

SN 77-592,927. PRODUCT PARTNERS, LLC, SANTA MONICA, CA. FILED 10-15-2008.

PIZÁH!

THE MARK CONSISTS OF STANDARD CHARACTERS WITHOUT CLAIM TO ANY PARTICULAR FONT, STYLE, SIZE, OR COLOR.

CLASS 5—PHARMACEUTICALS

FOR NUTRITIONAL ENERGY SUPPLEMENTS (U.S. CLS. 6, 18, 44, 46, 51 AND 52).

CLASS 32—LIGHT BEVERAGES

FOR ENERGY DRINKS (U.S. CLS. 45, 46 AND 48).
HOWARD B. LEVINE, EXAMINING ATTORNEY

SN 77-593,226. SPRINGS GLOBAL US, INC., FORT MILL, SC. FILED 10-15-2008.

J-TEX

THE MARK CONSISTS OF STANDARD CHARACTERS WITHOUT CLAIM TO ANY PARTICULAR FONT, STYLE, SIZE, OR COLOR.

CLASS 20—FURNITURE AND ARTICLES NOT OTHERWISE CLASSIFIED

FOR WINDOW BLINDS; WINDOW SHADES (U.S. CLS. 2, 13, 22, 25, 32 AND 50).
FIRST USE 1-1-2008; IN COMMERCE 1-1-2008.

CLASS 24—FABRICS

FOR CURTAINS; DRAPERIES (U.S. CLS. 42 AND 50).
FIRST USE 1-1-2008; IN COMMERCE 1-1-2008.
LAKEISHA LEWIS, EXAMINING ATTORNEY

SN 77-600,961. ELITE GOLF PARTNERS, LLC, OMAHA, NE. FILED 10-27-2008.

Where Everyone Belongs

THE MARK CONSISTS OF STANDARD CHARACTERS WITHOUT CLAIM TO ANY PARTICULAR FONT, STYLE, SIZE, OR COLOR.

CLASS 25—CLOTHING

FOR GOLF CAPS; GOLF SHIRTS; GOLF TROUSERS; JACKETS; MOISTURE-WICKING SPORTS SHIRTS; POLO SHIRTS; RAINPROOF JACKETS; REVERSIBLE JACKETS; SPORT SHIRTS; SPORTS SHIRTS WITH SHORT SLEEVES (U.S. CLS. 22 AND 39).

CLASS 35—ADVERTISING AND BUSINESS

FOR ON-LINE RETAIL STORE SERVICES FEATURING GOLF CLUB RELATED CLOTHING (U.S. CLS. 100, 101 AND 102).
CARYN GLASSER, EXAMINING ATTORNEY

SN 77-615,261. POSH CUTIE COUTURE LLC, AURORA, IL. FILED 11-15-2008.

Posh Cutie Couture

THE MARK CONSISTS OF STANDARD CHARACTERS WITHOUT CLAIM TO ANY PARTICULAR FONT, STYLE, SIZE, OR COLOR.
NO CLAIM IS MADE TO THE EXCLUSIVE RIGHT TO USE "COUTURE", APART FROM THE MARK AS SHOWN.

CLASS 24—FABRICS

FOR BED LINEN (U.S. CLS. 42 AND 50).

CLASS 25—CLOTHING

FOR WEARABLE GARMENTS AND CLOTHING, NAMELY, SHIRTS (U.S. CLS. 22 AND 39).
SUSAN RICHARDS, EXAMINING ATTORNEY

SN 77-618,867. ELMER'S PRODUCTS, INC., COLUMBUS, OH. FILED 11-20-2008.

ECOTIVITY

THE MARK CONSISTS OF STANDARD CHARACTERS WITHOUT CLAIM TO ANY PARTICULAR FONT, STYLE, SIZE, OR COLOR.

CLASS 16—PAPER GOODS AND PRINTED MATTER

FOR CHILDREN'S ACTIVITY BOOKS (U.S. CLS. 2, 5, 22, 23, 29, 37, 38 AND 50).

CLASS 28—TOYS AND SPORTING GOODS

FOR HOBBY CRAFT KIT COMPRISING ACTIVITY BOOKS, POSTER BOARD, BLANK AND THEMED PAPER AND PAPER PADS, PAINT PENS, PAINT BRUSHES, CRAYONS, FELT-TIP MARKERS, COLORED PENCILS, GLUE AND GLUE STICKS (U.S. CLS. 22, 23, 38 AND 50).
WENDY GOODMAN, EXAMINING ATTORNEY

SN 77-619,643. MIRAGE TILE, L.L.C., NEWPORT NEWS, VA.
FILED 11-21-2008.

SN 78-479,456. ATOMIC CARTOONS INC., VANCOUVER,
CANADA, FILED 9-7-2004.

Bay Watch Tile

THE MARK CONSISTS OF STANDARD CHARACTERS WITHOUT CLAIM TO ANY PARTICULAR FONT, STYLE, SIZE, OR COLOR.

NO CLAIM IS MADE TO THE EXCLUSIVE RIGHT TO USE "TILE", APART FROM THE MARK AS SHOWN.

CLASS 6—METAL GOODS

FOR TILES OF METAL FOR WALLS, FLOORS, AND CEILING (U.S. CLS. 2, 12, 13, 14, 23, 25 AND 50).

CLASS 19—NON-METALLIC BUILDING MATERIALS

FOR TILES OF GLASS, PORCELAIN, AND STONE FOR WALLS, FLOORS, AND CEILING (U.S. CLS. 1, 12, 33 AND 50).

LINDSEY RUBIN, EXAMINING ATTORNEY



PRIORITY CLAIMED UNDER SEC. 44(D) ON CANADA APPLICATION NO. 1219793, FILED 6-9-2004, REG. NO. TMA710,991, DATED 4-4-2008, EXPIRES 4-4-2023.

CLASS 14—JEWELRY

FOR ALARM CLOCKS; ANKLE BRACELETS; BEADS FOR USE IN THE MANUFACTURE OF JEWELRY; BRACELETS; BRACELETS OF PRECIOUS METALS; BROOCHES; CHARMS; CHOKERS; CHRONOGRAPHS FOR USE AS WATCHES; CLIP EARRINGS; CLOCKS; CLOISONNE PINS; COSTUME JEWELRY; CUFF-LINKS; EAR CLIPS; EARRINGS; HAT ORNAMENTS OF PRECIOUS METAL; HAT PINS OF PRECIOUS METAL; HOLIDAY ORNAMENTS OF PRECIOUS METAL NOT USED AS TREE ORNAMENTS; JEWELRY IDENTIFICATION BRACELETS; JEWELRY; JEWELRY CHAINS; JEWELRY PINS FOR USE ON HATS, JEWELRY, NAMELY, AMULETS; KEY RINGS OF PRECIOUS METAL; NECK CHAINS; NECKLACES; ORNAMENTAL LAPEL PINS; ORNAMENTAL PINS; PENDANTS; PENDULUM CLOCKS; POCKET WATCHES; RINGS BEING JEWELRY; STOP WATCHES; TIARAS; TIE CLIPS; TIE FASTENERS; TIE PINS; TIE TACKS; WALL CLOCKS; WATCH BANDS; WATCHES; WATCHES CONTAINING AN ELECTRONIC GAME FUNCTION; WATCHES CONTAINING A GAME FUNCTION; WRIST WATCHES (U.S. CLS. 2, 27, 28 AND 50).

CLASS 18—LEATHER GOODS

FOR ALL PURPOSE SPORT BAGS; ALL PURPOSE ATHLETIC BAGS, ATHLETIC BAGS; BAGS AND HOLLARDS FOR SPORTS CLOTHING; CHANGE PURSES; COIN PURSES; SPORTS BAGS; SPORTS PACKS (U.S. CLS. 1, 2, 3, 22 AND 41).

CLASS 24—FABRICS

FOR BATH LINEN; BED SHEETS; BED SPREADS; BLANKET THROWS; COMFORTERS; DUVET COVERS; EIDERDOWN COVERS, EIDERDOWNS; HOUSEHOLD LINEN, KITCHEN LINENS, LINEN, MATTRESS COVERS; PILLOW CASES; PILLOW COVERS; PILLOW SHAMS; TABLE LINEN (U.S. CLS. 42 AND 50).

CLASS 25—CLOTHING

FOR ANKLET SOCKS; BATHROBES; BERMUDA SHORTS; BOXER BRIEFS; BOXER SHORTS; BRASIERES; UNDERWEAR BRIEFS; BUSTIERS; CAMISOLES; HOSIERY; NIGHT GOWNS; PAJAMAS; PANTIES, SANDALS, CHILDREN'S AND JUNIOR'S SPORT SHIRTS (U.S. CLS. 22 AND 39).

ANTHONY RINKER, EXAMINING ATTORNEY

SN 78-234,975. E. BEGEROW GMBH & CO., LANGENLONSHEIM, FED REP GERMANY, FILED 4-8-2003.

INTEGRA

PRIORITY CLAIMED UNDER SEC. 44(D) ON ERPNTY TM OFC APPLICATION NO. 002901858, FILED 10-22-2002, REG. NO. 002901858, DATED 9-14-2007, EXPIRES 9-14-2017.

CLASS 7—MACHINERY

FOR FILTRATION EQUIPMENT, APPARATUS AND APPLIANCES, NAMELY, FILTER AND PREFILTER ELEMENTS, DEPTH FILTER ELEMENTS AND SHEETS, FILTER CARTRIDGES, FILTER DISCS, STAGE FILTERS, STERILIZATION FILTERS, FILTER SHEETS AND MULTI FILTER SHEETS, FILTRATE AND UNFILTRATE PLATES, FILTER FRAMES, FILTER CHASSIS, CARTRIDGE HOUSINGS FOR USE ON FILTERING MACHINES AND INSTALLATIONS, WITHIN TECHNICAL APPLICATIONS, ESPECIALLY FOR USE WITHIN THE PROCESS TECHNOLOGY, THE CONSTRUCTION OF MACHINES AND VEHICLES (U.S. CLS. 13, 19, 21, 23, 31, 34 AND 35).

CLASS 11—ENVIRONMENTAL CONTROL APPARATUS

FOR LIQUID AND GAS FILTRATION EQUIPMENT, APPARATUS AND APPLIANCES, NAMELY, FILTER AND PREFILTER ELEMENTS, DEPTH FILTER ELEMENTS AND SHEETS, FILTER MEMBRANES AND FILTER BEDS, FILTER CARTRIDGES, FILTER DISCS, STAGE FILTERS, STERILIZATION FILTERS, FILTER SHEETS AND MULTI FILTER SHEETS, FILTRATE AND UNFILTRATE PLATES, FILTER FRAMES, FILTER CHASSIS, CARTRIDGE HOUSING FOR FILTERING, CLARIFYING AND STERILIZING OF LIQUIDS, SPECIFICALLY USED WITHIN TECHNICAL APPLICATIONS IN THE BEVERAGE, CHEMICAL AND CHEMO-PHARMACEUTICAL INDUSTRIES (U.S. CLS. 13, 21, 23, 31 AND 34).

PAM WILLIS, EXAMINING ATTORNEY

SN 78-508,254. KEYSTONE WEST, INC., MERIDIAN, ID.
FILED 10-29-2004.

KEYSTONE WEST

THE MARK CONSISTS OF STANDARD CHARACTERS WITHOUT CLAIM TO ANY PARTICULAR FONT, STYLE, SIZE, OR COLOR.

CLASS 35—ADVERTISING AND BUSINESS

FOR PROFESSIONAL BUSINESS MANAGEMENT SERVICES FOR OTHERS OF LONG TERM AND PERPETUAL CARE NURSING HOMES, AND ASSISTED LIVING FACILITIES; BUSINESS MANAGEMENT OF RETIREMENT FACILITIES, LONG TERM AND PERPETUAL CARE NURSING HOMES, AND ACCOMMODATIONS FOR SENIOR CITIZENS; CONSULTING FOR OTHERS ABOUT QUALITY ASSURANCE SURVEYS IN LONG TERM AND PERPETUAL CARE NURSING HOMES AND ASSISTED LIVING FACILITIES (U.S. CLS. 100, 101 AND 102).

FIRST USE 7-8-2004; IN COMMERCE 7-8-2004.

CLASS 42—SCIENTIFIC AND COMPUTER SERVICES

FOR CONSULTING IN THE FIELD OF REVIEWING STANDARDS AND PRACTICES TO ASSURE REGULATORY COMPLIANCE WITH HEALTH AND SAFETY REGULATIONS FOR ASSISTED LIVING FACILITIES AND LONG TERM AND PERPETUAL CARE NURSING HOMES; CONSULTING FOR OTHERS ABOUT QUALITY ASSURANCE SERVICES IN THE FIELD OF LONG TERM AND PERPETUAL CARE NURSING HOMES AND ASSISTED LIVING FACILITIES (U.S. CLS. 100 AND 101).

FIRST USE 7-8-2004; IN COMMERCE 7-8-2004.
NELSON SNYDER, EXAMINING ATTORNEY

SN 78-602,599. BENCOM S.R.L., TREVISO, ITALY, FILED 4-5-2005.



OWNER OF ITALY REG. NO. 00736427, DATED 9-12-1997, RENEWED AS REG. NO. MI2006C00541, DATED 5-19-2006, EXPIRES 5-19-2016.

OWNER OF ITALY REG. NO. 00686322, DATED 9-12-1996, RENEWED AS REG. NO. 686322, DATED 9-12-1996, EXPIRES 7-19-2016.

OWNER OF U.S. REG. NOS. 1,618,282, 1,809,273 AND 2,382,177.

THE COLOR(S) GREEN AND WHITE IS/ARE CLAIMED AS A FEATURE OF THE MARK.

THE MARK CONSISTS OF THE WORDS "UNITED COLORS OF BENETTON." IN WHITE LETTERS, ALIGNED FLUSH LEFT WITHIN A GREEN RECTANGLE.

CLASS 9—ELECTRICAL AND SCIENTIFIC APPARATUS

FOR MAGNETS, DECORATIVE SWITCH PLATES, CALCULATORS, ELECTRIC DOOR BELLS (U.S. CLS. 21, 23, 26, 36 AND 38).

CLASS 16—PAPER GOODS AND PRINTED MATTER

FOR BLANK THEME BOOKS, MEMO BLOCKS, STUDENT PLANNERS, DIARIES, ADDRESS BOOKS, WRITING PAPER, BINDERS, PENCIL POUCHES, AGENDAS, ORGANIZER FILES, RING BINDERS, DESK ACCESSORIES, NAMEPLATES, PENS, PENCILS, PEN AND PENCIL HOLDERS, STAPLERS, DESK SETS, MEMO BOARDS, LAP DESKS, ERASERS, PENCIL SHARPENERS, GLUE FOR OFFICE, STATIONERY OR HOUSEHOLD USE, STAMPERS, STICKERS, BOOK COVERS, BOOKENDS, BOOKMARKERS, PAPER COASTERS, MEMO PADS, PHOTO ALBUMS, DESKTOP OR STATIONERY ORGANIZERS, PERSONAL ORGANIZERS, DRY ERASE MARKERS, CRAYONS, HIGH LIGHTERS PENS AND MARKERS, LUNCH BAGS MADE OF TEXTILE (U.S. CLS. 2, 5, 22, 23, 29, 37, 38 AND 50).

CLASS 18—LEATHER GOODS

FOR SCHOOL BAGS, SCHOOL BACKPACKS, ROLLING BACKPACKS AND BACKPACK ORNAMENTS (U.S. CLS. 1, 2, 3, 22 AND 41).

CLASS 20—FURNITURE AND ARTICLES NOT OTHERWISE CLASSIFIED

FOR LOCKER AND CLOSET ORGANIZER ACCESSORIES, NAMELY, BARS, RAILS, BASKETS AND CLOTHES HANGERS, SHELVES, SLING CHAIRS, MINI TABLES, HEADBOARDS, DREAM PILLOWS, NON-METAL AND NON-LEATHER KEY CHAINS, PLASTIC STORAGE BOXES AND CONTAINERS (U.S. CLS. 2, 13, 22, 25, 32 AND 50).

CLASS 21—HOUSEWARES AND GLASS

FOR LAUNDRY BASKETS, WASTE BASKETS, PLASTIC COASTERS, LUNCH BOXES, INSULATED LUNCH COOLER BAGS AND BOXES (U.S. CLS. 2, 13, 23, 29, 30, 33, 40 AND 50).

CLASS 27—FLOOR COVERINGS

FOR RUGS (U.S. CLS. 19, 20, 37, 42 AND 50).
CYNTHIA SLOAN, EXAMINING ATTORNEY

SN 78-636,231. REDNER, CHRISTOPHER W., FEDERAL WAY, WA. FILED 5-24-2005.

WORLD WEEK

THE MARK CONSISTS OF STANDARD CHARACTERS WITHOUT CLAIM TO ANY PARTICULAR FONT, STYLE, SIZE, OR COLOR.

CLASS 36—INSURANCE AND FINANCIAL

FOR CHARITABLE FUND RAISING SERVICES FOR ORGANIZATIONS CONCERNED WITH GLOBAL ISSUES (U.S. CLS. 100, 101 AND 102).

FIRST USE 11-12-1993; IN COMMERCE 11-12-1993.

CLASS 41—EDUCATION AND ENTERTAINMENT

FOR EDUCATIONAL SERVICES, NAMELY, CONDUCTING PROGRAMS AND PROVIDING ORGANIZED ACTIVITIES IN THE NATURE OF CLASSES AND WORKSHOPS, WHICH RAISE AWARENESS AND UNDERSTANDING OF GLOBAL ISSUES SUCH AS HEALTH, EDUCATION, POVERTY, ENVIRONMENTAL PROTECTION, AND HUMAN RIGHTS. (U.S. CLS. 100, 101 AND 107).

FIRST USE 11-12-1993; IN COMMERCE 11-12-1993.
KATHY DE JONGE, EXAMINING ATTORNEY

SN 78-641,510. TRINITY CHRISTIAN CENTER OF SANTA ANA, INC., SANTA ANA, CA. FILED 6-1-2005.

TRINITY BROADCASTING NETWORK

THE MARK CONSISTS OF STANDARD CHARACTERS WITHOUT CLAIM TO ANY PARTICULAR FONT, STYLE, SIZE, OR COLOR.

NO CLAIM IS MADE TO THE EXCLUSIVE RIGHT TO USE "BROADCASTING NETWORK", APART FROM THE MARK AS SHOWN.

CLASS 9—ELECTRICAL AND SCIENTIFIC APPARATUS

FOR PRE-RECORDED AUDIO TAPES AND CASSETTES AND VIDEO TAPES AND CASSETTES FEATURING RELIGIOUS PROGRAMMING; PRE-RECORDED CDS AND DVDS FEATURING RELIGIOUS PROGRAMMING; AND PRE-RECORDED AUDIO TAPES AND CASSETTES AND VIDEO TAPES AND CASSETTES FEATURING INSPIRATIONAL MUSICAL SONGS AND MUSIC; AND PRE-RECORDED CDS AND DVDS FEATURING INSPIRATIONAL MUSICAL SONGS AND MUSIC (U.S. CLS. 21, 23, 26, 36 AND 38).

FIRST USE 12-31-1975; IN COMMERCE 12-31-1975.

CLASS 35—ADVERTISING AND BUSINESS

FOR RETAIL STORE SERVICES FEATURING PRE-RECORDED AUDIO CASSETTES AND TAPES, VIDEO CASSETTES AND TAPES, CDS, DVDS AND BOOKS; AND ONLINE RETAIL STORE SERVICES FEATURING PRE-RECORDED AUDIO CASSETTES AND TAPES, VIDEO CASSETTES AND TAPES, CDS, DVDS AND BOOKS (U.S. CLS. 100, 101 AND 102).

FIRST USE 12-31-1990; IN COMMERCE 12-31-1990.

CLASS 38—COMMUNICATION

FOR TELEVISION BROADCASTING; CABLE TELEVISION BROADCASTING; DIGITAL TELEVISION BROADCASTING; VIDEO BROADCASTING; STREAMING OF AUDIO AND VIDEO MATERIAL ON THE INTERNET; BROADCASTING PROGRAMS VIA A GLOBAL COMPUTER NETWORK (U.S. CLS. 100, 101 AND 104).

FIRST USE 12-31-1973; IN COMMERCE 12-31-1973.

CLASS 41—EDUCATION AND ENTERTAINMENT

FOR PRODUCTION OF CABLE TELEVISION PROGRAMS; PRODUCTION OF CLOSED CAPTION TELEVISION PROGRAMS; PRODUCTION OF TELEVISION PROGRAMS; TELEVISION PRODUCTION; TELEVISION PROGRAM SYNDICATION; TELEVISION SHOW PRODUCTION; ENTERTAINMENT IN THE NATURE OF ON-GOING TELEVISION PROGRAMS IN THE FIELD OF NEWS, COMEDY, VARIETY, RELIGION, HEALTH, MUSIC AND YOUTH, ADULT AND CHILDREN SPECIFIC TOPICS; ENTERTAINMENT SERVICES, NAMELY, PROVIDING A TELEVISION PROGRAM IN THE FIELD OF NEWS, RELIGION, HEALTH, VARIETY, MUSIC, COMEDY AND YOUTH, ADULT AND CHILDREN SPECIFIC TOPICS VIA A GLOBAL COMPUTER NETWORK; ENTERTAINMENT SERVICES IN THE NATURE OF ON-GOING TELEVISION PROGRAMS IN THE FIELD OF CHILDREN'S ENTERTAINMENT; ENTERTAINMENT, NAMELY, PRODUCTION OF TELEVISION SHOWS AND GAME SHOWS; ENTERTAINMENT SERVICES, NAMELY, PRODUCTION AND DISTRIBUTION OF A GAME SHOW; PRODUCTION OF VIDEO CASSETTES; VIDEOTAPE PRODUCTION; ENTERTAINMENT SERVICES, NAMELY, PROVIDING A WEB SITE FEATURING MUSICAL PERFORMANCES, MUSICAL VIDEOS, RELATED FILM CLIPS, PHOTOGRAPHS, AND OTHER MULTIMEDIA MATERIALS; ENTERTAINMENT SERVICES, NAMELY, AN ONLINE ACTIVITY WHERE USERS CREATE THEIR OWN MUSIC VIDEOS; ENTERTAINMENT, NAMELY, A CONTINUING NEWS, COMEDY, VARIETY, HEALTH, MUSIC OR RELIGIOUS SHOW BROADCAST OVER TELEVISION, SATELLITE, AUDIO, AND VIDEO MEDIA; CONTINUING TELEVISION SHOWS BROADCAST OVER TELEVISION, SATELLITE, AUDIO, AND VIDEO MEDIA FEATURING RELIGIOUS CONTENT; AND MOTION PICTURE FILM PRODUCTION (U.S. CLS. 100, 101 AND 107).

FIRST USE 12-31-1973; IN COMMERCE 12-31-1973.
KEVIN CORWIN, EXAMINING ATTORNEY

SN 78-688,023. MARTIN IMDAHL, UBERSEE, FED REP GERMANY, FILED 8-8-2005.

MATADOR

THE MARK CONSISTS OF STANDARD CHARACTERS WITHOUT CLAIM TO ANY PARTICULAR FONT, STYLE, SIZE, OR COLOR.

OWNER OF ERPN CMNTY TM OFC REG. NO. 1270321, DATED 5-22-2001, EXPIRES 8-6-2009.

CLASS 3—COSMETICS AND CLEANING PREPARATIONS

FOR SOAPS, NAMELY, HAND SOAPS, ANTIBACTERIAL SOAPS, LIQUID SOAPS, PERFUMED SOAPS, BATH SOAPS, BATH OILS, SHOWER GELS, SHOWER CREAMS, SHAMPOOS; PERFUMERY, NAMELY, PERFUME AND EAU DE TOILETTE; ESSENTIAL OILS; COSMETICS, NAMELY, AFTER SHAVE LOTIONS, DEODORANTS FOR PERSONAL USE, AND SUN CARE PRODUCTS, NAMELY, SUN CREAMS, SUN CARE LOTIONS, SUN TAN OILS, SUN BLOCKERS AND AFTER SUN LOTIONS; HAIR LOTIONS; DENTIFRICES (U.S. CLS. 1, 4, 6, 50, 51 AND 52).

CLASS 25—CLOTHING

FOR CLOTHING, NAMELY, CASUAL WEAR, NAMELY, T-SHIRTS, SWEATSHIRTS, SHIRTS, COATS, JACKETS, SKIRTS, DRESSES, JEANS, LONG AND SHORT PANTS, PULLOVERS, SOCKS, UNDERWEAR; ACTIVE WEAR, NAMELY, SKI WEAR AND SNOWBOARD WEAR, NAMELY, JACKETS, VESTS, FLEECE JACKETS, PANTS, BOOTS, GLOVES; SURF WEAR, SWIM WEAR, BEACH WEAR, FLEECE WEAR, NAMELY, SHORTS FOR SWIMMING, BIKINIS, SWIM SUITS, PULLOVERS, SHORTS, T-SHIRTS, SWEATSHIRTS, SKIRTS, SHIRTS, LONG AND SHORT PANTS, JACKETS, UNDERWEAR; FLEECE JACKETS, TECHNICAL/FUNCTIONAL UNDERWEAR, NAMELY, PERSPIRATION ABSORBENT UNDERWEAR; FOOTWEAR, NOT INCLUDING SAFETY FOOTWEAR; HEADWEAR; SNOWBOARD BOOTS, SKI BOOTS (U.S. CLS. 22 AND 39).

CLASS 28—TOYS AND SPORTING GOODS

FOR SPORTING GOODS, NAMELY, SURFBOARDS, SNOWBOARDS, SKIS, SKI POLES, SURFBOARD AND SKI WAX (U.S. CLS. 22, 23, 38 AND 50).
PAUL CROWLEY, EXAMINING ATTORNEY

SN 78-691,781. 777388 ONTARIO LIMITED, BURLINGTON, ONTARIO, CANADA, FILED 8-12-2005.

ACCUMASK

THE MARK CONSISTS OF STANDARD CHARACTERS WITHOUT CLAIM TO ANY PARTICULAR FONT, STYLE, SIZE, OR COLOR.

PRIORITY CLAIMED UNDER SEC. 44(D) ON CANADA APPLICATION NO. 1266158, FILED 7-27-2005, REG. NO. TMA712,062, DATED 4-16-2008, EXPIRES 4-16-2023.

CLASS 9—ELECTRICAL AND SCIENTIFIC APPARATUS

FOR SOUND MASKING, PAGING AND MUSIC NETWORK COMPRISING ANY OF THE FOLLOWING COMPONENTS: LOUDSPEAKER, PROGRAMMABLE TIMER, ELECTRIC CABLES, TRANSFORMER, REMOTE CONTROL, OR ANY COMBINATION OF SUCH COMPONENTS, ALL PARTS THEREFORE AND ACCESSORIES THEREOF, NAMELY, REMOTE CONTROLS, ELECTRIC SWITCHES (U.S. CLS. 21, 23, 26, 36 AND 38).

CLASS 37—CONSTRUCTION AND REPAIR

FOR INSTALLATION AND MAINTENANCE OF AN ELECTRONIC NOISE MASKING SYSTEM (U.S. CLS. 100, 103 AND 106).

CLASS 42—SCIENTIFIC AND COMPUTER SERVICES

FOR INSPECTIONS OF ELECTRONIC NOISE MASKING SYSTEMS; DESIGN FOR OTHERS IN THE FIELD OF ELECTRONIC NOISE MASKING SYSTEMS (U.S. CLS. 100 AND 101).
AMY ALFIERI, EXAMINING ATTORNEY

SN 78-705,374. U.S. SKATEBOARDING FEDERATION, CONSHOHOCKEN, PA. FILED 9-1-2005.



NO CLAIM IS MADE TO THE EXCLUSIVE RIGHT TO USE "USA SKATEBOARDING", APART FROM THE MARK AS SHOWN.

THE MARK CONSISTS OF THE STYLIZED LETTERS "USA" IN UPPER CASE LETTERING WITH THE WORD "SKATEBOARDING" POSITIONED BELOW "USA" IN LOWER CASE LETTERING; TO THE LEFT OF THE STYLIZED LETTERING IS AN IMAGE OF THE TOP LEFT PORTION OF AN AMERICAN STAR WITH AN IMAGE OF A PERSON AND A SKATEBOARD WITHIN THE BOUNDARIES OF THE STAR.

CLASS 16—PAPER GOODS AND PRINTED MATTER

FOR PRINTED MATERIALS, NAMELY, PAMPHLETS, NEWSLETTERS, MAGAZINES AND BROCHURES, ALL IN THE FIELD OF SKATEBOARDING, POSTERS, PRINTED AWARDS, PRINTED EMBLEMS, PAPER EMBLEMS AND DECALS (U.S. CLS. 2, 5, 22, 23, 29, 37, 38 AND 50).

FIRST USE 8-16-2005; IN COMMERCE 8-16-2005.

CLASS 25—CLOTHING

FOR CLOTHING, NAMELY, SHIRTS, T-SHIRTS, SWEATSHIRTS, SWEATPANTS, TANK TOPS, TOPS, HATS, CAPS, SHORTS, PANTS, JACKETS, NECKTIES, BELTS, BLOUSES, COATS, DRESSES, PAJAMAS, FOOTWEAR, SOCKS, UNDERWEAR, BANDANNAS, HEADBANDS, NECKBANDS, WRISTBANDS, BEACHWEAR, SWIMWEAR, VESTS, SKIRTS, SLEEPWEAR AND SUN VISORS (U.S. CLS. 22 AND 39).

FIRST USE 8-16-2005; IN COMMERCE 8-16-2005.

CLASS 41—EDUCATION AND ENTERTAINMENT

FOR ENTERTAINMENT SERVICES, NAMELY, CONDUCTING SKATEBOARDING COMPETITIONS AND EXHIBITIONS (U.S. CLS. 100, 101 AND 107).

FIRST USE 8-16-2005; IN COMMERCE 8-16-2005.

SONYA STEPHENS, EXAMINING ATTORNEY

SN 78-717,423. ZULUWORKS, LLC, SAN FRANCISCO, CA. FILED 9-21-2005.

ZULUWORKS

THE MARK CONSISTS OF STANDARD CHARACTERS WITHOUT CLAIM TO ANY PARTICULAR FONT, STYLE, SIZE, OR COLOR.

CLASS 9—ELECTRICAL AND SCIENTIFIC APPARATUS

FOR COMPUTER SOFTWARE FOR USE IN SCHEDULING THE RENTAL OF AVIATION EQUIPMENT AND AIRPLANES, COMPUTER SOFTWARE FOR USE AS A PILOT LOGBOOK, FLASHING SAFETY LIGHTS, SUNGLASSES, RADIO HEADSETS, AND SCALES (U.S. CLS. 21, 23, 26, 36 AND 38).

CLASS 16—PAPER GOODS AND PRINTED MATTER

FOR CLIPBOARDS, PERSONAL ORGANIZERS, KNEE BOARDS IN THE NATURE OF PERSONAL ORGANIZERS THAT ARE STRAPPED TO A PILOT'S LEG AND USED DURING FLIGHT, NOTE PADS, PRINTED AVIATION INFORMATION CARDS AND OTHER PRINTED MATERIAL, NAMELY, INSTRUCTIONAL MATERIALS FOR AVIATION-SPECIFIC CODES AND TERMINOLOGY (U.S. CLS. 2, 5, 22, 23, 29, 37, 38 AND 50).

FIRST USE 7-0-2003; IN COMMERCE 7-0-2003.

CLASS 18—LEATHER GOODS

FOR DUFFLE BAGS, SHOULDER BAGS, BACKPACKS, AND LUGGAGE (U.S. CLS. 1, 2, 3, 22 AND 41).

CLASS 35—ADVERTISING AND BUSINESS

FOR ONLINE RETAIL STORE SERVICES IN THE FIELD OF PILOT AND FLYING ACCESSORIES (U.S. CLS. 100, 101 AND 102).

FIRST USE 7-0-2003; IN COMMERCE 7-0-2003.
MELISSA VALLILLO, EXAMINING ATTORNEY

CLASS 30—STAPLE FOODS

FOR GROUND AND WHOLE BEAN COFFEE, COCOA, TEA, NAMELY, HERBAL AND NON-HERBAL, COFFEE, TEA, COCOA AND ESPRESSO, AND BEVERAGES MADE WITH A BASE OF COFFEE AND/OR ESPRESSO, TEA-BASED BEVERAGES WITH FRUIT FLAVORING, CHOCOLATE POWDER AND VANILLA, SYRUPS FOR BEVERAGES; BAKED GOODS, NAMELY, MUFFINS, SCONES, BISCUITS, COOKIES, PASTRIES AND BREADS, SANDWICHES, COCOA-BASED INGREDIENT IN CONFECTIONERY PRODUCTS; GRANOLA; PREPARED COFFEE AND TEA, ICE CREAM, MILK SHAKES AND FROZEN CONFECTIONS; CHOCOLATE, CANDY AND CANDY CONFECTIONS (U.S. CL. 46).

CLASS 32—LIGHT BEVERAGES

FOR BOTTLED WATER, MINERAL WATER, SPARKLING WATER, AND OTHER NON-ALCOHOLIC DRINKS, NAMELY, SOFT DRINKS, FRUIT DRINKS AND FRUIT JUICES, LIQUID AND POWDERED BEVERAGE MIXES FOR MAKING CARBONATED AND NON-CARBONATED SOFT DRINKS AND FRUIT DRINKS; FLAVORING SYRUPS FOR MAKING BEVERAGES; FLAVORED AND UNFLAVORED BOTTLED WATERS, SPARKLING WATERS, MINERAL WATERS, FRUIT JUICES, SPARKLING FRUIT AND JUICE BASED BEVERAGES AND SODA POP AND SODA WATER BEVERAGES; FROZEN FRUIT BEVERAGES AND FROZEN FRUIT-BASED BEVERAGES (U.S. CLS. 45, 46 AND 48).

CLASS 35—ADVERTISING AND BUSINESS

FOR BUSINESS ADMINISTRATION; BUSINESS MANAGEMENT; FRANCHISING, NAMELY, PROVIDING TECHNICAL ASSISTANCE IN THE ESTABLISHMENT AND/OR OPERATION OF RESTAURANTS, CAFES, COFFEE HOUSES AND SNACK BARS; RETAIL STORE SERVICES IN THE FIELD OF COFFEE, TEA, COCOA, PACKAGED AND PREPARED FOODS, ELECTRIC APPLIANCES, NON-ELECTRIC APPLIANCES, HOUSEWARES, KITCHENWARE, CLOCKS, WATCHES, KITCHEN TIMERS, STOP WATCHES, JEWELRY, BOOKS, MUSICAL RECORDINGS, MOUSE PADS, WALLETTS, BILLFOLDS, TOTE BAGS, PURSES, BRIEFCASES, BOOK BAGS, VALISES AND UMBRELLAS, ALL MADE OF CLOTH, PLASTIC OR LEATHER, KEY FOBBS OF LEATHER, CLOTHING, CAPS AND HATS, TOYS, TEDDY BEARS, STUFFED TOYS, PLUSH TOYS, DOLLS AND ACCESSORIES THEREFOR, CHRISTMAS ORNAMENTS; WHOLESALE DISTRIBUTORSHIPS, WHOLESALE STORES AND WHOLESALE ORDERING SERVICES ALL IN THE FIELD OF COFFEE, TEA, COCOA, PACKAGED AND PREPARED FOODS, ELECTRIC APPLIANCES, NON-ELECTRIC APPLIANCES, HOUSEWARES, KITCHENWARE, CLOCKS, WATCHES, KITCHEN TIMERS, STOP WATCHES, JEWELRY, BOOKS, MUSICAL RECORDINGS, MOUSE PADS, WALLETTS, BILLFOLDS, TOTE BAGS, PURSES, BRIEFCASES, BOOK BAGS, VALISES AND UMBRELLAS, ALL MADE OF CLOTH, PLASTIC OR LEATHER, KEY FOBBS OF LEATHER, CLOTHING, CAPS AND HATS, TOYS, NAMELY, TEDDY BEARS, STUFFED TOYS, PLUSH TOYS, DOLLS AND ACCESSORIES THEREFOR, CHRISTMAS ORNAMENTS; MAIL ORDER SERVICES AND MAIL ORDER CATALOG SERVICES, COMPUTERIZED ON-LINE ORDERING SERVICES, COMPUTERIZED ON-LINE RETAIL STORE SERVICES, ON-LINE ORDERING SERVICES AND ON-LINE RETAIL STORE SERVICES ALL IN THE FIELD OF COFFEE, TEA, COCOA, PACKAGED AND PREPARED FOODS, ELECTRIC APPLIANCES, NON-ELECTRIC APPLIANCES, HOUSEWARES, KITCHENWARE, CLOCKS, WATCHES, KITCHEN TIMERS, STOP WATCHES, JEWELRY, BOOKS, MUSICAL RECORDINGS, MOUSE PADS, WALLETTS, BILLFOLDS, TOTE BAGS, PURSES, BRIEFCASES, BOOK BAGS, VALISES AND UMBRELLAS, ALL MADE OF CLOTH, PLASTIC OR LEATHER, KEY FOBBS OF LEATHER, CLOTHING, CAPS AND HATS, TOYS, NAMELY, TEDDY BEARS, STUFFED TOYS, PLUSH TOYS, DOLLS AND ACCESSORIES THEREFOR, CHRISTMAS ORNAMENTS; COMPUTERIZED ON-LINE GIFT REGISTRY AND ORDERING SERVICE (U.S. CLS. 100, 101 AND 102).

SN 78-725,264. SEATTLE'S BEST COFFEE, LLC, SEATTLE, WA. FILED 10-3-2005.



OWNER OF U.S. REG. NOS. 2,127,370 AND 2,733,884.
NO CLAIM IS MADE TO THE EXCLUSIVE RIGHT TO USE "COFFEE SMOOTH ROASTED SINCE 1970", APART FROM THE MARK AS SHOWN.

THE COLOR(S) RED, GOLD AND WHITE IS/ARE CLAIMED AS A FEATURE OF THE MARK.

THE COLOR WHITE APPEARS IN THE WORDING "SEATTLE'S BEST COFFEE SMOOTH ROASTED SINCE 1970", AND IN TWO OF THE CONCENTRIC RINGS SURROUNDING THE OVAL DESIGN. THE COLOR RED APPEARS IN THE INTERIOR OF THE OVAL DESIGN AND BANDING DESIGN. THE COLOR YELLOW APPEARS IN THE INTERIOR OF THE BANDING AND AS LINING WITHIN THE OVAL DESIGN.

SEC. 2(F).

CLASS 43—HOTEL AND RESTAURANT SERVICES

FOR RESTAURANT, CAFE, CAFETERIA, SNACK BAR, COFFEE BAR AND COFFEE HOUSE, CARRY OUT RESTAURANT, AND TAKE OUT RESTAURANT SERVICES; CATERING SERVICES; COFFEE SUPPLY SERVICES FOR OFFICES; OFFICE COFFEE SUPPLY SERVICES; CONTRACT FOOD SERVICES; FOOD PREPARATION; PREPARATION OF CARRY OUT FOODS AND BEVERAGES (U.S. CLS. 100 AND 101).
TIMOTHY FINNEGAN, EXAMINING ATTORNEY

SN 78-752,556. LOWERCASE PEOPLE JUSTICE FUND, INC., BRENTWOOD,, TN. FILED 11-11-2005.

LOWERCASE PEOPLE

THE MARK CONSISTS OF STANDARD CHARACTERS WITHOUT CLAIM TO ANY PARTICULAR FONT, STYLE, SIZE, OR COLOR.

CLASS 9—ELECTRICAL AND SCIENTIFIC APPARATUS

FOR (BASED ON INTENT TO USE) ELECTRONIC PUBLICATIONS, NAMELY, MAGAZINES FEATURING INFORMATION ON MUSIC, ART, LITERATURE AND SOCIAL JUSTICE ISSUES RECORDED ON COMPUTER MEDIA; MUSICAL SOUND RECORDINGS; AUDIOVISUAL RECORDINGS FEATURING MUSIC AND DVDS FEATURING MUSIC VIDEOS; DOWNLOADABLE AUDIOVISUAL RECORDINGS FEATURING MUSIC; DOWNLOADABLE MUSIC SOUND RECORDINGS (U.S. CLS. 21, 23, 26, 36 AND 38).
FIRST USE 9-13-2005; IN COMMERCE 9-13-2005.

CLASS 14—JEWELRY

FOR (BASED ON INTENT TO USE) CHARITY BRACELETS (U.S. CLS. 2, 27, 28 AND 50).

CLASS 16—PAPER GOODS AND PRINTED MATTER

FOR (BASED ON USE IN COMMERCE) POSTCARDS, STICKERS AND NEWSPAPERZINES, NAMELY, MAGAZINE SUPPLEMENTS TO NEWSPAPERS IN THE FIELDS OF MUSIC, ART, SOCIAL JUSTICE AND CHARITABLE SERVICES; (BASED ON INTENT TO USE) PRINTED MATERIALS, NAMELY, MAGAZINES, NEWSLETTERS, BROCHURES, PAMPHLETS, INFORMATIONAL FLYERS AND BOOKS FEATURING THE FIELDS OF MUSIC, ART, SOCIAL JUSTICE, AND CHARITABLE SERVICES; POSTERS; ARTWORK, NAMELY, PRINTED ART REPRODUCTIONS, PRINTS (U.S. CLS. 2, 5, 22, 23, 29, 37, 38 AND 50).
FIRST USE 5-0-2005; IN COMMERCE 5-0-2005.

CLASS 25—CLOTHING

FOR (BASED ON USE IN COMMERCE) T-SHIRTS; (BASED ON INTENT TO USE)CLOTHING, NAMELY, HEADWEAR, BELTS, SCARVES, JOGGING SUITS, JACKETS (U.S. CLS. 22 AND 39).
FIRST USE 6-0-2005; IN COMMERCE 6-0-2005.

CLASS 35—ADVERTISING AND BUSINESS

FOR (BASED ON INTENT TO USE) PROVIDING INFORMATION ONLINE REGARDING POLITICAL ISSUES IN THE FIELD OF SOCIAL JUSTICE (U.S. CLS. 100, 101 AND 102).

CLASS 38—COMMUNICATION

FOR (BASED ON USE IN COMMERCE)STREAMING OF SOUND AND AUDIOVISUAL RECORDINGS FEATURING MUSIC ON THE INTERNET; (BASED ON INTENT TO USE) POD CASTING SERVICES, WEB CASTING SERVICES (U.S. CLS. 100, 101 AND 104).
FIRST USE 9-13-2005; IN COMMERCE 9-13-2005.

CLASS 41—EDUCATION AND ENTERTAINMENT

FOR (BASED ON USE IN COMMERCE)PROVIDING INFORMATION ONLINE IN THE FIELD OF MUSIC, ART AND LITERATURE (U.S. CLS. 100, 101 AND 107).
FIRST USE 9-13-2005; IN COMMERCE 9-13-2005.
KRISTINA MORRIS, EXAMINING ATTORNEY

SN 78-756,677. RETAIL OEM INTERNATIONAL, INC., COSTA MESA, CA. FILED 11-18-2005.

IDECOR HOME

THE MARK CONSISTS OF STANDARD CHARACTERS WITHOUT CLAIM TO ANY PARTICULAR FONT, STYLE, SIZE, OR COLOR.

NO CLAIM IS MADE TO THE EXCLUSIVE RIGHT TO USE "HOME", APART FROM THE MARK AS SHOWN.

CLASS 20—FURNITURE AND ARTICLES NOT OTHERWISE CLASSIFIED

FOR PICTURE FRAMES, MIRROR FRAMES, MIRRORS, FURNITURE, FURNITURE PARTS (U.S. CLS. 2, 13, 22, 25, 32 AND 50).

CLASS 21—HOUSEWARES AND GLASS

FOR HOLDERS FOR FLOWERS AND PLANTS (U.S. CLS. 2, 13, 23, 29, 30, 33, 40 AND 50).

CLASS 27—FLOOR COVERINGS

FOR NON-TEXTILE WALL HANGINGS (U.S. CLS. 19, 20, 37, 42 AND 50).
ELLEN PERKINS, EXAMINING ATTORNEY

SN 78-767,380. SE-KURE CONTROLS, INC., FRANKLIN PARK, IL. FILED 12-6-2005.

LE

THE MARK CONSISTS OF STANDARD CHARACTERS WITHOUT CLAIM TO ANY PARTICULAR FONT, STYLE, SIZE, OR COLOR.

CLASS 7—MACHINERY

FOR POWER AND MANUALLY OPERATED RETRACTING MECHANISMS FOR ELECTRICAL AND MECHANICAL CABLES (U.S. CLS. 13, 19, 21, 23, 31, 34 AND 35).

FIRST USE 12-31-1993; IN COMMERCE 12-31-1993.

CLASS 9—ELECTRICAL AND SCIENTIFIC APPARATUS

FOR ELECTROMECHANICAL THEFT, FIRE, AND ACCIDENT PREVENTION EQUIPMENT FOR PORTABLE OBJECTS, NAMELY, BURGLAR ALARMS; ELECTRONIC SENSORS FOR ATTACHING TO PORTABLE OBJECTS TO BE MONITORED AND ACCESSORIES THEREFOR, NAMELY, ADHESIVE ATTACHMENT LAYERS AND PADS SOLD AS A UNIT; ELECTRONIC CONTROL MODULES FOR ARMING, DISARMING, AND MONITORING THE STATE OF SENSORS; CONNECTION CABLES FOR COMMUNICATING BETWEEN THE CONTROL MODULES AND SENSORS AND ACCESSORIES THEREFOR, NAMELY, ELECTRICAL AND MECHANICAL END CONNECTORS SOLD AS A UNIT; AUDIBLE AND VISUAL ALARM SIGNAL GENERATORS THAT ARE ACTIVATED IN THE EVENT OF A SECURITY BREACH; ELECTRONIC SPLITTER MODULES FOR CONTROL SIGNALS; ELECTRONIC COMBINED CONTROL, SIGNAL SPLITTING, AND SIGNAL GENERATING MODULES; ELECTRONIC COMBINED CONTROL AND SIGNAL GENERATING MODULES; THEFT, FIRE, AND ACCIDENT PREVENTION SIGNAL LED'S/LIGHTS; SHUNT PLUGS FOR ELECTRICAL CONNECTIONS; CONVEX DETECTION AND ONE-WAY VIEWING MIRRORS; SIMULATED CLOSED CIRCUIT TELEVISION SCANNERS; HAND-HELD FIRE EXTINGUISHERS, EMERGENCY SIGNALING LIGHTS AND ALARMS (U.S. CLS. 21, 23, 26, 36 AND 38).

FIRST USE 12-31-1993; IN COMMERCE 12-31-1993.

CLASS 17—RUBBER GOODS

FOR ADHESIVE ATTACHMENT LAYERS AND PADS FOR ATTACHING ELECTRONIC SENSORS TO PORTABLE OBJECTS (U.S. CLS. 1, 5, 12, 13, 35 AND 50).

FIRST USE 12-31-1993; IN COMMERCE 12-31-1993.

JEFF DEFORD, EXAMINING ATTORNEY

SN 78-788,648. VILLAGE RESORTS LIMITED, KINGSTON 5, JAMAICA, FILED 1-10-2006.

HEDONISM

THE MARK CONSISTS OF STANDARD CHARACTERS WITHOUT CLAIM TO ANY PARTICULAR FONT, STYLE, SIZE, OR COLOR.

OWNER OF JAMAICA REG. NO. 41365, DATED 10-10-2001, EXPIRES 10-10-2011.

OWNER OF U.S. REG. NOS. 2,271,059, 2,348,958 AND OTHERS.

CLASS 43—HOTEL AND RESTAURANT SERVICES

FOR PROVIDING FOOD AND DRINK, NAMELY, RESTAURANT SERVICES; PROVIDING TEMPORARY ACCOMMODATIONS (U.S. CLS. 100 AND 101).

CLASS 44—MEDICAL, BEAUTY AND AGRICULTURAL SERVICES

FOR PROVIDING HEALTH AND BEAUTY CARE, NAMELY, BEAUTY SALONS AND HEALTH AND BEAUTY SPAS, NAMELY, COSMETIC BODY CARE SERVICES (U.S. CLS. 100 AND 101).

SANI KHOURI, EXAMINING ATTORNEY

SN 78-850,341. BUNN-O-MATIC CORPORATION, SPRINGFIELD, IL. FILED 3-30-2006.

SIGNATURE SERIES

THE MARK CONSISTS OF STANDARD CHARACTERS WITHOUT CLAIM TO ANY PARTICULAR FONT, STYLE, SIZE, OR COLOR.

NO CLAIM IS MADE TO THE EXCLUSIVE RIGHT TO USE "SERIES", APART FROM THE MARK AS SHOWN.

CLASS 7—MACHINERY

FOR ELECTRIC COFFEE GRINDERS FOR DOMESTIC AND COMMERCIAL USE (U.S. CLS. 13, 19, 21, 23, 31, 34 AND 35).

CLASS 11—ENVIRONMENTAL CONTROL APPARATUS

FOR TEMPERATURE-CONTROLLED BEVERAGE DISPENSERS, NAMELY, HEATED BEVERAGE DISPENSING UNITS FOR COMMERCIAL USE AND COMPONENTS THEREOF; BEVERAGE BREWING EQUIPMENT, NAMELY, ELECTRIC DRIP TEA MAKERS; HEATED PORTABLE BEVERAGE DISPENSING UNITS; TEMPERATURE CONTROLLED PORTABLE HOT BEVERAGE MAKING AND HOT WATER DISPENSING MACHINES SOLD AS A UNIT THEREWITH; ELECTRIC COFFEE URNS; ELECTRIC BEVERAGE AND WATER WARMERS; ELECTRIC TEA AND ELECTRIC ICED TEA BREWERS FOR COMMERCIAL USE (U.S. CLS. 13, 21, 23, 31 AND 34).

LAURA HAMMEL, EXAMINING ATTORNEY

SN 78-874,366. ADSENSA LTD., NEWBURY, BERKSHIRE, UNITED KINGDOM, FILED 5-2-2006.



PRIORITY CLAIMED UNDER SEC. 44(D) ON ERP N CMNTY TM OFC APPLICATION NO. 004700977, FILED 11-3-2005, REG. NO. 004700977, DATED 12-8-2006, EXPIRES 11-2-2015.

THE COLOR(S) AQUAMARINE, RED, ORANGE, YELLOW, GREEN AND PURPLE IS/ARE CLAIMED AS A FEATURE OF THE MARK.

THE MARK CONSISTS OF LETTERING IN THE COLOR AQUAMARINE, WHILE THE PETALS ARE CLOCKWISE FROM THE TOP: RED, ORANGE, YELLOW, GREEN AND PURPLE.

CLASS 9—ELECTRICAL AND SCIENTIFIC APPARATUS

FOR COMPUTER OPERATING PROGRAMS; COMPUTER SOFTWARE, NAMELY, DOCUMENT ANALYSIS, DOCUMENT COMPARISON AND REPORTING TOTAL SOFTWARE; BLANK CD ROMS FOR SOUND OR VIDEO RECORDINGS; BLANK RECORDABLE DVDS; PRE-RECORDED CDS, VIDEO TAPES, LASER DISCS AND DVDS FEATURING ADVICE AND INFORMATION REGARDING DOCUMENT ANALYSIS, DOCUMENT COMPARISON AND REPORTING TOOL SOFTWARE; DISC MEMORIES; PERIPHERAL MEMORY PRODUCTS, NAMELY, SOLID STATE MEMORIES; SOLID STATE MEMORIES IN THE FORM OF CARDS OR SOLID STATE DRIVES; HARD DISCS FOR COMPUTERS; OPTICAL DISCS FEATURING DOCUMENT ANALYSIS, DOCUMENT COMPARISON AND REPORTING TOTAL SOFTWARE; BLANK MAGNETIC DISCS; BLANK MAGNETO-OPTICAL DISCS; BLANK MAGNETIC TAPES; SEMI-CONDUCTOR MEMORIES; COMPUTER SOFTWARE FOR USE IN DOCUMENT MANAGEMENT, DOCUMENT COMPARISON, DOCUMENT ANALYSIS, DOCUMENT MERGING, DOCUMENT MATCHING, DOCUMENT CATEGORIZATION, DOCUMENT CONSOLIDATION, COMPUTER SOFTWARE IN THE FIELD OF CONSULTANCY AND ADVISORY SERVICES; COMPUTER SOFTWARE IN THE FIELD OF DESIGN (U.S. CLS. 21, 23, 26, 36 AND 38).

CLASS 42—SCIENTIFIC AND COMPUTER SERVICES

FOR COMPUTER PROGRAMMING, LEASING OF COMPUTERS, RENTAL OF COMPUTERS, COMPUTER SYSTEMS AND COMPUTER SOFTWARE; COMPUTER SERVICES, NAMELY, PROVIDING ADVISORY AND CONSULTANCY SERVICES RELATING TO COMPUTER SOFTWARE (U.S. CLS. 100 AND 101).

INGA ERVIN, EXAMINING ATTORNEY

CLASS 12—VEHICLES

FOR AUTOMOBILE, MILITARY VEHICLE, TRAILER AND TRUCK PARTS, NAMELY, SPRINGS, AIR BEAMS FOR AIR SUSPENSIONS COMPRISED OF SPRINGS, AIR BEAMS, U-BOLTS, BRACKETS, SHOCK ABSORBERS AND HANGERS, SUSPENSIONS, COMPRISED OF SPRINGS, AIR BEAMS, U-BOLTS, BRACKETS AND HANGERS, SUSPENSION COMPONENTS, COMPRISED OF SPRINGS, AIR BEAMS, U-BOLTS, BRACKETS, SHOCK ABSORBERS, AND HANGERS, AIR SUSPENSIONS FOR TRAILERS, RUBBER TORSION TRAILER SUSPENSIONS, TRAILER HITCHES, STABILIZER BARS FOR TRUCKS, AUTOMOBILES AND TRAILERS, TAND-EM BUSHINGS, TRAILER AXLES AND RUNNING GEAR, COMPRISED OF AXLES, BRAKES, SPRINGS OR AIR BEAMS, U-BOLTS, BRACKETS, SHOCK ABSORBERS, AND HANGERS; DRIVE SHAFTS, U-BOLTS AND THREADED PRODUCTS, NAMELY, PINS, BUSHINGS, HANGERS, AND OTHER SPRING MOUNTING PARTS (U.S. CLS. 19, 21, 23, 31, 35 AND 44).

FIRST USE 0-0-1924; IN COMMERCE 0-0-1924.

CLASS 35—ADVERTISING AND BUSINESS

FOR WHOLESALE DISTRIBUTORSHIPS FEATURING PARTS OF AUTOMOBILES, TRAILER AND TRACK PARTS, FARM MACHINERY PARTS, TRACK VEHICLE PARTS AND PARTS FOR MILITARY EQUIPMENT (U.S. CLS. 100, 101 AND 102).

FIRST USE 0-0-1924; IN COMMERCE 0-0-1994.

CLASS 40—MATERIAL TREATMENT

FOR CUSTOM MANUFACTURING TO THE SPECIFICATION OF OTHERS OF AUTOMOBILE, TRAILER AND TRUCK PARTS, FARM MACHINERY PARTS, TRACK VEHICLE PARTS AND PARTS FOR MILITARY EQUIPMENT (U.S. CLS. 100, 103 AND 106).

FIRST USE 0-0-1924; IN COMMERCE 0-0-1994.

DAWN FELDMAN, EXAMINING ATTORNEY

SN 78-877,824. STANDEN'S LIMITED, CALGARY, ALBERTA, CANADA, FILED 5-5-2006.

SN 78-886,703. CRYSTAL JADE CULINARY CONCEPTS HOLDING PTE. LTD., SINGAPORE, SINGAPORE, FILED 5-18-2006.

STANDEN'S



THE MARK CONSISTS OF STANDARD CHARACTERS WITHOUT CLAIM TO ANY PARTICULAR FONT, STYLE, SIZE, OR COLOR.
SEC. 2(F).

CLASS 7—MACHINERY

FOR OFF HIGHWAY AND FARM MACHINERY PARTS, NAMELY, DRAW BARS AND SHANKS, AGRICULTURAL CHISEL PLOW POINTS, TILLAGE TOOLS, NAMELY, SHANKS AND RIPPERS, TRACK VEHICLE GROUSER BARS AND RELATED ASSEMBLY PARTS (U.S. CLS. 13, 19, 21, 23, 31, 34 AND 35).

FIRST USE 0-0-1924; IN COMMERCE 0-0-1924.

OWNER OF SINGAPORE REG. NO. T00/08685C, DATED 8-3-1999, EXPIRES 8-3-2009.

OWNER OF SINGAPORE REG. NO. T01/01619C, DATED 2-13-2001, EXPIRES 2-13-2011.

THE MARK CONSISTS OF THE LETTER "C" INSIDE A BOX.

CLASS 30—STAPLE FOODS

FOR CONFECTIONERY, NAMELY, JAMS, ALMOND CONFECTIONERY; BISCUITS; BREAD; GINGER-BREAD; BREAD ROLLS; BUNS; CAKE PASTE; CAKES; FLAVORINGS FOR CAKES OTHER THAN ESSENTIAL OILS; RICE CAKES; CANDY FOR FOOD; CHOCOLATE; COOKIES; EDIBLE DECORATIONS FOR CAKES; CONFECTIONERY FONDANTS; FARINACEOUS FOOD PASTES FOR HUMAN CONSUMPTION; FRUIT JELLIES; MEAT PIES; NOODLES; PANCAKES; PASTRIES; PASTIES; PEANUT CONFECTIONERY; PIES; PIZZAS; PRALINES; PUDDINGS; SANDWICHES; SUGAR CONFECTIONERY; SUSHI; SWEETMEATS; TARTS; WAFLES; MOONCAKES; DUMPLINGS; TEA CAKES; BREAKFAST CAKES; SAUCES; CHILI SAUCES AND PASTES; SEASONINGS; SOYA SAUCES; SPICES; CONDIMENTS, NAMELY, CHUTNEY, HONEY, KETCHUP, MUSTARD (U.S. CL. 46).

CLASS 43—HOTEL AND RESTAURANT SERVICES

FOR CAFE SERVICES; CAFETERIA SERVICES; CANTEN SERVICES; CATERING SERVICES; COCKTAIL LOUNGE SERVICES; RESTAURANTS; SELF-SERVICE RESTAURANT SERVICES; SNACK-BAR SERVICES (U.S. CLS. 100 AND 101).

SHAUNIA CARLYLE, EXAMINING ATTORNEY

SN 78-886,707. CRYSTAL JADE CULINARY CONCEPTS HOLDING PTE. LTD., SINGAPORE, SINGAPORE, FILED 5-18-2006.

OWNER OF SINGAPORE REG. NO. T00/08683G, DATED 8-3-1999, EXPIRES 8-3-2009.

OWNER OF SINGAPORE REG. NO. T01/01620G, DATED 2-13-2001, EXPIRES 2-13-2011.

THE MARK CONSISTS OF CHINESE CHARACTERS. THE FOREIGN WORDING IN THE MARK TRANSLATES INTO ENGLISH AS JADEITE.

THE NON-LATIN CHARACTER(S) IN THE MARK TRANSLITERATES INTO FEI CUI, AND THIS MEANS JADEITE IN ENGLISH.

CLASS 30—STAPLE FOODS

FOR CONFECTIONERY, NAMELY, JAMS, ALMOND CONFECTIONERY; BISCUITS; BREAD; GINGER-BREAD; BREAD ROLLS; BUNS; CAKE PASTE; CAKES; FLAVORINGS FOR CAKES OTHER THAN ESSENTIAL OILS; RICE CAKES; CANDY FOR FOOD; CHOCOLATE; COOKIES; EDIBLE DECORATIONS FOR CAKES; CONFECTIONERY FONDANTS; FARINACEOUS FOOD PASTES FOR HUMAN CONSUMPTION; FRUIT JELLIES; MEAT PIES; NOODLES; PANCAKES; PASTRIES; PASTIES; PEANUT CONFECTIONERY; PIES; PIZZAS; PRALINES; PUDDINGS; SANDWICHES; SUGAR CONFECTIONERY; SUSHI; SWEETMEATS; TARTS; WAFLES; MOONCAKES; DUMPLINGS; TEA CAKES; BREAKFAST CAKES; SAUCES; CHILI SAUCES AND PASTES; SEASONINGS; SOYA SAUCES; SPICES; CONDIMENTS, NAMELY, CHUTNEY, HONEY, KETCHUP, MUSTARD (U.S. CL. 46).

CLASS 43—HOTEL AND RESTAURANT SERVICES

FOR CAFE SERVICES; CAFETERIA SERVICES; CANTEN SERVICES; CATERING SERVICES; COCKTAIL LOUNGE SERVICES; RESTAURANTS; SELF-SERVICE RESTAURANT SERVICES; SNACK-BAR SERVICES (U.S. CLS. 100 AND 101).

SHAUNIA CARLYLE, EXAMINING ATTORNEY

SN 78-899,996. SAENZ-SALDANA, THERESE, LANGLEY, CANADA, FILED 6-4-2006.

SANTA'S CHOICE

THE MARK CONSISTS OF STANDARD CHARACTERS WITHOUT CLAIM TO ANY PARTICULAR FONT, STYLE, SIZE, OR COLOR.

CLASS 35—ADVERTISING AND BUSINESS

FOR RETAIL AND WHOLESALE SERVICES, NAMELY, RETAIL AND WHOLESALE SERVICES BY MAIL ORDER AND THE INTERNET FEATURING HAMPER AND GIFT PACKS, FOOD, BEVERAGES, GROCERIES, HOUSEHOLD APPLIANCES HOMEWARE, CLOTHING, FOOTWEAR, HEADGEAR, TOYS, GAMES, PLAYTHINGS, BICYCLES, SPORTING EQUIPMENT, CAMPING EQUIPMENT, LEISURE EQUIPMENT, STATIONERY, BOOKS, JEWELRY, CLEANING PRODUCTS, CUTLERY AND GLASSWARE, PERSONAL AND HOUSEHOLD ITEMS; OPERATION OF CUSTOMER LOYALTY PROGRAMS AND INCENTIVE SCHEMES FOR COMMERCIAL, PROMOTIONAL AND ADVERTISING PURPOSES; ADVERTISING AND MARKETING SERVICES (U.S. CLS. 100, 101 AND 102).

CLASS 36—INSURANCE AND FINANCIAL

FOR FINANCIAL SERVICES, NAMELY, CHRISTMAS CLUB SAVINGS ACCOUNTS (U.S. CLS. 100, 101 AND 102).

FLORENTINA BLANDU, EXAMINING ATTORNEY

SN 78-933,379. GMR HOLDINGS PVT. LTD., BANGALORE, INDIA, FILED 7-19-2006.

OWNER OF INDIA REG. NO. 703694, DATED 11-16-2005, EXPIRES 11-16-2015.

CLASS 36—INSURANCE AND FINANCIAL

FOR REAL ESTATE AFFAIRS, NAMELY, REAL ESTATE AGENCY, VALUATION OF REAL ESTATE, LEASING OF REAL ESTATE, MANAGEMENT OF REAL ESTATE; INSURANCE SERVICES, NAMELY INSURANCE AGENCY, INSURANCE CONSULTATION, INSURANCE INFORMATION, INSURANCE UNDERWRITING FOR ALL TYPES OF INSURANCE, INSURANCE BROKERAGE; FINANCIAL CONSULTATION; COMMODITY BROKERAGE; LEASING OF REAL ESTATE; FINANCIAL VALUATION OF PERSONAL PROPERTY AND REAL ESTATE; AND REAL ESTATE FINANCE INVESTMENTS AND CONSULTATIONS; BANKING ESTABLISHMENTS; STOCK BROKERAGE; TRUST SERVICES, NAMELY, INVESTMENT AND TRUST COMPANY SERVICES; CREDIT AGENCIES (U.S. CLS. 100, 101 AND 102).

SN 79-012,440. IGOR AKRAPOVIC, SLOVENIA, FILED 5-18-2005.



OWNER OF INTERNATIONAL REGISTRATION 0825461 DATED 8-1-2003, EXPIRES 8-1-2013.

NO CLAIM IS MADE TO THE EXCLUSIVE RIGHT TO USE "EXHAUST SYSTEM TECHNOLOGY", APART FROM THE MARK AS SHOWN.

THE COLOR(S) RED, BLACK, AND YELLOW IS/ARE CLAIMED AS A FEATURE OF THE MARK.

THE MARK CONSISTS OF THE COLOR RED APPEARS IN THE MISCELLANEOUS DESIGN AND IN THE WORDING "EXHAUST SYSTEM TECHNOLOGY". THE WORD "AKRAPOVIC" IS IN YELLOW, AND THE OVAL SHAPED BACKGROUND IS BLACK. THE OVAL IS TRIMMED IN YELLOW.

CLASS 37—CONSTRUCTION AND REPAIR

FOR SERVICES OF BUILDING CONSTRUCTION; BUILDING REPAIR; REPAIR OF INFRASTRUCTURES, NAMELY, REPAIR INFORMATION, UNDERWATER REPAIR, REPAIR OF ELEVATORS, REPAIR OF ELECTRICAL INSTALLATIONS, REPAIR OF HEATING EQUIPMENTS, ROOF REPAIR, FURNITURE RESTORATION; INSTALLATION SERVICES, NAMELY, INSTALLATIONS IN HEATING AND ELECTRICAL EQUIPMENT INSTALLATIONS IN BUILDINGS, INSTALLATIONS OF SEWAGE SEEPAGE SYSTEM IN BUILDINGS, INSTALLATION OF WATER DRAINAGE SYSTEMS IN BUILDINGS; CONSTRUCTION SERVICES, NAMELY, AIRPORTS, RAILWAY STATIONS, METRO STATIONS, RAILWAY TRACKS, METRO LINES, ROADS, TUNNELS, BUS STANDS, TERMINALS, DRAINS, TOWERS, BRIDGES, SUBWAYS, RESIDENTIAL COMPLEXES, OFFICE COMPLEXES, SHOPPING MALLS, RETAIL MARKETS; CONTRACTOR SERVICES, NAMELY, PLUMBING, ELECTRICAL FITTINGS, HEATING, SEWAGE SEEPAGE, ELEVATORS; BUILDING MAINTENANCE (U.S. CLS. 100, 103 AND 106).

CLASS 4—LUBRICANTS AND FUELS

FOR AUTOMOTIVE GREASES, NAMELY, GREASES FOR BELTS; GASOLINE, NAMELY, BENZENE; LUBRICATING OIL AND GREASE FOR MOTOR VEHICLE ENGINES; INDUSTRIAL OILS; MOTOR OIL; KEROSENE; FUELS; NAPHTA (U.S. CLS. 1, 6 AND 15).

CLASS 6—METAL GOODS

FOR ALLOY STEEL SCRAPS; STEEL ALLOYS IN THE FORM OF STEEL BANDS, STEEL STRIPS AND STEEL WIRE; STEEL TUBES, NAMELY, EXHAUST TUBES; STEEL PLATES AND SHEETS; UNWROUGHT OR SEMI-WROUGHT STEEL; METAL MACHINE BELT FASTENERS; FITTINGS OF METAL FOR COMPRESSES AIR DUCTS; METAL ALLOYS; WIRES OF COMMON METAL ALLOYS EXCEPT FUSES; METAL REINFORCING MATERIAL FOR HEATING OR AIR CONDITIONING DUCTS; METAL REINFORCING MATERIAL TO BE USED ON METAL BELTS FOR HANDLING LOADS; COLLARS OF METAL FOR FASTENING PIPES; METAL CABLE CLIPS; RING SHAPED FITTINGS OF METAL; METAL BRAZING RODS AND METAL WELDING RODS; METAL BEAK IRONS; METAL BUILDING MATERIALS, NAMELY, WHITE METAL; FLANGE COLLARS OF METAL FOR ARMOR PLATING; STEEL IN THE FORM OF IRON SLABS; METAL BRAZING RODS; METAL FLANGES; METAL CHAINS; METAL FASTENERS, NAMELY, METALLIC BOLTS; COTTER PINS; METAL WINDING KEYS FOR LOCKS; METAL LATCH BARS; PENSTOCK PIPES MADE OF METAL; METAL ROPES; ELBOWS OF METAL FOR PIPES; BELT STRETCHERS OF METAL; METAL CRAMPONS; NON-ELECTRIC METAL CABLES; BRANCHING PIPES OF METAL; IRON AND NON-FERROUS METAL IN THE FORM OF IRON STRIPS; BARBED WIRE AND METAL CABLE WIRE; CHROME IRON ORE; WIRE ROPE; METAL WIRE; UNWROUGHT OR SEMI-WROUGHT CAST IRON; METAL GREASE NIPPLES; METAL GRATINGS; METAL REGISTRATION PLATES; LETTER BOXES MADE OF METAL AND METAL HOUSE NUMBERS; METAL BINDING STRIPS USED ON PACKAGING; FILINGS OF METAL; CABLE JUNCTION SLEEVES OF METAL; BELTS AND SLINGS OF METAL FOR HANDLING LOADS; METAL VICE CLAWS; METAL POLES; GIRDERS OF METAL; METAL PIPE COUPLINGS AND JOINTS; METAL RIVETS; METAL CONTAINERS FOR LIQUID FUEL; METAL FLUID STORAGE TANKS; METAL WHEEL CLAMPS; METAL SOLDERING WIRE; METAL HOPPERS; METAL TUBES, NAMELY, EXHAUST TUBES; METAL TILES; METAL PIPES; METAL FLOOR TILES; METAL JUNCTION FOR PIPES; MANUALLY OPERATED METAL VALVES; FERRULES OF METAL FOR CANES AND WALKING STICKS; METAL SCREWS; METAL NUTS; METAL VICE BENCHES; STIRRUPS OF METAL (U.S. CLS. 2, 12, 13, 14, 23, 25 AND 50).

CLASS 39—TRANSPORTATION AND STORAGE

FOR SERVICES OF TRANSPORT, NAMELY, AIRLINE TRANSPORTATION, TRANSPORTATION OF PASSENGERS AND GOODS BY RAIL, TRANSPORTATION OF PASSENGERS AND GOODS BY ROAD; TRAVEL ARRANGEMENT; AIR TRANSPORT; SERVICES CONNECTED TO HIRING OF TRANSPORT VEHICLES, NAMELY, MAKING RESERVATIONS AND BOOKINGS FOR TRANSPORTATION; PACKAGING AND PARCELING OF MERCHANDISE BEFORE DISPATCH; CARGO HANDLING; UNLOADING OF CARGOES (U.S. CLS. 100 AND 105).

REBECCA EISINGER, EXAMINING ATTORNEY

CLASS 7—MACHINERY

FOR ENGINES AND MOTORS FOR NON-TERRESTRIAL VEHICLES; ENGINES AND MOTORS FOR MACHINES, EQUIPMENT FOR MACHINES, MOTORS AND ENGINES, NAMELY, COUPLINGS OTHER THAN FOR LAND VEHICLES; NEEDLE BEARINGS; COMPRESSED AIR ENGINES; MACHINE FILTERS FOR CLEANING COOLING AIR FOR MOTORS AND ENGINES; IGNITING DEVICES FOR INTERNAL COMBUSTION ENGINES; IGNITING MAGNETOS; ALTERNATORS FOR VEHICLES; SHOCK ABSORBER PLUNGERS FOR MACHINES; ANTI-FRICTION PADS FOR MACHINES; ANTI-FRICTION BEARINGS FOR MACHINES; ANTI-POLLUTION DEVICES FOR MOTORS AND ENGINES; AXLES FOR MACHINES; TRANSMISSION SHAFTS NOT FOR LAND VEHICLES; SELF-OILING BEARINGS; AIRPLANE ENGINES; AERONAUTICAL ENGINES; GREASE RINGS BEING PART OF MACHINES; PISTON RINGS; DYNAMO BRUSHES; MOTORS FOR BOATS; BICYCLE DYNAMOS; CONNECTING RODS FOR MACHINES; STARTERS FOR MOTORS AND ENGINES; EMBOSSING MACHINES; MUD CATCHERS AND COLLECTORS FOR MACHINES; DIESEL ENGINE HEATERS; GREASE BOXES; GEAR BOXES NOT FOR LAND VEHICLES; OIL AND GAS WELLHEAD TOOLS AND EQUIPMENT, NAMELY, STUFFING BOXES; GRINDING MACHINES; MACHINE HOUSINGS; CATALYTIC CONVERTERS FOR MOTORS AND ENGINES; CARBURETORS; UNIVERSAL JOINTS; MACHINE PARTS, NAMELY, METAL CARD CLOTHING; VEHICLE ENGINE PARTS, NAMELY, CRANKCASE BREATHERS; REFRIGERATION COMPRESSORS AND ACCESSORIES, NAMELY, BEARING BRACKETS; SLIDE RESTS FOR MACHINES; PIPES FOR BOILERS; DRIVING CHAINS NOT FOR LAND VEHICLES; CLACK VALVES; FUEL CONVERSION APPARATUS FOR INTERNAL COMBUSTION ENGINES; CONTROL CABLES FOR MACHINES; HYDRAULIC AND PNEUMATIC CONTROLS FOR MACHINES, ENGINES AND MOTORS; COMPRESSORS; GEAR CUTTERS; DRILLING HEADS; FAN BELTS FOR MACHINES; BELTS FOR MOTORS AND ENGINES; CYLINDER HEADS FOR ENGINES; PISTONS FOR CYLINDERS; CYLINDERS FOR MACHINES; CYLINDERS FOR MOTORS AND ENGINES; STARTERS FOR MOTORS AND ENGINES; REDUCTION GEARS NOT FOR LAND VEHICLES; MECHANICAL REELS; MECHANICAL REELS FOR FLEXIBLE HOSES; SWAGING MACHINES; DIE-STAMPING MACHINES; METAL-WORKING MACHINES; THREADING MACHINES; FILTERS; DRILL CHUCKS FOR MACHINES; BRAKE LININGS FOR OTHER THAN VEHICLES; BRAKE SHOES NOT FOR LAND VEHICLES; BRAKE SEGMENTS NOT FOR LAND VEHICLES; LUBRICATORS FOR MACHINES; ENGRAVING MACHINES; EMERGENCY POWER GENERATORS; HYDRAULIC ENGINES AND MOTORS; EMERGENCY POWER GENERATORS; INJECTORS FOR ENGINES; THERMAL LANCES USING OXYGEN; WHEELS BEING PART OF MACHINES; CHUCKS FOR POWER DRILLS; EXHAUST MANIFOLDS FOR ENGINES; INDUSTRIAL MANIPULATORS FOR MACHINES; HAMMERS THAT ARE A PART OF MACHINES; IGNITING MAGNETOS FOR ENGINES; SPEED CONTROLLERS FOR MOTORS AND ENGINES; CHAIN TACKLE BLOCKS; LUBRICATING PUMPS; VACUUM PUMPS; MACHINE TOOL HOLDERS; SILENCERS AS PART OF VEHICLE EXHAUST SYSTEMS; PRESSURE REGULATORS FOR MACHINES; PRESSURE VALVES FOR MACHINES; PROPULSION MECHANISMS NOT FOR LAND VEHICLES; STEAM TRAPS FOR MACHINES; RADIATORS; SPRINGS FOR MACHINES; RIVETING MACHINES; TAPS FOR MACHINES; INDUSTRIAL ROBOTS; MACHINE FLY-WHEELS FOR OTHER THAN LAND VEHICLES; JET ENGINES FOR OTHER THAN LAND VEHICLES; REGULATORS FOR MACHINES; CYCLONE, OIL AND DUST SEPARATORS; DIE-CUTTING AND TAPPING MACHINES; STAMPING MACHINES; CONVEYORS; TURBINES FOR OTHER THAN LAND VEHICLES; VEHICLE ENGINE PARTS, NAMELY, OIL TANKS; FAN BELTS FOR MOTORS AND ENGINES; VIBRATORS FOR MACHINES; MACHINE FLY WHEELS; ENGINES FOR USE IN AIR-CUSHION VEHICLES; ELECTRIC MOTORS FOR OTHER THAN LAND VEHICLES; AND WIRE DRAWING MACHINES (U.S. CLS. 13, 19, 21, 23, 31, 34 AND 35).

CLASS 12—VEHICLES

FOR COUPLINGS FOR LAND VEHICLES; INNER TUBES FOR PNEUMATIC TIRES; AMBULANCES; SHOCK ABSORBING SPRINGS FOR VEHICLES; SUSPENSION SHOCK ABSORBERS; NON-SKID DEVICES FOR VEHICLE TIRES, INCLUDING TIRE CHAINS; ANTI-THEFT DEVICES FOR VEHICLES; TRANSMISSION SHAFTS FOR LAND VEHICLES; TRAILER HITCHES FOR VEHICLES; MOTOR HOMES; AUTOMOBILES; SHOCK ABSORBERS FOR AUTOMOBILES; AUTOMOBILE TIRES; AUTOMOBILE HOODS; AUTOMOBILE CHAINS; AUTOMOBILE CHASSIS; HORNS FOR VEHICLES; AIRPLANES; AIR VEHICLES; AIR-CUSHION VEHICLES; VALVES FOR VEHICLE TIRES; TIRES FOR VEHICLE WHEELS; TIPPING CARTS; SCREW PROPELLERS FOR BOATS; BICYCLE TIRES; BICYCLE FRAMES; INNER TUBES FOR BICYCLES; BICYCLE BRAKES; DIRECTION INDICATORS FOR BICYCLES; BICYCLE RIMS; BICYCLE PUMPS; BICYCLE SPOKES; CONNECTING RODS FOR LAND VEHICLES, OTHER THAN PARTS OF MOTORS AND ENGINES; MUD FLAPS, MUDGUARDS; TUBELESS TIRES FOR CYCLES; CAISSON VEHICLES; HOODS FOR VEHICLES; HOUSE TRAILERS; CRANKCASES FOR COMPONENTS FOR LAND VEHICLES OTHER THAN FOR ENGINES; SAFETY BELTS FOR VEHICLE SEATS; LAUNCHES; REPAIR OUTFITS FOR INNER TUBES; ANTI-SKID CHAINS; DRIVING CHAINS FOR LAND VEHICLES; CYCLE CHAINS; TRANSMISSION CHAINS FOR LAND VEHICLES; TREADS FOR VEHICLES; HYDRAULIC CIRCUITS FOR VEHICLES; TORQUE CONVERTERS FOR LAND VEHICLES; CYCLE CARS; CRANKS FOR CYCLES; MOTORS FOR CYCLES; CYCLE HUBS; PEDALS FOR CYCLES; DIRECTION SIGNALS FOR VEHICLES; HAND CARS; REDUCTION GEARS FOR LAND VEHICLES; CLUTCHES FOR LAND VEHICLES; GEARING FOR LAND VEHICLES; GEARS FOR CYCLES; BICYCLES AND MOTORCYCLES; HUBCAPS; LAND VEHICLE PARTS, NAMELY, AXLES; WHEELCHAIRS; BRAKE LININGS FOR VEHICLES; BRAKE SHOES FOR VEHICLES; REFRIGERATED VEHICLES; RUDDERS FOR VESSELS; REFRIGERATED TRAILERS; SADDLE COVERS FOR BICYCLES OR MOTORCYCLES; ENGINES FOR LAND VEHICLES; MOTOR BICYCLES; MOTORCYCLES; HUBS FOR MOTORCYCLE WHEELS; WATER VEHICLES; VEHICLE BUMPERS; PNEUMATIC TIRES; TREADS FOR RETREADING TIRES; AIR PUMPS; PROPULSION MECHANISMS FOR LAND VEHICLES, INCLUDING ENGINES AND TRANSMISSIONS; SPOKE CLIPS FOR WHEELS; TRAILERS; VEHICLE SUSPENSION SPRINGS; JET ENGINES FOR LAND VEHICLES; SADDLES FOR CYCLES, BICYCLES OR MOTORCYCLES; SIDECARS; VEHICLE SEATS; SPORTS CARS; TRACTORS; UNDERCARRIAGES FOR VEHICLES; DELIVERY TRICYCLES; AIR TURBINES FOR LAND VEHICLES; WINDOWS FOR VEHICLES; CARS; SPACE VEHICLES; ELECTRIC DRIVES FOR VEHICLES; MOPEDS; ELECTRIC MOTORS FOR MOTOR CARS (U.S. CLS. 19, 21, 23, 31, 35 AND 44).

CLASS 35—ADVERTISING AND BUSINESS

FOR RETAIL STORE AND DISTRIBUTORSHIP SERVICES IN THE FIELD OF FUEL, ORES, METALS AND CHEMICAL PRODUCTS FOR TECHNICAL USE; ON-LINE RETAIL STORE SERVICES IN THE FIELD OF FUEL, ORES, METALS AND CHEMICAL PRODUCTS FOR TECHNICAL USE; RETAIL STORE AND DISTRIBUTORSHIP SERVICES IN THE FIELD OF MACHINES, INDUSTRIAL EQUIPMENT, AIRPLANES, BOATS, CARS, PARTICULARLY MOTORCYCLES, SPARE PARTS FOR CARS AND PARTICULARLY MOTORCYCLES, AND ACCESSORIES AND PARTS THEREOF; ON-LINE RETAIL STORE SERVICES IN THE FIELD OF MACHINES, INDUSTRIAL EQUIPMENT, AIRPLANES, BOATS, CARS, PARTICULARLY MOTORCYCLES, SPARE PARTS FOR CARS AND PARTICULARLY MOTORCYCLES, AND ACCESSORIES AND PARTS THEREOF; ADVERTISING AND MARKETING SERVICES (U.S. CLS. 100, 101 AND 102).

CLASS 37—CONSTRUCTION AND REPAIR

FOR MAINTENANCE AND REPAIR OF CARS, NAMELY, MOTOR CARS AND MOTORCYCLES; MAINTENANCE AND REPAIR OF AIRPLANES; BOILER CLEANING AND REPAIR; BURNER MAINTENANCE AND REPAIR; AIR-CONDITIONING INSTALLATION AND REPAIR; VEHICLE LUBRICATION; RENTAL OF CLOTHES WASHING MACHINES; INSTALLATION, REPAIR AND MAINTENANCE OF MACHINES; PLUMBING SERVICES; VEHICLE POLISHING; TIRE RETREADING; RECONDITIONING OF MACHINES; PROVIDING INFORMATION ON MOTOR VEHICLE REPAIRS; PROVIDING INFORMATION ON REPAIR SERVICES IN THE AVIATION SECTOR; AUTOMOBILE SERVICE STATION SERVICES; AUTOMOBILE VARNISHING; CAR CLEANING; INSTALLATION, MAINTENANCE AND REPAIR OF COMPUTERS; REBUILDING ENGINES THAT HAVE BEEN WORN OR PARTIALLY DESTROYED; RIVETING; ANTI-RUST TREATMENT FOR VEHICLES (U.S. CLS. 100, 103 AND 106).

SN 79-014,983. JUVENTUS F.C. SPA, ITALY, FILED 7-14-2004.

**CLASS 39—TRANSPORTATION AND STORAGE**

FOR AMBULANCE TRANSPORT; VEHICLE TOWING; MOTOR CAR TRANSPORT AND AIR TRANSPORT; TRUCK TRANSPORT; CHAUFFEUR SERVICES; FREIGHT BROKERAGE; TRANSPORT BROKERAGE; WAREHOUSING SERVICES; RENTAL OF WAREHOUSE SPACE; FREIGHT FORWARDING SERVICES; RENTAL OF GARAGE SPACE; RENTAL OF MOTOR CARS; RENTAL OF WHEELCHAIRS; RENTAL OF PARKING SPACES; RENTAL OF TRUCKS; MARINE TRANSPORT; COURIER SERVICES; CAR PARKING SERVICES; RESCUE SERVICES; TAXI TRANSPORT; MASS TRANSIT FOR THE GENERAL PUBLIC (U.S. CLS. 100 AND 105).

PRIORITY DATE OF 2-3-2004 IS CLAIMED.
OWNER OF INTERNATIONAL REGISTRATION 0861154 DATED 7-14-2004, EXPIRES 7-14-2014.
OWNER OF U.S. REG. NOS. 2,096,945, 2,708,382 AND OTHERS.

THE MARK CONSISTS OF A VERTICAL OVAL PRINT WITH DOUBLE EDGING AND DARK BACKGROUND CONTAINING: VERTICAL STRIPES ALTERNATING BETWEEN A LIGHT AND DARK BACKGROUND; HORIZONTAL STRIPE WITH A LIGHT BACKGROUND FEATURING THE WORD JUVENTUS CORRESPONDING TO THE COMPANY NAME WRITTEN IN CAPITAL TAPERED LETTERS, UNDERLINED WITH THICK DARK BACKGROUND; SHIELD IN DARK BACKGROUND BEARING THE REPRESENTATION OF A RAMPANT BULL IN LIGHT BACKGROUND PLACED UNDER THE REPRESENTATION OF A CROWN.

CLASS 40—MATERIAL TREATMENT

FOR SOLDERING; METAL CASTING; ENGRAVING; PATTERN PRINTING; MAGNETIZATION; GRINDING; METAL TEMPERING; NICKEL PLATING; VULCANIZATION (U.S. CLS. 100, 103 AND 106).

CLASS 3—COSMETICS AND CLEANING PREPARATIONS

FOR SOAPS, DEODORANT SOAPS, ANTIPERSPIRANT SOAPS, DEODORANTS FOR PERSONAL USE, BATH SALTS NOT FOR MEDICAL PURPOSES, PERFUMERY, EAU DE COLOGNE, ESSENTIAL OILS, COSMETICS, MAKE-UP, COSMETIC KITS CONSISTING PRIMARILY OF MAKE UP AND PERFUMERY, USED AS A PORTABLE TRAVELLING COMPACT KITS, BODY LOTIONS, SHAMPOOS, HAIR CONDITIONERS, SUNTAN CREAMS AND LOTIONS, SHAVE AND AFTER SHAVE SOAPS, CREAMS AND LOTIONS (U.S. CLS. 1, 4, 6, 50, 51 AND 52).

CLASS 42—SCIENTIFIC AND COMPUTER SERVICES

FOR CHEMICAL ANALYSIS; COMPUTER SYSTEMS ANALYSIS; GRAPHIC ARTS DESIGN SERVICES; CHEMICAL RESEARCH; CONSTRUCTION DRAFTING; CONSULTATION ON ENVIRONMENTAL PROTECTION IN SCIENTIFIC RESEARCH SERVICES; QUALITY CONTROL FOR OTHERS; INDUSTRIAL DESIGN; ENGINEERING DRAWING; MATERIAL TESTING; ENGINEERING; RENTAL OF COMPUTER SOFTWARE; LEASING OF COMPUTER FACILITIES; UPDATING OF COMPUTER SOFTWARE FOR OTHERS; COMPUTER PROGRAMMING FOR OTHERS; PRODUCT RESEARCH AND DEVELOPMENT; MECHANICAL RESEARCH; COMPUTER SOFTWARE DESIGN FOR OTHERS (U.S. CLS. 100 AND 101).

INGA ERVIN, EXAMINING ATTORNEY

CLASS 6—METAL GOODS

FOR RINGS OF METAL, NAMELY, RINGS OF COMMON METAL FOR KEYS, METAL KEYS, METAL KEY CHAINS, METAL KEY HOLDERS, MONEY CLIPS OF COMMON METAL, CLOTHES HOOKS OF METAL, MEMORIAL PLATES AND PLAQUES OF METAL, NAMELY COMMEMORATIVE PLATES AND PLAQUES OF METAL, STATUETTES OF COMMON METAL, BOXES OF METAL, BOOKMARKERS OF COMMON METAL (U.S. CLS. 2, 12, 13, 14, 23, 25 AND 50).

CLASS 8—HAND TOOLS

FOR CUTLERY, NAMELY FORKS, KNIVES AND SPOONS; CUTLERY OF PRECIOUS METAL OR COATED THEREWITH; HAND-OPERATED HAND TOOLS, NAMELY, HAMMERS, SCREWDRIVERS, WRENCHES, FILES, ICE PICKS, MANICURE SETS, SCISSORS (U.S. CLS. 23, 28 AND 44).

CLASS 9—ELECTRICAL AND SCIENTIFIC APPARATUS

FOR BLANK CASSETTES, DVDS, CD-ROMS, AUDIO TAPES, VHS TAPES, CDS, DVDS, CD-ROMS FEATURING MUSIC, CHORUS OF SUPPORTERS, INTERVIEWS TO PLAYERS, IMAGES OF SOCCER PLAYERS, HISTORY OF SOCCER, HISTORY OF TEAM, SOCCER ACTIVITIES, SOCCER EVENTS, MP3 PLAYERS, RADIO APPARATUS, NAMELY, PORTABLE RADIO DEVICES, HI-FI STEREO DEVICE, RADIO RECEIVERS, COMPUTER ACCESSORIES, NAMELY, COMPUTER CAMERAS, COMPUTER CARRYING CASES, COMPUTER CENTRAL PROCESSING UNITS, COMPUTER CHIPS, COMPUTER CURSOR CONTROL DEVICES, NAMELY, COMPUTER MOUSE, COMPUTER CURSOR CONTROL DEVICES, NAMELY, DIGITIZER TABLETS, COMPUTER CURSOR CONTROL DEVICES, NAMELY, LIGHT PENS, COMPUTER CURSOR CONTROL DEVICES, NAMELY, TOUCH PADS, COMPUTER CURSOR CONTROL DEVICES, NAMELY, TRACKBALLS, COMPUTER DISC DRIVER, COMPUTER DOCKETING STATION, COMPUTER HARD DISCS, COMPUTER HARDWARE, COMPUTER MONITORS, KEYBOARDS, MOUSE, OPTICAL MOUSE, JOY PADS, NAMELY, HAND HELD JOY STICK UNITS FOR PLAYING VIDEO GAMES, STEERING-WHEELS, NAMELY, STEERING WHEELS ATTACHED TO VIDEO MACHINES USED AS CONTROLLERS, CONTROL STICKS, NAMELY, HAND HELD JOY STICK UNITS FOR PLAYING VIDEO GAMES; TELESCOPES, BINOCULARS, CAMERAS, CALCULATORS, DATA PROCESSING EQUIPMENT, NAMELY, PERSONAL COMPUTERS, LAPTOPS, PORTABLE ELECTRONIC PERSONAL DIGITAL ASSISTANTS (PDA), AND COMPUTERS, CONSOLES, NAMELY, VIDEO-GAMES MACHINES FOR USE WITH TELEVISIONS, MEMORY CARDS FOR SUCH VIDEOGAMES; ACCESSORIES FOR VIDEOGAMES JOY PADS, NAMELY, HAND HELD JOY-STICK UNITS FOR PLAYING VIDEO GAMES, STEERING-WHEELS, NAMELY STEERING WHEELS ATTACHED TO VIDEO MACHINES USED AS CONTROLLERS, CONTROL STICKS, NAMELY, HAND HELD JOY STICK UNITS FOR PLAYING VIDEO GAMES; ARCADE VIDEOGAME SOFTWARE; EYEGLASSES, SUNGLASSES, LENS, FRAMES, CHAINS AND CASES FOR EYEGLASSES, GOGGLES, NAMELY, GOGGLES FOR SPORTS; HELMETS, NAMELY, MOTORCYCLE HELMETS, BICYCLE HELMETS, CAR RACING HELMETS, ICE SPORTS HELMETS, SKI HELMETS, TELEPHONE AND VIDEO TELEPHONE APPARATUS, NAMELY, VIDEO TELEPHONES, TELEPHONE AND VIDEO TELEPHONE RECEIVERS, TELEPHONE AND VIDEO TELEPHONE TRANSMITTERS, PORTABLE AND MOBILE TELEPHONES AND VIDEO TELEPHONE, CHAINS AND CASES FOR MOBILE TELEPHONES AND VIDEO TELEPHONE, PORTABLE AND MOBILE TELEPHONE AND VIDEO TELEPHONE ACCESSORIES, NAMELY, CHARGERS, COVERS NOT MADE OF PAPER, BATTERIES, EARPHONES, TABLE SUPPORT FOR PORTABLE TELEPHONES AND VIDEO TELEPHONES, VEHICULAR TELEPHONE KITS, NAMELY, CAR KITS FOR ADAPTING CELLULAR TELEPHONES FOR VEHICLE USE, MAGNETICALLY ENCODED TELEPHONE CARDS; DOWNLOADABLE RING TONES, WALLPAPER, SCREEN SAVERS AND COMPUTER GAME SOFTWARE FOR PORTABLE TELEPHONES AND VIDEO TELEPHONES, BAROMETERS, HYGROMETERS, RADIO SETS, TRANSISTORS, RADIO TRANSMITTERS, WALKIE-TALKIES, MAGNETICALLY ENCODED CREDIT CARDS, PREPAID CARDS AND FIDELITY CARDS (U.S. CLS. 21, 23, 26, 36 AND 38).

CLASS 10—MEDICAL APPARATUS

FOR BABY PACIFIERS, BABY BOTTLES, THERMOMETERS FOR MEDICAL USE, NAMELY, ALCOHOL THERMOMETERS, GAS THERMOMETERS, LIQUID-FILLED THERMOMETERS, RESISTANCE THERMOMETERS, CLINICAL THERMOMETERS, ELECTRIC THERMOMETERS (U.S. CLS. 26, 39 AND 44).

CLASS 11—ENVIRONMENTAL CONTROL APPARATUS

FOR BEVERAGES COOLING APPARATUS, NAMELY, REFRIGERATORS, ELECTRIC COFFEE MAKING MACHINES AND PERCOLATORS, FLASHLIGHTS AND TORCHES, PORTABLE LIGHTING DEVICES, NAMELY LIGHTING FIXTURES, LIGHTING APPARATUS AND INSTALLATIONS, NAMELY, LAMPS, HANGINGS FOR LAMPS, LIGHT DIFFUSERS (U.S. CLS. 13, 21, 23, 31 AND 34).

CLASS 12—VEHICLES

FOR BICYCLES (U.S. CLS. 19, 21, 23, 31, 35 AND 44).

CLASS 14—JEWELRY

FOR SPECIFIC TABLEWARE ITEMS OF PRECIOUS METAL, NAMELY PLACE CARDS HOLDERS, CUPS, NAMELY EGG CUPS OF PRECIOUS MATERIAL, TRAYS OF PRECIOUS MATERIAL, BOTTLE CAPS OF PRECIOUS MATERIALS, JEWELLERY AND CUSTOM JEWELLERY, MEDALS, COINS, NAMELY, HISTORICAL COINS BEARING TEAM'S PLAYERS, MANAGERS, COACHES AND EVENTS, LEGAL TENDER COLLECTIBLE OR COMMEMORATIVE COINS, COLLECTABLE GOLD PLATED REAL LEAVES, COLLECTABLE SILVER LEAVES, PRECIOUS STONES, EARRINGS, BRACELETS, NECKLACES, SMALL JEWELLERY CHAINS, PENDANTS, RINGS; RINGS, FOBS, NAMELY CHAINS TO FASTEN A WATCH TO A MAN'S WAISTCOAT OR TRINKETS, NAMELY RINGS FOR BODY PIERCING, BROOCHES, ORNAMENTS OF PRECIOUS METAL, BOOKMARKERS OF PRECIOUS METAL, STICKPINS, NAMELY JEWELRY PINS FOR USE ON HATS, CUFF LINKS, KEY RINGS OF PRECIOUS METAL, MONEY CLIPS OF PRECIOUS METAL, PINS, NAMELY ORNAMENTAL PINS, PHOTO FRAMES OF PRECIOUS METAL, LIGHTERS OF PRECIOUS METAL, COVERS FOR LIGHTERS OF PRECIOUS METAL, PAPER KNIVES IN PRECIOUS METAL, NAMELY LETTER OPENER, WRISTWATCHES, CLOCKS, STOPWATCHES, CHRONOGRAPHS FOR USE AS TIME PIECES, ALARM CLOCKS, CLOCKS, CHRONOMETRIC INSTRUMENTS (U.S. CLS. 2, 27, 28 AND 50).

CLASS 16—PAPER GOODS AND PRINTED MATTER

FOR PRINTED MATTER, NAMELY MAGAZINES, JOURNALS AND BOOKS, ALL IN THE FIELD OF SOCCER, HISTORY OF SOCCER, HISTORY OF TEAMS, SOCCER PLAYERS, SOCCER YOUTH TEAMS, AND SOCCER SCHOOLS ACTIVITIES; CATALOGUES IN THE FIELD OF SOCCER EQUIPMENT; FIGURINES ALBUMS, NAMELY MEMORY BOOKS, PHOTOGRAPH ALBUMS IN THE FIELD OF SOCCER, STICKING FIGURES, NAMELY STICKERS DEPICTING SOCCER PLAYERS, PAPER COLLECTABLE FIGURINES, STATIONERY, NOTEBOOKS, NAMELY PAPER AND CARDBOARDS ITEMS FOR WRITING, NAMELY BLOCK NOTES, WIREBOUND AND NON-WIREBOUND NOTEBOOKS, OF ANY DIMENSION, PAPER/CARDBOARD/PLASTIC FILING CABINETS, WITH OR WITHOUT RINGS, NAMELY FOLDERS, BINDERS, PAPER/CARDBOARD/PLASTIC BINDERS, AGENDAS, PHONE DIRECTORIES, ADDRESS BOOKS, BOOK MARKS IN PAPER OR CARDBOARD, DIARIES, POSTCARDS, GREETING CARDS, ENVELOPES, LETTER PAPER, WRAPPING PAPER, STAMPS, NAMELY COLLECTIBLE AND COMMERCIAL POST STAMPS FOR NATIONAL AND INTERNATIONAL MAIL, FOR PRIORITY AND ORDINARY MAIL, COLLECTIONS OF PHILATELIC COLLECTIBLE STAMP SETS, POSTERS, PHOTOGRAPHS, STICKERS, CALENDARS, WRITING INSTRUMENTS, NAMELY PENCILS, PENS, FELT-PENS AND FOUNTAIN PENS, ERASERS, PENCIL SHARPENERS, DRAWING RULERS, CORRECTING FLUIDS FOR TYPE CORRECTION, PENCIL CASES, PAINT TRAYS, PAPER

LABELS, PAPER TOWELS AND TISSUES, PAPER SACKS, POCKETS, NAMELY, PAPER CARRYING CASES AND BAGS MADE OF PAPER OR OF PLASTIC MATERIAL FOR HOUSEHOLD USE, PAPERWEIGHTS, FRAMED SIGNED JERSEYS, NAMELY PLAYING SHIRTS/JERSEYS SIGNED BY A SOCCER STAR AND FRAMED IN PICTURE TO BE HUNG ON THE WALL, NON-MAGNETICALLY ENCODED CREDIT CARDS, NON-MAGNETICALLY ENCODED PREPAID PURCHASE CARDS FOR ALLOWING USERS TO TRANSFER FINANCIAL VALUE ON-LINE VIA RETAIL COMPUTER NETWORKS (U.S. CLS. 2, 5, 22, 23, 29, 37, 38 AND 50).

CLASS 18—LEATHER GOODS

FOR TRUNKS AND TRAVELLING BAGS, SUITCASES, BRIEFCASES, PURSES, BACKPACKS, HANDBAGS, WAIST PACKS, SPORT BAGS, GYM BAGS, KNAPSACKS, RUCKSACKS, SCHOOLBAGS, TEXTILE SHOPPING BAGS, LEATHER SHOPPING BAGS, MESH SHOPPING BAGS, GARMENT BAGS, BAG FOR LAP-TOPS, NAMELY TRAVEL BAGS FOR LAPTOP COMPUTERS, BAGS FOR DIGITAL CAMERAS MADE OF CLOTH, LEATHER BUT NOT BEING OF PAPER, NAMELY TRAVEL CASES FOR DIGITAL CAMERAS, CARD CASES MADE OF CLOTH, LEATHER, METAL, PLASTIC; POUCHES MADE OF CLOTH, LEATHER, METAL BUT NOT BEING OF PAPER, NOT FOR MAILING OR MERCHANDISE PACKAGING, VANITY CASES SOLD EMPTY, WALLETS; UMBRELLAS AND PARASOLS; DOG COLLARS AND LEADS (U.S. CLS. 1, 2, 3, 22 AND 41).

CLASS 20—FURNITURE AND ARTICLES NOT OTHERWISE CLASSIFIED

FOR FURNITURE, GARDEN FURNITURE, BEDSIDE TABLES, BEDS, BED FITTING, NAMELY, BED FRAMES, BOX SPRINGS, TABLES, CHAIRS, DECK-CHAIRS, ARMCHAIRS, SOFAS, DESKS, LIBRARY SHELVES, MIRRORS, PICTURE FRAMES, PILLOWS; POUFS, NAMELY, SOFT ROUND OR SQUARE SEATS WITH NO BACK OR SIDES, USED FOR SITTING ON OR RESTING YOUR FEET ON, GOODS, NOT INCLUDED IN OTHER CLASSES, OF WOOD, CORK, REED, CANE, WICKER, HORN, BONE, IVORY, WHALEBONE, SHELL, AMBER, MOTHER-OF-PEARL, MEERSCHAUM AND SUBSTITUTES FOR ALL THESE MATERIALS, OR OF PLASTIC, NAMELY, FURNITURE, GARDEN FURNITURE, BEDSIDE TABLES, BEDS, TABLES, CHAIRS, DECKCHAIRS, NAMELY, DECKCHAIRS, ARMCHAIRS, SOFAS, DESKS, LIBRARY SHELVES, MIRRORS, PICTURE FRAMES (U.S. CLS. 2, 13, 22, 25, 32 AND 50).

CLASS 21—HOUSEWARES AND GLASS

FOR HOUSEHOLD OR KITCHEN UTENSILS AND CONTAINERS NOT OF PRECIOUS METAL, NAMELY, BOTTLE RACKS, NAMELY WOODEN OR METAL FRAMES TO STORE BOTTLES, BASINS, BOWLS, BASKETS OF STRAW, WICKER, WOOD OR PLASTIC, BINS, NAMELY PAPER BINS, STORAGE CONTAINERS MADE OF PAPER, WASTE BINS, BOXES, NAMELY SPICE RACKS, SALT BOXES, NAMELY SALT CELLARS, SUGAR BASINS, FLOUR BOXES, NAMELY FLOUR SIFTER, PASTA BOXES, NAMELY PASTA CONTAINERS, COOKIES JARS SOLD EMPTY, BUCKETS, NAMELY ICE BUCKETS, VASES, COOKING POTS, GLASS STORAGE JARS SOLD EMPTY FOR SPICES, SALT, SUGAR, FLOUR, PASTA AND COOKIES, DEWAR VESSEL, PLATES, SOUP PLATES, DESSERT PLATES, BUTTER DISHES, BEVERAGE GLASSWARE, HOUSEHOLD FOOD AND BEVERAGE CONTAINERS, REFRIGERATING AND HEAT INSULATING CONTAINERS, NAMELY THERMAL INSULATED CONTAINERS FOR FOOD OR BEVERAGES, BOTTLES SOLD EMPTY, DRINKING GLASSES, GOBLETs, DISHES, MUGS, CUPS, PLATES, SAUCERS, SOUP TUREENS, CRUETS NOT OF PRECIOUS METAL, SALAD BOWLS, COOKIE JARS, EGG CUPS, FRUIT CUPS, ICE PAILS, FLOWER POTS, COASTERS, NOT OF PAPER AND OTHER THAN TABLE LINEN, TRAYS NOT OF PRECIOUS METAL AND CABARETS, NAMELY KITCHEN PAPER TOWEL HOLDERS, DUSTBINS, GARBAGE CANS, COMBS AND CLEANING SPONGES, SHAVER BRUSHES AND SHAVING BRUSH STANDS, HAND-OPERATED COOKING,

HOUSEHOLD OR KITCHEN INSTRUMENTS, NAMELY BOTTLE OPENERS, CORKSCREWS, COOKERY MOULDS, COOKING POTS, NON-ELECTRIC PRESSURE COOKERS, COOKING PANS, CAULDRONS, COCKTAIL STIRRERS, FLASKS, COFFEE FILTERS, MANUALLY OPERATED COFFEE GRINDERS MANUALLY OPERATED, COFFEE PERCOLATORS, COFFEEPOTS, TEA CADDIES, NOT OF PRECIOUS METAL, HAND-OPERATED DOMESTIC GRINDERS, KETTLES, WINE TASTERS, NAMELY SIPHONS, SIPHONS FOR CARBONATED WATER, SHAKERS, NAMELY COCKTAIL SHAKERS, WORKS OF ART, NAMELY FIGURINES, BUSTS, STATUETTES AND STATUES, OF PORCELAIN, TERRA-COTTA OR GLASS, FIGURINES, BUSTS, STATUETTES AND STATUES OF PORCELAIN, TERRA-COTTA OR GLASS, CERAMICS FOR HOUSEHOLD PURPOSES, NAMELY PLATES, SOUP PLATES, DESSERT PLATES, CUPS, MUGS, FLOWERPOTS, POTTERY, NAMELY PLATES, SOUP PLATES, DESSERT PLATES, CUPS, MUGS, FLOWERPOTS, SANTA CLAUS FIGURINES OF TERRA COTTA, DWARVES FIGURINES OF TERRA COTTA, ANIMAL FIGURINES OF TERRA COTTA, AND SNOWMEN FIGURINES OF TERRA COTTA, CHINA ORNAMENTS, CRYSTAL BEVERAGE GLASSWARE, ENAMELED GLASS, TOILET BRUSH HOLDER CASES MADE OF CLOTH, PLASTIC OR LEATHER NAMELY, TOILET SPONGES, TOOTHBRUSHES, TOOTHBRUSHES AND TOOTHPASTE HOLDERS, FLOSS FOR DENTAL PURPOSES, SOAP DISPENSERS, SOAP HOLDERS, SOAP BOXES, TOILET PAPER-ROLL HOLDER, CANDELABRA THAT IS NON-ELECTRIC AND NOT OF PRECIOUS METAL, CANDLE RINGS NOT OF PRECIOUS METAL, BUTTONHOOKS, PERFUME BURNERS, SPRAYERS SOLD EMPTY AND VAPORIZERS SOLD EMPTY, COSMETIC UTENSILS, NAMELY EYELASH BRUSHES, MAKE-UP SPONGES, MAKE-UP BRUSHES, PAPER PLATES AND PAPER CUPS (U.S. CLS. 2, 13, 23, 29, 30, 33, 40 AND 50).

CLASS 24—FABRICS

FOR BED CLOTHES, NAMELY, BED TOP SHEETS, BED BOTTOM SHEETS, BED LINEN, BED COVERS, NAMELY EIDERDOWNS, QUILTS, DUVETS, PLAIDS, NAMELY FLANNEL, AND RELATED COVERS, NAMELY PAPER BED COVERS; BED COVERS OF PAPER, NAMELY BED BLANKETS, BED SPREADS, MATTRESS COVERS, PILLOWCASES, HOUSEHOLD LINEN, HANDKERCHIEFS OF TEXTILE, TABLE LINEN, TABLE COVERS, NAMELY TABLE CLOTHS NOT OF PAPER, PLACE-MATS NOT OF PAPER, TEXTILE BAGS FOR BREAD, NAMELY TEXTILE BREAD CONTAINERS; TABLE NAPKINS AND TABLE CLOTHS NOT OF PAPER, UNFITTED COVERINGS OF TEXTILE OR PLASTIC FOR FURNITURE, CURTAINS OF TEXTILE OR PLASTIC, SHOWER CURTAINS OF TEXTILE OR PLASTIC, BATH LINEN NOT INCLUDING CLOTHING, SERVIETTES OF TEXTILE, NAMELY WASHING GLOVES, NAPKINS AND TISSUES OF TEXTILE, NAMELY HANDKERCHIEFS AND SERVIETTES, FABRICS FOR TEXTILE FOR HOME INTERIOR DECORATION, CAR INTERIOR DECORATION, CLOTHING MANUFACTURE, COTTON FABRICS, FABRICS FOR BOOTS AND SHOES, KNITTED FABRICS, CLOTH LABELS, WALL HANGINGS OF TEXTILE, FLAGS AND PENNANTS OF TEXTILE, NAMELY TEAM FLAGS AND TEAM PENNANTS FOR SUPPORTERS; TEXTILE OR PLASTIC POT HOLDERS (U.S. CLS. 42 AND 50).

CLASS 25—CLOTHING

FOR ARTICLES OF CLOTHING, NAMELY ACTIVE WEAR, NAMELY PANTS, JACKETS, HATS AND CAPS, SPORTSWEAR, NAMELY PANTS, JACKETS, HATS AND CAPS, SWIMWEAR, UNDERWEAR, NIGHTWEAR, LEATHERWEAR, NAMELY PANTS, JACKETS, HATS AND CAPS, AND LOUNGEWEAR; SPORTS UNIFORMS AND JERSEYS BOTH CURRENT AND HISTORICAL, PANTS, TROUSERS, JEANS, SHORTS, JACKETS, WIND JACKETS, COATS, OVERCOATS, RAINCOATS, HOSIERY, SWEATERS, CARDIGANS, FLEECE TOPS AND BOTTOMS, NAMELY FLEECE SWEATSHIRTS, JACKETS, PANTS, TRAINING AND TRACK SUITS, SHIRTS, WOVEN SHIRTS, SWEAT SHIRTS, PLUSH SHIRTS, POLO SHIRTS, T-SHIRTS, TANK TOPS, TOPS, CUT AND SEW TOPS, PYJAMAS, OVERALLS, DRESSES, EVENING DRESSES, TIGHTS, SKIRTS, GOWNS; SOCKS;

ROBES, KITCHEN APRONS, SCHOOL APRONS; HEAD BANDS, WRISTBANDS; SCARVES; NECK WARMERS, NAMELY NECK BANDS; BATH ROBES, SWIMSUITS, BEACH WEAR, NAMELY SWIMSUITS, BATHING CAPS, RUBBER FLIPPERS, NAMELY FLIP FLOPS, WETSUITS, BEACH TOWELS, NAMELY BEACH COVER-UPS, PLASTIC AND CLOTH BIBS, HEADWEAR, NAMELY HATS, CAPS AND HEAD BANDS, BANDANAS, WRISTBANDS; BELTS AND TIES; FOOTWEAR, NAMELY SHOES, BOOTS, CHAPS, SANDALS, SLIPPERS, SPORT AND ATHLETIC SHOES, SOCCER AND FOOTBALL SHOES, TENNIS SHOES, CLIMBING SHOES (U.S. CLS. 22 AND 39).

CLASS 26—FANCY GOODS

FOR RIBBONS AND BRAIDS; BUTTONS FOR CLOTHING, HOOKS AND EYES, PINS, NAMELY, PINS FOR CLOTHING, NAMELY, SAFETY PINS IN PRECIOUS OR NOT PRECIOUS METAL, PLASTIC, WOOD OR CLOTH; ARTIFICIAL GARLANDS, BADGES FOR WEAR, NAMELY, ORNAMENTAL CLOTH PATCHES AND KNITTED BADGES, BELT CLASPS NOT OF PRECIOUS METAL, HAIR ORNAMENTS, HAIR BANDS, FALSE HAIR, NAMELY, WIGS, TOUPEES, HAIR COLOURING CAPS, HAIR CURLING PAPERS, PINS AND GRIPS, HAT ORNAMENTS NOT OF PRECIOUS METAL, HEAT ADHESIVE PATCHES FOR REPAIRING OR FOR DECORATION OF TEXTILE ARTICLES, NUMERALS OR LETTERS FOR MARKING LINEN, NAMELY, HEAT TRANSFER NUMBERS AND LETTERS, MONOGRAM TABS FOR MARKING LINEN, NAMELY LABELS OF CLOTH NAMELY, EMBROIDERED EMBLEMS, EMBROIDERED PATCHES FOR CLOTHING, COMPETITORS' NUMBERS NOT OF TEXTILE, SHOE ORNAMENTS NOT OF PRECIOUS METAL, LACE TRIMMINGS FOR CLOTHING, TRIMMINGS FOR CLOTHING, NAMELY, TEXTILE PATCHES, METAL BADGES, NAMELY, SMALL PIECES OF METAL TO BE PINNED OR SEWN TO CLOTHING, STICKPINS NOT OF PRECIOUS METAL, NAMELY HAT PINS, SEWING BOXES NOT OF PRECIOUS METAL, BOXES FOR NEEDLES, NOT OF PRECIOUS METAL, BUCKLES FOR BELTS, COLLARS STAYS, NOT BEING OF PRECIOUS METAL, HABERDASHERY, EXCEPT THREAD, NAMELY, PASSEMENTERIE, ZIPPERS, ZIPPER (U.S. CLS. 37, 39, 40, 42 AND 50).

CLASS 27—FLOOR COVERINGS

FOR CARPETS, CARPETS FOR AUTOMOBILES, FLOOR COVERINGS, RUGS, FLOOR MATS, DOOR MATS, BATH FLOOR MATS, NON-SLIP BATH TUB MATS, GYMNASIUM MATS, LINOLEUM FOR USE ON FLOORS, WALLPAPER, WALL HANGINGS, NOT OF TEXTILE, ARTIFICIAL TURF (U.S. CLS. 19, 20, 37, 42 AND 50).

CLASS 28—TOYS AND SPORTING GOODS

FOR GYMNASIUM AND SPORTING GOODS AND EQUIPMENT, NAMELY BALLS FOR FOOTBALL/SOCCER GAMES, BALL PUMPS, SPORTS IMPLEMENTS, TOOLS AND ACCESSORIES, SUCH AS FOR FOOTBALL/SOCCER, NAMELY SOCCER BALL GOAL NETS, SOCCER GOAL POSTS SETS FEATURING FIXTURES, NAMELY GOALPOSTS AND NETS, NETS FOR BALL GAMES, FLAGS AND FLAG POSTS FOR SOCCER CORNER KICKS, FLAGS FOR REFEREES, BODY BOARDS, HAND GUARD, ELBOW GUARDS, KNEE GUARDS, SHIN GUARDS, PROTECTIVE PADDING FOR PLAYING FOOTBALL/SOCCER, GLOVES FOR SOCCER, GLOVES FOR BALL GAMES, GOALKEEPER GLOVES; SKATE BOARDS, SURF BOARDS, BODY BUILDING APPARATUS, NAMELY CHEST EXPANDERS, CHEST PULLS, LEG WEIGHTS, MANUAL LEG EXERCISERS, EXERCISE BARS, EXERCISE BENCHES, WRIST AND ANKLES EXERCISE WEIGHTS, BODY TRAINING APPARATUS, NAMELY TREADMILLS, AEROBIC CARPETS, NAMELY PERSONAL EXERCISE MATS, STATIONARY EXERCISE BICYCLES, EXERCISERS EXPANDERS, NAMELY CHEST EXPANDERS, EXERCISING PULLEYS, ELECTRONIC GAMES OTHER THAN THOSE ADAPTED FOR USE WITH TELEVISION RECEIVERS ONLY; FLOOR-STANDING UNITS FOR PLAYING ELECTRONIC GAMES OTHER THAN IN CONJUNCTION WITH A TELEVISION OR COMPUTER;

HAND-HELD ELECTRONIC GAMES OTHER THAN THOSE ADAPTED FOR USE WITH TELEVISION RECEIVERS ONLY; TABLETOP UNITS FOR PLAYING ELECTRONIC GAMES OTHER THAN IN CONJUNCTION WITH A TELEVISION OR COMPUTER; TABLE FOOTBALL IN THE NATURE OF FOOTBALL GAME TABLES, FOOTBALL/SOCCER ARCADE ELECTRONIC VIDEO GAMES, STRATEGY GAMES, NAMELY ACTIONS STREET GAMES, PARLOUR GAMES, BILLIARD TABLES, NAMELY ITALIAN POOL TABLES, AMERICAN POOL TABLES, BILLIARD-BALLS, BILLIARD CUES, YO-YOS, CARD GAMES, TOY ACTION FIGURES, PLAYING CARDS, SCALE MODEL VEHICLES, TOY VEHICLES, DICE, DICE GAMES, DOMINOES, PUZZLES, SOFT SCULPTURE TOYS, DOLLS, MARIONETTE PUPPETS, PUPPETS, TEDDY BEARS, PLAY BALLOONS, SOAP BUBBLES, NAMELY BUBBLE MAKING WAND AND SOAP SETS, BUILDING SETS, BUILDING PLAY SETS, OUTDOOR GAMES, NAMELY OUTDOOR ACTIVITY GAMES IN THE NATURE OF INFLATABLE, GOAL SETS, WOOD/PLASTIC RACKETS FOR TENNIS, BADMINTON, TABLE-TENNIS, PLAY AND SPORTS ARTICLES TO BE INFLATED, NAMELY PLAY BALLOONS, PLAY TOYS, NAMELY HOPPING BALLS INFLATABLE SWIMMING POOLS, BUOYS, NAMELY, RING BUOYS FOR AQUATIC RECREATIONAL USE AND INFLATABLE INNER TUBES FOR AQUATIC RECREATIONAL USE, NINEPINS, NAMELY INFLATABLE, PLASTIC OR WOOD BOWLING PINS, ORNAMENTS AND DECORATIONS FOR CHRISTMAS TREES (U.S. CLS. 22, 23, 38 AND 50).

CLASS 30—STAPLE FOODS

FOR COFFEE, COFFEE BEANS, GRINDED COFFEE, COFFEE FOR ESPRESSO MACHINES, SOLUBLE COFFEE, ARTIFICIAL COFFEE, COFFEE SUBSTITUTES, PREPARED COFFEE-BASED BEVERAGES, COFFEE BEVERAGES WITH MILK; TEA, TEA-BASED BEVERAGES WITH FRUIT FLAVOURINGS; HERBAL INFUSION, NOT MEDICINAL, COCOA, CHOCOLATE, COCOA AND CHOCOLATE CONFECTIONERY, NAMELY CHIPS FOR BAKING, CHOCOLATE BARS, CHOCOLATE MOUSSE, CHOCOLATE CANDIES IN THE SHAPE OF EGGS, CHOCOLATE CANDIES SOLD DURING EASTER SEASON, CHOCOLATE CHRISTMAS PRODUCTS NUTS CREAMS, NAMELY BONBONS AND CAKES MADE OF NUT CHOCOLATE, COCOA AND CHOCOLATE-BASED BEVERAGES, NOT BEING DAIRY OR VEGETABLE BASED, SUGAR, BAKERY PRODUCTS, PASTRY, BREAD, CRACKERS, PIZZAS, RUSKS, CONFECTIONERY, NAMELY CAKES, PIES, PUDDINGS, SWEETS, NAMELY CANDIES, COOKIES SNACKS, NAMELY CRACKERS, CRISPS, APERITIF SALTED COOKIES AND SNACKS CAKES, PIES, PUDDINGS, SWEETS, COOKIES, PROCESSED CEREALS, CORN FLAKES, POPCORN, MUESLI, CANDIES, LOLLIPOPS, CHEWING-GUM, NOT FOR MEDICAL PURPOSES, CONFECTIONERY, NAMELY EDIBLE CAKE DECORATIONS FOR DECORATING CHRISTMAS TREES, CONFECTIONERY NAMELY EDIBLE CAKE DECORATIONS FOR DECORATING CAKES, ICE, ICE CREAMS, SHERBETS, FROZEN YOGURTS, HONEY, SAUCES IN THE NATURE OF CONDIMENTS, NAMELY MUSTARD, MAYONNAISE, KETCHUP, PASTA SAUCES, SPICES; FRUIT SAUCES EXCLUDING CRANBERRY SAUCE AND APPLESAUCE, MILK AND MILK-BASED BEVERAGES WITH FRUIT FLAVOURING/WITH COCOA FLAVOURING, NAMELY MILK SHAKE (U.S. CL. 46).

CLASS 33—WINES AND SPIRITS

FOR WINES, SPARKLING WINES, APERITIFS, LIQUEURS, PREPARED ALCOHOLIC COCKTAIL MIXES, DISTILLED BEVERAGES, NAMELY GRAPPA, WHISKY, GIN, DIGESTERS, NAMELY ALCOHOL BITTERS, ALCOHOL APERITIF BITTERS, SPIRITS, NAMELY DISTILLED SPIRITS, BRANDY SPIRITS, POTABLE SPIRITS (U.S. CLS. 47 AND 49).

CLASS 34—SMOKERS' ARTICLES

FOR SMOKERS' ARTICLES, NAMELY, CIGAR AND CIGARETTE CASES NOT OF PRECIOUS METAL, LIGHTERS, MATCHES, ASHTRAYS NOT OF PRECIOUS METAL, MATCH BOXES AND MATCH HOLDERS, NOT OF PRECIOUS METAL (U.S. CLS. 2, 8, 9 AND 17).

CLASS 35—ADVERTISING AND BUSINESS

FOR ADVERTISING; ADVERTISING AGENCIES, EMPLOYMENT RECRUITING AGENCIES, BUSINESS MANAGEMENT; RELOCATION SERVICES FOR BUSINESSES, BUSINESS ADMINISTRATION; ORGANIZATION OF EXHIBITIONS AND TRADE FAIRS FOR COMMERCIAL AND ADVERTISING PURPOSES, PERSONNEL RECRUITMENT, PUBLIC RELATIONS, PUBLICITY AGENCIES, PROCUREMENT SERVICES FOR OTHERS, NAMELY PURCHASING GOODS AND/OR SERVICES FOR OTHER BUSINESSES, RADIO ADVERTISING AND COMMERCIALS, SALES PROMOTIONS, FRANCHISING BUSINESSES, NAMELY FRANCHISING, NAMELY CONSULTATION AND ASSISTANCE IN BUSINESS MANAGEMENT, ORGANIZATION AND PROMOTION, RETAIL STORE SERVICES AND ONLINE RETAIL STORE SERVICES FEATURING FURNITURE, WEAR, SHOES, HATS, TEXTILES, FOODSTUFFS, COSMETICS, STATIONERY, JEWELLERY, WATCHES, HOUSEHOLD AND KITCHEN UTENSILS, SPORTING GOODS AND EQUIPMENT (U.S. CLS. 100, 101 AND 102).

CLASS 36—INSURANCE AND FINANCIAL

FOR INSURANCE AGENCIES IN THE FIELD OF LIFE INSURANCE, HEALTH INSURANCE, AVIATION INSURANCE, CAR INSURANCE, MOTOR INSURANCE, HOME CONTENTS INSURANCE, INDEMNITY INSURANCE, UNEMPLOYMENT INSURANCE, THEFT INSURANCE, BURGLARY INSURANCE, FIRE INSURANCE, INDUSTRIAL ACCIDENT INSURANCE, DISABILITY INSURANCE, RAIN INSURANCE, PUBLIC LIABILITY INSURANCE, PROFESSIONAL INDEMNITY INSURANCE, ALL-RISKS INSURANCE, SEA INSURANCE, RETIREMENT INCOME INSURANCE, ENDOWMENT INSURANCE, MEDICAL INSURANCE, THIRD-PARTY RISK INSURANCE, FINANCIAL AFFAIRS, NAMELY, MONETARY AFFAIRS, NAMELY, MONETARY EXCHANGE; REAL ESTATE AFFAIRS, NAMELY, ESTATE AGENCIES, ESTATE INVESTMENT TRUSTS, NAMELY, ESTATE TRUST MANAGEMENT, BANKING, BROKERAGE, NAMELY, EQUITY CAPITAL INVESTMENTS, FIDUCIARY, NAMELY, TRUST SERVICES, NAMELY, INVESTMENT TRUSTS SERVICES, FINANCIAL SPONSORSHIP OF SPORT, CHARITY, SOCIAL AND POLITICAL EVENTS (U.S. CLS. 100, 101 AND 102).

CLASS 41—EDUCATION AND ENTERTAINMENT

FOR EDUCATION, NAMELY, LANGUAGE COURSES, SPORTS EDUCATION, NAMELY PROVIDING TRAINING COURSES IN THE FIELD OF SPORTS; PROVIDING OF TRAINING IN THE FIELD OF SPORTS AND SOCCER; SPORTING AND CULTURAL ACTIVITIES, NAMELY, SOCCER CAMPS, FOOTBALL CAMPS, SOCCER TRAINING SCHOOLS AND ACADEMIES, ARRANGING AND CONDUCTION OF SYMPOSIUMS, CONFERENCES, WORKSHOP AND EVENTS, NAMELY, TOURNAMENTS FOR SPORTING AND CULTURAL PURPOSES IN THE FIELD OF SOCCER, CHILD EDUCATION AND PERSONAL DEVELOPMENT; CAMP SERVICES IN ENTERTAINMENT AND SPORT, NAMELY, SOCCER TRAINING SESSIONS, SOCCER TOURNAMENTS, CLUB SERVICES, NAMELY, ORGANIZATION OF SPORTS COMPETITIONS AND EVENTS, ONLINE COMPUTER GAME SERVICES, CINEMAS THEATRES, MUSIC AND OTHER ENTERTAINMENT, NAMELY, PRESENTATION OF LIVE SHOWS PERFORMANCES, ON-GOING TELEVISION AND RADIO AND ONLINE TELEVISION AND RADIO BROADCASTED PROGRAMS IN THE FIELD OF ENTERTAINMENT, SOCCER, SPORT; AMUSEMENT PARKS, PRODUCTION OF RADIO AND TELEVISION PROGRAMS, PRODUCTION OF SHOWS, NAMELY, TELEVISION SHOWS, RADIO SHOWS, LIVE SHOWS, PROVIDING AMUSEMENTS ARCADE SERVICES, PUBLICATION OF BOOKS AND JOURNALS, ONLINE PUBLICATION OF BOOKS AND JOURNALS, PROVIDING SPORT AND RECREATION FACILITIES (U.S. CLS. 100, 101 AND 107).

CLASS 43—HOTEL AND RESTAURANT SERVICES

FOR SERVING AND PROVIDING FOOD AND DRINK; TEMPORARY ACCOMMODATION, CAFÉS, CAFETERIAS, CANTEENS, CAMP SERVICES, NAMELY PROVIDING CAMPGROUND FACILITIES, DAY-NURSERIES, NAMELY CHILDREN CRÉCHES, FOOD AND DRINK CATERING, RESTAURANTS, SELF-SERVICES RESTAURANTS, BAR SERVICES, SNACK-BARS (U.S. CLS. 100 AND 101).

JENNIFER VASQUEZ, EXAMINING ATTORNEY

SN 79-023,273. IPANEMA TECHNOLOGIES, FRANCE, FILED 3-24-2006.

SALSA

THE MARK CONSISTS OF STANDARD CHARACTERS WITHOUT CLAIM TO ANY PARTICULAR FONT, STYLE, SIZE, OR COLOR.

PRIORITY DATE OF 10-14-2005 IS CLAIMED.
OWNER OF INTERNATIONAL REGISTRATION 0883319 DATED 3-24-2006, EXPIRES 3-24-2016.

CLASS 9—ELECTRICAL AND SCIENTIFIC APPARATUS

FOR COMPUTER SOFTWARE FOR THE USE IN NETWORK MANAGEMENT, NAMELY, SOFTWARE FOR MANAGEMENT OF APPLICATION AWARE NETWORK DEVICES, FOR NETWORK TRAFFIC MANAGEMENT IN THE NATURE OF MONITORING AND CONTROL OF APPLICATION FLOWS, FOR NETWORK SERVICE LEVEL MANAGEMENT IN THE NATURE OF MONITORING AND ENFORCEMENT OF APPLICATION FLOW SERVICE LEVELS AND FOR NETWORK SECURITY IN THE NATURE OF FIREWALLING, INTRUSION DETECTION AND NETWORK BEHAVIOR ANOMALY DETECTION (U.S. CLS. 21, 23, 26, 36 AND 38).

CLASS 38—COMMUNICATION

FOR TELECOMMUNICATION SERVICES, NAMELY, TRANSMISSION OF VOICE, DATA, DOCUMENTS AND VIDEO IN THE FIELDS OF MANAGEMENT OF APPLICATION AWARE NETWORK DEVICES, NETWORK TRAFFIC MANAGEMENT, NETWORK SERVICE LEVEL MANAGEMENT, NETWORK SECURITY, MONITORING AND CONTROL OF APPLICATION FLOWS, NETWORK SERVICE LEVEL MANAGEMENT, MONITORING AND ENFORCEMENT OF APPLICATION FLOW SERVICE LEVELS, AND NETWORK SECURITY, FIREWALLING AND INTRUSION DETECTION AND NETWORK BEHAVIOR ANOMALY DETECTION (U.S. CLS. 100, 101 AND 104).

DAYNA BROWNE, EXAMINING ATTORNEY

SN 79-031,046. GEORG FISCHER GMBH & CO. KG, FED REP GERMANY, FILED 10-27-2006.

SiboDur 700-MESH

THE MARK CONSISTS OF STANDARD CHARACTERS WITHOUT CLAIM TO ANY PARTICULAR FONT, STYLE, SIZE, OR COLOR.

PRIORITY DATE OF 5-17-2006 IS CLAIMED.

OWNER OF INTERNATIONAL REGISTRATION 0903868 DATED 10-27-2006, EXPIRES 10-27-2016.

OWNER OF U.S. REG. NO. 2,985,567.

NO CLAIM IS MADE TO THE EXCLUSIVE RIGHT TO USE "700-MESH", APART FROM THE MARK AS SHOWN.

CLASS 6—METAL GOODS

FOR METAL MATERIALS, NAMELY, METAL ALLOYS FOR FURTHER MANUFACTURING OF SPHEROIDAL GRAPHITE IRON (U.S. CLS. 2, 12, 13, 14, 23, 25 AND 50).

CLASS 12—VEHICLES

FOR VEHICLE PARTS, NAMELY, CARRIAGE PARTS, NAMELY, WHEEL CARRIERS, CHAIN GUIDES, TRANSVERSE CONTROL ARMS, STEERING WHEEL SPINDLES, STEERING WHEEL SPINDLE ASSEMBLIES AND WHEEL SHAFT HUB JOINTS; VEHICLE MOTOR PARTS, NAMELY, CONNECTING RODS, EXCLUDING CONNECTING RODS FOR ENGINES, WHEEL AND AXLE BEARING HOUSINGS AND BEARING COVERS (U.S. CLS. 19, 21, 23, 31, 35 AND 44).

CARYN GLASSER, EXAMINING ATTORNEY

SN 79-033,855. GRO-GROUP HOLDINGS LIMITED, UNITED KINGDOM, FILED 10-21-2005.



THE MARK CONSISTS OF STANDARD CHARACTERS WITHOUT CLAIM TO ANY PARTICULAR FONT, STYLE, SIZE, OR COLOR.

PRIORITY DATE OF 4-22-2005 IS CLAIMED.

OWNER OF INTERNATIONAL REGISTRATION 0911255 DATED 10-21-2005, EXPIRES 10-21-2015.

OWNER OF U.S. REG. NOS. 2,679,749 AND 2,946,655.

CLASS 9—ELECTRICAL AND SCIENTIFIC APPARATUS

FOR BABY MONITORS; DEVICES FOR PARENT AND CHILD THAT DETECT MOVEMENT AND DISTANCE BETWEEN THEM BY SENSORS, NAMELY, BABY MONITORS; BABY ALARM SYSTEMS COMPRISED PRIMARILY OF BABY MONITORS TO INCLUDE TEMPERATURE, VIDEO AND SOUND MONITORS; ELECTRONIC PUBLICATIONS IN THE NATURE OF LISTS FEATURING INFORMATION ABOUT BABY GIFTS; SMOKE ALARMS; COMPACT DISCS FEATURING MUSIC TO HELP BABIES SLEEP; PROTECTIVE CLOTHING FEATURING UV FILTERS; PROTECTIVE CLOTHING THAT IS CHLORINE RESISTANT; UV FILTER SUNGLASSES; THERMOMETERS; DVDS FEATURING INFORMATION AND ADVICE REGARDING PREGNANCY AND MOTHERHOOD; UV PROTECTIVE EYEWEAR (U.S. CLS. 21, 23, 26, 36 AND 38).

CLASS 20—FURNITURE AND ARTICLES NOT OTHERWISE CLASSIFIED

FOR AIR CUSHIONS FOR USE IN BABIES' COTS; AIR MATTRESSES FOR USE IN BABIES' COTS; AIR PILLOWS FOR USE IN BABIES' COTS; SLEEPING BAGS; BABY SLEEPING BAGS; TRAVEL SLEEPING BAGS; ORGANIC SLEEPING BAGS; SLEEPING BAGS INCORPORATING A CUSHION FOR BABIES; SLEEPING BAGS INCORPORATING A PILLOW FOR BABIES; REPLACEMENT PARTS AND REPLACEMENT FITTINGS FOR SLEEPING BAGS; BEDDING, NAMELY, MATTRESS TOPPERS; PILLOWS; MATTRESSES; ALLERGY-FREE MATTRESSES; COTS; COT BUMPERS; NON-METAL FABRIC HANGING ORGANIZERS; DECORATIVE MOBILES FOR COTS; COT BEDS; TRAVEL COTS; TODDLER BEDS; MOSES BASKETS, NAMELY, WICKER CRIBS; MOSES BASKET STANDS, NAMELY, BED LEGS FOR WICKER CRIBS; CHANGING TABLES; DIAPER CHANGING MATS; CRADLES; BABY NAPPY BINS, NAMELY, NON-METAL BINS FOR BABY NAPPIES; DISPENSERS FOR BABY NAPKINS, NAMELY, FIXED BABY NAPKIN DISPENSERS NOT OF METAL; EASY CHAIRS; FIRE SCREENS AND FIRE GUARDS FOR DOMESTIC USE; HIGH CHAIRS FOR BABIES; INFANT WALKERS; CHILD LOCKS FOR SAFETY PURPOSES, NAMELY, NON-METAL LOCKS; PROTECTIVE EDGINGS FOR FURNITURE, NAMELY, BUMPER GUARDS FOR CRIBS AND BEDS AND PROTECTIVE EDGING FOR TABLES; PLAYPENS FOR BABIES; NURSERY FURNITURE, NAMELY, CRIBS, TABLES, BUREAUS AND ROCKING CHAIRS; FOLDING CHAIRS (U.S. CLS. 2, 13, 22, 25, 32 AND 50).

CLASS 24—FABRICS

FOR BATH LINEN; BED BLANKETS; BED LINEN; BLANKETS FOR COVERING SLEEPING BAGS, NAMELY, UNFITTED AND FITTED WOOLEN, COTTON AND POLYESTER BLANKETS FOR INDOOR AND OUTDOOR USE; FABRICS OF TEXTILES FOR THE MANUFACTURE OF CLOTHING, BEDDING AND MATTRESSES; PILLOWCASES; QUILTS; DUVETS; FIRST DUVET FOR CHILDREN WITH ATTACHED PILLOW CASE AND ZIP-ON DUVET COVER; BED SHEETS; COT SHEETS; ALLERGY FREE COT SHEETS; FABRIC CURTAINS IN THE NATURE OF WINDOW-COVERINGS THAT DARKEN ROOMS; COMFORTERS FOR BABIES; WATERPROOF FABRICS FOR MANUFACTURING CLOTHING; ALLERGY-FREE BED PADS; ALLERGY-FREE DUVETS; ALLERGY-FREE PILLOWS; ALLERGY-FREE SHEETS; ALLERGY-FREE BLANKETS; CURTAINS; CO-ORDINATED FABRICS, NAMELY, FABRICS FOR THE MANUFACTURE OF CLOTHING; SEAT PROTECTIVE COVERS, NAMELY, UNFITTED FABRIC FURNITURE COVERS; TOWELS; WASHCLOTHS; HOODED BATH TOWELS; TRAVEL COT SHEETS (U.S. CLS. 42 AND 50).

CLASS 25—CLOTHING

FOR BABY NAPKINS OF TEXTILE, NAMELY, CLOTH DIAPERS; BABIES PANTS; CHILDREN'S BATH ROBES; CHILDREN'S CUDDLE ROBES; CHILDREN'S BATH SLIPPERS; BATHING SUITS; BATHING TRUNKS; BIBS, NOT OF PAPER, NAMELY, CLOTH BIBS; MASQUERADE COSTUMES; DRESSING GOWNS; PAJAMAS; SUN VISORS; BODY SUITS FOR BABIES AND TODDLERS; SLEEP SUITS, NAMELY, PAJAMAS AND BODY SUITS; SLEEP SUITS WITH SOCKS, NAMELY, PAJAMAS AND BODY SUITS; BABY CLOTHING, NAMELY, TOPS, TROUSERS, DRESSES AND SWEATERS; BABY HEADGEAR, NAMELY, HATS, BONNETS AND CAPS; SWADDLING FOR BABIES, NAMELY, BABIES' WRAPS; CHILDREN'S CLOTHING, NAMELY, TOPS, TROUSERS, DRESSES AND SWEATERS; CHILDREN'S HEADGEAR, NAMELY, HATS, BONNETS AND CAPS; CHILDREN'S FOOTWEAR; UV PROTECTIVE CLOTHING, NAMELY, TOPS, TROUSERS, DRESSES, SWIMWEAR AND SWEA-

TERS; UV PROTECTIVE HEADGEAR, NAMELY, SUN VISORS AND HATS; SWIMWEAR THAT PROVIDES UV PROTECTION; SWIMWEAR MADE OF CHLORINE-RESISTANT FABRIC; WATERPROOF CLOTHING, NAMELY, FOOTWEAR, JACKETS, HATS AND TROUSERS; MATERNITY CLOTHING, NAMELY, SUPPORTIVE TOPS AND BREAST FEEDING TOPS; MATERNITY FOOTWEAR; MATERNITY UNDERWEAR; MATERNITY BREAST FEEDING T-SHIRTS; BELLY BRA, NAMELY, FULL TORSO SUPPORT GARMENT FOR USE DURING PREGNANCY (U.S. CLS. 22 AND 39).

CLASS 35—ADVERTISING AND BUSINESS

FOR THE BRINGING TOGETHER, FOR THE BENEFIT OF OTHERS, OF A VARIETY OF GOODS, ENABLING THE CUSTOMER TO CONVENIENTLY VIEW AND PURCHASE THESE GOODS, IN A RETAIL STORE, OR FROM A CATALOGUE, OR BY MEANS OF TELECOMMUNICATIONS INCLUDING INTERNET WEBSITES (U.S. CLS. 100, 101 AND 102).

SEAN CROWLEY, EXAMINING ATTORNEY

SN 79-036,533. REHAU AG + CO, REHAU, FED REP GERMANY, FILED 8-28-2006.



PRIORITY DATE OF 3-3-2006 IS CLAIMED.
OWNER OF INTERNATIONAL REGISTRATION 0918947 DATED 8-28-2006, EXPIRES 8-28-2016.
THE COLOR(S) RED, GREEN AND GRAY IS/ARE CLAIMED AS A FEATURE OF THE MARK.
THE COLOR GREEN, GRAY AND RED EACH APPEARS IN ONE OF THREE ROUNDED TRIANGULAR FIGURES ARRANGED TOGETHER TO FORM A LARGER TRIANGULAR FIGURE.

CLASS 1—CHEMICALS

FOR ACETATE OF CELLULOSE, UNPROCESSED; ACETATES; ACETIC ANHYDRIDE; ACETONE; ACETYLENE TETRACHLORIDE; ACETYLENE; ACIDULATED WATER FOR RECHARGING ACCUMULATORS; ACIDULATED WATER FOR RECHARGING BATTERIES; ACRYLIC RESINS, UNPROCESSED; ACTINIUM; ACTIVATED CARBONS; ADHESIVE PREPARATIONS FOR SURGICAL BANDAGES; ADHESIVES FOR BILLPOSTING; ADHESIVES FOR INDUSTRIAL PURPOSES; ADHESIVES FOR PAPERHANGING; ADHESIVES FOR WALL TILES; ADHESIVES USED IN INDUSTRY; AGAR; AGGLUTINANTS FOR CONCRETE; AGGRESSOR REPELLENT CHEMICALS; ALBUMINIZED PAPER; ALDEHYDES; ALGAROVILLA FOR TANNING LEATHER; ALGINATES FOR INDUSTRIAL PURPOSES; ALKALIES; ALKALINE IODIDES FOR INDUSTRIAL PURPOSES; ALKALINE METALS; ALKALINE-EARTH METALS; ALKALOIDS FOR INDUSTRIAL PURPOSES; ALUM; ALUMINIUM OXIDE; ACETIC ACID; ALUMINIUM ALUM; ALUMINIUM CHLORIDE; ALUMINIUM HYDRATE; ALUMINIUM IODIDE; ALUMINIUM SILICATE; AMERICIUM; AMMONIA FOR INDUSTRIAL PURPOSES; AMMONIUM

ALUM; AMMONIACAL SALTS; AMMONIUM ALDEHYDE; AMMONIUM SALTS; AMYL ACETATE; AMYL ALCOHOL; ANHYDROUS AMMONIA; ANTI-BOIL PREPARATIONS FOR ENGINE COOLANTS; ANTIFREEZE; ANTI-FROTHING CHEMICAL SOLUTIONS FOR ACCUMULATORS; ANTI-FROTHING CHEMICAL SOLUTIONS FOR BATTERIES; ANTI-INCRUSTANTS; ANTI-KNOCK CHEMICAL SOLUTIONS FOR INTERNAL COMBUSTION ENGINES; GERMIATION INHIBITOR; ANTI-TARNISHING CHEMICALS FOR WINDOWS; ANTIMONY OXIDE; ANTIMONY SULPHIDE; ANTIMONY; ANTISTATIC SPRAY FOR INDUSTRIAL PURPOSES; ANTRANILIC ACID; ARGON; ARSENIC; ARSENIUS ACID; ARTIFICIAL SWEETENERS; ASTATINE; AUXILIARY FLUIDS FOR USE WITH ABRASIVES FOR INDUSTRIAL USE; BACTERIAL PREPARATIONS FOR INDUSTRIAL USE; BACTERIOLOGICAL PREPARATIONS FOR ACETIFICATION; BARIUM SULPHATE; BARIUM; PHOTOGRAPHIC PAPER, NAMELY, BARYTA PAPER; BARYTES; BASIC GALLATE OF BISMUTH; BAUXITE; CHEMICAL PRODUCTS FOR PRESERVING BEER; BENTONITE; BENZENE FOR INDUSTRIAL USE; BENZOIC ACID; BENZOIC SULPHINIDE; BERKELIUM; SODIUM BICARBONATE; BICHLORIDE OF TIN; POTASSIUM BICHROMATE; SODIUM BICHROMATE; CATALYSTS FOR BIOCHEMICAL PROCESSES; BIRDLIME FOR INDUSTRIAL PURPOSES; BISMUTH; BISMUTH NITRITE; BLEACHING PREPARATIONS FOR INDUSTRIAL PURPOSES; BLUEPRINT CLOTH FOR MAKING BLUEPRINTS; BLUEPRINT PAPER; SODIUM BORATE; BORIC ACID FOR INDUSTRIAL PURPOSES; BRAKE FLUID; BRAZING FLUXES; BRICKWORK PRESERVATIVES; CAESIUM; ANHYDROUS SODIUM CARBONATE; CALCIUM CARBIDE; CALCIUM CYANAMIDE; CALIFORNIUM; CAMPHOR FOR INDUSTRIAL PURPOSES; CARBIDES; CARBON AND LAMP BLACK FOR INDUSTRIAL PURPOSES; ABSORBING CARBONS FOR FILTERS; CARBON DISULPHIDE; CARBON TETRACHLORIDE; CARBONATES; CARBONIC HYDRATES; CASEIN FOR INDUSTRIAL PURPOSES; LUTETIUM; CAUSTIC ALKALIES; CAUSTIC SODA FOR INDUSTRIAL PURPOSES; CELLULOSE ESTERS FOR INDUSTRIAL PURPOSES; CELLULOSE ETHERS FOR INDUSTRIAL PURPOSES; CELLULOSE; ADHESIVE CEMENT FOR USE WITH METAL; ADHESIVE CEMENT FOR MANUFACTURING BOOTS AND SHOES; RUBBER CEMENT FOR REPAIRING PNEUMATIC TIRES; MASONRY CEMENT PRESERVATIVES; WATERPROOFING CHEMICAL COMPOSITIONS FOR MASONRY CEMENT; CERAMIC GRANULES AND POWDER FOR INDUSTRIAL SINTERING; CERAMIC GLAZINGS; CERIUM; CHEMICAL ADDITIVES TO DRILLING MUDS; CHEMICAL ADDITIVES TO FUNGICIDES; CHEMICAL ADDITIVES TO INSECTICIDES; CHEMICAL ADDITIVES TO MOTOR FUEL; CHEMICAL CONDENSATION PREPARATIONS FOR INDUSTRIAL PURPOSES; CHEMICAL INTENSIFIERS FOR PAPER FOR INDUSTRIAL PURPOSES; CHEMICAL INTENSIFIERS FOR RUBBER FOR INDUSTRIAL PURPOSES; CHEMICAL PREPARATIONS FOR SCIENTIFIC PURPOSES; CHEMICAL PREPARATIONS FOR DECARBONISING ENGINES; CHEMICAL PREPARATIONS FOR FACILITATING THE METAL ALLOYING; CHEMICAL PREPARATIONS FOR PROTECTION AGAINST WHEAT BLIGHT; CHEMICAL PREPARATIONS FOR PERSONAL DEFENSE SPRAYS; CHEMICAL PREPARATIONS FOR SMOKING MEAT; CHEMICAL PREPARATIONS FOR THE MANUFACTURE OF PAINTS; CHEMICAL PREPARATIONS FOR THE MANUFACTURE OF PIGMENTS; CHEMICAL PREPARATIONS FOR USE IN PHOTOGRAPHY; CHEMICAL PREPARATIONS TO PREVENT MILDEW; CHEMICAL PRODUCTS FOR THE PREPARATION OF ENAMELS; CHEMICAL REAGENTS FOR NON-MEDICAL OR NON-VETERINARY PURPOSES; CHEMICAL PRODUCTS FOR THE FRESH-KEEPING AND PRESERVING OF FOOD; CHEMICALS FOR FERMENTING WINE; CHEMICALS USED IN INDUSTRY, SCIENCE AND PHOTOGRAPHY; CHEMICALS PREPARATIONS FOR CLEANING CHIMNEYS; KAOLIN; CHLORATES, NAMELY, SODIUM CHLORATE, POTASSIUM CHLORATE, AND MAGNESIUM CHLORATE; CHLORINE; CHOLIC ACID; CHROME ALUM; CHROMIUM OXIDES; UNEXPOSED CINEMATOGRAPHIC FILM; CITRIC ACID FOR INDUSTRIAL PURPOSES; COBALT OXIDES FOR INDUSTRIAL PURPOSES; COLLODION; TIRE PUNCTURE SEALANT; CHEMICAL COMPOSITIONS FOR THE MANUFACTURE OF PHONOGRAPH RECORDS; CHEMICAL COMPOSITIONS FOR THE MANUFACTURE OF TECHNICAL

CERAMICS; COMPOST; CONCRETE PRESERVATIVES; CONCRETE AERATION CHEMICALS; COOLANTS FOR VEHICLE ENGINES; COPPER SULPHATE; CREAM OF TARTAR FOR INDUSTRIAL PURPOSES; CREOSOTE FOR INDUSTRIAL PURPOSES; CROTONIC ALDEHYDE; CULTURES OF MICROORGANISMS FOR SCIENTIFIC AND INDUSTRIAL PURPOSES; CURIUM; CHEMICAL PREPARATIONS FOR CURRYING LEATHER; CHEMICAL PREPARATIONS FOR CURRYING ANIMAL SKINS; CYANIDES; CYMENE; DAMP-PROOFING CHEMICAL COMPOSITIONS FOR MASONRY; DECOLORANTS FOR INDUSTRIAL PURPOSES; DEFOLIANTS; DEGREASING PREPARATIONS FOR USE IN MANUFACTURING PROCESSES; DEGUMMING PREPARATIONS FOR INDUSTRIAL PURPOSES; DEHYDRATING PREPARATIONS FOR INDUSTRIAL PURPOSES; DETERGENT ADDITIVES TO GASOLINE; DETERGENTS FOR USE IN MANUFACTURING PROCESSES; DEXTRINE SIZE; DIAGNOSTIC PREPARATIONS, OTHER THAN FOR MEDICAL OR VETERINARY PURPOSES; DIASTASE FOR INDUSTRIAL PURPOSES; DIATOMACEOUS EARTH; DIAZO PAPER; HYDROGEN PEROXIDE FOR INDUSTRIAL PURPOSES; DISINCRUSTANTS FOR INDUSTRIAL USE; DISPERSIONS OF PLASTICS FOR INDUSTRIAL USE; DISTILLED WATER; DOLOMITE FOR INDUSTRIAL PURPOSES; DRILLING MUDS FOR USE IN OIL WELL DRILLING; DRY ICE; DYSPROSIUM; PLANTING AND POTTING SOIL; EMOLLIENTS FOR INDUSTRIAL PURPOSES; EMULSIFIERS FOR INDUSTRIAL USE; ENZYMES AND ENZYME PREPARATIONS FOR INDUSTRIAL PURPOSES; UNPROCESSED EPOXY RESINS; ERBIUM; ESTERS; ETHANE; ETHERS; ETHYL ALCOHOL; ETHYL ETHER; EUROPIUM; FERMENTS FOR INDUSTRIAL AND SCIENTIFIC PURPOSES; FERMIUM; FERROCYANIDES; UNEXPOSED FERROTYPE PLATES; FERTILIZERS; CHEMICAL PREPARATIONS IN THE NATURE OF FILTERING MATERIALS FOR THE BEVERAGE INDUSTRY; FIRE EXTINGUISHING COMPOSITIONS; FIREPROOFING PREPARATIONS; FUEL FOR NUCLEAR REACTORS; FIXING SOLUTIONS FOR PHOTOGRAPHY; WOOD FLOUR FOR USE AS A FILLER IN THE MANUFACTURE OF PLASTICS; FLOWER PRESERVATIVES; FLUIDS FOR HYDRAULIC CIRCUITS; FLUORINE; FLUORITE; FORMIC ACID; FORMALDEHYDE; FOUNDRY SAND; FRANCIUM; FULLER'S EARTH FOR USE IN TEXTILE INDUSTRY; FULFING PREPARATIONS FOR USE IN TEXTILE INDUSTRY; GADOLINIUM; TANNIN EXTRACTED FROM GALLNUTS FOR INDUSTRIAL PURPOSES; GALLIC ACID FOR THE MANUFACTURE OF INK; GALLIUM; GALLOTANNIC ACID; GAS PROPELLANTS FOR AEROSOLS; GAS PURIFYING PREPARATIONS FOR INDUSTRIAL USE; GELATINE FOR INDUSTRIAL AND PHOTOGRAPHIC PURPOSES; FROSTING AND STAINING CHEMICALS FOR TREATING GLASS AND ENAMEL; GLUCOSE AND GLUCOSIDES FOR INDUSTRIAL PURPOSES; GLUE FOR INDUSTRIAL PURPOSES; GLUTEN-BASED GLUE FOR INDUSTRIAL PURPOSES, TREE BANDING, AND TREE GRAFTING; GLYCERIDES; GLYCERINE FOR INDUSTRIAL PURPOSES; GLYCOL ETHER; GLYCOL; GOLD SALTS, NAMELY, POTASSIUM GOLD CYANIDE; GRAFTING MASTIC FOR TREES; GRAFTING WAX FOR TREES; GRAPHITE IN RAW OR SEMI-FINISHED FORM FOR USE IN MANUFACTURE AND INDUSTRY; GUANO; GUM ARABIC GLUE FOR INDUSTRIAL PURPOSES; GUM SOLVENTS FOR INDUSTRIAL PURPOSES; GUM ADHESIVES FOR INDUSTRIAL USE; HEAVY WATER; HELIUM; HOLMIUM; PLANT HORMONES FOR HASTENING THE RIPENING OF FRUIT; HUMUS TOP DRESSING; HUMUS; CARBON HYDRATES; HYDRAZINE; HYDROCHLORIDES; HYDROCHLORIC ACID; HYDROFLUORIC ACID; HYDROGEN; SODIUM HYPOCHLORITE; SODIUM THIOSULFATE; CHEMICALS FOR INDUSTRIAL USE; IODIC ACID; IODINE FOR INDUSTRIAL PURPOSES AND SCIENTIFIC PURPOSES; IODISED SALTS; IRON SALTS FOR INDUSTRIAL AND SCIENTIFIC PURPOSES; ISINGLASS FOR INDUSTRIAL AND SCIENTIFIC PURPOSES; ISOTOPES FOR INDUSTRIAL PURPOSES; KAINITE; KETONES; KIESELGUR; KRYPTON; LACTIC ACID FOR INDUSTRIAL AND SCIENTIFIC PURPOSES; LANTHANUM; LEAD ACETATE; LEAD ARSENATE; LEAD OXIDES; GLUES AND MASTICS FOR THE MANUFACTURING OF LEATHER; CHEMICALS FOR USE IN THE MANUFACTURE OF LEATHER; CHEMICAL AGENTS FOR IMPREGNATING, BINDING OR COATING OF LEATHER; WATERPROOFING CHEMICAL COMPOSITIONS FOR ARTICLES OF

LEATHER; LECITHIN FOR INDUSTRIAL USE IN THE MANUFACTURE OF FOOD PRODUCTS; LIME ACETATE; LIME CARBONATE; LIME CHLORIDE; LIMESTONE HARDENING SUBSTANCES; LIQUID RUBBER; LIQUIDS FOR REMOVING SULFATES FROM ACCUMULATORS; LIQUIDS FOR REMOVING SULFATES FROM BATTERIES; LITHIUM OXIDE; LITHIUM; LITMUS PAPER; LOAM; MAGNESITE; MAGNESIUM CARBONATE; MAGNESIUM CHLORIDE; MAGNETIC FLUID FOR INDUSTRIAL PURPOSES; MANGANATE; MANGANESE DIOXIDES; TANNIN EXTRACTED FROM MANGROVE BARK FOR INDUSTRIAL PURPOSES; MANURE FOR AGRICULTURE; MANURES; MASONRY PRESERVATIVES; MASTICS FOR THE MANUFACTURE OF TIRES; MEAT TENDERIZERS FOR INDUSTRIAL PURPOSES; MERCURY OXIDES; MERCURY; MERCURY SALTS FOR INDUSTRIAL AND SCIENTIFIC PURPOSES; METAL ANNEALING PREPARATIONS; RARE METAL EARTHS; METAL HARDENING PREPARATIONS; METAL TEMPERING PREPARATIONS; METHANE; TOLUOL; METHYL BENZOL; METHYL ETHER; MILK FERMENTS FOR INDUSTRIAL AND SCIENTIFIC PURPOSES; MINERAL ACIDS FOR INDUSTRIAL AND SCIENTIFIC PURPOSES; MOISTENING PREPARATIONS FOR USE IN BLEACHING FOR INDUSTRIAL PURPOSES; MOISTENING PREPARATIONS FOR USE IN DYEING FOR INDUSTRIAL PURPOSES; MOISTENING PREPARATIONS FOR USE IN THE TEXTILE INDUSTRY; MOLD-RELEASE PREPARATIONS; MORDANTS FOR METALS; MUST-FINING PREPARATIONS FOR WINE; NAPHTHALENE; NEODYMIUM; NEON; NEPTUNIUM; URANIUM NITRATE; NITRATE PAPER; NITRIC ACID; NITRIC MONOXIDE FOR INDUSTRIAL AND SCIENTIFIC PURPOSES; NITROGEN; NITROGENOUS FERTILIZERS; NITROUS OXIDE FOR INDUSTRIAL AND SCIENTIFIC PURPOSES; BACTERICIDES FOR USE IN WINE MAKING; CHEMICALS FOR DISPERSING, BLEACHING, PURIFYING, AND SEPARATING OIL FOR INDUSTRIAL AND SCIENTIFIC PURPOSES; OILS FOR CURRYING LEATHER; OILS FOR PREPARING LEATHER IN THE COURSE OF MANUFACTURE; OILS FOR TANNING LEATHER; OILS FOR THE PRESERVATION OF FOOD; OLEIC ACID; OLIVINE FOR INDUSTRIAL PURPOSES; OPACIFIERS FOR ENAMEL OR GLASS; OPACIFIERS FOR ENAMEL AND GLASS; ORGANIC BLEACHING CHEMICALS FOR INDUSTRIAL AND SCIENTIFIC PURPOSES; OXALATES; OXALIC ACID; OXYGEN; PALLADIUM CHLORIDE; PAPER PULP FOR MANUFACTURING PURPOSES; PEAT; PEAT POTS FOR HORTICULTURE; PECTIN FOR USE IN PHOTOGRAPHIC PROCESSES; SODIUM PERBORATE; POTASSIUM PERCARBONATE; PERCHLORATES FOR INDUSTRIAL AND SCIENTIFIC PURPOSES; PERSULFATES FOR INDUSTRIAL AND SCIENTIFIC PURPOSES; PERSULFURIC ACID INDUSTRIAL AND SCIENTIFIC PURPOSES; PETROLEUM DISPERSANTS; PHENOL FOR INDUSTRIAL PURPOSES; PHOSPHATES FERTILIZERS; PHOSPHOLIPIDS FOR INDUSTRIAL AND SCIENTIFIC PURPOSES; PHOSPHORIC ACID; PHOSPHORUS; PHOTOGRAPHIC DEVELOPERS; PHOTOGRAPHIC EMULSIONS; PHOTOGRAPHIC PAPER; PHOTOGRAPHIC SENSITIZERS; PHOTOMETRIC PAPER; PICRIC ACID; PLANT GROWTH REGULATING PREPARATIONS; PLASTICIZERS; UNPROCESSED PLASTICS; PLASTISOLS; PLUTONIUM; POLISH REMOVING SUBSTANCES FOR INDUSTRIAL PURPOSES; POLONIUM; POTASH WATER; POTASH; POTASSIUM DIOXALATE; POTASSIUM FOR INDUSTRIAL AND SCIENTIFIC PURPOSES; POTATO FLOUR FOR INDUSTRIAL PURPOSES; POTTING SOIL; POWER STEERING FLUID; PRASEODYMIUM; PREPARATIONS FOR PREVENTING THE TARNISHING OF GLASS AND LENSES FOR INDUSTRIAL AND SCIENTIFIC PURPOSES; PREPARATIONS FOR THE PURIFICATION OF GAS FOR INDUSTRIAL AND SCIENTIFIC PURPOSES; PREPARATIONS FOR THE SEPARATION OF GREASES FOR INDUSTRIAL AND SCIENTIFIC PURPOSES; MICROORGANISMS PREPARATIONS FOR INDUSTRIAL AND SCIENTIFIC PURPOSES; PREPARATIONS OF DISTILLED WOOD ALCOHOL FOR INDUSTRIAL AND SCIENTIFIC PURPOSES; PRESERVATIVES FOR TILES; PROMETHIUM; PROTACTINIUM; PROTECTIVE GASES FOR WELDING; PROTEINS FOR INDUSTRIAL AND SCIENTIFIC PURPOSES; PYROGALLIC ACID FOR INDUSTRIAL AND SCIENTIFIC PURPOSES; PYROLIGNEOUS ACID FOR INDUSTRIAL AND SCIENTIFIC PURPOSES; QUEBRACHO FOR INDUSTRIAL PURPOSES; FLUSHING AGENTS FOR AUTOMOBILE RADIATORS; RADIOACTIVE ELEMENTS FOR SCIENTIFIC

PURPOSES; RADIUM FOR SCIENTIFIC PURPOSES; RADON; RARE EARTHS; REAGENT PAPER FOR SCIENTIFIC USE; REDUCING AGENTS FOR USE IN PHOTOGRAPHY; REFRIGERANTS; RHENIUM; ROCK SALT; UNEXPOSED ROENTGEN FILMS; RUBBER PRESERVATIVES FOR INDUSTRIAL USE; RUBBER SOLUTIONS; RUBIDIUM; SACCHARIN; AMMONIUM CHLORIDE SPIRITS; AMMONIUM CHLORIDE; SALICYLIC ACID FOR INDUSTRIAL AND SCIENTIFIC PURPOSES; POTASSIUM AND SODIUM NITRATE; SALT FOR PRESERVING FOR INDUSTRIAL PURPOSES; SALTS FOR USE AS FERTILIZER; SALTS FOR COLORING METAL FOR INDUSTRIAL PURPOSES; SALTS FOR GALVANIC BATTERIES; SALTS FOR GALVANIC CELLS; SALTS FOR INDUSTRIAL AND SCIENTIFIC PURPOSES; SALTS FROM RARE EARTH METALS; SALTS OF ALKALINE METALS FOR INDUSTRIAL PURPOSES; SALTS OF PRECIOUS METALS FOR INDUSTRIAL PURPOSES; SAMARIUM; CHEMICAL SOLUTIONS FOR THE PROCESSING OF TOBACCO; PREPARATIONS FOR REMOVING SCALE FROM METALS FOR INDUSTRIAL PURPOSES; SCANDIUM; SEA WATER FOR INDUSTRIAL PURPOSES; SEAWEED FOR USE AS FERTILIZER; SEBACIC ACID; CHEMICAL PREPARATIONS FOR USE IN AGRICULTURE, HORTICULTURE AND FORESTRY, NAMELY, SEED PRESERVING SUBSTANCES; SELENIUM; SELF-TONING PAPER FOR PHOTOGRAPHIC PROCESSES; SENSITIZED PHOTOGRAPHIC FILM, CLOTH, AND PLATES; SENSITIZED PHOTOGRAPHIC PLATES FOR OFFSET PRINTING; SILICATES FOR INDUSTRIAL AND SCIENTIFIC USE; SILICON; SILICONES FOR INDUSTRIAL AND SCIENTIFIC PURPOSES; SILVER NITRATE; SILVER SALT SOLUTIONS FOR SILVERING; SIZE FOR FINISHING AND PRIMING WALLS; BASIC SLAG FOR USE AS FERTILIZER; METALLIC SOAP FOR INDUSTRIAL PURPOSES; SODIUM SALTS FOR INDUSTRIAL AND SCIENTIFIC PURPOSES; SODIUM; SOIL-CONDITIONING CHEMICALS; SOLDERING CHEMICALS; SOLDERING FLUXES; SOLUTIONS FOR BLUEPRINTING; SOLVENTS FOR MANUFACTURING VARNISHES; SOOT FOR INDUSTRIAL OR AGRICULTURAL PURPOSES; SORREL SALT FOR INDUSTRIAL AND SCIENTIFIC PURPOSES; MAGNESIUM ALUMINUM OXIDE; SPIRITS OF SALT; DILUTE ACETIC ACID; STAIN REPELLENTS FOR USE ON FABRICS; STARCH FOR INDUSTRIAL PURPOSES; STARCH PASTE; STEARIC ACID; STRONTIUM; SUBSTANCES FOR PREVENTING RUNS IN STOCKINGS FOR THE MANUFACTURE OF STOCKINGS; GROWING MEDIA FOR PLANTS FOR SOIL-FREE GROWING; SULPHATES; SULPHIDES; SULPHONIC ACIDS; SULPHUR; SULPHURIC ACID; SULPHURIC ETHER; SULPHUROUS ACID; SUMAC FOR USE IN TANNING ANIMAL HIDES; SUPERPHOSPHATES FOR USE AS FERTILIZER; SURFACE ACTIVE COMPOUNDS FOR GENERAL USE IN THE INDUSTRIAL ARTS, NAMELY, AS WETTING, SPREADING, EMULSIFYING, DISPERSING AND PENETRATING AGENTS; SYNTHETIC MATERIALS FOR ABSORBING OIL; UNPROCESSED SYNTHETIC RESINS; MAGNESIUM SILICATE; TANNIC ACID; TANNING AGENTS FOR USE IN THE MANUFACTURE OF LEATHER; TAPIOCA FLOUR FOR INDUSTRIAL PURPOSES; TARTARIC ACID; TECHNETIUM; TELLURIUM; TEMPERING AND SOLDERING CHEMICAL PREPARATIONS; TERBIUM; CHEMICAL TEST PAPER; TETRACHLORIDES FOR INDUSTRIAL AND SCIENTIFIC PURPOSES; BRIGHTENING, IMPREGNATING, AND WATER-PROOFING CHEMICALS FOR THE MANUFACTURE OF TEXTILES; THALLIUM; THIOCARBANILIDE; THORIUM; THULIUM; TITANIUM DIOXIDE FOR INDUSTRIAL PURPOSES; TOLUENE; TONING BATHS AND SALTS FOR PHOTOGRAPHIC PROCESSES; TOXIC GAS NEUTRALIZING CHEMICALS FOR INDUSTRIAL USE; TRAGACANTH GUM FOR USE IN MANUFACTURING; TRANSMISSION FLUID; TREE CAVITY FILERS; TUNGSTIC ACID; CHEMICAL PREPARATIONS FOR LIQUIFYING STARCH; UNPROCESSED ARTIFICIAL RESINS; URANIUM OXIDE; URANIUM; CHEMICAL PREPARATIONS FOR USE IN AGRICULTURE, HORTICULTURE, AND FORESTRY, NAMELY, CHEMICALS FOR PREVENTING VINE DISEASE; VINIC ALCOHOL FOR INDUSTRIAL AND SCIENTIFIC USE; UNPROCESSED CELLULOSE ACETATE FOR INDUSTRIAL PURPOSES; VULCANISATION ACCELERATORS; VULCANISING PREPARATIONS FOR THE INDUSTRIAL PURPOSES; SODIUM SILICATE; WATER PURIFYING AND SOFTENING CHEMICALS; WELDING CHEMICALS; WETTING AGENTS FOR USE IN

BLEACHING AND DYEING; WETTING AGENTS FOR USE IN THE TEXTILE INDUSTRY; WITHERITE; METHYL ALCOHOL; WOOD PULP FOR MANUFACTURING PURPOSES; UNEXPOSED X-RAY FILM; XENON; YTTERBIUM; YTTRIUM; ZIRCONIUM OXIDE (U.S. CLS. 1, 5, 6, 10, 26 AND 46).

CLASS 6—METAL GOODS

FOR ADVERTISEMENT COLUMNS OF METAL; ALLOYS OF COMMON METAL; ALUMINUM FOIL; ALUMINUM WIRE; ALUMINUM; METAL ANCHOR PLATES; ANCHORS; METAL ANGLE IRONS; ANTI-FRICTION METAL; ANVILS; PORTABLE ANVILS; ARMOR PLATING MADE OF METAL; AVIARIES OF METAL; BADGES OF METAL FOR VEHICLES; BALLS OF STEEL; BANDS OF METAL FOR TYING-UP PURPOSES; BARBED WIRE; BARREL HOOPS OF METAL; BARRELS OF METAL; BARS FOR METAL RAILINGS; BASKETS OF COMMON METAL; NON-LUMINOUS BEACONS OF METAL; BED CASTERS OF METAL; METAL BELLS FOR ANIMALS; METAL BELLS; BELT STRETCHERS OF METAL; BELTS OF METAL FOR HANDLING LOADS; BERYLLIUM ORE; METAL BICYCLE STORAGE RACKS; BINDING SCREWS OF METAL FOR CABLES; BINDING THREAD OF METAL FOR AGRICULTURAL PURPOSES; BINDINGS OF METAL; BINS OF METAL; METAL BIRD BATHS; BLOOMS OF IRON; MOBILE BOARDING STAIRS OF METAL FOR AIRLINE PASSENGERS; METAL BOLTS; BOOTHS OF METAL FOR SPRAYING PAINT; BOTTLE CAPS OF METAL; BOTTLE CLOSURES OF METAL; METAL BOTTLES FOR COMPRESSED GAS OR LIQUID AIR; BOXES OF COMMON METAL; CONSTRUCTION ELEMENTS MADE OF METAL, NAMELY, BRACES; BRACKETS OF METAL FOR BUILDING; METAL BRADS; BRANCHING PIPES OF METAL; UNWROUGHT AND SEMI-WROUGHT BRASS; BRAZING ALLOYS; BRONZE; BRONZE WORKS OF ART; BRONZE FOR TOMBSTONES; BROOM HANDLES OF METAL; BUCKLES OF COMMON METAL; BUILDING OR FURNITURE FITTINGS OF GERMAN SILVER; BUILDING PANELS OF METAL, NAMELY, CEILING, DOOR, FENCE, GATE, ROOFING, AND WALL PANELS; PREFABRICATED AND MOBILE BUILDINGS OF METAL; CASK STOPPERS OF METAL, NAMELY, BUNGS; BUSTS OF COMMON METAL; NON-ELECTRICAL CABLE JOINTS OF METAL; NON-ELECTRICAL CABLE LINKAGES OF METAL; NON-ELECTRICAL CABLES OF METAL; CADMIUM METAL; WINDOWS CASEMENT OF METAL; CASHBOXES OF METAL; CASINGS OF METAL FOR OILWELLS; CASK STANDS OF METAL; CASKS OF METAL; UNWROUGHT OR SEMI-WROUGHT CAST IRON; CRUCIBLE STEEL; METAL CHAINS FOR CALVING; METAL CEILING PANELS; HAFNIUM METAL; CERMETS MADE PRIMARILY OF METAL; METAL CHAINS FOR DOGS; CHAINS OF METAL; CHESTS OF METAL FOR FOOD; CHESTS OF METAL; METAL CHICKEN COOPS; FOUNDRY CHILL-MOLDS; METAL CHIMNEY COWLS; CHIMNEY POTS OF METAL; CHIMNEY SHAFTS OF METAL; CHIMNEYS OF METAL; CHROME IRON; CHROME ORES; CHROMIUM METAL; CLADDING OF METAL FOR CONSTRUCTION AND BUILDING; CLIPS OF METAL FOR CABLES AND PIPES; CLIPS OF METAL FOR PIPES; CLOSURES OF METAL FOR CONTAINERS; CLOTHES HOOKS OF METAL; COBALT ORES; COLLARS OF METAL FOR FASTENING PIPES; UNWROUGHT AND SEMI-WORKED COMMON METALS AND THEIR ALLOYS; CONTAINERS OF METAL FOR STORAGE AND TRANSPORT; CONTAINERS OF METAL FOR COMPRESSED GAS OR LIQUID AIR; CONTAINERS OF METAL FOR LIQUID FUEL; CONTAINERS OF METAL FOR STORING ACIDS; COPPER RINGS FOR INDICATE USE; COPPER WIRE, NOT INSULATED; UNWROUGHT OR SEMI-WROUGHT COPPER; CORNICES OF METAL; COTTER PINS; COUPLINGS OF METAL FOR CHAINS; CRAMPONS; CRASH BARRIERS OF METAL FOR ROADS; DIVING BOARDS OF METAL; NON-ELECTRIC DOOR BELLS; METAL DOOR BOLTS; DOOR CASES OF METAL; NON-ELECTRIC METAL DOOR CLOSERS; METAL DOOR FITTINGS; DOOR FRAMES OF METAL; DOOR HANDLES OF METAL; METAL DOOR KNOCKERS; NON-ELECTRIC METAL DOOR OPENERS; DOOR PANELS OF METAL; METAL DOOR SCRAPERS; NON-ELECTRIC METAL DOOR SPRINGS; DOOR STOPS OF METAL; DOORS OF METAL; DRAIN PIPES OF METAL; DRAIN TRAPS OF METAL; DUCKBOARDS OF METAL;

METAL DUCTS AND PIPES FOR CENTRAL HEATING INSTALLATIONS; METAL DUCTS FOR VENTILATING AND AIR CONDITIONING INSTALLATIONS; ELBOWS OF METAL FOR PIPES; METAL TOMBS ENCLOSURES; EYE BOLTS; FENCES OF METAL; FERROTITANIUM ALLOYS; FERRULES OF METAL FOR HANDLES; FERRULES OF METAL FOR WALKING STICKS; FIGURINES OF COMMON METAL; FILINGS OF METAL; FIRE-DOGS; METAL FISH PLATES; FITTINGS OF METAL FOR BEDS; FITTINGS OF METAL FOR BUILDINGS; FITTINGS OF METAL FOR COFFINS; FITTINGS OF METAL FOR COMPRESSED AIR DUCTS; FITTINGS OF METAL FOR FURNITURE; FITTINGS OF METAL FOR WINDOWS; FLANGES OF METAL; FLASHING OF METAL FOR BUILDING; FLOATING CONTAINERS OF METAL; FLOATING DOCKS OF METAL FOR MOORING BOATS; FLOOR TILES OF METAL; FLOORS OF METAL; FOILS OF METAL FOR WRAPPING AND PACKAGING; METAL FOOT SCRAPERS; FOUNDRY MOLDS OF METAL; FRAMES OF METAL FOR BUILDING; METAL SCREENS FOR INDUSTRIAL FURNACES; FURNITURE CASTERS OF METAL; GALENA ORE; GATE STOPS OF METAL; GATES OF METAL; GERMAN SILVER; GERMANIUM ORE; GIRDERS OF METAL; GOLD SOLDER; GRATINGS OF METAL; GRAVESTONE SLABS OF NON-PRECIOUS METAL; GRAVESTONES OF NON-PRECIOUS METAL; METAL GREASE NIPPLES; GREENHOUSE FRAMES OF METAL; TRANSPORTABLE GREENHOUSES OF METAL; GUARD RAILS OF METAL; GUTTER PIPES OF METAL; GUTTERS OF METAL; HANDCUFFS; HANDLING PALLETS OF METAL; HARNESS OF METAL FOR HANDLING LOADS; HINGES OF METAL; METAL HOOKS; METAL HOOKS FOR SLATE; HOOKS OF METAL FOR CLOTHES RAILS; HOOP IRON; HOOP STEEL; NON-MECHANICAL HOPPERS OF METAL; METAL HORSESHOE NAILS; HORSESHOES OF METAL; NON-LUMINOUS HOUSE NUMBERS OF METAL; ICE MOULDS OF METAL; IDENTIFICATION BRACELETS OF METAL FOR HOSPITALS; IDENTITY PLATES OF METAL; INDIUM ORE; INGOTS OF COMMON METAL; INSECT SCREENS OF METAL; IRON ORES; IRON SLABS; IRON STRIPS; IRON WIRE; IRON, UNWROUGHT OR SEMI-WROUGHT; IRONWORK FOR DOORS; IRONWORK FOR WINDOWS; JALOUSIES OF METAL; JOISTS OF METAL; JUNCTIONS OF METAL FOR PIPES; METAL KEY BLANKS; KNIFE HANDLES OF METAL; KNOBS OF METAL; LADDERS OF METAL; LATCH BARS OF METAL; LATCHES OF METAL; LATHS OF METAL; LATTICEWORK OF METAL; LEAD SEALS; UNWROUGHT OR SEMI-WROUGHT LEAD; LETTER BOXES OF METAL; METAL HOUSE NUMBERS AND LETTERS; LIMONITE ORE; LININGS OF METAL FOR BUILDING PURPOSES; LINTELS OF METAL; LOADING PALLETS OF METAL; NON-ELECTRONIC METAL LOCKS; LOCKS OF METAL FOR BAGS; LOCKS OF METAL FOR VEHICLES; MACHINE BELT FASTENERS OF METAL; MAGNESIUM ORES; MANGANESE ORES; MANHOLE COVERS OF METAL; MANIFOLDS OF METAL FOR PIPELINES; METALLIC MATERIALS FOR RAILWAY TRACKS; MATERIALS OF METAL FOR RAILWAY TRACKS; METAL MEMORIAL PLAQUES; MEMORIAL PLATES OF METAL; MOLDINGS OF METAL FOR CORNICES; MOLYBDENUM ORES; MONEY BOXES OF METAL; MONEY CLIPS OF COMMON METAL; MONUMENTS OF BRONZE FOR TOMBS; MONUMENTS OF NON-PRECIOUS METAL FOR TOMBS; MONUMENTS OF NON-PRECIOUS METAL; MOORING BOLLARDS OF METAL; MOORING BUOYS OF METAL; NAILS; NICKEL ORE; NIOBIUM ORE; NON-ELECTRIC CABLES AND WIRES OF COMMON METAL; LICENSE PLATES OF METAL; NUTS OF METAL; ORES OF METAL; OUTDOOR BLINDS OF METAL; INDUSTRIAL PACKAGING CONTAINERS OF METAL; METAL PADLOCKS; PAINT SPRAYING BOOTHS OF METAL; PALINGS OF METAL; PARTITIONS OF METAL; PAVING BLOCKS OF METAL; PEGS OF METAL; METAL PENSTOCK PIPES; PILINGS OF METAL; PRE-FABRICATED METAL ARCHITECTURAL COLUMNS; PIPE MUFFS OF METAL; PIPES AND TUBES OF METAL; PIPES OF METAL FOR CENTRAL HEATING INSTALLATIONS; MOUNTAINEERING EQUIPMENT, NAMELY, PITONS OF METAL; PREFABRICATED PLATFORMS OF METAL; PLUGS OF METAL; POLES OF METAL FOR ELECTRIC LINES; POLES OF METAL; PREFABRICATED PORCHES OF METAL; POSTS OF METAL FOR ELECTRIC LINES; POSTS OF METAL; POT HOOKS OF METAL; METAL PRESERVE CONTAINERS; BUILDING PROPS OF METAL; METAL

HARDWARE, NAMELY, PULLEYS; PYROPHORIC METAL ORE; RAILROAD TIES OF METAL; RAILS OF METAL; RAILWAY CONSTRUCTION MATERIAL OF METAL; METAL RAILWAY POINTS; RAILWAY SWITCHES; NON-MECHANICAL REELS OF METAL FOR FLEXIBLE HOSES; REINFORCING MATERIALS OF METAL FOR BUILDING PURPOSES; REINFORCING MATERIALS OF METAL FOR MACHINE BELTS; REINFORCING MATERIALS OF METAL FOR PIPES; REINFORCING MATERIALS OF METAL FOR CONCRETE; RINGS OF COMMON METAL FOR KEYS; RIVETS OF METAL; ROCKET LAUNCHING PLATFORMS OF METAL; RODS OF METAL FOR BRAZING AND WELDING; EXTERIOR ROLLER BLINDS OF STEEL; ROOF COVERINGS OF METAL; ROOF FLASHING OF METAL; ROOFING OF METAL; ROPE THIMBLES OF METAL; ROPES OF METAL; RUNNERS OF METAL FOR SLIDING DOORS; METAL SAFES; SAFETY DEPOSIT BOXES; METAL CASH BOXES; SASH FASTENERS OF METAL FOR WINDOWS; METAL SASH PULLEYS; SCAFFOLDING OF METAL; METAL SCREW RINGS; SCREWS OF METAL; SCYTHE HANDLES OF METAL; SEALING CAPS OF METAL FOR BOTTLES; SEALING CAPS OF METAL; SHEAF BINDERS OF METAL; SHEET PILES OF METAL; SHEETS AND PLATES OF METAL; METAL SHIMS; METAL CASTING FORMS FOR CONCRETE; INTERIOR SHUTTERS OF METAL; SIGNALING PANELS, NON-LUMINOUS AND NON-MECHANICAL, OF METAL; SIGNBOARDS OF METAL; NON-LUMINOUS AND NON-MECHANICAL SIGNS OF METAL, FOR ROADS; NON-LUMINOUS AND NON-MECHANICAL SIGNS OF METAL; SILICON IRON ALLOY; WINDOW SILLS OF METAL; SILOS OF METAL; SILVER PLATED TIN ALLOY; SILVER SOLDER; SLINGS OF METAL FOR HANDLING LOADS; SOLDERING WIRE OF METAL; METAL SPRING LOCKS; METAL HARDWARE, NAMELY, SPRINGS; SPURS; STAIR TREADS OF METAL; STAIRCASES OF METAL; STATUES OF NON-PRECIOUS METAL; STATUETTES OF NON-PRECIOUS METAL; STEEL ALLOYS; PREFABRICATED STEEL BUILDINGS; STEEL PIPES; STEEL SHEETS; STEEL STRIP; STEEL TUBES; STEEL WIRE; UNWROUGHT OR SEMI-WROUGHT STEEL; STEPS LADDERS OF METAL; STIRRUPS OF METAL; STOP COLLARS OF METAL; STRAP-HINGES OF METAL; STRAPS OF METAL FOR HANDLING LOADS; METAL STRETCHERS FOR IRON BANDS; METAL STRETCHERS FOR METAL BANDS; STAIRCASE STRINGERS OF METAL; METAL SWIMMING POOLS; METAL HARDWARE, NAMELY, TACKS; METAL FLUID STORAGE TANKS; TANTALUM AND ITS ALLOYS; METAL TAPS FOR CASKS OF METAL; TELEGRAPH POSTS OF METAL; TELEPHONE BOOTHS OF METAL; METAL TELPHER CABLES; METAL TENSION LINKS; TENT PEGS OF METAL; THREAD OF METAL FOR TYING-UP PURPOSES; METAL TIE PLATES; TILE FLOORINGS OF METAL; TILES OF METAL FOR BUILDING; TILES OF METAL; TIN CANS, SOLD EMPTY; TIN AND ITS ALLOYS; TINFOIL; TIN PLATING; TITANIUM ALLOYS; TOMBAC ALLOY; TOMBS OF NON-PRECIOUS METAL; TOMBSTONE PLAQUES OF NON-PRECIOUS METAL; TOMBSTONE STELAE OF NON-PRECIOUS METAL; TOMBSTONES OF NON-PRECIOUS METAL; TOOL BOXES OF METAL; TOOL CHESTS OF METAL; TOOL HANDLES OF METAL; FIXED TOWEL DISPENSERS OF METAL; TRANSPORT PALLETS OF METAL; TRAPS FOR WILD ANIMALS; TREE PROTECTORS OF METAL; TRELLIS OF METAL; TROUGHS OF METAL FOR MIXING MORTAR; TUBES OF METAL; TUNGSTEN ORE; NON-AUTOMATIC TURNSTILES; RAILWAY TURNTABLES; MANUALLY OPERATED METAL VALVES; VANADIUM ORES; VATS OF METAL; BURIAL VAULTS OF METAL; VICE BENCHES OF METAL; VICE CLAWS OF METAL; WAINSCOTTING OF METAL; WALL CLADDINGS OF METAL FOR BUILDING; WALL HOOKS OF METAL FOR PIPES; WALL LININGS OF METAL FOR BUILDING; WALL PLUGS OF METAL; METAL HARDWARE, NAMELY, WASHERS; MANUALLY OPERATED WATER-PIPE VALVES OF METAL; WATER-PIPES OF METAL; WEATHER VANES OF METAL; WEATHER OR WIND-VANES OF METAL; METAL WHEEL CLAMPS; WIND VANES OF METAL; CLOCK WINDING KEYS OF METAL; NON-MECHANICAL WINDING SPOOLS OF METAL FOR FLEXIBLE HOSES; METAL WINDOW CASEMENT BOLTS; METAL WINDOW FASTENERS OF METAL; WINDOW FRAMES OF METAL; METAL WINDOW PULLEYS; WINDOW STOPS OF METAL; WINDOWS OF METAL; WIRE CLOTH; METAL WIRE FOR AERIALS; WIRE GAUZE; WIRE OF COMMON METAL

ALLOYS; WIRE OF COMMON METAL; WIRE ROPE; WORKS OF ART OF COMMON METAL; WRAPPING OR BINDING BANDS OF METAL; ZINC ORES; ZIRCONIUM ORES (U.S. CLS. 2, 12, 13, 14, 23, 25 AND 50).

CLASS 7—MACHINERY

FOR ADHESIVE BANDS FOR PULLEYS; MECHANIZED ADHESIVE TAPE DISPENSERS; AERATED BEVERAGES MAKING MACHINES; AERATED WATER MAKING MACHINES; AERATING AQUARIUM PUMPS; AERATORS; AIRCRAFT ENGINES; AGRICULTURAL ELEVATORS; AIR BRUSHES FOR APPLYING COLOR; AIR CONDENSERS; AIR CUSHION DEVICES FOR MOVING LOADS; COMPRESSED AIR PUMPS; AIR SUCTION MACHINES; AC GENERATORS; ANTI-FRICTION PADS FOR MACHINES; ANTI-POLLUTION DEVICES FOR MOTORS AND ENGINES; ANTI-FRICTION BEARINGS FOR MACHINES; APPARATUS FOR DRAWING UP BEER UNDER PRESSURE, NAMELY, BEER PUMPS; APRONS FOR MACHINES; ATOMISERS MACHINES; AUTOMATED GRAPNELS FOR MARINE PURPOSES; AXLES FOR MACHINES; BEARING BRACKETS FOR MACHINES; BEARINGS FOR MACHINES; BEARINGS FOR TRANSMISSION SHAFTS; FORGE BELLOWS; BELT CONVEYORS; BELTS FOR CONVEYORS; BELTS FOR MACHINES; BENDING MACHINES; BICYCLE ASSEMBLING MACHINES; BICYCLE DYNAMOS; HAY BINDING MACHINES; BITUMEN MAKING MACHINES; MACHINE PARTS, NAMELY, BLADES, BLADE SHARPENERS, AND BLADE HOLDERS; ELECTRIC FOOD BLENDERS FOR HOUSEHOLD PURPOSES; ENGINES FOR BLOWING MACHINES; BLOWING MACHINES FOR EXHAUSTION OF DUST; BLOWING MACHINES FOR THE COMPRESSION, EXHAUSTION, AND TRANSPORT OF GASES; BLOWING MACHINES FOR THE COMPRESSION, SUCKING AND CARRYING OF GRAIN; BOBBINS FOR WEAVING LOOMS; BOOK-BINDING MACHINES FOR INDUSTRIAL PURPOSES; BOTTLE CAPPING MACHINES; BOTTLING MACHINES; BOTTLE SEALING MACHINES; BOTTLE STOPPERING MACHINES; BOTTLE WASHING MACHINES; TEXTILE BRAIDING MACHINES; BRAKE LININGS FOR MACHINES; BRAKE SEGMENTS FOR MACHINES; BRAKE SHOES FOR MACHINES; BREAD SLICING MACHINES; ELECTRICALLY OPERATED BRUSHES BEING PARTS OF MACHINES; BULLDOZERS; BUTTER MACHINES; CALENDERS; ELECTRIC CAN OPENERS; POWER-OPERATED CAPSTANS; CARBON BRUSHES BEING PARTS OF MOTORS, GENERATORS AND DYNAMOS; CARBURETOR; CARD CLOTHING FOR CARDING MACHINES; CARDING MACHINES; CARRIAGES FOR KNITTING MACHINES; CATALYTIC CONVERTERS FOR MOTORS AND ENGINES; CENTRAL VACUUM CLEANING INSTALLATIONS; CENTRIFUGES; CENTRIFUGAL GRINDING MACHINES; CENTRIFUGAL PUMPS; BLADES FOR ELECTRIC CHAFF CUTTER; ELECTRIC CHAFF CUTTERS; CHAIN SAWS; CHISELS FOR MACHINES; CHUCKS FOR POWER DRILLS; POWER OPERATED INDUSTRIAL MILK CHURNS; MACHINES FOR MAKING CIGARETTE; CINDER SIFTING MACHINES FOR INDUSTRIAL PURPOSES; CLUTCHES FOR MACHINES; COALCUTTING MACHINES; ELECTRIC COFFEE GRINDERS; COIN-OPERATED WASHING MACHINES FOR CLOTHING; AIR POWERED TOOLS, NAMELY, GUNS FOR THE EXTRUSION OF MASTICS; AIR COMPRESSORS; COMPRESSORS FOR REFRIGERATORS; CONCRETE MIXERS; STEAM CONDENSERS; CONNECTING RODS FOR MACHINES, MOTORS AND ENGINES; TEXTILE MACHINES, NAMELY, PRINTING, PRESSING, SCUTCHING, TENTERING, AND WASHING MACHINES FOR TEXTILES; CONTROL CABLES FOR MACHINES, ENGINES, AND MOTORS; CONTROL MECHANISMS FOR MACHINES, ENGINES, AND MOTORS; CONVEYORS; MACHINES FOR MAKING CORD; CORN AND GRAIN HUSKING MACHINES; COUPLINGS FOR MACHINES; COWLINGS FOR MACHINES; CRANES; CRANKCASES FOR MACHINES, MOTORS AND ENGINES; CRANKS FOR MACHINES; MACHINES FOR SEPARATING MILK AND CREAM; WASTE CRUSHING MACHINES; POWER-OPERATED CULTIVATORS; ELECTRIC GENERATORS; ELECTRICALLY OPERATED CURTAIN DRAWING MACHINE; BLOW TORCHES, NAMELY, GAS OPERATED CUTTING TORCHES; CUTTING MACHINES; CYLINDERS FOR MACHINES; CYLINDERS FOR MOTORS AND ENGINES; SEWING MACHINES; DASHPOT PLUNGERS

FOR MACHINES; POWER OPERATED DE-AERATORS FOR FEEDWATER; DERRICKS; DIE-CUTTING AND TAPPING MACHINES; DIE-STAMPING MACHINES; EARTH MOVING MACHINES, NAMELY, BACKHOES, GRADERS, LOADERS, SCARIFIERS, SCRAPERS, AND EXCAVATORS; DISHWASHERS; DISINTEGRATORS; PLOUGHS; POWER-OPERATED TOOLS, NAMELY, GRINDERS AND CRUSHERS; DRAIN COCKS; POWER DRILL BITS; POWER DRILL HEADS; DRILLING MACHINES; FLOATING OR NON-FLOATING OIL AND GAS DRILLING RIGS; TIMING CHAINS FOR MACHINES, MOTORS, AND ENGINES USED IN INDUSTRIAL APPLICATIONS; ELECTRIC MOTORS FOR MACHINES; DIP-DYEING MACHINES; DYNAMO BELTS; DYNAMO BRUSHES; DYNAMOS; EDIBLE PASTES MAKING MACHINES; ELECTRIC HAMMERS; ELECTRIC HAND-HELD DRILLS; PARTS OF ELEVATORS, NAMELY, ELEVATOR BELTS AND CHAINS; ELEVATORS; EMBOSsing MACHINES; EMERGENCY ELECTRIC GENERATORS; ENGINES FOR AIR CUSHION VEHICLES; ENGINES FOR BOATS; ENGINES NOT FOR LAND VEHICLES; ENGRAVING MACHINES; ESCALATORS; EXHAUST MANIFOLD FOR ENGINES; FAN BELTS FOR MOTORS AND ENGINES; FANS FOR MACHINE MOTORS AND ENGINES; FANS FOR MACHINES THAT COMPRESS, SUCK, AND CARRY GRAIN; FILTER PRESSES FOR MECHANICAL PURPOSES; WATER, AIR, AND OIL FILTERING MACHINES FOR MECHANICAL PURPOSES; WATER, AIR, AND OIL FILTERS FOR MACHINES AND ENGINES; FLESHING MACHINES; FLOUR MILLING MACHINES; FLUES FOR ENGINE BOILERS; FODDER PRESSES; ELECTRIC FOOD PROCESSORS; ELECTRIC FRUIT SQUEEZERS FOR HOUSEHOLD PURPOSES; FUEL ECONOMIZERS FOR MOTORS AND ENGINES; GARBAGE DISPOSALS; GASIFIERS; GEAR BOXES FOR INDUSTRIAL MACHINERY; GEARS FOR WEAVING LOOMS; GEARS FOR INDUSTRIAL MACHINERY; GLOW PLUGS FOR DIESEL ENGINES; ELECTRIC GLUE GUNS; POWER-OPERATED GRAIN SEPARATING MACHINES; GRATING MACHINES FOR VEGETABLES; GREASE BOXES FOR INDUSTRIAL MACHINERY; GREASE RINGS FOR INDUSTRIAL MACHINERY; GRINDING MACHINES; MACHINE PARTS, NAMELY, GRINDSTONES; HAIR CLIPPING MACHINES FOR ANIMALS; HAIR CUTTING MACHINES FOR ANIMALS; MATERIAL HANDLING MACHINES, NAMELY, PALLETIZERS, CASE ELEVATORS, AUTOMATIC PALLET DISPENSING MACHINES, AND AUTOMATIC SLIP SHEET DISPENSING MACHINES; TRACTOR-TOWED HARROWS; HEAT EXCHANGERS BEING PARTS OF MACHINES; SHOE HEEL MAKING MACHINES; SEWING MACHINES FOR HEMMING TEXTILES; MULTI-PURPOSE HIGH PRESSURE WASHERS; HOISTS; HOLDING DEVICES FOR MACHINE TOOLS; MACHINE PARTS, NAMELY, HOODS; HOSIERY LOOMS; HYDRAULIC CONTROLS FOR MACHINES, MOTORS, AND ENGINES; HYDRAULIC DOOR OPENERS AND CLOSERS; HYDRAULIC ENGINES AND MOTORS FOR MACHINES; HYDRAULIC TURBINES; IGNITING DEVICES FOR INTERNAL COMBUSTION ENGINES, NAMELY, SPARK PLUGS, IGNITION WIRES, AND SPARK PLUG CABLES; IGNITING MAGNETOS FOR INTERNAL COMBUSTION ENGINES; INCUBATORS FOR EGGS; FUEL INJECTORS FOR ENGINES; INKING APPARATUS FOR PRINTING MACHINES; ELECTRIC CLOTHING PRESSING MACHINES; JET ENGINES NOT FOR LAND VEHICLES; JOINTS FOR ENGINES; KICK STARTERS FOR MOTORCYCLES; KNEADING MACHINES; KNITTING MACHINES; MACHINE PARTS, NAMELY, BLADES; MACHINE PARTS, NAMELY, BLADES FOR LAWN MOWERS; ELECTRIC KNIVES; LACE MAKING MACHINES; MACHINE LASTS FOR MAKING SHOES; LATHES; LAWNMOWERS; LEATHER PARING MACHINES; POWER-OPERATED LOADING RAMPS; PARTS FOR POWER LOOMS, NAMELY, LOOM SHAFTS; POWER LOOMS; MACHINE LUBRICATING PUMPS; MACHINE LUBRICATORS; MACHINE COUPLINGS; POWER TRANSMISSIONS AND GEARING FOR MACHINES; MACHINE FLY-WHEELS; CARPET CLEANING MACHINES; ELECTRIC WAX-POLISHING MACHINES FOR HOUSEHOLD AND INDUSTRIAL PURPOSES; MANGLES; PRINTING PLATES; ELECTRIC MEAT CHOPPERS; ELECTRIC MEAT MINCERS; MECHANIZED LIVESTOCK FEEDERS; MILKING MACHINES; MILLING MACHINES; ELECTRIC GRINDERS; MACHINE PARTS, NAMELY, MILLSTONES; MINE BORERS; MINERAL WATER MAKING MACHINES; MIXERS; COMPRESSION, EXTRUSION,

AND INJECTION MOLDING MACHINES; MORTISING MACHINES; MOTORIZED CULTIVATORS; MOTORS AND ENGINES NOT FOR LAND VEHICLES; MOTORS FOR BOATS; ELECTRIC MOTORS NOT FOR LAND VEHICLES; MOVING PAVEMENT; REAPING MACHINES; MUFFLERS FOR MOTORS AND ENGINES; NET HAULING MACHINES; MACHINE TOOLS, NAMELY, NOTCHERS; NUT-TAPPING MACHINES; OIL REFINING MACHINES; PACKAGING MACHINES; PACKING MACHINES; PAPER FEEDING MACHINES; PAPERMAKING MACHINES; ELECTRIC PARQUET WAX-POLISHERS; PEDAL DRIVES FOR SEWING MACHINES; ELECTRIC PEPPER MILLS; PISTON RINGS; PISTONS FOR MACHINES; PISTONS FOR CYLINDERS; PISTONS FOR ENGINES; PLANING MACHINES; MACHINE PARTS, NAMELY, BLADES FOR PLOUGHS; PNEUMATIC CONTROLS FOR MACHINES, MOTORS AND ENGINES; PNEUMATIC DOOR OPENERS AND CLOSERS; PNEUMATIC HAMMERS; PNEUMATIC TRANSPORTERS; PNEUMATIC TUBE CONVEYORS; POWER-OPERATED POTTERS' WHEELS; POWER-OPERATED HAMMERS; INDUSTRIAL MACHINE PRESSES; PRESSING MACHINES FOR TEXTILES, NAMELY, PRESSING MACHINES TO MANUFACTURE SATIN-LIKE MATERIALS; PRINTING CYLINDERS; PRINTING MACHINES FOR USE ON SHEET METAL; PRINTING MACHINES; PRINTING PRESSES; PRINTING ROLLERS FOR MACHINES; PULLEYS BEING PARTS OF MACHINES; POWER-OPERATED PULVERIZERS; ELECTRIC PUMPS FOR HEATING INSTALLATIONS; PUNCHES FOR PUNCHING MACHINES; PUNCHING MACHINES; RACK AND PINION JACKS; RACKET STRINGING MACHINES; RADIATORS FOR MOTORS AND ENGINES; RAILROAD CONSTRUCTION MACHINES, NAMELY, RAIL-LAYING MACHINES; TRACTOR TOWED AGRICULTURAL IMPLEMENTS, NAMELY, HAY RAKES; POWER-OPERATED RAMMERS; POWER-OPERATED AGRICULTURAL MACHINES, NAMELY, REAPERS, BINDERS, AND THRESHERS; REDUCTION GEARS FOR INDUSTRIAL MACHINERY; POWER-OPERATED REELS FOR REELS WEAVING LOOMS AND FLEXIBLE HOSES; REGULATORS FOR MACHINES; POWER-OPERATED RIVETING MACHINES; ROAD MAKING MACHINES, NAMELY, ROAD ROLLERS; ROAD SWEEPING MACHINES; INDUSTRIAL ROBOTS; ROLLER BEARINGS FOR MACHINES; CYLINDERS FOR ROLLING MILL; ROLLING MILLS; ROOT SLICING MACHINES; ROTARY PRINTING PRESSES; PORTABLE ROTARY STEAM PRESSES FOR FABRICS; TEXTILE TREATMENT MACHINES, NAMELY, SATINIZING MACHINES; SAUSAGE MACHINES; SAW BENCHES BEING PARTS OF MACHINES; POWER SAW BLADES; POWER-OPERATED SAWS; ELECTRIC SCISSORS; SEALING JOINTS FOR ENGINES; SEALING MACHINES FOR INDUSTRIAL PURPOSES; MACHINE PARTS, NAMELY, SELF-OILING BEARINGS; CENTRIFUGAL SEPARATORS; SEWAGE PULVERIZING MACHINES; SHAFT COUPLINGS FOR MACHINES; SHARPENING MACHINES, NAMELY, POWER-OPERATED SHARPENING WHEELS; SHEAF-BINDING MACHINES; HAIR SHEARING MACHINES FOR ANIMALS; POWER-OPERATED SHEARS; SHOCK ABSORBER PLUNGERS FOR MACHINES; POWER-OPERATED SHOE LASTS; POWER-OPERATED SHOE POLISHERS; POWER SHOVELS; SHREDDING MACHINES FOR INDUSTRIAL USE; MATERIAL HANDLING MACHINES, NAMELY, SHUTTLES; MACHINES FOR SEPARATING MATERIALS, NAMELY, SIEVES AND SIFTING MACHINES; SILENCERS AS PART OF VEHICLE EXHAUST SYSTEMS; SLIDERS FOR KNITTING MACHINES; SNOW PLOWS; GAS-OPERATED SOLDERING IRONS; SORTING MACHINES FOR INDUSTRY; SOWER MACHINES; SPARK PLUGS FOR INTERNAL COMBUSTION ENGINES; SPEED GOVERNORS FOR MACHINES, ENGINES, AND MOTORS; TEXTILE PROCESSING MACHINES, NAMELY, SPINNING FRAMES, SPINNING MACHINES, AND SPINNING WHEELS; SPRAY GUNS FOR PAINT; MACHINE PARTS, NAMELY, SPRINGS; AUTOMATIC STAMPING MACHINES; STANDS FOR MACHINES; STARTERS FOR MOTORS AND ENGINES; STEAM ENGINE BOILERS; STEAM ENGINES; OIL SEPARATORS; STEAMROLLERS; STITCHING MACHINES; STONE WORKING MACHINES; POWER-OPERATED STROPPING MACHINES; OIL WELL PRODUCTION EQUIPMENT, NAMELY, STUFFING BOXES; SUCTION CUPS FOR MILKING MACHINES; AIR SUCTION MACHINES FOR INDUSTRIAL PURPOSES; SUGAR MAKING MACHINES; COMPRESSORS FOR INTERNAL COMBUSTION ENGINES,

NAMELY, SUPERCHARGERS; POWER-OPERATED SWAGING MACHINES; TABLES FOR MACHINES; TAMBOURS FOR EMBROIDERY MACHINES; POWER-OPERATED TAPS FOR MACHINES, ENGINES, OR MOTORS; TARRING MACHINES; TEAT CUPS FOR MILKING MACHINES; POWER-OPERATED TEDDING MACHINES; THREADING MACHINES; THRESHING MACHINES; TILT HAMMERS FOR FORGES; TOBACCO PROCESSING MACHINES; TORQUE CONVERTERS, NOT FOR LAND VEHICLES; TRANSMISSION CHAINS NOT FOR LAND VEHICLES; TRANSMISSION SHAFTS NOT FOR LAND VEHICLES; TRASH COMPACTING MACHINES; POWER-OPERATED TRUCK LIFTS; AGRICULTURAL IMPLEMENTS, NAMELY, HAY BALERS; TURBINES NOT FOR LAND VEHICLES; TURBOCOMPRESSORS NOT FOR LAND VEHICLES; TYMPANS FOR PRINTING PRESSES; TYPESETTING MACHINES; VACUUM CLEANER ATTACHMENTS FOR DISSEMINATING PERFUMES AND DISINFECTANTS; VACUUM CLEANER BAGS; VACUUM CLEANER HOSES; VACUUM CLEANERS; VACUUM PUMPS; VEHICLE WASHING INSTALLATIONS; CONCRETE VIBRATORS FOR INDUSTRIAL USE; MACHINES FOR VULCANIZING RUBBER; WASHING INSTALLATIONS FOR VEHICLES; CLOTHES WASHING MACHINES; WASTE COMPACTING MACHINES; FOOD WASTE DISPOSALS; WEEDING MACHINES; GAS-OPERATED WELDING MACHINES; ELECTRIC WELDING MACHINES; ELECTRIC MIXERS FOR HOUSEHOLD PURPOSES; WINCHES; MACHINES, NAMELY, WINE PRESSES; WINNOWING MACHINES; WRAPPING MACHINES; WRINGING MACHINES FOR LAUNDRY (U.S. CLS. 13, 19, 21, 23, 31, 34 AND 35).

CLASS 8—HAND TOOLS

FOR ABRADING TOOLS; HAND TOOLS, NAMELY, ADZES; ANNULAR SCREW PLATES; HAND TOOLS, NAMELY, AUGERS; HAND TOOLS, NAMELY, AWLS; AXES; BAYONETS; BEARD CLIPPERS; HAND TOOLS, NAMELY, BILL-HOOKS; BITS FOR HAND DRILLS; SHARPENING WHEELS FOR KNIVES AND BLADES; PLANING BLADES; BLUDGEONS; HAND TOOLS, NAMELY, HEDGE SHEARS; HAND TOOLS, NAMELY, BORERS; BOW SAWS; HAND TOOLS, NAMELY, BRAIDERS; BRANDING IRONS; HAND TOOLS, NAMELY, BREAST DRILLS; BUDDING KNIVES; BUSHHAMMERS; NON-ELECTRIC CAN OPENERS; HAND-OPERATED CATTLE SHEARERS; KNIVES FOR SKINNING CATTLE; CAULKING IRONS; HAND TOOLS, NAMELY, CENTER PUNCHES; CHEESE SLICERS; CHISELS; HAND-OPERATED CHOPPERS; CARPENTER'S CLAMPS; CLEAVERS; HAND TOOLS, NAMELY, CRIMPING IRONS; CROWBARS; NON-ELECTRIC CURLING IRONS; CUTICLE SCISSORS; CUTICLE TWEEZERS; CUTLERY; SICKLE BARS; DAGGERS; DEPILATORY APPLIANCES; HAND TOOLS, NAMELY, DIES; HAND TOOLS, NAMELY, DIGGERS; HAND TOOLS, NAMELY, DITCHERS; HAND OPERATED DRILL HOLDERS; MANUAL DRILLS; EAR PIERCING APPARATUS; HAND TOOLS, NAMELY, EARTH RAMMERS; HAND-OPERATED LAWN EDGERS; EGG SLICERS; HAND TOOLS, NAMELY, MANUALLY-OPERATED EMERY GRINDING WHEELS; ENGRAVING NEEDLES; EYELASH CURLERS; FARRIERS' KNIVES; FILES; FINGERNAIL POLISHERS; FIRE IRONS; FIREPLACE BELLOWS; FLESHING KNIVES; FORKS; HAND TOOLS, NAMELY, FOUNDRY LADLES; FRAMES FOR HANDSAWS; HAND TOOLS, NAMELY, FULLERS; GIMLETS; HAND TOOLS, NAMELY, NON-ELECTRIC GOFFERING IRONS; HAND TOOLS, NAMELY, GOUGES; SPADES; HAND TOOLS, NAMELY, GRAVING TOOLS; HAND TOOLS, NAMELY, MANUALLY-OPERATED GRINDSTONES; CAULKING GUNS; HAINAULT SCYTHES; HAND OPERATED HAIR CLIPPERS FOR ANIMALS; ELECTRIC AND NON-ELECTRIC HAIR CLIPPERS FOR PERSONAL USE; HAIR-REMOVING TWEEZERS; HAMMERS; HAND TOOLS, NAMELY, DRILLS; HAND TOOLS, NAMELY, HAND-OPERATED PUMPS; HARPOONS FOR FISHING; HARPOONS; HATCHETS; HOES; HUNTING KNIVES; HAND TOOLS, NAMELY, ICE PICKS; HAND-OPERATED SPRAYERS FOR INSECTICIDE; JIG-SAWS; KNIVES FOR SKINNING ANIMALS; TICKET PUNCHERS; KNIFE SHARPENING STEELS; KNIVES; HAND-TO-HAND COMBAT WEAPONS, NAMELY, KNUCKLE DUSTERS; HAND TOOLS, NAMELY, LADLES FOR WINE; HAND TOOLS, NAMELY, SHOE LASTS; HAND-OPERATED LAWN CLIPPERS; LEATHER STROPS; HAND OPERATED LIFTING JACKS; MACHETES; MALLETS;

ELECTRIC MANICURE SETS; MANICURE SETS; MARLINE SPIKES; MASONS' HAMMERS; MATTOCKS; HAND TOOLS, NAMELY, MILLING CUTTERS; MINING KNIVES; HAND TOOLS, NAMELY, MITRE BOXES; MORTARS FOR POUNDING; HAND TOOLS, NAMELY, MORTISE AXES; HAND TOOLS, NAMELY, MORTISE CHISELS; ELECTRIC OR NON-ELECTRIC NAIL BUFFERS; ELECTRIC OR NON-ELECTRIC NAIL CLIPPERS; CARPENTERS' PINNERS; ELECTRIC NAIL FILES; NAIL FILES; NAIL NIPPERS; HAND TOOLS, NAMELY, NAIL PUNCHES; HAND TOOLS, NAMELY, NEEDLE FILES; NEEDLE-THREADERS; NIPPERS; HAND TOOLS, NAMELY, NUMBERING PUNCHES; NUTCRACKERS, NOT OF PRECIOUS METAL; OYSTER OPENERS; PALETTE KNIVES; PARING IRONS; PARING KNIVES; PEDICURE SETS; PENKNIVES; HAND TOOLS, NAMELY, PERFORATING TOOLS; PESTLES FOR POUNDING; PICKAXES; HAND TOOLS, NAMELY, PICKS; HAND TOOLS, NAMELY, PIN PUNCHES; HAND TOOLS, NAMELY, PINNERS; NON-ELECTRIC PIZZA CUTTERS; NON-ELECTRIC PLANE IRONS; PLANES; PLIERS; POLICE BATONS; NON-ELECTRIC POLISHING IRONS; NON-ELECTRIC PRIMING IRONS; PRUNING KNIVES; PRUNING SCISSORS; PRUNING SHEARS; HAND TOOLS, NAMELY, PUNCHES; HAND TOOLS, NAMELY, RABBETING PLANES; RAKES; HAND TOOLS, NAMELY, RAMMERS; HAND TOOLS, NAMELY, RASPS; HAND TOOLS, NAMELY, RATCHET WRENCHES; RAZOR BLADES; RAZOR CASES; RAZOR STROPS; ELECTRIC OR NON-ELECTRIC RAZORS; RAZORS; REAMERS; HAND-OPERATED RIVETING TOOLS; SABRES; SAND TRAP RAKES; BLADES FOR HAND SAWS; SAW HOLDERS; SAWS; SCALING KNIVES; SCISSORS; HAND TOOLS, NAMELY, SCRAPERS; HAND TOOLS, NAMELY, SCREW-THREAD CUTTERS; SCREWDRIVERS; SHARPENING STONES FOR SCYTHES; SCYTHES; HAND TOOLS, NAMELY, PRUNERS; SHARPENING STEELS RODS; SHARPENING STEELS; SHARPENING STONES; SHAVING CASES; SHEAR BLADES; SHOVELS; SICKLES; SILVER PLATED KNIVES, FORKS, AND SPOONS; SLEDGEHAMMERS; SPANNERS; SPATULAS FOR SPREADING HOT WAX; SPOONS; HAND TOOLS, NAMELY, SQUARES; HAND TOOLS, NAMELY, STAMPING PRESS; STONE HAMMERS; HAND TOOLS, NAMELY, STRETCHERS FOR WIRE AND METAL BANDS; SUGAR TONGS; SWORD SCABBARDS; SWORDS; TABLE CUTLERY, NAMELY, KNIVES, FORKS, AND SPOONS; TAP WRENCHES; HAND TOOLS, NAMELY, TAPS; HAND TOOLS, NAMELY, THISTLE EXTIRPATORS; HAND TOOLS, NAMELY, TONGS; TOOL BELTS; GARDENING TROWELS; TROWELS; SIDE ARMS, NOT INCLUDING FIREARMS, NAMELY, TRUNCHEONS; HAND TOOLS, NAMELY, TUBE CUTTERS; TWEEZERS; HAND-OPERATED VEGETABLE CHOPPERS; VEGETABLE KNIVES; HAND-OPERATED VEGETABLE SHREDDERS; VEGETABLE SLICERS; VICES; WEEDING FORKS; WHETSTONE HOLDERS; WHETSTONES; CANDLE WICK TRIMMERS; HAND TOOLS, NAMELY, WIRE STRETCHERS; WRENCHES (U.S. CLS. 23, 28 AND 44).

CLASS 11—ENVIRONMENTAL CONTROL APPARATUS

FOR ACETYLENE BURNERS; ACETYLENE FLARES; ACETYLENE GENERATORS; AIR CONDITIONERS FOR VEHICLES; AIR CONDITIONING APPARATUS; CENTRAL AIR CONDITIONING INSTALLATIONS; AIR COOLING UNITS; ELECTRIC AIR DEODORIZERS; DEHUMIDIFIERS; INDUSTRIAL AIR FILTER MACHINES; AIR PURIFYING UNITS FOR COMMERCIAL, DOMESTIC, AND INDUSTRIAL USE; AIR REHEATERS FOR COMMERCIAL, DOMESTIC, AND INDUSTRIAL USE; AIR STERILIZERS; STEAM VALVES FOR HEATING INSTALLATIONS; ALCOHOL BURNERS FOR COOKING; ANTI-DAZZLE AND ANTI-GLARE HEADLIGHT FITTINGS FOR VEHICLES; ANTI-SPLASH TAP NOZZLES; ELECTRIC DEHYDRATORS FOODSTUFFS; LIGHTING FIXTURES; HOT-AIR SPACE HEATING APPARATUS; STEAM GENERATORS; COOKING RANGES; REFRIGERATORS; INDUSTRIAL DRYERS FOR HEATING AND DEHUMIDIFYING; AQUARIUM FILTRATION APPARATUS; AQUARIUM HEATERS; AQUARIUM LIGHTS; ARC LAMPS; ASH CONVEYORS AND PITS FOR FURNACES; ATOMIC PILES; AUTOCLAVES; AUTOMOBILE HEADLIGHTS; BAKING OVENS; BARBECUES; BATH TUBS; BATHTUB AND SHOWER LININGS; BATH TUBS FOR SITZ BATHS;

BED WARMERS; PORTABLE THERMOELECTRIC COOLING UNIT FOR BEVERAGES; BICYCLE LIGHTS; BIDETS; ELECTRIC BLANKETS NOT FOR MEDICAL PURPOSES; PIPES FOR HEATING BOILERS; ELECTRIC AND FURNACE BOILERS; BRACKETS FOR GAS BURNERS; ELECTRIC BREAD TOASTERS; CARBON ARC LAMPS; CEILING FIXTURES FOR ELECTRIC LIGHTS; CENTRAL HEATING RADIATORS; CHANDELIERS; CHIMNEY BLOWERS; CHIMNEY FLUES; ELECTRIC CHINESE LANTERNS; CLEAN ROOMS; ELECTRIC COFFEE FILTERS; ELECTRIC COFFEE PERCOLATORS; ELECTRIC COFFEE ROASTERS; HEATING AND COOLING COILS FOR HEATING AND AIR CONDITIONING UNITS; GAS COOKERS; COOKING RINGS; COOLERS FOR FURNACES; COOLING VATS FOR FURNACES; DAMPERS, NAMELY, CONTROL DEVICES USED IN AIR DUCTS TO REGULATE THE FLOW OF AIR; ELECTRIC DEEP FRYERS; DEFROSTING APPARATUS FOR VEHICLES; DENTAL OVENS; WATER DESALINATION PLANTS; DISCHARGE LAMPS AND THEIR FITTINGS; DISINFECTANT DISPENSERS FOR TOILETS; WATER DISTILLATION UNITS; WATER DISTILLATION COLUMNS; DIVING LIGHTS; DRIP IRRIGATION EMITTERS; DRYERS FOR DRYING ANIMAL FEED; ELECTRIC YOGURT MAKERS; ELECTRIC FANS FOR PERSONAL USE; ELECTRIC LAMPS; ELECTRIC LIGHTS FOR CHRISTMAS TREES; ELECTRICALLY HEATED CARPETS; EVAPORATORS; EXPANSION TANKS FOR CENTRAL HEATING INSTALLATIONS; EXTRACTOR HOODS FOR KITCHENS; ELECTRIC HOLIDAY LIGHTS; FANS FOR AIR CONDITIONING UNITS; FAUCETS FOR PIPES; FEEDERS FOR HEATING BOILERS; FILAMENTS FOR ELECTRIC LAMPS; FILTERS FOR AIR CONDITIONING UNITS; FILTERS FOR DRINKING WATER; FIREPLACES; FLARE STACKS FOR USE IN OIL REFINERIES; FLARE STACKS FOR USE IN THE OIL INDUSTRY; FLARES; FLASHLIGHTS; FLUES FOR FURNACE BOILERS; FLUSH LEVERS; TOILET TANKS; ELECTRIC FOOTWARMERS; PORTABLE FORGES; DECORATIVE WATER FOUNTAINS; FRAMEWORK OF METAL FOR OVENS; FREEZERS; FRICTION LIGHTERS FOR IGNITING GAS FURNACES; ELECTRIC FRUIT ROASTERS; FUEL ECONOMIZERS FOR GAS FURNACES AND STOVES; FURNACE ASH BOXES; FURNACE GRATES; FURNACES NOT FOR EXPERIMENTAL PURPOSES; FURNACES; GAS FURNACE BOILERS; ELECTROCHEMICAL GAS GENERATORS; GAS LAMPS; GAS SCRUBBERS; AIR CLEANING UNITS CONTAINING AN AIR FILTER, ULTRAVIOLET LIGHTS, AND A PHOTOCATALYTIC FILTER; GLASS LANTERN GLOBES; ELECTRIC GRIDDLES; ELECTRIC AND GAS GRILLS; LAMP SHADES; HAIR DRYERS; ELECTRIC HAND DRYING APPARATUS FOR WASHROOMS; HEADLIGHTS FOR AUTOMOBILES; HEARTHS; HEAT ACCUMULATORS; HEAT EXCHANGERS; HEAT PUMPS; HEAT REGENERATORS; ELECTRIC HEATERS FOR BATHS; ELECTRIC HEATERS FOR HEATING IRONS; HEATERS FOR VEHICLES; ELECTRIC HEATERS FOR BABY BOTTLES; ELECTRIC HEATING APPARATUS FOR SOLID, LIQUID, OR GASEOUS FUELS; ELECTRIC HEATING BOILERS; ELECTRIC HEATING CUSHIONS NOT FOR MEDICAL PURPOSES; HOT WATER HEATERS; ELECTRIC HEATING PADS NOT FOR MEDICAL PURPOSES; ELECTRIC HOT PLATES; HOT AIR BLOWERS; CONVECTION OVENS; HOT PLATES; HOT WATER BOTTLES; HUMIDIFIERS FOR CENTRAL HEATING RADIATORS; HYDRANTS; ICE CHESTS; ICE MACHINES; IMMERSION WATER HEATERS; INCANDESCENT BURNERS FOR LIGHTING; INCINERATORS; INSTALLATIONS FOR PROCESSING NUCLEAR FUEL AND NUCLEAR MODERATING MATERIAL; AIR PURIFYING IONIZERS; ELECTRIC KETTLES; KILN FURNITURE; KILNS; BUNSEN BURNERS FOR LABORATORY USE; LABORATORY LAMPS; LAMP CASINGS; LAMP CHIMNEYS; LAMP GLASSES; LAMP GLOBES; LAMP HANGING SUPPORTS; LAMP MANTLES; LAMP REFLECTORS; VEHICLE TURN-SIGNAL LIGHT BULBS; LAMPS; LAMP SHADE HOLDERS; ELECTRIC LANTERNS FOR LIGHTING; ELECTRIC LAUNDRY DRYERS; ELECTRIC LAUNDRY ROOM BOILERS; LAVA ROCKS FOR USE IN BARBECUE GRILLS; ELECTRIC LIGHT BULBS; LIGHT BULBS; LIGHT DIFFUSERS; LANDSCAPE LIGHTING INSTALLATIONS; LIGHTS FOR VEHICLES; LOADING APPARATUS FOR FURNACES; LUMINOUS HOUSE NUMBERS; LUMINOUS TUBES FOR LIGHTING; MAGNESIUM FILAMENTS FOR ELECTRIC LAMPS; MALT ROASTERS; MICROWAVE; MILK COOLING UNITS; SAFETY LAMPS FOR UNDERGROUND USE; MIXER

FAUCETS FOR WATER PIPES; NUCLEAR REACTORS; OIL BURNERS; OIL LAMPS; MINERAL OIL-SCRUBBERS; ORNAMENTAL WATER FOUNTAINS; OXYHYDROGEN BURNERS; SPIGOTS; PIPES BEING PARTS OF SANITARY FACILITIES; ELECTRIC PLATE WARMERS; NON-ELECTRIC POCKET WARMERS, NAMELY, CHEMICALLY-ACTIVATED HEATING PACKETS FOR WARMING HANDS; POLYMERIZATION OVENS; ELECTRIC PRESSURE COOKERS; ELECTRIC PRESSURE COOKING SAUCEPANS; PRESSURIZED HOT WATER TANKS; PROCESSING INSTALLATIONS FOR NUCLEAR FUEL; SEWAGE TREATMENT PLANTS; PROJECTOR LAMPS; RADIATOR CAPS; RADIATORS; REFRIGERATING MACHINES; REFRIGERATING DISPLAY CABINETS; REGULATING ACCESSORIES FOR WATER SUPPLY, NAMELY, METERED VALVES; ELECTRIC ROASTERS; ELECTRIC ROASTING SPITS; ROTISERIES; SAUNAS; SEARCHLIGHTS; SHAPED SHOWER ENCLOSURES; SHOWERS; SINKS; SOCKETS FOR ELECTRIC LIGHTS; SOLAR COLLECTORS; SOLAR FURNACES; SOLDERING LAMPS; SPAS IN THE NATURE OF HEATED POOLS; STEAM ACCUMULATORS; STEAM BOILERS; ELECTRONIC FACIAL STEAMERS; STERILIZERS; GAS, ELECTRIC, OIL COOKING, AND WOOD BURNING STOVES; STREET LAMPS; SWIMMING POOL CHLORINATING UNITS; TANNING BEDS; THERMOSTATIC VALVES; ELECTRIC TOASTERS; TOBACCO ROASTERS; TOILET BOWLS; TOILET SEATS; TOILETS; PORTABLE TOILETS; URINALS; VEHICLE HEADLIGHTS; VEHICLE REFLECTORS; AIR-CONDITIONING UNITS; AIR-CONDITIONING UNITS FOR VEHICLES; VENTILATION HOODS FOR LABORATORIES; VENTILATION HOODS; ELECTRIC WAFFLE IRONS; WALK-IN COOLERS; WARMING PANS FOR BEDS; WATER CLOSETS; WATER FILTERS; WATER PURIFICATION UNITS; WATER SOFTENING UNITS; WATER STERILIZERS; NON-MECHANIZED LIVESTOCK WATERING UNITS; WHIRLPOOL-JETS (U.S. CLS. 13, 21, 23, 31 AND 34).

CLASS 12—VEHICLES

FOR ADHESIVE RUBBER PATCHES FOR REPAIRING TUBES OR TIRES; AIRPLANES; AIR BAGS; AIRSHIPS; AIR CUSHION VEHICLES; AIR PUMPS OF AUTOMOBILES, TWO-WHEELED MOTOR VEHICLES, AND BICYCLES; AIRCRAFT; AMBULANCES; AMPHIBIOUS AIRPLANES; LAND VEHICLE PARTS, NAMELY, TIRE CHAINS; ANTI-THEFT WARNING APPARATUS FOR MOTOR CARS; ANTI-THEFT ALARMS FOR VEHICLES; AUTOMOBILE BODIES; AUTOMOBILE CHASSIS; AUTOMOBILE HOODS; AUTOMOBILE TIRES; AUTOMOBILES; AXLE JOURNALS FOR LAND VEHICLES; AXLES FOR LAND VEHICLES; BABY CARRIAGES; BALANCE WEIGHTS FOR VEHICLE WHEELS; BARGES; BASKETS ADAPTED FOR BICYCLES; BELLS FOR BICYCLES; BICYCLE BRAKES; BICYCLE CHAINS; BICYCLE FRAMES; BICYCLE HANDLE BARS; BICYCLE PUMPS; BICYCLE WHEEL RIMS; BICYCLE SADDLES; BICYCLE WHEEL SPOKES; BICYCLE STANDS; BICYCLE TIRES; BICYCLES; BOAT HOOKS; BOATS; BODIES FOR LAND VEHICLES; BOGIES FOR RAILWAY CARS; BRAKE LININGS FOR LAND VEHICLES; BRAKE SEGMENTS FOR MOTOR CARS; BRAKE SHOES FOR LAND VEHICLES; BRAKES FOR LAND VEHICLES; BUFFERS FOR RAILWAY ROLLING STOCK; BUMPER FOR AUTOMOBILES; CABLE CARS; CAMPING TRAILERS; GAS CAPS FOR LAND VEHICLES; RAILWAY CARRIAGES; CARRIER TRICYCLES; CARS; CARTS; CHAIRLIFTS; CLEANING TROLLEYS; BOAT CLEATS; CLUTCHES FOR LAND VEHICLES; CONCRETE MIXING TRUCKS; CONNECTING RODS FOR LAND VEHICLES, OTHER THAN PARTS OF MOTORS AND ENGINES; TRAILER COUPLINGS; COVERS FOR BABY CARRIAGES; CRANKCASES FOR COMPONENTS FOR MOTOR CARS; BICYCLE PEDALS; BICYCLE HUBS; BICYCLE MUDGUARDS; DAVITS FOR BOATS; DINING RAILWAY CARS; DIRECTION INDICATORS FOR BICYCLES; DIRECTION SIGNALS FOR VEHICLES; DIS-ENGAGING GEAR FOR BOATS; DOORS FOR LAND VEHICLES; BOATS FOR DREDGING; DRESS GUARDS FOR BICYCLES; ENGINES FOR LAND VEHICLES; EJECTOR SEATS FOR AIRCRAFT; MOTORIZED TAILGATES FOR TRUCKS; FENDERS FOR SHIPS; FERRY BOATS; FLANGES FOR RAILWAY WHEELS; FLANGES OF RAILWAY WHEELS; FORK LIFT TRUCKS; FREE-WHEELS FOR LAND VEHICLES; FUNICULAR RAILCARS; FUNNEL EXHAUSTS FOR LOCOMOTIVES;

FUNNEL EXHAUSTS FOR SHIPS; GEAR BOXES FOR LAND VEHICLES; GEARS FOR LAND VEHICLES; GEARS FOR BICYCLES; MOTORIZED GOLF CARTS; MOBILE STORAGE CART FOR DOMESTIC AND COMMERCIAL USE; HANDCARTS; HEAD RESTS FOR SEATS FOR LAND VEHICLES; HOODS FOR LAND VEHICLES; HORNS FOR VEHICLES; HOSE CARTS; HUB CAPS; HUBS FOR VEHICLE WHEELS; HYDRAULIC CIRCUITS FOR LAND VEHICLES; HYDROPLANES; INNER TUBES FOR VEHICLE TIRES; INNER TUBES FOR PNEUMATIC TIRES; JET KICK SLEDS; LADLE RAILWAY CARRIAGES; LAUNCHES; LOCOMOTIVES; LIGHT LORRIES; LUGGAGE CARRIERS FOR VEHICLES; LUGGAGE NETS FOR LAND VEHICLES; LUGGAGE TROLLEYS; MINE CAR WHEELS; MOPEDS; MOTOR BUSES; MOTOR CARS; MOTOR HOMES; MOTORCYCLES; MOTORS FOR BICYCLES; ELECTRIC MOTORS FOR LAND VEHICLES; MUDGUARDS; ANTI-SKID CHAINS FOR VEHICLES; OARS; PADDLES FOR CANOES; PANNIERS BAGS FOR BICYCLES; PARACHUTES; PNEUMATIC TIRES FOR LAND VEHICLES; PONTOONS FOR BOATS; PORTHOLES; RAILWAY COUPLINGS; REARVIEW MIRRORS; REDUCTION GEARS FOR LAND VEHICLES; REFRIGERATED LAND VEHICLES; REFRIGERATED RAILWAY CARS; REVERSING ALARMS FOR VEHICLES; RIMS FOR VEHICLE WHEELS; RIMS FOR WHEELS OF BICYCLES; ROLLING STOCK FOR FUNICULAR RAILWAYS; ROLLING STOCK FOR RAILWAYS; ROWLOCKS; RUDDERS; DOLLIES; SADDLE COVERS FOR BICYCLES AND MOTORCYCLES; SAFETY BELTS FOR VEHICLES FOR MOTOR CARS; SAFETY SEATS FOR INFANTS AND CHILDREN FOR VEHICLES; SCREW PROPELLERS FOR BOATS; SCREW-PROPELLERS; SCULLS; SEAPLANES; SEAT COVERS FOR VEHICLES; SEAT SAFETY HARNESSSES FOR MOTOR CARS; SHIPS' HULLS; SHIPS' STEERING GEARS; SHIPS; SHOCK ABSORBERS FOR AUTOMOBILES; SHOCK ABSORBING SPRINGS FOR LAND VEHICLES; SHOPPING TROLLEYS; MOTORCYCLE SIDECARS; SKI RACKS FOR VEHICLES; SKI LIFTS; SLEEPING BERTHS FOR LAND VEHICLES; SLEEPING RAILWAY CARS; SLEIGHS; SNOWMOBILES; SPACE VEHICLES; SPARS FOR SHIPS; SPIKES FOR TIRES; SPOKE CLIPS FOR BICYCLE WHEELS; SPOKES FOR BICYCLE WHEELS; SPORTS CARS; STANDS FOR BICYCLES; STEAM STEERING GEARS FOR VESSELS; VEHICLE PARTS, NAMELY, STEERING WHEELS; STERN OARS; BABY STROLLERS; STUDS FOR TIRES; SUN-BLINDS ADAPTED FOR AUTOMOBILES; VEHICLE PARTS, NAMELY, SHOCK ABSORBERS; TIMBER FRAMES FOR SHIPS; TIRES FOR BICYCLES; TIRES FOR VEHICLE WHEELS; SOLID TIRES FOR VEHICLES; TORQUE CONVERTERS FOR LAND VEHICLES; TORSION BARS FOR VEHICLES; TRACTOR ENGINES; TRACTORS; TRAILER HITCHES FOR VEHICLES; TRAILERS; TRAMCARS; TRANSMISSION CHAINS FOR LAND VEHICLES; TRANSMISSION SHAFTS FOR LAND VEHICLES; TRANSMISSIONS FOR LAND VEHICLES; TREAD USED TO RETREAD TIRES; TREADS FOR VEHICLES, NAMELY, TRACTOR TREADS; TRICYCLES; TROLLEYS; TRUCKS; TUBELESS TIRES FOR BICYCLES; AIR TURBINES FOR LAND VEHICLES; TURN SIGNALS FOR VEHICLES; UNDERCARRIAGES FOR LAND VEHICLES; UPHOLSTERY FOR VEHICLES; VALVES FOR VEHICLE TIRES; VANS; LAND VEHICLE BUMPER; LAND VEHICLE CHASSIS; FITTED VEHICLE COVERS; LAND VEHICLE PARTS, NAMELY, RUNNING BOARDS; VEHICLE SEATS; LAND VEHICLE SUSPENSION SPRINGS; LAND VEHICLE WHEEL HUBS; LAND VEHICLE WHEEL RIMS; LAND VEHICLES; WAGONS; WHEELBARROWS; WHEELCHAIRS; WINDOWS FOR VEHICLES; WINDSCREEN WIPERS; AUTOMOBILE WINDSHIELDS; WINDSHIELD WIPERS; YACHTS (U.S. CLS. 19, 21, 23, 31, 35 AND 44).

CLASS 17—RUBBER GOODS

FOR ADHESIVE BANDS OTHER THAN FOR STATIONERY AND NOT FOR MEDICAL OR HOUSEHOLD PURPOSES; ADHESIVE TAPE FOR INDUSTRIAL AND COMMERCIAL USE; ASBESTOS FABRICS FOR USE AS CABLE INSULATION; ASBESTOS FELT; ASBESTOS PAPER; ASBESTOS FIRE CURTAINS; ASBESTOS SLATE; RUBBER BAGS FOR PACKAGING; BALATA; BANDS OF RUBBER FOR UNSCREWING JAR LIDS; ACOUSTICAL INSULATION FOR BUILDINGS COMPRISED OF BARK COVERINGS; INSULATION FOR BOILERS; PARTLY-PROCESSED FRICTION MATERIALS FOR BRAKE LININGS; CARBON FIBERS NOT FOR TEXTILE USE; CAULKING; CLUTCH LININGS; FLEXIBLE COMPRESSED AIR PIPE FITTINGS, NOT OF METAL; CONNECTING HOSE FOR VEHICLE RADIATORS; CORDS OF RUBBER; INSULATING AND PROTECTIVE INTER-LAYER DIELECTRIC MATERIALS AND COATINGS FOR USE IN INTEGRATED CIRCUITS, SEMICONDUCTOR DEVICES, COMPUTER DISK DRIVES AND OTHER COMPUTER HARDWARE; EBONITE; ELASTIC THREADS NOT FOR TEXTILE USE; ELASTIC YARNS NOT FOR TEXTILE USE; EXPANSION JOINT FILLERS FOR PAVEMENT; FIBERGLASS FABRICS FOR BUILDING INSULATION; FIBERGLASS FOR BUILDING INSULATION; SEMI-PROCESSED FILMS OF PLASTIC USED AS FILTERING MATERIALS; FIRE HOSES; FLEXIBLE PIPES, NOT OF METAL; FLOATING ANTI-POLLUTION BARRIERS; FOAM SUPPORTS FOR FLOWER ARRANGEMENTS; CELLULOSE FOIL OTHER THAN FOR PACKING; FOILS OF METAL FOR BUILDING INSULATION; GLASS FIBERS FOR USE IN INSULATION FOR BUILDING AND WATER HEATERS; GLASS WOOL FOR BUILDING INSULATION; GUM, RAW OR PARTLY PROCESSED; GUTTAPERCHA; HORSESHOES, NOT OF METAL; TEXTILE HOSES; INSULATING GLOVES; INSULATING OIL FOR TRANSFORMERS; INSULATING PAINTS; INSULATING PLASTER; ELECTRICAL INSULATING TAPE; INSULATING VARNISH; INSULATORS FOR ELECTRICAL CABLES; INSULATORS FOR ELECTRIC MAINS; INSULATORS FOR RAILWAY TRACKS; JOINT PACKINGS FOR PIPES; LATEX FOR INDUSTRIAL USE; METAL FOIL FOR BUILDING INSULATION; MICA, RAW OR PARTLY PROCESSED; MINERAL WOOL FOR USE AS A BUILDING INSULATOR; PACKING PADDING OF RUBBER OR PLASTICS FOR SHIPPING CONTAINERS; PAPER FOR ELECTRICAL CAPACITORS; PIPE GASKETS; PLASTIC SHEETING FOR AGRICULTURAL PURPOSES; SEMI-PROCESSED PLASTIC IN THE FORM OF FILMS, SHEETS, TUBES, BARS, OR RODS; PLASTICS IN EXTRUDED FORM USED IN PRODUCTION; INSULATED PIPE SUPPORTS; RINGS OF RUBBER FOR USE AS PIPE CONNECTION SEALS; RUBBER SLEEVES FOR PROTECTING PARTS OF MACHINES; RUBBER STOPPERS; RUBBER; MICA; FIRE CURTAINS OF ASBESTOS; PIPE JOINT SEALANT; SELF-ADHESIVE TAPES FOR INDUSTRIAL AND COMMERCIAL USE; SHOCK ABSORBING RUBBER BUFFERS FOR INDUSTRIAL MACHINERY; SLAG WOOL FOR USE AS A BUILDING INSULATOR; SOLDERING THREADS OF PLASTIC; SOUNDPROOFING MATERIALS FOR BUILDINGS; DOOR STOPS OF RUBBER; STUFFING OF RUBBER AND PLASTIC; STUFFING RINGS OF RUBBER AND PLASTIC; POLYURETHANE FILM FOR USE AS A MOISTURE BARRIER; SYNTHETIC RESINS IN EXTRUDED FORM FOR GENERAL INDUSTRIAL USE; SYNTHETIC RUBBER; THREADS OF RUBBER NOT FOR USE IN TEXTILES; VALVES OF RUBBER OR VULCANIZED FIBER; VULCANIZED FIBER; WASHERS OF RUBBER OR VULCANIZED FIBER; WATERTIGHT RINGS FOR PLUMBING PIPES; WATERING HOSES; PIPE MUFFS, NOT OF METAL, FOR USE WITH PLUMBING PIPES, HEATING PIPES, COOLING PIPES, INDUSTRY PIPES, WATER PIPES, GAS PIPES, FIRE PROTECTION PIPES, SPRINKLER PIPES; SEALS FOR PLUMBING PIPE CONNECTIONS, HEATING PIPE CONNECTIONS, COOLING PIPE CONNECTIONS, INDUSTRY PIPE CONNECTIONS, WATER PIPE CONNECTIONS, GAS PIPE CONNECTIONS, FIRE PROTECTION PIPE CONNECTIONS, SPRINKLER PIPE CONNECTIONS, PIPE JACKETS, NOT OF METAL, FOR USE WITH PLUMBING PIPES, HEATING PIPES, COOLING PIPES, INDUSTRY PIPES, WATER PIPES, GAS PIPES, FIRE PROTECTION PIPES, SPRINKLER PIPES (U.S. CLS. 1, 5, 12, 13, 35 AND 50).

CLASS 19—NON-METALLIC BUILDING MATERIALS

FOR ADVERTISEMENT COLUMNS NOT OF METAL; AGGLOMERATED BAGASSES OF CANE FOR USE AS BUILDING MATERIAL; ALABASTER GLASS; ALABASTER; NON-METAL ANGLE IRONS; AQUARIUM GRAVEL; AQUARIUM SAND; ARBORS AND TRELLISES MADE OF WOOD; ARTIFICIAL STONE; ASBESTOS CEMENT; ASBESTOS MORTAR; ASPHALT PAVING; ASPHALT; PITCH; BITUMEN ASPHALT; AVIARIES NOT OF METAL; BALUSTRADES; NON-METAL NON-LUMINOUS BEACONS; BEAMS, NOT OF METAL; NON-METAL BICYCLE STORAGE RACKS; NON-METAL BIRD BATHS; BITUMINOUS COATINGS FOR ROOFING; NON-METAL EXTERIOR BLINDS; NON-METAL BRANCHING PIPES; BRICKS; NON-METAL BUILDING PANELS; ASPHALT ROOFING PAPER; BUILDING STONE; CONSTRUCTION TIMBER; NON-METALLIC TRANSPORTABLE BUILDINGS; BUSTS OF STONE, CONCRETE, AND MARBLE; CAISSONS FOR CONSTRUCTION WORK UNDER WATER; LIMESTONE; NON-METAL WINDOW CASEMENTS; CASK WOOD; NON-METAL CEILING PANELS; CEMENT FOR BLAST FURNACES; CEMENT FOR FURNACES; CEMENT POSTS; CEMENT SLABS; CEMENT MIXES; NON-METAL CHICKEN COOPS; NON-METAL CHIMNEY COWLS; NON-METAL CHIMNEY POTS; NON-METAL CHIMNEY SHAFTS; NON-METAL CHIMNEYS; NON-METAL CLADDING FOR CONSTRUCTION AND BUILDING; SLABS OF CLAY; COAL TAR; CONCRETE; FLOORING UNDERLAYMENT MADE OF CORK; NON-METAL CORNICES; NON-METAL ROOF COVERINGS FOR BUILDING; CRASH BARRIERS OF CONCRETE, WOOD, AND PLASTIC FOR ROADS; NON-METAL DIVING BOARDS; DOOR CASINGS, NOT OF METAL; DOOR FRAMES, NOT OF METAL; DOOR PANELS, NOT OF METAL; NON-METAL DOORS; DRAIN PIPES OF CONCRETE, EARTHENWARE, SANDSTONE, AND CERAMIC; NON-METAL, NON-PLASTIC DRAIN TRAPS; NON-METAL DUCTS FOR VENTILATING AND AIR-CONDITIONING INSTALLATIONS; EARTH FOR BRICKS; FAIR STANDS; ASPHALT FELT FOR BUILDING; NON-METAL FENCES; FIGURINES OF STONE, CONCRETE, AND MARBLE; FIRECLAY; NON-METAL BUILDING FLASHING; NON-METAL FLOATING DOCKS FOR MOORING BOATS; FLOOR BOARDS; NON-METAL FLOOR TILES; NON-METAL FLOORS; NON-METAL FOLDING DOORS; NON-METAL FOUNDRY MOLDS; NON-METAL FRAMEWORK FOR BUILDING; FURRING OF WOOD; NON-METAL GATES; GEOTEXTILES FOR USE IN CONNECTION WITH ROAD CONSTRUCTION, RAILROAD CONSTRUCTION, TUNNEL CONSTRUCTION, WATERWAY CONSTRUCTION AND PUBLIC WORKS CONSTRUCTION; NON-METAL GIRDERS; GLASS GRANULES FOR MARKING ROADS; GRANITE, STONE, CONCRETE, AND MARBLE GRAVE OR TOMB ENCLOSURES; GRAVEL; STONE, CONCRETE, AND MARBLE GRAVESTONE SLABS; NON-METAL GREENHOUSE FRAMES; TRANSPORTABLE NON-METAL GREENHOUSE FRAMES; GROUT; NON-METAL GUTTER PIPES; NON-METAL GUTTERS; GYPSUM; NON-METAL ROOFING HIPS; NON-METAL HUTS; INSECT SCREENS NOT OF METAL; NON-METAL JALOUSIES; NON-METAL JOISTS; NON-METAL LATHS; NON-METAL LATTICES; NON-METAL LENGTHENING PIECES FOR CHIMNEYS; LETTER BOXES OF MASONRY; CEMENT, CONCRETE, CLAY, AND SLATE LIGHTING SLABS; NON-AGRICULTURAL LIME FOR USE IN CONSTRUCTION; NON-METAL LINTELS; LUMBER; LUMINOUS PAVING BLOCKS, STONES, AND TILES; MACADAM FOR PAVEMENT, NAMELY, BITUMEN-BASED ASPHALT SEALANTS; MAGNESIA CEMENT; NON-METAL MANHOLE COVERS; NON-METAL MANTLEPIECES; TIMBER; MARBLE; ENGRAVED AND CUT STONE PLAQUES; NON-METAL DECORATIVE MOLDINGS AND DECORATIVE TRIM FOR USE IN BUILDING CONSTRUCTION; STONE, CONCRETE, AND MARBLE MONUMENTS; CONCRETE MOORING BOLLARDS; MORTAR FOR BUILDING; GLASS AND TILE MOSAICS FOR BUILDING; NON-METAL NON-LUMINOUS AND NON-MECHANICAL SIGNS; NON-METALLIC RIGID PIPES FOR BUILDING; BUILDINGS; OLIVINE FOR BUILDING; NON-METAL PAINT SPRAYING BOOTHS; NON-METAL PALINGS; NON-METAL PALISADES; NON-METAL PANTILE; PAPERBOARD FOR BUILDING; PARQUET WOOD FLOORING; PARQUET FLOORING OF CORK; PAVING BLOCKS; NON-METAL PAVING SLABS; NON-

METAL PENSTOCK PIPES; PRE-FABRICATED PIG-STIES; MARINE PRODUCTS, NAMELY, BUMPERS, OR PADS FOR PILINGS OR DOCK POSTS; PLANKS; PLASTER; PLATE GLASS FOR BUILDING; DIVING PLATFORMS NOT OF METAL; NON-METAL ROCKET LAUNCHING PLATFORMS PLYWOOD; NON-METAL POLES FOR ELECTRIC POWER LINES; PREFABRICATED NON-METAL PORCHES FOR BUILDINGS; NON-METAL POSTS FOR ELECTRIC POWER LINES; NON-METAL POSTS; POTTERS' CLAY; QUARTZ; NON-METAL RAILROAD TIES; RAW CHALK FOR BUILDING; REFRACTORY CONSTRUCTION MATERIALS, NOT OF METAL; REINFORCING MATERIALS NOT OF METAL FOR BUILDING PURPOSES; RIGID PIPES NOT OF METAL; ASPHALT-BASED COATINGS AND SEALANTS FOR USE ON PAVEMENTS; NON-METAL ROOF COVERINGS; NON-METAL ROOFING FLASHING; ROOFING SLATES; NON-METAL ROOFING; SAFETY GLASS FOR BUILDING PURPOSES; SAND; SANDSTONE FOR BUILDING; SANDSTONE TUBES; SAWN TIMBER; NON-METAL SCAFFOLDING; SCANTLINGS FOR BUILDING; NON-METAL SHEET PILES; SHINGLES; NON-METAL CONCRETE SHUTTERING; NON-METAL WINDOW SHUTTERS; NON-METAL, NON-LUMINOUS, AND NON-MECHANICAL SIGNALING PANELS; NON-METAL, NON-LUMINOUS, AND NON-MECHANICAL SIGNS FOR ROADS; SILICA STONE; NON-METAL WINDOW SILLS; PRE-FABRICATED SILOS; SLABS OF CEMENT, CONCRETE, CLAY, AND SLATE; SLAG STONE; SLATE; PRE-FABRICATED NON-METAL STABLES; STAINED-GLASS WINDOWS; STAIR TREADS NOT OF METAL; NON-METAL STAIRCASES; STATUES OF STONE, CONCRETE, AND MARBLE; STATUETTES OF STONE, CONCRETE, AND MARBLE; STAVE WOOD; STAIRCASE STRINGERS OF WOOD; NON-METAL SWIMMING POOLS; WATER TANKS OF MASONRY FOR HOUSEHOLD PURPOSES; TAR; TARRED FELTS AND ROOFING PAPER; NON-METAL TELEPHONE BOOTHS; NON-METAL TILES; NON-METAL TRELLISES; BURIAL VAULTS NOT OF METAL; WOOD VENEER; VINYL SIDING; NON-METAL WAINSCOTTING; SYNTHETIC FLOORING MATERIALS OR WALL-CLADDINGS; NON-METAL WALL TILES FOR BUILDING; NON-METAL WATER PIPES; NON-METAL WINDOW FRAMES; WINDOW GLASS; WOOD FOR MAKING HOUSEHOLD UTENSILS; WOOD PANELING; WOOD PAVING; WOOD PULP BOARD, FOR BUILDING; SEMI-WORKED WOOD; WORKED TIMBER; WORKS OF ART OF STONE, CONCRETE, AND MARBLE; NON-METALLIC BUILDING MATERIALS, NAMELY, WATER PIPES; NON-METALLIC CONSTRUCTION MATERIALS, NAMELY, WATER PIPES; NON-METALLIC RIGID PIPES, NAMELY, PLUMBING PIPES, HEATING PIPES, COOLING PIPES, INDUSTRY PIPES, WATER PIPES, GAS PIPES, FIRE PROTECTION PIPES, AND SPRINKLER PIPES; PIPES OF CONCRETE, EARTHENWARE, AND SANDSTONE (U.S. CLS. 1, 12, 33 AND 50).

CLASS 20—FURNITURE AND ARTICLES NOT OTHERWISE CLASSIFIED

FOR NON-MEDICAL AIR CUSHIONS; NON-MEDICAL AIR MATTRESSES; NON-MEDICAL AIR PILLOWS; AMBROID BARS; AMBROID PLATES; ANIMAL CLAWS; ANIMAL HOOVES; ANIMAL HORNS; ARMCHAIRS; BEEHIVES; BAKERS' BREAD BASKETS; BAMBOO CURTAINS; BARREL HOOPS, NOT OF METAL; WOOD BARRELS; BASSINETS; BEAD CURTAINS FOR DECORATION; NON-METAL CASTERS; BEDS FOR HOUSEHOLD PETS; BEDS; WOOD BEDSTEADS; BENCHES; BINDING SCREWS, NOT OF METAL, FOR CABLES; BINS OF WOOD OR PLASTIC; NON-METAL BINS; MOBILE BOARDING STAIRS, NOT OF METAL, FOR PASSENGERS; BABY BOLSTERS; NON-METAL BOLTS; BOOK RESTS; NON-METAL BOTTLE CAPS; BOTTLE CASINGS OF WOOD; BOTTLE CLOSURES, NOT OF METAL; WINE RACKS; BOXES OF WOOD OR PLASTIC; NON-METAL BROOM HANDLES; NON-METAL DOOR BRUSH MOUNTINGS; BUSTS OF WOOD, WAX, PLASTER, AND PLASTIC; CABINETS; CABLE AND PIPE CLIPS OF PLASTICS; FURNITURE CARTS FOR COMPUTERS; DISPLAY CASES OF WOOD AND PLASTIC; NON-METAL CASK STANDS; CASKS OF WOOD FOR DECANTING WINE; NON-METAL CASKS; CHAIRS; CHESTS FOR TOYS; CHESTS OF DRAWERS; NON-METAL CHESTS; WOOD CHOPPING BLOCK TABLES; NON-METAL AND NON-PAPER CLOSURES FOR CON-

TAINERS; NON-METAL CLOTHES HOOKS; COAT HANGERS; NON-METAL COAT HOOKS; COATSTANDS; COFFINS; COMB FOUNDATIONS FOR BEEHIVES; PLASTIC STORAGE CONTAINERS FOR COMMERCIAL OR INDUSTRIAL USE; CONTAINERS FOR INDUSTRIAL AND COMMERCIAL LIQUIDS NOT MADE OF METAL; CORAL; CORKS FOR BOTTLES; CORKS; COSTUME DISPLAY STANDS; COTS; CRADLES; PLASTIC AND WOOD CRATES; CUPBOARDS; SHOWER CURTAIN RODS; CURTAIN HOOKS; CURTAIN RAILS; CURTAIN RINGS; CURTAIN RODS; CURTAIN ROLLERS; CURTAIN TIE-BACKS; CUSHIONS; DECK CHAIRS; DECORATIVE WALL PLAQUES OF BONE, IVORY, PLASTIC, WAX, AND WOOD; DESKS; DINNER WAGONS; DISPLAY BOARDS; METAL DISPLAY STANDS; DIVANS; DOG KENNELS; DOORS FOR FURNITURE; DOWELS, NOT OF METAL; DRAFTING TABLES; DRESSING TABLES; DRESSMAKERS' DUMMIES; DRINKING STRAWS; DUCKBOARDS, NOT OF METAL; EASY CHAIRS; EDGINGS OF PLASTIC FOR FURNITURE; EMBROIDERY FRAMES; FANS FOR PERSONAL USE; FIGURINES OF WOOD, WAX, PLASTER OR PLASTIC; FILING CABINETS; FIRE SCREENS FOR DOMESTIC USE; FLAGPOLES; NON-METAL FLOATING CONTAINERS FOR COMMERCIAL USE; FLOWER-POT PEDESTALS; FLOWER STANDS; FODDER STORAGE RACKS; FOOTSTOOLS; FOUNDATIONS FOR BEEHIVES; FUNERARY URNS; NON-METAL FURNITURE CASTERS; FURNITURE OF METAL; FURNITURE PARTITIONS OF WOOD; FURNITURE SHELVES; FURNITURE; MIRRORS; PICTURE FRAMES; WALL-MOUNTED GUN RACKS; HAIRDRESSERS' CHAIRS; HAMPERS; NON-METAL HANDLING PALLETS; HAT RACKS; FURNITURE HEAD RESTS; HIGH CHAIRS FOR BABIES; NON-METAL HINGES; UNWORKED OR SEMI-WORKED ANIMAL HORN; HOSPITAL BEDS; HOUSE NUMBERS, NOT OF METAL, NON-LUMINOUS; WATER BEDS NOT FOR MEDICAL PURPOSES; NON-METAL IDENTIFICATION BRACELETS FOR HOSPITAL USE; PLASTIC NOVELTY LICENSE PLATES; INDOOR WINDOW BLINDS; INFANT WALKERS; INFLATABLE PUBLICITY OBJECTS; UNWORKED OR SEMI-WORKED IVORY; KENNELS FOR HOUSEHOLD PETS; COMPUTER KEYBOARD TRAYS; NON-METAL KNIFE HANDLES; LADDERS OF WOOD OR PLASTICS; NON-METAL LATCHES; LECTERNS; LETTER BOXES, NOT OF METAL OR MASONRY; LIBRARY SHELVES; NON-METAL LOADING GAUGE RODS FOR RAILWAY WAGONS; NON-METAL LOADING PALLETS; LOCKERS; NON-METAL LOCKS; NON-METAL LOCKS FOR VEHICLES; MAGAZINE RACKS; MANNEQUINS; MASSAGE TABLES; REMOVABLE MATS FOR SINKS; MATTRESSES; MEDICINE CABINETS; MEERSCHAUM; MIRROR TILES; DECORATIVE MOBILES; MOLDINGS FOR PICTURE FRAMES; MOORING BUOYS NOT OF METAL; RAW MOTHER-OF-PEARL; NON-METAL NAMEPLATES; NON-METAL NESTING BOXES; NEWSPAPER DISPLAY STANDS; BICYCLE RACING NUMBER PLATES; NON-METAL NUTS; OFFICE FURNITURE; DECORATIVE OYSTER SHELLS; CONSUMER PACKAGING CONTAINERS OF PLASTIC; PARTITIONS OF WOOD FOR FURNITURE; NON-METAL PEGS; PET CUSHIONS; NON-METAL FASTENING ANCHORS; PILLOWS; PIPE AND CABLE CLIPS OF PLASTICS; PLACARDS OF WOOD OR PLASTICS; UNENCODED PLASTIC KEY CARDS; PLATE RACKS; PLAYPENS FOR BABIES; NON-METAL POLES; PULLEYS OF PLASTICS FOR BLINDS; STORAGE RACKS; RATTAN; REEDS; REELS OF WOOD FOR YARN, SILK, CORD; NON-METAL NON-MECHANICAL REELS FOR FLEXIBLE HOSES; NON-METAL FASTENERS, NAMELY, RIVETS; SAW HORSES; SCHOOL FURNITURE; SCRATCHING POSTS FOR CATS; SCREENS; NON-METAL SCREWS; NON-METAL SCYTHE HANDLES; NON-METALLIC SEALING CAPS; SEATS OF METAL; SEATS; SETTEES; SEA SHELLS; SHELVES FOR FILING-CABINETS; SHELVES FOR STORAGE; SHELVES FOR TYPEWRITERS; SHOULDER POLES; SIDEBARDS; SIGNBOARDS OF WOOD AND PLASTICS; SLATTED INDOOR WINDOW BLINDS; SLEEPING BAGS FOR CAMPING; SOFAS; SPRING MATTRESSES; STAG ANTLERS; NON-METAL STAIR RODS; NON-METAL STAKES FOR PLANTS OR TREES; FURNITURE STANDS FOR CALCULATING MACHINES; STATUES OF WOOD, WAX, PLASTER, AND PLASTIC; STATUETTES OF WOOD, WAX, PLASTER, AND PLASTIC; WOODEN POLES; NON-METAL LADDERS; STOOLS; NON-METALLIC BOTTLE STOPPERS; STRAW EDGING FOR FURNITURE; STRAW MATTRESSES; STRAWS

FOR DRINKING; STUFFED ANIMALS; STUFFED BIRDS; TABLE TOPS; TABLES OF METAL; TABLES; TAILOR'S DUMMIES; NON-METAL FLUID STORAGE TANKS; NON-METAL TAPS FOR KEGS; TEA CARTS; NON-METAL TENT PEGS; NON-METAL TOOL HANDLES; TORTOISESHELL IMITATION; TORTOISESHELL; FIXED NONMETALLIC TOWEL DISPENSERS; NON-METAL TRANSPORT PALLETS; TRAYS, NOT OF METAL; NON-METAL TRESTLES FOR SUPPORTING TABLES; NON-METAL TROUGHS FOR MIXING MORTAR; TYPING DESKS; UMBRELLA STANDS; VALVES OF PLASTIC BEING OTHER THAN MACHINE PARTS; VATS, NOT OF METAL; VICE BENCHES NOT OF METAL; WAX FIGURES; UNWORKED OR SEMI-WORKED WHALEBONES; WICKER FURNITURE; WORK BENCHES; WORKS OF ART OF WOOD, WAX, PLASTER, AND PLASTIC; WOVEN TIMBER BLINDS; WRITING DESKS (U.S. CLS. 2, 13, 22, 25, 32 AND 50).

CLASS 24—FABRICS

FOR ADHESIVE FABRIC FOR APPLICATION BY HEAT; CLOTH BANNERS; BATH LINEN; BED BLANKETS; BED SHEETS OF PAPER; BED LINEN; BED SPREADS; BILLIARD CLOTH; BOLTING CLOTH; BROCADES; BUCKRAM; CLOTH BUNTING; CALICO; CANVAS FOR TAPESTRY OR EMBROIDERY; CHEESE CLOTH; CHENILLE FABRIC; CHEVIOT FABRIC; CLOTH COASTERS; COTTON FABRICS; COVERINGS OF PLASTIC FOR FURNITURE; COVERLETS; UNFITTED FABRIC FURNITURE COVERS; COVERS FOR CUSHIONS; CREPE CLOTH; CURTAIN LOOPS OF TEXTILE MATERIAL; CURTAINS OF TEXTILE OR PLASTIC; DAMASK; DIAPERED LINEN; DIMITY; DOOR CURTAINS; WOOL DRUGGET; EIDERDOWNS; ELASTIC FABRICS FOR CLOTHING; ESPARTO FABRIC; FABRIC FOR BOOTS AND SHOES; FABRIC OF IMITATION ANIMAL SKINS; FABRIC, IMPERVIOUS TO GASES, FOR AERONAUTICAL BALLOONS; FACE TOWELS OF TEXTILE; FELT; FIBERGLASS FABRIC FOR TEXTILE USE; FITTED TOILET LID COVERS; CLOTH, FABRIC, AND NYLON FLAGS; FLANNEL; FRIEZE; FUSTIAN; GAUZE FABRIC; KITCHEN TOWELS; GUMMED WATERPROOF CLOTH; HANDKERCHIEFS OF TEXTILE; TEXTILE HAT LININGS IN THE PIECE; HEMP CLOTH; HOUSEHOLD LINEN; JERSEY MATERIAL; JUTE FABRIC; KNITTED FABRIC; CLOTH LABELS; LINEN CLOTH; TEXTILE FABRICS FOR LINGERIE; TEXTILE USED AS LINING FOR CLOTHING; MARABOU FABRIC; TEXTILE NAPKINS FOR REMOVING MAKE-UP; PLACE MATS NOT OF PAPER; PRINTED CALICO CLOTH; SANITARY FLANNEL; TABLE CLOTHS NOT OF PAPER; TABLE LINEN; TABLE MATS NOT OF PAPER; TABLE LINEN, NAMELY, NAPKINS; FABRIC TABLE RUNNERS; TAFFETA; TAPESTRIES OF TEXTILE; TICKING FABRIC; TEXTILE TISSUES FOR REMOVING MAKE-UP; TOWELS OF TEXTILE; TRACED CLOTHS FOR EMBROIDERY; LAP ROBES; TULLE; UPHOLSTERY FABRICS; VELVET; WALL HANGINGS OF TEXTILE; WASHING MITTS; WOOLEN CLOTH; WOOLEN FABRIC; ZEPHYR FABRIC (U.S. CLS. 42 AND 50).

CLASS 25—CLOTHING

FOR ANTI-SWEAT UNDERCLOTHES; ANTI-SWEAT UNDERWEAR; CLOTH BABY DIAPERS; CLOTH BABY BIBS; BATHROBES; BATHING SUITS; BATHING TRUNKS; BOAS; BODICES; BOOT UPPERS; BOOTS FOR SPORTS; BOOTS; BRASSIERES; BREECHES; CAMISOLES; CAPS; CHASUBLES; CHEMISETTES; FOOTWEAR; HEADWEAR; COATS; COLLAR PROTECTORS; COLLARS; COMBINATIONS; CORSELETS; CORSETS; CUFFS; REMOVABLE COLLARS; DRESS SHIELDS; DRESSING GOWNS; EAR MUFFS; SHOES AND SANDALS MADE FROM ESPARTO FABRIC; FISHING VESTS; CLEATS FOR ATTACHMENT TO SPORTS SHOES; RUGBY SHOES; FOOTBALL SHOES; SLIPPERS; FOOTWEAR UPPERS; FROCKS; FUR STOLEES; FUR COATS AND JACKETS; SMOCKS; GAITER STRAPS; GAITERS; GALOSHES; GARTERS; GIRDLES; GLOVES; GYMNASIIC SHOES; HALF-BOOTS; HAT FRAMES; HATS; HEADBANDS; HEEL PIECES FOR STOCKINGS; HEELPIECES FOR BOOTS AND SHOES; HEELS; HOODS; HOSIERY; INNER SOLES; JACKETS; JERSEYS; JUMPERS; LACE BOOTS; LAYETTES; LEGGINGS; LIVERIES; MANIPLES; MANTILLAS; MASQUERADE

COSTUMES; MITERS HATS; MITTENS; MONEY BELTS; MUFFS; NECKTIES; NON-SLIP SOLES FOR BOOTS AND SHOES; OVERALLS; OVERCOATS; PAJAMAS; PANTS; PARKAS; PELERINES; PELISSES; PETTICOATS; POKKET SQUARES; POCKETS FOR CLOTHING; PULLOVERS; FINISHED TEXTILE LININGS FOR GARMENTS; SANDALS; SARIS; SASHES; SCARVES; SHAWLS; SHIRT FRONTS; SHIRT YOKES; SHIRTS; SHOES; SHOULDER WRAPS; SHOWER CAPS; SINGLETS; SKI BOOTS; SKIRTS; SKULL CAPS; SLIPS; SOCK SUSPENDERS; SOCKS; SOLES FOR FOOTWEAR; SPATS; SPORTS JERSEYS; SPORTS SHOES; STOCKINGS; STUFF JACKETS; SUITS; SUN VISORS; SUSPENDERS; SWEAT-ABSORBENT SOCKS; SWEAT-ABSORBENT UNDERWEAR; SWEATERS; SWIMSUITS; TEDDIES; T-SHIRTS; TIGHTS; TIPS FOR FOOTWEAR; TOGAS; TOP COATS; TOP HATS; TROUSERS; TROUSER STRAPS; TURBANS; UNDERPANTS; UNDERWEAR; UNIFORMS; VEILS; VESTS; VISORS; WAISTCOATS; WELTS FOR BOOTS AND SHOES; WET SUITS FOR WATER-SKIING; WIMPLES; WOODEN SHOES; WRISTBANDS (U.S. CLS. 22 AND 39).

CLASS 35—ADVERTISING AND BUSINESS

FOR ACCOUNTING SERVICES; ADVERTISING AGENCIES; DIRECT MAIL ADVERTISING; ADVERTISING SERVICES; ADVISORY SERVICES FOR BUSINESS MANAGEMENT; ARRANGING NEWSPAPER SUBSCRIPTIONS OF OTHERS; AUCTIONEERING; BUSINESS AUDITING; DISSEMINATION OF ADVERTISING MATTER OF OTHERS, NAMELY, HANGING POSTERS; BOOKKEEPING; BUSINESS ADMINISTRATION AND MANAGEMENT; BUSINESS APPRAISALS; BUSINESS ADVICE AND INFORMATION; BUSINESS CONSULTING, INQUIRIES OR INFORMATION; BUSINESS INVESTIGATIONS; BUSINESS MANAGEMENT AND ORGANIZATION CONSULTANCY; BUSINESS MANAGEMENT CONSULTATION; BUSINESS MANAGEMENT OF HOTELS FOR OTHERS; MANAGEMENT OF PERFORMING ARTISTS; BUSINESS MANAGEMENT; BUSINESS ORGANIZATION CONSULTANCY; BUSINESS RESEARCH; COMMERCIAL INFORMATION AGENCIES; COMMERCIAL AND INDUSTRIAL MANAGEMENT ASSISTANCE; COMPILATION OF INFORMATION INTO COMPUTER DATABASES; COMPUTERIZED FILE MANAGEMENT; COST/PRICE ANALYSIS; DATA SEARCH OF COMPUTER FILES FOR OTHERS; DEMONSTRATION OF PRODUCTS; DISSEMINATION OF ADVERTISING MATTER; DISTRIBUTION OF SAMPLES; DOCUMENT REPRODUCTION; FINANCIAL STATEMENT PREPARATION AND ANALYSIS FOR BUSINESSES; ECONOMIC FORECASTING; EFFICIENCY EXPERTS; EMPLOYMENT AGENCIES; EVALUATION OF STANDING TIMBER; EVALUATION OF WOOL; IMPORT AND EXPORT AGENCIES; TRACKING, LOCATING, AND MONITORING OF RAILROAD VEHICLES SERVICES FOR COMMERCIAL PURPOSES; MARKET RESEARCH; MARKET STUDIES; MODELING FOR ADVERTISING OR SALES PROMOTION; NEWS CLIPPING SERVICES; PROVIDING OFFICE FUNCTIONS; RENTAL OF OFFICE MACHINERY AND EQUIPMENT; ON-LINE ADVERTISING ON A COMPUTER COMMUNICATIONS NETWORK; PUBLIC OPINION POLLING; ARRANGING AND CONDUCTING OF FAIRS AND EXHIBITIONS FOR BUSINESS AND ADVERTISING PURPOSES; PLANNING AND CONDUCTING OF TRADE FAIRS, EXHIBITIONS AND PRESENTATIONS FOR ECONOMIC OR ADVERTISING PURPOSES; PAYROLL PREPARATION; PERSONNEL MANAGEMENT CONSULTATION; PERSONNEL RECRUITMENT; PHOTOCOPYING; PROFESSIONAL BUSINESS CONSULTATION; PSYCHOLOGICAL TESTING FOR THE SELECTION OF PERSONNEL; PUBLIC RELATIONS; PUBLICATION OF PUBLICITY TEXTS; PUBLICITY AGENCIES; PUBLICITY COLUMN'S PREPARATION; RENTAL OF PUBLICITY MATERIAL FOR ADVERTISING PURPOSES; ADVERTISING SERVICES OF A RADIO AND TELEVISION ADVERTISING AGENCY; BUSINESS RELOCATION SERVICES; RENTAL OF ADVERTISING SPACE; RENTAL OF PHOTOCOPYING MACHINES; RENTAL OF VENDING MACHINES; SALES PROMOTION SERVICES FOR OTHERS; SECRETARIAL SERVICES; WINDOW DRESSING AND DISPLAY ARRANGEMENT SERVICES; SHORTHAND SECRETARIAL SERVICES; PROVIDING STATISTICAL INFORMATION; SYSTEMIZATION OF INFORMATION INTO COMPUTER DATABASES; TAX PREPARATION; TELEPHONE ANSWERING SERVICE;

STENOGRAPHIC TRANSCRIPTION; TYPING; CREATING AND UPDATING ADVERTISING MATERIAL; VALUATION OF STANDING TIMBER; WORD PROCESSING (U.S. CLS. 100, 101 AND 102).

CLASS 37—CONSTRUCTION AND REPAIR

FOR AIR CONDITIONING APPARATUS INSTALLATION AND REPAIR; AIRCRAFT MAINTENANCE AND REPAIR; ANTI-RUST TREATMENT OF VEHICLES; ARTIFICIAL SNOW-MAKING SERVICES; ASPHALTING; BOILER CLEANING AND REPAIR; BRICKLAYING; BUILDING CONSTRUCTION SUPERVISION; BUILDING CONSTRUCTION SERVICES; INSTALLATION OF BUILDING INSULATION; BUILDING OF FAIR STALLS AND SHOPS; BUILDING SEALING SERVICES; BURGALAR ALARM INSTALLATION AND REPAIR; BURNER MAINTENANCE AND REPAIR; CABINET REPAIR; VEHICLE WASHING; CHIMNEY SWEEPING; CLEANING OF BUILDING EXTERIOR SURFACES; CLEANING OF BUILDING INTERIORS; CLEANING OF CLOTHING; CLOCK AND WATCH REPAIR; CLOTHING REPAIR; PROVIDING CONSTRUCTION INFORMATION; BUILDING DAMP-PROOFING; DEMOLITION OF BUILDINGS; DIAPER CLEANING; DISINFECTING; DRILLING OF OIL WELLS; DRY CLEANING; ELECTRIC APPLIANCE INSTALLATION AND REPAIR; ELEVATOR INSTALLATION AND REPAIR; FACTORY BUILDING CONSTRUCTION; REPAIR OR MAINTENANCE OF MOVIE PROJECTORS; FIRE ALARM INSTALLATION AND REPAIR; INSTALLATION AND REPAIR OF FREEZING APPARATUS; FULLING OF CLOTH; FUR CLEANING, CARE, AND REPAIR; FURNACE INSTALLATION AND REPAIR; FURNITURE RESTORATION, REPAIR AND MAINTENANCE; HARBOR CONSTRUCTION; INSTALLATION, REPAIR, AND MAINTENANCE OF HEATING EQUIPMENT; INSTALLATION, MAINTENANCE, AND REPAIR OF COMPUTER HARDWARE; INTERFERENCE SUPPRESSION IN ELECTRICAL APPARATUS; INSTALLATION AND MAINTENANCE OF IRRIGATION SYSTEMS; INSTALLATION OF KITCHEN APPLIANCES; KNIFE SHARPENING; LAUNDERING; LEATHER CLEANING AND REPAIR; LINEN IRONING; MASONRY; MENDING OF CLOTHING; MINING EXTRACTION; MOTOR VEHICLE MAINTENANCE AND REPAIR; INSTALLATION AND REPAIR OF BUSINESS AND OFFICE MACHINERY AND EQUIPMENT; PAINTING AND REPAIR OF SIGNS; INTERIOR AND EXTERIOR PAINTING; PAPER HANGING; UMBRELLA REPAIR; PHOTOGRAPHIC APPARATUS REPAIR; PIER BREAKWATER CONSTRUCTION; PIPELINE CONSTRUCTION AND MAINTENANCE; PLASTERING; PLUMBING SERVICES; PRESSING OF CLOTHING; PUMICING; PUMP REPAIR; QUARRY SERVICES; RAT EXTERMINATING; RE-TINNING; REBUILDING AUTOMOBILE ENGINES THAT HAVE BEEN WORN OR PARTIALLY DESTROYED; REBUILDING MACHINES THAT HAVE BEEN WORN OR PARTIALLY DESTROYED; RENOVATION OF CLOTHING; RENTAL OF BULLDOZERS; RENTAL OF CLEANING MACHINES; RENTAL OF CONSTRUCTION EQUIPMENT; RENTAL OF CONSTRUCTION EQUIPMENT, NAMELY, CRANES; RENTAL OF EXCAVATORS; RENTAL OF STREET CLEANING MACHINES; REPAIR OF SECURITY LOCKS; RETREADING OF TIRES; RIVETING; ROAD PAVING; ROOFING SERVICES; RUSTPROOFING; SAFE MAINTENANCE AND REPAIR; FLOOR SANDING; SCAFFOLDING ERECTION; CUSTOM SHIP-BUILDING; SHOE REPAIR; STREET CLEANING; STRONG ROOM MAINTENANCE AND REPAIR; TELEPHONE INSTALLATION AND REPAIR; UNDERWATER CONSTRUCTION; UNDERWATER REPAIR; UPHOLSTERING; UPHOLSTERY REPAIR; FURNITURE VARNISHING; VEHICLE CLEANING; VEHICLE GREASING; VEHICLE LUBRICATION; VEHICLE MAINTENANCE; VEHICLE POLISHING; VEHICLE REPAIR; VEHICLE SERVICE STATIONS; VERMIN EXTERMINATION OTHER THAN FOR AGRICULTURE; VULCANIZATION OF AUTOMOBILE TIRES; WAREHOUSE CONSTRUCTION AND REPAIR; WASHING OF LINEN; WINDOW CLEANING (U.S. CLS. 100, 103 AND 106).

CLASS 41—EDUCATION AND ENTERTAINMENT

FOR AMUSEMENT PARKS; PROVIDING AMUSEMENT FACILITIES; ANIMAL TRAINING; ARRANGING AND CONDUCTING OF EDUCATIONAL CONFERENCES; ARRANGING AND CONDUCTING OF SEMINARS; ARRANGING AND CONDUCTING OF PROFESSIONAL WORKSHOPS AND TRAINING; ENTERTAINMENT IN THE NATURE OF BEAUTY PAGEANTS; BOARDING SCHOOLS; BOOKING OF SEATS FOR SHOWS; BOOKMOBILE SERVICES; ENTERTAINMENT IN THE NATURE OF CIRCUSES; CORRESPONDENCE SCHOOLS; DIGITAL IMAGING SERVICES; DISCOTHEQUES; DUBBING SERVICES; INFORMATION ABOUT EDUCATION; EDUCATIONAL EXAMINATION SERVICES; DESKTOP PUBLISHING FOR OTHERS; ENTERTAINMENT SERVICES, NAMELY, LIVE, TELEVISED, AND MOVIE APPEARANCES BY A PROFESSIONAL ENTERTAINER; PROVIDING INFORMATION IN THE FIELD OF ENTERTAINMENT; MOTION PICTURE FILM PRODUCTION; ENTERTAINMENT SERVICES, NAMELY, PROVIDING ON-LINE COMPUTER GAMES; CONDUCTING AND PROVIDING FACILITIES FOR SPECIAL EVENTS FEATURING CASINO AND GAMING CONTESTS AND TOURNAMENTS; EDUCATION SERVICES, NAMELY, PROVIDING CLASSES IN THE FIELDS OF GYMNASTICS; HEALTH CLUB SERVICES, NAMELY, PROVIDING INSTRUCTION AND EQUIPMENT IN THE FIELD OF PHYSICAL EXERCISE; SUMMER CAMPS; LENDING LIBRARIES; MICROFILMING FOR OTHERS; MOBILE LIBRARY SERVICES; MODELING FOR ARTISTS; MOVIE STUDIOS; MUSIC COMPOSITION FOR OTHERS; PROVIDING MUSIC HALLS; NEWS REPORTING SERVICES; NIGHT CLUBS; NURSERY SCHOOLS; LOTTERY SERVICES; ENTERTAINMENT IN THE NATURE OF ORCHESTRA PERFORMANCES; ENTERTAINMENT SERVICES, NAMELY, CONDUCTING PARTIES FOR THE PURPOSE OF DATING AND SOCIAL INTRODUCTION FOR ADULTS; ARRANGING EXHIBITIONS FOR CULTURAL OR EDUCATIONAL PURPOSES; PARTY PLANNING; PHOTOGRAPHIC REPORTING; PHOTOGRAPHY SERVICES; PHYSICAL EDUCATION SERVICES; PRODUCTION OF RADIO AND TELEVISION PROGRAMS; AMUSEMENT ARCADES; PROVIDING CASINO FACILITIES; MOVIE THEATERS; PROVIDING GOLF FACILITIES; PROVIDING KARAOKE SERVICES; MUSEUMS; PROVIDING FACILITIES FOR RECREATION ACTIVITIES; PROVIDING SPORTS FACILITIES; PUBLICATION OF BOOKS; PUBLICATION OF ELECTRONIC BOOKS AND JOURNALS ON-LINE; PUBLICATION OF TEXTS, BOOKS, MAGAZINES AND OTHER PRINTED MATTER; RADIO ENTERTAINMENT PRODUCTION; RECORDING STUDIOS; PROVIDING INFORMATION ON RECREATIONAL ACTIVITIES; RELIGIOUS INSTRUCTION SERVICES; RENTAL OF AUDIO-VISUAL EQUIPMENT; RENTAL OF CINEMA FILMS; RENTAL OF LIGHTING APPARATUS FOR THEATRICAL SETS OR TELEVISION STUDIOS; RENTAL OF MOTION PICTURES; RENTAL OF MOVIE PROJECTORS AND ACCESSORIES; RENTAL OF RADIOS AND TELEVISIONS; RENTAL OF SHOW SCENERY; RENTAL OF SKIN DIVING EQUIPMENT; RENTAL OF SOUND RECORDINGS; RENTAL OF STADIUM FACILITIES; RENTAL OF STAGE SCENERY; RENTAL OF TENNIS COURTS; RENTAL OF VIDEO CAMERAS; RENTAL OF VIDEO CASSETTE RECORDERS; RENTAL OF VIDEOTAPES; SCRIPTWRITING SERVICES; SIGN LANGUAGE INTERPRETATION; SPORT DAY CAMP SERVICES; ORGANIZING COMMUNITY SPORTING AND CULTURAL EVENTS; PREPARING SUBTITLES FOR MOVIES; ENTERTAINMENT IN THE NATURE OF THEATER PRODUCTIONS; TIMING OF SPORTS EVENTS; TRANSLATION; VIDEOTAPE EDITING; VIDEOTAPE MOVIE PRODUCTION; VIDEOTAPING; VOCATIONAL GUIDANCE; ZOOS (U.S. CLS. 100, 101 AND 107).

DAVID TOOLEY, EXAMINING ATTORNEY

SN 79-038,132. CIMOS D.D., SLOVENIA, FILED 2-19-2007.



OWNER OF INTERNATIONAL REGISTRATION 0923140 DATED 2-19-2007, EXPIRES 2-19-2017.

THE COLOR(S) RED (PANTONE 1795C) AND WHITE IS/ ARE CLAIMED AS A FEATURE OF THE MARK.

THE COLOR RED APPEARS AS THE TEXT "CIMOS." AND THE LETTER "C" APPEARS IN THE COLOR WHITE INSIDE A RED CIRCLE

CLASS 1—CHEMICALS

FOR UNPROCESSED ARTIFICIAL RESINS USED IN CHEMICAL SYNTHESIS PROCESSES, UNPROCESSED PLASTICS FOR MOLDING PROCESSES; MANURES; FIRE EXTINGUISHING COMPOSITIONS; TEMPERING AND SOLDERING PREPARATIONS; COMBUSTING PREPARATIONS, NAMELY, FUEL ADDITIVES FOR INTERNAL COMBUSTION ENGINES; ANTI-KNOCK SUBSTANCES FOR INTERNAL COMBUSTION ENGINES, QUENCHING LIQUIDS FOR USE IN METAL-WORKING; METAL HARDENING AND THERMAL TREATMENT PREPARATIONS ALSO KNOWN AS QUENCHING LIQUIDS, NAMELY, BRINE, SOFT DISTILLED WATER OR OILS; METAL ANNEALING PREPARATIONS FOR METAL, METAL TEMPERING PREPARATIONS, MOLD-RELEASE PREPARATIONS FOR USE IN PROCESSES OF MOLDING METALS OR THEIR ALLOYS, CONCRETE FABRICATION, AS WELL AS IN MOLDING OF PLASTICS, POLYURETHANE, FIBERGLASS OR ARTIFICIAL RESINS; FIREPROOFING PREPARATIONS (U.S. CLS. 1, 5, 6, 10, 26 AND 46).

CLASS 6—METAL GOODS

FOR COMMON METALS AND THEIR ALLOYS; METAL BUILDING MATERIALS, NAMELY, TUBES, POSTS, WIRE, MESHES, PLATES, GRIDS, HOT-ROLLED PROFILES, COLD-ROLLED PROFILES; TRANSPORTABLE BUILDINGS OF METAL; NON-ELECTRIC CABLES AND WIRES OF COMMON METAL; IRONMONGERY, NAMELY, BRACKETS, FENCES, CHAINS AND GRIDS, SMALL ITEMS OF METAL HARDWARE, NAMELY, SCREWS, NAILS, RIVETS, NUTS, WASHERS, SPRINGS, LEVERS, ARMS, SLEEVES, HOOKS, FLANGES, BUSHES AND PINS; PIPES AND TUBES OF METAL; METAL SAFES; STANDS, HINGES, PIPE MUFFS OF METAL, MANIFOLDS OF METAL FOR PIPES, PIPES OF METAL, LEDGES OF METAL FOR SLIDING GUIDES; CAST IRON, RAW AND PROCESSED; IRON, RAW AND PROCESSED; ALLOYS OF COMMON METALS, INGOTS OF COMMON METAL, STEEL PLATES; STEEL CONSTRUCTIONS, NAMELY, FRAMEWORKS, GRIDS, SKELETONS, WELDED BEAMS, RIVETED BEAMS, SKELETONS FOR BUILDINGS, POSTS, CANTILEVERS, BEAMS OF STEEL, DOOR CLOSERS, NAMELY, METAL DOOR BOLTS, METAL KEYS, METAL LOCKS, LOCKS OF METAL FOR VEHICLES, MOLDINGS OF METAL, HINGES OF METAL, BINDINGS OF METAL FOR USE ON PACKAGING, DOORS OF METAL, CLOSURES OF METAL FOR CONTAINERS, TANKS OF METAL, FENCES OF METAL, SCREWS OF METAL, WASHERS OF METAL, NUTS OF METAL, CLAMPS OF METAL, BUILDING MATERIALS OF METAL, CHAINS OF METAL, GRIPS OF METAL; REINFORCING MATERIALS OF METAL FOR BUILDING, NAMELY, REINFORCING GRIDS, PROFILES, BEAMS, ROPES AND CABLES; ANTI-FRICTION METAL, NAMELY, SINTERED FRICTION SHOES AND PADS; HOOKS OF METAL, CAST METALLIC PRODUCTS, NAMELY, CASINGS, HOUSINGS, COVERS, LEVERS, BEAMS, CANTILEVERS, STANDS AND GRIDS; COLD-FORMED AND HOT-FORMED METALLIC PRODUCTS, NAMELY, SCREWS, NAILS, RIVETS, NUTS, WASHERS, SPRINGS, LEVERS, ARMS, SLEEVES, HOOKS, HINGES, FLANGES, BUSHES AND PINS; WELDED METALLIC PRODUCTS, NAMELY, FRAMEWORKS, GRIDS, SKELETONS,

BEAMS, SKELETONS FOR BUILDINGS, POSTS, CANTILEVERS AND PLATFORMS; MACHINED METALLIC PRODUCTS, NAMELY, SCREWS, NUTS, WASHERS, SPRINGS, LEVERS, ARMS, SLEEVES, HOOKS, FLANGES, BUSHES, PINS, GEARS, WORMS, SPINDLES, GUIDES AND HINGES (U.S. CLS. 2, 12, 13, 14, 23, 25 AND 50).

CLASS 7—MACHINERY

FOR MACHINES AND MACHINE TOOLS, NAMELY, GRINDING MACHINES, POLISHING MACHINES, DRILLING MACHINES, MILLING MACHINES AND TURNING MACHINES, MOTORS AND ENGINES FOR AGRICULTURAL MACHINES, NAMELY, HARVESTERS AND TEDDERS, AS WELL AS FOR CONSTRUCTION MACHINES, NAMELY, EXCAVATORS, BULLDOZERS, STONE SPREADERS, ROLLERS AND GRADERS, AND FOR MINING MACHINES, NAMELY, DRILLING MACHINES, BULLDOZERS, SCRAPERS AND HAMMERS, MACHINE COUPLING AND TRANSMISSION COMPONENTS, NAMELY, FLEXIBLE SHAFT COUPLINGS, FRICTION CLUTCHES, CARDAN COUPLINGS, BELT TRANSMISSIONS, CHAIN TRANSMISSIONS, BOWDEN TRANSMISSIONS, CABLE AND ROPE TRANSMISSIONS; AGRICULTURAL MACHINES, NAMELY, HARVESTERS, SEED PLANTING MACHINES AND MOWERS; SNOW PLOUGHS; CORN AND WHEAT CULTIVATORS; LAWN HUSKING MACHINES, MECHANIZED MOWING MACHINES, STRAW CUTTERS, SEED PLOUGHS, RAKING AND TEDDING MACHINES, AGRICULTURAL MACHINERY, NAMELY, HARVESTERS, EGG INCUBATORS, MANIPULATORS FOR FORGING PRESSES, WELDING MACHINES, CASTING MACHINES, SCREWING MACHINES, MEASURING APPARATUS AND PAINTING MACHINES; PISTONS FOR PNEUMATIC AND HYDRAULIC CYLINDERS; ELECTRIC PUMPS AND HYDRAULIC PUMPS; COMPRESSORS, HYDRAULIC MOTORS, TRUCK MILLS; CLEANING MACHINES AND APPLIANCES, NAMELY, SAND CLEANING MACHINES AND DRY CLEANING MACHINES; METAL EXTRUSION PRESSES, PLASTIC EXTRUSION PRESSES, METAL FORMING PRESSES, FORGING PRESSES AND PERFORATING MECHANIC AND HYDRAULIC PRESSES; COMPRESSED-AIR POLISHING MACHINES, COMPRESSED-AIR GRINDING MACHINES; CRUSHING MACHINES AND DISINTEGRATORS FOR ORES AND WASTE; PAINTING MACHINES, NAMELY, SPRAYING GUNS, PAINTING CHAMBERS AND ELECTROSTATIC PAINTING MACHINES; PLASTIC MOLDING MACHINES, FIBERGLASS MOLDING MACHINES, RUBBER MOLDING MACHINES; STEEL CAST MOLDING MACHINES, ALUMINUM MOLDING MACHINES AND CONCRETE MOLDING MACHINES; CONSTRUCTION MACHINES, NAMELY, EXCAVATORS, BULLDOZERS, STONE SPREADERS, ROLLERS AND GRADERS; MACHINING MACHINES FOR MACHINING OF WOOD, STONE, METALS OR PLASTICS, NAMELY, SAWS, DRILLING MACHINES, TURNING MACHINES, MILLING MACHINES, GRINDING AND POLISHING MACHINES AND CUTTING MACHINES; MACHINES FOR MANUFACTURING AND MOLDING OF PLASTICS; EXHAUSTS, NAMELY, PIPES, TUBES AND FLANGES FOR MOTORS AND ENGINES; CONTROL MECHANISMS FOR MACHINES, MOTORS AND ENGINES; PNEUMATIC, MECHANIC, HYDRAULIC, ELECTRIC AND ELECTRONIC CONTROLS FOR MACHINES, MOTORS AND ENGINES; IGNITING DEVICES FOR INTERNAL COMBUSTION ENGINES; SHAFT COUPLINGS FOR MACHINES, BEARINGS, NAMELY, AXIAL AND RADIAL ROLLER BEARINGS AND BALL BEARINGS AS WELL AS HYDRAULIC SLIDING BEARINGS; ORE PROCESSING DEVICES, NAMELY, CRUSHING MACHINES, DISINTEGRATORS, SEPARATORS, MIXERS, DRYING AND PRE-HEATING APPLIANCES; FRAMES AS STRUCTURAL PARTS OF CONSTRUCTION MACHINES AND TOOL MACHINES, HOUSINGS, ENGINE HOUSINGS AND HOUSINGS FOR PARTS OF TRANSMISSIONS, NAMELY, FOR CLUTCHES AND BEARINGS; SPRAYING GUNS, FEEDERS, GAS-OPERATED WELDING MACHINES, SHAFT COUPLINGS FOR MACHINES; CONVEYORS, TRANSMISSIONS FOR MACHINES, TRANSMISSION SHAFTS FOR MACHINES, LIFTING MACHINES FOR TRANSPORT OF PERSONS; LIFTING MACHINES FOR TRANSPORT OF GOODS, WINCHES, PULLEYS BEING PARTS OF MACHINES; MACHINES FOR CUTTING, THREAD-CUTTING, PER-

FORATING, METAL DRAWING, THREADING AND PUNCHING; ASSEMBLING MACHINES, NAMELY, MACHINES FOR ASSEMBLING OF VEHICLE BODIES BY WELDING OR SCREWING, MACHINES FOR ASSEMBLING OF PARTS OF FURNITURE AND MACHINES FOR ASSEMBLING PARTS IN MANUFACTURING OF MANUALLY OPERATED ELECTRIC HAND TOOLS; APPARATUS FOR MACHINING OF METALS, NAMELY, METAL EXTRUSION PRESSES, ROLLING MACHINES FOR ROLLING METALS AND PRESS DIES FOR METAL FORMING; METAL CASTING MACHINES, METAL CASTING APPARATUS, METAL WELDING APPARATUS AND MACHINES, NAMELY, ELECTRIC RESISTANCE WELDING MACHINES, PLASMA WELDING MACHINES, LASER BEAM WELDING MACHINES AND GAS WELDING GUNS; MACHINES FOR FORGING OF METALS, METALWORKING MACHINES, NAMELY, ROLLING MACHINES, DIES, FORGING HAMMERS, FORGING PRESSES AND FORGING MOLDS; MOTORS FOR BOATS, MIXERS, NET HAULING DEVICES, GREASE BOXES AS PARTS OF MACHINES, NAMELY, OF AGRICULTURAL MACHINES, NAMELY, HARVESTERS AND TEDDERS, AS WELL AS OF CONSTRUCTION MACHINES, NAMELY, EXCAVATORS, BULLDOZERS, STONE SPREADERS, ROLLERS AND GRADERS, AND OF MINING MACHINES, NAMELY, DRILLING MACHINES, BULLDOZERS, SCRAPERS AND HAMMERS (U.S. CLS. 13, 19, 21, 23, 31, 34 AND 35).

CLASS 8—HAND TOOLS

FOR HAND TOOLS AND IMPLEMENTS, NAMELY, SCREWDRIVERS, WRENCHES, TORQUE WRENCHES, PLIERS, PINCERS, SAWS; CUTLERY, NAMELY, FORKS, SPOONS AND KNIVES; SIDE ARMS NOT INCLUDING FIRE ARMS, NAMELY, HUNTING KNIVES; RAZORS; KNIFE BLADES AND ROLLER BLADES; SCRAPERS, KNIVES, BORERS, PUNCHES, PERFORATING TOOLS; GRINDING AND SHARPENING TOOLS, NAMELY, MANUALLY-OPERATED GRINDING WHEELS AND BLADE SHARPENERS; PIPE CUTTING TOOLS, CASTING CANS ALSO KNOWN AS METALLURGIC CANS (U.S. CLS. 23, 28 AND 44).

CLASS 9—ELECTRICAL AND SCIENTIFIC APPARATUS

FOR APPARATUS AND INSTRUMENTS FOR CONDUCTING, SWITCHING, TRANSFORMING, ACCUMULATING, REGULATING, OR CONTROLLING ELECTRICITY, NAMELY, ELECTRIC SWITCHES AND SWITCHBOARDS USED IN VEHICLES; MEASURING INSTRUMENTS, NAMELY, ELECTRONIC DEVICES FOR MEASURING VELOCITY USED IN VEHICLES; ELECTRONIC DEVICES FOR MEASURING TEMPERATURE USED IN VEHICLES; ELECTRONIC DEVICES FOR MEASURING ACCELERATIONS USED IN VEHICLES; ELECTRONIC BRAKE CONTROL DEVICES, PLASMA DISPLAY PANELS AND SENSORS, NAMELY, ELECTRIC SENSORS, PNEUMATIC SENSORS AND HYDRAULIC SENSORS; BRAKE SENSORS; SAFE-BELT SENSORS, AND TEMPERATURE SENSORS, BLANK MAGNETIC DATA CARRIERS, BLANK RECORDING DISCS; AUTOMATIC VENDING MACHINES AND MECHANISMS FOR COIN-OPERATED APPARATUS; CASH REGISTERS, CALCULATING MACHINES, DATA PROCESSING EQUIPMENT AND COMPUTERS; FIRE-EXTINGUISHING APPARATUS (U.S. CLS. 21, 23, 26, 36 AND 38).

CLASS 11—ENVIRONMENTAL CONTROL APPARATUS

FOR REFRIGERATORS; COOLING APPARATUS AND DEVICES, NAMELY, INDUSTRIAL AIR-CONDITIONING DEVICES, AIR-CONDITIONING DEVICES FOR VEHICLES (U.S. CLS. 13, 21, 23, 31 AND 34).

CLASS 12—VEHICLES

FOR CARS, BUSES, TRUCKS, TRACTORS, MOTOR HOMES, TRAILERS, CARAVANS AND CAMPING TRAILERS, FORK-LIFTS AND MILITARY VEHICLES FOR TRANSPORT; WINGS, BUMPER, HOODS FOR VEHICLE ENGINES, DOORS FOR VEHICLES, VEHICLE CHASSIS, AUTOMOBILE CHASSIS; STEERING WHEELS AND STEERING MECHANISMS FOR LAND VEHICLES, INCLUDING PARTS THEREOF; TRANSMISSION MECHANISMS FOR LAND VEHICLES, INCLUDING PARTS THEREOF; TRANSMISSION SHAFTS FOR LAND VEHICLES, TRANSMISSION CHAINS FOR LAND VEHICLES, VEHICLE SUSPENSION SPRINGS, VEHICLE WHEELS, TIRES FOR VEHICLE WHEELS, VEHICLE WHEEL AXLES, VEHICLE WHEEL RIMS, BRAKES FOR VEHICLES, BRAKE LININGS FOR VEHICLES, BRAKE PEDALS, VEHICLE BRAKE PADS, VEHICLE BRAKE DISCS, PARTS OF VEHICLE BRAKES, CASINGS FOR TRANSMISSION PARTS OF MOTOR VEHICLES, CLUTCHES FOR MOTOR VEHICLES, REDUCTION GEARS AND PARTS THEREOF, VEHICLE GEARBOXES AND PARTS THEREOF, HYDRAULIC CIRCUITS FOR VEHICLES, PNEUMO-HYDRAULIC CIRCUITS FOR VEHICLES, PNEUMATIC CIRCUITS FOR VEHICLES, SNOW-CHAINS, WINDSCREENS FOR VEHICLES, WINDSCREEN WIPERS, VEHICLE SAFETY SEATS FOR CHILDREN, CAPS FOR VEHICLE FUEL TANKS, COVERS FOR VEHICLES, TOWING HOOKS FOR VEHICLES, LUGGAGE CARRIERS FOR VEHICLES, STAIRS FOR VEHICLES, ANTI-THEFT ALARMS FOR VEHICLES, ELECTRIC MOTORS FOR VEHICLES, TURBINES FOR LAND VEHICLES, CARGO TRUCKS, TRANSPORTING TRUCKS, AND CASTING CARRIAGES (U.S. CLS. 19, 21, 23, 31, 35 AND 44).

CLASS 37—CONSTRUCTION AND REPAIR

FOR BUILDING CONSTRUCTION AND REPAIR; VEHICLE REPAIR, VEHICLE WASH, VEHICLE POLISHING, CLEANING; MACHINES INSTALLATION, MAINTENANCE AND REPAIR IN THE FIELD OF LAND VEHICLES; RIVETING OF STEEL CONSTRUCTIONS AND LIGHT METALLIC CONSTRUCTIONS; RIVETING OF VEHICLE CHASSIS, REPAIR OF VEHICLE BODIES, ANTI-RUST TREATMENT OF VEHICLES, REPAIR OF DAMAGED VEHICLES; SANDING, REBUILDING OF MACHINES THAT HAVE BEEN WORN OR PARTIALLY DESTROYED; REBUILDING OF ENGINES THAT HAVE BEEN WORN OR PARTIALLY DESTROYED; GREASING, REPAIR OF SECURITY LOCKS, REPAIR OF PUMPS, BUILDING AND MAINTENANCE OF WAREHOUSES AND FACTORIES, BUILDING OF FAIR STALLS; ELECTRIC APPLIANCES INSTALLATION AND REPAIR, HEATING APPLIANCES INSTALLATION AND REPAIR, COOLING APPLIANCES INSTALLATION AND REPAIR, OVENS INSTALLATION AND REPAIR, FIRE ALARMS OR ANTI-THEFT ALARMS INSTALLATION AND REPAIR (U.S. CLS. 100, 103 AND 106).

CLASS 39—TRANSPORTATION AND STORAGE

FOR TRANSPORT BY BOAT, TRANSPORT BY FERRY TRANSPORT BY RAIL, TRANSPORT BY AIR, TRANSPORT BY TRUCKS, COORDINATION OF TRAVEL ARRANGEMENT FOR INDIVIDUALS OR FOR GROUPS; DELIVERY OF GOODS BY TRUCK; CAR RENTAL, TRUCK RENTAL, RENTAL OF WAREHOUSE SPACE, PARKING PLACE RENTAL, TRANSPORT BROKERAGE, FREIGHT BROKERAGE, WAREHOUSE SERVICES, NAMELY, STORAGE OF VEHICLE SPARE PARTS, VEHICLE TOWING, BOAT TRANSPORT, RAILWAY TRANSPORT, ROADWAY TRANSPORT, AND AIR TRANSPORT (U.S. CLS. 100 AND 105).

CLASS 40—MATERIAL TREATMENT

FOR KEY CUTTING, PROVIDING MATERIAL TREATMENT INFORMATION, METAL TREATING, GRINDING, POLISHING, TURNING, MILLING, ENGRAVING, ZINC-PLATING, GALVANIZATION, NICKEL-PLATING, CHROMIUM-PLATING, CADMIUM-PLATING, SILVER-PLATING, GOLD-PLATING, METAL PLATING, QUENCHING, FORGING, ROLLING, CASTING SOLDERING, AND WELDING (U.S. CLS. 100, 103 AND 106).

CLASS 42—SCIENTIFIC AND COMPUTER SERVICES

FOR INDUSTRIAL ANALYSIS AND RESEARCH SERVICES IN THE FIELD OF MACHINING, HEAT TREATMENT AND SURFACE TREATMENT OF MATERIALS OR COMPONENTS IN CONNECTION WITH VEHICLE MANUFACTURING AND COMMON MACHINERY; INDUSTRIAL DESIGN, GRAPHIC ARTS DESIGN, PACKAGING DESIGN SERVICES; TECHNICAL PROJECT STUDIES, NAMELY, FEASIBILITY STUDIES, DRAFTING OF WORKING PLANS AND CONSTRUCTION DRAWINGS; RESEARCH IN THE FIELD OF MACHINERY, QUALITY CONTROL, MATERIAL TESTING, CONSTRUCTION PLANNING, AND VEHICLE ROADWORTHINESS TESTING (U.S. CLS. 100 AND 101).
RONALD AIKENS, EXAMINING ATTORNEY

SN 79-038,367. GRUPPO MANGANO SRL, ITALY, FILED 12-28-2006.



PRIORITY DATE OF 11-29-2006 IS CLAIMED.
OWNER OF INTERNATIONAL REGISTRATION 0923843 DATED 12-28-2006, EXPIRES 12-28-2016.
THE NAME(S), PORTRAIT(S), AND/OR SIGNATURE(S) SHOWN IN THE MARK DOES NOT IDENTIFY A PARTICULAR LIVING INDIVIDUAL.
THE MARK CONSISTS OF THE WORDING "M MANGANO" WRITTEN IN FANCY TYPE.
THE WORDING "MANGANO" HAS NO MEANING IN A FOREIGN LANGUAGE.

CLASS 3—COSMETICS AND CLEANING PREPARATIONS

FOR COSMETICS, NAMELY, BODY AND FACE CREAMS, BODY AND FACE LOTIONS; SKIN DETERGENTS, NAMELY, SOAPS; ESSENTIAL OILS, SHAMPOO AND HAIR BALMS; PERFUMES (U.S. CLS. 1, 4, 6, 50, 51 AND 52).

CLASS 18—LEATHER GOODS

FOR LEATHER AND IMITATIONS OF LEATHER, PARTICULARLY PURSES, BAGS, TRAVELLING BAGS, TRUNKS, BACKPACKS, WALLET, PURSES, DOCUMENT BAGS (U.S. CLS. 1, 2, 3, 22 AND 41).

CLASS 25—CLOTHING

FOR CLOTHING FOR MEN, WOMEN AND CHILDREN, PARTICULARLY TROUSERS, SHORTS, SKIRTS, DRESSES, SHIRTS, SWEATERS, JACKETS, COATS, JACKETS, JUMPSUITS, STOCKINGS, TIGHTS, PANTY-HOSE, UNDERWEAR, BRAS, UNDERSHIRTS, SWIMSUITS, NIGHT CLOTHES, NAMELY, NIGHTGOWNS, NIGHTSHIRTS AND NIGHTGOWNS, HATS, CAPS, SCARFS, FOULARDS AND GLOVES; SHOES AND BOOTS (U.S. CLS. 22 AND 39).
CIMMERIAN COLEMAN, EXAMINING ATTORNEY

SN 79-040,727. ULTRA PROIZVODNJA ELEKTRONSKIH NAPRAV D.O.O., SI-1410 ZAGORJE OB SAVI, SLOVENIA, FILED 10-10-2006.

MARGENTO

PRIORITY DATE OF 4-12-2006 IS CLAIMED.
OWNER OF INTERNATIONAL REGISTRATION 0929918 DATED 10-10-2006, EXPIRES 10-10-2016.
THE MARK "MARGENTO" HAS NO MEANING IN A FOREIGN LANGUAGE.

CLASS 9—ELECTRICAL AND SCIENTIFIC APPARATUS

FOR POINT-OF-SALE TERMINALS FOR USE WITH MOBILE PHONES AND/OR SMART CARDS, MAGNETIC CARDS AND/OR CARDS OR APPARATUS WITH RADIO FREQUENCY IDENTIFICATION DEVICES; COMPUTER PROGRAMS AND SOFTWARE FOR TRANSMITTING, DISPLAYING AND STORING TRANSACTION, IDENTIFICATION AND FINANCIAL INFORMATION FOR USE IN THE FINANCIAL, BANKING, RETAIL AND TELECOMMUNICATIONS INDUSTRIES; CASH REGISTERS; AUTOMATIC VENDING MACHINES; TELECOMMUNICATION AND ELECTRIC APPARATUS AND INSTRUMENTS FOR TRACKING, MANAGEMENT AND ANALYSIS OF FINANCIAL ACCOUNTS VIA GLOBAL COMPUTER NETWORK AND/OR TELECOMMUNICATION NETWORKS; MICRO CHIP BASED, MAGNETIC AND OPTICAL CARDS WITH RADIO FREQUENCY IDENTIFICATION DEVICES, NAMELY, RFID TAGS FOR ELECTRONIC TRANSFER OF FUNDS AND FOR FINANCIAL AND NON FINANCIAL TRANSACTIONS IN GENERAL; MODEMS; CIRCUIT BOARDS; THERMAL PRINTERS; CARD READERS FOR CREDIT AND DEBIT CARDS; MAGNETIC CODED CARD READERS; RADIO FREQUENCY IDENTIFICATION CARD READERS; SMART CARD READERS; CHECK READERS; BAR CODE READERS; BIOMETRIC AND RADIO FREQUENCY IDENTITY VERIFICATION DEVICES; DATA PROCESSORS FOR MANAGEMENT OF TRANSACTION CENTERS; APPARATUS AND PARTS THEREFORE FOR THE TRANSMISSION OF DATA AND SIGNALS USING TELEPHONES, MOBILE PHONES, FACSIMILE MACHINES, TELEGRAPHS, TELEPRINTERS, TELEX, CABLE; COMPUTER PROGRAMS AND SOFTWARE FOR USE IN VOICE IDENTIFICATION, RECOGNITION AND VERIFICATION; COMPUTER PROGRAMS AND SOFTWARE FOR CONFIGURATION, OPERATION AND MANAGEMENT OF POINT-OF-SALE TERMINALS, CASH REGISTERS AND OTHER POINT-OF-SALE ELECTRONIC DEVICES; COMPUTER PROGRAMS AND SOFTWARE FOR PROCESSING, MONITORING AND MANAGEMENT OF TRANSACTIONS IN FINANCIAL, BANKING, TELECOMMUNICATION AND/OR RETAIL BUSINESS; COMPUTER PROGRAMS AND SOFTWARE FOR SECURE DATA ENCRYPTION, STORAGE, RETRIEVAL AND TRANSMISSION OF CONFIDENTIAL INFORMATION; COMPUTER SOFTWARE FOR IDENTIFICATION AND AUTHENTICATION OF PERSONS; DOWNLOADABLE ELECTRONIC PUBLICATIONS, BOOKS, MAGAZINES, MANUALS, BULLETINS, TECHNICAL INSTRUCTIONS, FOR USE WITH POINT-OF-SALE TERMINALS, TRANSACTION SYSTEMS AND BANKING, IN ELECTRONIC FORM; DATA ENCRYPT-

TION APPARATUS AND DATA ENCRYPTION COMPUTER PROGRAMS AND SOFTWARE (U.S. CLS. 21, 23, 26, 36 AND 38).

CLASS 16—PAPER GOODS AND PRINTED MATTER

FOR CONSUMER COUPONS DOWNLOADED FROM A GLOBAL COMPUTER NETWORK (U.S. CLS. 2, 5, 22, 23, 29, 37, 38 AND 50).

CLASS 35—ADVERTISING AND BUSINESS

FOR MANAGEMENT OF RETAIL SERVICES PROVIDED ON-LINE, THROUGH NETWORKS, MOBILE TELECOMMUNICATION MEANS OR OTHER ELECTRONIC MEANS, USING ELECTRONICALLY DIGITIZED INFORMATION FOR OTHERS; BUSINESS MANAGEMENT; BUSINESS ADMINISTRATION; BUSINESS MANAGEMENT CONSULTING SERVICES WITH RELATION TO STRATEGY, MARKETING, PRODUCTION, PERSONNEL AND RETAIL SALES MATTERS; RENDERING OF BUSINESS INFORMATION CONCERNING FINANCIAL TRANSACTION SYSTEMS; PROVIDING BUSINESS INFORMATION SERVICES FOR USERS OF A MOBILE TRANSACTION SYSTEM; ADVERTISING; PUBLIC RELATIONS; BUSINESS AND MARKETING RESEARCH STUDIES; ADVISORY SERVICES FOR ORGANIZATIONAL ISSUES AND BUSINESS ADMINISTRATION, WITH OR WITHOUT THE HELP OF ELECTRONIC DATABASES; FINANCIAL STATEMENT PREPARATION AND ANALYSIS FOR BUSINESSES; PROMOTION OF FINANCIAL, INSURANCE, RETAIL AND OTHER SERVICES, ON BEHALF OF THIRD PARTIES; COMPUTER DATABASE MANAGEMENT; CUSTOMER LOYALTY SERVICES AND CUSTOMER CLUB SERVICES, FOR COMMERCIAL, PROMOTIONAL AND/OR ADVERTISING PURPOSES; ORGANIZATION AND MANAGEMENT OF CUSTOMER LOYALTY PROGRAMS; SALES PROMOTION THROUGH CUSTOMER LOYALTY PROGRAMS FOR OTHERS; ORGANIZATION, OPERATION AND SUPERVISION OF CUSTOMER LOYALTY PROGRAMS; CONSULTING SERVICES REGARDING CUSTOMER LOYALTY PROGRAMS (U.S. CLS. 100, 101 AND 102).

CLASS 36—INSURANCE AND FINANCIAL

FOR PROCESSING OF CREDIT AND DEBIT TRANSACTIONS BY TELEPHONE AND TELECOMMUNICATION LINK; PROVISION OF PAYMENT, MOBILE PAYMENT, BILL PAYMENT, PERSON TO PERSON MONEY TRANSFERS SERVICES; PROVISION OF PREPAID RECHARGE SERVICES, NAMELY, PAYMENT OF PREPAID MOBILE PHONES, PREPAID INTERNET SERVICES, PREPAID GAS, PREPAID ELECTRICITY, PREPAID COMMUNICATIONS, NAMELY, PREPAID LONG DISTANCE CALL CARDS AND OTHER PREPAID ACCOUNTS; FINANCIAL AFFAIRS, NAMELY, ISSUING OF CREDIT, DEBIT, PREPAID AND STORED VALUE ACCOUNTS AND/OR CARDS; ELECTRONIC FUNDS TRANSFER SERVICES, NAMELY, TRANSFER OF FUNDS BY MEANS OF TELECOMMUNICATION DEVICES, NAMELY, MOBILE PHONES, POINT OF SALE TERMINALS AND/OR BY MEANS OF PAYMENT CARDS AND RADIO FREQUENCY IDENTIFICATION DEVICES, NAMELY, TRANSPONDERS, COMPUTER NETWORKS, NAMELY, INTERNET AND OTHER TELECOMMUNICATION NETWORKS; PROCESSING PAYMENTS AND OTHER FINANCIAL TRANSACTIONS MADE BY MOBILE PHONES OR PAYMENT CARDS; FINANCIAL SETTLEMENT, NAMELY, DEBT SETTLEMENT AND CLEARING SERVICES; VERIFICATION OF FINANCIAL INFORMATION, NAMELY, CREDIT CARD INFORMATION; FINANCIAL FORECASTING, ADVISING, PLANNING, MANAGEMENT, RESEARCH AND REPORT SERVICES; ORGANIZATION AND OPERATION OF TRADING MARKETS FOR FINANCIAL SERVICES AND FINANCIAL INSTRUMENTS; PROFESSIONAL CONSULTANCY FOR THE ORGANIZATION AND ADMINISTRATION OF BANKING AND FINANCIAL BUSINESS (U.S. CLS. 100, 101 AND 102).

CLASS 38—COMMUNICATION

FOR PROVIDING SECURE COMMUNICATION AND TRANSMISSION OF TRANSACTION, IDENTIFICATION AND FINANCIAL INFORMATION BY WHATEVER MEANS, NAMELY, VIA ELECTRONIC COMMUNICATION NETWORKS; COMMUNICATION SERVICES BY MEANS OF MOBILE TELEPHONE AND TELEPHONES; PROVIDING MULTI-USER ACCESS TO A SECURE COMPUTERIZED INFORMATION NETWORK FOR THE TRANSFER AND DISSEMINATION OF A RANGE OF INFORMATION IN THE FIELD OF FINANCIAL AND RETAIL SERVICES; PROVIDING MULTI-USER ACCESS TO A SECURE GLOBAL COMPUTER INFORMATION NETWORK FOR THE TRANSFER AND DISSEMINATION OF A RANGE OF INFORMATION IN THE FIELD OF FINANCIAL AND RETAIL SERVICES; POINT-OF-SALE COMMUNICATION SERVICES, NAMELY, PROVIDING SECURE COMMUNICATION AND TRANSMISSION OF FINANCIAL DATA AND PAYMENTS BY WHATEVER MEANS, NAMELY, VIA ELECTRONIC COMMUNICATIONS NETWORKS, FROM POINT-OF-SALES TO THE PROCESSING CENTERS (U.S. CLS. 100, 101 AND 104).

CLASS 42—SCIENTIFIC AND COMPUTER SERVICES

FOR DESIGN AND DEVELOPMENT OF POINT-OF-SALE TERMINALS, ELECTRONIC TERMINALS, VALUE TRANSFER TERMINALS AND ELECTRONIC TRANSACTION EQUIPMENT FOR USE IN ELECTRONIC COMMERCE AND AT RETAIL POINT-OF-SALE; TECHNICAL SERVICES, NAMELY, BANKING COMPUTER SYSTEM SERVICES AND SYSTEM INTEGRATION SERVICES FOR MOBILE AND ELECTRONIC TRADING IN BANKING AND POINT-OF-SALE SYSTEMS; DEVELOPMENT OF ALL FORMS OF COMPUTER PROGRAMS AND SOFTWARE FOR PROCESSING, CLEARING AND SETTLEMENT OF FINANCIAL TRANSACTIONS, FOR USE IN BANKING, ELECTRONIC COMMERCE AND RETAIL BUSINESS; TECHNICAL SUPPORT OR CONSULTATION SERVICES CONCERNING USE AND OPERATION OF A TRANSACTION SYSTEM (U.S. CLS. 100 AND 101).

BERNICE MIDDLETON, EXAMINING ATTORNEY

SN 79-040,830. WAVECOM, FRANCE, FILED 8-18-2006.



PRIORITY DATE OF 3-9-2006 IS CLAIMED.
OWNER OF INTERNATIONAL REGISTRATION 0930226
DATED 8-18-2006, EXPIRES 8-18-2016.
OWNER OF U.S. REG. NO. 2,836,393.
THE MARK CONSISTS OF THE LETTER "W" WITH A CIRCULAR DESIGN SURROUNDING THE LETTER.

CLASS 9—ELECTRICAL AND SCIENTIFIC APPARATUS

FOR COMPUTER HARDWARE AND COMPUTER SOFTWARE AND FIRMWARE FOR WIRELESS CONTENT DELIVERY; COMPUTER GAMES SOFTWARE; SOFTWARE FOR CONTROLLING THE ACCESS TO A COMPUTER NETWORK; DATA TRANSMISSION SOFTWARE; CONTROL SOFTWARE, NAMELY, TO CONTROL BEHAVIOR OF PRODUCTS, NAMELY, AUTOMATIC METER READER, VEHICLE TRACKING DEVICE, DESKTOP PHONE, PERSONAL DATA ASSISTANTS (PDAS), AND CAMERAS; COMPUTER SOFTWARE DEVELOPMENT TOOLS, FOR USE IN A SOFTWARE DEVELOPMENT ENVIRONMENT; COMPUTER SOFTWARE FOR THE ENABLING OF ACCESS OR ENTRANCE CONTROL; COMPUTER SOFTWARE FOR CONTROLLING AND MANAGING ACCESS SERVER APPLICATIONS; FACILITIES MANAGEMENT SOFTWARE, NAMELY, SOFTWARE TO CONTROL BUILDING ENVIRONMENT, ACCESS AND SECURITY SYSTEMS; SOFTWARE FOR REMOTELY MONITORING ENVIRONMENTAL CONDITIONS AND CONTROLLING DEVICES WITHIN A BUILDING, FACILITY, GROUNDS, OR DESIGNATED SPATIAL AREA; SOFTWARE USED TO MONITOR THE STATUS OF INDUSTRIAL PROCESSES, NAMELY, POWER GENERATION, ELECTRICAL DISTRIBUTION AND OIL AND GAS PROCESSING; COMPUTER SOFTWARE FOR COMPUTER SYSTEM AND APPLICATION DEVELOPMENT, DEPLOYMENT AND MANAGEMENT; SOFTWARE USED FOR DEVELOPING SOFTWARE APPLICATIONS INTENDED FOR USE WITH RADIO COMMUNICATION APPARATUS AND ALL DEVICES EQUIPPED WITH MEANS OF RADIO COMMUNICATION, AND ESPECIALLY ELECTRONIC MODULES; EMBEDDED SOFTWARE FOR TRANSMITTING DATA OR FOR COMMUNICATION BETWEEN MACHINES, AND BETWEEN MACHINES, SENSORS, MEASURING INSTRUMENTS AND DATA SERVERS; EMBEDDED SOFTWARE FOR TRANSMITTING DATA OR INFORMATION IN THE MOTOR VEHICLE SECTOR, AND EMBEDDED SOFTWARE FOR TRANSMITTING DATA OR INFORMATION BETWEEN LAPTOP COMPUTERS AND PERSONAL DATA ASSISTANTS (PDAS); SOFTWARE FOR SETTING UP AND CONFIGURING RADIO-COMMUNICATION DEVICES NAMELY ELECTRONIC MODULES AND MODEMS, AND DEVICES FITTED WITH RADIO-COMMUNICATION MEANS; VENDING MACHINES; COIN-OPERATED APPARATUS, NAMELY, AUTOMATIC VENDING MACHINES FOR FOOD, BEVERAGES AND NEWSPAPERS; SOFTWARE FOR COMMUNICATING WITH WIRELESS NETWORK SERVICE PROVIDERS FOR ANY WIRED AND WIRELESS TECHNOLOGIES; COMPUTER OPERATING SYSTEM SOFTWARE; COMPUTER OPERATING PROGRAMS AND COMPUTER OPERATING SYSTEM EXTENSIONS, NAMELY, SOFTWARE CONTAINING DEBUGGING TOOLS AND HARDWARE COMPONENTS DRIVERS FOR CONNECTING PERSONAL COMPUTERS; COMPUTER HARDWARE, NAMELY, COMPUTER NETWORK ADAPTERS, SWITCHES, ROUTERS AND HUBS; WIRELESS COMMUNICATIONS AND COMPUTER SOFTWARE FOR DEVELOPING, SERVICING, MAINTAINING AND USING LOCAL AREA COMPUTER NETWORKS (LANS) AND WIDE AREA COMPUTER NETWORKS (WANS); COMPUTER HARDWARE AND SOFTWARE FOR TRANSMITTING/DIFFUSING HUB, ROUTER, VIDEO, AUDIO AND DIGITAL DATA SIGNALS; COMPUTER SERVERS; FIRMWARE, NAMELY, COMPUTER OPERATING SYSTEM SOFTWARE; FIXED ROLE COMPUTER SERVERS; NETWORKED COMPUTER HARDWARE; SEMI-CONDUCTORS; COMPUTER HARDWARE AND SOFTWARE FOR CREATING, FACILITATING AND MANAGING REMOTE ACCESS TO AND COMMUNICATION WITH LOCAL AREA NETWORKS (LANS), VIRTUAL PRIVATE NETWORKS (VPNS), WIDE AREA NETWORKS (WANS) AND GLOBAL COMPUTER NETWORKS; VIRTUAL PRIVATE NETWORKS (VPNS), WIDE AREA NETWORKS (WANS) OPERATING SOFTWARE FOR SERVERS; COMPUTER SOFTWARE FOR USE IN GATEWAYS FOR COMPUTER NETWORKING TO MULTIPLE USERS FOR SEARCHING, RETRIEVING, TRANSFERRING, MANIPULATING AND DISSEMINATING A LARGE RANGE OF DATA; COMPUTER HARDWARE AND SOFTWARE FOR WIRELESS COMMUNICATIONS WITH NETWORKS; ELECTRICITY CONDUITS AND ADAPTERS; REMOTE CONTROL TELEMETERING MACHINES, VEHICLE TRACKING AND

APPARATUS; ELECTRIC INSTALLATIONS AND ELECTRONIC APPARATUS FOR THE REMOTE CONTROL OF INDUSTRIAL OPERATIONS; ELECTRONIC TRANSMITTERS AND RECEIVERS FOR HANDLING DATA SIGNALS ALONG ELECTRICAL POWER LINES; ELECTRONIC TRANSMITTERS AND RECEIVERS FOR EXTENDING VIDEO, KEYBOARD, MOUSE, AUDIO OR SERIAL SIGNALS OVER A DISTANCE; ELECTRONIC TRANSMITTERS AND RECEIVERS FOR THE BROADCAST AND RECEPTION OF SATELLITE, TELEPHONIC, TELEVISION AND CABLE SIGNALS; ELECTRIC BATTERIES; FIXED AND MOBILE RADIO-COMMUNICATION EQUIPMENT, NAMELY, VEHICLE LOCATOR AND RECOVERY DEVICE PROGRAMMED TO USE GLOBAL POSITIONING SYSTEM (GPS) AND CELLULAR COMMUNICATIONS AND WIRELESS TRANSCIEVERS WITH COLLECTION AND DISPLAY TECHNOLOGY FOR THE STATUS AND TRACKING OF ALL VEHICLE TYPES IN LOCAL ENVIRONMENTS; DATA PROCESSORS AND DATA PROCESSING APPARATUS, NAMELY, AUTOMATIC METER READER, NODES FOR DATA ACQUISITION AND FORMATTING PROBES FOR NETWORK AND FACILITIES TESTING, LIVE MONITORING, ALERTING AND TROUBLESHOOTING, FOR QUALITY OF SERVICE AND SERVICE MANAGEMENT; COMPUTERS ESPECIALLY COMPUTER SERVERS AND PERSONAL DIGITAL ASSISTANTS (PDAS); DATA PROCESSING APPARATUS; APPARATUS FOR RECORDING, EMISSION, RECEPTION, TRANSMISSION, PROCESSING AND REPRODUCTION OF SOUND, STILL OR ANIMATED IMAGES, MESSAGES OR DATA BUT EXCLUDING LOUDSPEAKER PRODUCTS AND MUSIC SYSTEMS, NAMELY, SYSTEMS FOR THE CONVERSION OF ELECTRIC ANALOG AND DIGITAL SIGNALS INTO ACOUSTIC SIGNAL AND STAND ALONE PARTS AND ACCESSORIES THEREFOR; MAGNETIC RECORDING MEDIA, NAMELY, BLANK CD-ROMS; MAGNETIC DATA MEDIA, NAMELY, BLANK CD-ROMS; RECORDING DISCS, NAMELY, BLANK CD-ROMS AND RECORDABLE OPTICAL DISCS; OPTICAL DATA MEDIA, NAMELY, OPTICAL READERS; APPARATUS FOR AUDIO, VIDEO AND MULTIMEDIA CONTENT STREAMING AND FOR TRANSFERRING, TRANSMITTING, RECEIVING, PROCESSING AND DIGITIZING IMAGES, NAMELY, DIGITAL MEDIA STREAMING DEVICES; ALGORITHMS FOR DATA COMPRESSION AND DECOMPRESSION, NAMELY, DATA COMPRESSION AND DECOMPRESSION SOFTWARE; PRE-RECORDED MAGNETIC DATA CARRIERS FEATURING DATA AND INFORMATION IN THE FIELD OF INDUSTRIAL WIRELESS COMMUNICATIONS; TELEPHONE AND RADIOTELEPHONE INSTALLATIONS, NAMELY, TELECOMMUNICATION TOWERS, TELEPHONE APPARATUS, TELEPHONE TRANSMITTERS AND TELEPHONE RECEIVERS, ESPECIALLY MOBILE, PORTABLE AND STATIC FORM; TELEPHONE ANSWERING MACHINES, MODEMS; COMPUTER HARDWARE AND SOFTWARE FOR TRANSMITTING AND RECEIVING FAXES; RADIO PAGING RECEIVERS; TELEPHONE EXCHANGES; RADIOTELEPHONY TERMINALS; RADIO PAGING TERMINALS; SATELLITES AND ANTENNAE, FOR CIRCULATION, TRANSMISSION AND RECEPTION OF DATA, SOUNDS, STILL OR ANIMATED IMAGES, MESSAGES; AUDIO-VIDEO TERMINALS AND MULTIMEDIA TERMINALS, NAMELY, COMPUTER TERMINALS AND MOBILE DATA TERMINALS (MDTS); LOCAL NETWORKS OF COMPUTERS COMPRISED OF COMPUTER NETWORK ADAPTERS, HUBS AND SWITCHES; DATA PROCESSOR, COMPUTER HARDWARE; REMOTE-CONTROL SOFTWARE AND HARDWARE USED FOR TRANSFERRING, RECORDING, READING AND REPRODUCING COMPUTER SOUND, IMAGES AND DATA; COMPUTERS, MICRO-COMPUTERS; COMPUTER PERIPHERALS; INTEGRATED CIRCUITS, FIRE EXTINGUISHERS, COMPUTER KEYBOARDS, COMPUTER MICE; MICROPROCESSORS, SEMICONDUCTORS, CENTRAL PROCESSING UNITS USING SEMICONDUCTORS, CENTRAL PROCESSING UNIT CHIPS USING SEMICONDUCTORS, PRINTED CIRCUITS FOR DATA PROCESSING EQUIPMENT, ELECTRIC BATTERIES, MEMORY CARDS, MEMORY CARD READERS, PRINTED CIRCUIT CARDS, ELECTRONIC CIRCUIT CARDS; SEMICONDUCTOR CHIPS; VIDEO CIRCUIT CARDS; AUDIO CIRCUIT CARDS; AUDIO-VIDEO CIRCUIT CARDS; VIDEO GRAPHICS ACCELERATORS; MULTIMEDIA ACCELERATORS; VIDEO PROCESSORS; INSTRUCTIONAL MATERIAL NAMELY BOOKS, TECHNICAL INSTRUCTION MANUAL, BROCHURES IN THE

FIELDS OF COMPUTERS, COMPUTER OPERATING SYSTEMS AND TELECOMMUNICATIONS, SOFTWARE COMPUTING INDUSTRY, CAR MANUFACTURING AND TELEMTRY SEGMENTS, ALL RECORDED MAGNETICALLY, OPTICALLY AND ELECTRONICALLY RECORDED ON CDS, DVDS AND DOWNLOADABLE AUDIO FILES; DOWNLOADABLE ELECTRONIC PUBLICATIONS, NAMELY, NEWSLETTERS, TECHNICAL INSTRUCTION MANUAL, JOURNALS, AND MAGAZINES IN THE FIELDS OF TELECOMMUNICATIONS AND COMPUTER OPERATING SYSTEMS, SOFTWARE COMPUTING INDUSTRY, CAR MANUFACTURING AND TELEMTRY SEGMENTS (U.S. CLS. 21, 23, 26, 36 AND 38).

CLASS 38—COMMUNICATION

FOR COMMUNICATION SERVICES PROVIDED VIA COMPUTER TERMINALS TRANSMITTING ANY TYPE OF DATA ACQUIRED AND PROCESSED BY THE TERMINALS, NAMELY, DATA, AUDIO, VIDEO, FILES, PICTURES; COMMUNICATIONS VIA COMPUTER TERMINALS; SERVICES FOR MULTIMEDIA COMMUNICATION AND FOR DIGITAL COMMUNICATIONS, NAMELY, DISTRIBUTION, ELECTRONIC TRANSMISSION AND INTERACTIVE AND NON-INTERACTIVE RECEPTION OF VOICE, DATA, IMAGES, PAGED MESSAGES, FAXES AND INFORMATION, TRANSMISSION AND RECEPTION OF AUDIO DATA ON AN INTERNET NETWORK; TELECOMMUNICATIONS USING GLOBAL COMPUTER NETWORKS PROVIDING INFORMATION IN THE FIELD OF TELECOMMUNICATION, RADIO COMMUNICATION, RADIO PAGING, TELEPHONY, RADIOTELEPHONY, BROADCASTING, TRANSMISSION AND DISTRIBUTION OF SOUNDS, STILL AND ANIMATED IMAGES, DATA, MESSAGES VIA A GLOBAL TELECOMMUNICATIONS NETWORK NAMELY THE INTERNET OR A PRIVATE ACCESS NETWORK, NAMELY, INTRANET; FACSIMILE TRANSMISSION; PROVIDING OF INFORMATION RELATING TO TELECOMMUNICATIONS, RADIO-COMMUNICATION, RADIO PAGING, TELEPHONY, WIRELESS TELEPHONY, MOBILE RADIOTELEPHONY SERVICES, RADIO BROADCASTING, DISTRIBUTION AND TRANSMISSION OF SOUNDS OR IMAGES, OF STILL OR ANIMATED IMAGES, OF DATA AND OF MESSAGES; PROVIDING ACCESS TO GLOBAL COMMUNICATION NETWORKS, THE INTERNET, AND PRIVATE ACCESS NETWORKS AND INTRANETS; RENTAL OF COMMUNICATION TERMINALS, MODEMS; CONSULTING SERVICES REGARDING COMPUTERS, SOFTWARE, TELECOMMUNICATION, RADIO COMMUNICATION, RADIO PAGING, TELEPHONY, WIRELESS TELEPHONY, RADIO BROADCASTING, DISTRIBUTION AND TRANSMISSION OF SOUNDS OR IMAGES, OF STILL OR ANIMATED IMAGES, OF DATA AND OF MESSAGES; SERVICES PROVIDING ACCESS TO AN INTERNET SITE FOR THE PURPOSE OF DOWNLOADING SOFTWARE, SOUNDS, STILL OR ANIMATED IMAGES, OF DATA, MESSAGES; RENTAL OF ACCESS TIME TO DATA BASE SERVER CENTRES ON A GLOBAL COMPUTER INFORMATION NETWORK; PROVIDING MULTIPLE USE ACCESS TO A GLOBAL COMPUTER INFORMATION NETWORK FOR THE TRANSFER AND DISSEMINATION OF FILES CONTAINED ON THE WEBSITES OF OTHERS FOR DOWNLOADING SOFTWARE, COMPUTER GAMES SOFTWARE, SOUNDS, STILL AND ANIMATED IMAGES, OF DATA, MESSAGES ON THE INTERNET WEB SITE; TELECONFERENCING SERVICES NAMELY VIDEOCONFERENCE, CONFERENCE CALL SERVICES; SERVICES PROVIDING DISCUSSION GROUPS AND INSTANTANEOUS MESSAGING ON THE INTERNET, NAMELY, FORUMS; TRANSMISSION OF PUBLICATIONS ONLINE, NAMELY, INFORMATION BOOKLETS, CATALOGUES, RELATING TO COMPUTING AND NEW INFORMATION TECHNOLOGIES (U.S. CLS. 100, 101 AND 104).

CLASS 41—EDUCATION AND ENTERTAINMENT

FOR EDUCATIONAL SERVICES, NAMELY, TEACHING COURSES OF INSTRUCTION, PROVIDING CORRESPONDENCE COURSES, AND PROVIDING PRACTICAL TRAINING FEATURING DEMONSTRATIONS ALL IN THE FIELDS OF TELECOMMUNICATIONS AND COMPUTER OPERATING SYSTEMS, SOFTWARE DEVELOPMENT, SOFTWARE TESTING AND DEBUGGING, CAR MANUFACTURING AND TELEMTRY SEGMENTS; ARRANGING AND CONDUCTING PRACTICAL TRAINING, TRAINING WORKSHOPS IN THE FIELD OF SOFTWARE DEVELOPMENT, SOFTWARE TESTING AND DEBUGGING, SECURING, DOWNLOADING, UPGRADING AND UPDATING; ARRANGING AND CONDUCTING OF COLLOQUIUMS, EXHIBITIONS, CONFERENCES, CONVENTIONS IN THE FIELD OF SOFTWARE DEVELOPMENT, SOFTWARE TESTING AND DEBUGGING, SECURING, DOWNLOADING, UPGRADING AND UPDATING ORGANIZATION AND CONDUCTING OF EDUCATIONAL TESTS; EDUCATION IN THE NATURE OF PRACTICAL TRAINING FEATURING DEMONSTRATION IN THE FIELD OF SOFTWARE USE, DESIGN AND DEVELOPMENT; PRACTICAL TRAINING FEATURING DEMONSTRATIONS IN THE FIELD OF TELECOMMUNICATIONS, TELECOMMUNICATIONS VIA GLOBAL COMPUTER NETWORKS, COMPUTING, PROGRAMMING, DEVELOPING, INSTALLING, OPERATING, MANAGING AND MAINTAINING SOFTWARE AND COMPUTERS; ARRANGING AND CONDUCTING OF COLLOQUIUMS, CONFERENCES, CONVENTIONS, PRACTICAL TRAINING WORKSHOPS FEATURING DEMONSTRATION IN THE FIELDS OF PROGRAMMING, DEVELOPING, INSTALLING, OPERATING, MANAGING AND MAINTAINING SOFTWARE AND COMPUTERS (U.S. CLS. 100, 101 AND 107).

CLASS 42—SCIENTIFIC AND COMPUTER SERVICES

FOR CONSULTING SERVICES IN THE FIELD OF DESIGN, SELECTION, IMPLEMENTATION AND USE OF COMPUTER HARDWARE AND SOFTWARE SYSTEMS FOR OTHERS; TECHNICAL CONSULTING AND ASSISTANCE WITH COMPUTER-BASED INFORMATION SYSTEMS AND COMPONENTS; HOSTING SERVICES FOR WEB SITES; DESIGN AND DEVELOPMENT OF SOFTWARE, COMPUTING AND TELECOMMUNICATIONS EQUIPMENT; CONDUCTING COMPUTER ENGINEERING STUDIES FOR OTHERS, INSTALLATION OF COMPUTER SOFTWARE PROGRAMMING, RENTAL OF COMPUTER SOFTWARE, MAINTENANCE OF COMPUTER SOFTWARE, COMPUTER SOFTWARE UPDATES, COMPUTER PROGRAMMING; REMOTE AND ON-SITE MANAGEMENT OF SERVICES FOR HOSTING WEB SITES AND, REMOTE AND ON-SITE MANAGEMENT OF ELECTRONIC MESSAGING FOR OTHERS, FOR SECURE MESSAGING; SCIENTIFIC AND INDUSTRIAL RESEARCH RELATING TO NEW INFORMATION TECHNOLOGIES, NAMELY, RESEARCH AND DEVELOPMENT OF NEW PRODUCTS, TECHNICAL RESEARCH IN THE FIELD OF TELECOMMUNICATION, COMPUTING TECHNOLOGIES; PATENT EXPLOITATION, NAMELY, GRANTING PATENT LICENSES (U.S. CLS. 100 AND 101).

BERNICE MIDDLETON, EXAMINING ATTORNEY

SN 79-041,137. WAVECOM, FRANCE, FILED 8-18-2006.



PRIORITY DATE OF 3-9-2006 IS CLAIMED.
 OWNER OF INTERNATIONAL REGISTRATION 0930899
 DATED 8-18-2006, EXPIRES 8-18-2016.
 OWNER OF U.S. REG. NO. 2,836,393.
 "THE COLOR(S) BLUE AND BLACK IS/ARE CLAIMED
 AS A FEATURE OF THE MARK."
 THE MARK CONSISTS OF THE WORDING "WAVECOM
 W"; THE WORD "WAVECOM" IS DEPICTED IN BLACK,
 AND THE LETTER "W" IS DEPICTED IN BLUE WITH A
 BLUE CIRCLE AROUND THE "W". THE TERM "WAVE-
 COM" IS BLACK AND THE STYLISED "W" LOGO IS BLUE;
 PANTONE 2718 (CYAN 72%, MAGENTA 43%).

CLASS 9—ELECTRICAL AND SCIENTIFIC APPARATUS

FOR COMPUTER HARDWARE AND COMPUTER SOFTWARE AND FIRMWARE FOR WIRELESS CONTENT DELIVERY; COMPUTER GAMES SOFTWARE; SOFTWARE FOR CONTROLLING ACCESS TO A COMPUTER NETWORK; DATA TRANSMISSION SOFTWARE; CONTROL SOFTWARE, NAMELY, TO CONTROL BEHAVIOR OF PRODUCTS, NAMELY, AUTOMATIC METER READERS, VEHICLE TRACKING DEVICES, DESKTOP PHONES, PERSONAL DATA ASSISTANTS (PDAS), AND CAMERAS; SOFTWARE DEVELOPMENT TOOLS FOR USE IN A SOFTWARE DEVELOPMENT ENVIRONMENT; COMPUTER SOFTWARE FOR THE ENABLING OF ACCESS AND ENTRANCE CONTROL; COMPUTER SOFTWARE FOR CONTROLLING AND MANAGING ACCESS SERVER APPLICATIONS; FACILITIES MANAGEMENT SOFTWARE, NAMELY, SOFTWARE TO CONTROL BUILDING ENVIRONMENT, ACCESS AND SECURITY SYSTEMS; SOFTWARE FOR REMOTELY MONITORING ENVIRONMENTAL CONDITIONS AND CONTROLLING DEVICES WITHIN A BUILDING, FACILITY, GROUNDS, OR DESIGNATED SPATIAL AREA; SOFTWARE USED TO MONITOR THE STATUS OF INDUSTRIAL PROCESSES, NAMELY, POWER GENERATION, ELECTRICAL DISTRIBUTION AND OIL AND GAS PROCESSING; KITS AND TOOLS FOR INTEGRATED DEVELOPMENT ENVIRONMENTS TO EASE THE DEVELOPMENT OF THIRD PARTY SOFTWARE APPLICATIONS AND TO ALLOW USERS TO WRITE AND COMPILE APPLICATIONS, DOWNLOAD THEM VIA WIRELESS TECHNOLOGY, AND DEBUG AND MONITOR SUCH APPLICATIONS; SOFTWARE USED FOR DEVELOPING SOFTWARE APPLICATIONS INTENDED FOR USE WITH RADIO COMMUNICATION APPARATUS AND ALL DEVICES EQUIPPED WITH MEANS OF RADIO COMMUNICATION, AND ESPECIALLY ELECTRONIC MODULES; EMBEDDED SOFTWARE FOR TRANSMITTING DATA AND FOR COMMUNICATION BETWEEN MACHINES, AND BETWEEN MACHINES, SENSORS, MEASURING INSTRUMENTS AND DATA SERVERS; EMBEDDED SOFTWARE FOR TRANSMITTING DATA AND INFORMATION IN THE MOTOR VEHICLE SECTOR, AND EMBEDDED SOFTWARE FOR TRANSMITTING DATA AND INFORMATION BETWEEN LAPTOP COMPUTERS AND PERSONAL DATA ASSISTANTS (PDAS); SOFTWARE FOR SETTING UP AND CONFIGURING RADIO-COMMUNICATION DEVICES NAMELY ELECTRONIC MODULES AND MODEMS, AND DEVICES FITTED WITH RADIO-COMMUNICATION MEANS; VENDING MACHINES; COIN-OPERATED APPARATUS, NAMELY, AUTOMATIC VENDING MACHINES FOR FOOD, BEVERAGES AND NEWSPAPERS; SOFTWARE FOR COMMUNICATING WITH WIRELESS NETWORK SERVICE PROVIDERS FOR ANY WIRED AND WIRELESS TECHNOLOGIES; COMPUTER OPERATING SYSTEM SOFTWARE; COMPUTER OPERATING PROGRAMS AND COMPUTER OPERATING SYSTEM EXTENSIONS, NAMELY, SOFTWARE CONTAINING DEBUGGING TOOLS AND HARDWARE COMPONENTS AND DRIVERS FOR CONNECTING PERSONAL COMPUTERS; COMPUTER HARDWARE, NAMELY, COMPUTER NETWORK ADAPTERS, SWITCHES, ROUTERS AND HUBS; WIRELESS COMMUNICATIONS AND COMPUTER SOFTWARE FOR DEVELOPING, SERVING, MAINTAINING AND USING LOCAL AREA

COMPUTER NETWORKS (LANS) AND WIDE AREA COMPUTER NETWORKS (WANS); COMPUTER HARDWARE AND SOFTWARE FOR TRANSMITTING/DIFFUSING HUB, ROUTER, VIDEO, AUDIO AND DIGITAL DATA SIGNALS; COMPUTER SERVERS; FIRMWARE, NAMELY, COMPUTER OPERATING SYSTEM SOFTWARE; FIXED ROLE COMPUTER SERVERS; NETWORKED COMPUTER HARDWARE; SEMI-CONDUCTORS; COMPUTER HARDWARE AND SOFTWARE FOR CREATING, FACILITATING AND MANAGING REMOTE ACCESS TO AND COMMUNICATION WITH LOCAL AREA NETWORKS (LANS), VIRTUAL PRIVATE NETWORKS (VPNS), WIDE AREA NETWORKS (WANS) AND GLOBAL COMPUTER NETWORKS; VIRTUAL PRIVATE NETWORKS (VPNS), WIDE AREA NETWORKS (WANS), AND OPERATING SOFTWARE FOR SERVERS; COMPUTER SOFTWARE FOR USE IN GATEWAYS FOR COMPUTER NETWORKING TO MULTIPLE USERS FOR SEARCHING FOR, RETRIEVING, TRANSFERRING, MANIPULATING AND DISSEMINATING A LARGE RANGE OF DATA; COMPUTER HARDWARE AND SOFTWARE FOR WIRELESS COMMUNICATIONS WITH NETWORKS; ELECTRICITY CONDUITS AND ADAPTERS; REMOTE CONTROL TELEMETERING MACHINES AND APPARATUS; ELECTRIC INSTALLATIONS AND ELECTRONIC APPARATUS FOR THE REMOTE CONTROL OF INDUSTRIAL OPERATIONS; ELECTRONIC TRANSMITTERS AND RECEIVERS FOR HANDLING DATA SIGNALS ALONG ELECTRICAL POWER LINES; ELECTRONIC TRANSMITTERS AND RECEIVERS FOR EXTENDING VIDEO, KEYBOARD, MOUSE, AUDIO AND SERIAL SIGNALS OVER A DISTANCE; ELECTRONIC TRANSMITTERS AND RECEIVERS FOR THE BROADCAST AND RECEPTION OF SATELLITE, TELEPHONIC, TELEVISION AND CABLE SIGNALS; ELECTRIC BATTERIES; FIXED AND MOBILE RADIO-COMMUNICATION EQUIPMENT, NAMELY, VEHICLE LOCATOR AND RECOVERY DEVICE PROGRAMMED TO USE GLOBAL POSITIONING SYSTEM (GPS) AND CELLULAR COMMUNICATIONS AND WIRELESS TRANSCEIVERS WITH COLLECTION AND DISPLAY TECHNOLOGY FOR THE STATUS AND TRACKING OF ALL VEHICLE TYPES IN LOCAL ENVIRONMENTS; DATA PROCESSORS AND DATA PROCESSING APPARATUS, NAMELY, AUTOMATIC METER READER, NODES FOR DATA ACQUISITION AND FORMATTING PROBES FOR NETWORK AND FACILITIES TESTING, LIVE MONITORING, ALERTING AND TROUBLESHOOTING, FOR QUALITY OF SERVICE AND SERVICE MANAGEMENT; COMPUTERS ESPECIALLY COMPUTER SERVERS AND PERSONAL DIGITAL ASSISTANTS (PDAS); DATA PROCESSING APPARATUS; APPARATUS FOR RECORDING, TRANSMISSION, PROCESSING AND REPRODUCTION OF SOUND, IMAGES AND DATA BUT EXCLUDING LOUD-SPEAKER PRODUCTS, AND MUSIC SYSTEMS, NAMELY, SYSTEMS FOR THE CONVERSION OF ELECTRIC SIGNALS, WHETHER ANALOG OR DIGITAL, INTO ACOUSTIC SIGNALS AND COMPONENT PARTS AND ACCESSORIES THEREFOR; MAGNETIC RECORDING MEDIA, NAMELY, BLANK CD-ROMS; MAGNETIC DATA MEDIA, NAMELY BLANK CD-ROMS; RECORDING DISCS, NAMELY, BLANK CD-ROMS AND BLANK RECORDABLE OPTICAL DISCS; OPTICAL DATA MEDIA, NAMELY, OPTICAL READERS; APPARATUS FOR AUDIO, VIDEO AND MULTIMEDIA CONTENT STREAMING AND FOR TRANSFERRING, TRANSMITTING, RECEIVING, PROCESSING AND DIGITIZING IMAGES, NAMELY, DIGITAL MEDIA STREAMING DEVICES; ALGORITHMS FOR DATA COMPRESSION AND DECOMPRESSION, NAMELY, DATA COMPRESSION AND DECOMPRESSION SOFTWARE; PRERECORDED MAGNETIC DATA CARRIERS FEATURING DATA AND INFORMATION IN THE FIELD OF INDUSTRIAL WIRELESS COMMUNICATIONS; TELEPHONE AND RADIOTELEPHONE INSTALLATIONS NAMELY TELECOMMUNICATION TOWERS, TELEPHONE APPARATUS, TELEPHONE TRANSMITTERS AND TELEPHONE RECEIVERS, ESPECIALLY MOBILE, PORTABLE AND STATIC FORM; TELEPHONE ANSWERING MACHINES, MODEMS; COMPUTER HARDWARE AND SOFTWARE FOR TRANSMITTING AND RECEIVING FAXES; RADIO PAGING RECEIVERS; TELEPHONE EXCHANGES; RADIOTELEPHONY TERMINALS; RADIO PAGING TERMINALS; SATELLITES AND ANTENNAE, FOR CIRCULATION, TRANSMISSION AND RECEPTION OF DATA, SOUNDS, STILL OR ANIMATED IMAGES, MESSAGES; AUDIO-VIDEO TERMINALS AND MULTIMEDIA TERMINALS,

NAMELY, COMPUTER TERMINALS AND MOBILE DATA TERMINALS (MDTS); LOCAL NETWORKS OF COMPUTERS COMPRISED OF COMPUTER NETWORK ADAPTERS, HUBS AND SWITCHES; DATA PROCESSOR, COMPUTER HARDWARE; REMOTE-CONTROL SOFTWARE AND HARDWARE USED FOR TRANSFERRING, RECORDING, READING AND REPRODUCING COMPUTER SOUND, IMAGES AND DATA; COMPUTERS, MICRO-COMPUTERS; COMPUTER PERIPHERALS; INTEGRATED CIRCUITS, FIRE EXTINGUISHERS, COMPUTER KEYBOARDS, COMPUTER MICE; MICROPROCESSORS, SEMICONDUCTORS, CENTRAL PROCESSING UNITS USING SEMICONDUCTORS, CENTRAL PROCESSING UNIT CHIPS USING SEMICONDUCTORS, PRINTED CIRCUITS FOR DATA PROCESSING EQUIPMENT, ELECTRIC BATTERIES, MEMORY CARDS, MEMORY CARD READERS, PRINTED CIRCUIT CARDS, ELECTRONIC CIRCUIT CARDS; SEMICONDUCTOR CHIPS; VIDEO CIRCUIT CARDS; AUDIO CIRCUIT CARDS; AUDIO-VIDEO CIRCUIT CARDS; VIDEO GRAPHICS ACCELERATORS; MULTIMEDIA ACCELERATORS; VIDEO PROCESSORS; INSTRUCTIONAL MATERIAL, NAMELY, BOOKS, TECHNICAL INSTRUCTION MANUAL, AND BROCHURES IN THE FIELDS OF COMPUTERS AND TELECOMMUNICATIONS, COMPUTER OPERATING SYSTEMS, THE SOFTWARE COMPUTING INDUSTRY, CAR MANUFACTURING AND TELEMETRY SEGMENTS, ALL RECORDED MAGNETICALLY, OPTICALLY AND ELECTRONICALLY RECORDED ON CDS, DVDS AND DOWNLOADABLE AUDIO FILES; DOWNLOADABLE ELECTRONIC PUBLICATIONS, NAMELY, NEWSLETTERS, TECHNICAL INSTRUCTION MANUAL, JOURNALS, AND MAGAZINES IN THE FIELDS OF TELECOMMUNICATIONS, COMPUTER OPERATING SYSTEMS, THE SOFTWARE COMPUTING INDUSTRY, CAR MANUFACTURING AND TELEMETRY SEGMENTS (U.S. CLS. 21, 23, 26, 36 AND 38).

CLASS 38—COMMUNICATION

FOR COMMUNICATION SERVICES PROVIDED VIA COMPUTER TERMINALS TRANSMITTING ANY TYPE OF DATA ACQUIRED AND PROCESSED BY THE TERMINALS, NAMELY, DATA, AUDIO, VIDEO, FILES, PICTURES; COMMUNICATIONS VIA COMPUTER TERMINALS; SERVICES FOR MULTIMEDIA COMMUNICATION AND FOR DIGITAL COMMUNICATIONS, NAMELY, DISTRIBUTION, ELECTRONIC TRANSMISSION AND INTERACTIVE AND NON-INTERACTIVE RECEPTION OF VOICE, DATA, IMAGES, PAGED MESSAGES, FAXES AND INFORMATION, TRANSMISSION AND RECEPTION OF AUDIO DATA ON AN INTERNET NETWORK; TELECOMMUNICATIONS USING GLOBAL COMPUTER NETWORKS PROVIDING INFORMATION IN THE FIELD OF TELECOMMUNICATION, RADIO COMMUNICATION, RADIO PAGING, TELEPHONY, RADIOTELEPHONY, BROADCASTING, TRANSMISSION AND DISTRIBUTION OF SOUNDS, STILL AND ANIMATED IMAGES, DATA, MESSAGES VIA A GLOBAL TELECOMMUNICATIONS NETWORK, NAMELY, THE INTERNET OR A PRIVATE ACCESS NETWORK, NAMELY, INTRANET; FACSIMILE TRANSMISSION; PROVIDING OF INFORMATION RELATING TO TELECOMMUNICATIONS, RADIO-COMMUNICATION, RADIO PAGING, TELEPHONY, WIRELESS TELEPHONY, MOBILE RADIOTELEPHONY SERVICES, RADIO BROADCASTING, DISTRIBUTION AND TRANSMISSION OF SOUNDS OR IMAGES, OF STILL OR ANIMATED IMAGES, OF DATA AND OF MESSAGES; PROVIDING ACCESS TO GLOBAL COMMUNICATION NETWORKS (SUCH AS THE INTERNET) OR A PRIVATE ACCESS NETWORK (SUCH AS AN INTRANET); RENTAL OF COMMUNICATION TERMINALS, MODEMS; CONSULTING SERVICES REGARDING COMPUTERS, SOFTWARE, TELECOMMUNICATION, RADIO COMMUNICATION, RADIO PAGING, TELEPHONY, WIRELESS TELEPHONY, RADIO BROADCASTING, DISTRIBUTION AND TRANSMISSION OF SOUNDS OR IMAGES, OF STILL OR ANIMATED IMAGES, OF DATA AND OF MESSAGES; SERVICES PROVIDING ACCESS TO AN INTERNET SITE FOR THE PURPOSE OF DOWNLOADING SOFTWARE, SOUNDS, STILL OR ANIMATED IMAGES, OF DATA, MESSAGES; RENTAL OF ACCESS TIME TO DATA BASE SERVER CENTERS ON A GLOBAL COMPUTER INFORMATION NETWORK; PROVIDING ACCESS TO A GLOBAL COMPUTER NETWORK CONTAINING WEBSITES OF

OTHERS FOR DOWNLOADING SOFTWARE, COMPUTER GAMES SOFTWARE, SOUNDS, STILL OR ANIMATED IMAGES, OF DATA, MESSAGES ON THE INTERNET WEB SITE; TELECONFERENCING SERVICES, NAMELY, VIDEO CONFERENCE, CONFERENCE CALL SERVICES; SERVICES PROVIDING DISCUSSION GROUPS AND INSTANTANEOUS MESSAGING ON THE INTERNET, NAMELY, FORUMS; TRANSMISSION OF PUBLICATIONS ONLINE, NAMELY, INFORMATION BOOKLETS, CATALOGUES, RELATING TO COMPUTING AND NEW INFORMATION TECHNOLOGIES (U.S. CLS. 100, 101 AND 104).

CLASS 41—EDUCATION AND ENTERTAINMENT

FOR EDUCATIONAL SERVICES, NAMELY, TEACHING COURSES OF INSTRUCTION, PROVIDING CORRESPONDENCE COURSES, AND PROVIDING PRACTICAL TRAINING FEATURING DEMONSTRATIONS ALL IN THE FIELD OF TELECOMMUNICATIONS, OPERATING SYSTEM INDUSTRY, SOFTWARE DEVELOPMENT, TEST AND DEBUG, SOFTWARE COMPUTING INDUSTRY, CAR MANUFACTURING AND TELEMETRY SEGMENTS; ARRANGING AND CONDUCTING PRACTICAL TRAINING, TRAINING WORKSHOPS IN THE FIELD OF SOFTWARE DEVELOPMENT, TEST, DEBUG, SECURE, DOWNLOAD, IN VOLUME, UPGRADE AND UPDATE OF SOFTWARE ON FIELD; ARRANGING AND CONDUCTING OF COLLOQUIUMS, EXHIBITIONS, CONFERENCES, CONVENTIONS IN THE FIELD OF SOFTWARE DEVELOPMENT, TEST, DEBUG, SECURE, DOWNLOAD, IN VOLUME, UPGRADE AND UPDATE OF SOFTWARE ON FIELD; ARRANGING AND CONDUCTING OF COMPETITIONS (EDUCATION OR ENTERTAINMENT); ORGANIZATION AND CONDUCTING OF EDUCATIONAL TESTS; EDUCATION IN THE NATURE OF PRACTICAL TRAINING FEATURING DEMONSTRATION IN THE FIELD OF SOFTWARE USE, DESIGN AND DEVELOPMENT; PRACTICAL TRAINING FEATURING DEMONSTRATION IN THE FIELD OF TELECOMMUNICATIONS, TELECOMMUNICATIONS VIA GLOBAL COMPUTER NETWORKS, COMPUTING, PROGRAMMING, DEVELOPING, INSTALLING, OPERATING, MANAGING AND MAINTAINING SOFTWARE AND COMPUTERS; ARRANGING AND CONDUCTING OF COLLOQUIUMS, CONFERENCES, CONVENTIONS, PRACTICAL TRAINING WORKSHOPS FEATURING DEMONSTRATION IN THE FIELD OF PROGRAMMING, DEVELOPING, INSTALLING, OPERATING, MANAGING AND MAINTAINING SOFTWARE AND COMPUTERS (U.S. CLS. 100, 101 AND 107).

CLASS 42—SCIENTIFIC AND COMPUTER SERVICES

FOR CONSULTING SERVICES IN THE FIELD OF GLOBAL COMPUTER NETWORKS, COMPUTER SYSTEMS, COMMUNICATIONS EQUIPMENT, COMPUTING TECHNOLOGIES SERVICES OF ENGINEERS NAMELY CONDUCTING ENGINEERING STUDIES AND SURVEYS FOR OTHERS WITH REGARD TO OPERATING SYSTEMS, ADMINISTRATION OF NETWORKS, MONITORING AND ANALYSIS OF OPERATIONS, OF SECURITY TO PREVENT ILLEGAL ACCESS TO THE NETWORK AND SERVICES FOR DEVELOPING SOFTWARE NAMELY TECHNICAL RESEARCH, DEVELOPMENT AND UPDATING OF; COMPUTING SERVICES, NAMELY, COMPUTER CONSULTING, TECHNICAL COMPUTER CONSULTING, DESIGN, DEVELOPMENT AND UPDATING OF INTEGRATED CIRCUITS, PRINTED CIRCUITS, APPARATUS AND INSTALLATIONS FOR TELECOMMUNICATION, RADIO-COMMUNICATION, RADIO PAGING, TELEPHONY, WIRELESS TELEPHONY, RADIO BROADCASTING AND TRANSMISSION OF SOUNDS OR IMAGES, OF STILL OR ANIMATED IMAGES, OF DATA AND OF MESSAGES; HOSTING SERVICES FOR WEB SITES; DESIGN AND DEVELOPMENT OF SOFTWARE, COMPUTING AND TELECOMMUNICATIONS EQUIPMENT; CONDUCTING COMPUTER ENGINEERING STUDIES FOR OTHERS, INSTALLATION OF COMPUTER SOFTWARE PROGRAMMING, RENTAL OF COMPUTER SOFTWARE, MAINTENANCE OF COMPUTER SOFTWARE, COMP-

TER SOFTWARE UPDATES, COMPUTER PROGRAMMING; REMOTE AND ON-SITE MANAGEMENT OF SERVICES FOR HOSTING WEB SITES AND, REMOTE AND ON-SITE MANAGEMENT OF ELECTRONIC MESSAGING FOR OTHERS, FOR SECURE MESSAGING; SCIENTIFIC AND INDUSTRIAL RESEARCH RELATING TO NEW INFORMATION TECHNOLOGIES, NAMELY, RESEARCH AND DEVELOPMENT OF NEW PRODUCTS, TECHNICAL RESEARCH IN THE FIELD OF TELECOMMUNICATION, COMPUTING TECHNOLOGIES; PATENT EXPLOITATION, NAMELY, GRANTING PATENT LICENSES (U.S. CLS. 100 AND 101).

SHAILA SETTLES, EXAMINING ATTORNEY

SN 79-041,304. JOHNSON MATTHEY PUBLIC LIMITED COMPANY, LONDON, UNITED KINGDOM, FILED 6-22-2007.

HISPEC

OWNER OF INTERNATIONAL REGISTRATION 0931410 DATED 6-22-2007, EXPIRES 6-22-2017.
OWNER OF U.S. REG. NO. 3,023,915.

CLASS 1—CHEMICALS

FOR CATALYSTS FOR CHEMICAL AND ELECTROCHEMICAL PROCESSES; SUPPORTED CATALYSTS AND CATALYST SUSPENSIONS FOR CHEMICAL AND ELECTROCHEMICAL PROCESSES; CATALYSTS FOR SENSORS AND FUEL CELLS; CATALYZED COMPONENTS, NAMELY, CATALYST-COATED ION-CONDUCTING MEMBRANES IN CHEMICAL FORM FOR INCORPORATION INTO FUEL CELLS; ION-CONDUCTING MEMBRANES IN SOLID CHEMICAL FORM; CATALYZED ION-CONDUCTING MEMBRANES IN SOLID CHEMICAL FORM (U.S. CLS. 1, 5, 6, 10, 26 AND 46).

CLASS 9—ELECTRICAL AND SCIENTIFIC APPARATUS

FOR FUEL CELLS AND FUEL CELL COMPONENTS, NAMELY, ELECTRODES, CATALYZED ELECTRODES, GAS DIFFUSION ELECTRODES, MEMBRANE ELECTRODE ASSEMBLIES (U.S. CLS. 21, 23, 26, 36 AND 38).
SARA THOMAS, EXAMINING ATTORNEY

SN 79-042,050. OPTEK-DANULAT GMBH, FED REP GERMANY, FILED 6-14-2007.

PRIORITY DATE OF 2-28-2007 IS CLAIMED.
OWNER OF INTERNATIONAL REGISTRATION 0933171 DATED 6-14-2007, EXPIRES 6-14-2017.
OWNER OF U.S. REG. NOS. 2,041,931, 2,897,797 AND OTHERS.

CLASS 9—ELECTRICAL AND SCIENTIFIC APPARATUS

FOR MEASURING DEVICES AND MEASURING INSTRUMENTS AND MEASURING SYSTEMS IN THE FIELD OF PHOTOMETRY, NAMELY, PHOTOMETERS AND CONDUCTIVITY METERS; MEASURING INSTRUMENTS IN THE FIELD OF PHOTOMETRY, NAMELY, HAZE, COLOR, UV-ABSORPTION, TRANSMISSION, PH, CONDUCTIVITY AND CONCENTRATION MEASURING SENSORS; IN-LINE MEASURING INSTRUMENTS AND DEVICES IN THE FIELD OF PHOTOMETRY, NAMELY NON-MEDICAL TESTERS OF VOLTAGE AND AMPERAGE; SIGNAL CONDITIONING AND COMMUNICATION DEVICES FOR INDUSTRIAL PROCESS CONTROL; REPLACEMENT PARTS FOR THE AFOREMENTIONED GOODS; ACCESSORIES FOR THE AFOREMENTIONED GOODS, NAMELY, ABSORPTION PROBES, TURBIDIMETERS, ELECTRICAL CONNECTORS, HOUSINGS FOR CONVERTERS, CONNECTION CABLES, SENSOR SIMULATORS, VALIDATION ADAPTERS, REFERENCE FILTERS, ADAPTERS, FUSES, PH ELECTRODES, SOLUTION GROUND CALIBRATION PIN FOR CALIBRATION OF PH ELECTRODES, DETECTOR MODULES FOR DETECTING LIGHT; FLANGES, GASKETS, SCREWS, CURVETTES, MOUNTING KITS FOR THE ABOVE LISTED ACCESSORIES, WELD-IN PORTS, TURBIDITY STANDARD SOLUTIONS, WINDOWS FOR USE WITH SENSOR BODIES, LAMP MODULES FOR PHOTOMETRIC INSTRUMENTS, ALL SOLD AS A UNIT WITH THE ABOVE LISTED ACCESSORIES (U.S. CLS. 21, 23, 26, 36 AND 38).

CLASS 42—SCIENTIFIC AND COMPUTER SERVICES

FOR ENGINEERING SERVICES AND TECHNOLOGY CONSULTATION IN THE FIELD OF PHOTOMETRY AND MEASUREMENT AND ANALYSIS OF LIGHT AND ELECTRIC SIGNALS (U.S. CLS. 100 AND 101).
SUZANNE BLANE, EXAMINING ATTORNEY

SN 79-042,356. BONNE PIOCHE PRODUCTIONS, FRANCE, FILED 1-29-2007.

THE FOX AND THE CHILD

THE MARK CONSISTS OF STANDARD CHARACTERS WITHOUT CLAIM TO ANY PARTICULAR FONT, STYLE, SIZE, OR COLOR.

OWNER OF INTERNATIONAL REGISTRATION 0933837 DATED 1-29-2007, EXPIRES 1-29-2017.

CLASS 9—ELECTRICAL AND SCIENTIFIC APPARATUS

FOR FILM, NAMELY, CINEMATOGRAPHIC FILM; FIRE EXTINGUISHERS; COMPUTER GAMES SOFTWARE; ELECTRIC WIRES, ELECTRIC RELAYS; COMBINATION DIVING SUITS, GLOVES AND MASKS; SPECTACLE CASES; JUMPING SHEETS AS LIFE-SAVING APPARATUS, NAMELY, SHEETS FOR CATCHING JUMPERS (U.S. CLS. 21, 23, 26, 36 AND 38).

CLASS 16—PAPER GOODS AND PRINTED MATTER

FOR STATIONERY; ADHESIVES GLUES FOR STATIONERY AND HOUSEHOLD PURPOSES; POSTERS; POSTCARDS; NEWSPAPERS; CALENDARS, TABLE LINEN, BAGS AND SACHETS FOR PACKAGING IN THE NATURE OF ENVELOPES AND POUCHES, ALL OF PAPER (U.S. CLS. 2, 5, 22, 23, 29, 37, 38 AND 50).

CLASS 18—LEATHER GOODS

FOR TRUNKS AND SUITCASES, UMBRELLAS, PARASOLS AND WALKING STICKS, HANDBAGS; BAGS FOR CLIMBERS, BAGS FOR CAMPERS, TRAVELING BAGS, BEACH BAGS, SCHOOL BAGS; BAGS OR SMALL BAGS IN THE NATURE OF ENVELOPES, POUCHES, FOR PACKAGING, MADE OF LEATHER (U.S. CLS. 1, 2, 3, 22 AND 41).

CLASS 21—HOUSEWARES AND GLASS

FOR BOTTLES SOLD EMPTY; WORKS OF ART MADE OF PORCELAIN, TERRA-COTTA OR GLASS; REFUSE BINS; DRINKING GLASSES (U.S. CLS. 2, 13, 23, 29, 30, 33, 40 AND 50).

CLASS 25—CLOTHING

FOR BELTS; GLOVES; SCARVES, TIES, HOSIERY, SOCKS, SLIPPERS; BEACH, SKI OR SPORTS FOOTWEAR; TEXTILE NAPPIES, UNDERWEAR (U.S. CLS. 22 AND 39).

CLASS 28—TOYS AND SPORTING GOODS

FOR DECORATIONS FOR CHRISTMAS TREES, EXCEPT LIGHTING ARTICLES; FISHING TACKLE; BALLS FOR GAMES AND PLAY BALLOONS; PLAYING CARDS AND BOARD GAMES; ICE AND ROLLER SKATES; TOY SCOOTERS; SURF BOARDS AND WINDSURFING BOARDS; SNOW SHOES (U.S. CLS. 22, 23, 38 AND 50).

CLASS 41—EDUCATION AND ENTERTAINMENT

FOR PROVIDING INFORMATION ON EDUCATIONAL OR ENTERTAINMENT EVENTS; PROVIDING RECREATION FACILITIES; PUBLICATION OF BOOKS; ANIMAL TRAINING; MOVIE FILM PRODUCTION; RENTAL OF SOUND RECORDINGS; VIDEOTAPE EDITING; PHOTOGRAPHIC SERVICES; ORGANIZATION OF EXHIBITIONS CULTURAL OR EDUCATIONAL PURPOSE, NAMELY, FOR ENTERTAINMENT AND EDUCATION; ELECTRONIC PUBLISHING OF ONLINE BOOKS AND PERIODICALS; DESKTOP PUBLISHING (U.S. CLS. 100, 101 AND 107).

REBECCA POVARCHUK, EXAMINING ATTORNEY

SN 79-042,397. INVENSYS PLC, LONDON SW1E 5BF, UNITED KINGDOM, FILED 6-22-2007.



PRIORITY DATE OF 1-29-2007 IS CLAIMED.
OWNER OF INTERNATIONAL REGISTRATION 0933953
DATED 6-22-2007, EXPIRES 6-22-2017.

OWNER OF U.S. REG. NOS. 2,715,842 AND 2,715,843.
NO CLAIM IS MADE TO THE EXCLUSIVE RIGHT TO USE "RAIL GROUP", APART FROM THE MARK AS SHOWN.

THE STIPPLING IS A FEATURE OF THE MARK.

CLASS 9—ELECTRICAL AND SCIENTIFIC APPARATUS

FOR ELECTRICAL AND ELECTRONIC APPARATUS FOR CONTROL OR SUPERVISION OF RAILWAY VEHICLES; ELECTRICAL AND ELECTRONIC APPARATUS FOR USE IN RAILWAY SIGNALING; ELECTRICAL AND ELECTRONIC COMMUNICATION APPARATUS FOR USE IN RAILWAY SIGNALING OR FOR THE CONTROL OR SUPERVISION OF RAILWAY VEHICLES; ELECTRICAL AND ELECTRONIC AUTOMATIC TRAIN PROTECTION APPARATUS; ELECTRICAL AND ELECTRONIC AUTOMATIC TRAIN OPERATION APPARATUS; ELECTRICAL AND ELECTRONIC AUTOMATIC TRAIN REGULATION APPARATUS; ELECTRICAL AND ELECTRONIC TRACKSIDE APPARATUS AND TRAIN MOUNTED APPARATUS FOR CONTROLLING RAILWAY VEHICLES; COMMUNICATION APPARATUS FOR COMMUNICATING DATA BETWEEN TRACKSIDE APPARATUS OR A CONTROL CENTRE AND RAILWAY VEHICLES; ELECTRICAL AND ELECTRONIC INTERLOCKING APPARATUS FOR USE IN RAILWAY SYSTEMS; ELECTRICAL AND ELECTRONIC RAILWAY POINTS OPERATING MACHINES; ELECTRICAL AND ELECTRONIC RAILWAY POINTS CONDITION MONITORING APPARATUS; RAILWAY SIGNAL LIGHTS; ELECTRICAL AND ELECTRONIC RAILWAY VEHICLE DETECTION APPARATUS; ELECTRICAL AND ELECTRONIC RAILWAY LEVEL CROSSING APPARATUS; ELECTRICAL AND ELECTRONIC RAILWAY VEHICLE DETECTION APPARATUS FOR USE IN RAILWAY LEVEL CROSSING SYSTEMS; COMPUTER SOFTWARE FOR USING AND CONTROLLING ALL THE AFORESAID GOODS AND ELECTRICAL AND ELECTRONIC PARTS FOR ALL THE AFORESAID GOODS (U.S. CLS. 21, 23, 26, 36 AND 38).

CLASS 37—CONSTRUCTION AND REPAIR

FOR INSTALLATION SERVICES, MAINTENANCE SERVICES, REPAIR SERVICES, ALL RELATING TO RAILWAYS, RAILWAY SYSTEMS OR RAILWAY VEHICLES (U.S. CLS. 100, 103 AND 106).

CLASS 42—SCIENTIFIC AND COMPUTER SERVICES

FOR DESIGN SERVICES; CONSULTANCY SERVICES IN THE FIELD OF DESIGN AND DEVELOPMENT OF RAILWAY SYSTEMS AND EQUIPMENT; CONSULTANCY SERVICES IN THE FIELD OF SOFTWARE; TECHNOLOGICAL CONSULTATION IN THE FIELD OF COMPUTER HARDWARE SYSTEMS; ENGINEERING PROJECT MANAGEMENT SERVICES; COMPUTER PROJECT MANAGEMENT SERVICES; SOFTWARE DESIGN SERVICES; ALL RELATING TO RAILWAYS, RAILWAY SYSTEMS OR RAILWAY VEHICLES (U.S. CLS. 100 AND 101).

NORA BUCHANAN WILL, EXAMINING ATTORNEY

SN 79-042,641. QUESTBACK AS, NORWAY, FILED 6-19-2007.

ASK & ACT

THE MARK CONSISTS OF STANDARD CHARACTERS WITHOUT CLAIM TO ANY PARTICULAR FONT, STYLE, SIZE, OR COLOR.

PRIORITY DATE OF 2-15-2007 IS CLAIMED.
OWNER OF INTERNATIONAL REGISTRATION 0934573
DATED 6-19-2007, EXPIRES 6-19-2017.

CLASS 9—ELECTRICAL AND SCIENTIFIC APPARATUS

FOR SOFTWARE FOR DISTRIBUTING WEB BASED QUESTIONNAIRES AND GATHERING OF DATA, WEB BASED DIALOGUE AND FEEDBACK RELATED TO CONDUCTING WEB BASED SURVEYS (U.S. CLS. 21, 23, 26, 36 AND 38).

CLASS 35—ADVERTISING AND BUSINESS

FOR CONSULTANCY, NAMELY, ADVISORY SERVICES RELATED TO WEB-BASED COMPILING AND ANALYZING IN THE FIELD OF WEB-BASED SURVEYS; MARKETING RESEARCH (U.S. CLS. 100, 101 AND 102).

CLASS 38—COMMUNICATION

FOR COMMUNICATIONS BY COMPUTER TERMINALS; TRANSFERRING MESSAGES BETWEEN INDIVIDUALS VIA TELECOMMUNICATIONS, NAMELY, MESSAGES RELATED TO QUESTIONNAIRES, REPORTS, SURVEYS AND FEEDBACK RELATED TO CONDUCTING WEB-BASED SURVEYS (U.S. CLS. 100, 101 AND 104).

CLASS 42—SCIENTIFIC AND COMPUTER SERVICES

FOR INDUSTRIAL ANALYSIS, NAMELY, COMPUTER SYSTEMS ANALYSIS, ANALYSIS OF SURVEY METHODOLOGIES, AND ANALYTICAL SERVICES RELATED TO GATHERING, MANAGING, EVALUATING AND PROCESSING INFORMATION IN THE FIELD OF QUESTIONNAIRES, REPORTS, SURVEYS AND FEEDBACK RELATED TO CONDUCTING WEB BASED SURVEYS; DESIGN, NAMELY, COMPUTER NETWORK DESIGN FOR OTHERS AND COMPUTER SOFTWARE DESIGN FOR OTHERS; DEVELOPMENT OF SOFTWARE (U.S. CLS. 100 AND 101).

SUZANNE BLANE, EXAMINING ATTORNEY

CLASS 9—ELECTRICAL AND SCIENTIFIC APPARATUS

FOR APPARATUS FOR RECORDING, TRANSMISSION AND REPRODUCTION OF SOUND AND IMAGES; PRE-RECORDED COMPACT DISKS BEING READ-ONLY MEMORY FEATURING COMPUTER GAMES, PRE-RECORDED COMPACT DISKS FOR AUDIO-VIDEO CONTENT, NAMELY, PRE-RECORDED COMPACT DISKS FEATURING COMPUTER GAMES; PRE-RECORDED AND DOWNLOADABLE COMPUTER PROGRAMS FOR USE IN DATABASE MANAGEMENT AND FOR USE IN INTERACTIVE COMPUTER GAMES; DOWNLOADABLE ELECTRONIC PUBLICATIONS IN THE NATURE OF MAGAZINES AND BOOKS FEATURING EQUIVATION; EXPOSED CINEMATOGRAPHIC FILMS; BLANK MAGNETIC COMPUTER TAPES FOR USE IN DATABASE MANAGEMENT, PRE-RECORDED MAGNETIC COMPUTER TAPES FEATURING COMPUTER SOFTWARE FOR USE IN DATABASE MANAGEMENT; PRE-RECORDED MAGNETIC DATA PROCESSING MEDIA IN THE NATURE OF COMPACT DISKS FEATURING SOFTWARE FOR USE IN DATABASE MANAGEMENT; GAME PROGRAMS FOR COMPUTER; VIDEO GAMES AS ACCESSORY DEVICES FOR TV SETS; VIDEO GAME CASSETTES (U.S. CLS. 21, 23, 26, 36 AND 38).

CLASS 28—TOYS AND SPORTING GOODS

FOR GAMES, NAMELY, BOARD GAMES, CARD GAMES, JIGSAW PUZZLES, ARCADE GAMES; TOYS, NAMELY, PLUSH TOYS, SOFT SCULPTURE TOYS, MUSIC BOX TOYS, ACTION FIGURES, INFANT TOYS, STUFFED TOY ANIMALS (U.S. CLS. 22, 23, 38 AND 50).

CLASS 42—SCIENTIFIC AND COMPUTER SERVICES

FOR DEVELOPMENT AND DESIGN OF SOFTWARE (U.S. CLS. 100 AND 101).

DEBRA LEE, EXAMINING ATTORNEY

SN 79-043,359. L'ATELIER DES CHEFS, FRANCE, FILED 4-30-2007.

SN 79-043,004. DTP LIZENZ- UND RECHTE GMBH, FED REP GERMANY, FILED 5-29-2007.



OWNER OF INTERNATIONAL REGISTRATION 0935464 DATED 5-29-2007, EXPIRES 5-29-2017.

NO CLAIM IS MADE TO THE EXCLUSIVE RIGHT TO USE "RIDING", APART FROM THE MARK AS SHOWN.

THE COLOR(S) RED AND GOLD AND BLACK IS/ARE CLAIMED AS A FEATURE OF THE MARK.

THE COLOR RED APPEARS ON THE RIBBON, THE COLOR GOLD APPEARS ON THE WORDING "RIDING STAR", AND THE COLOR BLACK APPEARS AS OUTLINING AND SHADING ON THE RIBBON AND WORDING.



OWNER OF INTERNATIONAL REGISTRATION 0936318 DATED 4-30-2007, EXPIRES 4-30-2017.

NO CLAIM IS MADE TO THE EXCLUSIVE RIGHT TO USE "L'ATELIER DES CHEFS" AS TO CLASS 41, APART FROM THE MARK AS SHOWN.

THE COLOR(S) RED, WHITE AND BLACK IS/ARE CLAIMED AS A FEATURE OF THE MARK.

THE MARK CONSISTS OF A WHITE CHEF'S HAT IN FRONT OF THE LETTER "C" IN BLACK; A RED CIRCLE BACKGROUND APPEARS WITH THE WORDING "L'ATELIER DES CHEFS" ALONG THE PERIMETER IN WHITE.

THE ENGLISH TRANSLATION OF THE WORD "L'ATELIER DES CHEFS" IN THE MARK IS CHEF'S WORKSHOP.

CLASS 41—EDUCATION AND ENTERTAINMENT

FOR VIDEOTAPING; RENTAL OF VIDEOTAPES; EDITING OF VIDEOTAPES, VIDEOTAPE AND MOTION PICTURE FILM PRODUCTION; RENTAL OF MOTION PICTURES; ENTERTAINMENT, NAMELY, ORGANIZATION OF CULINARY COMPETITIONS, ORGANIZATION OF EXHIBITIONS FOR COOKING PURPOSES, ORGANIZATION OF LIVE SHOW PERFORMANCES IN THE FIELD OF FOOD PREPARATION; ENTERTAINMENT INFORMATION, NAMELY, PROVIDING INFORMATION ON THE ORGANIZATION OF CULINARY COMPETITIONS, THE ORGANIZATION OF EXHIBITIONS FOR COOKING PURPOSES, THE ORGANIZATION OF LIVE SHOW PERFORMANCES IN THE FIELD OF FOOD PREPARATION; RADIO ENTERTAINMENT, NAMELY, SHOWS IN CONNECTION WITH COOKING, RECIPE CREATION, GASTRONOMY, TABLE ARTS, CULINARY ARTS, NUTRITION AND OENOLOGY; TELEVISION ENTERTAINMENT, NAMELY, SHOWS IN CONNECTION WITH COOKING, RECIPE CREATION, GASTRONOMY, TABLE ARTS, CULINARY ARTS, NUTRITION AND OENOLOGY; EDUCATION, NAMELY, PROVIDING CLASSES, SEMINARS, WORKSHOPS, TEACHING AND THEORETICAL OR PRACTICAL VOCATIONAL TRAINING IN THE FIELDS OF GASTRONOMY, TABLE ARTS, CULINARY ARTS, NUTRITION AND OENOLOGY, AND DISTRIBUTING COURSE MATERIALS IN CONNECTION THEREWITH, PROVIDING ADVANCED TRAINING COURSES IN COOKING, AND ORGANIZATION OF CULINARY COMPETITIONS; EDUCATION IN THE FIELDS OF GASTRONOMY, TABLE ARTS, CULINARY ARTS, NUTRITION AND OENOLOGY RENDERED THROUGH CORRESPONDENCE COURSES; TUITION, NAMELY, PROVIDING FOR TRAINING COURSES IN THE GASTRONOMY, TABLE ARTS, CULINARY ARTS, NUTRITION AND OENOLOGY; PROVIDING ONLINE COMPUTER GAMES IN CONNECTION WITH COOKING, RECIPE CREATION, GASTRONOMY, TABLE ARTS, CULINARY ARTS, NUTRITION AND OENOLOGY; PUBLICATION OF BOOKS; RENTAL OF AUDIO EQUIPMENT, RENTAL OF LIGHTING APPARATUS FOR THEATRICAL SETS OR TELEVISION STUDIOS; RENTAL OF MOVIE PROJECTORS AND ACCESSORIES, RENTAL OF SOUND RECORDINGS, RENTAL OF VIDEO CAMERAS; DESKTOP PUBLISHING FOR OTHERS; MICROFILMING FOR OTHERS; ARRANGING AND CONDUCTING PROFESSIONAL TRAINING WORKSHOPS; ARRANGING AND CONDUCTING OF EDUCATIONAL AND ENTERTAINMENT COLLOQUIES, CONFERENCES, CONVENTIONS, SYMPOSIUMS AND SEMINARS, ALL IN THE FIELDS OF FOOD, GASTRONOMY, TABLE ARTS, CULINARY ARTS, NUTRITION AND OENOLOGY; CAREER COUNSELING; AMUSEMENT PARKS; PUBLICATION OF BOOKS, ELECTRONIC PUBLISHING OF ONLINE BOOKS AND PERIODICALS; SCRIPTWRITING SERVICES; ORGANIZATION AND PRODUCTION OF TELEVISION SHOWS AND LIVE SHOW PERFORMANCES, NAMELY, SHOWS IN CONNECTION WITH COOKING, RECIPE CREATION, GASTRONOMY, TABLE ARTS, CULINARY ARTS, NUTRITION AND OENOLOGY; PRESENTATION OF LIVE SHOW PERFORMANCES; BOOKING OF SEATS FOR SHOWS; TRANSLATION SERVICES; EDITING OF RADIO AND TELEVISION PROGRAMS; PROVIDING INFORMATION RELATED TO THE TEACHING AND THEORETICAL OR PRACTICAL VOCATIONAL TRAINING IN THE FIELDS OF GASTRONOMY, TABLE ARTS, CULINARY ARTS, NUTRITION AND OENOLOGY, AND PROVIDING INFORMATION RELATED TO ADVANCED TRAINING COURSES IN COOKING; PUBLICATION OF TEXTS, EXCEPT ADVERTISING TEXTS (U.S. CLS. 100, 101 AND 107).

CLASS 43—HOTEL AND RESTAURANT SERVICES

FOR BAR AND COFFEE SHOP SERVICES, CAFETERIAS, HOTEL SERVICES, SNACK-BARS, CATERING SERVICES, RESTAURANT SERVICES; FOOD PREPARATION SERVICES (U.S. CLS. 100 AND 101).
BERNICE MIDDLETON, EXAMINING ATTORNEY

SN 79-043,635. RIBO ROBERT, FRANCE, FILED 8-10-2007.



PRIORITY DATE OF 2-15-2007 IS CLAIMED.
OWNER OF INTERNATIONAL REGISTRATION 0936921 DATED 8-10-2007, EXPIRES 8-10-2017.

NO CLAIM IS MADE TO THE EXCLUSIVE RIGHT TO USE "SYSTÈME", APART FROM THE MARK AS SHOWN.

THE COLOR(S) BLUE, YELLOW AND GREY IS/ARE CLAIMED AS A FEATURE OF THE MARK.

THE MARK CONSISTS OF THE TERMS "SYSTÈME RIBO" IN BLUE, ABOVE A GREY UNDERLINING IN THE FORM OF A WAVE, WITH A SIX-PETAL FLOWER IN YELLOW APPEARING WITHIN THE LETTER "O" OF THE TERM "RIBO".

THE ENGLISH TRANSLATION OF "SYSTÈME" IS SYSTEM.

CLASS 11—ENVIRONMENTAL CONTROL APPARATUS

FOR GLOBAL INSTALLATIONS FOR CLIMATIZATION, HEATING AND AIR CONDITIONING IN PREMISES, NAMELY, MULTIPURPOSE CLIMATE CONTROL APPARATUS AND MULTIPURPOSE AIR CONDITIONING APPARATUS CONSISTING OF APPARATUS DESIGNED FOR THE HEATING, COOLING, VENTILATION AND FILTRATION OF AMBIENT AIR IN PREMISES (U.S. CLS. 13, 21, 23, 31 AND 34).

CLASS 42—SCIENTIFIC AND COMPUTER SERVICES

FOR ENGINEER'S SERVICES IN THE FIELD OF CLIMATIZATION, HEATING AND AIR CONDITIONING IN PREMISES; TECHNICAL PROJECT STUDIES IN THE FIELD OF CLIMATIZATION, HEATING AND AIR CONDITIONING OF PREMISES, NAMELY, DESIGN OF MULTIPURPOSE CLIMATE CONTROL APPARATUS AND OF MULTIPURPOSE AIR CONDITIONING APPARATUS CONSISTING OF APPARATUS DESIGNED FOR THE HEATING, COOLING, VENTILATION AND FILTRATION OF AMBIENT AIR IN PREMISES; TECHNICAL PROJECT STUDIES IN THE FIELD OF CLIMATIZATION, HEATING AND AIR CONDITIONING OF PREMISES, NAMELY, RESEARCH IN THE FIELD OF MULTIPURPOSE CLIMATE CONTROL APPARATUS AND OF MULTIPURPOSE AIR CONDITIONING APPARATUS CONSISTING OF APPARATUS DESIGNED FOR THE HEATING, COOLING, VENTILATION AND FILTRATION OF AMBIENT AIR IN PREMISES; DRAFTING OF CONSTRUCTION PLANS FOR SETTING UP MULTIPURPOSE CLIMATE CONTROL APPARATUS AND MULTIPURPOSE AIR CONDITIONING APPARATUS CONSISTING OF APPARATUS DESIGNED FOR THE HEATING, COOLING, VENTILATION AND FILTRATION OF AMBIENT AIR IN PREMISES (U.S. CLS. 100 AND 101).

JAMES STEIN, EXAMINING ATTORNEY

SN 79-043,674. KTM-SPORTMOTORCYCLE AG, AUSTRIA, FILED 7-13-2007.



OWNER OF INTERNATIONAL REGISTRATION 0937019 DATED 7-13-2007, EXPIRES 7-13-2017.

THE COLOR(S) BLACK, GRAY, ORANGE, AND YELLOW IS/ARE CLAIMED AS A FEATURE OF THE MARK.

THE MARK CONSISTS OF A BLACK RECTANGLE, WITH THE LETTERS "KTM" IN THE MIDDLE OF THE BLACK RECTANGLE. THE LETTERS ARE IN BLACK WITH A GRAY BAR ACROSS THE TOP OF THE LETTER "T" AND ALSO ACROSS THE MIDDLE OF THE "KTM". THE LETTERS ARE SHADED IN ORANGE EXCEPT FOR THE RIGHT SIDE OF THE "M" WHICH IS SHADED IN YELLOW.

CLASS 7—MACHINERY

FOR RADIATORS FOR ENGINES FOR MOTOR VEHICLES; FANS AND CYLINDERS FOR MOTORS, CYLINDER HEADS (U.S. CLS. 13, 19, 21, 23, 31, 34 AND 35).

CLASS 12—VEHICLES

FOR LAND VEHICLES AND STRUCTURAL PARTS THEREFORE (U.S. CLS. 19, 21, 23, 31, 35 AND 44).

CLASS 37—CONSTRUCTION AND REPAIR

FOR MAINTENANCE AND REPAIR OF MOTOR VEHICLES; REPAIR OF MOTOR VEHICLES AND ENGINES AS WELL AS REPAIRING PARTS OF THESE PRODUCTS (U.S. CLS. 100, 103 AND 106).

SARA THOMAS, EXAMINING ATTORNEY

SN 79-043,751. KTM-SPORTMOTORCYCLE AG, AUSTRIA, FILED 7-13-2007.



OWNER OF INTERNATIONAL REGISTRATION 0937255 DATED 7-13-2007, EXPIRES 7-13-2017.

THE COLOR(S) WHITE, ORANGE, BLACK AND GREY IS/ARE CLAIMED AS A FEATURE OF THE MARK.

THE MARK CONSISTS OF THE LETTERS "KTM". THE LETTERS ARE WHITE WITH GREY BARS ACROSS THE TOP OF THE "T" AND THE MIDDLE OF THE LETTERS. THE LETTERS ARE SHADED IN BLACK AND ORANGE.

CLASS 7—MACHINERY

FOR RADIATORS FOR ENGINES FOR MOTOR VEHICLES; FANS AND CYLINDERS FOR MOTORS, CYLINDER HEADS (U.S. CLS. 13, 19, 21, 23, 31, 34 AND 35).

CLASS 12—VEHICLES

FOR LAND VEHICLES AND STRUCTURAL PARTS THEREFORE (U.S. CLS. 19, 21, 23, 31, 35 AND 44).

CLASS 37—CONSTRUCTION AND REPAIR

FOR MAINTENANCE AND REPAIR OF MOTOR VEHICLES; REPAIR OF MOTOR VEHICLES AND ENGINES AS WELL AS REPAIRING PARTS OF THESE PRODUCTS (U.S. CLS. 100, 103 AND 106).

SARA THOMAS, EXAMINING ATTORNEY

SN 79-043,837. NTN CORPORATION, JAPAN, FILED 6-28-2007.



PRIORITY DATE OF 6-25-2007 IS CLAIMED. OWNER OF INTERNATIONAL REGISTRATION 0937420 DATED 6-28-2007, EXPIRES 6-28-2017.

OWNER OF U.S. REG. NOS. 709,011, 1,437,740 AND 1,588,528.

CLASS 7—MACHINERY

FOR BALL BEARINGS FOR SHIPS AND PLANES, ROLLER BEARINGS FOR SHIPS AND PLANES, BALL BEARINGS OTHER THAN FOR LAND VEHICLES, NAMELY, FOR MACHINES, ROLLER BEARINGS OTHER THAN FOR LAND VEHICLES, NAMELY, FOR MACHINES, UNIVERSAL JOINTS OTHER THAN FOR LAND VEHICLES, NAMELY, FOR MACHINES, PULLEYS OTHER THAN FOR LAND VEHICLES, NAMELY, BEING PARTS OF MACHINES, CLUTCHES OTHER THAN FOR LAND VEHICLES, NAMELY, FOR MACHINES, SHAFT COUPLINGS OTHER THAN FOR LAND VEHICLES, VIBRATION CONVEYORS OF A RESONANCE TYPE (U.S. CLS. 13, 19, 21, 23, 31, 34 AND 35).

CLASS 12—VEHICLES

FOR BALL BEARINGS FOR USE WITH LAND VEHICLES, ROLLER BEARINGS FOR USE WITH LAND VEHICLES, AUTOMATIC TENSIONERS FOR USE WITH LAND VEHICLES, NAMELY, DEVICES THAT CONSTANTLY MAINTAIN PROPER TENSION OF TIMING BELTS, TIMING CHAINS AND ACCESSORY DRIVE BELTS, UNIVERSAL JOINTS FOR USE WITH LAND VEHICLES, PROPELLER SHAFTS FOR USE WITH LAND VEHICLES, SHAFT COUPLINGS FOR USE WITH LAND VEHICLES, BALL SCREWS FOR USE WITH LAND VEHICLES, PULLEYS FOR USE WITH LAND VEHICLES, CLUTCHES FOR USE WITH LAND VEHICLES (U.S. CLS. 19, 21, 23, 31, 35 AND 44).

THOMAS MANOR, EXAMINING ATTORNEY

SN 79-044,556. ALPHACARE MEDICAL GMBH, FED REP GERMANY, FILED 6-18-2007.



THE MARK CONSISTS OF STANDARD CHARACTERS WITHOUT CLAIM TO ANY PARTICULAR FONT, STYLE, SIZE, OR COLOR.

PRIORITY DATE OF 1-19-2007 IS CLAIMED. OWNER OF INTERNATIONAL REGISTRATION 0939355 DATED 6-18-2007, EXPIRES 6-18-2017.

CLASS 5—PHARMACEUTICALS

FOR SANITARY PREPARATIONS FOR MEDICAL PURPOSES; MEDICAL PLASTERS, GAUZE FOR DRESSINGS; MATERIAL FOR STOPPING TEETH, DENTAL WAX; ALL PURPOSE DISINFECTANTS; PREPARATIONS FOR DESTROYING VERMIN; FUNGICIDES, HERBICIDES (U.S. CLS. 6, 18, 44, 46, 51 AND 52).

CLASS 9—ELECTRICAL AND SCIENTIFIC APPARATUS

FOR APPARATUS FOR RECORDING, TRANSMISSION OR REPRODUCTION OF SOUND OR IMAGES; BLANK MAGNETIC DATA CARRIERS, BLANK RECORDING DISCS; AUTOMATIC VENDING MACHINES; CASH REGISTERS, CALCULATING MACHINES; DATA PROCESSING EQUIPMENT AND COMPUTERS; FIRE-EXTINGUISHING APPARATUS (U.S. CLS. 21, 23, 26, 36 AND 38).

CLASS 10—MEDICAL APPARATUS

FOR SURGICAL, MEDICAL, DENTAL AND VETERINARY APPARATUS AND INSTRUMENTS, NAMELY, APPARATUS FOR PREVENTING AND TREATING PRESSURE ULCERS CONSISTING OF AIR BLOWERS, CONTROL PANELS FOR SETTING AND RECORDING AIR PRESSURE, AIR MATTRESSES AND FOAM; ARTIFICIAL LIMBS, EYES AND TEETH; SUTURE MATERIALS (U.S. CLS. 26, 39 AND 44).

BARNEY CHARLON, EXAMINING ATTORNEY

SN 79-044,790. KTM-SPORTMOTORCYCLE AG, AUSTRIA, FILED 7-12-2007.



OWNER OF INTERNATIONAL REGISTRATION 0940018 DATED 7-12-2007, EXPIRES 7-12-2017.

CLASS 7—MACHINERY

FOR RADIATORS FOR ENGINES FOR MOTOR VEHICLES (U.S. CLS. 13, 19, 21, 23, 31, 34 AND 35).

CLASS 12—VEHICLES

FOR BICYCLES, MOTORCYCLES, LIGHT MOTORCYCLES, SCOOTERS, MOPEDS, AND THEIR PARTS AND ACCESSORIES, NAMELY, MOTORS FOR LAND VEHICLES, SADDLES FOR BICYCLES AND MOTORCYCLES, TIRES, WHEELS, RIMS, BRAKE LININGS, BRAKE DISCS, AERO-DYNAMIC FAIRINGS, LUGGAGE CARRIERS FOR MOTORCYCLES, CASES FOR LUGGAGE ADAPTED FOR USE WITH MOTORCYCLES, TRANSPORT CASES ADAPTED FOR USE WITH MOTORCYCLES, SADDLEBAGS ADAPTED FOR USE WITH BICYCLES AND MOTORCYCLES, TANK BAGS ADAPTED FOR USE WITH MOTORCYCLES, BICYCLE STANDS, MUDGUARDS, SPOILERS, REAR-VIEW MIRRORS, LICENSE PLATE CARRIERS, COMPETITION NUMBER PLATES, FUEL TANK CAPS, FUEL TANKS, CHAINS, FANS AND CYLINDERS FOR MOTORS, REAR SILENCERS, EXHAUST SILENCERS, MOTORCYCLE SEATS, CYLINDER HEADS, IGNITION COVERS; LAND VEHICLES AND STRUCTURAL PARTS THEREFOR (U.S. CLS. 19, 21, 23, 31, 35 AND 44).

CLASS 37—CONSTRUCTION AND REPAIR

FOR MAINTENANCE AND REPAIR OF MOTOR VEHICLES; REPAIR OF MOTOR VEHICLES AND ENGINES, AND REPAIRING PARTS OF THESE PRODUCTS (U.S. CLS. 100, 103 AND 106).

BARBARA GAYNOR, EXAMINING ATTORNEY

SN 79-044,851. VALLOUREC & MANNESMANN TUBES, FRANCE, FILED 8-31-2007.



THE MARK CONSISTS OF STANDARD CHARACTERS WITHOUT CLAIM TO ANY PARTICULAR FONT, STYLE, SIZE, OR COLOR.

PRIORITY DATE OF 3-14-2007 IS CLAIMED.

OWNER OF INTERNATIONAL REGISTRATION 0940210 DATED 8-31-2007, EXPIRES 8-31-2017.

CLASS 6—METAL GOODS

FOR HOT-MANUFACTURED TUBES OF METAL (U.S. CLS. 2, 12, 13, 14, 23, 25 AND 50).

CLASS 16—PAPER GOODS AND PRINTED MATTER

FOR PRINTED MATTER, NAMELY, PRINTED INFORMATIONAL MATERIAL, NAMELY, BROCHURES, FLYERS, LETTERS, CARDS AND FOLDERS IN THE FIELD OF HOT-MANUFACTURED METAL TUBE, METAL TREATMENT AND TREATMENT OF METAL TUBE ENDS (U.S. CLS. 2, 5, 22, 23, 29, 37, 38 AND 50).

CLASS 40—MATERIAL TREATMENT

FOR METAL TREATMENT, NAMELY, TREATMENT OF THE TUBE ENDS (U.S. CLS. 100, 103 AND 106).

ELI HELLMAN, EXAMINING ATTORNEY

SN 79-045,120. INTELLECTUAL PROPERTY HOLDINGS AS, N-0250 OSLO, NORWAY, FILED 8-1-2007.

AKER - The Preferred Partner

THE MARK CONSISTS OF STANDARD CHARACTERS WITHOUT CLAIM TO ANY PARTICULAR FONT, STYLE, SIZE, OR COLOR.

PRIORITY DATE OF 2-7-2007 IS CLAIMED.

OWNER OF INTERNATIONAL REGISTRATION 0940673 DATED 8-1-2007, EXPIRES 8-1-2017.

OWNER OF U.S. REG. NOS. 2,652,824, 3,348,694 AND OTHERS.

CLASS 7—MACHINERY

FOR OIL AND GAS PRODUCTION MACHINERY, APPARATUS BEING PARTS, EQUIPMENT, SYSTEMS OR OTHER APPARATUS OR OIL AND GAS WELL MACHINERY, NAMELY, DRILLING AND WORKOVER SYSTEMS COMPRISING DRILLING DERRICK, WORKOVER RISERS, SUBSTRUCTURES, RISERS AND RISER SYSTEMS, NAMELY, PRODUCTION RISERS, DRILLING RISERS, SERVICE/WORKOVER RISERS AND RISER CONNECTORS AND RISER HANDLING POWER TOOLS, WINCHES, WINDLASSES, CHAIN STOPPERS FOR USE IN EQUIPPING AND BUILDING SEA-GOING VESSELS AND OIL AND GAS DRILLING RIGS; OIL AND GAS WELL MACHINERY, APPARATUS BEING PARTS, EQUIPMENT, SYSTEMS OR OTHER APPARATUS OR OIL AND GAS WELL MACHINERY, NAMELY, WELLHEADS, AND CHRISTMAS TREES; SUBSEA PUMPING, COMPRESSION AND PROCESSING SYSTEMS COMPRISING SEPARATION, CRUDE OIL CONDITIONING, WATER TREATMENT AND/OR INJECTION, PUMPING/COMPRESSION, AND HEAT EXCHANGE MASS TRANSFER DEVICES FOR USE IN SUBSEA EXTRACTION, PROCESSING AND EXPORTING OF OIL AND NATURAL GAS; OIL AND GAS WELL MACHINERY, APPARATUS BEING PARTS, EQUIPMENT SYSTEMS OR OTHER APPARATUS OR OIL AND GAS WELL MACHINERY, NAMELY, WIRELINE, TRACTOR AND LOGGING PRODUCTS, COMPRISING WIRELINE TRACTOR DEVICES, FOR FUNCTIONS SUCH AS SCALE REMOVAL, MILLING/SIDE-TRACKING, SAND-BAILING, PERFORATING AND PLUG-SETTING FOR USE DOWN HOLE IN THE EXTRACTION, PROCESSING AND EXPORTING OF OIL AND NATURAL GAS; ELECTRICAL PUMPS, NAMELY, FLUIDISING PUMPS FOR MEDIUM CONSISTENCY PUMPS, CENTRIFUGAL PUMPS, LINE SHAFT PUMPS AND MULTI-PHASE PUMPS USED FOR CRUDE OIL TRANSPORTATION, FIREFIGHTING AND SEAWATER PUMPING SYSTEMS, LIFT PUMPS, LIFT CAISSONS, AND BOOSTER PUMPS; HEATERS AND HEAT EXCHANGERS BEING PARTS OF MACHINES, INERT GAS ELECTRIC GENERATORS FOR PRODUCTION OF LIQUEFIED NATURAL GAS, NATURAL GAS LIQUIDS AND PETROLEUM PRODUCTS; CONTROL MODULES, NAMELY, PUMP CONTROL VALVES FOR PRODUCTS OF COMBUSTIBLE GASES AND RECOVERY OF CHEMICALS AND FOR THE OPTIMIZATION OF SUCH PROCESSES; OIL AND GAS WELL DRILLING MACHINE AND PARTS AND FITTINGS THEREFOR (U.S. CLS. 13, 19, 21, 23, 31, 34 AND 35).

CLASS 12—VEHICLES

FOR SHIPS, FAST BOATS, SEA-GOING VESSELS, AND STRUCTURAL PARTS AND FITTINGS THEREFOR FOR USE IN EQUIPPING, BUILDING, MAINTAINING AND FITTING OUT SEA-GOING VESSELS, SHIPS AND OTHER FIXED AND FLOATING VESSELS FOR THE STORAGE AND TRANSPORTATION OF GAS (U.S. CLS. 19, 21, 23, 31, 35 AND 44).

CLASS 20—FURNITURE AND ARTICLES NOT OTHERWISE CLASSIFIED

FOR FURNITURE, MIRRORS, PICTURE FRAMES; ALL SORTS OF STORAGE, FILING AND HANDLING SOLUTIONS, NAMELY, SHELVES AND BRACKETS SOLD AS A UNIT (U.S. CLS. 2, 13, 22, 25, 32 AND 50).

CLASS 29—MEATS AND PROCESSED FOODS

FOR MEAT, FISH, POULTRY AND GAME; MEAT EXTRACTS; PRESERVED, DRIED AND COOKED FRUITS AND VEGETABLES; JELLIES, JAMS, COMPOTES; EGGS, MILK AND MILK PRODUCTS, EXCLUDING ICE CREAM, ICE MILK AND FROZEN YOGURT; EDIBLE OILS AND FATS (U.S. CL. 46).

CLASS 35—ADVERTISING AND BUSINESS

FOR ADVERTISING AND BUSINESS MANAGEMENT CONSULTANCY; BUSINESS MANAGEMENT; BUSINESS MANAGEMENT AND CONSULTATION; BUSINESS ADMINISTRATION AND MANAGEMENT; BUSINESS ADMINISTRATION AND OFFICE WORK; BUSINESS OPERATION, BUSINESS ADMINISTRATION AND OFFICE FUNCTIONS (U.S. CLS. 100, 101 AND 102).

CLASS 37—CONSTRUCTION AND REPAIR

FOR BUILDING CONSTRUCTION; BUILDING CONSTRUCTION AND REPAIR; REPAIR AND INSTALLATION SERVICES RELATING TO OFFSHORE OIL AND GAS PRODUCTION PLANTS AND ONSHORE INDUSTRIAL FACILITIES INCLUDING PLANTS FOR THE PROCESSING OF WASTE WATER AND THE PROCESSING AND MANUFACTURING OF NUCLEAR MATERIALS, PHARMACEUTICALS, METALS, POLYMERS AND CHEMICALS, OIL REFINING AND ONSHORE OIL AND GAS PROCESSING; CONSTRUCTION, MODIFICATION, REPAIR AND INSTALLATION OF PULP AND PAPER PLANTS AND OF CHEMICAL RECOVERY, POLLUTION CONTROL AND ENERGY GENERATING ENERGY PLANTS FOR USE IN THE CHEMICAL, PULP AND PAPER INDUSTRIES; CONSTRUCTION, MODIFICATION, REPAIR AND INSTALLATION OF POWER PLANTS (U.S. CLS. 100, 103 AND 106).

CLASS 40—MATERIAL TREATMENT

FOR TREATMENT OF METAL (U.S. CLS. 100, 103 AND 106).

CLASS 42—SCIENTIFIC AND COMPUTER SERVICES

FOR SCIENTIFIC RESEARCH, INDUSTRIAL RESEARCH, DEVELOPMENT OF COMPUTER PROGRAMS, DESIGN FOR OTHERS, AND TECHNOLOGICAL CONSULTATION IN THE TECHNOLOGY FIELD OF THE FOLLOWING, ALL IN THE FIELDS OF AUTOMATED DRILLING, FIXED AND FLOATED CONCRETE PLATFORM/MARINE STRUCTURE TECHNOLOGY, DOWN HOLE TECHNOLOGY, RESERVOIR TECHNOLOGY, SUBSEA TECHNOLOGY, FIXED AND FLOATING OIL AND GAS PLATFORM TECHNOLOGY, INCLUDING HULLS, JACKETS AND RISER SYSTEMS, THE PROCESSING, PUMPING, STORAGE AND TRANSPORTATION OF OIL AND GAS, PETROCHEMICAL AND BIOCHEMICAL PROCESS TECHNOLOGY, PHARMACEUTICAL TECHNOLOGY, NUCLEAR WASTE AND PUMPING TECHNOLOGY, SHIPBUILDING, SHIP AND FIXED AND FLOATING CONCRETE PLATFORM INSTRUMENTATIONS, PROCESSING FERROUS AND NON-FERROUS METALS/ORES, SEAFOOD, AND BIOMARINE PRODUCT RESEARCH (U.S. CLS. 100 AND 101).
KALIE KUNG, EXAMINING ATTORNEY

SN 79-045,224. DSM IP ASSETS B.V., NETHERLANDS, FILED 8-20-2007.

DMX-SL

THE MARK CONSISTS OF STANDARD CHARACTERS WITHOUT CLAIM TO ANY PARTICULAR FONT, STYLE, SIZE, OR COLOR.

PRIORITY DATE OF 3-13-2007 IS CLAIMED.
OWNER OF INTERNATIONAL REGISTRATION 0940910 DATED 8-20-2007, EXPIRES 8-20-2017.

CLASS 1—CHEMICALS

FOR RADIATION AND/OR THERMALLY CURABLE COATINGS OR COATING COMPOSITIONS ALL FOR USE IN SOLID IMAGING, STEREOLITHOGRAPHY AND RAPID PROTOTYPING PROCEDURES IN THE MANUFACTURING AND PROTOTYPING INDUSTRIES OR ADHESIVES USED IN INDUSTRY; RADIATION AND/OR THERMALLY CURABLE UNPROCESSED SYNTHETIC RESINS; COATING COMPOSITIONS, COATINGS, OR ADHESIVES FOR OPTICAL FIBERS AND DISPLAY MATERIALS USED IN INDUSTRY; ALL FOR USE IN SOLID IMAGING, STEREOLITHOGRAPHY AND RAPID PROTOTYPING PROCEDURES IN THE MANUFACTURING AND PROTOTYPING INDUSTRIES; UNPROCESSED SYNTHETIC RESIN COMPOSITIONS, NAMELY, COATED AND UNCOATED POWDERS, ORGANIC AND INORGANIC POWDERS, MELTABLE POLYMERS FOR EXTRUSION DEPOSITION, COMPOSITE LIQUID RESINS, LIQUID PHOTOPOLYMERS AND COMBINATIONS THEREOF, ALL FOR USE IN SOLID IMAGING, STEREOLITHOGRAPHY AND RAPID PROTOTYPING PROCEDURES IN THE MANUFACTURING AND PROTOTYPING INDUSTRIES (U.S. CLS. 1, 5, 6, 10, 26 AND 46).

CLASS 2—PAINTS

FOR RADIATION AND/OR THERMALLY CURABLE PAINTS, LACQUERS AND VARNISHES BASED ON RADIATION AND/OR THERMALLY CURABLE COATINGS ON THE BASIS OF SYNTHETIC RESINS; RADIATION AND/OR THERMALLY CURABLE PRINTING INKS; CONDUCTIVE INKS USED IN FIBER OPTIC CABLES (U.S. CLS. 6, 11 AND 16).

CAROLYN GRAY, EXAMINING ATTORNEY

SN 79-045,275. GEBRÜDER MÄRKLIN & CIE GMBH, FED REP GERMANY, FILED 9-28-2007.

MONDOLINO

THE MARK CONSISTS OF STANDARD CHARACTERS WITHOUT CLAIM TO ANY PARTICULAR FONT, STYLE, SIZE, OR COLOR.

PRIORITY DATE OF 4-3-2007 IS CLAIMED.

OWNER OF INTERNATIONAL REGISTRATION 0941112 DATED 9-28-2007, EXPIRES 9-28-2017.

THE FOREIGN WORDING IN THE MARK TRANSLATES INTO ENGLISH AS "LITTLE WORLD".

CLASS 9—ELECTRICAL AND SCIENTIFIC APPARATUS

FOR ELECTRIC CONTROL APPARATUS FOR VEHICLES, NAMELY, CONTROL APPARATUS FOR MODEL RAILWAYS (U.S. CLS. 21, 23, 26, 36 AND 38).

CLASS 16—PAPER GOODS AND PRINTED MATTER

FOR BOOKS AND PRINTED PERIODICALS IN THE FIELD OF TOY MODEL RAILWAYS, TOY MODEL VEHICLES, AND TOY BACKGROUND LANDSCAPE MATERIALS FOR CREATING TOY MODEL INSTALLATIONS IN THE NATURE OF TOY BUILDINGS, BRIDGES, EQUIPMENT, TREES, AND HUMAN AND ANIMAL FIGURES; STATIONARY; PACKAGING MATERIALS MADE OF PAPER, PLASTICS, AND CARDBOARD, NAMELY, BAGS AND ENVELOPES; PACKAGING CONTAINERS OF PAPER AND CARDBOARD; CARDBOARD PACKAGING (U.S. CLS. 2, 5, 22, 23, 29, 37, 38 AND 50).

CLASS 28—TOYS AND SPORTING GOODS

FOR GAMES, NAMELY, BOARD GAMES, CARD GAMES, AND ACTION SKILL GAMES; TOYS, NAMELY, MECHANICAL TOYS, TOY FIGURES; TOY MODEL RAILWAYS; TOY VEHICLES FOR TOY MODEL RAILWAYS AND RELATED ACCESSORIES; TOY VEHICLE TRACK SETS AND ROADWAYS AND ACCESSORIES THEREFOR; TOY TRAINS AND PARTS AND ACCESSORIES THEREFOR; TOY BUILDINGS AND ACCESSORIES THEREFOR; TOY ACTION FIGURES AND ACCESSORIES THEREFOR (U.S. CLS. 22, 23, 38 AND 50).

INGA ERVIN, EXAMINING ATTORNEY

SN 79-045,541. THE BRITISH BROADCASTING CORPORATION, UNITED KINGDOM, FILED 5-25-2007.



PRIORITY DATE OF 4-2-2007 IS CLAIMED.
OWNER OF INTERNATIONAL REGISTRATION 0941941 DATED 5-25-2007, EXPIRES 5-25-2017.

CLASS 9—ELECTRICAL AND SCIENTIFIC APPARATUS

FOR AUDIO, VIDEO, STILL, AND MOVING IMAGES AND DATA RECORDINGS IN COMPRESSED AND UNCOMPRESSED FORM, NAMELY, PRE-RECORDED AUDIO AND VIDEO TAPES, CASSETTES, CD-ROMS, CDS, TAPES, CARTRIDGES, DIGITAL AUDIO AND VIDEO COMPRESSION FILES, MP3 FILES, AND FILMS IN THE FIELDS OF NEWS, CULTURAL EVENTS, EDUCATIONAL INFORMATION AND ENTERTAINMENT NEWS AND REVIEWS; COMPUTER GAME AND VIDEO GAME EQUIPMENT, NAMELY, COMPUTER GAME PROGRAMS, SOFTWARE, CASSETTES, DISCS AND TAPES; COMPUTER SOFTWARE FOR ACCESSING, REVIEWING, INTERACTING WITH AND RETRIEVING ON-LINE INFORMATION, ENTERTAINMENT AND EDUCATION FROM THE INTERNET; DOWNLOADABLE PUBLICATIONS IN THE NATURE OF MAGAZINES IN THE FIELDS OF NEWS, CULTURAL EVENTS, EDUCATIONAL INFORMATION AND ENTERTAINMENT NEWS AND REVIEWS; FLOATS FOR BATHING AND SWIMMING (U.S. CLS. 21, 23, 26, 36 AND 38).

CLASS 16—PAPER GOODS AND PRINTED MATTER

FOR PRINTED PUBLICATIONS, NAMELY, BOOKS, PAMPHLETS, PRINTED GUIDES, CATALOGUES AND PRINTED PROGRAMS PROVIDING INSTRUCTION, ENTERTAINMENT, AND EDUCATION RELATING TO ENVIRONMENTAL ISSUES; MAGAZINES FEATURING ENTERTAINMENT, INSTRUCTION IN THE FIELD OF ENVIRONMENTAL ISSUES, EDUCATION IN THE FIELD OF THE ENVIRONMENT, SPORT AND NEWS; PHOTOGRAPHS; STATIONERY; PAINT BRUSHES; PRINTED INSTRUCTIONAL AND TEACHING MATERIAL FOR CHILDREN IN THE FIELD OF ENVIRONMENTAL ISSUES; PLASTIC MATERIAL FOR PACKAGING, NAMELY, BAGS AND BUBBLE PACKS; PRINTING BLOCKS; POSTERS; POSTCARDS; GREETINGS CARDS; TRADING CARDS; PRINTED INVITATIONS; DIARIES; CALENDARS; PHOTOGRAPH ALBUMS; ART PRINTS; PAPER BAGS AND GENERAL PURPOSE PLASTIC BAGS; GIFT BOXES; NOTEPADS; WRITING INSTRUMENTS AND CRAYONS; COASTERS MADE OF PAPER; GIFT TAGS OF PAPER AND LUGGAGE TAGS; PAPER ORNAMENTS OF PAPER, CARDBOARD AND PAPIERMACHE; STICKERS; IRON ON AND PLASTIC TRANSFERS; RUBBER STAMPS; PERSONAL ORGANIZERS; ADDRESS BOOKS; AND PENCIL HOLDERS; DESK PADS; EMBROIDERY, SEWING AND KNITTING PATTERNS; POSTAGE STAMPS, NAMELY, COMMEMORATIVE STAMP SHEETS, AND PAPER AND PLASTIC GIFT WRAP; CROSSWORD PUZZLES (U.S. CLS. 2, 5, 22, 23, 29, 37, 38 AND 50).

CLASS 18—LEATHER GOODS

FOR ALL-PURPOSE CARRYING BAGS; BACKPACKS IN THE NATURE OF RUCKSACKS (U.S. CLS. 1, 2, 3, 22 AND 41).

CLASS 25—CLOTHING

FOR CLOTHING, NAMELY, SHIRTS, T-SHIRTS, BLOUSES, VESTS, PANTS, JEANS, SWEATPANTS, OVERALLS, SHORTS, SKIRTS, DRESSES, SWIMSUITS, JACKETS, COATS, SWEATERS, SWEATSHIRTS, ROBES, TIES, BELTS, GLOVES, MITTENS, PAJAMAS, UNDERWEAR, FOOTWEAR, AND HEADGEAR, NAMELY, HATS AND CAPS; FANCY DRESS COSTUMES, NAMELY, HALLOWEEN, MASQUERADE, FOLK AND DANCE COSTUMES (U.S. CLS. 22 AND 39).

CLASS 28—TOYS AND SPORTING GOODS

FOR TOYS, GAMES AND PLAYTHINGS, NAMELY, PLUSH TOYS, PUPPETS, BATH TOYS, TOY MASKS, TOY MUSICAL BOXES, TOY MUSICAL INSTRUMENTS, TOY MODEL HOBBYCRAFT KITS, JIGSAW PUZZLES, BOARD GAMES; GYMNAS TIC AND SPORTING ARTICLES, NAMELY, BASEBALL GLOVES, HANDBALL GLOVES, SKATEBOARDS, ROLLER SKATES, IN-LINE SKATES, BASEBALL BATS, TENNIS AND SQUASH RACKETS; CHRISTMAS CRACKERS; KITES; PLAY BALLS AND PLAY BALLOONS; FLIPPERS FOR SWIMMING; INFLATABLE TOYS FOR PLAY PURPOSES; ELECTRONIC AND VIDEO GAME APPARATUS, NAMELY, HANDHELD UNITS FOR PLAYING ELECTRONIC AND VIDEO GAMES; PLAYING CARDS (U.S. CLS. 22, 23, 38 AND 50).

CLASS 35—ADVERTISING AND BUSINESS

FOR MAIL ORDER CATALOG AND ON-LINE RETAIL STORE SERVICES FEATURING CLOTHING, EDUCATIONAL AND LANGUAGE TEACHING MATERIALS, SOUND AND VIDEO RECORDINGS, BOOKS, MAGAZINES, GAMES AND TOYS, AND MERCHANDISE RELATED TO RADIO AND TELEVISION PROGRAMS (U.S. CLS. 100, 101 AND 102).

CLASS 38—COMMUNICATION

FOR TELEVISION AND RADIO BROADCASTING; AUDIO AND VIDEO BROADCASTING; BROADCASTING PROGRAMS VIA THE INTERNET; STREAMING OF AUDIO AND VIDEO MATERIAL ACROSS BROADBAND NETWORKS AND THE INTERNET; AUDIO AND VIDEO BROADCASTING SERVICES RENDERED THROUGH TERRESTRIAL BROADCASTING, SATELLITES, WEBCASTING, AND TRANSMISSION TO WIRELESS COMMUNICATIONS DEVICES, HANDHELD COMPUTERS, PERSONAL DIGITAL ASSISTANTS, AND MOBILE AND CELLULAR PHONES; ELECTRONIC TRANSMISSION OF DATA, DOCUMENTS, MESSAGES, TEXT, SOUND, IMAGES, GRAPHICS, ENTERTAINMENT MEDIA CONTENT AND EDUCATIONAL INFORMATION VIA A GLOBAL COMPUTER NETWORK; VIDEO-ON-DEMAND TRANSMISSION SERVICES; MOBILE MEDIA AND ENTERTAINMENT SERVICES IN THE NATURE OF ELECTRONIC TRANSMISSION OF ENTERTAINMENT MEDIA CONTENT; PROVIDING ONLINE ELECTRONIC BULLETIN BOARDS AND CHAT ROOMS FOR TRANSMISSION OF MESSAGES AMONG COMPUTER USERS CONCERNING TOPICS OF GENERAL INTEREST (U.S. CLS. 100, 101 AND 104).

CLASS 41—EDUCATION AND ENTERTAINMENT

FOR ENTERTAINMENT SERVICES, NAMELY PRODUCTION OF RADIO AND TELEVISION ENTERTAINMENT AND AUDIO AND VIDEO RECORDINGS; ENTERTAINMENT SERVICES, NAMELY, ONGOING RADIO AND TELEVISION PROGRAMS, ONLINE TELEVISION PROGRAMS, ONLINE NON-DOWNLOADABLE FILMS VIA A VIDEO ON DEMAND SERVICE, AND ONLINE COMPUTER GAMES, ALL IN THE FIELDS OF CULTURAL EVENTS, EDUCATIONAL PROGRAMS, NEWS AND ENTERTAINMENT INFORMATION; ORGANIZING EXHIBITIONS FOR ENTERTAINMENT, EDUCATIONAL, CULTURAL, AND SPORTING PURPOSES RELATING TO OR FEATURING QUIZZES AND GAMES DESIGNED TO TEST GENERAL KNOWLEDGE AND RELATING TO MUSIC, DRAMA, FILM, ART, COMEDY, GENERAL KNOWLEDGE, GAMES, INFORMATION, NEWS, TELEVISION AND RADIO PROGRAMS INCLUDING CHILDREN'S RADIO AND TELEVISION PROGRAMS, EVENTS, SPORT, DOCUMENTARIES, HISTORY, FICTION, NON-FICTION TOPICS, SCIENCE AND TECHNOLOGY; RENTAL OF MOTION PICTURE FILMS, PRERECORDED RADIO AND TELEVISION PROGRAMS, AND SOUND RECORDINGS AND VIDEOTAPES; PUBLICATION OF BOOKS; DISTRIBUTION OF TELEVISION PROGRAMMING FOR OTHERS TO CABLE, TERRESTRIAL OR SATELLITE TELEVISION SYSTEMS; PROVISION OF ENTERTAINMENT IN THE NATURE OF RADIO AND TELEVISION EDUCATIONAL PROGRAMS FOR ACCESSING VIA COMMUNICATION AND COMPUTER NETWORKS; PROVISION OF NON-DOWNLOADABLE FILMS, RADIO AND TV PROGRAMS VIA A VIDEO-ON-DEMAND SERVICE; EDUCATIONAL SERVICES, NAMELY, PROVIDING COURSES OF INSTRUCTION IN THE FIELD OF MATH VIA COMMUNICATION AND COMPUTER NETWORKS INCLUDING THE GLOBAL COMPUTER NETWORK; NEWS SYNDICATION FOR THE BROADCASTING INDUSTRY; INTERNET PORTAL SERVICES, NAMELY, PROVIDING INFORMATION ABOUT EDUCATION AND ENTERTAINMENT INFORMATION VIA THE INTERNET; RENTAL OF RADIO PROGRAMS, TELEVISION PROGRAMS, AND FILMS (U.S. CLS. 100, 101 AND 107).

ERNEST SHOSHO, EXAMINING ATTORNEY

SN 79-046,163. LEONI KABEL GMBH, FED REP GERMANY,
FILED 9-10-2007.

LEONI Adascar

THE MARK CONSISTS OF STANDARD CHARACTERS WITHOUT CLAIM TO ANY PARTICULAR FONT, STYLE, SIZE, OR COLOR.

PRIORITY DATE OF 3-12-2007 IS CLAIMED.
OWNER OF INTERNATIONAL REGISTRATION 0943377
DATED 9-10-2007, EXPIRES 9-10-2017.

OWNER OF U.S. REG. NOS. 3,063,887, 3,313,047 AND OTHERS.

THE NAME "LEONI ADASCAR" DOES NOT IDENTIFY A LIVING INDIVIDUAL.

CLASS 9—ELECTRICAL AND SCIENTIFIC APPARATUS

FOR ELECTRICAL CABLES, WIRES, CONDUCTORS, ELECTRICAL STRANDED WIRES AND SPUN PRODUCTS, PRINTED CIRCUIT BOARDS; OPTICAL FIBERS; ELECTRIC CABLE SETS; ON-BOARD ELECTRICAL NETWORK; SHIELDED ELECTRICAL CONDUITS; PROTECTIVE EQUIPMENT FOR THE AFORESAID GOODS (U.S. CLS. 21, 23, 26, 36 AND 38).

CLASS 17—RUBBER GOODS

FOR PROTECTIVE AND INSULATION MATERIALS, NAMELY, INSULATING TAPE AND RUBBER TUBE CONNECTORS (U.S. CLS. 1, 5, 12, 13, 35 AND 50).

FRED MANDIR, EXAMINING ATTORNEY

CLASS 9—ELECTRICAL AND SCIENTIFIC APPARATUS

FOR ELECTRONIC DISPLAY AND CONTROL DEVICES FOR MOTOR VEHICLES, NAMELY, INTERNAL AND EXTERNAL TEMPERATURE MEASURING APPARATUS IN THE NATURE OF TEMPERATURE INDICATORS; CONTROL APPARATUS FOR AIR CONDITIONING INSTALLATIONS IN THE NATURE OF MANUAL AND PROGRAMMED TEMPERATURE SWITCHES AND ELECTRIC CONTROL PANELS FOR MONITORING AND DISPLAYING TEMPERATURE INFORMATION AND ACTIVATING AIR CONDITIONING INSTALLATIONS; CONTROL APPARATUS FOR LIGHTING INSTALLATIONS IN THE NATURE OF AUTOMATED ELECTRIC LIGHT DIMMERS FOR FRONT HEADLIGHTS, ELECTRONIC CIRCUIT FOR DIRECTION SIGNALS, SWITCHES AND LIGHTING CONTROL PANELS; HEAD UP DISPLAY MODULES FOR DISPLAYING DRIVING DATA ON LAND VEHICLE WINDSHIELDS; CONTROL APPARATUS ALERTING DRIVERS OF OBJECTS ADJACENT TO THE VEHICLE EXTERIOR, NAMELY, DISTANCE MEASURING APPARATUS IN THE NATURE OF DISTANCE METERS COMPRISED OF ULTRASONIC DETECTORS AND SENSORS, MAINFRAME, AND ALARMS, AND MOUNTED CAMERAS; ELECTRONIC SECURITY APPARATUS FOR MOTOR VEHICLES, NAMELY, ALARM SYSTEMS FOR MOTOR VEHICLES INSTALLED AFTER PURCHASE, AND ACCESS CONTROL SYSTEMS, NAMELY, ELECTRIC DOOR OPENERS, CENTRAL LOCKING SYSTEMS COMPRISED OF ELECTRIC LOCK ACTUATORS, MANUAL SWITCHES, AND CONNECTING WIRES, AND KEYLESS ENTRY SYSTEMS FOR AUTOMOTIVE VEHICLES COMPRISED OF A MICROPROCESSOR, ELECTRONIC SIGNAL RECEIVER, KEY FOB WITH ELECTRONIC SIGNAL TRANSPONDER, AND ELECTRIC LOCK ACTUATORS; BATTERY CHARGERS, AND SATELLITE POSITION MONITORING DEVICES, NAMELY, A GLOBAL POSITIONING SYSTEM (GPS); REMOTE CONTROLS FOR THE AFORESAID GOODS (U.S. CLS. 21, 23, 26, 36 AND 38).

CLASS 11—ENVIRONMENTAL CONTROL APPARATUS

FOR LIGHTING INSTALLATIONS FOR MOTOR VEHICLES, NAMELY, VEHICLE TURN SIGNAL LIGHT BULBS, FRONT HEADLIGHTS, REAR LIGHTS, SIDE MARKER LIGHTS, FOG LIGHTS, AND MOTOR VEHICLE INTERIOR LIGHTING (U.S. CLS. 13, 21, 23, 31 AND 34).

CLASS 12—VEHICLES

FOR BODY PARTS FOR LAND MOTOR VEHICLES, NAMELY, ENGINE BONNETS, BOOT LIDS, MUDGUARDS, WIND DEFLECTORS AND AUTOMOTIVE WINDSHIELD SHADE SCREENS, CAR WINDOW SHADES; FITTINGS FOR MOTOR VEHICLES NAMELY, EXTERIOR MIRRORS, MIRROR COVERS FOR EXTERIOR VEHICLE MIRRORS, RADIATOR GRILLES, STRUCTURAL PARTS OF VENTILATION AND HEATING APPARATUS, NAMELY, INTERIOR OUTLETS FOR VENTILATION/HEATING SYSTEM; DECORATIVE ELEMENTS FOR CAR BODIES MADE OF PLASTIC OR METAL NAMELY, AUTOMOTIVE EXTERIOR METAL AND PLASTIC DECORATIVE AND PROTECTIVE TRIM, FRONT BUMPERS, BULL BARS AND SIDE SKIRTS, RUNNING BOARDS, SPOILERS, WIND DEFLECTORS, ROLL BARS, HANDLES, LAND VEHICLE ENGINE COVERS; PARTS FOR LAND MOTOR VEHICLES, NAMELY, GEAR LEVERS, STEERING WHEELS, GAS AND BREAK AND CLUTCH PEDALS, CHASSIS PARTS, NAMELY, SHOCK ABSORBERS AND CHASSIS SPRINGS, WHEEL SPACERS, VEHICLE WHEEL RIMS, ELECTRIC WINDOW LIFTS, HORNS (U.S. CLS. 19, 21, 23, 31, 35 AND 44).

LYDIA BELZER, EXAMINING ATTORNEY

SN 79-046,985. IN.PRO. HERSTELLUNGS- UND VER-
TRIEBSGESELLSCHAFT MBH, FED REP GERMANY,
FILED 9-3-2007.

in.pro.

THE MARK CONSISTS OF STANDARD CHARACTERS WITHOUT CLAIM TO ANY PARTICULAR FONT, STYLE, SIZE, OR COLOR.

OWNER OF INTERNATIONAL REGISTRATION 0945442
DATED 9-3-2007, EXPIRES 9-3-2017.

OWNER OF U.S. REG. NO. 2,429,215.

SN 79-047,443. SKYLOTEC GMBH, FED REP GERMANY,
FILED 7-20-2007.

SN 79-048,393. HAWLE ARMATUREN GMBH, FED REP
GERMANY, FILED 8-28-2007.

SKYLINE



PRIORITY DATE OF 3-20-2007 IS CLAIMED.
OWNER OF INTERNATIONAL REGISTRATION 0946674
DATED 7-20-2007, EXPIRES 7-20-2017.

CLASS 6—METAL GOODS

FOR ANTIFALL GUARD RAILS OF METAL (U.S. CLS. 2, 12, 13, 14, 23, 25 AND 50).

CLASS 9—ELECTRICAL AND SCIENTIFIC APPARATUS

FOR LIFE-SAVING APPARATUS AND INSTRUMENTS, NAMELY, FALL PROTECTION EQUIPMENT FOR FALL RESTRAINT AND FALL ARREST, NAMELY, BARS, ANCHORS, HARNESSES, LINES, LANYARDS, CARABINERS, AND ANCHORAGE CONNECTORS; FALL PROTECTION EQUIPMENT FOR FALL RESTRAINT AND ARREST, NAMELY, ROPE AND CARABINER CLIPPING AND UNCLIPPING DEVICES; FALL PROTECTION EQUIPMENT FOR FALL RESTRAINT AND ARREST, NAMELY, BELAY AND RAPPEL DEVICES, NAMELY, EQUIPMENT FOR BELAYING AND RAPPELLING COMPRISED OF FOLLOWING-ON CATCHING BRACES, MATCHING ROPES, SHOCK ABSORBING STRAPS, HARNESS STRAPS, HOLDING ROPES, AND SLINGS; PROTECTIVE CLOTHING USED ON CONNECTION WITH FALL RESTRAINTS; SAFETY DEVICES AND EQUIPMENT, NAMELY, INDIVIDUAL PROTECTION EQUIPMENT FOR PREVENTING PERSONS ACTING IN AREAS INVOLVING A RISK OF FALL, FROM FALLING, NAMELY, LIFE LINE SYSTEMS CONSISTING OF WIRE OR TEXTILE ROPES, AUTOMATIC FALL STOPPING OR FALL SLOWING DEVICES, DESCENT DEVICES FOR LOWERING DOWN PERSONS BEING RESCUED, NAMELY, EQUIPMENT FOR ABSEILING AND RESCUING, NAMELY, ROPE AND CARABINER CLIPPING AND UNCLIPPING DEVICES, FOLLOWING-ON CATCHING BRACES, MATCHING ROPES, SHOCK ABSORBING STRAPS, HARNESS STRAPS, HOLDING ROPES, AND SLINGS; FALL PROTECTION EQUIPMENT FOR FALL RESTRAINT AND FALL ARREST, NAMELY, SUPPORT OR CONNECTION LANYARDS, HARNESSES, TRIPODS, SNAP HOOKS AND MOBILE AND STATIONARY ANCHORING DEVICES FOR FASTENING LIFE-SAVING APPARATUS EQUIPMENT TO BEARING STRUCTURES (U.S. CLS. 21, 23, 26, 36 AND 38).

CLASS 22—CORDAGE AND FIBERS

FOR ROPES FOR USE AS ANTIFALL GUARDS (U.S. CLS. 1, 2, 7, 19, 22, 42 AND 50).
HEATHER THOMPSON, EXAMINING ATTORNEY

PRIORITY DATE OF 4-12-2007 IS CLAIMED.
OWNER OF INTERNATIONAL REGISTRATION 0949232
DATED 8-28-2007, EXPIRES 8-28-2017.
OWNER OF U.S. REG. NO. 3,537,245.
THE COLOR(S) BLUE AND BLACK IS/ARE CLAIMED AS
A FEATURE OF THE MARK.
THE MARKS CONSISTS OF THE LETTERS "K3" IN
BLACK AND A BLUE ARC.

CLASS 6—METAL GOODS

FOR GAS AND LIQUID PIPING AND PIPELINE COMPONENTS MADE PREDOMINANTLY OF METAL, NAMELY, SLEEVES, SHUTTERS, SLEEVE SHUTTERS, STRAPS, SHACKLES, CAPS, FLANGES, PIPES, PIPE FITTINGS, PIPE CLIPS, PIPE COLLARS, PIPE CONNECTORS, PIPE COUPLINGS AND JOINTS, JUNCTIONS FOR PIPES, PIPE MUFFS, MANUALLY OPERATED VALVES, SEALING RINGS, GASKET RINGS, BALL LOCK PINS, CAPS FOR PIPES AND PIPE ENDS, CLOSURES FOR PIPES AND PIPE ENDS, LIDS, PLUGS, SEALS, MANHOLE COVERS, PIPE SAFETY FITTINGS THAT MINIMIZE TRACTION, DIRT, AND ROTATION, HAND WHEELS, NON-ELECTRIC POSITION INDICATORS BEING PARTS OF PIPE VALVES, NIPPLES, GASKET RINGS; METAL BRACKETS (U.S. CLS. 2, 12, 13, 14, 23, 25 AND 50).

CLASS 8—HAND TOOLS

FOR HAND-OPERATED TOOLS FOR ASSEMBLING AND DISASSEMBLING, MAINTAINING AND REPAIRING PIPES AND PIPE BRACKETS, NAMELY, HAND HELD CUTTING TOOLS, NAMELY, PINCHERS, WRENCHES, PLIERS, PIPE BEVELING DEVICES, NAMELY, PIPE CUTTERS, TAPS, HEX KEY WRENCHES AND EXTENSIONS FOR HAND TOOLS (U.S. CLS. 23, 28 AND 44).

CLASS 11—ENVIRONMENTAL CONTROL APPARATUS

FOR HYDRANTS, PLUMBING FITTINGS, NAMELY, VENTILATING AND EVACUATING VALVES AND CONTROL VALVES (U.S. CLS. 13, 21, 23, 31 AND 34).

CLASS 17—RUBBER GOODS

FOR NON-METAL GASKETS FOR LIQUID AND GAS BRACES (U.S. CLS. 1, 5, 12, 13, 35 AND 50).

CLASS 37—CONSTRUCTION AND REPAIR

FOR INSTALLATION, MAINTENANCE AND REPAIR SERVICES, NAMELY, ASSEMBLING AND DISASSEMBLING PLUMBING FITTINGS AND METAL PIPE FITTINGS FOR GAS AND WATER PIPING AND PIPELINES, AND GAS AND LIQUID CONDUCTION SYSTEMS (U.S. CLS. 100, 103 AND 106).

CLASS 42—SCIENTIFIC AND COMPUTER SERVICES

FOR TECHNICAL PLANNING OF GAS AND LIQUID PIPING AND PIPELINES; TECHNICAL PLANNING SERVICES IN THE NATURE OF INDUSTRIAL DESIGN OF PLUMBING FITTINGS AND METAL PIPE FITTINGS; TECHNICAL PLANNING OF GAS AND LIQUID CONDUCTION SYSTEMS (U.S. CLS. 100 AND 101).

ROBERT STRUCK, EXAMINING ATTORNEY

CLASS 42—SCIENTIFIC AND COMPUTER SERVICES

FOR QUALITY CONTROL AND CERTIFICATION FOR MOUNTAINEERING AND ROCK CLIMBING, INCLUDING SKI MOUNTAINEERING, ESPECIALLY CONSULTANCY SERVICES CONCERNING QUALITY CARE, QUALITY CONTROL AND QUALITY ASSURANCE, NAMELY, TESTING ANALYSIS AND EVALUATION OF THE GOODS AND SERVICES OF OTHERS FOR THE PURPOSE OF CERTIFICATION; SERVICES RELATING TO CERTIFICATION OF CARE SYSTEMS IN THE FIELD OF QUALITY CARE, NAMELY, CONSULTATION IN THE FIELD OF QUALITY CONTROL FOR OTHERS; DRAFTING AND CHECKING STANDARDS, CERTIFICATION CRITERIA AND GUIDELINES IN THE AREA OF CERTIFICATION, NAMELY, DEVELOPMENT OF VOLUNTARY STANDARDS FOR THE PRACTICE OF MOUNTAINEERING AND ROCK CLIMBING; CHECKING OF PROCEDURES, PRODUCTS AND MATERIALS ACCORDING TO CERTIFICATION CRITERIA BASED ON STANDARDS AND GUIDELINES ACCREDITED AT THE NATIONAL AND INTERNATIONAL LEVEL IN THE NATURE OF ACCREDITATION SERVICES, NAMELY, SETTING AND PROVIDING STANDARDS FOR MOUNTAINEERING AND ROCK CLIMBING FOR THE PURPOSE OF ACCREDITATION; MATERIALS TESTING (U.S. CLS. 100 AND 101).

SN 79-048,560. UIAA, SWITZERLAND, FILED 8-23-2007.



PRIORITY DATE OF 2-23-2007 IS CLAIMED.
OWNER OF INTERNATIONAL REGISTRATION 0949706
DATED 8-23-2007, EXPIRES 8-23-2017.

CLASS 16—PAPER GOODS AND PRINTED MATTER

FOR PRINTED MATTER, NAMELY, MANUALS, NEWSLETTERS AND PRINTED PERIODICALS ABOUT MOUNTAINEERING AND ROCK CLIMBING, INCLUDING SKI MOUNTAINEERING (U.S. CLS. 2, 5, 22, 23, 29, 37, 38 AND 50).

CLASS 41—EDUCATION AND ENTERTAINMENT

FOR EDUCATION SERVICES, NAMELY, PROVIDING CLASSES, SEMINARS, AND WORKSHOPS IN THE FIELD OF MOUNTAINEERING AND ROCK CLIMBING, INCLUDING SKI MOUNTAINEERING; SPORTS ACTIVITIES IN THE SECTOR OF MOUNTAINEERING AND ROCK CLIMBING, INCLUDING SKI MOUNTAINEERING, NAMELY ORGANIZING SPORTING EVENTS; ARRANGING AND CONDUCTING EDUCATIONAL SEMINARS AND SYMPOSIA IN THE FIELD OF MOUNTAINEERING AND ROCK CLIMBING, INCLUDING SKI MOUNTAINEERING; ELECTRONIC PUBLICATION ONLINE OF BOOKS AND PERIODICALS IN THE FIELD OF MOUNTAINEERING AND ROCK CLIMBING, INCLUDING SKI MOUNTAINEERING, NAMELY, PUBLISHING OF ELECTRONIC PUBLICATIONS; OPERATING NON-DOWNLOADABLE ONLINE ELECTRONIC PUBLICATIONS IN THE FIELD OF MOUNTAINEERING AND ROCK CLIMBING, INCLUDING SKI MOUNTAINEERING, NAMELY, PROVIDING ON-LINE PUBLICATIONS IN THE NATURE OF MANUALS, PRINTED PERIODICALS, DISCUSSION PAPERS AND NEWSLETTERS IN THE FIELD OF MOUNTAINEERING AND ROCK CLIMBING (U.S. CLS. 100, 101 AND 107).

CLASS 45—PERSONAL AND LEGAL SERVICES

FOR INTELLECTUAL PROPERTY LICENSING IN THE FIELD OF MOUNTAINEERING AND ROCK CLIMBING, INCLUDING SKI MOUNTAINEERING (U.S. CLS. 100 AND 101).

ROBERT STRUCK, EXAMINING ATTORNEY

SN 79-048,567. RAINBOW CO., LTD., JAPAN, FILED 9-12-2007.

Platinumdiamondphoton

THE MARK CONSISTS OF STANDARD CHARACTERS WITHOUT CLAIM TO ANY PARTICULAR FONT, STYLE, SIZE, OR COLOR.

PRIORITY DATE OF 8-1-2007 IS CLAIMED.

OWNER OF INTERNATIONAL REGISTRATION 0949717
DATED 9-12-2007, EXPIRES 9-12-2017.

THE WORDING "PLATINUMDIAMONDPHOTON" HAS NO MEANING IN A FOREIGN LANGUAGE.

CLASS 1—CHEMICALS

FOR CHEMICAL PRODUCTS, NAMELY, BLEACHING CHEMICALS FOR USE IN INDUSTRY AND SCIENCE AND NONFERROUS METAL, NAMELY, FISSIONABLE CHEMICAL ELEMENTS IN THE NATURE OF PLUTONIUM AND URANIUM, RARE EARTH METAL, AND RADIUM FOR SCIENTIFIC PURPOSES; NONMETALLIC MINERAL, NAMELY, DIATOMACEOUS EARTH, NATURAL GRAPHITE FOR INDUSTRIAL PURPOSES, AND CHINA CLAY IN THE NATURE OF KAOLIN; UNPROCESSED PLASTICS, NAMELY, UNPROCESSED ARTIFICIAL RESINS AND UNPROCESSED SYNTHETIC RESINS (U.S. CLS. 1, 5, 6, 10, 26 AND 46).

CLASS 11—ENVIRONMENTAL CONTROL APPARATUS

FOR HEATING APPARATUS FOR HOUSEHOLD USE, NAMELY, PORTABLE ELECTRIC HEATERS FOR HOUSEHOLD USE; DOME-SHAPED HEATING APPARATUS FOR HOUSEHOLD USE, NAMELY, ELECTRIC RADIANT HEATERS; HEATING APPARATUS FOR BUSINESS USE, NAMELY, DOME-SHAPED HEATING APPARATUS FOR BUSINESS USE, NAMELY, ELECTRIC HEATERS FOR COMMERCIAL USE (U.S. CLS. 13, 21, 23, 31 AND 34).

CLASS 17—RUBBER GOODS

FOR PLASTIC FIBERS, NOT FOR TEXTILE USE, FOR USE IN THE MANUFACTURE OF TIRE CORD; THREADS OF PLASTIC MATERIALS, NOT FOR TEXTILE USE, NAMELY, PLASTIC SOLDERING THREADS; MICA, RAW OR PARTIALLY PROCESSED (U.S. CLS. 1, 5, 12, 13, 35 AND 50).

CLASS 24—FABRICS

FOR CLOTH AND FABRICS FOR TEXTILE USE, NAMELY, POLYESTER FABRIC FOR TEXTILE USE AND FIBERGLASS FABRICS FOR TEXTILE USE; JERSEY FABRICS FOR CLOTHING, KNITTED FABRIC, FELT, NON-WOVEN TEXTILE FABRICS, TOWELS OF TEXTILE, HANDKERCHIEFS OF TEXTILE, JAPANESE COTTON TOWELS (TENUGUI), JAPANESE CEREMONIAL WRAPPING CLOTH (FUKUSA), JAPANESE GENERAL WRAPPING CLOTH (FUROSHIKI), BED BLANKETS, BED SHEETS, FUTON, NAMELY, FITTED FUTON COVERS NOT OF PAPER; QUILTS, FUTON AND QUILTS CASES, NAMELY, UNFITTED FUTON COVERS NOT OF PAPER; FUTON TICKS, NAMELY, BED BLANKETS; EIDERDOWNS, MOSQUITO NETS, PILLOWCASES, TABLE NAPKINS OF TEXTILE, GLASS CLOTHS, NAMELY, KITCHEN TOWELS; SHOWER CURTAINS OF TEXTILE OR PLASTIC, FITTED TOILET LID COVERS OF FABRIC, CHAIR COVERINGS OF TEXTILE, NAMELY, TABLE LINEN; WALL HANGINGS OF TEXTILE, CURTAINS OF TEXTILE OR PLASTIC, FABRIC TABLE RUNNERS, TABLECLOTHS NOT OF PAPER, DRAPERIES (U.S. CLS. 42 AND 50).

ROBERT STRUCK, EXAMINING ATTORNEY

SN 79-048,753, KONSTANTINA LYMBERIS, AUSTRALIA, FILED 8-30-2007.

ÜBERgroover

PRIORITY DATE OF 3-1-2007 IS CLAIMED.
OWNER OF INTERNATIONAL REGISTRATION 0950158 DATED 8-30-2007, EXPIRES 8-30-2017.

THE ENGLISH TRANSLATION OF THE FOREIGN WORD(S) IN THE MARK IS: "UBER" MEANS "OVER", "ABOVE" OR "SUPER".

CLASS 9—ELECTRICAL AND SCIENTIFIC APPARATUS

FOR SOUND RECORDING DISCS FEATURING DANCE RELATED ENTERTAINMENT; SOUND RECORDING TAPES FEATURING DANCE RELATED ENTERTAINMENT; AUDIO-VIDEO COMPACT DISCS FEATURING DANCE RELATED ENTERTAINMENT; COMPACT DISCS CONTAINING RECORDED VIDEO FEATURING DANCE RELATED ENTERTAINMENT; COMPUTER PROGRAMS FOR VIDEO GAMES; DISCS BEARING VIDEO RECORDINGS FEATURING DANCE RELATED ENTERTAINMENT; FILMS BEARING VIDEO RECORDINGS FEATURING DANCE RELATED ENTERTAINMENT; FILMS ON VIDEO TAPE FEATURING DANCE RELATED ENTERTAINMENT; INTERACTIVE EDUCATIONAL GAME SOFTWARE FOR USE WITH VIDEO APPARATUS; INTERACTIVE VIDEO DISC PLAYERS; INTERACTIVE VIDEO GAME SOFTWARE; KARAOKE MACHINES INCORPORATING VIDEO DISCS; OPTIC DISCS CARRYING VIDEO RECORDINGS FEATURING DANCE RELATED ENTERTAINMENT; PERSONAL COMPUTERS FOR USE WITH VIDEO GAME DEVICES; PRE-RECORDED INSTRUCTIONAL VIDEO TAPES FEATURING DANCE RELATED ENTERTAINMENT; PRE-RECORDED MOTION PICTURE VIDEOS FEATURING DANCE RELATED ENTERTAINMENT; PRE-RECORDED MUSIC VIDEO RECORDINGS; PRE-RECORDED VIDEO CASSETTE TAPES FEATURING DANCE RELATED ENTERTAINMENT; PRE-RECORDED VIDEO CASSETTES FEATURING DANCE RELATED ENTERTAINMENT; PRE-RECORDED VIDEO DISCS FEATURING DANCE RE-

LATED ENTERTAINMENT; PRE-RECORDED VIDEO FILMS FEATURING DANCE RELATED ENTERTAINMENT; PRE-RECORDED VIDEO RECORDINGS FEATURING DANCE RELATED ENTERTAINMENT PROGRAMS; PRE-RECORDED VIDEO TAPES FEATURING DANCE RELATED ENTERTAINMENT; PRE-RECORDED VIDEO TAPES FOR TEACHING PURPOSES FEATURING DANCE, MUSIC, EXERCISE; PRE-RECORDED VIDEO DVDS, DISCS, CASSETTES, DIGITAL FILES FEATURING DANCE RELATED ENTERTAINMENT; VIDEO COMPACT DISCS FEATURING DANCE RELATED ENTERTAINMENT; VIDEO FILMS FEATURING DANCE RELATED ENTERTAINMENT; VIDEO FILMS PREPARED FOR EXHIBITIONS FEATURING DANCE RELATED ENTERTAINMENT; VIDEO PHONES; VIDEO RECORDING DISCS FEATURING DANCE RELATED ENTERTAINMENT; VIDEO RECORDINGS FEATURING DANCE RELATED ENTERTAINMENT; VIDEO TAPES FEATURING DANCE RELATED ENTERTAINMENT; VIDEODISCS FEATURING DANCE RELATED ENTERTAINMENT; VIDEO RECORDINGS FEATURING DANCE RELATED ENTERTAINMENT; COMPUTER GAMES ADAPTED FOR USE WITH TELEVISION RECEIVERS ONLY; COMPUTER GAME CONSOLES ADAPTED FOR USE WITH MONITORS; COMPUTER GAMES ENTERTAINMENT SOFTWARE; COMPUTER GAMES PROGRAMS; COMPUTER GAME PROGRAMS DOWNLOADED VIA THE INTERNET; COMPUTER GAMES SOFTWARE; HAND-HELD COMPUTER GAMES FOR USE WITH TELEVISION RECEIVERS ONLY; PROGRAM CARTRIDGES FOR COMPUTER GAMES; PROGRAMS FOR USE WITH COMPUTER GAMES; DVDS FEATURING DANCE RELATED ENTERTAINMENT; PRE-RECORDED DVDS FEATURING DANCE RELATED ENTERTAINMENT; CDS FEATURING DANCE RELATED ENTERTAINMENT; PRE-RECORDED COMPACT DISCS FEATURING DANCE RELATED ENTERTAINMENT; SOUND RECORDING DISCS FEATURING DANCE RELATED ENTERTAINMENT; SOUND RECORDINGS FEATURING DANCE RELATED ENTERTAINMENT; SOUND RECORDINGS ON PHONOGRAPH RECORDS FEATURING DANCE RELATED ENTERTAINMENT; SOUND RECORDINGS FEATURING MUSIC SOUND TRACKS; TELEVISION FILMS FEATURING DANCE RELATED ENTERTAINMENT; PHONOGRAPH RECORDS BEARING ENTERTAINMENT MATERIAL; DIGITAL MUSIC DOWNLOADABLE FROM THE INTERNET; DIGITAL MP3 FILES DOWNLOADABLE FROM THE INTERNET FEATURING DIGITAL MUSIC; SOUND RECORDINGS FEATURING MUSIC; DATA FILES DOWNLOADED ELECTRONICALLY FROM THE INTERNET FEATURING DANCE RELATED ENTERTAINMENT FOR PERSONAL VIEWING; PRE-RECORDED COMPACT DISCS FEATURING DANCE RELATED ENTERTAINMENT; PRE-RECORDED COMPACT, DIGITAL VIDEO DISCS FEATURING DANCE RELATED ENTERTAINMENT; PRE-RECORDED DISCS FOR REPRODUCING SOUND FEATURING DANCE RELATED ENTERTAINMENT; PRE-RECORDED DVDS FEATURING DANCE RELATED ENTERTAINMENT; PRE-RECORDED MOTION PICTURE FILMS FEATURING DANCE RELATED ENTERTAINMENT; PRE-RECORDED MOTION PICTURE VIDEOS FEATURING DANCE RELATED ENTERTAINMENT; PRE-RECORDED MUSIC VIDEOS; PRE-RECORDED VIDEOS FEATURING DANCE RELATED ENTERTAINMENT; DOWNLOADABLE ELECTRONIC PUBLICATIONS IN THE NATURE OF PODCASTS FEATURING DANCE RELATED ENTERTAINMENT; ELECTRONIC PUBLICATIONS IN THE NATURE OF EMAIL NEWSLETTERS FEATURING DANCE RELATED ENTERTAINMENT RECORDED ON COMPUTER MEDIA; CARRYING CASES ADAPTED FOR SUNGLASSES; CASES ADAPTED FOR SUNGLASSES; CHAINS FOR SUNGLASSES; FRAMES FOR SUNGLASSES; SUNGLASSES; SPORTS GLASSES (U.S. CLS. 21, 23, 26, 36 AND 38).

CLASS 25—CLOTHING

FOR CLOTHING, NAMELY, TOPS, BOTTOMS, UNDERGARMENTS, BODYLINERS IN THE NATURE OF BODY STOCKINGS, T-SHIRTS, TANK TOPS, JACKETS, VESTS, HOOD-TOPS, BEANIES, TROUSERS, SHIRTS, SHORTS, ARM WARMERS, FOLK COSTUMES, KHAKIS, KNEE WARMERS, WRAP-AROUNDS, HOODS; CLOTHING FOR GYMNASTICS, NAMELY, LEOTARDS, BIKETARDS, SHORTS, BRIEFS, TOPS; CLOTHING FOR SPORTS, NAMELY, SPORTSBRAS, EXERCISE PANTS, SWEATSHIRTS, TRACKSUIT TOPS, TRACKSUIT PANTS, T-SHIRTS, SPORTS TOPS; CLOTHING FOR SURFING, NAMELY, HOODED SWEATSHIRTS, SINGLET, RASH GUARDS, WETSUITS, JACKETS; CLOTHING FOR SWIMMING, NAMELY, BIKINIS, BOARDSHORTS, SWIMSUITS; DANCE CLOTHING, NAMELY, LEOTARDS, TIGHTS, SKIRTS, DRESSES, TUTUS, DANCE PANTS, LEGWARMERS, SHIRTS, SWEATSHIRTS, LOUNGEWEAR; DENIM CLOTHING, NAMELY, SHIRTS, JACKETS, VESTS, OVERALLS, DRESSES, SKIRTS; GLOVES; HEADBANDS; HOODS; JACKETS; JERSEYS; JUMP SUITS; LADIES CLOTHING, NAMELY, CAMISOLES, SKIRTS, DRESSES, CHEMISES, TROUSERS; RAINPROOF CLOTHING, NAMELY, COATS, JACKETS, PANTS, TROUSERS; SILK CLOTHING, NAMELY, LINGERIE, NIGHTGOWNS, DRESSING GOWNS, SCARVES, CAMISOLES, CHEMISES, SINGLET, SHIRTS, PANTS, BOXERS, PONCHOS, KAFTANS, TUBE DRESSES, VESTS, OVER JACKETS, SHRUGS; THONGS BEING UNDERWEAR; WIND RESISTANT JACKETS; WOOLEN CLOTHING, NAMELY, COATS, JUMPERS, PANTS, SCARVES, BEANIES, SOCKS, JACKETS, THERMAL UNDERWEAR; WRISTBANDS; SWEATBAND WRISTLETS; FOOTWEAR; FOOTWEAR FOR DANCING; FOOTWEAR FOR MEN; FOOTWEAR FOR SPORT; FOOTWEAR FOR WOMEN; INFANTS' FOOTWEAR; SPORTS FOOTWEAR; HEADWEAR; SOCKS; BRAS; LEGGINGS; SPORTS HOSIERY (U.S. CLS. 22 AND 39).

CLASS 41—EDUCATION AND ENTERTAINMENT

FOR FILM PRODUCTION; LIVE ENTERTAINMENT PRODUCTION SERVICES, NAMELY, TV ENTERTAINMENT PRODUCTION, RADIO ENTERTAINMENT PRODUCTION; DANCE EVENTS ENTERTAINMENT PRODUCTION; LIVE SHOW PRODUCTION SERVICES, NAMELY, TELEVISION SHOW PRODUCTION, RADIO SHOW PRODUCTION, ONLINE TELEVISION SHOW PRODUCTION, TELEVISION DANCE SHOW PRODUCTION; ONLINE SHOW PRODUCTION, DANCE SHOW PRODUCTION; MOTION PICTURE DANCE AND SONG PRODUCTION; MULTIMEDIA ENTERTAINMENT SOFTWARE PRODUCTION SERVICES; PRODUCTION OF ANIMATED CARTOONS; PRODUCTION OF ANIMATED FILMS AND CARTOONS; PRODUCTION OF AUDIO AND/OR VIDEO RECORDINGS; PRODUCTION OF AUDIO ENTERTAINMENT; PRODUCTION OF AUDIO RECORDINGS; PRODUCTION OF AUDIO/VISUAL PRESENTATIONS; PRODUCTION OF CABLE TELEVISION PROGRAMS; PRODUCTION OF CINEFILMS; PRODUCTION OF FILMS; PRODUCTION OF LIVE ENTERTAINMENT, NAMELY, PRODUCTION OF PLAYS, PRODUCTION OF DANCE SHOWS; PRODUCTION OF LIVE PERFORMANCES, NAMELY, PRODUCTION OF LIVE MUSICAL PERFORMANCES, PRODUCTION OF LIVE DANCE PERFORMANCES; PUBLICATION OF MAGAZINES; PRODUCTION OF MOTION PICTURE FILMS; PRODUCTION OF LIVE MUSIC SHOWS; PRODUCTION OF MUSICAL VIDEO RECORDINGS; PRODUCTION OF NEWS AND CURRENT AFFAIRS FOR TELEVISION, RADIO, ONLINE, MOBILE PROGRAMS; PRODUCTION OF RADIO AND TELEVISION PROGRAMS; PRODUCTION OF RADIO PROGRAMS; PRODUCTION OF TELEVISION, CABLE, ONLINE, MOBILE, RADIO SHOWS; PRODUCTION OF A CONTINUING PROGRAM ABOUT DANCE RELATED ENTERTAINMENT ACCESSIBLE BY TELEVISION, CABLE TELEVISION, COMPUTER NETWORKS, MOBILE DEVICES, AND RADIO; PREPARATION OF SPECIAL EFFECTS; PRODUCTION OF STAGE PERFORMANCES; PRODUCTION OF STAGE PLAYS; PRODUCTION OF TELEVISION PROGRAMS; PRODUCTION OF THEATRE PROGRAMS; PRODUCTION OF VIDEO RECORDINGS; PRODUCTION OF VIDEOS; PROVISION OF FACILITIES FOR THE PRODUCTION OF

FILMS; GAME AND DANCE SHOW PRODUCTION SERVICES; THEATRE PRODUCTION SERVICES; ENTERTAINMENT IN THE NATURE OF THEATRE PRODUCTIONS; THEATRICAL PRODUCTION SERVICES; VIDEO PRODUCTION SERVICES; VIDEOTAPE FILM PRODUCTION; ENTERTAINMENT INFORMATION; PROVIDING INFORMATION, INCLUDING ON-LINE INFORMATION, ABOUT EDUCATION, DANCE, EXERCISE TRAINING, ENTERTAINMENT, SPORTING AND CULTURAL ACTIVITIES; RECREATION INFORMATION; PROVIDING PRERECORDED NON DOWNLOADABLE DIGITAL MUSIC FROM THE INTERNET; DISTRIBUTION OF AUDIO RECORDINGS; DISTRIBUTION OF FILMS; DISTRIBUTION OF SOUND RECORDINGS; DISTRIBUTION OF TELEVISION PROGRAMS; DISTRIBUTION OF VIDEOS; ARRANGING OF ENTERTAINMENT IN THE NATURE OF DANCE PERFORMANCES; ARRANGING OF EXHIBITIONS FOR ENTERTAINMENT PURPOSES; ENTERTAINMENT, NAMELY, DANCE EVENTS; ORGANIZATION OF ENTERTAINMENT EVENTS IN THE NATURE OF INTERACTIVE DANCE EVENTS; ORGANIZATION OF EXHIBITIONS FOR ENTERTAINMENT PURPOSES; PAY TELEVISION ENTERTAINMENT IN THE NATURE OF AN ON-GOING TELEVISION PROGRAM IN THE FIELD OF DANCE; TELEVISION ENTERTAINMENT IN THE NATURE OF AN ON-GOING TELEVISION PROGRAM FEATURING VARIETY, DANCE, INTERVIEWS, COMEDY, NEWS, EVENTS, MUSIC; TELEVISION STUDIO SERVICES; ORGANIZING OF DANCING COMPETITIONS; PROVIDING DANCING FACILITIES; INSTRUCTION IN DANCING (U.S. CLS. 100, 101 AND 107).

ALICIA COLLINS, EXAMINING ATTORNEY

SN 79-049,531. GEBRÜDER MÄRKLIN & CIE. GMBH, FED REP GERMANY, FILED 11-21-2007.

CIRCUS MONDOLINO

PRIORITY DATE OF 9-25-2007 IS CLAIMED.
OWNER OF INTERNATIONAL REGISTRATION 0952434 DATED 11-21-2007, EXPIRES 11-21-2017.

NO CLAIM IS MADE TO THE EXCLUSIVE RIGHT TO USE "CIRCUS", APART FROM THE MARK AS SHOWN.
THE FOREIGN WORD "MODOLINO" IN THE MARK TRANSLATES INTO ENGLISH AS "LITTLE WORLD".

CLASS 9—ELECTRICAL AND SCIENTIFIC APPARATUS

FOR ELECTRIC CONTROL DEVICES FOR VEHICLES, NAMELY, CONTROL DEVICES FOR MODEL RAILWAYS (U.S. CLS. 21, 23, 26, 36 AND 38).

CLASS 16—PAPER GOODS AND PRINTED MATTER

FOR BOOKS AND PRINTED PERIODICALS IN THE FIELD OF TOY MODEL RAILWAYS, TOY MODEL VEHICLES, AND ABOUT TOY BACKGROUND LANDSCAPE MATERIALS FOR CREATING TOY MODEL INSTALLATIONS IN THE NATURE OF TOY BUILDINGS, BRIDGES, EQUIPMENT, TREES, AND HUMAN AND ANIMAL FIGURES; STATIONERY; PACKAGING MATERIALS MADE OF PAPER, PLASTICS, AND CARDBOARD, NAMELY, BAGS AND ENVELOPES; PACKAGING CONTAINERS OF PAPER AND CARDBOARD; CARDBOARD PACKAGING (U.S. CLS. 2, 5, 22, 23, 29, 37, 38 AND 50).

CLASS 28—TOYS AND SPORTING GOODS

FOR GAMES, NAMELY, BOARD GAMES, CARD GAMES, AND ACTION SKILL GAMES; TOYS, NAMELY, MECHANICAL TOYS, TOY FIGURES; TOY MODEL RAILWAYS; TOY VEHICLES FOR TOY MODEL RAILWAYS AND RELATED ACCESSORIES; TOY VEHICLE TRACK SETS AND ROADWAYS AND ACCESSORIES THEREFOR; TOY TRAINS AND PARTS AND ACCESSORIES THEREFOR; TOY BUILDINGS AND ACCESSORIES THEREFOR; TOY ACTION FIGURES AND ACCESSORIES THEREFOR (U.S. CLS. 22, 23, 38 AND 50).

DAYNA BROWNE, EXAMINING ATTORNEY

CLASS 42—SCIENTIFIC AND COMPUTER SERVICES

FOR COMPUTER SERVICES, NAMELY, HOSTING ON-LINE WEB FACILITIES FOR OTHERS FOR ORGANISING AND CONDUCTING ON-LINE MEETINGS, GATHERINGS, SOCIAL EVENTS AND INTERACTIVE DISCUSSIONS; COMPUTER SERVICES IN THE NATURE OF CUSTOMISED WEB PAGES FEATURING USER-DEFINED INFORMATION, PERSONAL PROFILES AND INFORMATION (U.S. CLS. 100 AND 101).

CLASS 45—PERSONAL AND LEGAL SERVICES

FOR DATING SERVICES; PERSONAL INTRODUCTION SERVICES IN THE NATURE OF SOCIAL INTRODUCTION AGENCIES; INTERNET BASED DATING, INTRODUCTION AND SOCIAL NETWORKING SERVICES (U.S. CLS. 100 AND 101).

JOHN KELLY, EXAMINING ATTORNEY

SN 79-049,953. DOUBLE THE FUN PTY LTD, GLEBE, NSW 2037, AUSTRALIA, FILED 11-5-2007.

DOUBLE THE FUN

THE MARK CONSISTS OF STANDARD CHARACTERS WITHOUT CLAIM TO ANY PARTICULAR FONT, STYLE, SIZE, OR COLOR.

PRIORITY DATE OF 5-8-2007 IS CLAIMED.

OWNER OF INTERNATIONAL REGISTRATION 0953458 DATED 11-5-2007, EXPIRES 11-5-2017.

CLASS 35—ADVERTISING AND BUSINESS

FOR ADVERTISING, PROMOTIONAL AND MARKETING SERVICES, NAMELY, PRODUCTION AND DISSEMINATION OF ADVERTISING MATERIALS AND INFORMATION; PROVISION OF ADVERTISING SPACE BY ELECTRONIC MEANS AND GLOBAL INFORMATION NETWORKS; DATA STORAGE AND RETRIEVAL SERVICES IN THIS CLASS, NAMELY, COMPUTERISED DATA STORAGE SERVICES IN THIS CLASS, COMPILATION OF ON-LINE COMMERCIAL INFORMATION DIRECTORIES ON THE INTERNET; PROMOTING, ADVERTISING AND MARKETING OF THE ON-LINE WEB SITES OF OTHERS; PROVIDING BUSINESS INFORMATION IN THE FIELD OF ADVERTISING, PROMOTION AND MARKETING; PROVIDING BUSINESS CONSULTING IN THE FIELD OF ADVERTISING, PROMOTION AND MARKETING; PROVIDING BUSINESS ADVISORY SERVICES IN THE FIELD OF ADVERTISING, PROMOTION AND MARKETING (U.S. CLS. 100, 101 AND 102).

CLASS 41—EDUCATION AND ENTERTAINMENT

FOR PROVIDING ON-LINE EDUCATION INFORMATION; PROVIDING ON-LINE ENTERTAINMENT INFORMATION; PROVIDING ON-LINE CULTURAL INFORMATION IN THE NATURE OF INFORMATION ON CULTURAL EVENTS; ORGANIZING EXHIBITIONS FOR EDUCATIONAL, CULTURAL, SPORTING OR ENTERTAINMENT PURPOSES; EDUCATIONAL SERVICES IN THE FIELD OF ADULT EDUCATION; ENTERTAINMENT SERVICES IN THE FIELD OF ADULT ENTERTAINMENT; SPECIAL EVENT PLANNING, NAMELY, ARRANGING AND CONDUCTING EVENTS INCLUDING DINNER, AND SOCIAL EVENTS AT BARS AND CLUBS; SOCIAL CLUB SERVICES, NAMELY, ARRANGING, ORGANIZING AND HOSTING SOCIAL EVENTS, GET-TOGETHERS, AND PARTIES FOR CLUB MEMBERS; PROVIDING ON-LINE EDUCATION INFORMATION; PROVIDING ON-LINE ENTERTAINMENT INFORMATION; PROVIDING ON-LINE CULTURAL INFORMATION IN THE NATURE OF INFORMATION ON CULTURAL EVENTS; PUBLICATION OF TEXT BOOKS, INCLUDING THE ON-LINE PUBLICATION OF TEXT BOOKS (U.S. CLS. 100, 101 AND 107).

SN 79-049,959. EAGLE PICTURES S.P.A., ITALY, FILED 12-10-2007.



OWNER OF INTERNATIONAL REGISTRATION 0953465 DATED 12-10-2007, EXPIRES 12-10-2017.

NO CLAIM IS MADE TO THE EXCLUSIVE RIGHT TO USE "MOVIE", APART FROM THE MARK AS SHOWN.

CLASS 35—ADVERTISING AND BUSINESS

FOR ADVERTISING SERVICES; ADVERTISING FLYER DISTRIBUTION; PROVIDING TELEVISION AND RADIO ADVERTISING FOR OTHERS ABOUT MOTION PICTURES, VIDEOS, MUSICAL RECORDINGS AND ELECTRONIC AMUSEMENT DEVICES; PROVIDING OFFICE FUNCTIONS (U.S. CLS. 100, 101 AND 102).

CLASS 38—COMMUNICATION

FOR TELECOMMUNICATION SERVICES, NAMELY, SATELLITE TELEVISION BROADCASTING AND VIDEO BROADCASTING AND PROVIDING TELECOMMUNICATION ACCESS TO VISUAL AND AUDIO PERFORMANCES, NAMELY, MUSICAL, VARIETY, AND COMEDY PERFORMANCES PROVIDED VIA A VIDEO-ON-DEMAND SERVICE; ELECTRONIC AND DIGITAL TRANSMISSION OF VOICE, DATA, IMAGES, SIGNALS AND MESSAGES; ELECTRONIC TRANSMISSION OF VOICE, DATA AND IMAGES BY SATELLITE TELEVISION AND VIDEO BROADCASTING AND VIA A VIDEO-ON-DEMAND TRANSMISSION SERVICE; TELECOMMUNICATIONS CONSULTATION SERVICES, NAMELY, CONSULTATION SERVICES TO CABLE NETWORKS, TELEPHONY, DSL AND FIBER-OPTIC NETWORKS, SATELLITE NETWORKS AND MEDIA NETWORKS RELATING TO THE PROVISION OF VIDEO ON DEMAND SERVICES (U.S. CLS. 100, 101 AND 104).

CLASS 41—EDUCATION AND ENTERTAINMENT

FOR EDUCATIONAL SERVICES, NAMELY, CONDUCTING CLASSES IN THE FIELD OF CINEMATOGRAPHY AIDED BY MOTION PICTURES; ENTERTAINMENT SERVICES, NAMELY TELEVISION PROGRAM PRODUCTION AND DISTRIBUTION OF TELEVISION PROGRAMS FOR OTHERS, TELEVISION AND CINEMA MOTION PICTURE PRODUCTION AND DISTRIBUTION OF TELEVISION AND CINEMA MOTION PICTURES FOR OTHERS, OPERATING OF FILM STUDIOS, LIVE THEATRE PERFORMANCES, PROVISION OF CINEMA HALLS, FILM EDITING, NAMELY PRINT AND NEGATIVE FILM CUTTING; ENTERTAINMENT IN THE NATURE OF ONGOING TELEVISION AND RADIO PROGRAMS IN THE FIELD OF NEWS, COMEDY AND VARIETY SHOWS; SPORTING AND CULTURAL ACTIVITIES, NAMELY, ORGANIZATION OF SPORTS COMPETITIONS AND LIVE MUSICAL PERFORMANCES BY SINGERS AND MUSICAL BANDS, PROVIDING GYMNASIUMS; PRESENTATION OF LIVE SHOW PERFORMANCES IN THE FIELD OF DANCE, THEATRE AND MUSIC (U.S. CLS. 100, 101 AND 107).

PAUL E. FAHRENKOPF, EXAMINING ATTORNEY

SN 79-050,439. BRION TECHNOLOGIES INCORPORATED, DELAWARE CORPORATION, UNITED STATES, FILED 1-17-2008.

BRION

THE MARK CONSISTS OF STANDARD CHARACTERS WITHOUT CLAIM TO ANY PARTICULAR FONT, STYLE, SIZE, OR COLOR.

PRIORITY DATE OF 7-20-2007 IS CLAIMED.
OWNER OF INTERNATIONAL REGISTRATION 0939091
DATED 8-27-2007, EXPIRES 8-27-2017.
OWNER OF U.S. REG. NO. 2,826,491.

CLASS 9—ELECTRICAL AND SCIENTIFIC APPARATUS

FOR COMPUTER HARDWARE AND SOFTWARE FOR DESIGNING AND MANUFACTURING SEMICONDUCTOR WAFERS AND MASKS; METROLOGY AND INSPECTION COMPUTER HARDWARE, MICROPROCESSORS AND ELECTRONIC SENSORS FOR MEASURING, DETECTING AND INSPECTING CHEMICAL COMPOSITIONS, TEMPERATURE, LIGHT IMAGES, THICKNESS, FLATNESS, TEXTURE, LINE WIDTH AND CONTAMINATION OF SEMICONDUCTOR WAFERS AND MASKS DURING THE MANUFACTURING PROCESS (U.S. CLS. 21, 23, 26, 36 AND 38).

CLASS 42—SCIENTIFIC AND COMPUTER SERVICES

FOR SERVICES OF TECHNICAL SPECIALISTS IN THE AREA OF METROLOGY, NAMELY, SCIENTIFIC RESEARCH, RESEARCH IN THE AREA OF SEMICONDUCTOR MANUFACTURING TECHNOLOGY; TECHNOLOGICAL SERVICES WITH REFERENCE TO LITHOGRAPHY, NAMELY, SCIENTIFIC RESEARCH, RESEARCH IN THE AREA OF SEMICONDUCTOR MANUFACTURING TECHNOLOGY; AND TECHNICAL CONSULTANCY IN RELATION TO THE PRODUCTION OF SEMICONDUCTORS (U.S. CLS. 100 AND 101).

ANTHONY RINKER, EXAMINING ATTORNEY

SN 79-050,134. COLLEEN B. ROSENBLAT, FED REP GERMANY, FILED 8-30-2007.

Colleen B. Rosenblat

THE MARK CONSISTS OF STANDARD CHARACTERS WITHOUT CLAIM TO ANY PARTICULAR FONT, STYLE, SIZE, OR COLOR.

OWNER OF INTERNATIONAL REGISTRATION 0803697
DATED 4-16-2003, EXPIRES 4-16-2013.

THE NAME(S), PORTRAIT(S), AND/OR SIGNATURE(S) SHOWN IN THE MARK IDENTIFIES A LIVING INDIVIDUAL, WHOSE CONSENT(S) TO REGISTER IS SUBMITTED.

CLASS 14—JEWELRY

FOR PRECIOUS METALS AND THEIR ALLOYS; GOODS MADE OF OR COATED WITH PRECIOUS METALS AND THEIR ALLOYS, IN THE NATURE OF GOLD, SILVER, PLATINUM, DIAMONDS, NAMELY, NECKLACES, RINGS, EARRINGS, BRACELETS, BROOCHES AND PENDANTS, AND LEADS IN THE NATURE OF NECKLACES, RINGS, EARRINGS, BRACELETS, BROOCHES, PENDANTS; JEWELRY; PRECIOUS STONES; HOROLOGICAL AND CHRONOMETRIC INSTRUMENTS (U.S. CLS. 2, 27, 28 AND 50).

CLASS 37—CONSTRUCTION AND REPAIR

FOR REPAIR OF JEWELLERY (U.S. CLS. 100, 103 AND 106).

CLASS 42—SCIENTIFIC AND COMPUTER SERVICES

FOR SERVICES OF A DESIGNER, NAMELY, DESIGN FOR OTHERS IN THE FIELD OF JEWELRY (U.S. CLS. 100 AND 101).

ELLEN PERKINS, EXAMINING ATTORNEY

SN 79-050,612. HOLA, S.A., SPAIN, FILED 9-14-2007.



PRIORITY DATE OF 3-19-2007 IS CLAIMED.
OWNER OF INTERNATIONAL REGISTRATION 0955370
DATED 9-14-2007, EXPIRES 9-14-2017.

OWNER OF U.S. REG. NO. 1,935,065.
NO CLAIM IS MADE TO THE EXCLUSIVE RIGHT TO USE "TV", APART FROM THE MARK AS SHOWN.

THE COLOR(S) RED AND WHITE IS/ARE CLAIMED AS A FEATURE OF THE MARK.

THE MARK CONSISTS OF THE DENOMINATION "H! TV", WRITTEN IN WHITE LETTERS ON A RECTANGULAR RED BACKGROUND.

CLASS 38—COMMUNICATION

FOR TELECOMMUNICATIONS SERVICES, NAMELY, PERSONAL COMMUNICATION SERVICES, TELECOMMUNICATION ACCESS SERVICES; COMMUNICATION VIA COMPUTER TERMINALS BY DIGITAL TRANSMISSION OR BY SATELLITE; ELECTRONIC MAIL SERVICES; AUDIO AND VIDEO BROADCASTING OF AUDIOVISUAL PROGRAMS; BROADCASTING PROGRAMS VIA A GLOBAL COMPUTER NETWORK MEDIUM; COMMUNICATION SERVICES, NAMELY, TRANSMISSION OF MESSAGES AND IMAGES WIRELESS COMMUNICATION NETWORKS, THE INTERNET, TELECOM NETWORKS AND DATA NETWORKS (U.S. CLS. 100, 101 AND 104).

CLASS 41—EDUCATION AND ENTERTAINMENT

FOR ENTERTAINMENT IN THE NATURE OF AUDIO AND VISUAL PERFORMANCES, NAMELY, MUSICAL BAND, ORCHESTRA, AND DANCE PERFORMANCES; CULTURAL ACTIVITIES, NAMELY, ORGANIZATION OF EXHIBITIONS FOR CULTURAL OR EDUCATIONAL PURPOSES; EDITORIAL SERVICES, NAMELY, EDITORIAL REPORTING SERVICES; PUBLICATION OF ELECTRONIC BOOKS, PERIODICALS AND MAGAZINES; EXPLOITATION OF ON-LINE ELECTRONIC PUBLICATIONS, NAMELY, GENERAL FEATURE MAGAZINES; NEWS AND PHOTOGRAPHIC REPORTING SERVICES; DIGITAL VIDEO, AUDIO AND MULTIMEDIA PUBLISHING, EDITING AND PRODUCTION SERVICES; ENTERTAINMENT SERVICES, NAMELY, A MULTIMEDIA PROGRAM SERIES FEATURING NEWS, DOCUMENTARY, COMEDY, ACTION AND ADVENTURE DISTRIBUTED VIA VARIOUS PLATFORMS ACROSS MULTIPLE FORMS OF TRANSMISSION MEDIAS; PRODUCTION OF SHOWS, NAMELY, TALK SHOWS, NEWS PROGRAMS, REALITY SHOWS, LIVE MUSICAL PERFORMANCES, PLAYS, THEATER; PRODUCTION OF FILMS; AUDIO AND VIDEO RECORDING SERVICES (U.S. CLS. 100, 101 AND 107).

BERNICE MIDDLETON, EXAMINING ATTORNEY

CLASS 37—CONSTRUCTION AND REPAIR

FOR BUILDING CONSTRUCTION; INSTALLATION SERVICES, NAMELY, THE INSTALLATION OF HEATING, COOLING AND ENVIRONMENTAL CONTROL SYSTEMS PRIMARILY USING SOLAR ENERGY, RENEWABLE ENERGY RESOURCES AND RAINWATER; INSTALLATION OF INTERIOR AND EXTERIOR CUSTOM SEASONAL DECORATIONS FOR OTHERS; INSTALLATION OF DOORS AND WINDOWS; INSTALLATION OF COMPUTER SYSTEMS AND NETWORKS; INSTALLATION OF BUILDING INSULATION; ROOFING INSTALLATION; TILE INSTALLATION SERVICES; INSTALLATION OF BASEMENT WATERPROOFING PRODUCTS; INSTALLATION OF BLINDS; INSTALLATION OF SOLAR ENERGY BASED POWER PLANTS; INSTALLATION OF PHOTOVOLTAIC, SOLAR THERMAL AND PHOTOVOLTAIC/SOLAR THERMAL HYBRID INSTALLATIONS; INSTALLATION OF IRRIGATION SYSTEMS (U.S. CLS. 100, 103 AND 106).

CLASS 42—SCIENTIFIC AND COMPUTER SERVICES

FOR AGRICULTURAL RESEARCH; APPLICATION SERVICE PROVIDER, NAMELY, PROVIDING, HOSTING, MANAGING, DEVELOPING, AND MAINTAINING APPLICATIONS, SOFTWARE, WEB SITES, AND DATABASES IN THE FIELDS OF PERSONAL PRODUCTIVITY, WIRELESS COMMUNICATION, MOBILE INFORMATION ACCESS, AND REMOTE DATA MANAGEMENT FOR WIRELESS DELIVERY OF CONTENT TO HANDHELD COMPUTERS, LAPTOPS AND MOBILE ELECTRONIC DEVICES; APPLICATION SERVICE PROVIDER FEATURING SOFTWARE FOR PROVIDING AN ON-LINE DATABASE IN THE FIELD OF TRANSACTION PROCESSING TO UPLOAD TRANSACTIONAL DATA, PROVIDE STATISTICAL ANALYSIS, AND PRODUCE NOTIFICATIONS AND REPORTS; ARCHITECTURAL AND ENGINEERING SERVICES; ARCHITECTURAL CONSULTATION AND DESIGN; CALIBRATION MEASURING; CHEMICAL, BIOCHEMICAL AND BIOLOGICAL RESEARCH AND ANALYSIS; CIVIL ENGINEERING; COMPILING DATA FOR RESEARCH PURPOSES IN THE FIELD OF MEDICAL SCIENCE AND MEDICAL CONSULTANCY; COMPUTER AIDED DESIGN FOR OTHERS; CONSULTATION IN THE FIELD OF ERGONOMICS, NAMELY, DESIGNING WORKPLACE FACILITIES AND EQUIPMENT TO OPTIMIZE EFFICIENCY AND SAFETY; CONSULTING SERVICES IN THE FIELD OF ENVIRONMENTAL ASSESSMENT, COMPLIANCE AND PLANNING; COSMETIC RESEARCH; DESIGN AND DEVELOPMENT OF MULTIMEDIA PRODUCTS; DESIGN AND DEVELOPMENT OF COMPUTER HARDWARE AND SOFTWARE; DESIGN AND TESTING FOR NEW PRODUCT DEVELOPMENT; DESIGN OF HOME PAGES AND WEB SITES; DESIGNING OF PACKAGING AND WRAPPING MATERIALS; DEVELOPMENT OF PHARMACEUTICAL PREPARATIONS AND MEDICINES; ENGINEERING; ENVIRONMENTAL SERVICES, NAMELY, TECHNICAL CONSULTATION IN THE FIELD OF ENVIRONMENTAL SCIENCE, ENGINEERING SERVICES, DESIGN FOR OTHERS IN THE FIELD OF ENVIRONMENTAL ENGINEERING, DESIGNING AND TESTING OF NEW ENVIRONMENTALLY FRIENDLY PRODUCTS FOR OTHERS; EVALUATION AND TESTING OF REAL ESTATE FOR THE PRESENCE OF HAZARDOUS MATERIAL; FOOD RESEARCH; GRAPHIC DESIGN; INDUSTRIAL DESIGN; LABORATORY SERVICES, NAMELY, PIGMENT AND COLOR ANALYSIS; LANDSCAPE ARCHITECTURAL AND LIGHTING DESIGN; MATERIALS ANALYSING, TESTING AND EVALUATION; MEDICAL RESEARCH; NETWORKING OF HOME CONTROLS, NAMELY, WIRELESS AND WIRED LIGHTING CONTROLS, THERMOSTAT AND HEATING CONTROLS, ROLLING SHUTTERS AND DOOR CONTROLS, APPLIANCE CONTROLS, NAMELY, OVEN, WASHER, DRYER, REFRIGERATOR, DISHWASHER, LAWN AND GARDEN IRRIGATION CONTROLS, HOME AUDIO AND VIDEO CONTROLS; PHARMACEUTICAL RESEARCH AND DEVELOPMENT; PHYSICS RESEARCH; PRODUCT RESEARCH AND DEVELOPMENT; PROVIDING A WEBSITE THAT GIVES USERS THE ABILITY TO UPLOAD, EXCHANGE AND SHARE PHOTOS, VIDEOS AND VIDEO LOGS AND GIVES USERS THE ABILITY TO CREATE CUSTOMIZED WEB PAGES FEATURING USER-DEFINED INFORMATION AND PROFILES; PRO-

SN 79-050,660, PATRICK DOBLER DE SOUZA, FED REP GERMANY, FILED 12-3-2007.

Qilance

THE MARK CONSISTS OF STANDARD CHARACTERS WITHOUT CLAIM TO ANY PARTICULAR FONT, STYLE, SIZE, OR COLOR.

PRIORITY DATE OF 6-7-2007 IS CLAIMED.

OWNER OF INTERNATIONAL REGISTRATION 0955539 DATED 12-3-2007, EXPIRES 12-3-2017.

VIDING A WEB SITE FEATURING TECHNOLOGY THAT ENABLES INTERNET USERS TO CREATE, BOOKMARK, ANNOTATE, AND PUBLICLY SHARE DATA; PROVIDING TECHNOLOGICAL AND SCIENTIFIC INFORMATION ABOUT ENVIRONMENTALLY-CONSCIOUS AND GREEN INNOVATIONS; RESEARCH AND DEVELOPMENT OF ADVANCED LEARNING TECHNOLOGIES AND TEACHING METHODS; RESEARCH IN THE FIELD OF CHEMISTRY, HAIR CARE, PHYSICS, ENVIRONMENTAL PROTECTION, CHILD AND ADOLESCENT DEVELOPMENT; RESEARCH ON FOOD; RESEARCH ON THE SUBJECT OF PHARMACEUTICALS; RESIDENTIAL BUILDING DESIGN; SCIENTIFIC AND TECHNICAL CONSULTING AND RESEARCH SERVICES RELATING TO FOODS AND DIETARY SUPPLEMENTS; SCIENTIFIC AND TECHNOLOGICAL SERVICES AND RESEARCH AND DESIGN IN THE FIELD OF INTEGRATED SYSTEM ARCHITECTURE THAT ALLOWS FOR THE RAPID DEVELOPMENT OF HIGHLY INTERACTIVE AND CUSTOMIZABLE LEARNING APPLICATIONS; SCIENTIFIC INVESTIGATIONS FOR MEDICAL PURPOSES; SCIENTIFIC RESEARCH AND DEVELOPMENT; SURVEYING; TECHNICAL ANALYSIS OF A PRODUCT OR PROCESS TO DETERMINE HOW TO MAKE IT MORE ENVIRONMENTALLY SOUND; TECHNICAL PLANNING OF PHOTOVOLTAIC, SOLAR THERMAL AND PHOTOVOLTAIC/SOLAR THERMAL HYBRID INSTALLATIONS; TESTING, INSPECTION OR RESEARCH OF PHARMACEUTICALS, COSMETICS OR FOODSTUFF; TOOL DESIGN; SCIENTIFIC AND TECHNOLOGICAL SERVICES AND RESEARCH AND DESIGN RELATING THERETO IN THE FOLLOWING FIELDS: ACOUSTICS, ARCHITECTURE, AROMA, ART, BUILDING BIOLOGY, BUILDING ECOLOGY, COLOR, DECORATING, FASHION, FENG SHUI, FURNITURE, INTERIOR AND EXTERIOR ENVIRONMENTS, RADIESTHESIA, TACTUAL SENSATION, TEXTILES, VASTU (U.S. CLS. 100 AND 101).

CLASS 44—MEDICAL, BEAUTY AND AGRICULTURAL SERVICES

FOR MEDICAL SERVICES; VETERINARY SERVICES; HYGIENIC AND BEAUTY CARE FOR HUMAN BEINGS OR ANIMALS; AGRICULTURAL ADVICE; HORTICULTURE SERVICES (U.S. CLS. 100 AND 101).
DANIEL CAPSHAW, EXAMINING ATTORNEY

SN 79-050,948. MEAT & LIVESTOCK AUSTRALIA LIMITED, NORTH SYDNEY NSW 2060, AUSTRALIA, FILED 2-18-2008.



**EATING QUALITY ASSURED
AUSTRALIAN BEEF**

PRIORITY DATE OF 11-9-2007 IS CLAIMED.
OWNER OF INTERNATIONAL REGISTRATION 0956305 DATED 2-18-2008, EXPIRES 2-18-2018.
NO CLAIM IS MADE TO THE EXCLUSIVE RIGHT TO USE "AUSTRALIAN BEEF" AND MAP OF AUSTRALIA, APART FROM THE MARK AS SHOWN.

CLASS 29—MEATS AND PROCESSED FOODS

FOR MEAT (U.S. CL. 46).

CLASS 42—SCIENTIFIC AND COMPUTER SERVICES

FOR GRADING OF MEAT AND PRODUCTS MADE FROM MEAT; QUALITY CONTROL OF MEAT AND PRODUCTS MADE FROM MEAT; QUALITY ASSURANCE CONSULTANCY IN RELATION TO MEAT AND PRODUCTS MADE FROM MEAT (U.S. CLS. 100 AND 101).

TASNEEM HUSSAIN, EXAMINING ATTORNEY

SN 79-050,967. EUROFOURS (S.A.), FRANCE, FILED 11-27-2007.



OWNER OF INTERNATIONAL REGISTRATION 0625756 DATED 10-14-1994, EXPIRES 10-14-2014.

CLASS 11—ENVIRONMENTAL CONTROL APPARATUS

FOR APPARATUS FOR LIGHTING, HEATING, STEAM GENERATING, COOKING, REFRIGERATING, DRYING, VENTILATING, WATER SUPPLY AND SANITARY PURPOSES, NAMELY, COMMERCIAL BAKING OVEN, CONVECTIONS OVENS, PASTRY OVENS, ELECTRICAL MODULAR DECK OVENS, ROTARY RACK OVENS FOR BAKING BREAD, VIENNESE PASTRY AND CONFECTIONERY; PROVER CABINETS USED TO CONTROL TEMPERATURE AND HUMIDITY FOR CONTROLLED FERMENTATION IN THE FIELD OF BAKING; PROVER CHAMBERS USED TO CONTROL TEMPERATURE AND HUMIDITY FOR CONTROLLED FERMENTATION IN THE FIELD OF BAKING; REFRIGERATOR CABINETS; FREEZERS (U.S. CLS. 13, 21, 23, 31 AND 34).

CLASS 20—FURNITURE AND ARTICLES NOT OTHERWISE CLASSIFIED

FOR FURNITURE; FURNITURE, NAMELY, SHOWCASES; DISPLAY STANDS (U.S. CLS. 2, 13, 22, 25, 32 AND 50).
KRISTINA MORRIS, EXAMINING ATTORNEY

SN 79-051,002. SILICON FIRE AG, SWITZERLAND, FILED 1-9-2008.



PRIORITY DATE OF 7-11-2007 IS CLAIMED.
OWNER OF INTERNATIONAL REGISTRATION 0956368 DATED 1-9-2008, EXPIRES 1-9-2018.

NO CLAIM IS MADE TO THE EXCLUSIVE RIGHT TO USE "SILICON FIRE", APART FROM THE MARK AS SHOWN.

THE COLOR(S) GREEN AND GREY IS/ARE CLAIMED AS A FEATURE OF THE MARK.

THE MARK CONSISTS OF THE COLOR GREEN APPEARING IN THE THREE FLAMES AND IN THE WORD "FIRE" AND OF THE COLOR GREY APPEARING IN THE WORDING "SILICON".

CLASS 1—CHEMICALS

FOR CHEMICALS FOR INDUSTRIAL USE, NAMELY, CHEMICAL PRODUCTS FOR PURIFYING RESIDUAL GASES; CHEMICALS FOR INDUSTRIAL USE, NAMELY, CHEMICAL PRODUCTS USED AS ENERGY CARRIERS, SUCH AS SILICON AND HYDROGEN PEROXIDE (U.S. CLS. 1, 5, 6, 10, 26 AND 46).

CLASS 4—LUBRICANTS AND FUELS

FOR ELECTRICAL ENERGY (U.S. CLS. 1, 6 AND 15).

CLASS 11—ENVIRONMENTAL CONTROL APPARATUS

FOR APPARATUS AND INSTRUMENTS FOR THE TREATMENT AND PURIFICATION OF RESIDUAL GASES, NAMELY, SOLVENT EXTRACTION EQUIPMENT, NAMELY, CHEMICAL WASHING REACTORS AND COLUMNS (U.S. CLS. 13, 21, 23, 31 AND 34).

CLASS 39—TRANSPORTATION AND STORAGE

FOR DISTRIBUTION AND SUPPLY OF ENERGY (U.S. CLS. 100 AND 105).

CLASS 40—MATERIAL TREATMENT

FOR GENERATION OF HEAT ENERGY AND OF ENERGY IN POWER GENERATING PLANTS (U.S. CLS. 100, 103 AND 106).

CLASS 42—SCIENTIFIC AND COMPUTER SERVICES

FOR SCIENTIFIC RESEARCH AND DEVELOPMENT; TECHNOLOGY CONSULTATION AND RESEARCH IN THE FIELD OF ELECTRIC ENERGY AND POWER PLANTS; RESEARCH AND DEVELOPMENT OF TECHNOLOGY IN THE FIELD OF ELECTRIC ENERGY AND POWER PLANTS; ENGINEERING SERVICES, NAMELY, SERVICES OF ENGINEERS WHO PROVIDE ASSESSMENTS, FORECASTS, ANALYSES AND REPORTS IN THE FIELD OF SCIENCE AND ELECTRIC ENERGY AND POWER PLANTS TECHNOLOGY; PROVIDING TECHNOLOGY INFORMATION IN THE GAS INDUSTRY, NAMELY, INFORMATION RELATING TO PURIFYING RESIDUAL GASES (U.S. CLS. 100 AND 101).

CLASS 45—PERSONAL AND LEGAL SERVICES

FOR LICENSING INDUSTRIAL PROPERTY RIGHTS (U.S. CLS. 100 AND 101).
MEGHAN REINHART, EXAMINING ATTORNEY

SN 79-051,519. MICHAEL SCHULTE, SWITZERLAND, FILED 11-23-2007.

LIVEBUSTER

THE MARK CONSISTS OF STANDARD CHARACTERS WITHOUT CLAIM TO ANY PARTICULAR FONT, STYLE, SIZE, OR COLOR.

OWNER OF INTERNATIONAL REGISTRATION 0957707 DATED 11-23-2007, EXPIRES 11-23-2017.

CLASS 9—ELECTRICAL AND SCIENTIFIC APPARATUS

FOR COMPUTERS, COMPUTER PERIPHERAL DEVICES, COMPUTER MEMORIES, COMPUTER KEYBOARDS, RECORDED OPERATING SYSTEM PROGRAMS, RECORDED OR DOWNLOADABLE COMPUTER PROGRAMS ON THE INTERNET FOR SENDING E-MAIL GREETING CARDS WITH VIDEO CLIPS AND MOBILE STAMPS (U.S. CLS. 21, 23, 26, 36 AND 38).

CLASS 35—ADVERTISING AND BUSINESS

FOR COMPILATION OF INFORMATION IN A COMPUTER DATABASE, SYSTEMIZATION OF INFORMATION IN A COMPUTER DATABASE (U.S. CLS. 100, 101 AND 102).

KRISTINA MORRIS, EXAMINING ATTORNEY

SN 79-051,834. ALTAVIA, FRANCE, FILED 10-5-2007.

ACTIPAPER

PRIORITY DATE OF 4-6-2007 IS CLAIMED.
OWNER OF INTERNATIONAL REGISTRATION 0958556 DATED 10-5-2007, EXPIRES 10-5-2017.

CLASS 9—ELECTRICAL AND SCIENTIFIC APPARATUS

FOR COMPUTER PROGRAMS AND SOFTWARE FOR THE SHARING OF DATA AND INFORMATION IN THE FIELDS OF ADVERTISING AND MARKETING (U.S. CLS. 21, 23, 26, 36 AND 38).

CLASS 16—PAPER GOODS AND PRINTED MATTER

FOR PRINTED MATTER, NAMELY, BOOKS, MAGAZINES, AND PRINTED REVIEWS IN THE FIELDS OF ADVERTISING AND MARKETING, PUBLIC RELATIONS AND COMMUNICATIONS; NEWSPAPERS; FREE PRINTED PUBLICATIONS, NAMELY, PAMPHLETS IN THE FIELDS OF ADVERTISING AND MARKETING, PUBLIC RELATIONS AND COMMUNICATIONS; PRINTED PERIODICALS, DIRECTORIES AND PRINTED COLLECTIONS OF TEXTS AND IMAGES IN THE FIELDS OF ADVERTISING AND MARKETING, PUBLIC RELATIONS AND COMMUNICATIONS; CALENDARS, POSTERS; SMALL POSTERS; ADVERTISEMENTS; BOARDS OF PAPER OR CARDBOARD; PHOTOGRAPHS; PRINTING BLOCKS; ILLUSTRATIONS (U.S. CLS. 2, 5, 22, 23, 29, 37, 38 AND 50).

CLASS 35—ADVERTISING AND BUSINESS

FOR ADVERTISING ESPECIALLY IN THE PRESS, ON THE RADIO, ON TELEVISION AND ON GLOBAL TELECOMMUNICATIONS NETWORKS SUCH AS THE INTERNET AND PRIVATE OR RESTRICTED ACCESS NETWORKS SUCH AS INTRANETS; ADVERTISING MANAGEMENT; ADVERTISING AGENCIES; PUBLICATION OF ADVERTISEMENTS, NAMELY, PUBLISHING OF ADVERTISING TEXTS; DISTRIBUTION OF ADVERTISING MATERIAL; DISSEMINATION OF ADVERTISING MATERIAL ESPECIALLY LEAFLETS, PROSPECTUSES, PRINTED MATTER, AND SAMPLES; ADVERTISING DOCUMENTATION UPDATING; DIRECT MAIL ADVERTISING; SALES PROMOTION AND BUSINESS PROMOTION; SEARCH FOR AND RENTAL OF ADVERTISING SPACE AND TIME FOR THIRD PARTIES, ESPECIALLY IN THE PRESS, ON THE RADIO, ON TELEVISION AND ON GLOBAL TELECOMMUNICATIONS NETWORKS SUCH AS THE INTERNET AND PRIVATE OR RESTRICTED ACCESS NETWORKS SUCH AS INTRANETS; OUTDOOR ADVERTISING; RENTAL OF ADVERTISING EQUIPMENT AND SIGNS; ADVICE ON BUSINESS ORGANISATION AND MANAGEMENT; BUSINESS MANAGEMENT, BUSINESS ADMINISTRATION; OFFICE FUNCTIONS; BUSINESS, COMMERCIAL, BUSINESS ORGANISATION CONSULTING, INFORMATION, EXPERT REPORTS AND ACCOUNT AUDITING; CONSULTING IN MARKETING AND IN MARKETING AND ADVERTISING COMMUNICATION; MARKET STUDIES AND RESEARCH; STATISTICAL INFORMATION AND STUDIES; CONDUCTING OPINION POLLS; BUSINESS MANAGEMENT ASSISTANCE FOR INDUSTRIAL AND COMMERCIAL COMPANIES; BUSINESS INFORMATION ON THE CONTENTS OF MEDIA SYSTEMS, ESPECIALLY THE PRESS, ON THE RADIO, ON TELEVISION AND ON GLOBAL TELECOMMUNICATIONS NETWORKS SUCH AS THE INTERNET AND PRIVATE OR RESTRICTED ACCESS NETWORKS SUCH AS INTRANETS; ARRANGING SUBSCRIPTIONS TO TELECOMMUNICATION SERVICES; NEWSPAPER SUBSCRIPTIONS INCLUDING TO ELECTRONIC NEWSPAPERS AND TO INFORMATION, TEXT, SOUND AND IMAGE MEDIA, NAMELY, SUBSCRIPTIONS TO AN INFORMATION MEDIA PACKAGE; SERVICES CONSISTING OF THE TRANSCRIPTION, COMPILATION AND SYSTEMIZATION OF WRITTEN COMMUNICATIONS AND DATA; BUSINESS MANAGEMENT OF TELECOMMUNICATION NETWORKS AND SITES FOR E-COMMERCE INCLUDING BY MEANS OF COMPUTER NETWORKS; COMPUTERIZED FILE MANAGEMENT; DATA COMPILATION AND SYSTEMATIZATION IN A DATABASE; EDITING AND PUBLISHING OF ADVERTISING TEXTS AND/OR IMAGES IN ALL THEIR FORMS; DOCUMENT REPRODUCTION (U.S. CLS. 100, 101 AND 102).

CLASS 38—COMMUNICATION

FOR NEWS AGENCY SERVICES, NAMELY, THE TRANSMISSION OF NEWS ITEMS TO NEWS REPORTING ORGANIZATIONS; MULTIMEDIA TELECOMMUNICATIONS, NAMELY, TRANSMISSION OF DATA, SOUND AND IMAGES BY CABLE, SATELLITE, TELEPHONE, WIRELESS COMMUNICATION DEVICES AND COMPUTER MEANS AND VIA NETWORKS, INCLUDING VIA GLOBAL TELECOMMUNICATION NETWORKS SUCH AS THE INTERNET AND PRIVATE AND RESTRICTED ACCESS NETWORKS SUCH AS AN INTRANET; TRANSMISSION AND DISTRIBUTION OF DATA, SOUNDS AND IMAGES, COMPUTER ASSISTED OR NOT, BY CABLE, SATELLITE AND VIA NETWORKS, INCLUDING VIA GLOBAL TELECOMMUNICATION NETWORKS SUCH AS THE INTERNET AND PRIVATE AND RESTRICTED ACCESS NETWORKS SUCH AS AN INTRANET; TRANSMISSION SERVICES, WHETHER SECURE OR NOT, ALLOWING THE DISPLAYING OF INFORMATION HELD IN DATABASES OR STORED ON COMPUTER AND/OR INFORMATION ACCESSIBLE BY ACCESS CODE TO COMPUTER OR TELEMATIC DATABASES AND DATABASE SERVER CENTRES, NAMELY, PROVIDING ACCESS TO DATABASES; ELECTRONIC DATA INTERCHANGE; TRANSMISSION OF NEWS AND GENERAL INFORMATION; ELECTRONIC MAIL AND MESSAGING SERVICES; SENDING OF TELEGRAMS; TELECOMMUNICATION SERVICES, NAMELY, TRANSMISSION OF VOICE, DATA, GRAPHICS, IMAGES, AUDIO AND VIDEO BY MEANS OF TELECOMMUNICATIONS NETWORKS, WIRELESS COMMUNICATION NETWORKS, AND THE INTERNET (U.S. CLS. 100, 101 AND 104).

CLASS 40—MATERIAL TREATMENT

FOR ADVICE, CONSULTANCY, INFORMATION AND EXPERT CONSULTATION IN THE FIELDS OF PRINTING, PHOTOCOMPOSITION, PHOTOENGRAVING, RETOUCHING PHOTOGRAPHIC IMAGES; PRINTING, OFFSET PRINTING, LITHOGRAPHIC PRINTING; PHOTO COMPOSING SERVICES (U.S. CLS. 100, 103 AND 106).

CLASS 41—EDUCATION AND ENTERTAINMENT

FOR EDITING AND PUBLISHING OF TEXTS, ILLUSTRATIONS, BOOKS, REVIEWS, NEWSPAPERS, PERIODICALS, MAGAZINES, AND CATALOGUES INCLUDING THE AFORESAID PUBLICATIONS AVAILABLE ON GLOBAL TELECOMMUNICATION NETWORKS, SUCH AS THE INTERNET, AND PRIVATE OR RESTRICTED ACCESS NETWORKS, SUCH AS INTRANETS; SERVICES FOR EDITING, RECORDING, AND PUBLISHING SOUNDS; SERVICES FOR EDITING, RECORDING AND FILMING VIDEOTAPES; OPERATING LOTTERIES; EDITING OF WRITTEN TEXTS; SERVICES PROVIDED BY NEWS REPORTERS AND PHOTO REPORTS, NAMELY, PROVIDING NEWS IN THE NATURE OF CURRENT EVENT REPORTING AND PHOTO JOURNALISM; MICROFILMING FOR OTHERS; DESKTOP PUBLISHING FOR OTHERS (U.S. CLS. 100, 101 AND 107).

CLASS 42—SCIENTIFIC AND COMPUTER SERVICES

FOR COMPUTER PROGRAMMING; DESIGN, INSTALLATION, UPDATING, MAINTENANCE AND MANAGEMENT OF COMPUTER PROGRAMS AND SOFTWARE ESPECIALLY IN THE FIELDS OF MANAGEMENT, MARKETING AND STUDY OF MEDIAS, COMPUTER SYSTEMS, TELECOMMUNICATION SYSTEMS, DATABASE AND COMPUTER SERVERS; FASHION DESIGN; PACKAGING DESIGN SERVICES, GRAPHIC ARTS DESIGN SERVICES; ENGINEERING, SERVICES OF ENGINEERS AND TECHNICAL PROJECT STUDIES, NAMELY, CONDUCTING OF FEASIBILITY STUDIES, ESPECIALLY IN THE FIELD OF CONSUMPTION, COMPUTING, INFORMATION TECHNOLOGIES, AND IN CONNECTION WITH INTERNET SERVICES; QUALITY CONTROL FOR OTHERS IN THE FIELDS OF PRINTING, PHOTOCOMPOSITION, PHOTOENGRAVING, RETOUCHING IMAGES (U.S. CLS. 100 AND 101).
DAYNA BROWNE, EXAMINING ATTORNEY

SN 79-051,899, DEUTSCHLAND -; LAND DER IDEEN E.V., FED REP GERMANY, FILED 8-15-2007.



PRIORITY DATE OF 2-16-2007 IS CLAIMED.
OWNER OF INTERNATIONAL REGISTRATION 0958763 DATED 8-15-2007, EXPIRES 8-15-2017.
THE COLOR(S) BLACK, RED AND YELLOW IS/ARE CLAIMED AS A FEATURE OF THE MARK.
THE COLOR BLACK APPEARS IN THE FIRST THREE FLOWER TOPS; THE COLOR RED APPEARS IN THE MIDDLE THREE FLOWER TOPS AND AS SHADING IN THE LAST THREE FLOWER TOPS; THE COLOR YELLOW APPEARS IN THE LAST THREE FLOWER TOPS.

SN 79-051,890, VHF-TECHNOLOGIES SA, SWITZERLAND, FILED 2-6-2008.

CLASS 8—HAND TOOLS

FOR HAND TOOLS, NAMELY, DRILLS, SHOVELS, SPADES, SCREWDRIVERS; KNIVES, FORKS AND SPOONS (U.S. CLS. 23, 28 AND 44).

CLASS 16—PAPER GOODS AND PRINTED MATTER

FOR PAPER, CARDBOARD AND GOODS MADE OF THESE MATERIALS, NAMELY, BOXES, PRINTED MATTER, NAMELY, PRINTED REPORTS FEATURING INFORMATION ON GERMANY, NEWSPAPERS AND GENERAL FEATURE MAGAZINES, BOOKS IN THE FIELD OF INFORMATION ON GERMANY; BOOK-ENDS; PHOTOGRAPHS; POSTER; STATIONERY; POST-CARDS AND GREETING CARDS; CALENDARS; PAPERWEIGHTS, LETTER OPENERS, WRITING PADS; SQUARE DRAFTING RULERS, RUBBER ERASERS, PAPER FASTENERS, CLIPS FOR OFFICES, NAMELY, PAPER CLIPS; DECALCOMANIAS, TEMPORARY TATTOO, RUBBED PICTURES, STICKERS; WRAPPING PAPER; PARTY ARTICLES MADE OF PAPER AND/OR CARDBOARD, NAMELY, FLAGS, PAPER PENNANTS, TABLE DECORATION, NAPKINS, TABLECLOTHS; WRITING INSTRUMENTS; DRAWING, PAINTING AND MODELING MATERIALS, NAMELY, DRAWING BRUSHES, PAINT BRUSHES, MODELING CLAY (U.S. CLS. 2, 5, 22, 23, 29, 37, 38 AND 50).

flexcell

THE MARK CONSISTS OF STANDARD CHARACTERS WITHOUT CLAIM TO ANY PARTICULAR FONT, STYLE, SIZE, OR COLOR.

PRIORITY DATE OF 8-9-2007 IS CLAIMED.
OWNER OF INTERNATIONAL REGISTRATION 0958748 DATED 2-6-2008, EXPIRES 2-6-2018.
OWNER OF U.S. REG. NO. 2,903,128.

CLASS 9—ELECTRICAL AND SCIENTIFIC APPARATUS

FOR ELECTRIC BATTERIES; CHARGERS FOR ELECTRIC BATTERIES; ELECTRICAL CONDUCTORS; GLASS COVERED WITH AN ELECTRICAL CONDUCTOR; SOLAR BATTERIES; PHOTOVOLTAIC MODULES, CELLS, FILMS AND TARPULINS; APPARATUS FOR CONVERTING ELECTRONIC RADIATION TO ELECTRICAL ENERGY, NAMELY, PHOTOVOLTAIC SOLAR MODULES, PHOTOVOLTAIC ROOFING MEMBRANES, PHOTOVOLTAIC CLADDING PANELS; PHOTOVOLTAIC CHARGING DEVICES (U.S. CLS. 21, 23, 26, 36 AND 38).

CLASS 21—HOUSEWARES AND GLASS

FOR UTENSILS, NAMELY, SPATULAS, STRAINERS, WHISKS; CONTAINERS FOR THE HOUSEHOLD AND KITCHEN; BEVERAGE GLASSWARE; WORKS OF ART IN PORCELAIN AND EARTHENWARE, AS FAR AS THEY ARE NOT INCLUDED IN OTHER CLASSES (U.S. CLS. 2, 13, 23, 29, 30, 33, 40 AND 50).

CLASS 25—CLOTHING

FOR CLOTHING, NAMELY, SHIRTS, PANTS, UNDERWEAR, BANDANNAS, FOOTWEAR, HEADGEAR, NAMELY, HATS, CAPS, HEADBANDS (U.S. CLS. 22 AND 39).

CLASS 19—NON-METALLIC BUILDING MATERIALS

FOR NON-METALLIC ROOFING INCORPORATING PHOTOVOLTAIC CELLS (U.S. CLS. 1, 12, 33 AND 50).
SANDRA MANIOS, EXAMINING ATTORNEY

CLASS 28—TOYS AND SPORTING GOODS

FOR PARTY ARTICLES MADE OF PAPER AND/OR CARDBOARD, NAMELY, STREAMERS (U.S. CLS. 22, 23, 38 AND 50).

CLASS 35—ADVERTISING AND BUSINESS

FOR ADVERTISING FOR FOREIGN TRADE PROMOTION; MARKETING PROMOTION; FOREIGN TRADE ADVERTISEMENT; PROVIDING BUSINESS INFORMATION AND ORGANIZATIONAL ADVICE, PARTICULARLY ORGANIZATIONAL ADVICE IN BUSINESS MATTERS, ESPECIALLY IN BILATERAL TRADE; ORGANIZING FAIRS AND EXHIBITIONS FOR BUSINESS AND PUBLICITY PURPOSES FOR OTHERS; MARKET RESEARCH AND BUSINESS ANALYSES; SERVICES IN COMMERCIAL AND BUSINESS MATTERS, NAMELY, BUSINESS ADVICE AND COMMERCIAL INFORMATION; BUSINESS ORGANIZATION ADVICE; PUBLICITY WORK; MARKETING PROMOTION FOR THE FEDERAL REPUBLIC OF GERMANY; PRODUCING ECONOMIC FORECASTS; INVESTIGATIONS IN BUSINESS MATTERS; SPONSORING IN TERMS OF ADVERTISING; BUSINESS INVESTIGATIONS, NAMELY, DATA SEARCH IN COMPUTER FILES AND THE INTERNET FOR THIRD PARTIES, IN THE SCIENTIFIC AND RESEARCH FIELDS (U.S. CLS. 100, 101 AND 102).

CLASS 41—EDUCATION AND ENTERTAINMENT

FOR EDUCATION AND FURTHER EDUCATION, NAMELY, PROVIDING CLASSES, SEMINARS, WORKSHOPS IN THE FIELD OF INFORMATION ON GERMANY; ORGANIZING EDUCATIONAL CONGRESSES, CONFERENCES, SYMPOSIA IN THE FIELD OF INFORMATION ON GERMANY; EDITING AND PUBLISHING OF BOOKS, NEWSPAPERS, JOURNALS AND OTHER PRINTED PRODUCTS, EXCEPT FOR ADVERTISING PURPOSES, ALSO IN ELECTRONIC FORM; EDUCATION, NAMELY, PROVIDING CLASSES, SEMINARS, WORKSHOPS IN THE FIELD OF INFORMATION ON GERMANY; TRAINING IN THE FIELD OF INFORMATION ON GERMANY; CORRESPONDENCE COURSES IN THE FIELD OF INFORMATION ON GERMANY; EDUCATIONAL ADVICE; ORGANIZING AND HOLDING COMMUNITY CULTURAL AND/OR SPORTING EVENTS; ORGANIZING EXHIBITIONS FOR CULTURAL OR TRAINING PURPOSES; ORGANIZING AND HOLDING EDUCATIONAL WORKSHOPS IN THE FIELD OF INFORMATION ON GERMANY (U.S. CLS. 100, 101 AND 107).

CLASS 42—SCIENTIFIC AND COMPUTER SERVICES

FOR PRODUCING DATA PROCESSING PROGRAMS; INFORMATION TECHNOLOGY CONSULTATION, NAMELY, ADVICE IN TECHNOLOGY TRANSFER AND PROVISION OF TECHNICAL KNOW-HOW; SCIENTIFIC RESEARCH; PERFORMING TECHNICAL MEASUREMENTS IN THE FIELD OF PHYSICS AND CHEMISTRY; PERFORMING SCIENTIFIC INVESTIGATIONS FOR MEDICAL PURPOSES; EDP ADVICE, NAMELY, DEVELOPMENT OF TECHNOLOGIES FOR THE FABRICATION OF CIRCUITS FOR ELECTRONIC DATA PROCESSING; DESIGN OF PRODUCTION FACILITIES, NAMELY, DEVELOPMENT OF PRODUCTIVITY CONCEPTS FROM THE TECHNOLOGICAL POINT OF VIEW; DEVELOPMENT AND RESEARCH SERVICES CONCERNING NEW PRODUCTS FOR THIRD PARTIES; QUALITY CONTROL FOR OTHERS; TECHNICAL PROJECT PLANNING, NAMELY, PLANNING, DEVELOPMENT AND TECHNICAL SUPPORT OF ELECTRONIC COMMUNICATIONS NETWORKS; TECHNICAL PROJECT MANAGEMENT IN THE ELECTRONIC DATA PROCESSING FIELD, NAMELY, PLANNING, DEVELOPMENT AND TECHNICAL SUPPORT OF ELECTRONIC COMMUNICATIONS NETWORKS (U.S. CLS. 100 AND 101).

CLASS 45—PERSONAL AND LEGAL SERVICES

FOR ADVICE RELATING TO THE LICENSING OF INDUSTRIAL PROPERTY RIGHTS AND COPYRIGHTS; LEGAL ADVICE AND OTHER ADVICE IN CONNECTION WITH NATIONAL AND INTERNATIONAL LAWS IN ANY GIVEN LEGISLATION PROCESS (U.S. CLS. 100 AND 101).

AISHA SALEM, EXAMINING ATTORNEY

SN 79-052,046. AIRTIST, FRANCE, FILED 2-29-2008.



PRIORITY DATE OF 9-25-2007 IS CLAIMED.
OWNER OF INTERNATIONAL REGISTRATION 0959121 DATED 2-29-2008, EXPIRES 2-28-2018.

THE MARK CONSISTS OF THE WORDING "AIRTIST" TO THE LEFT OF A HEART WITH A STAR IN THE CENTER.

CLASS 35—ADVERTISING AND BUSINESS

FOR ADVERTISING SERVICES, ADVERTISING AGENCY SERVICES, BUSINESS MANAGEMENT, BUSINESS ADMINISTRATION, COMPUTER FILE MANAGEMENT, ONLINE ADVERTISING ON A COMPUTER NETWORK, RENTAL OF ADVERTISING TIME ON ALL MEANS OF COMMUNICATION; RENTAL OF ADVERTISING SPACE, PUBLISHING OF PUBLICITY TEXTS, QUALITATIVE AND QUANTITATIVE BUSINESS MANAGEMENT OF ADVERTISEMENTS, ORGANISATION OF EXHIBITIONS FOR COMMERCIAL AND ADVERTISING PURPOSES (U.S. CLS. 100, 101 AND 102).

CLASS 41—EDUCATION AND ENTERTAINMENT

FOR EDUCATION SERVICES, NAMELY, PROVIDING CLASSES, SEMINARS, WORKSHOPS IN THE FIELD OF TELECOMMUNICATIONS AND ENTERTAINMENT, NAMELY, MUSIC, CINEMA AND PHOTOGRAPHY, ENTERTAINMENT IN THE NATURE OF LIVE COMEDY, SHOWS, CONCERTS, MUSICAL SHOWS, PHOTO REPORTS, INFORMATION ON EDUCATION AND ENTERTAINMENT, BOOK PUBLISHING, FILM PRODUCTION, VIDEOTAPE FILM PRODUCTION, RENTAL OF CINEMATOGRAPHIC FILMS, RENTAL OF SOUND RECORDINGS, VIDEOTAPE EDITING, ARRANGING OF EDUCATIONAL AND ENTERTAINMENT COMPETITIONS IN THE FIELD OF MUSIC, CINEMA, PHOTOGRAPHY, ORGANIZATION OF EXHIBITIONS FOR CULTURAL OR EDUCATIONAL PURPOSES, BOOKING OF SEATS FOR SHOWS, ENTERTAINMENT SERVICES, NAMELY, PROVIDING ONLINE COMPUTER GAMES, PUBLICATION OF ELECTRONIC BOOKS AND NEWSPAPERS ONLINE, DESKTOP PUBLISHING, EDITING OF RADIO AND TELEVISION PROGRAMS, ENTERTAINMENT SERVICES, NAMELY, PROVIDING A RADIO AND TELEVISION PROGRAMS IN THE FIELD OF MUSIC, CINEMA, AND PHOTOGRAPHY (U.S. CLS. 100, 101 AND 107).

DAVID HOFFMAN, EXAMINING ATTORNEY

SN 79-052,119. KAROLINSKA INSTITUTET, SWEDEN, FILED 2-14-2008.



THE MARK CONSISTS OF STANDARD CHARACTERS WITHOUT CLAIM TO ANY PARTICULAR FONT, STYLE, SIZE, OR COLOR.

PRIORITY DATE OF 1-21-2008 IS CLAIMED.
OWNER OF INTERNATIONAL REGISTRATION 0959359 DATED 2-14-2008, EXPIRES 2-14-2018.

CLASS 38—COMMUNICATION

FOR DIGITAL TRANSFER SERVICES AND TRANSMISSION SERVICES VIA THE INTERNET; IP (INTERNET PROTOCOL) COMMUNICATION SERVICES FOR WEB AND MOBILE TELEPHONY; PROVIDING MULTIPLE-USER ACCESS TO A GLOBAL COMPUTER INFORMATION NETWORK; PROVISION OF USER ACCESS TO GLOBAL COMPUTER NETWORKS (U.S. CLS. 100, 101 AND 104).

CLASS 42—SCIENTIFIC AND COMPUTER SERVICES

FOR LABORATORY RESEARCH IN THE FIELD OF GENETICS; PHYSICS RESEARCH; INDUSTRIAL ANALYSIS AND RESEARCH SERVICES IN THE FIELD OF GENETICS; RESEARCH SERVICES IN THE FIELD OF INFORMATION AND TELECOMMUNICATIONS TECHNOLOGY, NAMELY, TRANSFER OPTION STUDIES RELATED TO COMPUTER INFORMATION SYSTEMS; BIOLOGICAL RESEARCH; BIOLOGICAL DEVELOPMENT SERVICES; MEDICAL LABORATORY SERVICE (U.S. CLS. 100 AND 101).

MARIA-VICTORIA SUAREZ, EXAMINING ATTORNEY

SN 79-052,208. GIVAUDAN S.A., SWITZERLAND, FILED 3-12-2008.

BLOOMTECH

THE MARK CONSISTS OF STANDARD CHARACTERS WITHOUT CLAIM TO ANY PARTICULAR FONT, STYLE, SIZE, OR COLOR.

PRIORITY DATE OF 10-5-2007 IS CLAIMED.
OWNER OF INTERNATIONAL REGISTRATION 0959586 DATED 3-12-2008, EXPIRES 3-12-2018.

CLASS 1—CHEMICALS

FOR CHEMICALS FOR USE IN THE MANUFACTURE OF PERFUMERY, COSMETICS, SOAP AND DETERGENT COMPOSITIONS (U.S. CLS. 1, 5, 6, 10, 26 AND 46).

CLASS 3—COSMETICS AND CLEANING PREPARATIONS

FOR PERFUMERY, PERFUMES, COSMETICS, SOAPS AND DETERGENTS (U.S. CLS. 1, 4, 6, 50, 51 AND 52).
WARREN L. OLANDRIA, EXAMINING ATTORNEY

SN 79-052,238. THE ROYAL BANK OF SCOTLAND GROUP PLC, UNITED KINGDOM, FILED 11-1-2007.



PRIORITY DATE OF 9-7-2007 IS CLAIMED.
OWNER OF INTERNATIONAL REGISTRATION 0959688 DATED 11-1-2007, EXPIRES 11-1-2017.

CLASS 9—ELECTRICAL AND SCIENTIFIC APPARATUS

FOR ENCODED MAGNETIC CARDS; MAGNETICALLY ENCODED CARDS FOR CARRYING IDENTITY DATA; BANK CARDS, NAMELY, MAGNETICALLY ENCODED CASH CARDS, CHARGE CARDS, CHEQUE CARDS, DEBIT CARDS, AND CREDIT CARDS; AUTOMATIC TELLER MACHINE; MAGNETICALLY ENCODED LOYALTY CARDS; BLANK MAGNETIC DATA CARRIERS; ELECTRONIC PUBLICATIONS, NAMELY, NEWSLETTERS, MAGAZINES, PERIODICALS, PAMPHLETS, LEAFLETS, INSTRUCTIONAL MATERIALS AND TEACHING MATERIALS IN THE FIELD OF BANKING, INSURANCE, FINANCE AND CREDIT CARD SERVICES, PROVIDED VIA ON-LINE COMPUTER DATABASES, GLOBAL COMPUTER NETWORKS AND VIA THE INTERNET; COMPUTER SOFTWARE FOR PROVIDING FINANCIAL AND BANKING TRANSACTIONS INCLUDING FOREIGN EXCHANGE AND FOREIGN EXCHANGE TRANSACTION SERVICES; COMPUTER SOFTWARE FOR FACILITATING OR ENABLING ACCESS TO BUSINESS SERVICES, FINANCIAL SERVICES, BANKING SERVICES, AND BANK ACCOUNT MANAGEMENT SERVICES (U.S. CLS. 21, 23, 26, 36 AND 38).

CLASS 16—PAPER GOODS AND PRINTED MATTER

FOR PRINTED PUBLICATIONS, NAMELY, BROCHURES, PAMPHLETS, BOOKLETS, CATALOGS, FLYERS, LEAFLETS, NEWSLETTERS, BOOKS AND CIRCULARS IN THE FIELDS OF BANKING, INSURANCE, FINANCE AND CREDIT CARD SERVICES; PRINTED ADVERTISING MATERIALS, NAMELY, BUSINESS CARDS, POSTERS, AND PAPER BANNERS; VOUCHER BOOKS; CHEQUES, CHEQUE BOOKS, BANK DEPOSIT BOOKS; BANK CARDS, CASH CARDS, CHARGE CARDS, CHEQUE CARDS, DEBIT CARDS, CREDIT CARDS AND LOYALTY CARDS, WITHOUT MAGNETIC CODING; CHEQUE BOOK HOLDERS (U.S. CLS. 2, 5, 22, 23, 29, 37, 38 AND 50).

CLASS 35—ADVERTISING AND BUSINESS

FOR FINANCIAL AFFAIRS, NAMELY, FINANCIAL PLANNING, FINANCIAL RESEARCH, FINANCIAL RISK MANAGEMENT, FINANCIAL EXCHANGE, AND FINANCIAL FORECASTING; MONETARY AFFAIRS, NAMELY, CASH MANAGEMENT INVESTMENT FUND ADMINISTRATION, ACQUISITION AND TRANSFER OF MONETARY CLAIMS, MONETARY EXCHANGE AND MONEY ORDER SERVICES; BANKING SERVICES; FINANCIAL SERVICES, NAMELY, FINANCIAL CONSULTING SERVICES; INVESTMENT MANAGEMENT SERVICES; MORTGAGE LENDING SERVICES; ADMINISTRATION OF EMPLOYEE PENSION PLANS; SAVINGS ACCOUNT SERVICES; BANK ACCOUNT SERVICES, NAMELY, SAVINGS ACCOUNT, CHECKING ACCOUNT, MONEY MARKET AND ANNUITY ACCOUNTS; CURRENT BANK ACCOUNT SERVICES, NAMELY, SAVINGS ACCOUNT, CHECKING ACCOUNT, MONEY MARKET AND ANNUITY ACCOUNTS; AUTOMATED BANKING SERVICES; ELECTRONIC BANKING, BROKERAGE AND FUNDS TRANSFER SERVICES; CASH DISPENSING SERVICES; CASH CARD SERVICES; CREDIT CARD SERVICES; DEBIT CARD SERVICES; HOME BANKING; TELEPHONE BANKING; INTERNET BANKING; ON-LINE BANKING; BUSINESS BANKING SERVICES; FOREIGN EXCHANGE SERVICES AND FOREIGN EXCHANGE TRANSACTIONS SERVICES, FINANCIAL TRANSACTION RELATING TO CURRENCY SWAPS, FOREIGN MONETARY ADVISORY SERVICE, PROVISION OF PRICING INFORMATION ABOUT MONEY MARKET RATES; FORECASTING OF FOREIGN EXCHANGE RATES; ARRANGING AND FINANCING OF LOANS; TANGIBLE AND INTANGIBLE ASSET FINANCING; BROKERAGE OF STOCKS, BONDS AND SECURITIES; CREDIT AGENCY SERVICES; FINANCIAL MANAGEMENT OF MUTUAL FUNDS; FINANCIAL FORECASTING AND PLANNING; PROFIT AND CASH FLOW FORECASTING AND PLANNING; INTERNATIONAL BANKING SERVICES; ISSUING LETTERS OF CREDIT; PROVISION OF FINANCIAL GUARANTEES; ELECTRONIC AND TELEGRAPHIC PAYMENT TRANSFER SERVICES, NAMELY, ELECTRONIC PROCESSING AND

TRANSMISSION OF BILL PAYMENT DATA; ISSUING AND REDEMPTION OF BANK DRAFTS, CURRENCY ACCOUNTS AND CURRENCY EXCHANGE SERVICES; COLLECTION AGENCY, NAMELY, COLLECTION OF PAYMENT AGAINST SHIPPING DOCUMENTS AND BILLS OF EXCHANGE; FINANCIAL ADVICE AND INFORMATION; INVESTMENT ADVICE AND INFORMATION; BANK ACCOUNT INFORMATION AND INFORMATION RELATING TO BANK ACCOUNTS; FINANCIAL SERVICES, NAMELY, FINANCIAL PORTFOLIO MANAGEMENT SERVICES FOR OTHERS AND BANK ACCOUNT INFORMATION PROVIDED ON-LINE FROM A COMPUTER DATABASE, COMPUTER NETWORK, GLOBAL COMPUTER NETWORK OR THE INTERNET; INFORMATION AND ADVICE RELATING TO BANKING, FINANCE, INSURANCE, INVESTMENT, MORTGAGES, PENSIONS AND SAVINGS, PROVIDED ON-LINE FROM A COMPUTER DATABASE, COMPUTER NETWORK, GLOBAL COMPUTER NETWORK AND VIA THE INTERNET; ADVISORY, CONSULTANCY, INFORMATION AND HELPLINE SERVICES RELATING TO ALL THE AFORESAID SERVICES (U.S. CLS. 100, 101 AND 102).

CLASS 36—INSURANCE AND FINANCIAL

FOR FINANCIAL AFFAIRS, NAMELY, FINANCIAL PLANNING, FINANCIAL RESEARCH, FINANCIAL RISK MANAGEMENT, FINANCIAL EXCHANGE, AND FINANCIAL FORECASTING; MONETARY AFFAIRS, NAMELY, CASH MANAGEMENT INVESTMENT FUND ADMINISTRATION, ACQUISITION AND TRANSFER OF MONETARY CLAIMS, MONETARY EXCHANGE AND MONEY ORDER SERVICES; BANKING SERVICES; FINANCIAL SERVICES, NAMELY, FINANCIAL CONSULTING SERVICES; INVESTMENT MANAGEMENT SERVICES; MORTGAGE LENDING SERVICES; ADMINISTRATION OF EMPLOYEE PENSION PLANS; SAVINGS ACCOUNT SERVICES; BANK ACCOUNT SERVICES, NAMELY, SAVINGS ACCOUNT, CHECKING ACCOUNT, MONEY MARKET AND ANNUITY ACCOUNTS; CURRENT BANK ACCOUNT SERVICES, NAMELY, SAVINGS ACCOUNT, CHECKING ACCOUNT, MONEY MARKET AND ANNUITY ACCOUNTS; AUTOMATED BANKING SERVICES; ELECTRONIC BANKING, BROKERAGE AND FUNDS TRANSFER SERVICES; CASH DISPENSING SERVICES; CASH CARD SERVICES; CREDIT CARD SERVICES; DEBIT CARD SERVICES; HOME BANKING; TELEPHONE BANKING; INTERNET BANKING; ON-LINE BANKING; BUSINESS BANKING SERVICES; FOREIGN EXCHANGE SERVICES AND FOREIGN EXCHANGE TRANSACTIONS SERVICES, FINANCIAL TRANSACTION RELATING TO CURRENCY SWAPS, FOREIGN MONETARY ADVISORY SERVICE, PROVISION OF PRICING INFORMATION ABOUT MONEY MARKET RATES; FORECASTING OF FOREIGN EXCHANGE RATES; ARRANGING AND FINANCING OF LOANS; TANGIBLE AND INTANGIBLE ASSET FINANCING; BROKERAGE OF STOCKS, BONDS AND SECURITIES; CREDIT AGENCY SERVICES; FINANCIAL MANAGEMENT OF MUTUAL FUNDS; FINANCIAL FORECASTING AND PLANNING; PROFIT AND CASH FLOW FORECASTING AND PLANNING; INTERNATIONAL BANKING SERVICES; ISSUING LETTERS OF CREDIT; PROVISION OF FINANCIAL GUARANTEES; ELECTRONIC AND TELEGRAPHIC PAYMENT TRANSFER SERVICES, NAMELY, ELECTRONIC PROCESSING AND TRANSMISSION OF BILL PAYMENT DATA; ISSUING AND REDEMPTION OF BANK DRAFTS, CURRENCY ACCOUNTS AND CURRENCY EXCHANGE SERVICES; COLLECTION AGENCY, NAMELY, COLLECTION OF PAYMENT AGAINST SHIPPING DOCUMENTS AND BILLS OF EXCHANGE; FINANCIAL ADVICE AND INFORMATION; INVESTMENT ADVICE AND INFORMATION; BANK ACCOUNT INFORMATION AND INFORMATION RELATING TO BANK ACCOUNTS; FINANCIAL SERVICES, NAMELY, FINANCIAL PORTFOLIO MANAGEMENT SERVICES FOR OTHERS AND BANK ACCOUNT INFORMATION PROVIDED ON-LINE FROM A COMPUTER DATABASE, COMPUTER NETWORK, GLOBAL COMPUTER NETWORK OR THE INTERNET; INFORMATION AND ADVICE RELATING TO BANKING, FINANCE, INSURANCE, INVESTMENT, MORTGAGES, PENSIONS AND SAVINGS, PROVIDED ON-LINE FROM A COMPUTER DATABASE, COMPUTER NETWORK, GLOBAL COMPUTER NETWORK AND VIA THE INTERNET; ADVISORY, CONSULTANCY,

INFORMATION AND HELPLINE SERVICES RELATING TO ALL THE AFORESAID SERVICES (U.S. CLS. 100, 101 AND 102).

PAULA MAHONEY, EXAMINING ATTORNEY

SN 79-052,452. AHT COOLING SYSTEMS GMBH.; NL DEUTSCHLAND, FED REP GERMANY, FILED 10-19-2007.



PRIORITY DATE OF 4-30-2007 IS CLAIMED. OWNER OF INTERNATIONAL REGISTRATION 0960418 DATED 10-19-2007, EXPIRES 10-19-2017.

OWNER OF U.S. REG. NOS. 2,568,852 AND 3,083,046.

THE COLOR(S) BLUE, RED AND WHITE IS/ARE CLAIMED AS A FEATURE OF THE MARK.

THE MARK CONSISTS OF THE COLOR(S) BLUE, RED AND WHITE, WITH THE COLOR BLUE APPEARING IN THE WORDING "COOLPOINT", IN THE CIRCLE AND IN THE INNER CURVED LINE; THE COLOR RED APPEARING IN THE WORDING "AHT", IN THE OUTER CURVED LINE AND IN THE TOP, MIDDLE AND BOTTOM HORIZONTAL LINES; AND THE COLOR WHITE IN THE MIDDLE CURVED LINE AND IN THE HORIZONTAL LINES BETWEEN THE TOP AND MIDDLE AND BETWEEN THE MIDDLE AND BOTTOM HORIZONTAL LINES.

CLASS 11—ENVIRONMENTAL CONTROL APPARATUS

FOR REFRIGERATING APPARATUS, NAMELY, UPRIGHT FREEZERS, CHEST FREEZERS, CHEST REFRIGERATORS, DISPLAY FREEZERS, COUNTERTOP REFRIGERATORS, BECK BAR REFRIGERATORS, UPRIGHT REFRIGERATORS, OPEN FRONT REFRIGERATORS, DISPLAY REFRIGERATORS, TOP OPENING REFRIGERATORS, COFFIN STYLE FREEZERS, COFFIN STYLE REFRIGERATORS, HORIZONTAL FREEZERS, HORIZONTAL REFRIGERATORS, REACH-IN FREEZERS, PORTABLE THERMOELECTRIC COOLING UNIT FOR FOOD AND BEVERAGES, REACH-IN REFRIGERATORS, GLASS DOOR FREEZERS, GLASS DOOR REFRIGERATORS, LID FREEZERS, LID REFRIGERATORS, SCOOPING FREEZERS; FREEZERS AND TOP-OPENING FREEZERS (U.S. CLS. 13, 21, 23, 31 AND 34).

CLASS 35—ADVERTISING AND BUSINESS

FOR MARKETING SERVICES RELATING TO SALE OF REFRIGERATING APPARATUS, FREEZERS AND TOP-OPENING FREEZERS; BUSINESS CONSULTANCY SERVICES RELATING TO SALE AND DISTRIBUTION OF REFRIGERATING APPARATUS, FREEZERS AND TOP-OPENING FREEZERS; BUSINESS MANAGEMENT; BUSINESS ADMINISTRATION, OFFICE FUNCTIONS, NAMELY, PROVIDING OFFICE FUNCTIONS; ADVERTISING (U.S. CLS. 100, 101 AND 102).

CLASS 37—CONSTRUCTION AND REPAIR

FOR REPAIR, NAMELY, REPAIR AND MAINTENANCE OF REFRIGERATING APPARATUS, FREEZERS AND TOP-OPENING FREEZERS (U.S. CLS. 100, 103 AND 106).

CLASS 42—SCIENTIFIC AND COMPUTER SERVICES

FOR TECHNICAL INSPECTIONS OF REFRIGERATING APPARATUS, FREEZERS AND TOP-OPENING FREEZERS PROVIDED AS AN AFTER SALE SERVICE (U.S. CLS. 100 AND 101).

MEGHAN REINHART, EXAMINING ATTORNEY

SN 79-052,462. IGA FINANCE B.V., NETHERLANDS, FILED
12-27-2007.



PRIORITY DATE OF 8-14-2007 IS CLAIMED.
OWNER OF INTERNATIONAL REGISTRATION 0960433
DATED 12-27-2007, EXPIRES 12-27-2017.
THE MARK CONSISTS OF TWO STYLIZED LETTER "C"US
LINKED TOGETHER THROUGH A STYLIZED LETTER
"R".

CLASS 9—ELECTRICAL AND SCIENTIFIC APPARATUS

FOR OPTICAL INSTRUMENTS, APPARATUS AND
EQUIPMENT, NAMELY, OPTICAL LENSES, OPERA
GLASSES, GOGGLES FOR SPORTS, CASES FOR CON-
TACT LENSES, PINCE-NEZ; SPECTACLES, SUN-
GLASSES, SPECTACLE FRAMES; MONOCLES;
LORGNETTES; PARTS, MOUNTINGS, CHAINS AND
OTHER ACCESSORIES NOT INCLUDED IN OTHER
CLASSES, COMPONENTS AND CASES FOR THE ABOVE
GOODS, NAMELY, PINCE-NEZ MOUNTINGS, CASES
FOR SPECTACLES AND SUNGLASSES, CASES FOR
PINCE-NEZ, CHAINS FOR SPECTACLES AND FOR
SUNGLASSES, FRAMES FOR SPECTACLES AND SUN-
GLASSES, EYEGLASS CORDS; MOBILE PHONES WITH
SUPPORT FOR APPLICATION SOFTWARE; ANTENNAS
FOR MOBILE PHONES; BATTERIES FOR MOBILE
PHONES; STEP-UP TRANSFORMERS FOR MOBILE
PHONES; POWER SUPPLIERS FOR MOBILE PHONES;
BAGS AND CASING FOR MOBILE PHONES, NAMELY
SPECIALTY HOLSTER BAGS FOR CARRYING MOBILE
PHONES AND CASES FOR MOBILE PHONES; FACINGS
FOR MOBILE PHONES, NAMELY, FACEPLATES FOR
MOBILE PHONES; ATTACHMENT SYSTEMS, NAMELY,
MOBILE PHONE STRAPS; CARRYING CASES FOR
MOBILE PHONES; MICROPHONES FOR MOBILE
PHONES; LOUDSPEAKERS FOR MOBILE PHONES;
EARPHONES FOR MOBILE PHONES; HANDS-FREE
KITS FOR MOBILE PHONES (U.S. CLS. 21, 23, 26, 36
AND 38).

CLASS 14—JEWELRY

FOR PRECIOUS METALS AND THEIR ALLOYS;
GOODS MADE OR COATED WITH PRECIOUS METALS
AND THEIR ALLOYS BUT NOT INCLUDED IN OTHER
CLASSES, NAMELY IMITATION JEWELLERY, CUFF
LINKS, TIE PINS, TIE CLIPS, JEWELRY CASES, BOXES
OF PRECIOUS METAL, FIGURINES OF PRECIOUS
METAL, WORKS OF ART OF PRECIOUS METAL;
JEWELLERY, PRECIOUS STONES; HOROLOGICAL
AND CHRONOMETRIC INSTRUMENTS (U.S. CLS. 2,
27, 28 AND 50).

CLASS 18—LEATHER GOODS

FOR LEATHER AND IMITATION LEATHER, HAND-
BAGS, WALLETS TRAVELING BAGS, ATTACHE CASES,
CARRIER BAGS, BRIEFCASES MADE OF LEATHER-
WARE, SPORTS BAGS NOT INCLUDED IN OTHER
CLASSES, NAMELY, BAGS AND HOLDALLS FOR
SPORTS CLOTHING, TRAVELING TRUNKS;
SHOULDER BAGS, TRAVELING BAGS, INCLUDING
GARMENT BAGS FOR TRAVEL, KEY CASES, UMBREL-
LAS, PARASOLS, WALKING STICKS, WHIPS, HARNESS
AND SADDLERY (U.S. CLS. 1, 2, 3, 22 AND 41).

CLASS 25—CLOTHING

FOR CLOTHING FOR MEN, WOMEN AND CHIL-
DREN, NAMELY, BELTS, COATS, RAINCOATS, WAIST-
COATS, BLOUSES AND PULLOVERS, JACKETS,
TROUSERS, SKIRTS, DRESSES, SUITS, SHIRTS,
SHORT-SLEEVED SHIRTS, T-SHIRTS, JERSEYS, UN-
DERWEAR, SOCKS AND STOCKINGS, GLOVES, TIES,
SCARVES, HATS, KNITTED CAPS, BOOTS, SHOES AND
SLIPPERS (U.S. CLS. 22 AND 39).

MEGHAN REINHART, EXAMINING ATTORNEY

SN 79-052,520. WILEX AG, FED REP GERMANY, FILED 3-
19-2008.

MESUPRON

THE MARK CONSISTS OF STANDARD CHARACTERS
WITHOUT CLAIM TO ANY PARTICULAR FONT, STYLE,
SIZE, OR COLOR.

PRIORITY DATE OF 10-8-2007 IS CLAIMED.
OWNER OF INTERNATIONAL REGISTRATION 0960551
DATED 3-19-2008, EXPIRES 3-19-2018.

CLASS 5—PHARMACEUTICALS

FOR PHARMACEUTICAL PREPARATIONS FOR THE
TREATMENT OF CANCER, ONCOLOGICAL DISEASES
AS WELL AS NEUROLOGICAL DISEASES; DIAGNOS-
TIC AGENTS, PREPARATIONS AND SUBSTANCES FOR
MEDICAL PURPOSES; MEDICINES FOR THE TREAT-
MENT OF CANCER, ONCOLOGICAL DISEASES AND
NEUROLOGICAL DISEASES (U.S. CLS. 6, 18, 44, 46, 51
AND 52).

CLASS 42—SCIENTIFIC AND COMPUTER SERVICES

FOR RESEARCH IN THE FIELD OF BIOTECHNOL-
OGY AND DEVELOPMENT OF PHARMACEUTICAL
PREPARATIONS AND MEDICINE (U.S. CLS. 100 AND
101).

MARILYN IZZI, EXAMINING ATTORNEY

SN 79-052,611. LIDL STIFTUNG & CO. KG, FED REP GERMANY, FILED 4-4-2008.

dentalux

THE MARK CONSISTS OF STANDARD CHARACTERS WITHOUT CLAIM TO ANY PARTICULAR FONT, STYLE, SIZE, OR COLOR.

PRIORITY DATE OF 1-17-2008 IS CLAIMED.

OWNER OF INTERNATIONAL REGISTRATION 0960878 DATED 4-4-2008, EXPIRES 4-4-2018.

OWNER OF U.S. REG. NO. 2,685,424.

THE WORDING "DENTALUX" IN THE MARK HAS NO ANY MEANING IN A FOREIGN LANGUAGE.

CLASS 3—COSMETICS AND CLEANING PREPARATIONS

FOR DENTIFRICES, NOT FOR MEDICAL PURPOSES, MOUTHWASHES, PREPARATIONS FOR ORAL AND DENTAL HYGIENE, NAMELY, NON-MEDICATED DENTAL RINSE, TOOTH POWDER, TOOTH BLEACHING PREPARATIONS, TOOTH CLEANING PREPARATIONS, TOOTH GEL, TOOTH PASTE, TOOTH WHITENING CREAMS AND GELS, TEETH BLEACHING PREPARATIONS, AND TOOTH POLISH (U.S. CLS. 1, 4, 6, 50, 51 AND 52).

CLASS 21—HOUSEWARES AND GLASS

FOR TOOTHBRUSHES (U.S. CLS. 2, 13, 23, 29, 30, 33, 40 AND 50).

EVERLYN BRADLEY, EXAMINING ATTORNEY

SN 79-052,909. DSM IP ASSETS B.V., NETHERLANDS, FILED 3-5-2008.



PRIORITY DATE OF 9-6-2007 IS CLAIMED.
OWNER OF INTERNATIONAL REGISTRATION 0961693 DATED 3-5-2008, EXPIRES 3-5-2018.

THE MARK CONSISTS OF A LARGE STYLIZED LETTER "Q" WITH A HEART SHAPE WHERE THE LINES NORMALLY INTERSECT, AND THE TERMS "QUALITY FOR LIFE" BELOW WITH THE SAME DESIGN IN THE "Q" IN "QUALITY".

CLASS 1—CHEMICALS

FOR CHEMICALS AND BIOCHEMICALS USED IN INDUSTRY, IN AGRICULTURE, HORTICULTURE AND FORESTRY; CHEMICALS AND BIOCHEMICALS FOR USE IN THE MANUFACTURE OF FOOD, ANIMAL FOOD, BEVERAGES, PHARMACEUTICAL PREPARATIONS AND COSMETICS; CHEMICAL AND BIOCHEMICAL PRODUCTS FOR PRESERVING FOODSTUFFS AND BEVERAGES; CHEMICALS AND BIOCHEMICALS FOR USE AS FLAVORINGS IN THE FOOD INDUSTRY (U.S. CLS. 1, 5, 6, 10, 26 AND 46).

CLASS 3—COSMETICS AND CLEANING PREPARATIONS

FOR COSMETICS AND NON-MEDICATED PREPARATIONS FOR SKIN CARE; HAIR LOTIONS; DENTIFRICES; NON-MEDICATED COSMETIC PREPARATIONS FOR APPLICATION TO THE SKIN TO PREVENT SUNBURN; ESSENTIAL OILS (U.S. CLS. 1, 4, 6, 50, 51 AND 52).

CLASS 5—PHARMACEUTICALS

FOR PHARMACEUTICAL AND VETERINARY PREPARATIONS FOR THE TREATMENT OF INFECTIOUS DISEASES, BLOOD DISORDERS, PAIN, INFLAMMATION, SEPSIS, ALOPECIA, OBESITY, NUTRITIONAL DISORDERS, HEALTH DISORDERS, EATING DISORDERS, SKIN DISORDERS AND COGNITIVE DISORDERS; FOOD SUPPLEMENTS AND FOOD INGREDIENTS FOR MEDICAL PURPOSES; VITAMINS AND VITAMIN PREPARATIONS; DIETETIC SUBSTANCES, NAMELY, FOODS ADAPTED FOR MEDICAL USE; FOOD FOR BABIES (U.S. CLS. 6, 18, 44, 46, 51 AND 52).

CLASS 29—MEATS AND PROCESSED FOODS

FOR PRESERVED, DRIED AND COOKED FRUITS AND VEGETABLES; JELLIES, JAMS, COMPOTES; EGGS, MILK AND MILK PRODUCTS EXCLUDING ICE CREAM, ICE MILK AND FROZEN YOGURT; EDIBLE OILS AND FATS (U.S. CL. 46).

CLASS 30—STAPLE FOODS

FOR YEAST, YEAST PRODUCTS, NAMELY, YEAST POWDER; YEAST EXTRACTS; SEASONINGS; RICE; FLOUR AND PREPARATIONS MADE FROM CEREALS, NAMELY, BREAKFAST CEREALS AND READY TO EAT CEREAL DERIVED FOOD BARS, CEREAL BASED SNACK FOOD, CEREAL BASED ENERGY BARS; BREAD, PASTRY AND CONFECTIONERY, NAMELY, SWEETS; SAUCES AS CONDIMENTS; READY-TO-EAT CEREAL BARS; SNACKS, NAMELY, GRAIN-BASED SNACK FOODS (U.S. CL. 46).

CLASS 31—NATURAL AGRICULTURAL PRODUCTS

FOR AGRICULTURAL, HORTICULTURAL AND FORESTRY SEEDS; FRESH FRUITS AND VEGETABLES; SOWING-SEEDS, NATURAL PLANTS AND FLOWERS; FOODSTUFFS FOR ANIMALS (U.S. CLS. 1 AND 46).

CLASS 32—LIGHT BEVERAGES

FOR MINERAL AND AERATED WATERS; FRUIT DRINKS AND FRUIT JUICES; SYRUPS FOR MAKING BEVERAGES; NON-ALCOHOLIC SPORT DRINKS AND NON-ALCOHOLIC ENERGY DRINKS (U.S. CLS. 45, 46 AND 48).

CLASS 42—SCIENTIFIC AND COMPUTER SERVICES

FOR SCIENTIFIC, TECHNOLOGICAL AND RESEARCH SERVICES FOR THE CHEMICAL AND PROCESSING INDUSTRY; INDUSTRIAL ANALYSIS AND RESEARCH SERVICES IN THE FIELD OF CHEMICALS, PHARMACEUTICALS, NUTRACEUTICALS, HEALTH, FOODS, BEVERAGES AND DIETARY PREPARATIONS (U.S. CLS. 100 AND 101).

JULIE VEPPUMTHARA, EXAMINING ATTORNEY

CLASS 41—EDUCATION AND ENTERTAINMENT

FOR EDUCATIONAL SERVICES, NAMELY, SEMINARS AND COURSES IN THE FIELD OF ANIMAL HEALTHCARE (U.S. CLS. 100, 101 AND 107).

CLASS 44—MEDICAL, BEAUTY AND AGRICULTURAL SERVICES

FOR VETERINARY SERVICES (U.S. CLS. 100 AND 101).

THEODORE MCBRIDE, EXAMINING ATTORNEY

SN 79-052,915. LORO PIANA S.P.A., I-13017 QUARONA (VC), ITALY, FILED 3-7-2008.

LORO PIANA "The wave"

THE MARK CONSISTS OF STANDARD CHARACTERS WITHOUT CLAIM TO ANY PARTICULAR FONT, STYLE, SIZE, OR COLOR.

PRIORITY DATE OF 2-8-2008 IS CLAIMED.

OWNER OF INTERNATIONAL REGISTRATION 0961703 DATED 3-7-2008, EXPIRES 3-7-2018.

OWNER OF U.S. REG. NOS. 1,337,982, 2,812,870 AND OTHERS.

THE NAME "LORO PIANA" IDENTIFIES A LIVING INDIVIDUAL WHOSE CONSENT IS OF RECORD.

CLASS 24—FABRICS

FOR TEXTILES AND TEXTILE GOODS, NAMELY, FABRICS FOR THE MANUFACTURE OF CLOTHING, BED COVERS, NAMELY, BLANKETS, DUVET COVERS, MATTRESS COVERS, PILLOW COVERS, AND FABRIC TABLE COVERS, NAMELY, TABLE CLOTHS, NAPKINS AND PLACEMATS (U.S. CLS. 42 AND 50).

CLASS 25—CLOTHING

FOR CLOTHING FOR MEN, WOMEN AND CHILDREN, NAMELY, JACKETS, COATS, SKIRTS, TROUSERS, CLOAKS, MANTLES, OVERCOATS, VESTS, SCARVES, MUFFLERS, SHAWLS AND GLOVES; FOOTWEAR; HEADWEAR (U.S. CLS. 22 AND 39).

MARGERY A. TIERNEY, EXAMINING ATTORNEY

SN 79-052,981. INTERVET INTERNATIONAL B.V., NETHERLANDS, FILED 4-8-2008.



PRIORITY DATE OF 2-19-2008 IS CLAIMED.
OWNER OF INTERNATIONAL REGISTRATION 0961891 DATED 4-8-2008, EXPIRES 4-8-2018.

NO CLAIM IS MADE TO THE EXCLUSIVE RIGHT TO USE "HEALTH FOR SERENGETI", APART FROM THE MARK AS SHOWN.

THE FOREIGN WORDING IN THE MARK TRANSLATES INTO ENGLISH AS "HEALTH".

CLASS 5—PHARMACEUTICALS

FOR RABIES VACCINES (U.S. CLS. 6, 18, 44, 46, 51 AND 52).

SN 79-052,983. AMPLIFON S.P.A., ITALY, FILED 4-21-2008.



PRIORITY DATE OF 1-3-2008 IS CLAIMED.
OWNER OF INTERNATIONAL REGISTRATION 0961902 DATED 4-21-2008, EXPIRES 4-21-2018.

THE COLOR(S) ORANGE IS/ARE CLAIMED AS A FEATURE OF THE MARK.

THE MARK CONSISTS OF A VISUALIZATION OF A SOUND WAVE APPEARING IN ORANGE.

CLASS 9—ELECTRICAL AND SCIENTIFIC APPARATUS

FOR AMPLIFICATION APPARATUS FOR THE HARD OF HEARING, NAMELY, PORTABLE AMPLIFIERS; ACCESSORIES FOR AMPLIFICATION APPARATUS FOR THE HARD OF HEARING, NAMELY, AMPLIFIERS, ELECTRONIC RECEIVER TRANSMITTERS, ELECTRIC CONNECTION CORDS, CONNECTION CABLES, RECEIVER AND AMPLIFIER ADAPTORS FOR BATTERIES, NETWORK FEEDERS; INDUCTION DEVICES FOR CONNECTING TO TELEPHONES AND TO ANY SOUND-EMITTING APPARATUS, NAMELY, TINNITUS MASKERS; APPARATUS PRODUCING OSCILLATIONS, NAMELY, OSCILLATORS (U.S. CLS. 21, 23, 26, 36 AND 38).

CLASS 10—MEDICAL APPARATUS

FOR ACOUSTIC APPARATUS FOR THE HARD OF HEARING, NAMELY, HEARING AIDS; PROSTHESES FOR EARS; AIR-CONDUCTION AND BONE-CONDUCTION RECEIVERS FOR USE WITH HEARING AIDS; CURVED PIECES FOR BONE-CONDUCTION RECEIVERS, NAMELY, TRANSMITTERS FOR USE WITH HEARING AIDS (U.S. CLS. 26, 39 AND 44).

CLASS 42—SCIENTIFIC AND COMPUTER SERVICES

FOR SCIENTIFIC AND TECHNOLOGICAL SERVICES AND RESEARCH AND DESIGN RELATING THERETO IN THE FIELD OF HEARING AIDS FOR PEOPLE WITH HEARING DISORDERS; MEDICAL RESEARCH IN THE AUDIOLOGICAL FIELD (U.S. CLS. 100 AND 101).

CLASS 44—MEDICAL, BEAUTY AND AGRICULTURAL SERVICES

FOR MEDICAL AND PARAMEDICAL ASSISTANCE PROVIDED FOR THE DEAF; MEDICAL SERVICES FOR THE TREATMENT OF DEAFNESS (U.S. CLS. 100 AND 101).

NICHOLAS ALTREE, EXAMINING ATTORNEY

SN 79-053.187. ZYTRONIC DISPLAYS LIMITED, UNITED KINGDOM, FILED 8-9-2007.

ZYBRID

THE MARK CONSISTS OF STANDARD CHARACTERS WITHOUT CLAIM TO ANY PARTICULAR FONT, STYLE, SIZE, OR COLOR.

PRIORITY DATE OF 2-23-2007 IS CLAIMED.

OWNER OF INTERNATIONAL REGISTRATION 0962489 DATED 8-9-2007, EXPIRES 8-9-2017.

CLASS 2—PAINTS

FOR OPTICAL COATINGS; COATINGS IN THE NATURE OF OPTICAL COATINGS TO REDUCE REFLECTION AND GLARE; COATINGS IN THE NATURE OF TINTED AND NEUTRAL DENSITY INTER-LAYERS FOR CONTRAST ENHANCEMENT FILTERS FOR ELECTRONIC DISPLAY READOUT WINDOWS (U.S. CLS. 6, 11 AND 16).

CLASS 9—ELECTRICAL AND SCIENTIFIC APPARATUS

FOR ELECTRONIC TOUCH SENSITIVE DISPLAY SCREENS; VISUAL DISPLAY UNITS, NAMELY, ELECTRONIC INDICATOR PANELS AND FLAT PANEL DISPLAY SCREENS; OPTICAL FILTERS, NAMELY, CONTRAST ENHANCEMENT FILTERS FOR ELECTRONIC DISPLAY READOUT WINDOWS; CASH REGISTERS; DATA PROCESSORS; COMPUTERS; ELECTRONIC TOUCH SENSITIVE SWITCHES; TOUCH PADS; TOUCH PANELS; ELECTRONIC CONTROL PANELS AND TOUCH PADS FOR SECURITY CONTROLS, DOMESTIC APPLIANCES, INDUSTRIAL CONTROL PANELS AND DRINKS MACHINES; SECURITY ALARMS, NAMELY, ACCESS CONTROL AND ALARM MONITORING SYSTEMS, FIRE ALARMS, BURGLAR ALARMS, SMOKE ALARMS, THEFT ALARMS; ELECTRONIC CONTROL PANELS AND TOUCH PADS FOR SECURITY ALARMS; METERED GASOLINE PUMPS; ELECTRONIC CONTROL PANELS AND TOUCH PADS FOR METERED GASOLINE PUMPS; AUTOMATIC TELLER MACHINES; ELECTRONIC CONTROL PANELS AND TOUCH PADS FOR AUTOMATIC TELLER MACHINES; ELECTRONIC TICKET DISPENSING MACHINES FOR PARKING LOTS, TRAINS, BUSES, AIRPLANES, CINEMAS; ELECTRONIC CONTROL PANELS AND TOUCH PADS FOR TICKET DISPENSING MACHINES; AUTOMATIC VENDING MACHINES AND MECHANISMS FOR COIN-OPERATED APPARATUS; ELECTRONIC CONTROL PANELS AND TOUCH PADS FOR VENDING MACHINES; ELECTRONIC CONTROL PANELS AND TOUCH SENSITIVE DISPLAY SCREENS FOR MEDICAL EQUIPMENT; ELECTRONIC ELEVATOR CONTROL PANELS; ELECTRONIC CONTROL PANELS AND TOUCH PADS FOR HEATING INSTALLATIONS; ELECTRONIC PROJECTED CAPACITIVE TOUCH SENSORS; APPARATUS FOR RECORDING, TRANSMISSION AND REPRODUCTION OF SOUND AND IMAGES; COMPUTER HARDWARE ASSOCIATED WITH TOUCH SENSITIVE DISPLAY SCREENS; OPTICAL FILTERS; OPTICAL FILTERS FOR ELECTRONIC DISPLAYS; NON-METAL STRUCTURAL REPLACEMENT PARTS AND FITTINGS FOR ALL THE AFOREMENTIONED GOODS (U.S. CLS. 21, 23, 26, 36 AND 38).

CLASS 17—RUBBER GOODS

FOR PLASTIC FILMS FOR COMMERCIAL AND INDUSTRIAL USE; LAMINATES IN THE NATURE OF A PLASTIC SHEET COATING FOR USE IN ELECTRONIC DISPLAYS, TOUCH SCREENS, TOUCH SENSORS, CONTROL PANELS, AND DISPLAY PANELS; PLASTIC FILMS FOR COMMERCIAL AND INDUSTRIAL USE, NAMELY, FOR ELECTRONIC DISPLAYS, TOUCH SCREENS, TOUCH SENSORS, CONTROL PANELS, AND DISPLAY PANELS (U.S. CLS. 1, 5, 12, 13, 35 AND 50).

CLASS 19—NON-METALLIC BUILDING MATERIALS

FOR LAMINATED FLAT GLASS; SAFETY GLASS FOR BUILDING PURPOSES; BALLISTIC GLASS; THERMAL TEMPERED AND STRENGTHENED GLASS (U.S. CLS. 1, 12, 33 AND 50).

CLASS 42—SCIENTIFIC AND COMPUTER SERVICES

FOR SCIENTIFIC RESEARCH AND DEVELOPMENT; INDUSTRIAL RESEARCH IN THE FIELD OF TOUCH SCREEN TECHNOLOGY, OPTICAL FILTERS AND VISORS; DESIGN AND DEVELOPMENT OF COMPUTER HARDWARE AND SOFTWARE; DESIGN AND DEVELOPMENT OF COMPUTER HARDWARE AND SOFTWARE RELATING TO SENSOR SWITCHES; DESIGN AND DEVELOPMENT OF COMPUTER HARDWARE AND SOFTWARE RELATING TO TOUCH SWITCHES; DESIGN AND DEVELOPMENT OF COMPUTER HARDWARE AND SOFTWARE RELATING TO TOUCH SENSITIVE DISPLAY AND CONTROL SCREENS; DESIGN AND DEVELOPMENT OF COMPUTER HARDWARE AND SOFTWARE RELATING TO MEMBRANE KEY-PADS; DESIGN FOR OTHERS IN THE FIELD OF TOUCH SCREEN TECHNOLOGY, OPTICAL FILTERS AND VISORS; INFORMATION, ADVISORY AND CONSULTANCY SERVICES RELATING TO ALL THE AFOREMENTIONED SERVICES (U.S. CLS. 100 AND 101).

LINDA M. KING, EXAMINING ATTORNEY

SN 79-053.223. DORMA GMBH + CO. KG, FED REP GERMANY, FILED 4-2-2007.

PORTEO

THE MARK CONSISTS OF STANDARD CHARACTERS WITHOUT CLAIM TO ANY PARTICULAR FONT, STYLE, SIZE, OR COLOR.

PRIORITY DATE OF 12-13-2006 IS CLAIMED.

OWNER OF INTERNATIONAL REGISTRATION 0962609 DATED 4-2-2007, EXPIRES 4-2-2017.

CLASS 6—METAL GOODS

FOR MECHANICAL METAL LOCKS AND METAL KEYS FOR THESE LOCKS; METALLIC BUILDING FITTINGS, NAMELY, HINGES, HANDLES FOR DOORS, LOCKS AND METAL STRIKING BOXES, LEVER HANDLES FOR DOORS, FITTINGS FOR TOUGHENED GLASS DOORS; METALLIC ACCESSORIES FOR TOUGHENED GLASS DOOR ASSEMBLIES, NAMELY, LOCKS, DOOR KICK PLATES, HANDLES FOR DOORS, DOOR KNOBS, CROSS BARS, SCREW-ON FITTINGS, CLAMPING FITTINGS, CONNECTORS, AND PROTECTIVE FITTINGS FOR DOORS; METAL PARTITIONING WALL PANELS, PARTICULARLY WITH STATIONARY AND MOVABLE INDIVIDUAL PANELS; METAL SLIDING DOORS, METAL SLIDING DOORS WITH SWING DOORS, METAL FOLDING DOORS; NON-ELECTRICAL METAL DOOR CLOSERS; METAL DOOR LOCKS; METALLIC DOOR STAY HINGES (U.S. CLS. 2, 12, 13, 14, 23, 25 AND 50).

CLASS 7—MACHINERY

FOR PNEUMATIC AND HYDRAULIC DRIVES AND CONTROLS FOR MOVING SINGLE PANEL OR MULTI PANEL DOORS OR GATES, NAMELY, SLIDING DOORS, SWING DOORS, REVOLVING DOORS, CURVED SLIDING DOORS, TELESCOPIC SLIDING DOORS, FOLDING DOORS, WING GATES, FOLDING GATES, SLIDING GATES AND PARTITIONING WALLS, ALL OF METAL AND POWER-OPERATED; ACCESSORIES FOR PNEUMATIC AND HYDRAULIC DRIVES AND CONTROLS FOR MOVING SINGLE PANEL OR MULTI PANEL DOORS OR GATES, NAMELY, OPERATING ARMS, CONTROL LEVERS, SLIDING RAILS AND MOUNTING PLATES, ALL OF METAL AND POWER-OPERATED; MOTORIZED GARAGE GATES (U.S. CLS. 13, 19, 21, 23, 31, 34 AND 35).

CLASS 9—ELECTRICAL AND SCIENTIFIC APPARATUS

FOR ELECTRICAL DRIVES FOR MOVING SINGLE PANEL OR MULTI PANEL DOORS OR GATES, NAMELY, SLIDING DOORS, SECURE SWING DOORS, REVOLVING DOORS, CURVED SLIDING DOORS, TELESCOPIC SLIDING DOORS, PARTITIONING WALLS, FOLDING DOORS, WING GATES, FOLDING GATES AND SLIDING GATES; ACCESSORIES FOR ELECTRICAL DRIVES FOR MOVING SINGLE PANEL OR MULTI PANEL DOORS OR GATES, NAMELY, FOR SLIDING DOORS, SECURE SWING DOORS, REVOLVING DOORS, CURVED SLIDING DOORS, TELESCOPIC SLIDING DOORS, PARTITIONING WALLS, FOLDING DOORS, WING GATES, FOLDING GATES AND SLIDING GATES, NAMELY, ELECTRIC PROGRAM SWITCHES, ELECTRONIC RADAR MOTION DETECTORS, LIGHT BARRIERS FOR DETECTING MOTION; ELECTRICAL LOCKS; ELECTRICAL CONTROL FOR LOCKS, WINDOWS AND DOORS DRIVES; ELECTRICAL DOOR OPENER; MAGNETICALLY ENCODED KEY CARDS; MAGNETICALLY ENCODED IDENTIFICATION CARDS; ACCESS CONTROL AND ALARM SYSTEMS, NAMELY, ELECTRONIC DEVICES FOR USE IN THE IDENTIFICATION OF PERSONS, COMPRISED OF READERS, CENTRAL UNITS FOR DATA PROCESSING AND TIME RECORDING DEVICES; MAGNETICALLY ENCODED CARD READERS, DATA PROCESSORS; TIME RECORDING APPARATUS; SMOKE ALARMS; SMOKE DETECTORS; VIDEO MONITORING SYSTEMS, CONSISTING OF VIDEO CAMERAS, WHICH TRANSMIT PICTURES ON CONTROL SYSTEMS WITHOUT ANY WIRE OR CABLE, TRANSMITTER AND RECEIVER FOR THE TRANSMISSION OF DATA; ELECTRICAL DISTRIBUTION BOXES; JUNCTION BOXES; ELECTRICAL DRIVES FOR SLIDING DOORS, SWING DOORS, REVOLVING DOORS, CURVED SLIDING DOORS, TELESCOPIC SLIDING DOORS, FOLDING DOORS, WING GATES, FOLDING GATES, SLIDING GATES AND PARTITIONING WALLS; AUTOMATIC CONTROLLERS FOR AUTOMATICALLY OPERATED DOORS (U.S. CLS. 21, 23, 26, 36 AND 38).

CLASS 19—NON-METALLIC BUILDING MATERIALS

FOR NON-METAL DOORS; NON-METAL PARTITIONING WALL PANELS, PARTICULARLY WITH STATIONARY AND MOVABLE INDIVIDUAL PANELS; NON-METAL SLIDING DOORS; NON-METAL SLIDING DOORS WITH SWING DOORS; NON-METAL FOLDING DOORS (U.S. CLS. 1, 12, 33 AND 50).

LINDA M. KING, EXAMINING ATTORNEY

SN 79-053,340. SWISS MEDICAL TECHNOLOGY GMBH, SWITZERLAND, FILED 3-16-2008.

DENTOSCOPE

THE MARK CONSISTS OF STANDARD CHARACTERS WITHOUT CLAIM TO ANY PARTICULAR FONT, STYLE, SIZE, OR COLOR.

OWNER OF INTERNATIONAL REGISTRATION 0962943 DATED 3-16-2008, EXPIRES 3-16-2018.

CLASS 9—ELECTRICAL AND SCIENTIFIC APPARATUS

FOR OPTICAL APPARATUS AND INSTRUMENTS, NAMELY, CAMERAS, DISC DRIVES, DISC READERS, OPTICAL SCANNERS, MONITORS, INFRARED TRANSMITTERS; APPARATUS FOR RECORDING, TRANSMISSION OR REPRODUCTION OF SOUND AND IMAGES, NAMELY, CAMERAS, MICROPHONES, SOUND RECORDING APPARATUS; DATA-PROCESSING EQUIPMENT, NAMELY, DATA PROCESSORS, PROCESSOR UNITS, CENTRAL PROCESSING UNITS FOR PROCESSING INFORMATION, DATA, SOUND OR IMAGES; COMPUTERS (U.S. CLS. 21, 23, 26, 36 AND 38).

CLASS 10—MEDICAL APPARATUS

FOR MEDICAL, DENTAL AND VETERINARY APPARATUS CONSISTING OF A SYSTEM COMPRISED OF ARRANGEMENTS OF OPTICAL LENSES THAT ALLOWS DOCTORS AND SURGEONS TO VISUALLY ENLARGE AND OBSERVE AREAS OF TREATMENT OR SURGERY, AND TO WHICH A DIGITAL CAMERA CAN BE FIXED IN ORDER TO VISUALIZE AND ENLARGE THE IMAGE OR FILM ON A MONITOR (U.S. CLS. 26, 39 AND 44).

CLASS 42—SCIENTIFIC AND COMPUTER SERVICES

FOR ENGINEERING IN THE MEDICAL, DENTAL AND DENTAL TECHNOLOGY SECTOR, NAMELY, DEVELOPMENT AND CONSTRUCTION DRAFTING OF OPTICAL APPARATUS AND INSTRUMENTS AND OF DIAGNOSTIC APPARATUS FOR MEDICAL PURPOSES; COMPUTER PROGRAMMING (U.S. CLS. 100 AND 101).

RICHARD A. STRASER, EXAMINING ATTORNEY

SN 79-053,383. SOLVAY SA, BELGIUM, FILED 3-6-2008.

ZENIVA

THE MARK CONSISTS OF STANDARD CHARACTERS WITHOUT CLAIM TO ANY PARTICULAR FONT, STYLE, SIZE, OR COLOR.

OWNER OF INTERNATIONAL REGISTRATION 0963036 DATED 3-6-2008, EXPIRES 3-6-2018.

THE MARK "ZENIVA" HAS NO MEANING IN A FOREIGN LANGUAGE.

CLASS 1—CHEMICALS

FOR CHEMICAL PRODUCTS FOR USE IN INDUSTRY, EXCLUDING CHEMICAL PRODUCTS FOR THE PRODUCTION OF COSMETICS, UNPROCESSED ARTIFICIAL RESINS, UNPROCESSED PLASTICS FOR INDUSTRIAL PURPOSES; UNPROCESSED MIXED PLASTICS FOR THE PRODUCTION OF MOLDED, LAMINATED OR EXTRUDED ARTICLES (U.S. CLS. 1, 5, 6, 10, 26 AND 46).

CLASS 10—MEDICAL APPARATUS

FOR IMPLANTS CONSISTING OF ARTIFICIAL MATERIAL; MEDICAL IMPLANTS MADE OF PLASTIC; ARTIFICIAL LIMBS, EYES AND TEETH; ORTHOPEDIC SOLES (U.S. CLS. 26, 39 AND 44).

CLASS 17—RUBBER GOODS

FOR SEMI-WORKED SYNTHETIC PLASTIC AND SYNTHETIC RESINS AS SEMI-FINISHED PRODUCTS IN FORM OF PELLETS, RODS, FOILS, FOAMS, FIBERS, FILMS AND SHEETS (U.S. CLS. 1, 5, 12, 13, 35 AND 50).
MONIQUE MILLER, EXAMINING ATTORNEY

SN 79-053,591. DANIEL MARKUS, SWEDEN, FILED 10-31-2007.

OpenXL

THE MARK CONSISTS OF STANDARD CHARACTERS WITHOUT CLAIM TO ANY PARTICULAR FONT, STYLE, SIZE, OR COLOR.

OWNER OF INTERNATIONAL REGISTRATION 0963612 DATED 10-31-2007, EXPIRES 10-31-2017.

CLASS 9—ELECTRICAL AND SCIENTIFIC APPARATUS

FOR BAGS AND CASES MADE FOR RECORDED AND RECORDABLE COMPUTER MEDIA; BAGS AND CASES FOR LAPTOPS; COMPUTERS, MICRO PROCESSORS AND PERIPHERAL DEVICES FOR COMPUTERS, SPECIALLY DESIGNED FOR THE PURPOSE OF HIGH-PERFORMANCE COMPUTING, NAMELY, COMPUTER CLUSTERS, SYMMETRIC SHARED-MEMORY MULTI-PROCESSORS, DISTRIBUTED SHARED-MEMORY MULTIPROCESSORS, DIGITAL SIGNAL PROCESSORS, RECONFIGURABLE COMPUTING HARDWARE; COMPUTER SOFTWARE, NAMELY, APPLICATION PROGRAMMING INTERFACES FOR THE PURPOSE OF CREATING HARDWARE INDEPENDENT FUNCTIONS, INTERFACE STANDARDS AND OPERATIONS; COMPUTER OPERATING SYSTEMS; COMPUTER SYSTEMS COMPRISING THE ABOVE COMPUTER HARDWARE AND SOFTWARE; ALL OF THE ABOVE FOR USE BY COMPUTER PROGRAMMERS AND ADMINISTRATORS (U.S. CLS. 21, 23, 26, 36 AND 38).

CLASS 42—SCIENTIFIC AND COMPUTER SERVICES

FOR DESIGN OF COMPUTER HARDWARE AND SOFTWARE; DEVELOPMENT OF COMPUTER HARDWARE AND SOFTWARE; CONSULTATION OF COMPUTER SECURITY; COMPUTER HARDWARE AND SOFTWARE RENTAL; COMPUTER CONSULTATION REGARDING COMPUTER HARDWARE; COMPUTER SYSTEM ANALYSES; DESIGN OF COMPUTER SYSTEMS; INSTALLATION OF COMPUTER SOFTWARE; COMPUTER DESIGN SERVICES FOR OTHERS; COMPUTERIZED ENGINEERING FOR OTHERS; COMPUTER CONSULTANT SERVICES; COMPUTERIZED DESIGN SERVICES CONCERNING ARCHITECTURE; COMPUTER DIAGNOSTIC TESTING SERVICES; COMPUTER HARDWARE DESIGN; DESIGN AND DEVELOPMENT OF COMPUTER SOFTWARE AND WEB SITES; COMPUTER SYSTEMS ANALYSIS, NAMELY, COMPARING ANALYSIS STUDIES OF THE PERFORMANCE OF COMPUTER SYSTEMS; COMPUTER HARDWARE CONSULTATION; COMPUTER SYSTEM CONSULTATION SERVICES; COMPUTER SOFTWARE MAINTENANCE; TECHNICAL SUPPORT SERVICES, NAMELY, TROUBLESHOOTING OF COMPUTER SOFTWARE PROBLEMS; COMPUTER TIME SHARING SERVICES; RENTAL OF COMPUTER HARDWARE AND COMPUTER PERIPHERAL DEVICES; DEVELOPMENT OF COMPUTER SYSTEMS; CONVERSION OF DATA AND DOCUMENTATION FROM PHYSICAL TO ELECTRONIC MEDIA; COMPUTER PROGRAMMING; COMPUTER SOFTWARE DESIGN; COMPUTER SOFTWARE UPDATING; COMPUTER SOFTWARE RENTAL; PRODUCT DEVELOPMENT; ALL OF THE ABOVE SERVICES INTENDED FOR COMPUTER PROGRAMMERS AND ADMINISTRATORS (U.S. CLS. 100 AND 101).
KELLY MCCOY, EXAMINING ATTORNEY

SN 79-053,619. OGAS SEKERLEME GIDA TURIZM; SANAYI TICARET ANONIM SIRKETI, TURKEY, FILED 12-7-2007.



OWNER OF INTERNATIONAL REGISTRATION 0963686 DATED 12-7-2007, EXPIRES 12-7-2017.

THE COLOR(S) RED AND WHITE IS/ARE CLAIMED AS A FEATURE OF THE MARK.

THE MARK CONSISTS OF A RED OVAL WITH THE WORD "OGAS" AND A DOT LOCATED DIRECTLY UNDERNEATH THE "S" SUPERIMPOSED IN WHITE.

THE TERM "OGAS" HAS NO MEANING IN A FOREIGN LANGUAGE.

CLASS 29—MEATS AND PROCESSED FOODS

FOR JAMS, MARMALADES, FRUIT PULPS, DRIED FRUIT, DRIED FRUIT PULPS, PROCESSED NUTS, NAMELY, HAZELNUTS AND PEANUTS, PREPARED PISTACHIO, TAHINI, PEANUT BUTTER, JELLIES, UNFLAVORED AND UNSWEETENED GELATINS (U.S. CL. 46).

CLASS 30—STAPLE FOODS

FOR MACARONI, TURKISH RAVIOLI, VERMICELLI, BREAD, PITA BREAD, PIZZA, SOUTHERN PIZZA WITH GROUND MEAT, PASTRIES AND SWEETS, NAMELY, BAKLAVA, SOBIYET, FRIED PASTRY WITH SYRUP, NIGHTINGALE'S NEST, GULLAC, BREAD KADAYIF, KADAYIF WITH WALNUT, KEMALPASHA CHEESE DESSERT, SUGAR BALLS WITH PULP, SWEETS MADE WITH SEMOLINA, GELEE ROYALE PROPOLIS; HONEY, FLOUR, PROCESSED SEMOLINA AND FOOD STARCH, GRANULATED SUGAR, CUBE SUGAR, POWDERED SUGAR, SWEETS, NAMELY, TURKISH DELIGHTS, HALVA, TURKISH COTTON CANDY DELIGHT, AND PALACE HALVA CHOCOLATES; CHOCOLATE, CANDY AND BAKERY GOODS COATED WITH CHOCOLATE OR SUGAR, SUGAR CANDY WITH BERGAMOT, CANDIES, NAMELY, PEPPERMINT DROPS; GRAPE MOLASSES (U.S. CL. 46).

KELLY MCCOY, EXAMINING ATTORNEY

SN 79-053,762. BIONORICA AG, FED REP GERMANY, FILED 10-15-2007.

Phytoland

THE MARK CONSISTS OF STANDARD CHARACTERS WITHOUT CLAIM TO ANY PARTICULAR FONT, STYLE, SIZE, OR COLOR.

PRIORITY DATE OF 5-24-2007 IS CLAIMED.

OWNER OF INTERNATIONAL REGISTRATION 0964144 DATED 10-15-2007, EXPIRES 10-15-2017.

CLASS 5—PHARMACEUTICALS

FOR PHARMACEUTICAL PREPARATIONS FOR USE IN THE TREATMENT, CURE, MITIGATION OR PREVENTION OF GINGIVITIS, HALITOSIS, STOMATITIS, PERIODONTITIS, INFLAMMATION OF THE ORAL CAVITY AND PHARYNGEAL CAVITY, HYPERSENSITIVITY OF TEETH, ANGINA, ATHEROSCLEROSIS, BRONCHIAL ASTHMA, CIRCULATORY DISORDERS, CONSTIPATION, DIARRHEA, HEART FAILURE, HEART RHYTHM DISORDERS, HIGH BLOOD PRESSURE, INDIGESTION, INSOMNIA, MIGRAINE, MOTION SICKNESS, NAUSEA, PEPTIC ULCERS, VOMITING, ALLERGY, GYNECOLOGICAL DISORDERS AFFECTING MENSTRUATION, STERILITY, MENSTRUAL SYNDROMES, DYSMENORRHOEA, INFERTILITY, GENITAL TRACT INFECTIONS, PELVIC INFLAMMATORY DISEASES, VAGINAL DISCOMFORT DUE TO MENOPAUSAL ATROPHIC CHANGES, ANATOMICAL ABNORMALITIES, NEOPLASIA, BREAST NEOPLASM, BREAST CANCER, MAMMA, MASTOPATHY, MASTODYNIA, PREMENSTRUAL SYNDROME, CLIMATERIC COMPLAINTS, BREAST PAIN, BLOOD CONDITIONS AND DISORDERS, BLOOD CIRCULATION DISORDERS, HIGH BLOOD PRESSURE, HYPERTENSION, PULMONARY DISEASES, HEART RHYTHM DISORDERS, HEART FAILURE, UROLOGICAL DISEASES, SEXUALLY TRANSMITTED DISEASES AND INFLAMMATORY PELVIC DISEASES, MENOPAUSAL COMPLAINTS DUE TO THERAPEUTICALLY INDUCED MENOPAUSE, TAMOXIFEN INDUCED HOT FLUSHES OF BREAST CANCER SURVIVORS, VAGINAL DISCOMFORT DUE TO MENOPAUSAL ATROPHIC CHANGES, CLIMACTIC SLEEP DISTURBANCES, DEPRESSIVE MOODS, OSTEOPROTECTIO, OSTEOPOROSIS, CENTRAL NERVOUS SYSTEM INFECTIONS, BRAIN DISEASES, CENTRAL NERVOUS SYSTEM MOVEMENT DISORDERS, OCULAR MOTILITY DISORDERS, SPINAL CORD DISEASES, PSYCHO VEGETATIVE DISORDERS, DEPRESSIVE SYNDROME, ANXIETY, NERVOUS UNREST, PERIPHERAL NERVOUS SYSTEM INFECTIONS, PERIPHERAL NERVOUS SYSTEM MOVEMENT DISORDERS, NERVE COMPRESSION SYNDROMES, NEURITIS, NEURALGIA AND REGIONAL PAIN SYNDROMES, DISEASES AND DISORDERS OF THE KIDNEY, UROLOGICAL DISORDERS, CHRONIC INFECTIONS OF THE BLADDER, CYSTITIS, PYELONEPHRITIS, GLOMERULONEPHRITIS, INTERSTITIAL NEPHRITIS, NEPRHOLITHIASIS, CANCER, UROLITH PROPHYLAXIS, DIZZINESS, MIGRAINE, DEPRESSION, INFLAMMATIONS OF THE UPPER AND LOWER RESPIRATORY ORGANS, SINUSES, BRONCHITIS, TONSILLITIS, ARTHRITIS, OSTEOARTHRITIS, FEVER, COUGH, COLD, ALZHEIMER'S DISEASE, INFECTION OF RESPIRATORY TRACT, INFECTION OF URINARY TRACT, URINARY OBSTRUCTION, CHRONIC VENOUS INSUFFICIENCY, PROSTATE HYPERPLASIA, MUSCLE PAINS, SOFT TISSUE RHEUMATISM, MUSCULOSKELETAL DISEASE, LIVER DISEASE, HEPATITIS, CIRRHOSIS OF LIVER, PERIODONTAL DISEASES AND DENTAL CARIES; PHARMACEUTICAL PREPARATIONS FOR USE AS AN ANTIDEPRESSANT, DIURETIC, HYPNOTIC, SEDATIVE, STIMULANT, AND TRANQUILIZER; HEMORRHOIDAL OINTMENT, LAXATIVE, NASAL DECONGESTANT CAPSULES, NASAL SPRAY PREPARATIONS, NON-NARCOTIC ANALGESICS, THROAT LOZENGES; MENSTRUATION CIRCULATION REGULATING TABLETS; HORMONE PREPARATIONS, HORMONE REPLACEMENT MEDICATION; PHARMACEUTICAL PREPARATIONS FOR SENSORY ORGANS, NAMELY, FOR USE IN OPHTHALMOLOGY, OTOLARYNGOLOGY AND DERMATOLOGY; PHARMACEUTICAL PREPARATIONS FOR REGULATION AND STRENGTHENING OF THE IMMUNE SYSTEM; PHARMACEUTICAL PREPARATIONS FOR TREATING TEMPORARY RELIEF OF OCCASIONAL MINOR IRRITATION, PAIN, SORE MOUTH, SORE GUMS, SORE THROAT, PAIN ASSOCIATED WITH CANKER SORES, PAIN DUE TO MINOR IRRITATION OR INJURY OF THE MOUTH AND GUMS, PAIN DUE TO MINOR DENTAL PROCEDURES, PAIN DUE TO MINOR IRRITATIONS CAUSED BY DENTURES OR ORTHODONTIC APPLIANCES, SORE GUMS DUE TO TEETHING IN INFANTS AND CHILDREN FOUR MONTHS OF AGE AND OLDER; PHARMACEUTICAL PRODUCTS, NAMELY, MEDICATED DENTAL, GUM AND MOUTH WASHES, MEDICATED DENTAL, GUM AND MOUTH RINSE, MEDICATED TOOTHPASTES, MEDICATED ORAL-CARE GELS, MEDICATED DENTAL GELS,

MEDICATED LOZENGES, COUGH LOZENGES, MEDICATED CHEWING GUM, MEDICATED GELS AND FLUIDS IN THE NATURE OF DENTAL BLEACHING GELS, GUM BALMS, MEDICATED DENTAL FLOSS, MEDICATED DENTAL TAPES, MEDICATED DENTAL RIBBONS, MEDICATED TEETH WHITENER GELS, MEDICATED TOOTHPICKS, FLUORIDE CHEWING GUM AND CHEWABLE TABLETS FOR DISCLOSING DENTAL PLAQUE AND TARTAR; PREPARATIONS FOR DENTAL PURPOSES, NAMELY, PLAQUE DISCLOSING REAGENTS, PERIODONTAL DIAGNOSTIC REAGENTS FOR MEDICAL PURPOSES FOR DETECTING DERIVATIVES FROM PERIODONTAL BACTERIA, CARIES, DIAGNOSTIC REAGENTS FOR DETECTING DERIVATIVES FROM CANES-CAUSAL BACTERIA AND MEDICINES FOR THE PREVENTION AND TREATMENT OF PERIODONTAL DISEASES, DENTAL CARIES, CANKER SORES, COLD SORES, MUCOSITIS AND ORAL AND TONGUE CANCERS; MEDICATED MOUTH SPRAYS AND DESENSITIZERS; SANITARY PREPARATIONS FOR MEDICAL USE; SANITARY PREPARATIONS FOR HYGIENE, NAMELY, ANTISEPTICS, ORAL ANTISEPTICS, DISINFECTANTS FOR HEALTH PURPOSES; SANITARY PREPARATIONS FOR THE TREATMENT, CLEANING AND PROTECTION OF THE SKIN; DIETARY SUPPLEMENTS IN THE FORM OF TABLETS, DROPS, CAPSULES, EXTRACT PREPARATIONS, BALMS OR IN LIQUID FORM, CONTAINING PLANT EXTRACTS; DIETETIC SUBSTANCES ADAPTED FOR MEDICAL USE IN THE FORM OF TABLETS, DROPS, CAPSULES, EXTRACT PREPARATIONS, BALMS OR IN LIQUID FORM; FOOD FOR MEDICALLY RESTRICTED DIETS, FOOD FOR DIABETICS, FOOD SUPPLEMENTS CONTAINING PLANT EXTRACTS, FOOD SUPPLEMENTS DERIVED FROM PLANTS OR PLANT EXTRACTS, ALL AFORESAID GOODS IN THE FORM OF TABLETS, DROPS, CAPSULES, EXTRACT PREPARATIONS, BALMS OR IN LIQUID FORM; VITAMIN AND MINERAL SUPPLEMENTS; FOOD AND FOOD SUPPLEMENTS, NAMELY, HERBAL TEAS FOR MEDICINAL PURPOSES AND MEDICINAL TEAS; NUTRITIONAL ADDITIVES FOR USE IN FOODS AND DIETARY SUPPLEMENTS FOR HUMAN CONSUMPTION; DIETETIC FOOD SUPPLEMENTS; MINERAL FOOD SUPPLEMENTS, FOOD SUPPLEMENTS BASED ON AMINO ACIDS, MINERALS AND/OR TRACE ELEMENTS; MEDICAL PLASTERS; MATERIALS FOR DRESSINGS, NAMELY, GAUZE AND BANDAGES; ALL PURPOSE DISINFECTANTS (U.S. CLS. 6, 18, 44, 46, 51 AND 52).

CLASS 9—ELECTRICAL AND SCIENTIFIC APPARATUS

FOR DOWNLOADABLE ELECTRONIC PUBLICATIONS IN THE NATURE OF MAGAZINES, JOURNALS, NEWSLETTERS, PERIODICALS, CATALOGS, BROCHURES, MANUALS, LEAFLETS, PACKAGE INSERTS IN THE FIELD OF MEDICINE AND PHYTOPHARMACY, PRESS RELEASES FEATURING INFORMATION ON MEDICINE AND PHYTOPHARMACY; PRERECORDED MAGNETIC DATA CARRIERS FEATURING MEDICINE AND PHYTOPHARMACY; SMALL WEIGHING, MEASURING, SIGNALING, CHECKING AND SUPERVISION APPARATUS, NAMELY, POCKET CALCULATORS, SCALES, BALANCES, MEASURING RULES, THERMOMETERS, COMPUTER STORAGE DEVICES, NAMELY, FLASH DRIVES, THUMB DRIVES, FLASH MEMORY CARDS, MEMORY CARDS AND COMPUTER MEMORY HARDWARE TO BE USED AS AN ADVERTISING MEDIUM; SPECTACLES, NAMELY, EYEGASSES AND GOGGLES; PROTECTIVE HELMETS, NAMELY, BICYCLE HELMETS; PERSONAL COMPUTERS; DVD, CD, MAGNETIC TAPE RECORDERS AND PLAYERS (U.S. CLS. 21, 23, 26, 36 AND 38).

CLASS 16—PAPER GOODS AND PRINTED MATTER

FOR PAPER; CARDBOARD; GOODS MADE FROM PAPER AND CARDBOARD, NAMELY, PAPER BAGS, COASTERS, FIGURES AND WORKS OF ART; PRINTED MATTER, NAMELY, BOOKS, MAGAZINES, JOURNALS, NEWSPAPERS, PERIODICALS, LEAFLETS, REVIEWS, MANUALS, CATALOGS AND BROCHURES IN THE FIELDS OF HEALTH AND MEDICINE; BOOKBINDING MATERIAL, NAMELY, BOOKBINDINGS; PHOTOGRAPHS; STATIONERY; ADHESIVES FOR STATIONERY OR HOUSEHOLD PURPOSES; ARTISTS' MATERIALS, NAMELY, ARTISTS' PASTELS, ARTISTS' PENCILS, ARTISTS' PENS, PAINTING SETS FOR ARTISTS; PAINT BRUSHES; TYPEWRITERS; OFFICE REQUISITES EXCEPT FURNITURE, NAMELY, PUNCHES, STAPLERS, ERASERS, DESK PADS, PENCIL SHARPENERS; PRINTED INSTRUCTIONAL AND TEACHING MATERIAL, NAMELY, INSTRUCTIONAL AND TEACHING MATERIAL IN THE FIELD OF MEDICINE AND PHYTOPHARMACY; PAPER BAGS, ENVELOPES AND POUCHES FOR PACKAGING; PLASTIC BAGS AND BUBBLE PACKS FOR PACKAGING (U.S. CLS. 2, 5, 22, 23, 29, 37, 38 AND 50).

CLASS 25—CLOTHING

FOR CLOTHING FOR MEN, WOMEN AND CHILDREN, NAMELY, T-SHIRTS, PANTS, DRESSES, JACKETS, TROUSERS, JUMPERS, SOCKS; FOOTWEAR FOR MEN, WOMEN AND CHILDREN; HEADGEAR FOR MEN, WOMEN AND CHILDREN, NAMELY, HATS, CAPS, HEADSCARVES (U.S. CLS. 22 AND 39).

CLASS 29—MEATS AND PROCESSED FOODS

FOR FOOD ADDITIVES FOR NON-MEDICAL PURPOSES, NAMELY, FOOD ADDITIVES CONTAINING PRIMARILY FATTY SUBSTANCES, GREASES AND FATTY ACIDS, EITHER SINGULAR OR IN COMBINATION, AND ALSO CONTAINING VITAMINS, MINERALS AND TRACE ELEMENTS; PLANT EXTRACTS FOR FOODSTUFFS IN THE NATURE OF FOOD ADDITIVES CONTAINING FATTY ACIDS AND PROTEINS TO BE USED IN FOOD SUPPLEMENTS AND FOOD, NAMELY, SOUPS, POWDERED NUTRITIONAL SUPPLEMENT DRINK MIXES AND PORRIDGE; PROTEIN FOR USE AS FOOD ADDITIVE; PROTEINS BEING FOOD ADDITIVES FOR HUMAN CONSUMPTION CONTAINING FATTY SUBSTANCES, FATTY ACIDS, VITAMINS, MINERALS AND TRACE ELEMENTS; FOOD ADDITIVES IN THE NATURE OF FAT ACIDS MADE FROM MEAT, FISH, FRUITS, VEGETABLES, EGGS, MILK AND EDIBLE OILS AND FATS CONTAINING FATTY SUBSTANCES, FATTY ACIDS, VITAMINS, MINERALS AND TRACE ELEMENTS (U.S. CL. 46).

CLASS 30—STAPLE FOODS

FOR FOOD ADDITIVES FOR NON-MEDICAL PURPOSES, NAMELY, FOOD ADDITIVES CONTAINING PRIMARILY CARBOHYDRATES AND FIBER, AND ALSO CONTAINING VITAMINS, MINERALS AND TRACE ELEMENTS, EITHER SINGULAR OR IN COMBINATION; PLANT EXTRACTS AND TINCTURES IN LIQUID, SOLID OR GASEOUS FORM TO BE USED AS FLAVORINGS IN FOOD AND NUTRITIONAL ADDITIVES; HERBAL TEAS FOR FOOD PURPOSES; FOOD ADDITIVES IN THE NATURE OF PLANT EXTRACTS USED AS FLAVORING IN LIQUID, SOLID OR GASEOUS FORM FOR FOODSTUFFS, FOOD SUPPLEMENTS AND FOOD; FOODS AND DIETETIC FOODS, NAMELY, READY TO EAT CEREAL DERIVED FOOD BARS (U.S. CL. 46).

ANDREA HACK, EXAMINING ATTORNEY

SN 79-053,789, VOLKSWAGEN AKTIENGESELLSCHAFT,
FED REP GERMANY, FILED 3-11-2008.

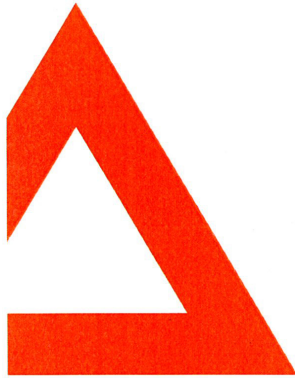

PRIORITY DATE OF 9-27-2007 IS CLAIMED.
OWNER OF INTERNATIONAL REGISTRATION 0964187
DATED 3-11-2008, EXPIRES 3-11-2018.
THE COLOR(S) ORANGE IS/ARE CLAIMED AS A FEATURE OF THE MARK.

THE MARK CONSISTS OF AN EQUILATERAL TRIANGLE THAT IS INCOMPLETE ON THE LOWER LEFT SIDE. THE ENTIRE MARK IS IN THE COLOR ORANGE.

CLASS 12—VEHICLES

FOR VEHICLES FOR LOCOMOTION BY LAND, AIR AND WATER AND STRUCTURAL PARTS THEREFOR; MOTORIZED LAND VEHICLES AND THEIR STRUCTURAL PARTS; TRAILERS FOR VEHICLES AND STRUCTURAL PARTS THEREFOR, ENGINES FOR LAND VEHICLES, TIRES FOR VEHICLE WHEELS, RIMS FOR VEHICLE WHEELS, COMPLETE VEHICLE WHEELS AND STRUCTURAL PARTS THEREFOR; VEHICLE ALARM SYSTEMS; ANTI-THEFT DEVICES FOR VEHICLES, ANTI-THEFT DEVICES FOR MOTORIZED LAND VEHICLES; MOTORIZED SCOOTERS FOR CHILDREN, MOTORIZED AUTOMOBILES FOR CHILDREN (U.S. CLS. 19, 21, 23, 31, 35 AND 44).

CLASS 35—ADVERTISING AND BUSINESS

FOR RETAIL STORE AND WHOLESALE STORE SERVICES FEATURING MOTOR VEHICLES AND THEIR PARTS AND FITTINGS; RETAIL AND WHOLESALE SERVICES, NAMELY, MAIL-ORDER BUSINESS SERVICES FEATURING MOTOR VEHICLES AND THEIR PARTS AND FITTINGS, ONLINE RETAIL AND ONLINE WHOLESALE STORE SERVICES FEATURING MOTOR VEHICLES AND THEIR PARTS AND FITTINGS; RETAIL STORE AND WHOLESALE STORE SERVICES PROVIDED VIA TELEVISION AND TELECOMMUNICATIONS FEATURING MOTOR VEHICLES AND THEIR PARTS AND FITTINGS; BRINGING TOGETHER, BUT NOT TRANSPORTING, A VARIETY OF MOTOR VEHICLES AND PARTS AND FITTINGS THEREFORE FOR THE BENEFIT OF OTHERS, THEREBY ENABLING CUSTOMERS TO VIEW AND PURCHASE THE GOODS IN A RETAIL OUTLET; NEGOTIATION OF CONTRACTS, NAMELY, OF COMMERCIAL TRANSACTIONS, FOR THE BENEFIT OF OTHERS ABOUT SALE AND PURCHASE OF MOTOR VEHICLES AND THEIR PARTS AND FITTINGS; PRESENTATION OF GOODS ON COMMUNICATIONS MEDIA FOR RETAIL PURPOSES; PRESENTATION OF AUCTIONS AND PUBLIC SALES ON THE INTERNET; PROVIDING CONSUMER INFORMATION AND CONSULTATION ABOUT TRADE AND BUSINESS ACTIVITIES, AS A CONSUMER ADVICE SHOP; ADMINISTRATIVE HANDLING OF ORDERS, NAMELY, OFFICE WORK; NEGOTIATION OF CONTRACTS, NAMELY, OF COMMERCIAL TRANSACTIONS, FOR THE BENEFIT OF OTHERS ABOUT SALE AND PURCHASE OF GOODS; CONSULTANCY AND BUSINESS ASSISTANCE IN ORGANIZATION AND MANAGEMENT OF RETAIL AND BUSINESS COMPANIES; ADVERTISING SERVICES; BUSINESS MANAGEMENT; BUSINESS ADMINISTRATION; OFFICE WORK; PERSONNEL RECRUITMENT, PERSONNEL MANAGEMENT CONSULTANCY, BUSINESS MANAGEMENT CONSULTANCY, PUBLIC RELATIONS; RADIO AND TELEVISION ADVERTISING AGENCIES; ORGANIZATION OF TRADE FAIRS FOR COMMERCIAL OR ADVERTISING PURPOSES; COLLECTING AND ARRANGING OF RELEVANT ADVERTISING MATERIALS, NAMELY, PRESS ARTICLES (U.S. CLS. 100, 101 AND 102).

CLASS 36—INSURANCE AND FINANCIAL

FOR INSURANCE, NAMELY, HEALTH INSURANCE CONSULTANCY, INSURANCE BROKERAGE, ACCIDENT INSURANCE CONSULTANCY, HEALTH INSURANCE UNDERWRITING, ACCIDENT INSURANCE UNDERWRITING; MONETARY AFFAIRS, NAMELY, MONETARY EXCHANGE; ISSUANCE OF CREDIT CARDS; BANKING; LOANS FINANCING; INSTALLMENT LOANS, CREDIT BUREAUS, FINANCIAL CONSULTANCY; LEASING AND FINANCE-LEASING OF VEHICLES, NAMELY, AUTOMOBILE LEASING FINANCING; SAVINGS BANKS, REAL ESTATE AFFAIRS, NAMELY, REAL ESTATE BROKERAGE; APARTMENT HOUSE MANAGEMENT, REAL ESTATE MANAGEMENT, REAL ESTATE APPRAISAL; REAL ESTATE SERVICES, NAMELY, RENTAL OF OFFICE SPACE; RENTING OF FLATS; REAL ESTATE AGENCIES; ACCOMMODATION BUREAUS, NAMELY, APARTMENT LOCATING SERVICES; LEASING OF REAL ESTATE; SERVICES OF AN INSURANCE AGENCY; SERVICES OF A FINANCING BROKER, NAMELY, FINANCIAL PLANNING; SERVICES OF AN ESTATE AGENT, NAMELY, REAL ESTATE BROKERAGE; SERVICES OF A STOCK BROKER, NAMELY, STOCK BROKERAGE; PROVISION OF ESTIMATES FOR REPAIR COSTS, NAMELY, REPAIR COST EVALUATION (U.S. CLS. 100, 101 AND 102).

CLASS 37—CONSTRUCTION AND REPAIR

FOR RECONSTRUCTION, REPAIR, SERVICING, DISMANTLING, CLEANING, MAINTENANCE AND VARNISHING OF VEHICLES AND THEIR PARTS AND MOTORS AND THEIR PARTS, VEHICLE REPAIR IN THE COURSE OF VEHICLE BREAKDOWN REPAIR SERVICE; REFINEMENT AND TUNING OF AUTOMOBILES, NAMELY, AUTOMOBILE MAINTENANCE; CUSTOMIZATION OF AUTOMOBILES (U.S. CLS. 100, 103 AND 106).

CLASS 39—TRANSPORTATION AND STORAGE

FOR TRANSPORT BY TRUCKS, MOTOR BUSES, AUTOMOBILES; PACKAGING OF GOODS FOR TRANSPORT AND STORAGE OF GOODS; TRAVEL ARRANGEMENT; VEHICLE TOWING, TAXI TRANSPORT, CAR TRANSPORT, RENTAL OF VEHICLES, NAMELY, AUTOMOBILES, TRANSPORT OF PEOPLE, NAMELY, BY MOTOR BUSES, AUTOMOBILES; SERVICES OF A FREIGHT AGENT, NAMELY, FREIGHT AND TRANSPORT BROKERAGE (U.S. CLS. 100 AND 105).
RONALD DELGIZZI, EXAMINING ATTORNEY

CLASS 20—FURNITURE AND ARTICLES NOT OTHERWISE CLASSIFIED

FOR FURNITURE; FURNISHINGS, NAMELY, BATHROOM FURNITURE; WASHSTANDS (U.S. CLS. 2, 13, 22, 25, 32 AND 50).

CLASS 24—FABRICS

FOR BATH LINEN; WASHING MITTS, FACE TOWELS OF TEXTILE (U.S. CLS. 42 AND 50).
LEIGH CAROLINE CASE, EXAMINING ATTORNEY

SN 79-053,844. LAEMPE & MÖSSNER GMBH, FED REP GERMANY, FILED 1-23-2008.

BeachBox

THE MARK CONSISTS OF STANDARD CHARACTERS WITHOUT CLAIM TO ANY PARTICULAR FONT, STYLE, SIZE, OR COLOR.
OWNER OF INTERNATIONAL REGISTRATION 0964327 DATED 1-23-2008, EXPIRES 1-23-2018.

CLASS 1—CHEMICALS

FOR BINDING AGENTS FOR MOULDING MATERIALS FOR USE IN FOUNDRIES, NAMELY, FOR FOUNDRY SANDS AND FOR USE IN THE CERAMIC INDUSTRY; BINDING AGENTS FOR THE MANUFACTURE OF MOULDED OBJECTS FROM FLOWABLE RAW MATERIALS, NAMELY, WOOD FLOUR AND CRUSHED COCONUT (U.S. CLS. 1, 5, 6, 10, 26 AND 46).

CLASS 7—MACHINERY

FOR FOUNDRY MACHINES, NAMELY, CORE SHOOTING MACHINES (U.S. CLS. 13, 19, 21, 23, 31, 34 AND 35).
APRIL ROACH, EXAMINING ATTORNEY

SN 79-054,614. OXAME, REVIN, FRANCE, FILED 5-5-2008.

OXAME

PRIORITY DATE OF 11-6-2007 IS CLAIMED.
OWNER OF INTERNATIONAL REGISTRATION 0966389 DATED 5-5-2008, EXPIRES 5-5-2018.

CLASS 11—ENVIRONMENTAL CONTROL APPARATUS

FOR BATHTUBS, BATH LININGS, NAMELY, BATH ENCLOSURES AND SURROUNDS, BATH TUBS FOR SITZ-BATHS, BATH INSTALLATIONS, SPA BATHS, NAMELY, WHIRLPOOL BATHS, WHIRLPOOL JETS, BATH FITTINGS, NAMELY, SPOUTS FOR AFFIXING ON WALLS FOR THE BATHS, SHOWER CUBICLES, SHOWERS, SINKS, WATER FOUNTAINS, SAUNA BATH INSTALLATIONS (U.S. CLS. 13, 21, 23, 31 AND 34).

SN 79-054,789. TORAY INDUSTRIES, INC., JAPAN, FILED 4-28-2008.

PLUTE BIO

PRIORITY DATE OF 1-30-2008 IS CLAIMED.
OWNER OF INTERNATIONAL REGISTRATION 0966976 DATED 4-28-2008, EXPIRES 4-28-2018.

THE MARK "PLUTE BIO" HAS NO MEANING IN A FOREIGN LANGUAGE.

CLASS 24—FABRICS

FOR WOVEN FABRICS; KNITTED FABRICS; FELT AND NON-WOVEN TEXTILE FABRICS; PERSONAL ARTICLES OF WOVEN TEXTILE, NAMELY, TOWELS AND HANDKERCHIEFS; BEDSHEETS; FUTON AND QUILTS; BED LINEN, NAMELY, FITTED AND UNFITTED FUTON AND QUILTS CASES; FUTON TICKS, NAMELY, UNFITTED FUTON COVERS; PILLOWCASES; BED BLANKETS; TABLE NAPKINS OF TEXTILE; DISH CLOTHS; SEAT COVERS OF TEXTILE, NAMELY, COVERS FOR CUSHIONS; WALL HANGINGS OF TEXTILES; CURTAINS; TABLE CLOTHS NOT OF PAPER (U.S. CLS. 42 AND 50).

CLASS 25—CLOTHING

FOR CLOTHING, NAMELY, SHIRTS, DRESSES, PANTS, SUITS, COATS, JACKETS, JUMPERS, TROUSERS, SKIRTS AND BLOUSES; GARTERS, SOCK SUSPENDERS; SUSPENDERS; WAISTBANDS; BELTS FOR CLOTHING; FOOTWEAR OTHER THAN BOOTS FOR SPORTS; CLOTHES FOR SPORTS, NAMELY, SPORTS JACKETS, SPORTS SHIRTS, SKIWEAR, SKI PANTS; BOOTS FOR SPORTS (U.S. CLS. 22 AND 39).
AISHA SALEM, EXAMINING ATTORNEY

SN 79-054,794. GOL PAKHSH-E-AVAL CO., IRAN, FILED 4-28-2008.

Ellaro

الارو

OWNER OF INTERNATIONAL REGISTRATION 0966988 DATED 4-28-2008, EXPIRES 4-28-2018.

THE NON-LATIN CHARACTERS IN THE MARK TRANSLITERATE TO "ELLARO".

CLASS 3—COSMETICS AND CLEANING PREPARATIONS

FOR BLEACHING PREPARATIONS FOR LAUNDRY USE; CLEANING AND SCOURING PREPARATIONS; SOAPS; PERFUMERY; ESSENTIAL OILS, COSMETICS, DENTIFRICES (U.S. CLS. 1, 4, 6, 50, 51 AND 52).

CLASS 35—ADVERTISING AND BUSINESS

FOR ADVERTISING AND MARKETING SERVICES; RETAIL STORE SERVICES FEATURING BLEACHING PREPARATIONS FOR LAUNDRY USE; CLEANING AND SCOURING PREPARATIONS; SOAPS; PERFUMERY; ESSENTIAL OILS, COSMETICS, DENTIFRICES; COMPARISON SHOPPING SERVICES (U.S. CLS. 100, 101 AND 102).

CLASS 39—TRANSPORTATION AND STORAGE

FOR DISTRIBUTION SERVICES, NAMELY, DELIVERY OF BLEACHING PREPARATIONS FOR LAUNDRY USE, CLEANING AND SCOURING PREPARATIONS, SOAPS, PERFUMERY, ESSENTIAL OILS, COSMETICS AND DENTIFRICES; STORAGE OF GOODS; PACKAGING ARTICLES FOR TRANSPORTATION; TRANSPORT BY TRUCK, TRAIN, VESSEL, AIRPLANE AND BOAT (U.S. CLS. 100 AND 105).
NICHOLAS ALTREE, EXAMINING ATTORNEY

CLASS 36—INSURANCE AND FINANCIAL

FOR FINANCIAL, MONETARY AND INVESTMENT SERVICES, NAMELY, INVESTMENT BROKERAGE SERVICES, MONETARY EXCHANGE SERVICES, AND INVESTMENT BANKING SERVICES; ONLINE COMMODITY FUTURES AND SECURITIES TRADING FOR OTHERS; STOCK EXCHANGE QUOTATION AND LISTING SERVICES; FINANCIAL CLEARING HOUSES FOR SECURITIES, OPTIONS AND FINANCIAL FUTURES CONTRACTS; FINANCIAL EXCHANGE IN THE FIELD OF SECURITIES; FISCAL VALUATIONS AND ASSESSMENTS PERTAINING TO SECURITIES (U.S. CLS. 100, 101 AND 102).

COLLEEN KEARNEY, EXAMINING ATTORNEY

SN 79-055,632. WIENER BÖRSE AG, AUSTRIA, FILED 6-17-2008.

SETX

SN 79-055,631. WIENER BÖRSE AG, A-1014 WIEN, AUSTRIA, FILED 6-17-2008.

THE MARK CONSISTS OF STANDARD CHARACTERS WITHOUT CLAIM TO ANY PARTICULAR FONT, STYLE, SIZE, OR COLOR.
OWNER OF INTERNATIONAL REGISTRATION 0905306 DATED 5-23-2006, EXPIRES 5-23-2016.

CECEXT

THE MARK CONSISTS OF STANDARD CHARACTERS WITHOUT CLAIM TO ANY PARTICULAR FONT, STYLE, SIZE, OR COLOR.
OWNER OF INTERNATIONAL REGISTRATION 0905304 DATED 5-19-2006, EXPIRES 5-19-2016.

CLASS 16—PAPER GOODS AND PRINTED MATTER

FOR PRINTED MATTER IN THE NATURE OF PRINTED TEACHING MATERIALS IN THE FIELD OF ECONOMY, INVESTMENTS, FINANCIAL AND EXCHANGE AFFAIRS; BOOKS, NEWSPAPERS AND MAGAZINES ALL IN THE FIELD OF ECONOMY, INVESTMENTS, FINANCIAL AND EXCHANGE AFFAIRS (U.S. CLS. 2, 5, 22, 23, 29, 37, 38 AND 50).

CLASS 16—PAPER GOODS AND PRINTED MATTER

FOR PRINTED MATTER IN THE NATURE OF PRINTED TEACHING MATERIALS IN THE FIELD OF ECONOMY, INVESTMENTS, FINANCIAL AND EXCHANGE AFFAIRS; BOOKS, NEWSPAPERS AND MAGAZINES ALL IN THE FIELD OF ECONOMY, INVESTMENTS, FINANCIAL AND EXCHANGE AFFAIRS (U.S. CLS. 2, 5, 22, 23, 29, 37, 38 AND 50).

CLASS 35—ADVERTISING AND BUSINESS

FOR BUSINESS RESEARCH IN THE NATURE OF THE COLLECTION, COMPILATION AND SYSTEMIZATION OF STATISTICAL DATA RELATING TO TRADING IN SECURITIES, OPTIONS AND FINANCIAL FUTURES TRANSACTIONS WITHIN AUSTRIA AND OUTSIDE THE COUNTRY ALL FOR BUSINESS PURPOSES; COMPILATION OF STATISTICS FOR BUSINESS OR COMMERCIAL PURPOSES IN THE NATURE OF COMPILATION OF MATHEMATICAL INDICES OF SECURITIES AND CURRENCIES (U.S. CLS. 100, 101 AND 102).

CLASS 35—ADVERTISING AND BUSINESS

FOR BUSINESS RESEARCH IN THE NATURE OF THE COLLECTION, COMPILATION AND SYSTEMIZATION OF STATISTICAL DATA RELATING TO TRADING IN SECURITIES, OPTIONS AND FINANCIAL FUTURES TRANSACTIONS WITHIN AUSTRIA AND OUTSIDE THE COUNTRY ALL FOR BUSINESS PURPOSES; COMPILATION OF STATISTICS FOR BUSINESS OR COMMERCIAL PURPOSES IN THE NATURE OF COMPILATION OF MATHEMATICAL INDICES OF SECURITIES AND CURRENCIES (U.S. CLS. 100, 101 AND 102).

CLASS 36—INSURANCE AND FINANCIAL

FOR FINANCIAL, MONETARY AND INVESTMENT SERVICES, NAMELY, INVESTMENT BROKERAGE SERVICES, MONETARY EXCHANGE SERVICES, AND INVESTMENT BANKING SERVICES; ONLINE COMMODITY FUTURES AND SECURITIES TRADING FOR OTHERS; STOCK EXCHANGE QUOTATION AND LISTING SERVICES; FINANCIAL CLEARING HOUSES FOR SECURITIES, OPTIONS AND FINANCIAL FUTURES CONTRACTS; FINANCIAL EXCHANGE IN THE FIELD OF SECURITIES; FISCAL VALUATIONS AND ASSESSMENTS PERTAINING TO SECURITIES (U.S. CLS. 100, 101 AND 102).

COLLEEN KEARNEY, EXAMINING ATTORNEY

SN 79-056,354. CUBBYHOLE PTY LTD, AUSTRALIA, FILED 7-4-2008.

perkolator

THE MARK CONSISTS OF STANDARD CHARACTERS WITHOUT CLAIM TO ANY PARTICULAR FONT, STYLE, SIZE, OR COLOR.

OWNER OF INTERNATIONAL REGISTRATION 0970888 DATED 7-4-2008, EXPIRES 7-4-2018.

THE WORDING IN THE MARK HAS NO MEANING IN A FOREIGN LANGUAGE.

CLASS 35—ADVERTISING AND BUSINESS

FOR ADVERTISING SERVICES PROVIDED VIA THE INTERNET (U.S. CLS. 100, 101 AND 102).

CLASS 38—COMMUNICATION

FOR INTERNET PORTAL SERVICES, NAMELY, PROVISION OF ACCESS TO SOCIAL NETWORKING WEBSITES ON THE INTERNET (U.S. CLS. 100, 101 AND 104).

CLASS 42—SCIENTIFIC AND COMPUTER SERVICES

FOR PROVIDING SEARCH ENGINES FOR THE INTERNET (U.S. CLS. 100 AND 101).
MARILYN IZZI, EXAMINING ATTORNEY

SN 79-056,780. BONE THERAPEUTICS,; SOCIÉTÉ ANONYME, BELGIUM, FILED 6-19-2008.

PREOB

THE MARK CONSISTS OF STANDARD CHARACTERS WITHOUT CLAIM TO ANY PARTICULAR FONT, STYLE, SIZE, OR COLOR.

PRIORITY DATE OF 12-24-2007 IS CLAIMED.
OWNER OF INTERNATIONAL REGISTRATION 0972042 DATED 6-19-2008, EXPIRES 6-19-2018.

CLASS 5—PHARMACEUTICALS

FOR PHARMACEUTICAL AND VETERINARY PREPARATIONS FOR USE IN THE TREATMENT OF BONE DISEASES, SANITARY PREPARATIONS FOR MEDICAL PURPOSES, FOOD FOR BABIES, MATERIAL FOR STOPPING TEETH, DENTAL WAX, PREPARATIONS FOR DESTROYING VERMIN; FUNGICIDES, HERBICIDES (U.S. CLS. 6, 18, 44, 46, 51 AND 52).

CLASS 42—SCIENTIFIC AND COMPUTER SERVICES

FOR SCIENTIFIC AND TECHNOLOGICAL SERVICES AND RESEARCH AND DESIGN RELATING THERETO, NAMELY, SCIENTIFIC RESEARCH, DESIGN AND TESTING FOR NEW PRODUCT DEVELOPMENT, ALL FOR CUSTOMERS IN THE PHARMACEUTICAL SECTOR; INDUSTRIAL ANALYSIS AND RESEARCH SERVICES IN THE FIELD OF NEW PRODUCT DEVELOPMENT AND MANUFACTURING FOR CUSTOMERS IN THE PHARMACEUTICAL SECTOR (U.S. CLS. 100 AND 101).

KEVIN CORWIN, EXAMINING ATTORNEY

SN 79-057,084. POLYSIUS AG, FED REP GERMANY, FILED 6-6-2008.

POLFLAME

THE MARK CONSISTS OF STANDARD CHARACTERS WITHOUT CLAIM TO ANY PARTICULAR FONT, STYLE, SIZE, OR COLOR.

PRIORITY DATE OF 12-14-2007 IS CLAIMED.
OWNER OF INTERNATIONAL REGISTRATION 0972792 DATED 6-6-2008, EXPIRES 6-6-2018.

CLASS 7—MACHINERY

FOR MACHINES AND MACHINE PARTS FOR THE CEMENT, LIME, GYPSUM, CERAMIC, REFRACTORY, IRON AND STEEL AND CHEMICAL INDUSTRIES, FOR MINING AND THE POWER INDUSTRY, PARTICULARLY MILLS, CRUSHERS, SEPARATORS, PRECIPITATORS; DEVICES AND EQUIPMENT FOR MIXING, HOMOGENIZING, STORING, DOSAGING, SORTING, FRAGMENTING, CONVEYING, PACKING AND LOADING OF SOLID MATERIALS, NAMELY, MIXERS, HOMOGENIZERS, DOSAGERS, SORTERS, FRAGMENTERS, CONVEYORS, PACKERS, AND LOADERS OF SOLID MATERIALS (U.S. CLS. 13, 19, 21, 23, 31, 34 AND 35).

CLASS 11—ENVIRONMENTAL CONTROL APPARATUS

FOR MACHINES AND MACHINE PARTS FOR THE CEMENT, LIME, GYPSUM, CERAMIC, REFRACTORY, IRON AND STEEL AND CHEMICAL INDUSTRIES, FOR MINING AND THE POWER INDUSTRY, PARTICULARLY FURNACES, CALCINERS, PREHEATERS, COOLERS (U.S. CLS. 13, 21, 23, 31 AND 34).
SANI KHOURI, EXAMINING ATTORNEY

SN 79-057,184. SOLVAY SA, BELGIUM, FILED 5-23-2008.

SYNDURA

THE MARK CONSISTS OF STANDARD CHARACTERS WITHOUT CLAIM TO ANY PARTICULAR FONT, STYLE, SIZE, OR COLOR.

PRIORITY DATE OF 1-7-2008 IS CLAIMED.
OWNER OF INTERNATIONAL REGISTRATION 0972900 DATED 5-23-2008, EXPIRES 5-23-2018.

THE WORDING "SYNDURA" HAS NO MEANING IN A FOREIGN LANGUAGE.

CLASS 1—CHEMICALS

FOR INDUSTRIAL CHEMICALS; UNPROCESSED ARTIFICIAL RESINS, UNPROCESSED PLASTICS; ADHESIVES USED IN INDUSTRY (U.S. CLS. 1, 5, 6, 10, 26 AND 46).

CLASS 2—PAINTS

FOR PAINTS, VARNISHES, LACQUERS (U.S. CLS. 6, 11 AND 16).

CLASS 17—RUBBER GOODS

FOR SEMI-FINISHED PRODUCTS OF SEMI-WORKED SYNTHETIC PLASTICS AND SYNTHETIC RESINS IN THE FORM OF PELLETS, RODS, SHEETS, FOAMS, FIBERS, FILMS, FOILS AND SLABS (U.S. CLS. 1, 5, 12, 13, 35 AND 50).

JAMES MACFARLANE, EXAMINING ATTORNEY

SN 79-057,562. RABENS SALONER; V/BIRGITTE RABEN OLRIK, DENMARK, FILED 3-4-2008.

Rabens Saloner

THE MARK CONSISTS OF STANDARD CHARACTERS WITHOUT CLAIM TO ANY PARTICULAR FONT, STYLE, SIZE, OR COLOR.

PRIORITY DATE OF 1-21-2008 IS CLAIMED. OWNER OF INTERNATIONAL REGISTRATION 0973764 DATED 3-4-2008, EXPIRES 3-4-2018. THE ENGLISH TRANSLATION OF "SALONER" IS "SALOONS."

CLASS 14—JEWELRY

FOR PRECIOUS METALS AND THEIR ALLOYS AND GOODS IN PRECIOUS METALS OR COATED THEREWITH, NAMELY, JEWELLERY, PRECIOUS STONES; HOROLOGICAL AND CHRONOMETRIC INSTRUMENTS (U.S. CLS. 2, 27, 28 AND 50).

CLASS 18—LEATHER GOODS

FOR LEATHER AND IMITATIONS OF LEATHER, AND GOODS MADE OF THESE MATERIALS, NAMELY, TRUNKS AND TRAVELLING BAGS; ANIMAL SKINS, HIDES; TRUNKS AND TRAVELLING BAGS; UMBRELLAS, PARASOLS AND WALKING STICKS; WHIPS, HARNESS AND SADDLERY (U.S. CLS. 1, 2, 3, 22 AND 41).

CLASS 25—CLOTHING

FOR CLOTHING, NAMELY, SHIRTS, PANTS, SKIRTS, DRESSES, COATS, JACKETS; FOOTWEAR; HEADGEAR, NAMELY, HATS AND CAPS (U.S. CLS. 22 AND 39). LAURA HAMMEL, EXAMINING ATTORNEY

SN 79-057,984. ROXTEC AB, KARLSKRONA, SWEDEN, FILED 7-8-2008.

ComSeal

THE MARK CONSISTS OF STANDARD CHARACTERS WITHOUT CLAIM TO ANY PARTICULAR FONT, STYLE, SIZE, OR COLOR.

PRIORITY DATE OF 1-17-2008 IS CLAIMED. OWNER OF INTERNATIONAL REGISTRATION 0974912 DATED 7-8-2008, EXPIRES 7-8-2018.

CLASS 6—METAL GOODS

FOR CABLE AND PIPE PENETRATION SEALS, MADE FROM METAL; SEALING FRAMES MADE FROM METAL FOR CABLES AND PIPES (U.S. CLS. 2, 12, 13, 14, 23, 25 AND 50).

CLASS 17—RUBBER GOODS

FOR CABLE AND PIPE PENETRATION SEALS, MADE FROM PLASTIC OR RUBBER; SEALING FRAMES, MADE FROM PLASTIC OR RUBBER FOR CABLES AND PIPES (U.S. CLS. 1, 5, 12, 13, 35 AND 50).

CLASS 19—NON-METALLIC BUILDING MATERIALS

FOR NON-METALLIC RIGID PIPES FOR BUILDING; NON-METALLIC CABLE AND PIPE PENETRATION SEALS, MADE FROM CEMENT OR CONCRETE; NON-METALLIC SEALING FRAMES, MADE FROM CEMENT OR CONCRETE, FOR CABLES AND PIPES (U.S. CLS. 1, 12, 33 AND 50).

JAMES MACFARLANE, EXAMINING ATTORNEY

SN 79-058,574. ZHU ZHENG LI, LUQIAO DISTRICT, TAIZHOU; ZHEJIANG, CHINA, FILED 6-24-2008.



OWNER OF INTERNATIONAL REGISTRATION 0976509 DATED 6-24-2008, EXPIRES 6-24-2018.

THE MARK CONSISTS OF THE DEPICTION A TOP HAT WITH A BOW TIE APPEARING ABOVE A CIRCLE WHICH IS LOCATED ABOVE A BOOT ALL OF WHICH ARE SURROUNDED BY AN OVAL WHICH IS SURROUNDED BY A RECTANGLE WITH SCALLOPED CORNER EDGES. IN EACH CORNER OF THE RECTANGLE APPEARS A CHINESE CHARACTER.

THE NON-LATIN CHARACTER IN THE UPPER LEFT-HANG CORNER OF THE MARK TRANSLITERATES TO HENG AND THIS MEANS "SMOOTHNESS, SUCCESS, OR PROSPERITY" IN ENGLISH. THE NON-LATIN CHARACTER IN THE UPPER RIGHT-HAND CORNER OF THE MARK TRANSLITERATES TO XIANG AND THIS MEANS "ENJOYMENT" IN ENGLISH. THE NON-LATIN CHARACTER IN THE UPPER LEFT-HANG CORNER OF THE MARK TRANSLITERATES TO CHUN AND THIS MEANS "SIMPLE" IN ENGLISH. THE NON-LATIN CHARACTER IN THE UPPER LEFT-HANG CORNER OF THE MARK TRANSLITERATES TO CHUN AND THIS MEANS "LUSCIOUS, GENTLE OR MILD" IN ENGLISH.

CLASS 32—LIGHT BEVERAGES

FOR BEER; CARBONATED BEVERAGES; SOY MILK, NAMELY, SOY-BASED BEVERAGES NOT BEING MILK SUBSTITUTES; PEANUT MILK BEVERAGES, NAMELY, NON-ALCOHOLIC BEVERAGES CONTAINING PEANUT FLAVOR; SOY-BASED BEVERAGES NOT BEING MILK SUBSTITUTES; NON-ALCOHOLIC FRUIT JUICE BEVERAGES; AERATED WATER; WATER BEVERAGES, NAMELY, DRINKING WATER; PREPARATIONS FOR MAKING FRUIT DRINKS; FRUIT JUICE (U.S. CLS. 45, 46 AND 48).

CLASS 33—WINES AND SPIRITS

FOR FRUIT WINE; APERITIF WINE; JAPANESE WHITE LIQUOR (SHOCHU); WINE DRINK, NAMELY, WINE; ALCOHOLIC BEVERAGES EXCEPT BEERS; EDIBLE ALCOHOL, NAMELY, VODKA, BRANDY, GIN, DISTILLED SPIRITS; RICE WINE; SAKE; HIGHLAND BARLEY WINE (U.S. CLS. 47 AND 49).

MICHAEL TANNER, EXAMINING ATTORNEY

SN 79-058,825. EURESCOM GMBH, FED REP GERMANY,
FILED 7-15-2008.

EuresTools

THE MARK CONSISTS OF STANDARD CHARACTERS WITHOUT CLAIM TO ANY PARTICULAR FONT, STYLE, SIZE, OR COLOR.

PRIORITY DATE OF 1-18-2008 IS CLAIMED.

OWNER OF INTERNATIONAL REGISTRATION 0977150
DATED 7-15-2008, EXPIRES 7-15-2018.

THE WORDING "EURESTOOLS" IN THE MARK HAS NO MEANING IN A FOREIGN.

CLASS 9—ELECTRICAL AND SCIENTIFIC APPARATUS

FOR COMMUNICATION EQUIPMENT, NAMELY, TELEPHONES, TELEPHONE RECEIVERS, TELEPHONE ANSWERING MACHINES, FAX MACHINES, INTERCOM, BUTTON OPERATED HANDSETS FOR USE WITH INTERCOMS; DIALING AND COMMUNICATIONS APPARATUS, NAMELY, APPARATUS FOR TRANSMISSION OF COMMUNICATION; TELEPHONE COAXIAL AND FIBRE-OPTIC CABLES; TELEPHONE WIRES; DICTATING MACHINES; ELECTRICAL EQUIPMENT FOR RECORDING, TRANSMISSION AND REPRODUCTION OF SOUND OR IMAGES, NAMELY, ELECTRICAL INTEGRATED CONTROL SYSTEMS FOR USE IN THE FIELD OF COMMUNICATIONS, DIGITAL TRANSMITTERS, SOUND OR IMAGES RECORDING APPARATUS, SOUND OR IMAGES RECEIVERS, SOUND OR IMAGES TRANSMITTING APPARATUS, SOUND OR IMAGES REPRODUCTION APPARATUS; TAPE RECORDERS; BLANK AUDIO CASSETTES; LOUDSPEAKERS; DATA PROCESSING EQUIPMENT; COMPUTER PROGRAMS FOR USE IN THE FIELD OF INFORMATION AND COMMUNICATION TECHNOLOGY, PROJECT MANAGEMENT AND FOR RECORDING, TRANSMISSION AND REPRODUCTION OF SOUND OR IMAGES AND STORED OR DATA CARRIERS; RADIO INTERCOMS; REMOTE CONTROL DEVICES FOR RADIOS, TELEVISIONS, STEREOS, COMPUTER CONTROL UNITS; CURRENT SIMPLY DEVICES, NAMELY, CURRENT RECTIFIERS, ELECTRICITY CONDUITS, CIRCUITS, ELECTRIC LOSS INDICATORS, ELECTRICITY INVERTERS; ELECTRIC CABLES; ACOUSTIC WARNING DEVICES, NAMELY, ELECTRONIC WARNING BELLS, SIGNAL BELLS; VOICE RECORDING DEVICES, NAMELY, DICTAPHONES (U.S. CLS. 21, 23, 26, 36 AND 38).

CLASS 38—COMMUNICATION

FOR TELECOMMUNICATION SERVICES, NAMELY, TRANSMISSION OF VOICE, AUDIO, VISUAL IMAGE, VIDEO AND DATA BY TELECOMMUNICATION NETWORKS, WIRELESS COMMUNICATION NETWORKS, INTERNET, INFORMATION SERVICES NETWORKS AND DATA NETWORKS, DATA TRANSMISSION AND RECEPTION SERVICES VIA TELECOMMUNICATION MEANS, ELECTRONIC EXCHANGE OF DATA STORED ON DATABASES ACCESSIBLE VIA TELECOMMUNICATION NETWORKS; WIRELESS TELEPHONE SERVICES, LOCAL AND LONG DISTANCE TRANSMISSION OF VOICE, DATA, VISUAL IMAGES VIDEO AND DATA BY MEANS OF BROADBAND, COPPER AND OPTICAL OR WIRELESS NETWORKS, PROVIDING INTERNET ACCESS VIA BROADBAND, OPTICAL OR WIRELESS NETWORKS (U.S. CLS. 100, 101 AND 104).

CLASS 42—SCIENTIFIC AND COMPUTER SERVICES

FOR COMPUTER PROGRAMMING; DRAWING UP OF EXPERT TECHNICAL OPINIONS IN CONNECTION WITH COMPUTERS; TECHNICAL RESEARCH IN THE FIELD AT COMPUTERS; SCIENTIFIC STUDY AND RESEARCH IN THE FIELD OF THE DEVELOPMENT OF TELECOMMUNICATIONS NETWORKS AND TELECOMMUNICATIONS SERVICES; RESEARCH AND DEVELOPMENT IN THE FIELD OF TELECOMMUNICATIONS, PREFERABLY PUBLIC TELECOMMUNICATIONS NETWORKS (U.S. CLS. 100 AND 101).

JOHN DALIER, EXAMINING ATTORNEY

SN 79-059,046. IMMAGINE EYEWEAR S.R.L., ITALY, FILED
6-11-2008.



PRIORITY DATE OF 4-11-2008 IS CLAIMED.

OWNER OF INTERNATIONAL REGISTRATION 0977807
DATED 6-11-2008, EXPIRES 6-11-2018.

CLASS 9—ELECTRICAL AND SCIENTIFIC APPARATUS

FOR EYE GLASSES, EYE GLASS LENSES, CONTACT LENSES, AND FRAMES FOR GLASSES, CASES FOR GLASSES, PARTS THEREOF; ACCESSORIES FOR GLASSES, NAMELY, EYEGLASS CORDS, CHAINS, EYEGLASS COVERS FOR PROTECTIVE PURPOSES, TEMPLES, END TIPS, NOSE PADS, DEMO LENSES, SUN LENSES, END PIECES, LENS CLOTHES FOR SPECTACLES (U.S. CLS. 21, 23, 26, 36 AND 38).

CLASS 25—CLOTHING

FOR CLOTHING, NAMELY, T-SHIRTS, SOCKS, PAJAMAS, BATHING SUITS, PANTS AND TROUSERS, JACKETS, SHIRTS AND SHORTS, JUMPERS, SWEATERS, GLOVES AND SCARVES; FOOTWEAR; HEADGEAR, NAMELY, HATS AND CAPS (U.S. CLS. 22 AND 39).

JACLYN KIDWELL, EXAMINING ATTORNEY

SN 79-059,606. NEMETSCHKE AG, FED REP GERMANY,
FILED 7-23-2008.



PRIORITY DATE OF 1-23-2008 IS CLAIMED.

OWNER OF INTERNATIONAL REGISTRATION 0979084
DATED 7-23-2008, EXPIRES 7-23-2018.

OWNER OF U.S. REG. NOS. 1,999,690 AND 1,999,691.

THE COLOR(S) LIGHT BLUE, DARK BLUE, LIGHT RED, DARK RED, LIGHT ORANGE, DARK ORANGE, LIGHT GREEN, DARK GREEN, BEIGE, BROWN, AND GREY IS/ ARE CLAIMED AS A FEATURE OF THE MARK.

THE MARK CONSISTS OF THE WORD "NEMETSCHKE"

IN GREY ABOVE THE WORD "ALLPLAN" IN DARK RED, WITH THREE EVENLY SPACED VERTICAL LINES IN LIGHT BLUE, DARK BLUE, AND LIGHT RED, RESPECTIVELY, TO THE LEFT OF THE WORDING, AND WITH EVENLY SPACED VERTICAL LINES CONTINUING ABOVE THE WORD "NEMETSCHKE" IN DARK RED, LIGHT ORANGE, LIGHT GREEN, DARK GREEN, DARK BLUE, DARK GREEN, LIGHT ORANGE, DARK ORANGE, DARK RED, BEIGE, DARK BLUE, BROWN, AND DARK GREEN, RESPECTIVELY.

CLASS 9—ELECTRICAL AND SCIENTIFIC APPARATUS

FOR DATA PROCESSING EQUIPMENT AND COMPUTERS; APPARATUS FOR RECORDING, TRANSMISSION OR REPRODUCTION OF SOUND OR IMAGES; SOFTWARE PROGRAMS STORED ON DATA CARRIERS FOR PRODUCING TECHNICAL DESIGNS, FOR ORGANIZING TECHNICAL DESIGNS, AND FOR ANALYZING STRUCTURES AND CALCULATING COSTS, IN THE FIELD OF ARCHITECTURE AND ENGINEERING (U.S. CLS. 21, 23, 26, 36 AND 38).

CLASS 16—PAPER GOODS AND PRINTED MATTER

FOR PRINTED INSTRUCTIONAL, EDUCATIONAL, AND TEACHING MATERIALS IN THE FIELD OF ARCHITECTURE, ENGINEERING, AND CONSTRUCTION; PRINTED MATTER, NAMELY, MAGAZINES IN THE FIELD OF ARCHITECTURE, ENGINEERING, AND CONSTRUCTION (U.S. CLS. 2, 5, 22, 23, 29, 37, 38 AND 50).

CLASS 41—EDUCATION AND ENTERTAINMENT

FOR PROVIDING OF TRAINING FOR THE USE OF COMPUTER SOFTWARE PROGRAMS (U.S. CLS. 100, 101 AND 107).

CLASS 42—SCIENTIFIC AND COMPUTER SERVICES

FOR DESIGN AND DEVELOPMENT OF COMPUTER HARDWARE AND SOFTWARE (U.S. CLS. 100 AND 101).
STEPHEN AQUILA, EXAMINING ATTORNEY

SN 79-059,921. NOKIA CORPORATION, FINLAND, FILED 7-31-2008.

DIRK DAGGER

PRIORITY DATE OF 7-2-2008 IS CLAIMED.
OWNER OF INTERNATIONAL REGISTRATION 0979750 DATED 7-31-2008, EXPIRES 7-31-2018.
DIRK DAGGER DOES NOT IDENTIFY A LIVING INDIVIDUAL.

CLASS 9—ELECTRICAL AND SCIENTIFIC APPARATUS

FOR COMPUTER GAME SOFTWARE; DOWNLOADABLE COMPUTER GAME SOFTWARE (U.S. CLS. 21, 23, 26, 36 AND 38).

CLASS 38—COMMUNICATION

FOR PROVIDING ONLINE FORUMS FOR TRANSMISSION OF MESSAGES AMONG COMPUTER USERS CONCERNING COMPUTER GAMES (U.S. CLS. 100, 101 AND 104).

CLASS 41—EDUCATION AND ENTERTAINMENT

FOR ENTERTAINMENT SERVICES, NAMELY, PROVIDING ONLINE COMPUTER GAMES PLAYED OVER A GLOBAL COMPUTER NETWORK; PROVIDING INFORMATION, NEWS AND COMMENTARY IN THE FIELD OF COMPUTER GAMES (U.S. CLS. 100, 101 AND 107).
CYNTHIA TRIPI, EXAMINING ATTORNEY

SN 79-060,470. TORAY ADVANCED COMPUTER SOLUTION, INC., JAPAN, FILED 9-5-2008.

CREACOMPO

PRIORITY DATE OF 3-5-2008 IS CLAIMED.
OWNER OF INTERNATIONAL REGISTRATION 0981047 DATED 9-5-2008, EXPIRES 9-5-2018.

CLASS 9—ELECTRICAL AND SCIENTIFIC APPARATUS

FOR COMPUTER PROGRAMS FOR USE IN PATTERN MAKING OF CLOTHES, GRADING AND MARKING OF CLOTHES (U.S. CLS. 21, 23, 26, 36 AND 38).

CLASS 42—SCIENTIFIC AND COMPUTER SERVICES

FOR COMPUTER SOFTWARE DESIGN, COMPUTER PROGRAMMING, OR MAINTENANCE OF COMPUTER SOFTWARE; RENTAL OF COMPUTERS; PROVIDING TEMPORARY USE OF NON-DOWNLOADABLE COMPUTER SOFTWARE FOR USE IN PATTERN MAKING OF CLOTHES, GRADING AND MARKING OF CLOTHES (U.S. CLS. 100 AND 101).
WENDY JUN, EXAMINING ATTORNEY

SN 79-060,845. ERIS, FRANCE, FILED 9-5-2008.

FYBRCOMP

PRIORITY DATE OF 3-7-2008 IS CLAIMED.
OWNER OF INTERNATIONAL REGISTRATION 0981979 DATED 9-5-2008, EXPIRES 9-5-2018.

CLASS 6—METAL GOODS

FOR METAL FASTENERS, NAMELY, RIVETS (U.S. CLS. 2, 12, 13, 14, 23, 25 AND 50).

CLASS 20—FURNITURE AND ARTICLES NOT OTHERWISE CLASSIFIED

FOR NON-METALLIC FASTENERS, NAMELY, RIVETS (U.S. CLS. 2, 13, 22, 25, 32 AND 50).
WENDY JUN, EXAMINING ATTORNEY

SECTION 2.— INTERNATIONAL CLASSIFICATION

The short titles associated below with the international class numbers are terms designed merely for quick identification and are not an official part of the international classification. The full names of international classes are given in section 6.1 of the trademark rules of practice.

The designation "U.S. Cl." appearing in this section refers to the U.S. class in effect prior to Sep. 1, 1973 rather than the international class which applies to applications filed on or after that date. For adoption of international classification see notice in the OFFICIAL GAZETTE of Jun. 26, 1973 (911 O.G. TM 210).

Application in one class

CLASS 1—CHEMICALS

SN 76-692,720. THE NIPPON SYNTHETIC CHEMICAL INDUSTRY CO., LTD., OSAKA-FU, JAPAN, FILED 9-9-2008.

G-SOARNOL

THE MARK CONSISTS OF STANDARD CHARACTERS WITHOUT CLAIM TO ANY PARTICULAR FONT, STYLE, SIZE, OR COLOR.

FOR UNPROCESSED ARTIFICIAL RESINS; UNPROCESSED PLASTICS (U.S. CLS. 1, 5, 6, 10, 26 AND 46).
DAYNA BROWNE, EXAMINING ATTORNEY

SN 77-365,517. DART SEASONAL PRODUCTS, INC., WOODMERE, NY. FILED 1-7-2008.

**BLUE HEAT Snow and Ice
Melter**

THE MARK CONSISTS OF STANDARD CHARACTERS WITHOUT CLAIM TO ANY PARTICULAR FONT, STYLE, SIZE, OR COLOR.

NO CLAIM IS MADE TO THE EXCLUSIVE RIGHT TO USE "SNOW AND ICE MELTER", APART FROM THE MARK AS SHOWN.

FOR CHEMICAL PREPARATIONS FOR MELTING SNOW AND ICE (U.S. CLS. 1, 5, 6, 10, 26 AND 46).

FIRST USE 10-2-2005; IN COMMERCE 10-2-2005.
NANCY CLARKE, EXAMINING ATTORNEY

CLASS 1—(Continued).

SN 77-401,658. CESCO SOLUTIONS INC., BELLINGHAM, WA. FILED 2-20-2008.



NO CLAIM IS MADE TO THE EXCLUSIVE RIGHT TO USE "SOLUTIONS, INC", APART FROM THE MARK AS SHOWN.

THE COLOR(S) BLACK, BLUE AND WHITE IS/ARE CLAIMED AS A FEATURE OF THE MARK.

THE MARK CONSISTS OF THE COLOR(S) BLUE, BLACK AND WHITE ARE CLAIMED AS A FEATURE OF THE MARK. THE MARK CONSISTS OF A WATER MOLECULE IN BLACK AND WHITE ADJACENT TO THE TERM "CESCO" IN BLUE WHICH IS POSITIONED ABOVE "SOLUTIONS INC" WHICH APPEAR IN WHITE ON A BLACK BACKGROUND.

FOR CHEMICAL PREPARATIONS FOR CLEANING PURPOSES IN THE FOOD AND FOOD PROCESSING INDUSTRIES; CHEMICALS USED IN INDUSTRY; WASTE WATER TREATMENT CHEMICALS FOR INDUSTRIAL USE; DEFOAMING AGENTS (U.S. CLS. 1, 5, 6, 10, 26 AND 46).

FIRST USE 10-15-2007; IN COMMERCE 10-15-2007.
REBECCA SMITH, EXAMINING ATTORNEY

SN 77-422,719. BIXLER'S MARINE INC., RINGWOOD, NJ. FILED 3-14-2008.



NO CLAIM IS MADE TO THE EXCLUSIVE RIGHT TO USE "TUBE SEAL", APART FROM THE MARK AS SHOWN.

THE MARK CONSISTS OF THE STYLIZED WORDS "TOOBSEAL BY BIXLER'S". ABOVE THE STYLIZED WORDS IS AN IMAGE OF A SEAL BALANCING A BALL ON ITS NOSE.

FOR LIQUID SEALER THAT IS USED TO SEAL HOLES IN INFLATABLE BOATS FROM THE INSIDE OF THE TUBE (U.S. CLS. 1, 5, 6, 10, 26 AND 46).

CARRIE GENOVESE, EXAMINING ATTORNEY

CLASS 1—(Continued).

SN 77-424,815. ALBION LABORATORIES, CLEARFIELD, UT. FILED 3-18-2008.

METALOSATE

THE MARK CONSISTS OF STANDARD CHARACTERS WITHOUT CLAIM TO ANY PARTICULAR FONT, STYLE, SIZE, OR COLOR.

OWNER OF U.S. REG. NO. 1,092,033.
 FOR PLANT FOOD; SUBSTANCES FOR REGULATING PLANT GROWTH; ORGANIC CHELATED MINERALS, NAMELY, MINERAL FERTILIZING PREPARATIONS TO PREVENT OR CORRECT NUTRIENT DEFICIENCIES FOR PLANTS; PLANT FOOD FOR INCREASING THE UPTAKE OF MINERALS IN PLANT TISSUES; PLANT FOOD CONTAINING CHELATED MINERAL COMPOSITIONS FOR APPLICATION TO SOILS TO ASSIST IN SEED GERMINATION AND PLANT GROWTH; NOURISHMENT FOR PLANTS, NAMELY, PLANT FOOD, FERTILIZERS AND/OR PLANT NUTRITION PREPARATIONS TO PREVENT OR CORRECT NUTRIENT DEFICIENCIES THAT MAY LIMIT CROP GROWTH AND YIELDS (U.S. CLS. 1, 5, 6, 10, 26 AND 46).

FIRST USE 12-6-1967; IN COMMERCE 5-31-1968.
 LANA PHAM, EXAMINING ATTORNEY

SN 77-432,517. KILFROST LIMITED, NORTHUMBERLAND, UNITED KINGDOM, FILED 3-26-2008.

DF SUSTAIN

THE MARK CONSISTS OF STANDARD CHARACTERS WITHOUT CLAIM TO ANY PARTICULAR FONT, STYLE, SIZE, OR COLOR.

FOR CHEMICAL PREPARATIONS FOR MELTING SNOW AND ICE; ANTI-FREEZING AND DE-ICING PREPARATIONS (U.S. CLS. 1, 5, 6, 10, 26 AND 46).
 MAUREEN DALL, EXAMINING ATTORNEY

SN 77-441,995. COSMOCEL S.A., S NICOLÁS DE LOS GARZA, MEXICO, FILED 4-7-2008.

TRIPLEX IRON

THE MARK CONSISTS OF STANDARD CHARACTERS WITHOUT CLAIM TO ANY PARTICULAR FONT, STYLE, SIZE, OR COLOR.

NO CLAIM IS MADE TO THE EXCLUSIVE RIGHT TO USE "IRON", APART FROM THE MARK AS SHOWN.
 FOR FERTILIZERS FOR AGRICULTURAL USE (U.S. CLS. 1, 5, 6, 10, 26 AND 46).
 FIRST USE 12-1-2007; IN COMMERCE 12-1-2007.
 WILLIAM BRECKENFELD, EXAMINING ATTORNEY

CLASS 1—(Continued).

SN 77-442,018. COSMOCEL S.A., S NICOLÁS DE LOS GARZA, MEXICO, FILED 4-7-2008.

RX-SILVER

THE MARK CONSISTS OF STANDARD CHARACTERS WITHOUT CLAIM TO ANY PARTICULAR FONT, STYLE, SIZE, OR COLOR.

FOR FERTILIZERS FOR AGRICULTURAL USE (U.S. CLS. 1, 5, 6, 10, 26 AND 46).
 FIRST USE 12-1-2007; IN COMMERCE 12-1-2007.
 WILLIAM BRECKENFELD, EXAMINING ATTORNEY

SN 77-446,189. MERCK KGAA, 64293 DARMSTADT, FED REP GERMANY, FILED 4-11-2008.

WE MAKE COMMUNICATION VISIBLE

THE MARK CONSISTS OF STANDARD CHARACTERS WITHOUT CLAIM TO ANY PARTICULAR FONT, STYLE, SIZE, OR COLOR.

OWNER OF U.S. REG. NO. 3,446,431.
 FOR CHEMICALS FOR USE IN INDUSTRY AND SCIENCE (U.S. CLS. 1, 5, 6, 10, 26 AND 46).
 CARYN GLASSER, EXAMINING ATTORNEY

SN 77-453,402. COSMOCEL S.A., S NICOLÁS DE LOS GARZA, MEXICO, FILED 4-21-2008.

RX SUPREME

THE MARK CONSISTS OF STANDARD CHARACTERS WITHOUT CLAIM TO ANY PARTICULAR FONT, STYLE, SIZE, OR COLOR.

NO CLAIM IS MADE TO THE EXCLUSIVE RIGHT TO USE "SUPREME", APART FROM THE MARK AS SHOWN.
 FOR FERTILIZERS FOR AGRICULTURAL USE (U.S. CLS. 1, 5, 6, 10, 26 AND 46).
 FIRST USE 12-1-2007; IN COMMERCE 12-1-2007.
 WILLIAM BRECKENFELD, EXAMINING ATTORNEY

CLASS 1—(Continued).

SN 77-477,176. N-ERGY CORPORATION, CANBY, OR.
FILED 5-16-2008.

N-ERGY

THE MARK CONSISTS OF STANDARD CHARACTERS WITHOUT CLAIM TO ANY PARTICULAR FONT, STYLE, SIZE, OR COLOR.

FOR SOIL, NAMELY, PLANTING SOIL; POTTING SOIL; SOIL ADDITIVES; SOIL AMENDMENTS; FERTILIZERS; CHEMICAL SOIL CONDITIONERS; SOIL IMPROVING AGENTS; PLANT GROWTH MEDIA; AGENTS AND ADDITIVES FOR PLANT GROWTH AND HEALTH (U.S. CLS. 1, 5, 6, 10, 26 AND 46).

ELISSA GARBER KON, EXAMINING ATTORNEY

SN 77-488,961. VALENT BIOSCIENCES CORPORATION,
LIBERTYVILLE, IL. FILED 6-2-2008.

PROTONE

THE MARK CONSISTS OF STANDARD CHARACTERS WITHOUT CLAIM TO ANY PARTICULAR FONT, STYLE, SIZE, OR COLOR.

THE ENGLISH TRANSLATION OF "PROTONE" IS "PROTON".

FOR PLANT GROWTH REGULATOR FOR USE ON GRAPE VINE PLANTS (U.S. CLS. 1, 5, 6, 10, 26 AND 46).

MAUREEN DALL, EXAMINING ATTORNEY

SN 77-500,433. MINNTECH CORPORATION, MINNEAPOLIS, MN. FILED 6-17-2008.

NEUTRA-HYDE

THE MARK CONSISTS OF STANDARD CHARACTERS WITHOUT CLAIM TO ANY PARTICULAR FONT, STYLE, SIZE, OR COLOR.

FOR CHEMICAL AGENTS IN THE NATURE OF GLYCINE-BASED NEUTRALIZERS FOR DEACTIVATING ALDEHYDE-BASED DISINFECTANTS USED IN MEDICAL AND HEALTHCARE APPLICATIONS (U.S. CLS. 1, 5, 6, 10, 26 AND 46).

NICHOLAS ALTREE, EXAMINING ATTORNEY

CLASS 1—(Continued).

SN 77-502,981. NOF CORPORATION, TOKYO, JAPAN,
FILED 6-19-2008.

NICHIYUMER

THE MARK CONSISTS OF STANDARD CHARACTERS WITHOUT CLAIM TO ANY PARTICULAR FONT, STYLE, SIZE, OR COLOR.

FOR CHEMICALS FOR USE IN THE MANUFACTURE AND/OR CHEMICAL MODIFICATION OF PAPER, PULP, LINGERIE FABRIC AND OTHER FABRICS, AND TEXTILES (U.S. CLS. 1, 5, 6, 10, 26 AND 46).

TIMOTHY FINNEGAN, EXAMINING ATTORNEY

SN 77-506,721. BIOBASED CHEMICALS, LLC, DBA BIOBASED TECHNOLOGIES, LLC, FAYETTEVILLE, AR.
FILED 6-24-2008.



OWNER OF U.S. REG. NO. 3,400,379.
NO CLAIM IS MADE TO THE EXCLUSIVE RIGHT TO USE "BIOBASED TECHNOLOGIES", APART FROM THE MARK AS SHOWN.

THE MARK CONSISTS OF THE WORDING "BIOBASED TECHNOLOGIES" WITH A LINE UNDER "TECHNOLOGIES" AND A LEAF DESIGN.

FOR AGRICULTURALLY BASED POLYOLS FOR USE IN THE PRODUCTION OF POLYURETHANE (U.S. CLS. 1, 5, 6, 10, 26 AND 46).

FIRST USE 10-15-2005; IN COMMERCE 10-15-2005.

TRACY CROSS, EXAMINING ATTORNEY

CLASS 1—(Continued).

SN 77-516,694. BIOBASED CHEMICALS, LLC, DBA BIOBASED TECHNOLOGIES, LLC, FAYETTEVILLE, AR. FILED 7-8-2008.

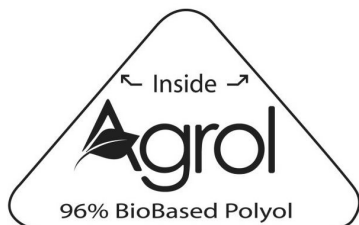

OWNER OF U.S. REG. NOS. 3,080,725 AND 3,400,379. NO CLAIM IS MADE TO THE EXCLUSIVE RIGHT TO USE "96% BIOBASED POLYOL", APART FROM THE MARK AS SHOWN.

THE MARK CONSISTS OF A TRIANGLE WITH THE FOLLOWING WORDS LOCATED INSIDE OF THE TRIANGLE: "INSIDE. AGROL. 96% BIOBASED POLYOL" WITH A LEAF DESIGN.

FOR AGRICULTURALLY BASED POLYOLS FOR USE IN THE PRODUCTION OF POLYURETHANE (U.S. CLS. 1, 5, 6, 10, 26 AND 46).

FIRST USE 10-15-2005; IN COMMERCE 10-15-2005. TRACY CROSS, EXAMINING ATTORNEY

CLASS 1—(Continued).

SN 77-522,456. KEMIRA WATER SOLUTIONS, INC., LAKE-LAND, FL. FILED 7-15-2008.

KLASP

THE MARK CONSISTS OF STANDARD CHARACTERS WITHOUT CLAIM TO ANY PARTICULAR FONT, STYLE, SIZE, OR COLOR.

THE MARK "KLASP" HAS NO MEANING IN A FOREIGN LANGUAGE.

FOR CHEMICALS, NAMELY, FERRIC HYDRATE AND FERRIC SULFATE COMPOSITIONS, USED TO LOWER AMMONIA EMISSIONS AND SEQUESTER SOLUBLE PHOSPHOROUS IN ANIMAL LITTER OR BEDDING MATERIALS (U.S. CLS. 1, 5, 6, 10, 26 AND 46).

RONALD MCMORROW, EXAMINING ATTORNEY

SN 77-518,919. MICRO ESSENTIAL LABORATORY, INC., BROOKLYN, NY. FILED 7-10-2008.

WWW.MICROESSENTIALLAB.COM

SN 77-526,926. THE DOW CHEMICAL COMPANY, MIDLAND, MI. FILED 7-21-2008.

K-DOW PETROCHEMICALS

THE MARK CONSISTS OF STANDARD CHARACTERS WITHOUT CLAIM TO ANY PARTICULAR FONT, STYLE, SIZE, OR COLOR.

FOR CHEMICAL TEST PRODUCTS, NAMELY, CHEMICAL TEST PAPERS, CHEMICAL INDICATORS, CHEMICAL TEST KITS, CHEMICAL INDICATOR KITS, PH INDICATOR PENCILS, CHEMICAL BUFFERS, BUFFER SALTS, BUFFER PRESERVATIVES, DISPENSERS SOLD WITH CHEMICAL TEST PAPERS AND AS PART OF CHEMICAL TEST KITS AND CHEMICAL INDICATOR KITS, COLOR CHARTS SOLD WITH CHEMICAL TEST PAPERS AND AS PART OF CHEMICAL TEST KITS AND CHEMICAL INDICATOR KITS, ALL OF THE FOREGOING FOR USE IN TESTING, DETECTING, IDENTIFYING, MEASURING, AND INDICATING LEVELS OF PH, OF SANITIZERS, AND OF OTHER SUBSTANCES, NAMELY, WATER, AMMONIA, CHLORINE, IODINE, QUATERNARY AMMONIUM CHLORIDE FORMULATIONS AND BUFFER SALTS (U.S. CLS. 1, 5, 6, 10, 26 AND 46).

FIRST USE 10-31-2001; IN COMMERCE 10-31-2001. JULIE WATSON, EXAMINING ATTORNEY

THE MARK CONSISTS OF STANDARD CHARACTERS WITHOUT CLAIM TO ANY PARTICULAR FONT, STYLE, SIZE, OR COLOR.

NO CLAIM IS MADE TO THE EXCLUSIVE RIGHT TO USE "PETROCHEMICALS", APART FROM THE MARK AS SHOWN.

FOR CHEMICALS FOR USE IN THE MANUFACTURE OF A WIDE VARIETY OF GOODS, UNPROCESSED ARTIFICIAL RESINS, UNPROCESSED PLASTICS AND ADHESIVES USED IN INDUSTRY (U.S. CLS. 1, 5, 6, 10, 26 AND 46).

TRACY CROSS, EXAMINING ATTORNEY

CLASS 1—(Continued).

SN 77-549,795. ASSAY DESIGNS, INC., ANN ARBOR, MI.
FILED 8-18-2008.

ASSAY DESIGNS

THE MARK CONSISTS OF STANDARD CHARACTERS WITHOUT CLAIM TO ANY PARTICULAR FONT, STYLE, SIZE, OR COLOR.

OWNER OF U.S. REG. NO. 3,398,379.
SEC. 2(F).

FOR ASSAYS FOR RESEARCH PURPOSES; BIO-CHEMICALS, NAMELY, PROTEINS, MONOCLONAL AND POLYCLONAL ANTIBODIES FOR IN VITRO SCIENTIFIC AND RESEARCH USE; REAGENTS FOR RESEARCH PURPOSES; CHEMICAL REAGENTS FOR NON-MEDICAL PURPOSES, NAMELY, FOR USE IN EVALUATING ASSAY DETECTION RESPONSE; REAGENTS FOR SCIENTIFIC AND MEDICAL RESEARCH USE; REAGENTS FOR USE IN SCIENTIFIC APPARATUS FOR CHEMICAL OR BIOLOGICAL ANALYSIS (U.S. CLS. 1, 5, 6, 10, 26 AND 46).

FIRST USE 0-0-1995; IN COMMERCE 0-0-1995.

LINDA MICKLEBURGH, EXAMINING ATTORNEY

SN 77-553,463. SYNDICATE SALES, INC., KOKOMO, IN.
FILED 8-22-2008.

ECOGRO

THE MARK CONSISTS OF STANDARD CHARACTERS WITHOUT CLAIM TO ANY PARTICULAR FONT, STYLE, SIZE, OR COLOR.

FOR ARTIFICIAL PLANT-CULTIVATION SOIL (U.S. CLS. 1, 5, 6, 10, 26 AND 46).

WENDY GOODMAN, EXAMINING ATTORNEY

SN 77-557,947. WAYLAND, DAVE, ENUMCLAW, WA.
FILED 8-28-2008.

BIO-TIRE BALLAST

THE MARK CONSISTS OF STANDARD CHARACTERS WITHOUT CLAIM TO ANY PARTICULAR FONT, STYLE, SIZE, OR COLOR.

NO CLAIM IS MADE TO THE EXCLUSIVE RIGHT TO USE "BALLAST", APART FROM THE MARK AS SHOWN.

FOR CHEMICAL PREPARATION TO PROTECT AGAINST RUST AND OXIDATION ON TIRE RIMS (U.S. CLS. 1, 5, 6, 10, 26 AND 46).

FIRST USE 10-31-2006; IN COMMERCE 10-31-2006.

BARBARA BROWN, EXAMINING ATTORNEY

CLASS 1—(Continued).

SN 77-560,018. JINCHUAN GROUP LTD., JINCHANG, GAN-SU PROVINCE, CHINA, FILED 9-2-2008.



THE MARK CONSISTS OF THE LETTERS "JNMC" IN STYLIZED LETTERING.

FOR NITROGEN; OXYGEN; CHLORINE; LIQUID CHLORINE; AMMONIA FOR INDUSTRIAL PURPOSES; DRY ICE; OXALIC ACID; SULPHUR AS NON-METALLIC ELEMENT; SULPHUR AS NON-METALLIC MINERAL; NITRIC ACID; HYDROCHLORIC ACID; SULPHURIC ACID; METALLATES, NAMELY, METAL SALTS OF ACIDS; SALTS FROM RARE EARTH METALS; MAGNESIUM SALTS; SALT FOR WATER SOFTENING; HALIDES AND HALOGEN ACID SALTS; SALT NEUTRALIZING CHEMICAL FOR LAWN GRASS; CHEMICALS FOR USE IN INDUSTRY AND SCIENCE; FERTILIZERS FOR AGRICULTURAL USE; MIXED FERTILIZERS (U.S. CLS. 1, 5, 6, 10, 26 AND 46).

TARA PATE, EXAMINING ATTORNEY

SN 77-563,722. PRINCE MINERALS, INC., NEW CASTLE, DE. FILED 9-5-2008.

SURECAST

THE MARK CONSISTS OF STANDARD CHARACTERS WITHOUT CLAIM TO ANY PARTICULAR FONT, STYLE, SIZE, OR COLOR.

FOR MINERAL SUBSTANCES USED AS AN ANTI-VEINING AGENT IN THE FOUNDRY INDUSTRY (U.S. CLS. 1, 5, 6, 10, 26 AND 46).

ALEXANDER L. POWERS, EXAMINING ATTORNEY

SN 77-563,740. PRINCE MINERALS, INC., NEW CASTLE, DE. FILED 9-5-2008.

CHROMECAST

THE MARK CONSISTS OF STANDARD CHARACTERS WITHOUT CLAIM TO ANY PARTICULAR FONT, STYLE, SIZE, OR COLOR.

FOR FOUNDRY SAND (U.S. CLS. 1, 5, 6, 10, 26 AND 46).

FIRST USE 1-2-2008; IN COMMERCE 1-2-2008.

ALEXANDER L. POWERS, EXAMINING ATTORNEY

CLASS 1—(Continued).

SN 77-563,748. PRINCE MINERALS, INC., NEW CASTLE, DE. FILED 9-5-2008.

ZIR-CAST

THE MARK CONSISTS OF STANDARD CHARACTERS WITHOUT CLAIM TO ANY PARTICULAR FONT, STYLE, SIZE, OR COLOR.
FOR FOUNDRY SAND (U.S. CLS. 1, 5, 6, 10, 26 AND 46).
FIRST USE 1-2-2008; IN COMMERCE 1-2-2008.
ALEXANDER L. POWERS, EXAMINING ATTORNEY

CLASS 1—(Continued).

SN 77-568,050. SI GROUP, INC., SCHENECTADY, NY. FILED 9-11-2008.

AQUYD

THE MARK CONSISTS OF STANDARD CHARACTERS WITHOUT CLAIM TO ANY PARTICULAR FONT, STYLE, SIZE, OR COLOR.
FOR INDUSTRIAL CHEMICALS, NAMELY, ALKYD DISPERSIONS (U.S. CLS. 1, 5, 6, 10, 26 AND 46).
KEVON CHISOLM, EXAMINING ATTORNEY

SN 77-564,247. PATHWAY POLYMERS, INC., CHATTANOOGA, TN. FILED 9-8-2008.



THE MARK CONSISTS OF A DESIGN OF TWO OVERLAPPING ARROWS TO THE LEFT OF THE STYLIZED WORDS "PATHWAY POLYMERS".
FOR POLYURETHANES, NAMELY, CUSTOM FORMULATIONS OF ONE AND TWO COMPONENT REACTIVE POLYURETHANE COMPOUNDS FOR USE IN FLAT PROOFING OF TIRES, PAPER PROCESSING, MANUFACTURING OF ARTIFICIAL STONES AND ROCKS AND GENERAL INDUSTRIAL APPLICATIONS (U.S. CLS. 1, 5, 6, 10, 26 AND 46).
FIRST USE 11-29-2007; IN COMMERCE 11-29-2007.
DAWN FELDMAN, EXAMINING ATTORNEY

SN 77-568,085. FELKNOR VENTURES LLC, KNOXVILLE, TN. FILED 9-11-2008.

TOPSY TURVY

THE MARK CONSISTS OF STANDARD CHARACTERS WITHOUT CLAIM TO ANY PARTICULAR FONT, STYLE, SIZE, OR COLOR.
OWNER OF U.S. REG. NO. 3,367,525.
FOR POTTING SOIL; PLANT FERTILIZER (U.S. CLS. 1, 5, 6, 10, 26 AND 46).
AISHA SALEM, EXAMINING ATTORNEY

SN 77-566,516. DXTERITY DIAGNOSTICS, RANCHO DOMINGUEZ, CA. FILED 9-10-2008.

Neat

THE MARK CONSISTS OF STANDARD CHARACTERS WITHOUT CLAIM TO ANY PARTICULAR FONT, STYLE, SIZE, OR COLOR.
FOR DIAGNOSTIC REAGENTS FOR CLINICAL OR MEDICAL LABORATORY USE; DIAGNOSTIC REAGENTS FOR IN VITRO USE IN BIOCHEMISTRY, CLINICAL CHEMISTRY AND MICROBIOLOGY (U.S. CLS. 1, 5, 6, 10, 26 AND 46).
SHARON MEIER, EXAMINING ATTORNEY

SN 77-571,326. SYNDICATE SALES, INC., KOKOMO, IN. FILED 9-16-2008.

Steadygro

THE MARK CONSISTS OF STANDARD CHARACTERS WITHOUT CLAIM TO ANY PARTICULAR FONT, STYLE, SIZE, OR COLOR.
FOR ARTIFICIAL PLANT-CULTIVATION SOIL (U.S. CLS. 1, 5, 6, 10, 26 AND 46).
WENDY GOODMAN, EXAMINING ATTORNEY

CLASS 1—(Continued).

SN 77-571,737. FLAME TECH INC, WINSTON-SALEM, NC. FILED 9-17-2008.



NO CLAIM IS MADE TO THE EXCLUSIVE RIGHT TO USE "FLAME", APART FROM THE MARK AS SHOWN.

THE MARK CONSISTS OF THE WORDS "FLAME TECH" TO THE RIGHT OF A DRAWING OF A FLAME.

FOR FIRE RETARDANT COMPOSITIONS FOR COMMERCIAL AND DOMESTIC USE (U.S. CLS. 1, 5, 6, 10, 26 AND 46).

FIRST USE 5-1-2002; IN COMMERCE 5-1-2002.
MELVIN AXILBUND, EXAMINING ATTORNEY

CLASS 1—(Continued).

SN 77-575,995. UR STUFF, LLC, WAUKEGAN, IL. FILED 9-22-2008.



THE MARK CONSISTS OF A STYLIZED DRAWING OF A FIREMAN'S HELMET WITH A CHRISTMAS TREE SHAPE DISPLAYED ON THE FRONT PLAQUE. THE WORD "TREECHIEF" IS DISPLAYED UNDERNEATH THE HELMET.

FOR CHEMICAL SPRAY PREPARATIONS CONTAINING FIRE RETARDANT CHEMICALS USED TO PROTECT PERSONAL PROPERTY (U.S. CLS. 1, 5, 6, 10, 26 AND 46).

KATHLEEN M. VANSTON, EXAMINING ATTORNEY

SN 79-043,439. DANISCO A/S, DENMARK, FILED 8-22-2007.

MAXALIQ

THE MARK CONSISTS OF STANDARD CHARACTERS WITHOUT CLAIM TO ANY PARTICULAR FONT, STYLE, SIZE, OR COLOR.

PRIORITY DATE OF 5-29-2007 IS CLAIMED.
OWNER OF INTERNATIONAL REGISTRATION 0936500 DATED 8-22-2007, EXPIRES 8-22-2017.

FOR ENZYMES FOR USE IN THE FUEL INDUSTRY (U.S. CLS. 1, 5, 6, 10, 26 AND 46).
ANDREA K. NADELMAN, EXAMINING ATTORNEY

SN 77-573,254. STATICWORX, INC., WATERTOWN, MA. FILED 9-18-2008.

STATBOND

SN 79-061,696. DSM IP ASSETS B.V., NETHERLANDS, FILED 7-28-2008.

SYNOLITE

THE MARK CONSISTS OF STANDARD CHARACTERS WITHOUT CLAIM TO ANY PARTICULAR FONT, STYLE, SIZE, OR COLOR.

FOR INDUSTRIAL ADHESIVES; CONSTRUCTION INDUSTRY ADHESIVES (U.S. CLS. 1, 5, 6, 10, 26 AND 46).

FIRST USE 2-1-2007; IN COMMERCE 2-1-2007.
ROBIN MITTLER, EXAMINING ATTORNEY

OWNER OF INTERNATIONAL REGISTRATION 0188130 DATED 10-17-1955, EXPIRES 10-17-2015.

FOR RAW POLYESTER RESINS (U.S. CLS. 1, 5, 6, 10, 26 AND 46).
BRENDAN MCCAULEY, EXAMINING ATTORNEY

CLASS 2—PAINTS

CLASS 2—(Continued).

SN 76-692,752. PIONEER MANUFACTURING COMPANY, CLEVELAND, OH. FILED 9-10-2008.

SN 77-556,215. MICROBLEND TECHNOLOGIES, INC., GILBERT, AZ. FILED 8-26-2008.

GAMELINE

SIMPLY BETTER PAINT

THE MARK CONSISTS OF STANDARD CHARACTERS WITHOUT CLAIM TO ANY PARTICULAR FONT, STYLE, SIZE, OR COLOR.
FOR PAINTS USED ON ATHLETIC FIELDS FOR MARKING AND GRAPHICS (U.S. CLS. 6, 11 AND 16).
FIRST USE 2-0-2007; IN COMMERCE 2-0-2007.
ALICIA COLLINS, EXAMINING ATTORNEY

THE MARK CONSISTS OF STANDARD CHARACTERS WITHOUT CLAIM TO ANY PARTICULAR FONT, STYLE, SIZE, OR COLOR.
NO CLAIM IS MADE TO THE EXCLUSIVE RIGHT TO USE "BETTER PAINT", APART FROM THE MARK AS SHOWN.
FOR EXTERIOR AND INTERIOR PAINTS, VARNISHES, CLEAR FINISHES, STAINS AND PRIMERS (U.S. CLS. 6, 11 AND 16).
ASMAT KHAN, EXAMINING ATTORNEY

SN 76-692,755. PIONEER MANUFACTURING COMPANY, CLEVELAND, OH. FILED 9-10-2008.

SN 77-556,241. MICROBLEND TECHNOLOGIES, INC., GILBERT, AZ. FILED 8-26-2008.

SEASONLINE

SIMPLY GREENER

THE MARK CONSISTS OF STANDARD CHARACTERS WITHOUT CLAIM TO ANY PARTICULAR FONT, STYLE, SIZE, OR COLOR.
FOR PAINTS USED ON ATHLETIC FIELDS FOR MARKING AND GRAPHICS (U.S. CLS. 6, 11 AND 16).
FIRST USE 2-0-2007; IN COMMERCE 2-0-2007.
ALICIA COLLINS, EXAMINING ATTORNEY

THE MARK CONSISTS OF STANDARD CHARACTERS WITHOUT CLAIM TO ANY PARTICULAR FONT, STYLE, SIZE, OR COLOR.
NO CLAIM IS MADE TO THE EXCLUSIVE RIGHT TO USE "GREENER", APART FROM THE MARK AS SHOWN.
FOR EXTERIOR AND INTERIOR PAINTS, VARNISHES, CLEAR FINISHES, STAINS AND PRIMERS (U.S. CLS. 6, 11 AND 16).
ASMAT KHAN, EXAMINING ATTORNEY

SN 77-556,106. MICROBLEND TECHNOLOGIES, INC., GILBERT, AZ. FILED 8-26-2008.

SN 77-563,518. MASTERCHEM INDUSTRIES LLC, IMPERIAL, MO. FILED 9-5-2008.

FRESH IS SIMPLY BETTER

RUST DEFENDER

THE MARK CONSISTS OF STANDARD CHARACTERS WITHOUT CLAIM TO ANY PARTICULAR FONT, STYLE, SIZE, OR COLOR.
FOR EXTERIOR AND INTERIOR PAINTS, VARNISHES, CLEAR FINISHES, STAINS AND PRIMERS (U.S. CLS. 6, 11 AND 16).
ASMAT KHAN, EXAMINING ATTORNEY

THE MARK CONSISTS OF STANDARD CHARACTERS WITHOUT CLAIM TO ANY PARTICULAR FONT, STYLE, SIZE, OR COLOR.
OWNER OF U.S. REG. NO. 1,510,592.
NO CLAIM IS MADE TO THE EXCLUSIVE RIGHT TO USE "RUST", APART FROM THE MARK AS SHOWN.
FOR ARCHITECTURAL COATINGS, NAMELY, INTERIOR AND EXTERIOR PAINT AND PRIMER (U.S. CLS. 6, 11 AND 16).
JOHN DALIER, EXAMINING ATTORNEY

CLASS 2—(Continued).

SN 77-564,609. COMPLEMENTARY COATINGS CORP., STONY POINT, NY. FILED 9-8-2008.

NATURESCAPE

THE MARK CONSISTS OF STANDARD CHARACTERS WITHOUT CLAIM TO ANY PARTICULAR FONT, STYLE, SIZE, OR COLOR.
FOR PAINTS AND LACQUERS (U.S. CLS. 6, 11 AND 16).
FIRST USE 8-1-2008; IN COMMERCE 8-1-2008.
BRENDAN MCCAULEY, EXAMINING ATTORNEY

SN 77-564,635. COMPLEMENTARY COATINGS CORP., STONY POINT, NY. FILED 9-8-2008.

NATURALAIR

THE MARK CONSISTS OF STANDARD CHARACTERS WITHOUT CLAIM TO ANY PARTICULAR FONT, STYLE, SIZE, OR COLOR.
FOR PAINTS AND LACQUERS (U.S. CLS. 6, 11 AND 16).
FIRST USE 8-1-2008; IN COMMERCE 8-1-2008.
BRENDAN MCCAULEY, EXAMINING ATTORNEY

SN 77-567,283. GENERAL PLASTIC INDUSTRIAL CO., LTD., TAICHUNG COUNTY, TAIWAN, FILED 9-10-2008.

CRYSTAL WIZARD

THE MARK CONSISTS OF STYLIZED WORDING "CRYSTAL WIZARD".
FOR PHOTOCOPIER TONERS, PRINTER TONERS, TONER FILLED CARTRIDGES, AND TONER CARTRIDGES FOR PHOTOCOPIER AND TONER CARTRIDGES FOR PRINTERS (U.S. CLS. 6, 11 AND 16).
SCOTT BIBB, EXAMINING ATTORNEY

CLASS 2—(Continued).

SN 77-568,102. FARROW & BALL HOLDINGS LIMITED, WIMBORNE, DORSET, UNITED KINGDOM, FILED 9-11-2008.

ARSENIC

THE MARK CONSISTS OF STANDARD CHARACTERS WITHOUT CLAIM TO ANY PARTICULAR FONT, STYLE, SIZE, OR COLOR.
FOR INTERIOR AND EXTERIOR PAINTS (U.S. CLS. 6, 11 AND 16).
SONYA STEPHENS, EXAMINING ATTORNEY

SN 77-568,117. FARROW & BALL HOLDINGS LIMITED, WIMBORNE, DORSET, UNITED KINGDOM, FILED 9-11-2008.

BORROWED LIGHT

THE MARK CONSISTS OF STANDARD CHARACTERS WITHOUT CLAIM TO ANY PARTICULAR FONT, STYLE, SIZE, OR COLOR.
FOR INTERIOR AND EXTERIOR PAINTS (U.S. CLS. 6, 11 AND 16).
SONYA STEPHENS, EXAMINING ATTORNEY

SN 77-570,909. SWIMC, INC., WILMINGTON, DE. FILED 9-16-2008.

EPOLON

THE MARK CONSISTS OF STANDARD CHARACTERS WITHOUT CLAIM TO ANY PARTICULAR FONT, STYLE, SIZE, OR COLOR.
FOR PAINTS (U.S. CLS. 6, 11 AND 16).
FIRST USE 12-20-2004; IN COMMERCE 12-20-2004.
JOHN E. MICHOS, EXAMINING ATTORNEY

CLASS 2—(Continued).

SN 77-572,838. SWIMC, INC., WILMINGTON, DE. FILED 9-18-2008.

GALVITE

THE MARK CONSISTS OF STANDARD CHARACTERS WITHOUT CLAIM TO ANY PARTICULAR FONT, STYLE, SIZE, OR COLOR.

FOR PAINTS (U.S. CLS. 6, 11 AND 16).
FIRST USE 9-3-2002; IN COMMERCE 9-3-2002.
JOHN E. MICHOS, EXAMINING ATTORNEY

SN 77-576,252. VALSPAR SOURCING, INC., MINNEAPOLIS, MN. FILED 9-23-2008.

AUTOVATE

THE MARK CONSISTS OF STANDARD CHARACTERS WITHOUT CLAIM TO ANY PARTICULAR FONT, STYLE, SIZE, OR COLOR.

FOR PRIMER AND CLEAR COATS, NAMELY, CLEAR COATING PROTECTANTS FOR VEHICLES AND METAL SUBSTRATES (U.S. CLS. 6, 11 AND 16).
RUDY R. SINGLETON, EXAMINING ATTORNEY

SN 77-578,738. TEIKOKU PRINTING INKS MFG. CO., LTD., TOKYO, JAPAN, FILED 9-25-2008.

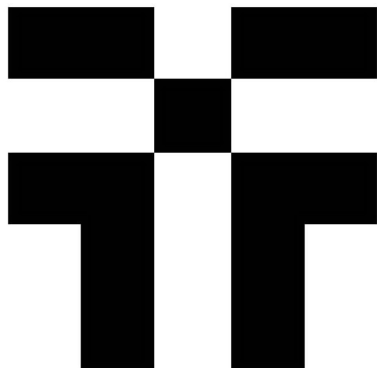

THE MARK CONSISTS OF A SHADED SQUARE WHERE EACH CORNER OF THE SQUARE IS CONNECTED TO THE

CLASS 2—(Continued).

CORNER OF A SHADED RECTANGLE; THE TOP LEFT CORNER OF THE SQUARE IS CONNECTED TO A RECTANGLE THAT IS HORIZONTALLY DISPOSED TO THE SQUARE; THE TOP RIGHT CORNER OF THE SQUARE IS CONNECTED TO A RECTANGLE THAT IS HORIZONTALLY DISPOSED TO THE SQUARE; THE BOTTOM LEFT CORNER OF THE SQUARE IS CONNECTED TO A REVERSE INVERTED "L" SHAPED LETTER AND THE BOTTOM RIGHT CORNER OF THE SQUARE IS CONNECTED TO AN INVERTED "L" SHAPED LETTER.

FOR PRINTING INK; COPYING INKS; METALLIC INKS; THERMOCHROMIC PRINTING INKS (U.S. CLS. 6, 11 AND 16).
FIRST USE 4-1-1989; IN COMMERCE 4-1-1989.
FRANK LATTUCA, EXAMINING ATTORNEY

SN 77-586,872. SWIMC, INC., WILMINGTON, DE. FILED 10-7-2008.

GREAT OUTDOORS

THE MARK CONSISTS OF STANDARD CHARACTERS WITHOUT CLAIM TO ANY PARTICULAR FONT, STYLE, SIZE, OR COLOR.

OWNER OF U.S. REG. NO. 2,170,292.
FOR WOOD STAINS (U.S. CLS. 6, 11 AND 16).
FIRST USE 4-25-1997; IN COMMERCE 4-25-1997.
MICHAEL LITZAU, EXAMINING ATTORNEY

CLASS 3—COSMETICS AND CLEANING PREPARATIONS

SN 76-692,649. BATAIFF, ALLAN, MONTEBELLO, CA. FILED 9-9-2008.



THE MARK CONSISTS OF A STYLIZED PERSON ON A SURFBOARD APPEARING ABOVE THE WORDING "LITTORAL LEGENDS".
FOR SUNBLOCK (U.S. CLS. 1, 4, 6, 50, 51 AND 52).
MARC LEIPZIG, EXAMINING ATTORNEY

CLASS 3—(Continued).

SN 77-015,857. NATURA COSMÉTICOS S/A, ITAPECERICA DA SERRA, BRAZIL, FILED 10-6-2006.

NATURA HOMEM

THE MARK CONSISTS OF STANDARD CHARACTERS WITHOUT CLAIM TO ANY PARTICULAR FONT, STYLE, SIZE, OR COLOR.

OWNER OF BRAZIL REG. NO. 818534524, DATED 10-28-1997, RENEWED AS REG. NO. 818534524, DATED 10-28-2007, EXPIRES 10-28-2017.

OWNER OF U.S. REG. NO. 2,164,917.

NO CLAIM IS MADE TO THE EXCLUSIVE RIGHT TO USE "HOMEM", APART FROM THE MARK AS SHOWN.

FOR PERFUMERY; NON-MEDICATED TOILETRIES; HYGIENE PRODUCTS AND TOILETRY ARTICLES, NAMELY, DEODORANTS, HAIR SHAMPOO, HAIR CONDITIONER, HAIR CARE PREPARATIONS, AFTER-SHAVE PREPARATIONS, SHAVING GELS, BODY SPRAYS, LIQUID SOAPS FOR THE FACE AND BODY AND EXFOLIATING SOAPS (U.S. CLS. 1, 4, 6, 50, 51 AND 52).

PAUL E. FAHRENKOPF, EXAMINING ATTORNEY

SN 77-186,636. MANA PRODUCTS, INC., LONG ISLAND CITY, NY. FILED 5-22-2007.

HAIRBUILDERS

THE MARK CONSISTS OF STANDARD CHARACTERS WITHOUT CLAIM TO ANY PARTICULAR FONT, STYLE, SIZE, OR COLOR.

FOR NON-MEDICATED SHAMPOO, NON-MEDICATED HAIR CONDITIONER, HAIR GEL, HAIR CARE LOTIONS, HAIR CARE CREAMS, AND HAIR SPRAY (U.S. CLS. 1, 4, 6, 50, 51 AND 52).

SHAILA SETTLES, EXAMINING ATTORNEY

CLASS 3—(Continued).

SN 77-349,011. LANCOME PARFUMS ET BEAUTE & CIE, PARIS, FRANCE, FILED 12-11-2007.

L'ABSOLU

THE MARK CONSISTS OF STANDARD CHARACTERS WITHOUT CLAIM TO ANY PARTICULAR FONT, STYLE, SIZE, OR COLOR.

OWNER OF U.S. REG. NO. 945,914.

THE FOREIGN WORDING IN THE MARK TRANSLATES INTO ENGLISH AS THE ABSOLUTE.

FOR COSMETICS, NAMELY, CREAMS, GELS, MILKS, POWDERS AND LOTIONS FOR THE FACE, BODY AND HANDS; MAKEUP PRODUCTS, NAMELY, MASCARA, EYE LINER, EYE SHADOW, EYEBROW PENCIL, LIP-STICKS, NAIL POLISH, BLUSH, FOUNDATION CREAMS AND POWDER, BODY DEODORANTS; SUN CARE PREPARATIONS, NAMELY, TANNING AND AFTER-SUN MILKS, GELS AND OILS (U.S. CLS. 1, 4, 6, 50, 51 AND 52).

RUDY R. SINGLETON, EXAMINING ATTORNEY

SN 77-376,089. MESO PRIVATE LIMITED, LALBAUG, INDIA, FILED 1-19-2008.

MONTEGO

THE MARK CONSISTS OF STANDARD CHARACTERS WITHOUT CLAIM TO ANY PARTICULAR FONT, STYLE, SIZE, OR COLOR.

THE MARK "MONTEGO" HAS NO MEANING IN A FOREIGN LANGUAGE.

FOR PERFUMES AND PERFUMERY COMPOUNDS, NAMELY, PERFUMED BODY POWDER, TALCUM POWDER, NON-MEDICATED TOILETRIES, PREPARATIONS AND OTHER SUBSTANCES FOR PERFUMERY PRODUCTS, NAMELY, FRAGRANCES, DEODORANTS FOR PERSONAL USE, BEAUTY PRODUCTS, NAMELY, LIP CONDITIONER, HENNA, LIP STICK, LIP BALM, NAIL POLISH, FACE POWDER, EYE LINER, EYE SHADOW, EYEBROW PENCILS, EYELINER PENCILS, SHADOW PENCILS AND MASCARA; NON-MEDICATED HAIR CARE PRODUCTS, NAMELY, HAIR OILS, HAIR LOTIONS, HAIR DYE, HAIR SHAMPOO, HAIR CONDITIONER, HAIR SPRAY, HAIR MOUSSE AND HAIR GEL; COLOR COSMETICS, NON-MEDICATED ORAL CARE PRODUCTS, FRAGRANCES, SOAPS, ESSENTIAL OILS, SKIN CARE PRODUCTS, NAMELY, SKIN RENEWAL CREAM, BODY LOTION, BODY OIL, SKIN BALANCING LOTION, SKIN FIRMING PREPARATION, NON-MEDICATED SKIN BLEMISH LOTIONS AND CREAMS, SKIN MOISTURIZER, NON-MEDICATED SKIN WRINKLE LOTIONS AND CREAMS, FACE CREAM, BODY CREAM, COLD CREAM, BODY MASK, SKIN TONE CORRECTOR CREAM, SKIN BLEACH AND SKIN CONCEALER; SUN CARE PRODUCTS, NAMELY, BODY SUNSCREEN, FACIAL SUNSCREEN, LIP SUNCARE, HAIR SUNSCREEN, SELF-TANNING PREPARATION, AFTER SUN SOOTHER AND BABY LOTION; DEPILATORIES AND NON-MEDICATED SKIN LOTIONS (U.S. CLS. 1, 4, 6, 50, 51 AND 52).

SUE LAWRENCE, EXAMINING ATTORNEY

CLASS 3—(Continued).

SN 77-389,327. TOTAL ECO SOLUTIONS, ATASCADERO, CA. FILED 2-5-2008.



NO CLAIM IS MADE TO THE EXCLUSIVE RIGHT TO USE "GREASE", APART FROM THE MARK AS SHOWN. THE COLOR(S) BLACK, WHITE, RED AND YELLOW IS/ ARE CLAIMED AS A FEATURE OF THE MARK.

THE MARK CONSISTS OF YELLOW LETTERS INCLUDING A BLACK DROP SHADOW. A WHITE BACKGROUND WITH A RED OUTLINE FOLLOWING AN ENLARGED SHAPE OF THE TEXT.

FOR ALL-PURPOSE CLEANERS; DE-GREASING PREPARATIONS FOR HOUSEHOLD PURPOSES (U.S. CLS. 1, 4, 6, 50, 51 AND 52).

KIMBERLY FRYE, EXAMINING ATTORNEY

CLASS 3—(Continued).

SN 77-405,839. JOHNSON & JOHNSON, NEW BRUNSWICK, NJ. FILED 2-26-2008.



OWNER OF U.S. REG. NOS. 791,169, 1,099,979 AND 1,452,799.

THE MARK CONSISTS OF THREE OVERLAPPING STYLIZED TEAR DROPS.

FOR TOILETRIES, NAMELY, HAIR SHAMPOO, HAIR CONDITIONER, SKIN CLEANSERS, SKIN MOISTURIZERS (U.S. CLS. 1, 4, 6, 50, 51 AND 52).

LEIGH LOWRY, EXAMINING ATTORNEY

SN 77-405,529. AWSOME PRODUCTS, INC., BUENA PARK, CA. FILED 2-25-2008.

FRUITAMIN

THE MARK CONSISTS OF STANDARD CHARACTERS WITHOUT CLAIM TO ANY PARTICULAR FONT, STYLE, SIZE, OR COLOR.

FOR TOILET PREPARATIONS, NAMELY, SOAP, SHAMPOO, HAIR CONDITIONER, SKIN LOTIONS AND MOISTURIZERS, AND LIQUID HAND SOAP (U.S. CLS. 1, 4, 6, 50, 51 AND 52).

BRIAN PINO, EXAMINING ATTORNEY

SN 77-405,844. JOHNSON & JOHNSON, NEW BRUNSWICK, NJ. FILED 2-26-2008.

K-Y INTENSE

THE MARK CONSISTS OF STANDARD CHARACTERS WITHOUT CLAIM TO ANY PARTICULAR FONT, STYLE, SIZE, OR COLOR.

OWNER OF U.S. REG. NOS. 54,124, 2,285,313 AND 3,290,289.

FOR NON-MEDICATED TOPICAL PREPARATIONS, NAMELY, GELS FOR ENHANCING SEXUAL AROUSAL (U.S. CLS. 1, 4, 6, 50, 51 AND 52).

LEIGH LOWRY, EXAMINING ATTORNEY

CLASS 3—(Continued).

SN 77-414,010. INTERVET INC., MILLSBORO, DE. FILED 3-5-2008.



OWNER OF U.S. REG. NOS. 1,520,254, 3,011,718 AND OTHERS.

NO CLAIM IS MADE TO THE EXCLUSIVE RIGHT TO USE "ANIMAL HEALTH", APART FROM THE MARK AS SHOWN.

THE COLOR(S) BLACK AND RED IS/ARE CLAIMED AS A FEATURE OF THE MARK.

THE MARK CONSISTS OF A STYLIZED "SP" IN RED TO THE LEFT OF THE BLACK WORDING "INTERVET SCHERING-PLOUGH ANIMAL HEALTH".

FOR SHAMPOO FOR ANIMALS (U.S. CLS. 1, 4, 6, 50, 51 AND 52).

REBECCA GILBERT, EXAMINING ATTORNEY

SN 77-452,677. JAFER LIMITED, HAMILTON, BERMUDA, FILED 4-18-2008.

Cercana
P A R F U M

OWNER OF PERU REG. NO. 00098992, DATED 8-3-2004, EXPIRES 8-3-2014.

NO CLAIM IS MADE TO THE EXCLUSIVE RIGHT TO USE "PARFUM", APART FROM THE MARK AS SHOWN.

THE FOREIGN WORDING IN THE MARK TRANSLATES INTO ENGLISH AS NEARBY.

FOR PERFUMES, FRAGRANCES, EAU DE TOILETTE, COLOGNES; SCENTED COSMETIC LOTIONS AND CREAMS FOR THE BODY, FEET, HANDS AND FACE; TOILETTE SOAP; ESSENTIAL OILS; SCENTED BODY DEODORANTS; TALCUM POWDER (U.S. CLS. 1, 4, 6, 50, 51 AND 52).

MARY CRAWFORD, EXAMINING ATTORNEY

SN 77-461,637. L'OREAL, PARIS, FRANCE, FILED 4-30-2008.

L'OREAL VOLUME COLLAGENE

THE MARK CONSISTS OF STANDARD CHARACTERS WITHOUT CLAIM TO ANY PARTICULAR FONT, STYLE, SIZE, OR COLOR.

OWNER OF U.S. REG. NOS. 540,541, 3,281,234 AND OTHERS.

NO CLAIM IS MADE TO THE EXCLUSIVE RIGHT TO USE "COLLAGEN", APART FROM THE MARK AS SHOWN. FOR MASCARAS (U.S. CLS. 1, 4, 6, 50, 51 AND 52).

TINA L. SNAPP, EXAMINING ATTORNEY

CLASS 3—(Continued).

SN 77-465,028. NOF CORPORATION, SHIBUYA-KU, TOKYO, JAPAN, FILED 5-3-2008.

CERACUTE

THE MARK CONSISTS OF STANDARD CHARACTERS WITHOUT CLAIM TO ANY PARTICULAR FONT, STYLE, SIZE, OR COLOR.

FOR COSMETICS; TOILET WATER; SUNTAN PREPARATIONS; SUNSCREEN PREPARATIONS; HAIR CARE PREPARATIONS; HAIR CONDITIONERS; HAIR RINSES; ADHESIVES FOR ATTACHING ARTIFICIAL FINGERNAILS AND/OR EYELASHES; COSMETICS FOR ANIMALS; HAIR RINSES AND HAIR CONDITIONERS FOR ANIMALS; ANTI-STATIC PREPARATIONS FOR HOUSEHOLD USE AND FOR USE ON THE HAIR; SOAPS FOR PERSONAL USE; SOAPS FOR ANIMALS; SHAMPOOS; SHAMPOOS FOR ANIMALS (U.S. CLS. 1, 4, 6, 50, 51 AND 52).

TIMOTHY FINNEGAN, EXAMINING ATTORNEY

SN 77-465,658. SY KESSLER SALES, INC., DALLAS, TX, FILED 5-5-2008.

SPARKLE PAK

THE MARK CONSISTS OF STANDARD CHARACTERS WITHOUT CLAIM TO ANY PARTICULAR FONT, STYLE, SIZE, OR COLOR.

OWNER OF U.S. REG. NO. 3,245,003.

NO CLAIM IS MADE TO THE EXCLUSIVE RIGHT TO USE "PAK", APART FROM THE MARK AS SHOWN.

FOR CLEANING PREPARATIONS FOR MIXING WITH WATER IN PRE-MEASURED AMOUNTS TO PROVIDE AN ULTRASOUND CONDUCTIVE BATH FOR USE IN ULTRASONIC CLEANING MACHINES (U.S. CLS. 1, 4, 6, 50, 51 AND 52).

SALLY SHIH, EXAMINING ATTORNEY

SN 77-466,527. L'OREAL, PARIS, FRANCE, FILED 5-6-2008.

GROW STRONG

THE MARK CONSISTS OF STANDARD CHARACTERS WITHOUT CLAIM TO ANY PARTICULAR FONT, STYLE, SIZE, OR COLOR.

OWNER OF U.S. REG. NO. 1,739,338.

FOR NAIL STRENGTHENERS (U.S. CLS. 1, 4, 6, 50, 51 AND 52).

TINA L. SNAPP, EXAMINING ATTORNEY

CLASS 3—(Continued).

SN 77-470,492. ABERCROMBIE & FITCH TRADING CO., NEW ALBANY, OH. FILED 5-9-2008.

HOLLISTER

THE MARK CONSISTS OF STANDARD CHARACTERS WITHOUT CLAIM TO ANY PARTICULAR FONT, STYLE, SIZE, OR COLOR.

OWNER OF U.S. REG. NOS. 2,774,426, 3,358,499 AND OTHERS.

FOR BREATH FRESHENING CONFECTIONARY, NAMELY, BREATH MINTS (U.S. CLS. 1, 4, 6, 50, 51 AND 52).

FIRST USE 9-30-2007; IN COMMERCE 9-30-2007.
ANNE E. GUSTASON, EXAMINING ATTORNEY

SN 77-471,557. PRISTINE RECOVERY, INC., RALEIGH, NC. FILED 5-12-2008.



THE COLOR(S) PINK, WHITE AND GRAY IS/ARE CLAIMED AS A FEATURE OF THE MARK.

THE MARK CONSISTS OF THE WORDS "PRISTINE RECOVERY" WITH THE DESIGN, NAMELY, AN OLD FASHIONED SILHOUETTE OF A SIDE PROFILE OF A WOMAN'S HEAD, HAIR, SHOULDER AND ARM IN BETWEEN THE WORDS. THE WOMAN IS WEARING A PINK RIBBON WITH A WHITE DIAMOND IN HER HAIR. THE SILHOUETTE AND WORDING APPEAR IN THE COLOR GRAY.

FOR BODY AND BEAUTY CARE COSMETICS AND SHAMPOO (U.S. CLS. 1, 4, 6, 50, 51 AND 52).

FIRST USE 2-20-2007; IN COMMERCE 2-1-2008.
GIANCARLO CASTRO, EXAMINING ATTORNEY

SN 77-473,645. EC RESEARCH CORP., CHADDS FORD, PA. FILED 5-13-2008.

LIPOTRISOME

THE MARK CONSISTS OF STANDARD CHARACTERS WITHOUT CLAIM TO ANY PARTICULAR FONT, STYLE, SIZE, OR COLOR.

FOR COSMETIC INGREDIENTS COMPRISED PRIMARILY OF BOTONICAL EXTRACTS IN A STABILIZED LIPOSOME SOLD AS A COMPONENT OF NON-MEDICATED SKIN CARE PREPARATIONS (U.S. CLS. 1, 4, 6, 50, 51 AND 52).

MARTHA FROMM, EXAMINING ATTORNEY

CLASS 3—(Continued).

SN 77-493,239. LUXI, INC., CHICAGO, IL. FILED 6-6-2008.

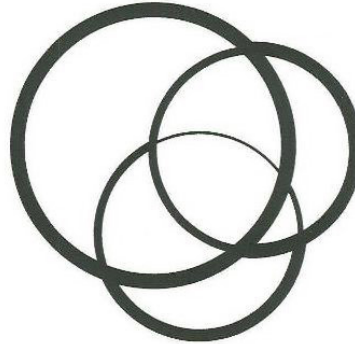

THE MARK CONSISTS OF THREE OVERLAPPING CIRCLES.

FOR BABY OIL, BABY POWDER, BABY SHAMPOO, BODY CREAM, BODY OIL, BODY POWDER, BUBBLE BATH; SKIN, BODY AND FACE CLEANSING LOTIONS; ALL PURPOSE CLEANING PREPARATIONS, DISPOSABLE WIPES IMPREGNATED WITH CHEMICALS OR COMPOUNDS FOR PERSONAL HYGIENE AND FOR HOUSEHOLD USE, SHAMPOO, SHAVE GEL, SHAVE CREAM, SKIN CLEANSING LOTION, SKIN CLEANSING CREAM, SOAP, SKIN TONERS, SKIN LOTION, SKIN MOISTURIZER, SKIN CLARIFIERS, LIQUID SOAP (U.S. CLS. 1, 4, 6, 50, 51 AND 52).

KAELIE KUNG, EXAMINING ATTORNEY

SN 77-529,822. CR TRADING COMPANY, INC., LOS ANGELES, CA. FILED 7-23-2008.

still blu'

THE MARK CONSISTS OF STANDARD CHARACTERS WITHOUT CLAIM TO ANY PARTICULAR FONT, STYLE, SIZE, OR COLOR.

NO CLAIM IS MADE TO THE EXCLUSIVE RIGHT TO USE "BLUE", APART FROM THE MARK AS SHOWN.

FOR COLOGNE; COLOGNE WATER; COLOGNES, PERFUMES AND COSMETICS; COSMETICS IN GENERAL, INCLUDING PERFUMES; DISINFECTING PERFUMED SOAPS; EAU DE COLOGNE; EAU DE COLOGNES; EAU DE PERFUME; EAU DE TOILETTE AND EAU DE COLOGNE; EAU-DE-COLOGNE; EAUX DE COLOGNE; ESSENTIAL OILS AS PERFUME FOR LAUNDRY PURPOSES; LIQUID PERFUMES; OILS FOR PERFUMES AND SCENTS; PERFUME; PERFUME OILS; PERFUME OILS FOR THE MANUFACTURE OF COSMETIC PREPARATIONS; PERFUMED CREAMS; PERFUMED EXTRACTS FOR TISSUES AND PERFUMES; PERFUMED PASTE; PERFUMED POWDER; PERFUMED POWDERS; PERFUMED SOAPS; PERFUMED TALCUM POWDER; PERFUMES; PERFUMES AND COLOGNES; PERFUMES AND TOILET WATERS; PERFUMES, AFTERSHAVES AND COLOGNES; PERFUMES, EAU DE COLOGNES AND AFTERSHAVES; PERFUMES, EAUX DE COLOGNE AND AFTERSHAVES; PERFUMING SACHETS (U.S. CLS. 1, 4, 6, 50, 51 AND 52).

TASNEEM HUSSAIN, EXAMINING ATTORNEY

CLASS 3—(Continued).

SN 77-534,567. TUPPERWARE PRODUCTS S.A., FRIBOURG, SWITZERLAND, FILED 7-30-2008.

CLASS 3—(Continued).

SN 77-537,051. AZZURO HOLDINGS LTD., RICHMOND, CANADA, FILED 8-1-2008.

SPECIAL SYSTEM

THE MARK CONSISTS OF STANDARD CHARACTERS WITHOUT CLAIM TO ANY PARTICULAR FONT, STYLE, SIZE, OR COLOR.

NO CLAIM IS MADE TO THE EXCLUSIVE RIGHT TO USE "SYSTEM", APART FROM THE MARK AS SHOWN.

FOR HAIR CARE PREPARATIONS (U.S. CLS. 1, 4, 6, 50, 51 AND 52).

GIANCARLO CASTRO, EXAMINING ATTORNEY

THE MARK CONSISTS OF STANDARD CHARACTERS WITHOUT CLAIM TO ANY PARTICULAR FONT, STYLE, SIZE, OR COLOR.

PRIORITY CLAIMED UNDER SEC. 44(D) ON CANADA APPLICATION NO. 1406938, FILED 7-31-2008.

FOR SKIN, BODY, FACE, HAIR AND FOOT CARE PREPARATIONS AND COSMETIC PREPARATIONS, NAMELY, SKIN CLARIFIERS, SKIN CLEANSERS, SKIN CLEANSING CREAM, SKIN CLEANSING LOTION, SKIN CONDITIONERS, SKIN CREAM, SKIN MOISTURIZER MASKS, SKIN SOAP, SKIN TONERS, SKIN CARE SERUMS AND TREATMENT OILS, CONTOURING CREAMS AND GELS, FACE CREAMS, FACE MASKS, FACE TREATMENT CREAMS, FACIAL CLEANSERS, FACIAL CREAMS, FACIAL EMULSIONS, FACIAL MASKS, FACIAL SCRUBS, FACIAL PEELS, FACIAL MAKEUP, EYE CREAM, EYE GELS, EYE MAKEUP, EYE MAKEUP REMOVER, HAND CREAM AND LOTION, BODY LOTION, BODY WASH, BODY EXFOLIANTS, BODY WRAPS, BATH SALTS, BATH OILS, SHAMPOO AND CONDITIONER FOR THE HAIR, FOOT CREAMS AND GELS, FOOT SOAK, NAIL CARE PREPARATIONS, NAIL CONDITIONERS, CUTICLE CONDITIONERS, CUTICLE OILS, NAIL POLISH, NAIL POLISH REMOVER, AND TRAVEL KITS CONTAINING TWO OR MORE OF THE FOREGOING PRODUCTS (U.S. CLS. 1, 4, 6, 50, 51 AND 52).

BRIAN NEVILLE, EXAMINING ATTORNEY

SN 77-534,699. CARTER, KERRY L. DBA KERRY'S CANDLES, ERIE, CO. FILED S.R. 7-30-2008; AM. P.R. 12-3-2008.

SN 77-540,181. HAUTE HOME, LLC, SAN FRANCISCO, CA. FILED 8-6-2008.

Bee Happy

THE MARK CONSISTS OF STANDARD CHARACTERS WITHOUT CLAIM TO ANY PARTICULAR FONT, STYLE, SIZE, OR COLOR.

NO CLAIM IS MADE TO THE EXCLUSIVE RIGHT TO USE "BEE", APART FROM THE MARK AS SHOWN.

FOR COSMETICS IN GENERAL, INCLUDING PERFUMES (U.S. CLS. 1, 4, 6, 50, 51 AND 52).

FIRST USE 8-1-2007; IN COMMERCE 8-1-2007.

PRISCILLA MILTON, EXAMINING ATTORNEY

HAUTE HOME

THE MARK CONSISTS OF STANDARD CHARACTERS WITHOUT CLAIM TO ANY PARTICULAR FONT, STYLE, SIZE, OR COLOR.

NO CLAIM IS MADE TO THE EXCLUSIVE RIGHT TO USE "HOME", APART FROM THE MARK AS SHOWN.

FOR SACHETS (U.S. CLS. 1, 4, 6, 50, 51 AND 52).

FIRST USE 5-1-2000; IN COMMERCE 5-1-2000.

JOHN DALIER, EXAMINING ATTORNEY

CLASS 3—(Continued).

SN 77-546,382. ELYSÉE SCIENTIFIC COSMETICS, INC., VERONA, WI. FILED 8-13-2008.

ESC SKINCARE INSTITUTE

THE MARK CONSISTS OF STANDARD CHARACTERS WITHOUT CLAIM TO ANY PARTICULAR FONT, STYLE, SIZE, OR COLOR.

NO CLAIM IS MADE TO THE EXCLUSIVE RIGHT TO USE "SKINCARE INSTITUTE", APART FROM THE MARK AS SHOWN.

FOR NON-MEDICATED SKIN CARE PREPARATIONS, NAMELY, SERUMS, LOTIONS, CREAMS, GELS, CLEANSERS, TONERS, EXFOLIANTS, SCRUBS, MASKS AND SPRAYS ALL FOR THE FACE AND BODY; SKIN MOISTURIZERS; NON-MEDICATED, ANTI-AGING CREAMS, LOTIONS AND SERUMS; NON-MEDICATED CREAMS AND LOTIONS FOR TREATMENT AND REDUCTION OF THE APPEARANCE OF CELLULITE; NON-MEDICATED ACNE TREATMENT PREPARATIONS; NON-MEDICATED TOPICAL PREPARATIONS FOR THE TREATMENT OF ROSACEA AND HYPERPIGMENTED SKIN; NON-MEDICATED SUNCARE PREPARATIONS, NAMELY, SUNSCREENS AND SUN BLOCKS; COLOR COSMETICS, NAMELY, FOUNDATION, FACIAL CONCEALER, BLUSH, PRESSED FACE POWDER, LIPTSTICK, LIP GLOSS, LIP BALM, LIP LINER, MASCARA, EYE LINER, EYE SHADOW, EYEBROW PENCIL, MAKEUP REMOVER; HAIR CARE PREPARATIONS, NAMELY, SHAMPOO AND CONDITIONER; FRAGRANCE, PERFUME, COLOGNE, AFTERSHAVE; NAIL CARE PREPARATIONS, NAMELY, NAIL POLISH AND NAIL POLISH REMOVER (U.S. CLS. 1, 4, 6, 50, 51 AND 52).

BARBARA GAYNOR, EXAMINING ATTORNEY

SN 77-554,406. ENVIRONMENTAL ESSENTIALS, LANCASTER, OH. FILED 8-24-2008.

Jungle Juice

THE MARK CONSISTS OF STANDARD CHARACTERS WITHOUT CLAIM TO ANY PARTICULAR FONT, STYLE, SIZE, OR COLOR.

FOR ALL-PURPOSE CLEANERS (U.S. CLS. 1, 4, 6, 50, 51 AND 52).

FIRST USE 12-1-2007; IN COMMERCE 12-1-2007.
WENDY GOODMAN, EXAMINING ATTORNEY

CLASS 3—(Continued).

SN 77-554,523. LANCOME PARFUMS ET BEAUTE & CIE, PARIS, FRANCE, FILED 8-25-2008.

JUICY
TUBES
PURE

THE MARK CONSISTS OF STANDARD CHARACTERS WITHOUT CLAIM TO ANY PARTICULAR FONT, STYLE, SIZE, OR COLOR.

OWNER OF U.S. REG. NOS. 2,442,440, 3,433,836 AND 3,483,489.

FOR COSMETICS, NAMELY, LIP GLOSS (U.S. CLS. 1, 4, 6, 50, 51 AND 52).

NICHOLAS COLEMAN, EXAMINING ATTORNEY

SN 77-556,916. INNOVATIVE SALON CONCEPTS, INC., BETHEL PARK, PA. FILED 8-27-2008.

BEAUTYTRIP

THE MARK CONSISTS OF STANDARD CHARACTERS WITHOUT CLAIM TO ANY PARTICULAR FONT, STYLE, SIZE, OR COLOR.

FOR HAIR-CARE PRODUCTS, NAMELY, SHAMPOOS AND CONDITIONERS; FINISHING AND STYLING PRODUCTS FOR HUMANS AND/OR ANIMALS, NAMELY, HAIRSTYLING GEL, HAIRSTYLING SPRAY, HAIRSTYLING PREPARATION, HAIRSPRAY, HAIR GLAZE, HAIR MOUSSE, HAIR OIL, HAIR WAX, HAIR RELAXER, HAIR-WAVING PREPARATION, AND HEAT-PROTECTANT SPRAY; SKIN-CARE PRODUCTS, NAMELY, BODY AND FACIAL LOTIONS AND MOISTURIZERS, BODY AND FACIAL CLEANSERS, SHAVING CREAMS, BODY AND FACIAL WASHES, AND SOAPS (U.S. CLS. 1, 4, 6, 50, 51 AND 52).

ALICE SUE CARRUTHERS, EXAMINING ATTORNEY

CLASS 3—(Continued).

SN 77-557,036. INNOVATIVE SALON CONCEPTS, INC.,
BETHEL PARK, PA. FILED 8-27-2008.

BEAUTYTRIP.GREEN

THE MARK CONSISTS OF STANDARD CHARACTERS WITHOUT CLAIM TO ANY PARTICULAR FONT, STYLE, SIZE, OR COLOR.

FOR HAIR-CARE PRODUCTS, NAMELY, SHAMPOOS AND CONDITIONERS; FINISHING AND STYLING PRODUCTS FOR HUMANS AND/OR ANIMALS, NAMELY, HAIRSTYLING GEL, HAIRSTYLING SPRAY, HAIRSTYLING PREPARATION, HAIRSPRAY, HAIR GLAZE, HAIR MOUSSE, HAIR OIL, HAIR WAX, HAIR RELAXER, HAIR-WAVING PREPARATION, AND HEAT-PROTECTANT SPRAY; SKIN-CARE PRODUCTS, NAMELY, BODY AND FACIAL LOTIONS AND MOISTURIZERS, BODY AND FACIAL CLEANSERS, SHAVING CREAMS, BODY AND FACIAL WASHES, AND SOAPS (U.S. CLS. 1, 4, 6, 50, 51 AND 52).

ALICE SUE CARRUTHERS, EXAMINING ATTORNEY

SN 77-557,315. WEST BRAND CORPORATION, BONSALE,
CA. FILED 8-27-2008.

VIA BOTANICA

THE MARK CONSISTS OF STANDARD CHARACTERS WITHOUT CLAIM TO ANY PARTICULAR FONT, STYLE, SIZE, OR COLOR.

OWNER OF U.S. REG. NO. 3,014,435.
THE ENGLISH TRANSLATION OF THE WORD "BOTANICA" IN THE MARK IS BOTANY.

FOR BODY CARE CLEANSING PRODUCTS, NAMELY, SOAPS, SKIN CARE SCRUBS, SKIN CARE CREAMS CONTAINING EXFOLIATES; SKIN CARE LOTIONS; NON-MEDICATED LIP CARE PRODUCTS, NAMELY, LIP BALM; SKIN CARE MOISTURIZING CREAMS; BODY WASH PRODUCTS, NAMELY, LIQUID, SOAPS, BAR SOAPS AND CLEANSERS; BODY BUTTER CREAM FOR COSMETIC PURPOSES; AND SKIN CARE OILS (U.S. CLS. 1, 4, 6, 50, 51 AND 52).

FIRST USE 4-1-2003; IN COMMERCE 4-1-2003.

TAMARA FRAZIER, EXAMINING ATTORNEY

SN 77-557,745. NIMENS, JON, CROOKSTON, MN. FILED 8-28-2008.

iDrain

THE MARK CONSISTS OF STANDARD CHARACTERS WITHOUT CLAIM TO ANY PARTICULAR FONT, STYLE, SIZE, OR COLOR.

FOR DRAIN OPENERS (U.S. CLS. 1, 4, 6, 50, 51 AND 52).

DAYNA BROWNE, EXAMINING ATTORNEY

CLASS 3—(Continued).

SN 77-560,982. KEL-SAN, INC., KNOXVILLE, TN. FILED 9-3-2008.



OWNER OF U.S. REG. NO. 2,197,029.

NO CLAIM IS MADE TO THE EXCLUSIVE RIGHT TO USE "CLEAN", APART FROM THE MARK AS SHOWN.

THE MARK CONSISTS OF THE LETTERS "KS" IN A BOX TO THE LEFT OF "KELSAN", WITH "THINK CLEAN" ABOVE THE LETTERS "SAN".

FOR GLASS CLEANER AND ALL-PURPOSE CLEANER FOR INSTITUTIONAL AND INDUSTRIAL USE (U.S. CLS. 1, 4, 6, 50, 51 AND 52).

FIRST USE 3-1-1999; IN COMMERCE 3-1-1999.

EMILY CHUO, EXAMINING ATTORNEY

SN 77-561,210. ROTTER, HELGA, MONTVILLE, NJ. FILED 9-3-2008.

LISEA FRAGRANCES

THE MARK CONSISTS OF STANDARD CHARACTERS WITHOUT CLAIM TO ANY PARTICULAR FONT, STYLE, SIZE, OR COLOR.

NO CLAIM IS MADE TO THE EXCLUSIVE RIGHT TO USE "FRAGRANCES", APART FROM THE MARK AS SHOWN.

FOR PERFUMES; SCENTED ROOM SPRAYS (U.S. CLS. 1, 4, 6, 50, 51 AND 52).

THEODORE MCBRIDE, EXAMINING ATTORNEY

SN 77-561,557. MCK LABORATORIES, LLC, SALT LAKE CITY, UT. FILED 9-3-2008.



THE MARK CONSISTS OF THE WORD "COSMION" IN DARK LETTERS OUTLINED IN A LIGHT BACKGROUND THAT DISSOLVES INTO DARKNESS.

FOR NON-MEDICATED SKIN CARE PREPARATIONS, NAMELY, CLEANSERS, SERUMS, AND SOLUTIONS USED IN CONJUNCTION WITH SKIN COVERINGS THAT EMIT ELECTRICAL CURRENT TO PROMOTE IMPROVED ABSORPTION (U.S. CLS. 1, 4, 6, 50, 51 AND 52).

SAMUEL E. SHARPER JR., EXAMINING ATTORNEY

CLASS 3—(Continued).

SN 77-561,581. DUWOP LLC, VAN NUYS, CA. FILED 9-3-2008.

FOUNDATION OF YOUTH

THE MARK CONSISTS OF STANDARD CHARACTERS WITHOUT CLAIM TO ANY PARTICULAR FONT, STYLE, SIZE, OR COLOR.
FOR COSMETICS (U.S. CLS. 1, 4, 6, 50, 51 AND 52).
DAVON HATCHETT, EXAMINING ATTORNEY

SN 77-562,224. PLATINUM WHITES INC., SALT LAKE CITY, UT. FILED 9-4-2008.

SUCCESS

THE MARK CONSISTS OF STANDARD CHARACTERS WITHOUT CLAIM TO ANY PARTICULAR FONT, STYLE, SIZE, OR COLOR.
FOR TEETH WHITENING KIT; TOOTH WHITENING GELS; TOOTH WHITENING PREPARATIONS (U.S. CLS. 1, 4, 6, 50, 51 AND 52).
KIM SAITO, EXAMINING ATTORNEY

SN 77-562,337. WOLF, SUSAN, JANESVILLE, WI. FILED 9-4-2008.



NO CLAIM IS MADE TO THE EXCLUSIVE RIGHT TO USE "INTERNATIONAL", APART FROM THE MARK AS SHOWN.

THE MARK CONSISTS OF THE TEXT "LHI" WRITTEN IN LARGE LETTERS ABOVE THE WORDS LITTLE HONEYZZZ INTERNATIONAL, WHICH ARE ABOVE TWO HORIZONTAL LINES, ALL SHOWN AGAINST A DARK SQUARE.

FOR NON-MEDICATED SKIN CARE PREPARATIONS ; FACE AND BODY LOTIONS ; SKIN CARE PREPARATIONS, NAMELY, BODY BALM, LIP BALM ; BEAUTY CREAMS FOR BODY CARE, TOOTHPASTES, MOUTH WASHES, HAIR SHAMPOOS, HAIR CONDITIONERS (U.S. CLS. 1, 4, 6, 50, 51 AND 52).
ESTHER BELENKER, EXAMINING ATTORNEY

CLASS 3—(Continued).

SN 77-562,490. H. BEST, LTD., NEW YORK, NY. FILED 9-4-2008.

2(X)IST

THE MARK CONSISTS OF STANDARD CHARACTERS WITHOUT CLAIM TO ANY PARTICULAR FONT, STYLE, SIZE, OR COLOR.
OWNER OF U.S. REG. NOS. 1,656,321, 2,406,472 AND OTHERS.

FOR PERFUMERY, NAMELY, EAU DE PERFUME, EAU DE TOILETTE, PERFUME, COLOGNE; COSMETICS, NAMELY, FOUNDATION MAKE-UP, FACE POWDER, COVER-UP CREAM AND CONCEALER, LIPSTICK, LIP GLOSS, LIP CONDITIONER, EYE LINER, EYESHADOW, MASCARA, EYEBROW PENCIL, EYEBROW FIXER, COSMETIC PENCILS, CHEEK BLUSH, NAIL ENAMEL, SKIN BRONZERS, BODY SUNSCREEN AND FACIAL SUNSCREEN; NON-MEDICATED TOILETRIES, NAMELY, AFTER-SHAVE LOTIONS, SHAVING CREAM, SKIN SOAP, FACIAL CLEANSERS, FACIAL MOISTURIZERS, EYE CREAM, EYE GEL, EYE MAKE-UP REMOVER, FACIAL MAKEUP REMOVER, NON-MEDICATED SKIN BLEMISH PREPARATIONS, FACIAL TONER, FACIAL SOAPS, HAND CREAM, BODY CREAM, BODY LOTION, BODY OIL, BODY GEL, BODY POWDER, NON-MEDICATED SKIN CARE PREPARATIONS, NON-MEDICATED ANTI-WRINKLE CREAM, NON-MEDICATED SKIN RENEWAL CREAM, FACIAL EXFOLIATING PREPARATIONS, FACIAL MASKS, SELF-TANNING PREPARATIONS, PERSONAL SOAPS, HAIR SHAMPOO, HAIR CONDITIONER, HAIR SPRAY, HAIR MOUSSE, HAIR GEL, HAIR HUMECTANT, ANTI-PERSPIRANT/DEODORANT AND ESSENTIAL OILS FOR PERSONAL USE (U.S. CLS. 1, 4, 6, 50, 51 AND 52).
BRIAN PINO, EXAMINING ATTORNEY

SN 77-562,631. LAURICE EL BADRY RAHME LTD., DBA LAURICE & CO., NEW YORK, NY. FILED 9-4-2008.

LITTLE INDIA

THE MARK CONSISTS OF STANDARD CHARACTERS WITHOUT CLAIM TO ANY PARTICULAR FONT, STYLE, SIZE, OR COLOR.

FOR FRAGRANCES FOR PERSONAL USE, NAMELY, PERFUMES, COLOGNES, AFTER BATH SPLASHES, BODY SPRAYS, SHOWER GELS, SOAPS, BODY LOTIONS, MASSAGE OILS, COSMETICS, NAMELY, NON-MEDICATED SKIN CARE PREPARATIONS, MAKEUP, LIPSTICK, FOUNDATION POWDER, EYESHADOW, NAIL POLISH, MASCARA AND EYE PENCIL (U.S. CLS. 1, 4, 6, 50, 51 AND 52).
LINDSEY RUBIN, EXAMINING ATTORNEY

CLASS 3—(Continued).

SN 77-562,762. DECKER, KEITH T., GRAND JUNCTION, CO.
FILED 9-4-2008.

Pitbull Lipstick

THE MARK CONSISTS OF STANDARD CHARACTERS WITHOUT CLAIM TO ANY PARTICULAR FONT, STYLE, SIZE, OR COLOR.

NO CLAIM IS MADE TO THE EXCLUSIVE RIGHT TO USE "LIPSTICK", APART FROM THE MARK AS SHOWN.

FOR LIPSTICK; LIPSTICK CASES; LIPSTICK HOLDERS; LIPSTICKS; MAKE-UP KITS COMPRISED OF LIPSTICK, LIP GLOSS, LIP SALVE, LIP CREAM, LIP SUNSCREEN, LIP LINER OR LIP EMOLLIENTS (U.S. CLS. 1, 4, 6, 50, 51 AND 52).

INGA ERVIN, EXAMINING ATTORNEY

SN 77-563,608. LOTTA LUV, LLC, NEW YORK, NY. FILED 9-5-2008.

CREATE-A-BALM

THE MARK CONSISTS OF STANDARD CHARACTERS WITHOUT CLAIM TO ANY PARTICULAR FONT, STYLE, SIZE, OR COLOR.

FOR LIP BALM (U.S. CLS. 1, 4, 6, 50, 51 AND 52).

FIRST USE 12-0-2007; IN COMMERCE 12-0-2007.

DAVID COLLIER, EXAMINING ATTORNEY

SN 77-563,609. LFL INVESTMENTS, LLC, WINDERMERE, FL. FILED 9-5-2008.

HOLLYWOOD SMILES

THE MARK CONSISTS OF STANDARD CHARACTERS WITHOUT CLAIM TO ANY PARTICULAR FONT, STYLE, SIZE, OR COLOR.

FOR TEETH WHITENING KIT; TOOTH WHITENING GELS (U.S. CLS. 1, 4, 6, 50, 51 AND 52).

FIRST USE 6-23-2004; IN COMMERCE 6-23-2004.

GISELLE AGOSTO, EXAMINING ATTORNEY

CLASS 3—(Continued).

SN 77-563,655. THOMAS REDMOND, EDEN PRAIRIE, MN.
FILED 9-5-2008.

AMAZING MIRACLE

THE MARK CONSISTS OF STANDARD CHARACTERS WITHOUT CLAIM TO ANY PARTICULAR FONT, STYLE, SIZE, OR COLOR.

FOR HAIR CARE PRODUCTS, NAMELY, SHAMPOO, CONDITIONER, RINSES, FIXATIVES, STYLING PREPARATIONS (U.S. CLS. 1, 4, 6, 50, 51 AND 52).

DAVID MILLER, EXAMINING ATTORNEY

SN 77-563,926. STEVENSON INDUSTRIES, INC., SIMI VALLEY, CA. FILED 9-6-2008.

ACTIPRO

THE MARK CONSISTS OF STANDARD CHARACTERS WITHOUT CLAIM TO ANY PARTICULAR FONT, STYLE, SIZE, OR COLOR.

FOR DENTURE CLEANERS (U.S. CLS. 1, 4, 6, 50, 51 AND 52).

NICHOLAS ALTREE, EXAMINING ATTORNEY

SN 77-564,634. MATIAS, JONATHAN R., HOLLIS, NY. FILED 9-8-2008.

Clayn

THE MARK CONSISTS OF STANDARD CHARACTERS WITHOUT CLAIM TO ANY PARTICULAR FONT, STYLE, SIZE, OR COLOR.

FOR COSMETICS AND COSMETIC PREPARATIONS (U.S. CLS. 1, 4, 6, 50, 51 AND 52).

FIRST USE 8-26-2008; IN COMMERCE 8-31-2008.

BRENDAN MCCAULEY, EXAMINING ATTORNEY

CLASS 3—(Continued).

SN 77-564,686. WEST MARINE IHC I, INC., WATSONVILLE, CA. FILED 9-8-2008.

PURE OCEANS

THE MARK CONSISTS OF STANDARD CHARACTERS WITHOUT CLAIM TO ANY PARTICULAR FONT, STYLE, SIZE, OR COLOR.

FOR CLEANER FOR USE ON BOATS; LIQUID SOAPS; POLISHING WAX; STAIN REMOVERS (U.S. CLS. 1, 4, 6, 50, 51 AND 52).

FIRST USE 2-15-2008; IN COMMERCE 3-31-2008.
KEVIN DINALLO, EXAMINING ATTORNEY

CLASS 3—(Continued).

SN 77-565,222. WALLACE, PAUL W., M.D., DBA WALLACE OF BEVERLY HILLS, BEVERLY HILLS, CA. FILED 9-9-2008.



SN 77-564,734. ROBERT T. MARKS, WALNUT CREEK, CA. FILED 9-8-2008.

PERIOCARE

THE MARK CONSISTS OF STANDARD CHARACTERS WITHOUT CLAIM TO ANY PARTICULAR FONT, STYLE, SIZE, OR COLOR.

FOR TOOTHPASTE (U.S. CLS. 1, 4, 6, 50, 51 AND 52).
TRACY FLETCHER, EXAMINING ATTORNEY

THE MARK CONSISTS OF A STYLIZED "WP".
FOR ANTIBACTERIAL SKIN SOAPS; AROMATHERAPY BODY CARE PRODUCTS, NAMELY, BODY LOTION, SHOWER GEL, CUTICLE CREAM, SHAMPOO, CONDITIONER, NON-MEDICATED LIP BALM, SOAP, BODY POLISH, BODY AND FOOT SCRUB AND NON-MEDICATED FOOT CREAM; BEAUTY CREAMS FOR BODY CARE; BODY AND BEAUTY CARE COSMETICS; CONCEALERS FOR SKIN AND BODY; CONDITIONERS; COSMETIC CREAMS FOR SKIN CARE; COSMETIC PREPARATIONS FOR BODY CARE; COSMETIC PREPARATIONS FOR SKIN RENEWAL; COSMETIC PRODUCTS IN THE FORM OF AEROSOLS FOR SKIN CARE; COSMETIC PRODUCTS IN THE FORM OF AEROSOLS FOR SKINCARE; DEODORANTS FOR BODY CARE; EXFOLIANTS FOR SKIN; HAIR CARE CREAMS; HAIR CARE KITS COMPRISING NON-MEDICATED HAIR CARE PREPARATIONS, NAMELY, CONDITIONERS, MOISTURIZERS, SHAMPOOS AND OILS; HAIR CARE LOTIONS; HAIR CARE PREPARATIONS; HAIR CARE PREPARATIONS CONSISTING OF ORGANIC COCONUT VIRGIN OIL AND COCONUT VIRGIN OIL; LOTIONS FOR FACE AND BODY CARE; LOTIONS FOR FACE AND BODY; MOUSSE FOR HAIR; NAIL CARE PREPARATIONS; NAIL CARE PREPARATIONS, NAMELY, NAIL SOFTENERS; NON-MEDICATED COSMETIC SKIN CARE PREPARATIONS CONSISTING OF ORGANIC COCONUT VIRGIN OIL AND COCONUT VIRGIN OIL; NON-MEDICATED LIP CARE PREPARATIONS; NON-MEDICATED PREPARATIONS ALL FOR THE CARE OF SKIN, HAIR AND SCALP; NON-MEDICATED SKIN CARE PREPARATION, NAMELY, BODY MIST; NON-MEDICATED SKIN CARE PREPARATIONS; NON-MEDICATED SKIN CARE PREPARATIONS, NAMELY, CREAMS, LOTIONS, GELS, TONERS, CLEANSERS AND PEELS; NON-MEDICATED SKIN CREAMS; NON-MEDICATED STIMULATING LOTIONS FOR THE SKIN; NON-MEDICATED SUN CARE PREPARATIONS; SKIN ABRASIVE PREPARATIONS; SKIN AND BODY TOPICAL LOTIONS, CREAMS AND OILS FOR COS-

SN 77-564,816. NUTRITION RESOURCE, INC., DBA NUTRIBIOTIC, LAKEPORT, CA. FILED 9-8-2008.

NUTRIBIOTIC

THE MARK CONSISTS OF STANDARD CHARACTERS WITHOUT CLAIM TO ANY PARTICULAR FONT, STYLE, SIZE, OR COLOR.

FOR PERSONAL/BODY CARE PRODUCTS, NAMELY, SHAMPOO, CONDITIONER, SKIN CARE CLEANSERS AND MOISTURIZERS, BATH GELS AND CLEANSERS, DEODORANT, TOOTHPASTE AND MOUTHWASH (U.S. CLS. 1, 4, 6, 50, 51 AND 52).

FIRST USE 7-26-1994; IN COMMERCE 7-26-1994.
AMY C. KEAN, EXAMINING ATTORNEY

CLASS 3—(Continued).

METIC USE; SKIN CARE PREPARATION, NAMELY, BODY POLISH; SKIN CARE PREPARATIONS, NAMELY, CHEMICAL PEELS FOR SKIN; SKIN CARE PREPARATIONS, NAMELY, FRUIT ACID PEELS FOR SKIN; SKIN CARE PREPARATIONS, NAMELY, BODY BALM; SKIN CARE PRODUCTS, NAMELY, NON-MEDICATED SKIN SERUM; SKIN CLARIFIERS; SKIN CLEANSERS; SKIN CLEANSING CREAM; SKIN CLEANSING LOTION; SKIN CONDITIONERS; SKIN CREAM; SKIN CREAMS; SKIN CREAMS IN LIQUID AND IN SOLID FORM; SKIN CREAMS IN LIQUID AND SOLID; SKIN CREAMS IN LIQUID AND SOLID FORM; SKIN EMOLLIENTS; SKIN FRESHENERS; SKIN LIGHTENERS; SKIN LIGHTENING CREAMS; SKIN LOTION; SKIN LOTIONS; SKIN MASKS; SKIN MOISTURIZER; SKIN MOISTURIZER MASKS; SKIN SOAP; SKIN TEXTURIZERS; SKIN TONERS; SKIN WHITENING CREAMS; SKIN WHITENING PREPARATIONS; SOAPS FOR BODY CARE; SUN CARE LOTIONS; TOPICAL SKIN SPRAYS FOR COSMETIC PURPOSES; WRINKLE REMOVING SKIN CARE PREPARATIONS (U.S. CLS. 1, 4, 6, 50, 51 AND 52).

FIRST USE 3-11-1974; IN COMMERCE 3-11-1974.
BARBARA BROWN, EXAMINING ATTORNEY

SN 77-565,312. AUSTRALIAN GOLD, INC., INDIANAPOLIS, IN. FILED 9-9-2008.

REVVED

THE MARK CONSISTS OF STANDARD CHARACTERS WITHOUT CLAIM TO ANY PARTICULAR FONT, STYLE, SIZE, OR COLOR.

FOR NON-MEDICATED SKIN TANNING PREPARATIONS (U.S. CLS. 1, 4, 6, 50, 51 AND 52).

FIRST USE 4-10-2007; IN COMMERCE 4-10-2007.
CARRIE GENOVESE, EXAMINING ATTORNEY

SN 77-565,624. MIX IT SMOOTH, LLC, DBA BATHBLOOMERS, NEW YORK, NY. FILED 9-9-2008.

TRANSLATIONS

THE MARK CONSISTS OF STANDARD CHARACTERS WITHOUT CLAIM TO ANY PARTICULAR FONT, STYLE, SIZE, OR COLOR.

FOR PERFUMES, EAU DE TOILETTE AND PERFUMED BODY SPRAY; TOILETRIES, NAMELY, BODY SOAPS, BATH SALTS, BATH OILS, BATH GELS AND FOAMS, HAIR SHAMPOOS AND CONDITIONERS, SHAVING CREAMS AND GELS, STYLING GELS, AND HAIR SPRAY; AND SKIN CARE PRODUCTS, NAMELY, FACIAL, BODY AND HAND CREAMS, LOTIONS, AND MOISTURIZERS, WITH AND WITHOUT SUNSCREEN, FACIAL MASKS, AND FACIAL TONERS (U.S. CLS. 1, 4, 6, 50, 51 AND 52).

LINDA LAVACHE, EXAMINING ATTORNEY

CLASS 3—(Continued).

SN 77-566,059. TSAI, MIN WEN, DIAMOND BAR, CA. FILED 9-9-2008.

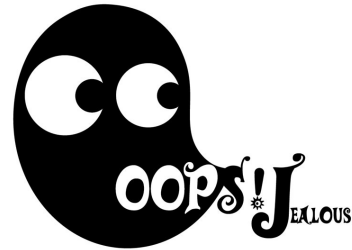

THE MARK CONSISTS OF A DESIGN ELEMENT THAT INCLUDES A BALLOON SHAPE WHOSE TIP IS ON THE BOTTOM SIDE AND POINTS TO THE RIGHT, TWO CRESCENT SHAPES, AND THE STYLIZED TERM "OOPS!-JEALOUS". THE TWO CRESCENT SHAPES ARE IN THE UPPER PORTION OF THE BALLOON AND NEXT TO EACH OTHER, THE LEFT ONE SLIGHTLY LARGER THAN THE RIGHT ONE. EACH CRESCENT HAS ITS OPENING FACING RIGHT. IN THE LOWER PORTION OF THE BALLOON AND NEAR THE TIP OF THE BALLOON APPEARS THE STYLIZED WORDING "OOP!". OUTSIDE THE BALLOON AND CONNECTED WITH THE TIP OF THE BALLOON IS THE STYLIZED LETTER "S". A PORTION OF THE EDGE OF THE "S" SHARES AN AREA WITH THE BALLOON TIP SO THAT THE TIP IS NOT POINTY. THE "S" IS FOLLOWED BY THE STYLIZED EXCLAMATION POINT "!" AND THE STYLIZED WORDING "JEALOUS". THE LOWER PART OF THE EXCLAMATION POINT IS A STYLIZED MULTI-POINTED STAR SHAPE WITH A CIRCLE INSIDE. A SMALL DOT APPEARS INSIDE BUT NOT IN THE CENTER OF THE CIRCLE.

FOR NAIL CARE PREPARATIONS, NAIL CREAM, NAIL ENAMEL, NAIL ENAMEL REMOVERS, NAIL GLITTER, NAIL POLISH TOP COAT, NAIL STENCILS, NAIL TIPS, NAIL VARNISH, COSMETICS AND MAKE-UP, NON-MEDICATED SKINCARE PREPARATION, NAIL POLISH, AND NAIL POLISH REMOVERS (U.S. CLS. 1, 4, 6, 50, 51 AND 52).

FIRST USE 10-1-2007; IN COMMERCE 12-1-2007.
JAMES GRIFFIN, EXAMINING ATTORNEY

SN 77-566,241. RICHMAN, DEBORAH K., HUNTINGTON BAY, NY. FILED 9-10-2008.

Cool Blue

THE MARK CONSISTS OF STANDARD CHARACTERS WITHOUT CLAIM TO ANY PARTICULAR FONT, STYLE, SIZE, OR COLOR.

FOR COLOGNES, PERFUMES AND COSMETICS; COSMETICS; EAU DE COLOGNE; EAU DE COLOGNES; EAU DE PARFUM; EAU DE PERFUME; EAU DE TOILETTE; EAU DE TOILETTE AND EAU DE COLOGNE; EAU-DE-COLOGNE; EAU-DE-TOILETTE; FRAGRANCES; FRAGRANCES AND PERFUMERY; FRAGRANCES FOR PERSONAL USE (U.S. CLS. 1, 4, 6, 50, 51 AND 52).

FIRST USE 2-8-2008; IN COMMERCE 2-8-2008.
JAMES STEIN, EXAMINING ATTORNEY

CLASS 3—(Continued).

SN 77-566,265. JOHNSON & JOHNSON, NEW BRUNSWICK, NJ. FILED 9-10-2008.

HYDRARELEASE

THE MARK CONSISTS OF STANDARD CHARACTERS WITHOUT CLAIM TO ANY PARTICULAR FONT, STYLE, SIZE, OR COLOR.

FOR SKINCARE PREPARATIONS, NAMELY, SKIN CREAMS AND LOTIONS (U.S. CLS. 1, 4, 6, 50, 51 AND 52).

FLORENTINA BLANDU, EXAMINING ATTORNEY



SN 77-566,269. JOHNSON & JOHNSON, NEW BRUNSWICK, NJ. FILED 9-10-2008.

POSITIVELY AGELESS

THE MARK CONSISTS OF STANDARD CHARACTERS WITHOUT CLAIM TO ANY PARTICULAR FONT, STYLE, SIZE, OR COLOR.

FOR SKIN CARE PREPARATIONS, NAMELY, SKIN CLEANSERS, SKIN MOISTURIZERS, SKIN CREAMS AND SERUMS, EYE CREAMS (U.S. CLS. 1, 4, 6, 50, 51 AND 52).

FIRST USE 5-4-2007; IN COMMERCE 5-4-2007.

FLORENTINA BLANDU, EXAMINING ATTORNEY



SN 77-566,315. GREENHOUSE ECO-CLEANING LLC, BROOKLYN, NY. FILED 9-10-2008.

GREENHOUSE

THE MARK CONSISTS OF STANDARD CHARACTERS WITHOUT CLAIM TO ANY PARTICULAR FONT, STYLE, SIZE, OR COLOR.

FOR CLEANING AGENTS AND PREPARATIONS (U.S. CLS. 1, 4, 6, 50, 51 AND 52).

AMY C. KEAN, EXAMINING ATTORNEY

CLASS 3—(Continued).

SN 77-566,325. GREENHOUSE ECO-CLEANING LLC, BROOKLYN, NY. FILED 9-10-2008.



THE MARK CONSISTS OF OUTLINE OF A HOUSE WITH A THREE-LEAFED PLANT WITHIN.

FOR CLEANING AGENTS AND PREPARATIONS (U.S. CLS. 1, 4, 6, 50, 51 AND 52).

AMY C. KEAN, EXAMINING ATTORNEY



SN 77-566,774. PRIMUS, JENIECE A., AMSTERDAM, NETHERLANDS, FILED 9-10-2008.

Soft Borders

THE MARK CONSISTS OF STANDARD CHARACTERS WITHOUT CLAIM TO ANY PARTICULAR FONT, STYLE, SIZE, OR COLOR.

FOR AFTERSHAVE LOTIONS; AFTER SUN CREAMS; AFTERSHAVE CREAMS; AFTERSHAVE LOTIONS; AFTER-SUN GELS; AFTER-SUN LOTIONS; AFTER-SUN MILKS; AFTER-SUN OILS; AGE RETARDANT LOTION; AGE SPOT REDUCING CREAMS; ALMOND SOAPS; ALOE VERA GEL FOR COSMETIC PURPOSES; ANTI-AGING CREAM; ANTI-AGING CREAMS; ANTI-FRECKLE CREAMS; ANTI-WRINKLE CREAM; ANTI-WRINKLE CREAMS; ANTIBACTERIAL SKIN SOAPS; ANTIBACTERIAL SOAP; AROMATHERAPY BODY CARE PRODUCTS, NAMELY, BODY LOTION, SHOWER GEL, CUTICLE CREAM, SHAMPOO, CONDITIONER, NON-MEDICATED LIP BALM, SOAP, BODY POLISH, BODY AND FOOT SCRUB AND NON-MEDICATED FOOT CREAM; AROMATHERAPY CREAMS; AROMATHERAPY LOTIONS; ASTRINGENTS FOR COSMETIC PURPOSES; BABY LOTION; BAR SOAP; BATH AND SHOWER GELS AND SALTS NOT FOR MEDICAL PURPOSES; BATH CREAM; BATH LOTION; BATH OILS AND BATH SALTS; BATH OILS FOR COSMETIC PURPOSES; BATH POWDER; BATH SALTS; BATH SOAPS; BATH SOAPS IN LIQUID, SOLID OR GEL FORM; BATHING LOTIONS; BEAUTY CREAMS; BEAUTY CREAMS FOR BODY CARE; BEAUTY GELS; BEAUTY LOTIONS; BEAUTY MASKS; BEAUTY MILKS; BEAUTY SERUMS; BLEACHING PREPARATIONS FOR COSMETIC PURPOSES; BODY AND BEAUTY CARE COSMETICS; BODY CREAM; BODY CREAM SOAP; BODY CREAMS; BODY LOTION; BODY LOTIONS; BODY MASK CREAM; BODY MASK LOTION; CAKES OF TOILET SOAP; CLEANSING CREAMS; COCOA BUTTER FOR COSMETIC PURPOSES; COLD CREAM; COLD CREAMS; COLOGNES, PERFUMES AND COSMETICS; COSMETIC CREAMS; COSMETIC CREAMS FOR SKIN CARE; COSMETIC FACIAL BLOTTER PAPERS; COSMETIC HAIR REGROWTH INHIBITING PREPARATIONS; COSMETIC MILKS; COSMETIC OILS; COSMETIC OILS FOR THE EPIDERMIS; COSMETIC

CLASS 3—(Continued).

OLIVE OIL FOR THE FACE AND BODY; COSMETIC PREPARATIONS; COSMETIC PREPARATIONS AGAINST SUNBURN; COSMETIC PREPARATIONS FOR BODY CARE; COSMETIC SOAPS; COSMETIC SUNTANNING PREPARATIONS; COSMETIC SUNTAN LOTIONS; COSMETIC SUNTAN PREPARATIONS; COSMETICS; COSMETICS AND COSMETIC PREPARATIONS; COSMETICS IN GENERAL, INCLUDING PERFUMES; CREAM SOAPS; CUTICLE CREAM; DEODORANT SOAP; DEPILATORY CREAMS; DETERGENT SOAP; DISINFECTANT SOAPS; DISINFECTING PERFUMED SOAPS; EAU DE PERFUME; ESSENTIAL OILS AS PERFUME FOR LAUNDRY PURPOSES; EXFOLIANT CREAMS; EYE CREAM; EYE LOTIONS; FACE AND BODY BEAUTY CREAMS; FACE AND BODY CREAMS; FACE AND BODY LOTIONS; FACE CREAMS; FACE CREAMS FOR COSMETIC USE; FACE MILK AND LOTIONS; FACE POWDER PASTE; FACIAL BEAUTY MASKS; FACIAL CREAM; FACIAL CREAMS; FACIAL LOTION; FAIR COMPLEXION CREAM; GRANULATED SOAPS; GRAPE SEED OIL FOR COSMETIC USE; GREASES FOR COSMETIC PURPOSES; HAIR CARE CREAMS; HAIR CARE LOTIONS; HAIR CREAMS; HAIR LOTION; HAIR LOTIONS; HAIR REMOVING CREAM; HAND CREAM; HAND CREAMS; HAND LOTIONS; HAND SOAPS; HENNA FOR COSMETIC PURPOSES; LIP CREAM; LIQUID BATH SOAPS; LIQUID PERFUMES; LIQUID SOAP; LIQUID SOAP USED IN FOOT BATH; LIQUID SOAPS; LIQUID SOAPS FOR HANDS AND FACE; LIQUID SOAPS FOR HANDS, FACE AND BODY; LOTIONS FOR BEARDS; LOTIONS FOR CELLULITE REDUCTION; LOTIONS FOR COSMETIC PURPOSES; LOTIONS FOR FACE AND BODY CARE; LOTIONS FOR STRENGTHENING THE NAILS; MAKEUP REMOVING LOTIONS; MAKEUP REMOVING MILK, GEL, LOTIONS AND CREAMS; MASSAGE CREAMS; MEDICATED SOAP; MEDICATED SOAPS; MILK FOR COSMETIC PURPOSES; MINERAL SALT IN THE NATURE OF BATH SALTS NOT FOR MEDICAL PURPOSES; MOISTURIZING CREAMS; NAIL CREAM; NIGHT CREAM; NONMEDICATED BATH SALTS; NONMEDICATED DIAPER RASH OINTMENTS AND LOTIONS; NONMEDICATED FOOT CREAM; NONMEDICATED FOOT LOTIONS; NONMEDICATED HAIR RESTORATION LOTIONS; NONMEDICATED SCALP TREATMENT CREAM; NONMEDICATED SKIN CARE PREPARATIONS, NAMELY, CREAMS, LOTIONS, GELS, TONERS, CLEANERS AND PEELS; NONMEDICATED SKIN CREAMS; NONMEDICATED STIMULATING LOTIONS FOR THE SKIN; OILS FOR COSMETIC PURPOSES; OILS FOR PERFUMES AND SCENTS; PERFUME; PERFUME OILS; PERFUMED CREAMS; PERFUMED PASTE; PERFUMED POWDER; PERFUMED POWDERS; PERFUMED SOAP; PERFUMED SOAPS; PERFUMED TALCUM POWDER; PERFUMES; PERFUMES AND COLOGNES; PERFUMES AND TOILET WATERS; PERFUMES, AFTERSHAVES AND COLOGNES; PERFUMES, EAU DE COLOGNES AND AFTERSHAVES; PERFUMES, EAU DE COLOGNE AND AFTERSHAVES; PERFUMING SACHETS; PRE-SHAVE CREAMS; PRIVATE LABEL COSMETICS; RETINAL CREAM FOR COSMETIC PURPOSES; ROSE OIL FOR COSMETIC PURPOSES; SADDLE SOAP; SCENTED BODY LOTIONS AND CREAMS; SHAVING CREAM; SHAVING CREAMS; SHAVING LOTION; SHAVING LOTIONS; SHAVING SOAP; SHAVING SOAPS; SHEA BUTTER FOR COSMETIC PURPOSES; SKIN AND BODY TOPICAL LOTIONS, CREAMS AND OILS FOR COSMETIC USE; SKIN BRONZING CREAMS; SKIN CLEANSING CREAM; SKIN CLEANSING LOTION; SKIN CREAM; SKIN CREAMS; SKIN CREAMS IN LIQUID AND IN SOLID FORM; SKIN CREAMS IN LIQUID AND SOLID; SKIN CREAMS IN LIQUID AND SOLID FORM; SKIN FRESHENERS; SKIN LIGHTENING CREAMS; SKIN LOTION; SKIN LOTIONS; SKIN SOAP; SKIN WHITENING CREAMS; SOAPS FOR BODY CARE; SOAPS FOR PERSONAL USE; SOAPS FOR TOILET PURPOSES; STYLING LOTIONS; STYLING PASTE FOR HAIR; SUN CARE LOTIONS; SUN CREAMS; SUNTAN

CLASS 3—(Continued).

LOTION; SUN-BLOCK LOTIONS; SUNTANNING OILS AND LOTIONS; SUNSCREEN CREAM; SUNSCREEN CREAMS; SUNTAN CREAMS; TANNING CREAMS; TEETH CLEANING LOTIONS; TISSUES IMPREGNATED WITH COSMETIC LOTIONS; TOILET SOAP; TOILET SOAPS; TONING LOTION FOR THE FACE, BODY AND HANDS; TOOTH PASTE; TOOTH PASTE IN SOFT CAKE; TOOTH WHITENING CREAMS; TOOTH WHITENING PASTES; TOPICAL HERBAL CREAM FOR FIRING AND ENHANCING BREASTS; VANISHING CREAM; WATERLESS SOAP; WRINKLE RESISTANT CREAM (U.S. CLS. 1, 4, 6, 50, 51 AND 52).

ALICE SUE CARRUTHERS, EXAMINING ATTORNEY

SN 77-566,941. PV CREATIONS LLC, FAIR LAWN, NJ.
FILED 9-10-2008.



THE MARK CONSISTS OF THE WORD "LUXTURAL" WITH A DROPLET OVER THE LETTER "U".

FOR SKIN CARE PRODUCTS, NAMELY, CREAMS, LOTIONS, TONERS, SPRAY TONERS, NON-MEDICATED BEAUTY MASKS, NON-MEDICATED SKIN SERUMS, BEAUTY SERUMS; SUNSCREEN; HAIR CARE PRODUCTS, NAMELY, SHAMPOO, CONDITIONERS, GELS, MOUSSE, HAIR SERUMS, NON-MEDICATED HAIR CARE PREPARATIONS; COSMETICS; MAKE-UP; NON-MEDICATED TOILETRIES AND NAIL CARE PREPARATIONS; PERFUMES, FRAGRANCES FOR PERSONAL USE, COLOGNES, EAU DE TOILETTE (U.S. CLS. 1, 4, 6, 50, 51 AND 52).

ALLISON SCHRODY, EXAMINING ATTORNEY

SN 77-566,969. KNOWLES, BEYONCE, BEVERLY HILLS, CA.
FILED 9-10-2008.

SASHA FIERCE

THE MARK CONSISTS OF STANDARD CHARACTERS WITHOUT CLAIM TO ANY PARTICULAR FONT, STYLE, SIZE, OR COLOR.

THE NAME "SASHA FIERCE" DOES NOT IDENTIFY A LIVING INDIVIDUAL.

FOR FRAGRANCE (U.S. CLS. 1, 4, 6, 50, 51 AND 52).
SHANNON TWOHIG, EXAMINING ATTORNEY

CLASS 3—(Continued).

SN 77-567,144. PAULA'S CHOICE, INC., RENTON, WA. FILED 9-10-2008.

Age Reduce

THE MARK CONSISTS OF STANDARD CHARACTERS WITHOUT CLAIM TO ANY PARTICULAR FONT, STYLE, SIZE, OR COLOR.

FOR COSMETICS AND NON-MEDICATED SKIN CARE PREPARATIONS (U.S. CLS. 1, 4, 6, 50, 51 AND 52). LAURIE MAYES, EXAMINING ATTORNEY

CLASS 3—(Continued).

SN 77-567,317. FABULOUS FACES BY BARBARA STRAMPELLO LLC, HADDONFIELD, NJ. FILED 9-11-2008.



NO CLAIM IS MADE TO THE EXCLUSIVE RIGHT TO USE "LLC", APART FROM THE MARK AS SHOWN.

THE NAME "BARABARA STRAMPELLO" IDENTIFIES A LIVING INDIVIDUAL WHOSE CONSENT IS OF RECORD. THE COLOR(S) BLACK AND PINK IS/ARE CLAIMED AS A FEATURE OF THE MARK.

THE MARK CONSISTS OF THE LITERAL ELEMENT "FABULOUS FACES" AND "BARBARA STRAMPELLO" IN BLACK, AND THE LITERAL ELEMENTS "BY" AND "LLC" IN PINK, WHERE THE "FABULOUS" AND "FACES" ELEMENTS ARE WRITTEN IN STYLIZED SCRIPT AND SHARE A LARGE SCRIPT "F," WHICH FORMS THE CURVE OF A WOMAN'S FACE. THE WOMAN'S EYE AND NOSE ARE BLACK AND HER LIPS ARE PINK.

FOR COSMETIC CREAMS FOR SKIN CARE; NON-MEDICATED SKIN CARE PREPARATIONS, NAMELY, CREAMS, LOTIONS, GELS, TONERS, CLEANSERS AND PEELS; SKIN CARE PRODUCTS, NAMELY, NON-MEDICATED SKIN SERUM; WRINKLE REMOVING SKIN CARE PREPARATIONS; FACIAL CLEANSERS; SKIN CLEANSERS; ANTI-AGING CREAMS; EXFOLIANT CREAMS; EYE CREAM; NIGHT CREAM; MOISTURIZING CREAM; RETINOL CREAM FOR COSMETIC PURPOSES; SKIN AND BODY TOPICAL LOTIONS, CREAMS AND OILS FOR COSMETIC USE; EYE SHADOW; EYE LINER; EYE LINER PENCILS; BLUSH; MASCARA; FOUNDATION MAKE-UP; LIPSTICK; LIP GLOSS; FACIAL CONCEALER (U.S. CLS. 1, 4, 6, 50, 51 AND 52). MIDGE BUTLER, EXAMINING ATTORNEY

SN 77-567,193. COMMERCIAL MAINTENANCE CHEMICAL CORP., MASSAPEQUA, NY. FILED 9-10-2008.

Green Gobbler

THE MARK CONSISTS OF STANDARD CHARACTERS WITHOUT CLAIM TO ANY PARTICULAR FONT, STYLE, SIZE, OR COLOR.

FOR DRAIN OPENERS (U.S. CLS. 1, 4, 6, 50, 51 AND 52). KATHY DE JONGE, EXAMINING ATTORNEY

SN 77-567,531. RÁ GHALA CORPORATION, SEATTLE, WA. FILED 9-11-2008.

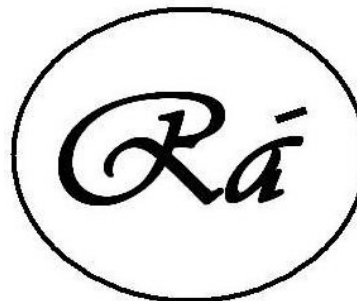

THE MARK CONSISTS OF A ROUNDED OVAL, WIDER THAN IT IS HIGH, CONTAINING THE WORD "RÁ" IN A STYLIZED FONT. THE LETTER "R" IS CAPITAL AND THE LETTER "A" IS LOWERCASE. THERE IS AN ACUTE ACCENT OVER THE LETTER "A".

FOR PERSONAL CARE PRODUCTS, NAMELY, COSMETICS, SKIN LOTIONS, AND BODY OILS (U.S. CLS. 1, 4, 6, 50, 51 AND 52). KRISTIN DAHLING, EXAMINING ATTORNEY

CLASS 3—(Continued).

SN 77-567,675. RAW BEAUTY, INC, BOCA RATON, FL. FILED 9-11-2008.

CLASS 3—(Continued).

SN 77-568,137. BATH & BODY WORKS BRAND MANAGEMENT, INC., REYNOLDSBURG, OH. FILED 9-11-2008.

GLOBAL GOOD

CERTIFIED RAW

THE MARK CONSISTS OF STANDARD CHARACTERS WITHOUT CLAIM TO ANY PARTICULAR FONT, STYLE, SIZE, OR COLOR.

FOR COSMETICS, NAMELY, SKIN CARE CREAM, FACE CREAM, BODY CREAM, SKIN MOISTURIZERS, SOAPS, SHAMPOOS, MAKE-UP KITS COMPRISED OF POWDERS FOR THE FACE, MAKE-UP KITS COMPRISED OF POWDERS FOR THE EYES IN THE NATURE OF EYE SHADOW, LIPSTICK, SELF-TANNING CREAMS, BODY WASH, SHOWER GEL AND FRAGRANCE FOR PERSONAL USE (U.S. CLS. 1, 4, 6, 50, 51 AND 52).

CAROLYN GRAY, EXAMINING ATTORNEY

SN 77-567,703. JON RENAU COLLECTIONS INC., VISTA, CA. FILED 9-11-2008.

afrodisiac

THE MARK CONSISTS OF STANDARD CHARACTERS WITHOUT CLAIM TO ANY PARTICULAR FONT, STYLE, SIZE, OR COLOR.

FOR HAIR CONDITIONER; HAIR OILS; HAIR SHAMPOO; HAIR STYLING GEL (U.S. CLS. 1, 4, 6, 50, 51 AND 52).

ARETHA SOMERVILLE, EXAMINING ATTORNEY

THE MARK CONSISTS OF STANDARD CHARACTERS WITHOUT CLAIM TO ANY PARTICULAR FONT, STYLE, SIZE, OR COLOR.

FOR 3-IN-1 HAIR CONDITIONERS, 3-IN-1 HAIR SHAMPOOS, ANTI-AGING CREAM, ANTI-PERSPIRANTS, ANTI-WRINKLE CREAMS, ANTIBACTERIAL SKIN SOAPS, ANTIPERSPIRANTS FOR PERSONAL USE, BATH BEADS, BATH CRYSTALS, BATH FOAMS, BATH GELS, BATH LOTION, BATH MILKS, BATH OILS FOR COSMETIC PURPOSES, BATH SALTS, BATH SOAKS, BODY CREAM SOAP, BODY CREAMS, BODY LOTIONS, BODY MASKS, BODY MILKS, BODY OILS, BODY POLISH, BODY SCRUB, BODY WASHES, BUBBLE BATH, CLEANSING CREAMS, COLOGNE, CONDITIONERS, CREAM SOAPS, DEODORANTS FOR BODY CARE, DUSTING POWDERS, EAU DE PARFUM, EAU DE TOILETTE, ESSENTIAL OILS FOR PERSONAL USE, EXFOLIANT CREAMS, EXFOLIANTS FOR SKIN, EYE CREAM, EYE GELS, FACIAL CLEANSERS, FACIAL CREAMS, FACIAL LOTION, FACIAL MASKS, FACE POLISH, FACIAL SCRUBS, FACIAL WASHES, FOAM BATH, HAIR CONDITIONERS, HAIR SHAMPOO, HAIR STYLING PREPARATIONS, HAND CLEANERS, HAND CLEANING PREPARATIONS, HAND CREAMS, HAND LOTIONS, HAND SOAPS, LIP BALM, LIP BUTTER, LIP CREAM, LIP GLOSS, MASSAGE OILS, MEDICATED SOAPS, MOISTURIZING CREAMS, PERFUME, PERFUME OILS, POMADES, SCENTED BODY SPRAY, SHOWER AND BATH FOAM, SHOWER AND BATH GEL, SHOWER CREAMS, SHOWER GELS, SKIN CLEANSERS, SKIN CLEANSING CREAM, SKIN CLEANSING LOTION, SKIN CONDITIONERS, SKIN CREAMS, SKIN LOTIONS, SKIN MASKS, SKIN MOISTURIZER, SKIN SOAP, SKIN TONERS, SOAPS FOR BODY CARE, SOAPS FOR PERSONAL USE, SUN CARE LOTIONS, SUN SCREEN, SUN SCREEN PREPARATIONS, SUN-BLOCK LOTIONS, SUNSCREEN CREAMS (U.S. CLS. 1, 4, 6, 50, 51 AND 52).

JILL PRATER, EXAMINING ATTORNEY

SN 77-568,226. DJF ENTERPRISES, CULVER CITY, CA. FILED 9-11-2008.

BE SMASHING

THE MARK CONSISTS OF STANDARD CHARACTERS WITHOUT CLAIM TO ANY PARTICULAR FONT, STYLE, SIZE, OR COLOR.

FOR COSMETICS (U.S. CLS. 1, 4, 6, 50, 51 AND 52).

ARETHA SOMERVILLE, EXAMINING ATTORNEY

CLASS 3—(Continued).

SN 77-570,466. JON RENAU INC., VISTA, CA. FILED 9-15-2008.

revere

THE MARK CONSISTS OF STANDARD CHARACTERS WITHOUT CLAIM TO ANY PARTICULAR FONT, STYLE, SIZE, OR COLOR.

FOR ESSENTIAL OILS; HAIR BALSAM; HAIR CONDITIONER; HAIR CONDITIONERS; HAIR GEL AND HAIR MOUSSE; HAIR GELS; HAIR GLAZE; HAIR MOUSSE; HAIR NOURISHERS; HAIR OILS; HAIR POMADES; HAIR RINSES; HAIR SHAMPOO; HAIR SHAMPOOS AND CONDITIONERS; HAIR SPRAY; HAIR SPRAYS; HAIR STRAIGHTENING PREPARATIONS; HAIR STYLING GEL; HAIR STYLING SPRAY; SHAMPOO-CONDITIONERS; SHAMPOOS (U.S. CLS. 1, 4, 6, 51 AND 52).

MARY MUNSON, EXAMINING ATTORNEY

SN 77-571,526. ILLINOIS TOOL WORKS INC., GLENVIEW, IL. FILED 9-16-2008.

TURBO WET

THE MARK CONSISTS OF STANDARD CHARACTERS WITHOUT CLAIM TO ANY PARTICULAR FONT, STYLE, SIZE, OR COLOR.

FOR CLEANING PREPARATIONS; AUTOMOTIVE CLEANING AND POLISHING PREPARATIONS; SILICONE PROTECTANT FOR AUTOMOBILE TIRES; TIRE AND WHEEL CLEANERS; TIRE CARE AND FINISHING PREPARATIONS (U.S. CLS. 1, 4, 6, 50, 51 AND 52).

DAWN FELDMAN, EXAMINING ATTORNEY

SN 77-573,345. GUERLAIN S.A., 75008 PARIS, FRANCE, FILED 9-18-2008.

IDYLLE

THE MARK CONSISTS OF STANDARD CHARACTERS WITHOUT CLAIM TO ANY PARTICULAR FONT, STYLE, SIZE, OR COLOR.

PRIORITY CLAIMED UNDER SEC. 44(D) ON UNITED KINGDOM APPLICATION NO. 248861, FILED 5-22-2008.

THE FOREIGN WORDING IN THE MARK TRANSLATES INTO ENGLISH AS IDYLL.

FOR PERFUMERY, PERFUMES, EAU DE TOILETTE, PERSONAL DEODORANTS, ESSENTIAL OILS FOR PERSONAL USE, SHOWER GELS, BATH SALTS, COSMETIC CREAMS FOR BODY CARE, HAIR LOTIONS, COSMETICS (U.S. CLS. 1, 4, 6, 50, 51 AND 52).

JEAN IM, EXAMINING ATTORNEY

CLASS 3—(Continued).

SN 77-578,530. SAMY MARK, INC., OLDSMAR, FL. FILED 9-25-2008.

ē·sen·cía
by samy

OWNER OF U.S. REG. NOS. 1,858,321, 3,087,282 AND OTHERS.

THE MARK CONSISTS OF THE WORD "ESENCIA" IN LETTERING DEPICTING ITS PRONUNCIATION WITH THE WORDS "BY SAMY" UNDERNEATH. BOTH OF THESE WORDS ARE ABOVE A CIRCLE CONTAINING A LEAF DRIPPING A SINGLE DROP ACCOMPANIED BY THE WORDS "THE ESSENCE OF HEALTHY HAIR".

THE FOREIGN WORDING IN THE MARK TRANSLATES INTO ENGLISH AS ESSENCE.

FOR HAIR CARE PREPARATIONS (U.S. CLS. 1, 4, 6, 50, 51 AND 52).

JENNY PARK, EXAMINING ATTORNEY

SN 77-584,367. MOSHE INC, DBA ECLECTIC COLLECTION, LOS ANGELES, CA. FILED 10-2-2008.

Evasive

THE MARK CONSISTS OF STANDARD CHARACTERS WITHOUT CLAIM TO ANY PARTICULAR FONT, STYLE, SIZE, OR COLOR.

FOR COLOGNES, PERFUMES AND COSMETICS; COSMETICS IN GENERAL, INCLUDING PERFUMES; DISINFECTING PERFUMED SOAPS; EAU DE PERFUME; ESSENTIAL OILS AS PERFUME FOR LAUNDRY PURPOSES; LIQUID PERFUMES; OILS FOR PERFUMES AND SCENTS; PERFUME; PERFUME OILS; PERFUME OILS FOR THE MANUFACTURE OF COSMETIC PREPARATIONS; PERFUMED CREAMS; PERFUMED EXTRACTS FOR TISSUES AND PERFUMES; PERFUMED PASTE; PERFUMED POWDER; PERFUMED POWDERS; PERFUMED SOAP; PERFUMED SOAPS; PERFUMED TALCUM POWDER; PERFUMES; PERFUMES AND COLOGNES; PERFUMES AND TOILET WATERS; PERFUMES, AFTERSHAVES AND COLOGNES; PERFUMES, EAU DE COLOGNES AND AFTERSHAVES; PERFUMES, EAUX DE COLOGNE AND AFTERSHAVES; PERFUMING SACHETS (U.S. CLS. 1, 4, 6, 50, 51 AND 52).

FIRST USE 11-8-2007; IN COMMERCE 11-8-2007.

INGRID C. EULIN, EXAMINING ATTORNEY

CLASS 3—(Continued).

SN 77-584,374. MOSHE INC, DBA ECLECTIC COLLECTION, LOS ANGELES, CA. FILED 10-2-2008.

Dilemma

THE MARK CONSISTS OF STANDARD CHARACTERS WITHOUT CLAIM TO ANY PARTICULAR FONT, STYLE, SIZE, OR COLOR.

FOR COLOGNES, PERFUMES AND COSMETICS; COSMETICS IN GENERAL, INCLUDING PERFUMES; DISINFECTING PERFUMED SOAPS; EAU DE PERFUME; ESSENTIAL OILS AS PERFUME FOR LAUNDRY PURPOSES; LIQUID PERFUMES; OILS FOR PERFUMES AND SCENTS; PERFUME; PERFUME OILS; PERFUME OILS FOR THE MANUFACTURE OF COSMETIC PREPARATIONS; PERFUMED CREAMS; PERFUMED EXTRACTS FOR TISSUES AND PERFUMES; PERFUMED PASTE; PERFUMED POWDER; PERFUMED POWDERS; PERFUMED SOAP; PERFUMED SOAPS; PERFUMED TALCUM POWDER; PERFUMES; PERFUMES AND COLOGNES; PERFUMES AND TOILET WATERS; PERFUMES, AFTERSHAVES AND COLOGNES; PERFUMES, EAU DE COLOGNES AND AFTERSHAVES; PERFUMES, EAUX DE COLOGNE AND AFTERSHAVES; PERFUMING SACHETS (U.S. CLS. 1, 4, 6, 50, 51 AND 52).
FIRST USE 11-8-2007; IN COMMERCE 11-8-2007.

INGRID C. EULIN, EXAMINING ATTORNEY

SN 77-584,398. MOSHE INC, DBA SCENT-SATION, LOS ANGELES, CA. FILED 10-2-2008.

Mentor

THE MARK CONSISTS OF STANDARD CHARACTERS WITHOUT CLAIM TO ANY PARTICULAR FONT, STYLE, SIZE, OR COLOR.

FOR COLOGNES, PERFUMES AND COSMETICS; COSMETICS IN GENERAL, INCLUDING PERFUMES; DISINFECTING PERFUMED SOAPS; EAU DE PERFUME; ESSENTIAL OILS AS PERFUME FOR LAUNDRY PURPOSES; LIQUID PERFUMES; OILS FOR PERFUMES AND SCENTS; PERFUME; PERFUME OILS; PERFUME OILS FOR THE MANUFACTURE OF COSMETIC PREPARATIONS; PERFUMED CREAMS; PERFUMED EXTRACTS FOR TISSUES AND PERFUMES; PERFUMED PASTE; PERFUMED POWDER; PERFUMED POWDERS; PERFUMED SOAP; PERFUMED SOAPS; PERFUMED TALCUM POWDER; PERFUMES; PERFUMES AND COLOGNES; PERFUMES AND TOILET WATERS; PERFUMES, AFTERSHAVES AND COLOGNES; PERFUMES, EAU DE COLOGNES AND AFTERSHAVES; PERFUMES, EAUX DE COLOGNE AND AFTERSHAVES; PERFUMING SACHETS (U.S. CLS. 1, 4, 6, 50, 51 AND 52).
FIRST USE 11-8-2007; IN COMMERCE 11-8-2007.

INGRID C. EULIN, EXAMINING ATTORNEY

CLASS 3—(Continued).

SN 77-584,409. MOSHE INC, DBA SCENT-SATION, LOS ANGELES, CA. FILED 10-2-2008.

Motto

THE MARK CONSISTS OF STANDARD CHARACTERS WITHOUT CLAIM TO ANY PARTICULAR FONT, STYLE, SIZE, OR COLOR.

FOR COLOGNES, PERFUMES AND COSMETICS; COSMETICS IN GENERAL, INCLUDING PERFUMES; DISINFECTING PERFUMED SOAPS; EAU DE PERFUME; ESSENTIAL OILS AS PERFUME FOR LAUNDRY PURPOSES; LIQUID PERFUMES; OILS FOR PERFUMES AND SCENTS; PERFUME; PERFUME OILS; PERFUME OILS FOR THE MANUFACTURE OF COSMETIC PREPARATIONS; PERFUMED CREAMS; PERFUMED EXTRACTS FOR TISSUES AND PERFUMES; PERFUMED PASTE; PERFUMED POWDER; PERFUMED POWDERS; PERFUMED SOAP; PERFUMED SOAPS; PERFUMED TALCUM POWDER; PERFUMES; PERFUMES AND COLOGNES; PERFUMES AND TOILET WATERS; PERFUMES, AFTERSHAVES AND COLOGNES; PERFUMES, EAU DE COLOGNES AND AFTERSHAVES; PERFUMES, EAUX DE COLOGNE AND AFTERSHAVES; PERFUMING SACHETS (U.S. CLS. 1, 4, 6, 50, 51 AND 52).
FIRST USE 11-8-2007; IN COMMERCE 11-8-2007.

INGRID C. EULIN, EXAMINING ATTORNEY

SN 77-591,101. JOHNSON & JOHNSON, NEW BRUNSWICK, NJ. FILED 10-13-2008.

LISTERINE ESSENTIAL CARE

THE MARK CONSISTS OF STANDARD CHARACTERS WITHOUT CLAIM TO ANY PARTICULAR FONT, STYLE, SIZE, OR COLOR.

OWNER OF U.S. REG. NOS. 41,413, 240,162 AND OTHERS. FOR TOOTHPASTE (U.S. CLS. 1, 4, 6, 50, 51 AND 52).
FIRST USE 10-20-2000; IN COMMERCE 10-20-2000.
FLORENTINA BLANDU, EXAMINING ATTORNEY

CLASS 3—(Continued).

SN 77-592,542. RICHMAN, DEBORAH K., HUNTINGTON BAY, NY. FILED 10-14-2008.

"No More"

THE MARK CONSISTS OF STANDARD CHARACTERS WITHOUT CLAIM TO ANY PARTICULAR FONT, STYLE, SIZE, OR COLOR.

FOR COLOGNES, PERFUMES AND COSMETICS; COSMETIC CREAMS; COSMETIC CREAMS FOR SKIN CARE; COSMETIC PREPARATIONS AGAINST SUN-BURN; COSMETIC PREPARATIONS FOR BODY CARE; COSMETIC PREPARATIONS FOR EYE LASHES; COSMETIC PREPARATIONS FOR SKIN RENEWAL; COSMETIC PREPARATIONS FOR SLIMMING PURPOSES; COSMETIC PRODUCTS IN THE FORM OF AEROSOLS FOR SKIN CARE; COSMETIC PRODUCTS IN THE FORM OF AEROSOLS FOR SKINCARE; COSMETIC SOAPS; COSMETICS IN GENERAL, INCLUDING PERFUMES; NAIL CARE PREPARATIONS; NAIL CARE PREPARATIONS, NAMELY, NAIL SOFTENERS; NON-MEDICATED SKIN CARE PREPARATION, NAMELY, BODY MIST; PRIVATE LABEL COSMETICS; RETINOL CREAM FOR COSMETIC PURPOSES; SKIN AND BODY TOPICAL LOTIONS, CREAMS AND OILS FOR COSMETIC USE; SKIN CARE PREPARATIONS, NAMELY, CHEMICAL PEELS FOR SKIN; SKIN CARE PREPARATIONS, NAMELY, FRUIT ACID PEELS FOR SKIN; SKIN CLEANSERS; SKIN CLEANSING CREAM; SKIN CLEANSING LOTION; SKIN CONDITIONERS; SKIN CREAM; SKIN CREAMS; SKIN EMOLLIENTS; SKIN LOTIONS; SKIN MOISTURIZER; SKIN MOISTURIZER MASKS; SKIN SOAP; SKIN TEXTURIZERS; SKIN TONERS; SKIN WHITENING CREAMS; SKIN WHITENING PREPARATIONS; SUN CARE LOTIONS; TOPICAL SKIN SPRAYS FOR COSMETIC PURPOSES; WRINKLE REMOVING SKIN CARE PREPARATIONS (U.S. CLS. 1, 4, 6, 50, 51 AND 52).

FIRST USE 9-1-2003; IN COMMERCE 9-1-2003.
JAMES STEIN, EXAMINING ATTORNEY

SN 77-600,470. GONE GREEN, LLC, PLEASANTON, CA. FILED 10-24-2008.

BRILLIANT DIVA

THE MARK CONSISTS OF STANDARD CHARACTERS WITHOUT CLAIM TO ANY PARTICULAR FONT, STYLE, SIZE, OR COLOR.

FOR MAKEUP, NAMELY, MINERAL FOUNDATIONS, MINERAL POWDERS, MINERAL BLUSHES, MINERAL BRONZERS, MINERAL EYE SHADOWS (U.S. CLS. 1, 4, 6, 50, 51 AND 52).
MONIQUE MILLER, EXAMINING ATTORNEY

CLASS 3—(Continued).

SN 77-601,294. AUSTRALIAN GOLD, INC., INDIANAPOLIS, IN. FILED 10-27-2008.

CALIFORNIA DREAMIN'

THE MARK CONSISTS OF STANDARD CHARACTERS WITHOUT CLAIM TO ANY PARTICULAR FONT, STYLE, SIZE, OR COLOR.

FOR NON-MEDICATED INDOOR AND OUTDOOR SKIN TANNING PREPARATIONS (U.S. CLS. 1, 4, 6, 50, 51 AND 52).

CARRIE GENOVESE, EXAMINING ATTORNEY

SN 77-601,296. AUSTRALIAN GOLD, INC., INDIANAPOLIS, IN. FILED 10-27-2008.

SHOW STOPPER

THE MARK CONSISTS OF STANDARD CHARACTERS WITHOUT CLAIM TO ANY PARTICULAR FONT, STYLE, SIZE, OR COLOR.

FOR NON-MEDICATED INDOOR AND OUTDOOR SKIN TANNING PREPARATIONS (U.S. CLS. 1, 4, 6, 50, 51 AND 52).

CARRIE GENOVESE, EXAMINING ATTORNEY

SN 77-608,077. DJF ENTERPRISES, CULVER CITY, CA. FILED 11-5-2008.

SHEER FOCUS

THE MARK CONSISTS OF STANDARD CHARACTERS WITHOUT CLAIM TO ANY PARTICULAR FONT, STYLE, SIZE, OR COLOR.

FOR COSMETICS (U.S. CLS. 1, 4, 6, 50, 51 AND 52).
ARETHA SOMERVILLE, EXAMINING ATTORNEY

CLASS 3—(Continued).

SN 77-611,002. AUSTRALIAN GOLD, INC., INDIANAPOLIS, IN. FILED 11-10-2008.

DEFENSE ZONE

THE MARK CONSISTS OF STANDARD CHARACTERS WITHOUT CLAIM TO ANY PARTICULAR FONT, STYLE, SIZE, OR COLOR.

FOR SUNTANNING PREPARATIONS (U.S. CLS. 1, 4, 6, 50, 51 AND 52).
CARRIE GENOVESE, EXAMINING ATTORNEY

SN 77-611,676. AUSTRALIAN GOLD, INC., INDIANAPOLIS, IN. FILED 11-11-2008.

DANGEROUSLY DARKER

THE MARK CONSISTS OF STANDARD CHARACTERS WITHOUT CLAIM TO ANY PARTICULAR FONT, STYLE, SIZE, OR COLOR.

OWNER OF U.S. REG. NO. 2,867,616.
FOR NON-MEDICATED INDOOR AND OUTDOOR SKIN TANNING PREPARATIONS (U.S. CLS. 1, 4, 6, 50, 51 AND 52).
FIRST USE 11-1-2008; IN COMMERCE 11-1-2008.
CARRIE GENOVESE, EXAMINING ATTORNEY

SN 77-624,571. L'OREAL USA CREATIVE, INC., NEW YORK, NY. FILED 12-2-2008.

FIBER SHUFFLE

THE MARK CONSISTS OF STANDARD CHARACTERS WITHOUT CLAIM TO ANY PARTICULAR FONT, STYLE, SIZE, OR COLOR.

FOR HAIR STYLING PREPARATION (U.S. CLS. 1, 4, 6, 50, 51 AND 52).
JOHN HWANG, EXAMINING ATTORNEY

CLASS 3—(Continued).

SN 78-134,993. PHILOSOPHY, INC., PHOENIX, AZ. FILED 6-12-2002.

MOON BATHING

NO CLAIM IS MADE TO THE EXCLUSIVE RIGHT TO USE "BATHING", APART FROM THE MARK AS SHOWN.

FOR MAKE-UP KITS COMPRISED OF LIPSTICK, LIP GLOSS, LIP LINER, LIP BALM, BLUSH, FOUNDATION, EYE SHADOW, EYE LINER, MASCARA, CONCEALER, COSMETIC PENCILS, AND FACIAL POWDER; COSMETICS, NAMELY, LIPSTICK, LIP GLOSS, LIP LINER, LIP BALM, BLUSH, FOUNDATION, EYE SHADOW, EYE LINER, MASCARA, CONCEALER, COSMETIC PENCILS, AND FACIAL POWDER; FRAGRANCES, NAMELY, PERFUME, COLOGNE, AND AFTER-SHAVE; NON-MEDICATED SKIN CARE PRODUCTS, NAMELY, SOAP, SCRUBS, TONER, CONDITIONER, EXFOLIATORS, SKIN CLARIFIER, WRINKLE REMOVING SKIN CARE PREPARATIONS, AND MOISTURIZER; FACE AND BODY LOTION, CREAM, OIL, GEL AND SPRAY; SUN SCREEN PREPARATIONS, NAMELY, LOTION, CREAM, GEL, AND SPRAY; NON-MEDICATED FACE AND BODY SKIN LIGHTENER; HAIR CARE PRODUCTS, NAMELY, SHAMPOO, CONDITIONER, RINSE, GEL, MOUSSE, SPRAY AND TONIC; BATH CARE PRODUCTS, NAMELY, SOAP, SALTS, CRYSTALS, BEADS, GEL, OIL, POWDER, AND BUBBLE BATH; SCENTED HEAD-TO-TOE BODY WASH; NAIL CARE PREPARATIONS, NAMELY, CUTICLE CREAM, CUTICLE REMOVING PREPARATIONS, NAIL ENAMEL, NAIL POLISH, NAIL POLISH REMOVER, NAIL POLISH BASE COAT, NAIL POLISH TOP COAT, AND NAIL STRENGTHENERS; PERSONAL DEODORANT. (U.S. CLS. 1, 4, 6, 50, 51 AND 52).

RON FAIRBANKS, EXAMINING ATTORNEY

SN 78-830,030. D'AVICENNA INC., TORONTO, CANADA, FILED 3-6-2006.

D'AVICENNA

THE MARK CONSISTS OF STANDARD CHARACTERS WITHOUT CLAIM TO ANY PARTICULAR FONT, STYLE, SIZE, OR COLOR.

PRIORITY CLAIMED UNDER SEC. 44(D) ON CANADA APPLICATION NO. 1291150, FILED 2-23-2006.

OWNER OF CANADA REG. NO. TMA693,336, DATED 8-2-2007, EXPIRES 8-2-2022.

FOR PERSONAL CLEANING AND BEAUTY PRODUCTS, NAMELY, HAND SOAPS, HAIR SHAMPOOS, HAIR CONDITIONERS, BODY LOTIONS, BEAUTY GELS, BODY CREAMS, NON-MEDICATED TOILETRIES, SKIN MOISTURIZERS, SKIN CLEANSERS AND COSMETICS (U.S. CLS. 1, 4, 6, 50, 51 AND 52).

EVELYN BRADLEY, EXAMINING ATTORNEY

CLASS 3—(Continued).

SN 78-850,632. MINDFX SCIENCE, LLC, SAN DIEGO, CA. FILED 3-30-2006.

MAXXMINT

THE MARK CONSISTS OF STANDARD CHARACTERS WITHOUT CLAIM TO ANY PARTICULAR FONT, STYLE, SIZE, OR COLOR.
FOR BREATH FRESHNERS (U.S. CLS. 1, 4, 6, 50, 51 AND 52).
JAMES MACFARLANE, EXAMINING ATTORNEY

SN 79-048,240. KUM LIMITED, IRELAND, FILED 11-6-2007.

KUM BEAUTY

THE MARK CONSISTS OF STANDARD CHARACTERS WITHOUT CLAIM TO ANY PARTICULAR FONT, STYLE, SIZE, OR COLOR.
PRIORITY DATE OF 6-4-2007 IS CLAIMED.
OWNER OF INTERNATIONAL REGISTRATION 0948828 DATED 11-6-2007, EXPIRES 11-6-2017.
NO CLAIM IS MADE TO THE EXCLUSIVE RIGHT TO USE "BEAUTY", APART FROM THE MARK AS SHOWN.
FOR BLEACHING PREPARATIONS FOR LAUNDRY USE; CLEANING, POLISHING, SCOURING AND ABRASIVE PREPARATIONS; SOAPS; PERFUMERY; COSMETICS; COSMETIC PENCILS; COSMETIC SKIN CARE PREPARATIONS; LIPSTICKS; ESSENTIAL OILS; HAIR LOTIONS; SHAMPOOS; DENTIFRICES; MAKE-UP BAGS SOLD FILLED WITH COSMETICS (U.S. CLS. 1, 4, 6, 50, 51 AND 52).
JAMES GRIFFIN, EXAMINING ATTORNEY

SN 79-052,601. EDITIONS DE PARFUMS FREDERIC MALLE, FRANCE, FILED 3-13-2008.

DANS TES BRAS

THE MARK CONSISTS OF STANDARD CHARACTERS WITHOUT CLAIM TO ANY PARTICULAR FONT, STYLE, SIZE, OR COLOR.
OWNER OF INTERNATIONAL REGISTRATION 0960833 DATED 3-13-2008, EXPIRES 3-13-2018.
THE FOREIGN WORDING IN THE MARK TRANSLATES INTO ENGLISH AS "IN YOUR ARMS".
FOR PERFUMERY, PERFUMES, ESSENTIAL OILS, COSMETICS, DEODORANTS FOR PERSONAL USE, OILS FOR PERFUMES AND SCENTS; MAKE-UP REMOVING PREPARATIONS; INCENSE; SCENTED ROOM SPRAYS, NAMELY, AIR-FRESHENING HOME SCENTS; COSMETIC PRODUCTS FOR SKIN AND HAIR CARE AND WASHING PURPOSES, NAMELY, HAIR SHAMPOOS, BATH OILS, BATH AND SHOWER GEL, SOAP, BODY CREAMS AND BODY MILKS (U.S. CLS. 1, 4, 6, 50, 51 AND 52).
GILBERT SWIFT, EXAMINING ATTORNEY

CLASS 3—(Continued).

SN 79-052,661. MELVITA, FRANCE, FILED 3-6-2008.

BIO-EXCELLENCE

OWNER OF INTERNATIONAL REGISTRATION 0961026 DATED 3-6-2008, EXPIRES 3-6-2018.
FOR SOAPS, PERFUMERY, ESSENTIAL OILS, COSMETICS, HAIR-LOTIONS, DENTIFRICES, ALL OF THE AFORESAID GOODS BEING ORGANICALLY-FARMED OR MADE WITH ORGANICALLY-FARMED PRODUCTS (U.S. CLS. 1, 4, 6, 50, 51 AND 52).
RAMONA ORTIGA, EXAMINING ATTORNEY

SN 79-059,701. PARFUMS GIVENCHY, FRANCE, FILED 8-22-2008.

PHOTO'PERFEXION

PRIORITY DATE OF 3-21-2008 IS CLAIMED.
OWNER OF INTERNATIONAL REGISTRATION 0979305 DATED 8-22-2008, EXPIRES 8-22-2018.
FOR MAKE-UP FOUNDATION (U.S. CLS. 1, 4, 6, 50, 51 AND 52).
ALEX KEAM, EXAMINING ATTORNEY

CLASS 4—LUBRICANTS AND FUELS

SN 77-222,072. GUE, JIMMY J., SEATTLE, WA. FILED 7-4-2007.



NO CLAIM IS MADE TO THE EXCLUSIVE RIGHT TO USE "INDUSTRIAL PRODUCTS GROUP INC", APART FROM THE MARK AS SHOWN.
FOR BIRTHDAY CANDLES (U.S. CLS. 1, 6 AND 15).
FIRST USE 2-4-2007; IN COMMERCE 2-4-2007.
ALEX KEAM, EXAMINING ATTORNEY

CLASS 4—(Continued).

SN 77-402,977. BIOPELLET HEATING SYSTEMS, LLC, EAST HAMPTON, CT. FILED 2-21-2008.

BioBricks

THE MARK CONSISTS OF STANDARD CHARACTERS WITHOUT CLAIM TO ANY PARTICULAR FONT, STYLE, SIZE, OR COLOR.

FOR COMBUSTIBLE BRIQUETTES; FIRELIGHTERS; FOSSIL FUEL SUBSTITUTES, NAMELY, BIO-FUELS; FUEL PELLETS; FUEL PRODUCTS FOR STOVES, NAMELY, WOOD PELLETS, CORN AND GRAINS; FUELS; PELLETS OF COMPRESSED FIBER MANUFACTURED FROM A PLANT CROP TO BE USED AS FUEL; RENEWABLE FUELS; WOOD HEATING PELLETS (U.S. CLS. 1, 6 AND 15).

FIRST USE 10-15-2005; IN COMMERCE 12-15-2005.
TAMARA FRAZIER, EXAMINING ATTORNEY

SN 77-424,048. HYDRO-GEN-TECH, POTTSTOWN, PA. FILED 3-17-2008.

HYDRO-GEN-TECH

THE MARK CONSISTS OF STANDARD CHARACTERS WITHOUT CLAIM TO ANY PARTICULAR FONT, STYLE, SIZE, OR COLOR.

FOR FUELS (U.S. CLS. 1, 6 AND 15).
ELLEN PERKINS, EXAMINING ATTORNEY

SN 77-534,194. WILL & BAUMER CANDLE COMPANY, L.L.C., PHOENIX, AZ. FILED 7-29-2008.

LUMEN DEO

THE MARK CONSISTS OF STANDARD CHARACTERS WITHOUT CLAIM TO ANY PARTICULAR FONT, STYLE, SIZE, OR COLOR.

THE FOREIGN WORDING IN THE MARK TRANSLATES INTO ENGLISH AS LIGHT GOD.

FOR REFILLABLE CANDLES, TAPER CANDLES, PILLAR CANDLES, WAX CANDLES, VOTIVE CANDLES, NYLON LIQUID FUEL CANDLES, LIQUID FUEL FOR CANDLES (U.S. CLS. 1, 6 AND 15).

MIDGE BUTLER, EXAMINING ATTORNEY

CLASS 4—(Continued).

SN 77-561,438. THE BEAUFORT CANDLE COMPANY, ANNAPOLIS, MD. FILED 9-3-2008.

The Beaufort Candle Company

THE MARK CONSISTS OF STANDARD CHARACTERS WITHOUT CLAIM TO ANY PARTICULAR FONT, STYLE, SIZE, OR COLOR.

NO CLAIM IS MADE TO THE EXCLUSIVE RIGHT TO USE "CANDLE COMPANY", APART FROM THE MARK AS SHOWN.

FOR CANDLES OF VARIOUS SCENTS (U.S. CLS. 1, 6 AND 15).

DOMINIC J. FERRAIUOLO, EXAMINING ATTORNEY

SN 77-563,523. ADMIRAL SYNTHETIC LUBRICANTS L.L.C., HILLSBOROUGH, NJ. FILED 9-5-2008.

Admiral

THE MARK CONSISTS OF STANDARD CHARACTERS WITHOUT CLAIM TO ANY PARTICULAR FONT, STYLE, SIZE, OR COLOR.

FOR ALL PURPOSE INDUSTRIAL OILS, GREASES, LUBRICANTS AND SYNTHETIC LUBRICANTS, NAMELY, LUBRICANTS FOR USE IN INDUSTRY, MANUFACTURING, CONSTRUCTION, MINING, FORESTRY, AVIATION, METAL WORKING, AND MARINE APPLICATIONS; SYNTHETIC LUBRICANTS FOR VEHICLES, ENGINES, TRANSMISSIONS, POWER TOOLS AND INDUSTRIAL MACHINERY; AND SYNTHETIC LUBRICANTS FOR USE IN REFRIGERATION AND AIR CONDITIONING COMPRESSORS (U.S. CLS. 1, 6 AND 15).

THEODORE MCBRIDE, EXAMINING ATTORNEY

SN 77-565,023. LCI LLC, DECATURVILLE, TN. FILED 9-8-2008.

SOY-100

THE MARK CONSISTS OF STANDARD CHARACTERS WITHOUT CLAIM TO ANY PARTICULAR FONT, STYLE, SIZE, OR COLOR.

FOR ALL PURPOSE LUBRICANTS (U.S. CLS. 1, 6 AND 15).

MICHAEL KEATING, EXAMINING ATTORNEY

CLASS 4—(Continued).

SN 77-566,800. WIKEL, ROBERT E., MILAN, OH. FILED 9-10-2008.

AIM

THE MARK CONSISTS OF STANDARD CHARACTERS WITHOUT CLAIM TO ANY PARTICULAR FONT, STYLE, SIZE, OR COLOR.

FOR GUN LUBRICANT (U.S. CLS. 1, 6 AND 15).
FIRST USE 10-2-1996; IN COMMERCE 10-2-1996.
LAURIE KAUFMAN, EXAMINING ATTORNEY

CLASS 4—(Continued).

SN 77-571,515. POOLE, BEVERLY, CHAPEL HILL, TN. FILED 9-16-2008.

Sky Knight

THE STIPPLING IS FOR SHADING PURPOSES ONLY. THE MARK CONSISTS OF THE TEXT "SKY KNIGHT" WRITTEN IN EDWARDIAN SCRIPT WITH A SMALL FLAME ABOVE THE LETTER "I", AND A SMALL SKETCH OF A HORSE'S HEAD, NECK, AND MANE BEHIND "SKY KNIGHT".

FOR SOY CANDLES (U.S. CLS. 1, 6 AND 15).
SUSAN RICHARDS, EXAMINING ATTORNEY

SN 77-567,307. ITALY DAYSLAND INTERNATIONAL LIMITED, ROAD TOWN, TORTOLA, BR.VIRGIN ISLANDS, FILED 9-11-2008.

FENNI
ALEXANDER

THE MARK CONSISTS OF WORDS "FENNI AND ALEXANDER" AND A LEAF DEVICE. THE LEAF DEVICE IS BETWEEN TWO CAPITAL LETTERS "N" OF WORD "FENNI".

FOR BEESWAX FOR USE IN THE MANUFACTURE OF CANDLES; BEESWAX FOR USE IN THE MANUFACTURE OF COSMETICS; BEESWAX FOR USE IN THE MANUFACTURE OF OINTMENTS; CANDLES; CANDLES BEING OF WAX OR LIQUID, FOR THE ILLUMINATION OF CARVED PUMPKINS, MINI-PUMPKINS, GOURDS, AND OTHER FRUITS AND VEGETABLES; CARNAUBA WAX; DUST-BINDING COMPOSITIONS; FUELS; INDUSTRIAL OILS; PARAFFIN; SCENTED CANDLES; WAX EMULSIONS AND WAX POWDERS FOR INDUSTRIAL APPLICATIONS; WAXES; WICKS FOR CANDLES (U.S. CLS. 1, 6 AND 15).

FIRST USE 6-26-2008; IN COMMERCE 6-26-2008.
HOWARD B. LEVINE, EXAMINING ATTORNEY

SN 77-604,092. CRC INDUSTRIES, INC., WARMINSTER, PA. FILED 10-30-2008.

TrueTap

THE MARK CONSISTS OF STANDARD CHARACTERS WITHOUT CLAIM TO ANY PARTICULAR FONT, STYLE, SIZE, OR COLOR.

FOR ALL PURPOSE LUBRICANTS; LUBRICANTS FOR METAL WORKING AND CUTTING (U.S. CLS. 1, 6 AND 15).

FIRST USE 1-0-2002; IN COMMERCE 1-0-2002.
JACQUELINE A. LAVINE, EXAMINING ATTORNEY

SN 77-568,309. AMYRIS BIOTECHNOLOGIES, INC., EMERYVILLE, CA. FILED 9-11-2008.

NO COMPROMISE

THE MARK CONSISTS OF STANDARD CHARACTERS WITHOUT CLAIM TO ANY PARTICULAR FONT, STYLE, SIZE, OR COLOR.

FOR ALTERNATIVE FUEL FOR MOTOR VEHICLES, NAMELY, BIOFUEL (U.S. CLS. 1, 6 AND 15).
JULIE GUTTADAURO, EXAMINING ATTORNEY

CLASS 5—PHARMACEUTICALS

SN 76-631,633. GREEN PLANET, INC., LOS ANGELES, CA. FILED 2-18-2005.

HERBAL
Jump
Start
EXTREME

NO CLAIM IS MADE TO THE EXCLUSIVE RIGHT TO USE "HERBAL", APART FROM THE MARK AS SHOWN. FOR VITAMIN AND MINERAL SUPPLEMENTS (U.S. CLS. 6, 18, 44, 46, 51 AND 52).

FIRST USE 1-15-2005; IN COMMERCE 1-15-2005.
DAVID TAYLOR, EXAMINING ATTORNEY

CLASS 5—(Continued).

SN 76-678,413. HERAEUS KULZER GMBH, D-63450 HANAU, FED REP GERMANY, FILED 6-19-2007.

i|BOND

PRIORITY CLAIMED UNDER SEC. 44(D) ON FED REP GERMANY APPLICATION NO. 30679083.1, FILED 12-21-2006, REG. NO. 30679083, DATED 5-16-2007, EXPIRES 12-31-2016.

OWNER OF U.S. REG. NO. 2,816,440.
FOR DENTAL ADHESIVES AND ADHESION PROMOTERS FOR DENTISTRY AND DENTAL TECHNICAL PURPOSES; DENTAL PREPARATIONS FOR USE IN THE MANUFACTURE OF DENTAL PRODUCTS FOR DENTAL AND DENTAL TECHNICAL PURPOSES (U.S. CLS. 6, 18, 44, 46, 51 AND 52).
ZACHARY BELLO, EXAMINING ATTORNEY

SN 76-689,004. COMBE INCORPORATED, WHITE PLAINS, NY. FILED 4-25-2008.

SCALPICIN

THE MARK CONSISTS OF STANDARD CHARACTERS WITHOUT CLAIM TO ANY PARTICULAR FONT, STYLE, SIZE, OR COLOR.

OWNER OF U.S. REG. NO. 1,979,862.
FOR MEDICATED PREMOISTENED TOWELETTES FOR USE IN THE RELIEF OF ITCHING OF THE SCALP AND OF SKIN ADJACENT TO THE SCALP (U.S. CLS. 6, 18, 44, 46, 51 AND 52).
MARY CRAWFORD, EXAMINING ATTORNEY

SN 76-694,158. IVY ANIMAL HEALTH, INC., OVERLAND PARK, KS. FILED 11-6-2008.

FINALYSE

THE MARK CONSISTS OF STANDARD CHARACTERS WITHOUT CLAIM TO ANY PARTICULAR FONT, STYLE, SIZE, OR COLOR.

FOR BACTERICIDES, NAMELY, BACTERIOPHAGE USED AS A HUMAN FOOD SAFETY AGENT TO REDUCE LEVELS OF FOOD BORNE PATHOGENS CARRIED ON LIVESTOCK, POULTRY, MEAT OR PRODUCE, PRIOR TO BEING PROCESSED FOR HUMAN CONSUMPTION (U.S. CLS. 6, 18, 44, 46, 51 AND 52).
MELISSA VALLILLO, EXAMINING ATTORNEY

CLASS 5—(Continued).

SN 77-020,955. ENDURANCE PRODUCTS COMPANY, TIGARD, OR. FILED 10-13-2006.

ENDUR-THINE

THE MARK CONSISTS OF STANDARD CHARACTERS WITHOUT CLAIM TO ANY PARTICULAR FONT, STYLE, SIZE, OR COLOR.

OWNER OF U.S. REG. NOS. 1,444,825 AND 1,704,518.
FOR DIETARY SUPPLEMENTS (U.S. CLS. 6, 18, 44, 46, 51 AND 52).
FIRST USE 9-18-1986; IN COMMERCE 9-18-1986.
BARNEY CHARLON, EXAMINING ATTORNEY

SN 77-143,492. VISALUS HOLDINGS LLC, TROY, MI. FILED 3-29-2007.

VISALUS NEURO

THE MARK CONSISTS OF STANDARD CHARACTERS WITHOUT CLAIM TO ANY PARTICULAR FONT, STYLE, SIZE, OR COLOR.

OWNER OF U.S. REG. NO. 3,312,137.
FOR DIETARY AND NUTRITIONAL SUPPLEMENTS (U.S. CLS. 6, 18, 44, 46, 51 AND 52).
MELVIN AXILBUND, EXAMINING ATTORNEY

CLASS 5—(Continued).

SN 77-179,357. AMSTERDAM MOLECULAR THERAPEUTICS (AMT) B.V., AMSTERDAM, NETHERLANDS, FILED 5-11-2007.

VECTIPRO

THE MARK CONSISTS OF STANDARD CHARACTERS WITHOUT CLAIM TO ANY PARTICULAR FONT, STYLE, SIZE, OR COLOR.

PRIORITY CLAIMED UNDER SEC. 44(D) ON ERPNCMNTY TM OFC APPLICATION NO. 005901277, FILED 5-1-2007.

OWNER OF ERPNCMNTY TM OFC REG. NO. 005901277, DATED 4-10-2008, EXPIRES 5-1-2017.

FOR BIOLOGICAL PREPARATIONS FOR USE IN MEDICAL AND CLINICAL GENE THERAPY AND CELL THERAPY; CLINICAL MEDICAL REAGENTS FOR USE IN GENE THERAPY, GENE DIAGNOSIS, AND GENE TESTING; PHARMACEUTICAL PREPARATIONS, NAMELY, VACCINES FOR USE IN GENE THERAPY; GENE THERAPY AND PROPHYLAXIS PRODUCTS, NAMELY, GENE DELIVERY, GENE TRANSFER, GENE REGULATION AND GENE MODULATION FOR THE TREATMENT OF METABOLIC DISORDERS, OCULAR DISORDERS, DISEASES OF THE NERVOUS SYSTEM, BLOOD DISORDERS, CANCER, INFLAMMATORY AND AUTO-IMMUNE DISEASES, VASCULAR DISORDERS, AND SINGLE GENE DISORDERS (U.S. CLS. 6, 18, 44, 46, 51 AND 52).

GINA HAYES, EXAMINING ATTORNEY

SN 77-186,788. RISING PHARMACEUTICALS, INC., ALLENDALE, NJ. FILED 5-22-2007.

RISING

THE MARK CONSISTS OF STANDARD CHARACTERS WITHOUT CLAIM TO ANY PARTICULAR FONT, STYLE, SIZE, OR COLOR.

FOR PHARMACEUTICAL PREPARATIONS FOR THE TREATMENT OF DISEASES OF THE CENTRAL NERVOUS, CARDIOVASCULAR, GASTROINTESTINAL AND UPPER RESPIRATORY SYSTEMS AS WELL AS ALLERGIES, KIDNEY AND GALLSTONES, GOUT AND METABOLIC DISEASE; TOPICAL PREPARATIONS FOR THE TREATMENT OF A VARIETY OF SKIN IRRITATIONS AND SKIN DISEASES; ANTISEPTIC OINTMENT AND SKIN PROTECTANT; ANTI-ITCH CREAM; ANTI-INFLAMMATORY OINTMENT; DIETARY SUPPLEMENTS; NUTRITIONAL SUPPLEMENTS; ALLERGY MEDICATION; MULTI-VITAMIN PREPARATIONS; VITAMIN AND MINERAL SUPPLEMENTS; MEDICATED DIAPER RASH OINTMENT; ANTI-CAVITY DENTAL COATING PREPARATIONS CONTAINING FLUORIDE (U.S. CLS. 6, 18, 44, 46, 51 AND 52).

FIRST USE 6-24-2004; IN COMMERCE 6-24-2004.
ANNE E. GUSTASON, EXAMINING ATTORNEY

CLASS 5—(Continued).

SN 77-191,975. AUTHENTA NATURAL PRODUCTS INC., WESTBANK, CANADA, FILED 5-29-2007.

AUTHENTA



PRIORITY CLAIMED UNDER SEC. 44(D) ON CANADA APPLICATION NO. 1347115, FILED 5-11-2007, REG. NO. TMA724883, DATED 10-1-2008, EXPIRES 10-1-2023.

THE MARK CONSISTS OF "AUTHENTA" AND DESIGN. FOR MEDICATED, NATURALLY SOURCED SKIN CREAMS AND SKIN LOTIONS FOR THERAPEUTIC TOPICAL APPLICATIONS; NUTRITIONAL SUPPLEMENTS, VITAMINS, MINERALS AND ANTI-OXIDANTS IN LIQUID AND CREAM FORMS FOR ORAL AND TOPICAL DOSAGE; ANALGESICS IN LIQUID AND CREAM FORMS FOR ORAL AND TOPICAL DOSAGE; MEDICINAL HERB EXTRACTS IN LIQUID AND CREAM FORMS FOR ORAL AND TOPICAL DOSAGE (U.S. CLS. 6, 18, 44, 46, 51 AND 52).

ANTHONY RINKER, EXAMINING ATTORNEY

SN 77-254,507. CADISTA PHAMACEUTICALS, INC., DBA JUBILANT PHARMACEUTICALS, INC., SALISBURY, MD. FILED 8-14-2007.



THE TERM "CADISTA" HAS NO MEANING IN A FOREIGN LANGUAGE.

FOR PHARMACEUTICALS, NAMELY, PHARMACEUTICAL PREPARATIONS FOR USE IN PREVENTING AND TREATING CONDITIONS, DISEASES, AND DISORDERS OF THE CARDIOVASCULAR, CENTRAL NERVOUS, DERMATOLOGIC, ENDOCRINE, GASTRIC AND GASTROENTERIC, HEMATOLOGIC, IMMUNOLOGIC, INFLAMMATORY, OSTEOLOGIC, AND RESPIRATORY SYSTEMS; PHARMACEUTICAL PREPARATIONS FOR USE IN PREVENTION AND TREATMENT OF ALLERGIES AND ALLERGIC RESPONSES, METABOLIC DISORDERS, PSYCHIATRIC AND EMOTIONAL DISORDERS, INFECTION AND INFECTIOUS DISEASES, AND PAIN (U.S. CLS. 6, 18, 44, 46, 51 AND 52).

FIRST USE 4-1-2007; IN COMMERCE 4-13-2007.
TOBY BULLOFF, EXAMINING ATTORNEY

CLASS 5—(Continued).

SN 77-301,523. INSENSE LIMITED, BEDFORD, GREAT BRITAIN, FILED 10-11-2007.

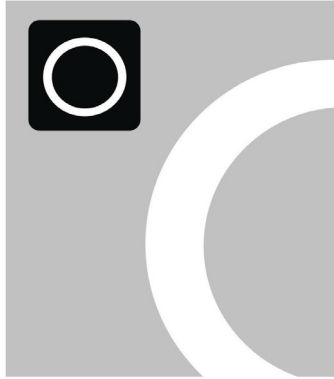

PRIORITY CLAIMED UNDER SEC. 44(D) ON ERPN CMNTY TM OFC APPLICATION NO. 000707690-00, FILED 4-12-2007.

THE MARK CONSISTS OF THE DESIGN OF A SQUARE. WITHIN THE UPPER LEFT CORNER OF THE SQUARE IS A DARKER SQUARE. WITHIN THAT DARKER SQUARE IS THE OUTLINE OF A CIRCLE. THE LOWER RIGHT CORNER OF THE LIGHTER SQUARE CONTAINS THE OUTLINE OF A SEMI-CIRCLE.

FOR DRESSINGS FOR WOUNDS, BURNS, ULCERS AND SURGERY (U.S. CLS. 6, 18, 44, 46, 51 AND 52).
MARILYN IZZI, EXAMINING ATTORNEY

CLASS 5—(Continued).

SN 77-376,068. QUERCEGEN PHARMA LLC, NEWTON, MA. FILED 1-19-2008.

QU 995 THE PUREST QUERCETIN

THE MARK CONSISTS OF STANDARD CHARACTERS WITHOUT CLAIM TO ANY PARTICULAR FONT, STYLE, SIZE, OR COLOR.

OWNER OF U.S. REG. NO. 3,395,876.
NO CLAIM IS MADE TO THE EXCLUSIVE RIGHT TO USE "THE PUREST QUERCETIN", APART FROM THE MARK AS SHOWN.

FOR NUTRITIONAL ADDITIVES TO FOODSTUFFS FOR ANIMALS FOR NUTRITIONAL PURPOSES; NUTRITIONAL ADDITIVES FOR NUTRITIONAL USE IN FOODS, BEVERAGES AND DIETARY SUPPLEMENTS FOR HUMAN CONSUMPTION; NUTRITIONAL PRODUCTS, NAMELY, NUTRITIONALLY FORTIFIED BEVERAGES AND NUTRITIONAL ENERGY BARS FOR USE AS A MEAL SUBSTITUTE AND NUTRITIONAL SUPPLEMENTS, ALL OF THE FOREGOING CONTAINING QUERCETIN (U.S. CLS. 6, 18, 44, 46, 51 AND 52).
STEPHEN AQUILA, EXAMINING ATTORNEY

SN 77-352,301. GREEN PLANET, INC., LOS ANGELES, CA. FILED 12-14-2007.



NO CLAIM IS MADE TO THE EXCLUSIVE RIGHT TO USE "HERBAL" AND "ENERGY DRINK", APART FROM THE MARK AS SHOWN.

THE MARK CONSISTS OF THE STYLIZED WORDS "HERBAL JUMP START ENERGY DRINK" WITH "HERBAL" IN CAPITAL LETTERS AND OUTLINED ABOVE "JUMP" AND THAT ABOVE "START", WITH "ENERGY DRINK" BELOW THAT IN CAPITAL LETTER AND OUTLINED.

FOR DIETARY SUPPLEMENTAL DRINKS (U.S. CLS. 6, 18, 44, 46, 51 AND 52).
FIRST USE 1-15-2005; IN COMMERCE 1-15-2005.
PAM WILLIS, EXAMINING ATTORNEY

SN 77-387,427. EYESCIENCE LABS, LLC, COLUMBUS, OH. FILED 2-4-2008.

EYESCIENCE

THE MARK CONSISTS OF STANDARD CHARACTERS WITHOUT CLAIM TO ANY PARTICULAR FONT, STYLE, SIZE, OR COLOR.

FOR VITAMINS AND VITAMIN PREPARATIONS, DIETARY AND NUTRITIONAL SUPPLEMENTS BASED ON COMBINATIONS OF VITAMINS, MINERALS, MINERAL NUTRIENTS, HERBAL EXTRACTS, HERBS IN DRIED OR PRESERVED FORMS, NUTRITIONAL OILS, FATTY ACIDS, AND AMINO ACIDS FOR THE PREVENTION AND TREATMENT OF OCULAR DISORDERS OR DISEASES AND NOT FOR COSMETIC PURPOSES (U.S. CLS. 6, 18, 44, 46, 51 AND 52).
FIRST USE 1-4-2008; IN COMMERCE 1-4-2008.

LOURDES AYALA, EXAMINING ATTORNEY

CLASS 5—(Continued).

SN 77-387,428. EYESCIENCE LABS, LLC, COLUMBUS, OH. FILED 2-4-2008.

EYESCIENCE MACULAR HEALTH
FORMULA

THE MARK CONSISTS OF STANDARD CHARACTERS WITHOUT CLAIM TO ANY PARTICULAR FONT, STYLE, SIZE, OR COLOR.

NO CLAIM IS MADE TO THE EXCLUSIVE RIGHT TO USE "MACULAR HEALTH FORMULA", APART FROM THE MARK AS SHOWN.

FOR VITAMINS AND VITAMIN PREPARATIONS, DIETARY AND NUTRITIONAL SUPPLEMENTS BASED ON COMBINATIONS OF VITAMINS, MINERALS, MINERAL NUTRIENTS, HERBAL EXTRACTS, HERBS IN DRIED OR PRESERVED FORMS, NUTRITIONAL OILS, FATTY ACIDS, AND AMINO ACIDS FOR THE PREVENTION AND TREATMENT OF OCULAR DISORDERS OR DISEASES AND NOT FOR COSMETIC PURPOSES (U.S. CLS. 6, 18, 44, 46, 51 AND 52).

FIRST USE 1-4-2008; IN COMMERCE 1-4-2008.
LOURDES AYALA, EXAMINING ATTORNEY

CLASS 5—(Continued).

SN 77-389,091. EYESCIENCE LABS, LLC, COLUMBUS, OH. FILED 2-5-2008.



THE MARK CONSISTS OF THREE EQUIDISTANT LINES IN ARC SHAPE, COUPLED AT EACH END WITH THE MIRROR IMAGE OF THREE EQUIDISTANT LINES IN ARC SHAPE, TOGETHER FORMING AN EYE-LIKE DESIGN WITH LEFT-TO-RIGHT PROGRESSIVE SHADING OF LINES, WITH SAID EYE-SHAPED DESIGN CENTERED ABOVE THE WORD "EYESCIENCE".

FOR VITAMINS AND VITAMIN PREPARATIONS, DIETARY AND NUTRITIONAL SUPPLEMENTS BASED ON COMBINATIONS OF VITAMINS, MINERALS, MINERAL NUTRIENTS, HERBAL EXTRACTS, HERBS IN DRIED OR PRESERVED FORMS, NUTRITIONAL OILS, FATTY ACIDS, AND AMINO ACIDS FOR THE PREVENTION AND TREATMENT OF OCULAR DISORDERS OR DISEASES AND NOT FOR COSMETIC PURPOSES (U.S. CLS. 6, 18, 44, 46, 51 AND 52).

FIRST USE 1-4-2008; IN COMMERCE 1-4-2008.
LOURDES AYALA, EXAMINING ATTORNEY

SN 77-388,498. PERFORMANCE HERBAL PRODUCTS LIMITED, ELLERSLIE, AUCKLAND, NEW ZEALAND, FILED 2-5-2008.

DURAZEST

THE MARK CONSISTS OF STANDARD CHARACTERS WITHOUT CLAIM TO ANY PARTICULAR FONT, STYLE, SIZE, OR COLOR.

PRIORITY CLAIMED UNDER SEC. 44(D) ON NEW ZEALAND APPLICATION NO. 773697, FILED 8-10-2007, REG. NO. 773697, DATED 8-10-2007, EXPIRES 8-10-2017.

FOR (BASED ON SECTIONS 1(A) AND 44(E)) HERBAL SUPPLEMENTS TO IMPROVE THE SEXUAL PERFORMANCE AND ERECTILE FUNCTION OF MEN; (BASED ON SECTIONS 1(B) AND 44(E)) HERBAL SUPPLEMENTS TO IMPROVE THE SEXUAL PERFORMANCE OF WOMEN (U.S. CLS. 6, 18, 44, 46, 51 AND 52).

FIRST USE 12-0-2003; IN COMMERCE 4-0-2006.
AMOS T. MATTHEWS, JR., EXAMINING ATTORNEY

SN 77-398,575. CELLTRAFFIX INC., PITTSFORD, NY. FILED 2-15-2008.

CELL SELECT

THE MARK CONSISTS OF STANDARD CHARACTERS WITHOUT CLAIM TO ANY PARTICULAR FONT, STYLE, SIZE, OR COLOR.

NO CLAIM IS MADE TO THE EXCLUSIVE RIGHT TO USE "CELL", APART FROM THE MARK AS SHOWN.

FOR PROTEINS AND OTHER POLYPEPTIDES, NAMELY, SINGLE-CHAIN TRANSMEMBRANE GLYCOPROTEINS THAT BIND SUGAR POLYMERS FOR USE WITH MEDICAL DEVICES AND KITS FOR MODIFYING, COLLECTING, OR ELIMINATING SPECIFIC CELLS FROM THE BLOOD AND/OR OTHER BODY FLUIDS, NAMELY, SINGLE-CHAIN TRANSMEMBRANE GLYCOPROTEINS THAT BIND SUGAR POLYMERS FOR USE WITH DEVICES FOR MODIFYING, COLLECTING, OR ELIMINATING TUMOR CELLS, CANCER CELLS, ADULT STEM CELLS, AND/OR IMMUNOLOGICAL CELLS FROM THE BLOOD AND/OR OTHER BODY FLUIDS (U.S. CLS. 6, 18, 44, 46, 51 AND 52).

HENRY S. ZAK, EXAMINING ATTORNEY

CLASS 5—(Continued).

SN 77-401,451. GLENMARK PHARMACEUTICALS INC.,
USA, MAHWAH, NJ. FILED 2-20-2008.

Glenmark Generics Inc., USA

THE MARK CONSISTS OF STANDARD CHARACTERS WITHOUT CLAIM TO ANY PARTICULAR FONT, STYLE, SIZE, OR COLOR.

OWNER OF U.S. REG. NO. 3,146,215.

NO CLAIM IS MADE TO THE EXCLUSIVE RIGHT TO USE "GENERICS INC., USA", APART FROM THE MARK AS SHOWN.

FOR PHARMACEUTICAL FOR THE TREATMENT OF ERECTILE DYSFUNCTION; PHARMACEUTICAL PREPARATION FOR THE TREATMENT OF GOUT; PHARMACEUTICAL PREPARATIONS ACTING ON THE CENTRAL NERVOUS SYSTEM; PHARMACEUTICAL PREPARATIONS AND SUBSTANCES FOR THE TREATMENT OF GASTRO-INTESTINAL DISEASES; PHARMACEUTICAL PREPARATIONS FOR SKIN CARE; PHARMACEUTICAL PREPARATIONS FOR THE PREVENTION AND TREATMENT OF DISORDERS OF THE NERVOUS SYSTEM, THE IMMUNE SYSTEM, THE CARDIO-VASCULAR SYSTEM, THE METABOLIC SYSTEM, THE RESPIRATORY SYSTEM, THE MUSCULO-SKELETAL SYSTEM, THE GENITOURINARY SYSTEM; FOR THE TREATMENT OF INFLAMMATORY DISORDERS; FOR USE IN DERMATOLOGY, ONCOLOGY, HEMATOLOGY AND IN TISSUE AND ORGAN TRANSPLANTATION, IN OPHTHALMOLOGY AND FOR GASTROENTEROLOGICAL DISORDERS; PHARMACEUTICAL PREPARATIONS FOR THE PREVENTION AND TREATMENT OF OCULAR DISORDERS OR DISEASES, FOR THE TREATMENT OF BACTERIA-BASED DISEASES, AND FOR THE TREATMENT OF DIABETES, AND ANTI-INFECTIVE PREPARATIONS, ANTIVIRAL PREPARATIONS, ANTIBIOTICS, ANTI-FUNGAL PREPARATIONS AND VACCINES; PHARMACEUTICAL PREPARATIONS FOR THE TREATMENT OF HEART RHYTHM DISORDERS; PHARMACEUTICAL PREPARATIONS FOR THE TREATMENT OF HORMONAL DISORDERS AND THE PREVENTION OF OSTEOPOROSIS; PHARMACEUTICAL PREPARATIONS FOR THE TREATMENT OF INFECTIOUS DISEASES; PHARMACEUTICAL PREPARATIONS FOR TREATING ALLERGIC RHINITIS AND ASTHMA; PHARMACEUTICAL PREPARATIONS FOR TREATING DIABETES; PHARMACEUTICAL PREPARATIONS FOR TREATING SKIN DISORDERS; PHARMACEUTICAL PREPARATIONS FOR USE IN DERMATOLOGY; PHARMACEUTICAL PREPARATIONS FOR USE IN UROLOGY; PHARMACEUTICAL PREPARATIONS, NAMELY, ANTIDEPRESSANTS; PHARMACEUTICAL PREPARATIONS, NAMELY, APPETITE SUPPRESSANTS; PHARMACEUTICAL PRODUCTS AND PREPARATIONS AGAINST DRY SKIN CAUSED BY PREGNANCY; PHARMACEUTICAL PRODUCTS AND PREPARATIONS FOR CHLOASMA; PHARMACEUTICAL PRODUCTS AND PREPARATIONS FOR HYDRATING THE SKIN DURING PREGNANCY; PHARMACEUTICAL PRODUCTS AND PREPARATIONS FOR PREGNANCY BLEMISHES; PHARMACEUTICAL PRODUCTS AND PREPARATIONS FOR PREVENTING SKIN BLEMISHES DURING PREGNANCY; PHARMACEUTICAL PRODUCTS AND PREPARATIONS TO PREVENT STRETCH MARKS; PHARMACEUTICAL PRODUCTS AND PREPARATIONS TO PREVENT SWELLING IN THE LEGS; PHARMACEUTICAL PRODUCTS FOR OPHTHALMOLOGICAL USE; PHARMACEUTICAL PRODUCTS FOR SKIN CARE FOR ANIMALS; PHARMACEUTICAL PRODUCTS FOR THE TREATMENT OF BONE DISEASES; PHARMACEUTICAL PRODUCTS FOR THE TREATMENT OF JOINT DISEASE; PHARMACEUTICAL PRODUCTS FOR THE TREATMENT OF VIRAL AND INFECTIOUS DISEASES, FOR THE TREATMENT OF CANCER; PHARMACEUTICAL PRODUCTS FOR TREATING RESPIRATORY DISEASES AND ASTHMA; PHARMACEUTICAL SKIN LOTIONS; PHARMACEUTICAL SOLUTIONS USED IN DIALYSIS; PHARMACEUTICALS FOR THE TREATMENT OF ERECTILE

CLASS 5—(Continued).

DYSFUNCTION; PHARMACEUTICALS, NAMELY, ANTI-INFECTIVES; PHARMACEUTICALS, NAMELY, ANTIHELMINTICS; PHARMACEUTICALS, NAMELY, INDUCERS OF ERECTIONS; PHARMACEUTICALS, NAMELY, LIPID LOWERING AGENTS; PHARMACEUTICAL PREPARATIONS FOR THE TREATMENT OF EYE DISEASES AND CONDITIONS; PHARMACEUTICAL PREPARATIONS FOR USE IN CHEMOTHERAPY; PHARMACEUTICAL PREPARATIONS FOR WOUNDS; PHARMACEUTICAL PREPARATIONS, NAMELY, A BLOOD CLOTTING AID AND DELIVERY SYSTEM FOR USE IN HUMAN AND VETERINARY MEDICINE; PHARMACEUTICAL PREPARATIONS, NAMELY, A DRUG DELIVERY SYSTEM COMPRISING POLYMER-BASED ORAL TABLETS FOR THE CONTINUOUS RELEASE OF A WIDE VARIETY OF THERAPEUTIC AGENTS; PHARMACEUTICAL PREPARATIONS, NAMELY, ANTICOAGULANTS; PHARMACEUTICAL PREPARATIONS FOR INHALATION FOR THE TREATMENT OF PULMONARY HYPERTENSION; PREPARATION FOR THE RELIEF OF PAIN; OPIUM ALKALOID PREPARATIONS; PHARMACEUTICAL ANTI-ALLERGIC PREPARATIONS AND SUBSTANCES; PHARMACEUTICAL ANTITUSSIVE-COLD PREPARATIONS (U.S. CLS. 6, 18, 44, 46, 51 AND 52).

JULIE WATSON, EXAMINING ATTORNEY

SN 77-401,483. GLENMARK PHARMACEUTICALS INC.,
USA, MAHWAH, NJ. FILED 2-20-2008.

Glenmark Generics

THE MARK CONSISTS OF STANDARD CHARACTERS WITHOUT CLAIM TO ANY PARTICULAR FONT, STYLE, SIZE, OR COLOR.

OWNER OF U.S. REG. NO. 3,146,215.

NO CLAIM IS MADE TO THE EXCLUSIVE RIGHT TO USE "GENERICS", APART FROM THE MARK AS SHOWN.

FOR OPIUM ALKALOID PREPARATIONS; PHARMACEUTICAL ANTI-ALLERGIC PREPARATIONS AND SUBSTANCES; PHARMACEUTICAL ANTITUSSIVE-COLD PREPARATIONS; PHARMACEUTICAL FOR THE TREATMENT OF ERECTILE DYSFUNCTION; PHARMACEUTICAL PREPARATION FOR THE TREATMENT OF GOUT; PHARMACEUTICAL PREPARATIONS ACTING ON THE CENTRAL NERVOUS SYSTEM; PHARMACEUTICAL PREPARATIONS AND SUBSTANCES FOR THE TREATMENT OF GASTRO-INTESTINAL DISEASES; PHARMACEUTICAL PREPARATIONS FOR ANIMAL SKIN CARE; PHARMACEUTICAL PREPARATIONS FOR INHALATION FOR THE TREATMENT OF PULMONARY HYPERTENSION; PHARMACEUTICAL PREPARATIONS FOR SKIN CARE; PHARMACEUTICAL PREPARATIONS FOR THE PREVENTION AND TREATMENT OF DISORDERS OF THE NERVOUS SYSTEM, THE IMMUNE SYSTEM, THE CARDIO-VASCULAR SYSTEM, THE METABOLIC SYSTEM, THE RESPIRATORY SYSTEM, THE MUSCULO-SKELETAL SYSTEM, THE GENITOURINARY SYSTEM; FOR THE TREATMENT OF INFLAMMATORY DISORDERS; FOR USE IN DERMATOLOGY, ONCOLOGY, HEMATOLOGY AND IN TISSUE AND ORGAN TRANSPLANTATION, IN OPHTHALMOLOGY AND FOR GASTROENTEROLOGICAL DISORDERS; PHARMACEUTICAL PREPARATIONS FOR THE PREVENTION AND TREATMENT OF OCULAR DISORDERS OR DISEASES, FOR THE TREATMENT OF BACTERIA-BASED DISEASES, AND FOR THE TREATMENT OF DIABETES, AND ANTI-INFECTIVE PREPARATIONS, ANTIVIRAL PREPARATIONS, ANTIBIOTICS, ANTI-FUNGAL PREPARATIONS AND VACCINES; PHARMACEUTICAL PREPARATIONS FOR THE TREATMENT OF EYE DISEASES AND CONDITIONS; PHARMACEUTICAL PREPARATIONS FOR THE TREATMENT OF HEART RHYTHM DISORDERS; PHARMACEUTICAL

CLASS 5—(Continued).

PREPARATIONS FOR THE TREATMENT OF HORMONAL DISORDERS AND THE PREVENTION OF OSTEOPOROSIS; PHARMACEUTICAL PREPARATIONS FOR THE TREATMENT OF INFECTIOUS DISEASES; PHARMACEUTICAL PREPARATIONS FOR TREATING ALLERGIC RHINITIS AND ASTHMA; PHARMACEUTICAL PREPARATIONS FOR TREATING DIABETES; PHARMACEUTICAL PREPARATIONS FOR TREATING SKIN DISORDERS; PHARMACEUTICAL PREPARATIONS FOR USE IN CHEMOTHERAPY; PHARMACEUTICAL PREPARATIONS FOR USE IN DERMATOLOGY; PHARMACEUTICAL PREPARATIONS FOR USE IN UROLOGY; PHARMACEUTICAL PREPARATIONS FOR WOUNDS; PHARMACEUTICAL PREPARATIONS, NAMELY, ANTIDEPRESSANTS; PHARMACEUTICAL PREPARATIONS, NAMELY, APPETITE SUPPRESSANTS; PHARMACEUTICAL PREPARATIONS, NAMELY, A BLOOD CLOTTING AID AND DELIVERY SYSTEM FOR USE IN HUMAN AND VETERINARY MEDICINE; PHARMACEUTICAL PREPARATIONS, NAMELY, A DRUG DELIVERY SYSTEM COMPRISING POLYMER-BASED ORAL TABLETS FOR THE CONTINUOUS RELEASE OF A WIDE VARIETY OF THERAPEUTIC AGENTS; PHARMACEUTICAL PREPARATIONS, NAMELY, ANTICOAGULANTS; PHARMACEUTICAL PRODUCTS AND PREPARATIONS AGAINST DRY SKIN CAUSED BY PREGNANCY; PHARMACEUTICAL PRODUCTS AND PREPARATIONS FOR CHLOASMA; PHARMACEUTICAL PRODUCTS AND PREPARATIONS FOR HYDRATING THE SKIN DURING PREGNANCY; PHARMACEUTICAL PRODUCTS AND PREPARATIONS FOR PREGNANCY BLEMISHES; PHARMACEUTICAL PRODUCTS AND PREPARATIONS FOR PREVENTING SKIN BLEMISHES DURING PREGNANCY; PHARMACEUTICAL PRODUCTS AND PREPARATIONS TO PREVENT STRETCH MARKS; PHARMACEUTICAL PRODUCTS AND PREPARATIONS TO PREVENT SWELLING IN THE LEGS; PHARMACEUTICAL PRODUCTS FOR OPHTHALMOLOGICAL USE; PHARMACEUTICAL PRODUCTS FOR SKIN CARE FOR ANIMALS; PHARMACEUTICAL PRODUCTS FOR THE TREATMENT OF BONE DISEASES; PHARMACEUTICAL PRODUCTS FOR THE TREATMENT OF JOINT DISEASE; PHARMACEUTICAL PRODUCTS FOR THE TREATMENT OF VIRAL AND INFECTIOUS DISEASES, FOR THE TREATMENT OF CANCER; PHARMACEUTICAL PRODUCTS FOR TREATING RESPIRATORY DISEASES AND ASTHMA; PHARMACEUTICAL SKIN LOTIONS; PHARMACEUTICAL SOLUTIONS USED IN DIALYSIS; PHARMACEUTICALS FOR THE TREATMENT OF ERECTILE DYSFUNCTION; PHARMACEUTICALS, NAMELY, ANTI-INFECTIVES; PHARMACEUTICALS, NAMELY, ANTIHELMINTICS; PHARMACEUTICALS, NAMELY, INDUCERS OF ERECTIONS; PHARMACEUTICALS, NAMELY, LIPID LOWERING AGENTS; PREPARATION FOR THE RELIEF OF PAIN; PREPARATIONS FOR THE TREATMENT OF ASTHMA (U.S. CLS. 6, 18, 44, 46, 51 AND 52).

JULIE WATSON, EXAMINING ATTORNEY

CLASS 5—(Continued).

SN 77-401,495. GLENMARK PHARMACEUTICALS INC., USA, MAHWAH, NJ. FILED 2-20-2008.

Glenmark Generics Ltd.

THE MARK CONSISTS OF STANDARD CHARACTERS WITHOUT CLAIM TO ANY PARTICULAR FONT, STYLE, SIZE, OR COLOR.

OWNER OF U.S. REG. NO. 3,146,215.

NO CLAIM IS MADE TO THE EXCLUSIVE RIGHT TO USE "GENERICS LTD.", APART FROM THE MARK AS SHOWN.

FOR OPIUM ALKALOID PREPARATIONS; PHARMACEUTICAL ANTI-ALLERGIC PREPARATIONS AND SUBSTANCES; PHARMACEUTICAL ANTITUSSIVE-COLD PREPARATIONS; PHARMACEUTICAL FOR THE TREATMENT OF ERECTILE DYSFUNCTION; PHARMACEUTICAL PREPARATION FOR THE TREATMENT OF GOUT; PHARMACEUTICAL PREPARATIONS ACTING ON THE CENTRAL NERVOUS SYSTEM; PHARMACEUTICAL PREPARATIONS AND SUBSTANCES FOR THE TREATMENT OF GASTRO-INTESTINAL DISEASES; PHARMACEUTICAL PREPARATIONS FOR INHALATION FOR THE TREATMENT OF PULMONARY HYPERTENSION; PHARMACEUTICAL PREPARATIONS FOR SKIN CARE; PHARMACEUTICAL PREPARATIONS FOR THE PREVENTION AND TREATMENT OF DISORDERS OF THE NERVOUS SYSTEM, THE IMMUNE SYSTEM, THE CARDIO-VASCULAR SYSTEM, THE METABOLIC SYSTEM, THE RESPIRATORY SYSTEM, THE MUSCULO-SKELETAL SYSTEM, THE GENITOURINARY SYSTEM; FOR THE TREATMENT OF INFLAMMATORY DISORDERS; FOR USE IN DERMATOLOGY, ONCOLOGY, HEMATOLOGY AND IN TISSUE AND ORGAN TRANSPLANTATION, IN OPHTHALMOLOGY AND FOR GASTROENTEROLOGICAL DISORDERS; PHARMACEUTICAL PREPARATIONS FOR THE PREVENTION AND TREATMENT OF OCULAR DISORDERS OR DISEASES, FOR THE TREATMENT OF BACTERIA-BASED DISEASES, AND FOR THE TREATMENT OF DIABETES, AND ANTI-INFECTIVE PREPARATIONS, ANTIVIRAL PREPARATIONS, ANTIBIOTICS, ANTI-FUNGAL PREPARATIONS AND VACCINES; PHARMACEUTICAL PREPARATIONS FOR THE TREATMENT OF EYE DISEASES AND CONDITIONS; PHARMACEUTICAL PREPARATIONS FOR THE TREATMENT OF HEART RHYTHM DISORDERS; PHARMACEUTICAL PREPARATIONS FOR THE TREATMENT OF HORMONAL DISORDERS AND THE PREVENTION OF OSTEOPOROSIS; PHARMACEUTICAL PREPARATIONS FOR THE TREATMENT OF INFECTIOUS DISEASES; PHARMACEUTICAL PREPARATIONS FOR TREATING ALLERGIC RHINITIS AND ASTHMA; PHARMACEUTICAL PREPARATIONS FOR TREATING DIABETES; PHARMACEUTICAL PREPARATIONS FOR TREATING SKIN DISORDERS; PHARMACEUTICAL PREPARATIONS FOR USE IN CHEMOTHERAPY; PHARMACEUTICAL PREPARATIONS FOR USE IN DERMATOLOGY; PHARMACEUTICAL PREPARATIONS FOR USE IN UROLOGY; PHARMACEUTICAL PREPARATIONS FOR WOUNDS; PHARMACEUTICAL PREPARATIONS, NAMELY, ANTIDEPRESSANTS; PHARMACEUTICAL PREPARATIONS, NAMELY, APPETITE SUPPRESSANTS; PHARMACEUTICAL PREPARATIONS, NAMELY, A BLOOD CLOTTING AID AND DELIVERY SYSTEM FOR USE IN HUMAN AND VETERINARY MEDICINE; PHARMACEUTICAL PREPARATIONS, NAMELY, A DRUG DELIVERY SYSTEM COMPRISING POLYMER-BASED ORAL TABLETS FOR THE CONTINUOUS RELEASE OF A WIDE VARIETY OF THERAPEUTIC AGENTS; PHARMACEUTICAL PREPARATIONS, NAMELY, ANTICOAGULANTS; PHARMACEUTICAL PRODUCTS AND PREPARATIONS AGAINST DRY SKIN CAUSED BY PREGNANCY; PHARMACEUTICAL PRODUCTS AND PREPARATIONS FOR CHLOASMA; PHARMACEUTICAL PRODUCTS AND PREPARATIONS FOR HYDRATING THE SKIN DURING PREGNANCY; PHARMACEUTICAL PRODUCTS AND PREPARATIONS FOR PREGNANCY BLEMISHES; PHARMACEUTICAL

CLASS 5—(Continued).

PRODUCTS AND PREPARATIONS FOR PREVENTING SKIN BLEMISHES DURING PREGNANCY; PHARMACEUTICAL PRODUCTS AND PREPARATIONS TO PREVENT STRETCH MARKS; PHARMACEUTICAL PRODUCTS AND PREPARATIONS TO PREVENT SWELLING IN THE LEGS; PHARMACEUTICAL PRODUCTS FOR OPHTHALMOLOGICAL USE; PHARMACEUTICAL PRODUCTS FOR SKIN CARE FOR ANIMALS; PHARMACEUTICAL PRODUCTS FOR THE TREATMENT OF BONE DISEASES; PHARMACEUTICAL PRODUCTS FOR THE TREATMENT OF JOINT DISEASE; PHARMACEUTICAL PRODUCTS FOR THE TREATMENT OF VIRAL AND INFECTIOUS DISEASES, FOR THE TREATMENT OF CANCER; PHARMACEUTICAL PRODUCTS FOR TREATING RESPIRATORY DISEASES AND ASTHMA; PHARMACEUTICAL SKIN LOTIONS; PHARMACEUTICAL SOLUTIONS USED IN DIALYSIS; PHARMACEUTICALS FOR THE TREATMENT OF ERECTILE DYSFUNCTION; PHARMACEUTICALS, NAMELY, ANTI-INFECTIVES; PHARMACEUTICALS, NAMELY, ANTIHELMINTICS; PHARMACEUTICALS, NAMELY, INDUCERS OF ERECTIONS; PHARMACEUTICALS, NAMELY, LIPID LOWERING AGENTS; PREPARATION FOR THE RELIEF OF PAIN (U.S. CLS. 6, 18, 44, 46, 51 AND 52).

JULIE WATSON, EXAMINING ATTORNEY

SN 77-401,634. GLENMARK PHARMACEUTICALS INC., USA, MAHWAH, NJ. FILED 2-20-2008.

Glenmark Therapeutics Inc., USA

THE MARK CONSISTS OF STANDARD CHARACTERS WITHOUT CLAIM TO ANY PARTICULAR FONT, STYLE, SIZE, OR COLOR.

OWNER OF U.S. REG. NO. 3,146,215.

NO CLAIM IS MADE TO THE EXCLUSIVE RIGHT TO USE "THERAPEUTICS INC., USA", APART FROM THE MARK AS SHOWN.

FOR PHARMACEUTICAL ANTI-ALLERGIC PREPARATIONS AND SUBSTANCES; PHARMACEUTICAL FOR THE TREATMENT OF ERECTILE DYSFUNCTION; PHARMACEUTICAL PREPARATION FOR THE TREATMENT OF GOUT; PHARMACEUTICAL PREPARATIONS ACTING ON THE CENTRAL NERVOUS SYSTEM; PHARMACEUTICAL PREPARATIONS AND SUBSTANCES FOR THE TREATMENT OF GASTRO-INTESTINAL DISEASES; PHARMACEUTICAL PREPARATIONS FOR INHALATION FOR THE TREATMENT OF PULMONARY HYPERTENSION; PHARMACEUTICAL PREPARATIONS FOR SKIN CARE; PHARMACEUTICAL PREPARATIONS FOR THE PREVENTION AND TREATMENT OF DISORDERS OF THE NERVOUS SYSTEM, THE IMMUNE SYSTEM, THE CARDIO-VASCULAR SYSTEM, THE METABOLIC SYSTEM, THE RESPIRATORY SYSTEM, THE MUSCULO-SKELETAL SYSTEM, THE GENITOURINARY SYSTEM; FOR THE TREATMENT OF INFLAMMATORY DISORDERS; FOR USE IN DERMATOLOGY, ONCOLOGY, HEMATOLOGY AND IN TISSUE AND ORGAN TRANSPLANTATION, IN OPHTHALMOLOGY AND FOR GASTROENTEROLOGICAL DISORDERS; PHARMACEUTICAL PREPARATIONS FOR THE PREVENTION AND TREATMENT OF OCULAR DISORDERS OR DISEASES, FOR THE TREATMENT OF BACTERIA-BASED DISEASES, AND FOR THE TREATMENT OF DIABETES, AND ANTI-INFECTIVE PREPARATIONS, ANTIVIRAL PREPARATIONS, ANTIBIOTICS, ANTIFUNGAL PREPARATIONS AND VACCINES; PHARMACEUTICAL PREPARATIONS FOR THE TREATMENT OF EYE DISEASES AND CONDITIONS; PHARMACEUTICAL PREPARATIONS FOR THE TREATMENT OF HEART RHYTHM DISORDERS; PHARMACEUTICAL PREPARATIONS FOR THE TREATMENT OF HORMONAL DISORDERS AND THE PREVENTION OF OSTEOPOROSIS; PHARMACEUTICAL

CLASS 5—(Continued).

PREPARATIONS FOR THE TREATMENT OF INFECTIOUS DISEASES; PHARMACEUTICAL PREPARATIONS FOR TREATING ALLERGIC RHINITIS AND ASTHMA; PHARMACEUTICAL PREPARATIONS FOR TREATING DIABETES; PHARMACEUTICAL PREPARATIONS FOR TREATING SKIN DISORDERS; PHARMACEUTICAL PREPARATIONS FOR USE IN CHEMOTHERAPY; PHARMACEUTICAL PREPARATIONS FOR USE IN DERMATOLOGY; PHARMACEUTICAL PREPARATIONS FOR USE IN UROLOGY; PHARMACEUTICAL PREPARATIONS FOR WOUNDS; PHARMACEUTICAL PREPARATIONS, NAMELY, ANTI-DEPRESSANTS; PHARMACEUTICAL PREPARATIONS, NAMELY, APPETITE SUPPRESSANTS; PHARMACEUTICAL PREPARATIONS, NAMELY, A BLOOD CLOTTING AID AND DELIVERY SYSTEM FOR USE IN HUMAN AND VETERINARY MEDICINE; PHARMACEUTICAL PREPARATIONS, NAMELY, A DRUG DELIVERY SYSTEM COMPRISING POLYMER-BASED ORAL TABLETS FOR THE CONTINUOUS RELEASE OF A WIDE VARIETY OF THERAPEUTIC AGENTS; PHARMACEUTICAL PREPARATIONS, NAMELY, ANTICOAGULANTS; PHARMACEUTICAL PRODUCTS AND PREPARATIONS AGAINST DRY SKIN CAUSED BY PREGNANCY; PHARMACEUTICAL PRODUCTS AND PREPARATIONS FOR CHLOASMA; PHARMACEUTICAL PRODUCTS AND PREPARATIONS FOR HYDRATING THE SKIN DURING PREGNANCY; PHARMACEUTICAL PRODUCTS AND PREPARATIONS FOR PREGNANCY BLEMISHES; PHARMACEUTICAL PRODUCTS AND PREPARATIONS FOR PREVENTING SKIN BLEMISHES DURING PREGNANCY; PHARMACEUTICAL PRODUCTS AND PREPARATIONS TO PREVENT STRETCH MARKS; PHARMACEUTICAL PRODUCTS AND PREPARATIONS TO PREVENT SWELLING IN THE LEGS; PHARMACEUTICAL PRODUCTS FOR OPHTHALMOLOGICAL USE; PHARMACEUTICAL PRODUCTS FOR SKIN CARE FOR ANIMALS; PHARMACEUTICAL PRODUCTS FOR THE TREATMENT OF BONE DISEASES; PHARMACEUTICAL PRODUCTS FOR THE TREATMENT OF JOINT DISEASE; PHARMACEUTICAL PRODUCTS FOR THE TREATMENT OF VIRAL AND INFECTIOUS DISEASES, FOR THE TREATMENT OF CANCER; PHARMACEUTICAL PRODUCTS FOR TREATING RESPIRATORY DISEASES AND ASTHMA; PHARMACEUTICAL SKIN LOTIONS; PHARMACEUTICAL SOLUTIONS USED IN DIALYSIS; PHARMACEUTICALS FOR THE TREATMENT OF ERECTILE DYSFUNCTION; PHARMACEUTICALS, NAMELY, ANTI-INFECTIVES; PHARMACEUTICALS, NAMELY, ANTIHELMINTICS; PHARMACEUTICALS, NAMELY, INDUCERS OF ERECTIONS; PHARMACEUTICALS, NAMELY, LIPID LOWERING AGENTS; PREPARATION FOR THE RELIEF OF PAIN (U.S. CLS. 6, 18, 44, 46, 51 AND 52).

JULIE WATSON, EXAMINING ATTORNEY

CLASS 5—(Continued).

SN 77-401,648. GLENMARK PHARMACEUTICALS INC.,
USA, MAHWAH, NJ. FILED 2-20-2008.

Glenmark Therapeutics

THE MARK CONSISTS OF STANDARD CHARACTERS WITHOUT CLAIM TO ANY PARTICULAR FONT, STYLE, SIZE, OR COLOR.

OWNER OF U.S. REG. NO. 3,146,215.

NO CLAIM IS MADE TO THE EXCLUSIVE RIGHT TO USE "THERAPEUTICS", APART FROM THE MARK AS SHOWN.

FOR PHARMACEUTICAL ANTI-ALLERGIC PREPARATIONS AND SUBSTANCES; PHARMACEUTICAL ANTITUSSIVE-COLD PREPARATIONS; PHARMACEUTICAL FOR THE TREATMENT OF ERECTILE DYSFUNCTION; PHARMACEUTICAL PREPARATION FOR THE TREATMENT OF GOUT; PHARMACEUTICAL PREPARATIONS ACTING ON THE CENTRAL NERVOUS SYSTEM; PHARMACEUTICAL PREPARATIONS AND SUBSTANCES FOR THE TREATMENT OF GASTRO-INTESTINAL DISEASES; PHARMACEUTICAL PREPARATIONS FOR INHALATION FOR THE TREATMENT OF PULMONARY HYPERTENSION; PHARMACEUTICAL PREPARATIONS FOR SKIN CARE; PHARMACEUTICAL PREPARATIONS FOR THE PREVENTION AND TREATMENT OF DISORDERS OF THE NERVOUS SYSTEM, THE IMMUNE SYSTEM, THE CARDIO-VASCULAR SYSTEM, THE METABOLIC SYSTEM, THE RESPIRATORY SYSTEM, THE MUSCULOSKELETAL SYSTEM, THE GENITOURINARY SYSTEM; FOR THE TREATMENT OF INFLAMMATORY DISORDERS; FOR USE IN DERMATOLOGY, ONCOLOGY, HEMATOLOGY AND IN TISSUE AND ORGAN TRANSPLANTATION, IN OPHTHALMOLOGY AND FOR GASTROENTEROLOGICAL DISORDERS; PHARMACEUTICAL PREPARATIONS FOR THE PREVENTION AND TREATMENT OF OCULAR DISORDERS OR DISEASES, FOR THE TREATMENT OF BACTERIA-BASED DISEASES, AND FOR THE TREATMENT OF DIABETES, AND ANTI-INFECTIVE PREPARATIONS, ANTIVIRAL PREPARATIONS, ANTIBIOTICS, ANTIFUNGAL PREPARATIONS AND VACCINES; PHARMACEUTICAL PREPARATIONS FOR THE TREATMENT OF EYE DISEASES AND CONDITIONS; PHARMACEUTICAL PREPARATIONS FOR THE TREATMENT OF HEART RHYTHM DISORDERS; PHARMACEUTICAL PREPARATIONS FOR THE TREATMENT OF HORMONAL DISORDERS AND THE PREVENTION OF OSTEOPOROSIS; PHARMACEUTICAL PREPARATIONS FOR THE TREATMENT OF INFECTIOUS DISEASES; PHARMACEUTICAL PREPARATIONS FOR TREATING ALLERGIC RHINITIS AND ASTHMA; PHARMACEUTICAL PREPARATIONS FOR TREATING DIABETES; PHARMACEUTICAL PREPARATIONS FOR TREATING SKIN DISORDERS; PHARMACEUTICAL PREPARATIONS FOR USE IN CHEMOTHERAPY; PHARMACEUTICAL PREPARATIONS FOR USE IN DERMATOLOGY; PHARMACEUTICAL PREPARATIONS FOR USE IN UROLOGY; PHARMACEUTICAL PREPARATIONS FOR WOUNDS; PHARMACEUTICAL PREPARATIONS, NAMELY, ANTIDEPRESSANTS; PHARMACEUTICAL PREPARATIONS, NAMELY, APPETITE SUPPRESSANTS; PHARMACEUTICAL PREPARATIONS, NAMELY, A BLOOD CLOTTING AID AND DELIVERY SYSTEM FOR USE IN HUMAN AND VETERINARY MEDICINE; PHARMACEUTICAL PREPARATIONS, NAMELY, A DRUG DELIVERY SYSTEM COMPRISING POLYMER-BASED ORAL TABLETS FOR THE CONTINUOUS RELEASE OF A WIDE VARIETY OF THERAPEUTIC AGENTS; PHARMACEUTICAL PREPARATIONS, NAMELY, ANTICOAGULANTS; PHARMACEUTICAL PRODUCTS AND PREPARATIONS AGAINST DRY SKIN CAUSED BY PREGNANCY; PHARMACEUTICAL PRODUCTS AND PREPARATIONS FOR CHLOASMA; PHARMACEUTICAL PRODUCTS AND PREPARATIONS FOR HYDRATING THE SKIN DURING PREGNANCY; PHARMACEUTICAL PRODUCTS AND PREPARATIONS FOR PREGNANCY BLEMISHES; PHARMACEUTICAL

CLASS 5—(Continued).

PRODUCTS AND PREPARATIONS FOR PREVENTING SKIN BLEMISHES DURING PREGNANCY; PHARMACEUTICAL PRODUCTS AND PREPARATIONS TO PREVENT STRETCH MARKS; PHARMACEUTICAL PRODUCTS AND PREPARATIONS TO PREVENT SWELLING IN THE LEGS; PHARMACEUTICAL PRODUCTS FOR OPHTHALMOLOGICAL USE; PHARMACEUTICAL PRODUCTS FOR THE TREATMENT OF BONE DISEASES; PHARMACEUTICAL PRODUCTS FOR THE TREATMENT OF JOINT DISEASE; PHARMACEUTICAL PRODUCTS FOR THE TREATMENT OF VIRAL AND INFECTIOUS DISEASES, FOR THE TREATMENT OF CANCER; PHARMACEUTICAL PRODUCTS FOR TREATING RESPIRATORY DISEASES AND ASTHMA; PHARMACEUTICAL SKIN LOTIONS; PHARMACEUTICALS FOR THE TREATMENT OF ERECTILE DYSFUNCTION; PHARMACEUTICALS, NAMELY, ANTI-INFECTIVES; PHARMACEUTICALS, NAMELY, ANTI-HELMINTICS; PHARMACEUTICALS, NAMELY, INDUCERS OF ERECTIONS; PHARMACEUTICALS, NAMELY, LIPID LOWERING AGENTS; PREPARATION FOR THE RELIEF OF PAIN (U.S. CLS. 6, 18, 44, 46, 51 AND 52).

JULIE WATSON, EXAMINING ATTORNEY

SN 77-405,832. JOHNSON & JOHNSON, NEW BRUNSWICK,
NJ. FILED 2-26-2008.

BENADROPS

THE MARK CONSISTS OF STANDARD CHARACTERS WITHOUT CLAIM TO ANY PARTICULAR FONT, STYLE, SIZE, OR COLOR.

OWNER OF U.S. REG. NOS. 416,252, 2,982,144 AND OTHERS.

FOR PHARMACEUTICAL PREPARATIONS, NAMELY, EYE DROPS; THERAPEUTIC OPHTHALMIC PREPARATIONS (U.S. CLS. 6, 18, 44, 46, 51 AND 52).

LEIGH LOWRY, EXAMINING ATTORNEY

SN 77-408,820. JOHNSON & JOHNSON, NEW BRUNSWICK,
NJ. FILED 2-28-2008.

INVEGA LAI

THE MARK CONSISTS OF STANDARD CHARACTERS WITHOUT CLAIM TO ANY PARTICULAR FONT, STYLE, SIZE, OR COLOR.

OWNER OF U.S. REG. NOS. 3,344,746 AND 3,391,680.

NO CLAIM IS MADE TO THE EXCLUSIVE RIGHT TO USE "LAI", APART FROM THE MARK AS SHOWN.

FOR PHARMACEUTICAL PREPARATION FOR THE TREATMENT OF CENTRAL NERVOUS SYSTEM DISEASES (U.S. CLS. 6, 18, 44, 46, 51 AND 52).

LEIGH LOWRY, EXAMINING ATTORNEY

CLASS 5—(Continued).

SN 77-414,016. INTERVET INC., MILLSBORO, DE. FILED 3-5-2008.



OWNER OF U.S. REG. NOS. 1,520,254, 3,011,718 AND OTHERS.

NO CLAIM IS MADE TO THE EXCLUSIVE RIGHT TO USE "ANIMAL HEALTH", APART FROM THE MARK AS SHOWN.

THE COLOR(S) BLACK AND RED IS/ARE CLAIMED AS A FEATURE OF THE MARK.

THE MARK CONSISTS OF A STYLIZED "SP" IN RED TO THE LEFT OF THE BLACK WORDING "INTERVET SCHERING-PLOUGH ANIMAL HEALTH".

FOR FULL LINE OF PHARMACEUTICAL PREPARATIONS FOR VETERINARY USE (U.S. CLS. 6, 18, 44, 46, 51 AND 52).

REBECCA GILBERT, EXAMINING ATTORNEY

SN 77-429,754. HUMPHREYS PHARMACAL, INCORPORATED, EAST HAMPTON, CT. FILED 3-24-2008.

SWIFT KIT

THE MARK CONSISTS OF STANDARD CHARACTERS WITHOUT CLAIM TO ANY PARTICULAR FONT, STYLE, SIZE, OR COLOR.

NO CLAIM IS MADE TO THE EXCLUSIVE RIGHT TO USE "KIT", APART FROM THE MARK AS SHOWN.

FOR PHARMACEUTICAL PREPARATIONS FOR THE RELIEF OF TEETHING PAIN (U.S. CLS. 6, 18, 44, 46, 51 AND 52).

WENDY GOODMAN, EXAMINING ATTORNEY

SN 77-429,808. HUMPHREYS PHARMACAL, INCORPORATED, EAST HAMPTON, CT. FILED 3-24-2008.

SWIFTLETS

THE MARK CONSISTS OF STANDARD CHARACTERS WITHOUT CLAIM TO ANY PARTICULAR FONT, STYLE, SIZE, OR COLOR.

FOR PHARMACEUTICAL PREPARATIONS FOR RELIEF OF FEVER, TEETHING PAIN, COLIC AND BEDWETTING (U.S. CLS. 6, 18, 44, 46, 51 AND 52).

WENDY GOODMAN, EXAMINING ATTORNEY

CLASS 5—(Continued).

SN 77-453,991. ATLEY PHARMACEUTICALS, INC., ASHLAND, VA. FILED 4-21-2008.

TUSSA

THE MARK CONSISTS OF STANDARD CHARACTERS WITHOUT CLAIM TO ANY PARTICULAR FONT, STYLE, SIZE, OR COLOR.

FOR MEDICINE, PHARMACEUTICAL PREPARATION, MEDICAL FOOD, NUTRACEUTICAL FOR THE TREATMENT AND SYMPTOMATIC RELIEF OF PAIN, RESPIRATORY DISEASE, COUGH AND COLD, TENSION HEADACHES (U.S. CLS. 6, 18, 44, 46, 51 AND 52).

STEPHEN AQUILA, EXAMINING ATTORNEY

SN 77-459,798. BATH SOLUTIONS, INC., BENSENVILLE, IL. FILED 4-28-2008.

GLITTER SCENTS

THE MARK CONSISTS OF STANDARD CHARACTERS WITHOUT CLAIM TO ANY PARTICULAR FONT, STYLE, SIZE, OR COLOR.

NO CLAIM IS MADE TO THE EXCLUSIVE RIGHT TO USE "SCENTS", APART FROM THE MARK AS SHOWN.

FOR AIR FRESHENERS (U.S. CLS. 6, 18, 44, 46, 51 AND 52).

JULIE WATSON, EXAMINING ATTORNEY

SN 77-476,572. KANE BIOTECH INC., WINNIPEG, CANADA. FILED 5-16-2008.

ALEDEX

THE MARK CONSISTS OF STANDARD CHARACTERS WITHOUT CLAIM TO ANY PARTICULAR FONT, STYLE, SIZE, OR COLOR.

FOR ANTIMICROBIAL, ANTIBACTERIAL AND ANTIFUNGAL PROTECTIVE COATING COMPOSITIONS APPLIED TO HEALTH, SURGICAL, MEDICAL, DENTAL OR VETERINARY DEVICES, APPARATUS AND INSTRUMENTS FOR THE TREATMENT AND PREVENTION OF THE GROWTH OF MOLD, MILDEW, BACTERIA AND FUNGUS; ANTIMICROBIAL COATING PREPARATIONS FOR HEALTH, SURGICAL, MEDICAL, DENTAL OR VETERINARY DEVICES; ANTIBACTERIAL COATINGS FOR MEDICAL PURPOSES; ANTIBACTERIAL COATINGS IN SPRAY FORM FOR HEALTH, SURGICAL, MEDICAL, DENTAL OR VETERINARY DEVICES; ANTIFUNGAL COATING CREAMS FOR MEDICAL USE (U.S. CLS. 6, 18, 44, 46, 51 AND 52).

SAMUEL E. SHARPER JR., EXAMINING ATTORNEY

CLASS 5—(Continued).

SN 77-476,677. BASF SE, LUDWIGSHAFEN AM RHEIN, FED REP GERMANY, FILED 5-16-2008.

FREQUENCY

THE MARK CONSISTS OF STANDARD CHARACTERS WITHOUT CLAIM TO ANY PARTICULAR FONT, STYLE, SIZE, OR COLOR.

FOR PESTICIDES, NAMELY, PREPARATIONS FOR DESTROYING VERMIN, INSECTICIDES, FUNGICIDES, HERBICIDES (U.S. CLS. 6, 18, 44, 46, 51 AND 52).

TINA BROWN, EXAMINING ATTORNEY

SN 77-476,737. BASF SE, LUDWIGSHAFEN AM RHEIN, FED REP GERMANY, FILED 5-16-2008.

INVERSION

THE MARK CONSISTS OF STANDARD CHARACTERS WITHOUT CLAIM TO ANY PARTICULAR FONT, STYLE, SIZE, OR COLOR.

FOR PESTICIDES, NAMELY, PREPARATIONS FOR DESTROYING VERMIN, INSECTICIDES, FUNGICIDES, HERBICIDES (U.S. CLS. 6, 18, 44, 46, 51 AND 52).

TINA BROWN, EXAMINING ATTORNEY

SN 77-477,561. JIA XINFENG, GUANGDONG, 51800, CHINA, FILED 5-19-2008.

富氧矿素

THE NON-LATIN CHARACTERS IN THE MARK TRANSLITERATE TO "FU; YANG; KUANG; SU" AND THIS MEANS "WEALTHY; OXYGEN; MINE; ELEMENT" IN ENGLISH.

FOR SOY PROTEIN FOR USE AS A NUTRITIONAL SUPPLEMENT IN VARIOUS POWDERED AND READY-TO-DRINK BEVERAGES; DIETETIC FOODS ADAPTED FOR MEDICAL USE; NUTRITIONAL ADDITIVES FOR MEDICAL PURPOSES FOR USE IN FOODS AND DIETARY SUPPLEMENTS FOR HUMAN CONSUMPTION; FOOD FOR BABIES; NUTRITIONALLY FORTIFIED BEVERAGES; DIETETIC SUGAR FOR MEDICAL USE; MINERAL FOOD SUPPLEMENTS; POWDERED MILK FOR BABIES (U.S. CLS. 6, 18, 44, 46, 51 AND 52).

FIRST USE 10-3-2007; IN COMMERCE 10-3-2007.

LEIGH LOWRY, EXAMINING ATTORNEY

CLASS 5—(Continued).

SN 77-482,062. DEAN, PAUL H., STOCKTON, MO. FILED 5-23-2008.



NO CLAIM IS MADE TO THE EXCLUSIVE RIGHT TO USE "NATIVE AMERICAN NUTRITIONALS", APART FROM THE MARK AS SHOWN.

THE COLOR(S) WHITE, BLACK, ORANGE, RED, GREEN, BLUE, AND YELLOW IS/ARE CLAIMED AS A FEATURE OF THE MARK.

THE MARK CONSISTS OF A NATIVE AMERICAN MEDICINE WHEEL WITH A RED BACKGROUND AND BLACK BORDER WITH THE WORDING "NATIVE AMERICAN NUTRITIONALS" AROUND IT IN WHITE. THE WHEEL IS BROKEN INTO RED, GREEN, BLUE, AND YELLOW SECTIONS WITH ORANGE SECTION DIVIDERS. THERE IS A SPECIFIC ANIMAL IN BLACK AND WHITE ASSOCIATED WITH EACH SECTION. THE NORTH POINT IS WHITE AND THE ANIMAL IS A WOLF; THE EAST POINT IS YELLOW AND THE ANIMAL IS AN EAGLE; THE SOUTH POINT IS GREEN AND THE ANIMAL IS A MOUSE; THE WEST POINT IS BLUE AND THE ANIMAL IS A BISON.

FOR MEDICINAL HERBAL SUPPLEMENTS FEATURING NATIVE AMERICAN HERBS (U.S. CLS. 6, 18, 44, 46, 51 AND 52).

FIRST USE 6-1-2006; IN COMMERCE 6-1-2006.

DOMINIC J. FERRAIUOLO, EXAMINING ATTORNEY

SN 77-483,437. MALONE, JOHN, LA JOLLA, CA. FILED 5-26-2008.

NONI NITRO

THE MARK CONSISTS OF STANDARD CHARACTERS WITHOUT CLAIM TO ANY PARTICULAR FONT, STYLE, SIZE, OR COLOR.

NO CLAIM IS MADE TO THE EXCLUSIVE RIGHT TO USE "NONI", APART FROM THE MARK AS SHOWN.

FOR DIETARY SUPPLEMENTS, NAMELY, DIETARY SUPPLEMENTS CONTAINING NONI PLANT EXTRACTS (U.S. CLS. 6, 18, 44, 46, 51 AND 52).

YAT SYE, LEE, EXAMINING ATTORNEY

CLASS 5—(Continued).

SN 77-503,931. STROMEDIX, INC., CAMBRIDGE, MA.
FILED 6-20-2008.

STX-100

THE MARK CONSISTS OF STANDARD CHARACTERS
WITHOUT CLAIM TO ANY PARTICULAR FONT, STYLE,
SIZE, OR COLOR.

FOR PHARMACEUTICAL PREPARATIONS FOR THE
PURPOSE OF TREATING FIBROTIC DISEASES, AND
FIBROTIC CONDITIONS AND CANCER (U.S. CLS. 6, 18,
44, 46, 51 AND 52).

FIRST USE 1-16-2008; IN COMMERCE 1-16-2008.
SANDRA MANIOS, EXAMINING ATTORNEY

SN 77-511,106. STAHL, JAN, GLEN HEAD, NY. FILED 6-30-
2008.

A.I.R. PADS

THE MARK CONSISTS OF STANDARD CHARACTERS
WITHOUT CLAIM TO ANY PARTICULAR FONT, STYLE,
SIZE, OR COLOR.

NO CLAIM IS MADE TO THE EXCLUSIVE RIGHT TO
USE "PADS", APART FROM THE MARK AS SHOWN.

FOR SALIVA ABSORBER FOR DENTAL USE IN THE
NATURE OF ABSORBENT PADS (U.S. CLS. 6, 18, 44, 46,
51 AND 52).

FIRST USE 4-1-2008; IN COMMERCE 4-1-2008.
CYNTHIA TRIPI, EXAMINING ATTORNEY

SN 77-517,014. ISHIHARA SANGYO KAISHA, LTD., OSAKA,
JAPAN, FILED 7-8-2008.

KATANA

THE MARK CONSISTS OF STANDARD CHARACTERS
WITHOUT CLAIM TO ANY PARTICULAR FONT, STYLE,
SIZE, OR COLOR.

FOR HERBICIDES (U.S. CLS. 6, 18, 44, 46, 51 AND 52).
JOHN GARTNER, EXAMINING ATTORNEY

CLASS 5—(Continued).

SN 77-532,007. SHARP, SIDNEY, BEVERLY HILLS, CA. AND
DEL, TRISTAN S., BEVERLY HILLS, CA. FILED 7-25-2008.

DIMEBON

THE MARK CONSISTS OF STANDARD CHARACTERS
WITHOUT CLAIM TO ANY PARTICULAR FONT, STYLE,
SIZE, OR COLOR.

THE WORDING "DIMEBON" IN THE MARK HAS NO
MEANING IN A FOREIGN LANGUAGE.

FOR PHARMACEUTICAL PRODUCTS, NAMELY,
NOOTROPIC AGENTS, COGNITIVE ENHANCEMENT
AGENTS, ANTIHISTAMINE AGENTS, AND AGENTS
FOR THE TREATMENT OF NEURODEGENERATIVE
CONDITIONS AND CONDITIONS INVOLVING COGNITIVE
IMPAIRMENT (U.S. CLS. 6, 18, 44, 46, 51 AND 52).
MICHAEL GAAFAR, EXAMINING ATTORNEY

SN 77-535,281. ALOE LIFE INTERNATIONAL, INC., LAKE-
SIDE, CA. FILED 7-30-2008.

Bug Beware

THE MARK CONSISTS OF STANDARD CHARACTERS
WITHOUT CLAIM TO ANY PARTICULAR FONT, STYLE,
SIZE, OR COLOR.

NO CLAIM IS MADE TO THE EXCLUSIVE RIGHT TO
USE "BUG", APART FROM THE MARK AS SHOWN.

FOR INSECT REPELLENTS (U.S. CLS. 6, 18, 44, 46, 51
AND 52).

FIRST USE 6-25-2008; IN COMMERCE 6-25-2008.
RUDY R. SINGLETON, EXAMINING ATTORNEY

CLASS 5—(Continued).

SN 77-535,609. 9189-7355 QUEBEC INC., ST-BERNARD LA-COLLE, QC, CANADA, FILED 7-31-2008.



THE MARK CONSISTS OF THE STYLIZED WORD "SURO" APPEARING BELOW A DESIGN RESEMBLING A MAN OR TOWER BUILT OF STONES, AND BELOW THE WORD "SURO" APPEARS THE STYLIZED WORD "BIOSAMBUCUS".

FOR COUGH SYRUPS FOR USE IN TREATING FLU SYMPTOMS, PHARMACEUTICAL PREPARATIONS IN THE NATURE OF TINCTURES FOR USE IN TREATING FLU SYMPTOMS, ANTI-INFLAMMATORY SALVES FOR USE IN TREATING RHEUMATISM (U.S. CLS. 6, 18, 44, 46, 51 AND 52).

FIRST USE 10-1-2006; IN COMMERCE 10-1-2006.
KAELIE KUNG, EXAMINING ATTORNEY



SN 77-546,658. PATENTHEALTH, LLC, CANTON, OH. FILED 8-13-2008.

RAPIDFLEX

THE MARK CONSISTS OF STANDARD CHARACTERS WITHOUT CLAIM TO ANY PARTICULAR FONT, STYLE, SIZE, OR COLOR.

FOR TOPICAL ANALGESICS (U.S. CLS. 6, 18, 44, 46, 51 AND 52).

ALLISON HOLTZ, EXAMINING ATTORNEY

CLASS 5—(Continued).

SN 77-547,571. AXIAL BIOTECH, INC., SALT LAKE CITY, UT. FILED 8-14-2008.

SCOLI-MAP

THE MARK CONSISTS OF STANDARD CHARACTERS WITHOUT CLAIM TO ANY PARTICULAR FONT, STYLE, SIZE, OR COLOR.

FOR PHARMACEUTICALS AND THERAPEUTICS, COMPRISING, BIOLOGICAL PREPARATIONS FOR TREATING AND DIAGNOSING BONE DISORDERS; NUTRITIONAL SUPPLEMENTS (U.S. CLS. 6, 18, 44, 46, 51 AND 52).

DAVON HATCHETT, EXAMINING ATTORNEY



SN 77-547,583. AXIAL BIOTECH, INC., SALT LAKE CITY, UT. FILED 8-14-2008.

SCOLI-SCORE

THE MARK CONSISTS OF STANDARD CHARACTERS WITHOUT CLAIM TO ANY PARTICULAR FONT, STYLE, SIZE, OR COLOR.

FOR PHARMACEUTICALS AND THERAPEUTICS, COMPRISING, BIOLOGICAL PREPARATIONS FOR TREATING AND DIAGNOSING BONE DISORDERS; NUTRITIONAL SUPPLEMENTS (U.S. CLS. 6, 18, 44, 46, 51 AND 52).

DAVON HATCHETT, EXAMINING ATTORNEY



SN 77-548,051. RAWLS, MARCUS, JACKSONVILLE, FL. FILED 8-15-2008.

MIDBACTUM

THE MARK CONSISTS OF STANDARD CHARACTERS WITHOUT CLAIM TO ANY PARTICULAR FONT, STYLE, SIZE, OR COLOR.

FOR DIETARY SUPPLEMENTS FOR HUMANS WHICH CONTAIN A COMBINATION OF PROBIOTIC MICROORGANISMS THAT AID IN THE DIGESTION OF FOOD (U.S. CLS. 6, 18, 44, 46, 51 AND 52).

JEFFREY LOOK, EXAMINING ATTORNEY

CLASS 5—(Continued).

SN 77-549,736. PROFESSIONAL MEDICAL SURGICAL SUPPLY, INC., NEW LENNOX, IL. FILED 8-18-2008.



THE COLOR(S) RED, GRAY, LIGHT BLUE, DARK BLUE, BLACK, WHITE AND PINK FLESH IS/ARE CLAIMED AS A FEATURE OF THE MARK.

THE MARK CONSISTS OF A PINK FLESH COLORED STRONG-BODIED CHARACTER WEARING A SUIT THAT IS LIGHT BLUE, DARK BLUE AND RED, WITH A RED CHECK MARK ON IT. THE CHECK MARK IS ON A WHITE CIRCULAR BACKGROUND WITH A RED OUTLINE. THE CHARACTER'S HAIR AND EYEBROWS ARE BLACK, HIS TEETH ARE WHITE, AND HIS GLASSES ARE BLUE, GRAY AND WHITE. BELOW THE CHARACTER, THE WORDING "CAPTAIN COMPLIANCE" APPEARS IN WHITE AND GRAY AND OUTLINED IN RED. THERE IS ALSO A WHITE AND GRAY CHECK MARK INSIDE A WHITE AND GRAY CIRCULAR BORDER. THE CHECK MARK AND THE CIRCULAR BORDER ARE OUTLINED IN RED. THE REMAINING WHITE IN THE MARK IS BACKGROUND ONLY AND IS NOT INTENDED AS A FEATURE OF THE MARK.

FOR WOUND DRESSING, SANITIZING WIPES, MEDICAL ADHESIVE TAPE, INCONTINENCE GARMENTS, INCONTINENCE PADS, MEDICATED LOTIONS FOR SKIN (U.S. CLS. 6, 18, 44, 46, 51 AND 52).

FIRST USE 5-10-2008; IN COMMERCE 5-10-2008.

AMY ALFIERI, EXAMINING ATTORNEY

SN 77-551,162. AMERIFIT, INC., CROMWELL, CT. FILED 8-20-2008.

AZO PMS

THE MARK CONSISTS OF STANDARD CHARACTERS WITHOUT CLAIM TO ANY PARTICULAR FONT, STYLE, SIZE, OR COLOR.

OWNER OF U.S. REG. NOS. 1,817,683, 2,349,020 AND OTHERS.

NO CLAIM IS MADE TO THE EXCLUSIVE RIGHT TO USE "PMS", APART FROM THE MARK AS SHOWN.

FOR PREPARATIONS FOR THE TREATMENT OF PREMENSTRUAL SYNDROME ("PMS") (U.S. CLS. 6, 18, 44, 46, 51 AND 52).

JOHN KELLY, EXAMINING ATTORNEY

CLASS 5—(Continued).

SN 77-552,317. HALL, EDWARD, SANDY, UT. FILED 8-21-2008.

NATRAGAIA

THE MARK CONSISTS OF STANDARD CHARACTERS WITHOUT CLAIM TO ANY PARTICULAR FONT, STYLE, SIZE, OR COLOR.

THE WORDING "NATRAGAIA" HAS NO MEANING IN A FOREIGN LANGUAGE.

FOR NUTRITIONAL SUPPLEMENTS (U.S. CLS. 6, 18, 44, 46, 51 AND 52).

FRED CARL, EXAMINING ATTORNEY

SN 77-552,328. MVT TRADEMARKS LTD., MISSISSAUGA, ONTARIO, CANADA, FILED 8-21-2008.

VITAKIC

THE MARK CONSISTS OF STANDARD CHARACTERS WITHOUT CLAIM TO ANY PARTICULAR FONT, STYLE, SIZE, OR COLOR.

THE WORDING "VITAKIC" HAS NO MEANING IN A FOREIGN LANGUAGE.

FOR DIETARY SUPPLEMENTS (U.S. CLS. 6, 18, 44, 46, 51 AND 52).

FRED CARL, EXAMINING ATTORNEY

SN 77-558,130. PHARMACIST'S REMEDY, INC., IRVINE, CA. FILED 8-28-2008.

NIP-IT

THE MARK CONSISTS OF STANDARD CHARACTERS WITHOUT CLAIM TO ANY PARTICULAR FONT, STYLE, SIZE, OR COLOR.

FOR PHARMACEUTICAL PRODUCTS, NAMELY, COMBINATIONS OF VITAMINS, MINERALS, AND HERBS, FOR USE IN REDUCING SYMPTOMS OF SORE THROAT ASSOCIATED WITH THE COMMON COLD (U.S. CLS. 6, 18, 44, 46, 51 AND 52).

PRISCILLA MILTON, EXAMINING ATTORNEY

CLASS 5—(Continued).

SN 77-562,015. MCLAUGHLIN GORMLEY KING COMPANY, MINNEAPOLIS, MN. FILED 9-4-2008.



THE COLOR(S) ORANGE AND WHITE IS/ARE CLAIMED AS A FEATURE OF THE MARK.
 THE MARK CONSISTS OF A WHITE FLOWER ON AN ORANGE BACKGROUND.
 FOR INSECTICIDES (U.S. CLS. 6, 18, 44, 46, 51 AND 52).
 MATTHEW KLINE, EXAMINING ATTORNEY

SN 77-562,019. MCLAUGHLIN GORMLEY KING COMPANY, MINNEAPOLIS, MN. FILED 9-4-2008.

PIRETROS

THE MARK CONSISTS OF STANDARD CHARACTERS WITHOUT CLAIM TO ANY PARTICULAR FONT, STYLE, SIZE, OR COLOR.
 FOR INSECTICIDES (U.S. CLS. 6, 18, 44, 46, 51 AND 52).
 MATTHEW KLINE, EXAMINING ATTORNEY

SN 77-562,084. UBIMED, L.L.C., MIAMI, FL. FILED 9-4-2008.

CLEANOZ

THE MARK CONSISTS OF STANDARD CHARACTERS WITHOUT CLAIM TO ANY PARTICULAR FONT, STYLE, SIZE, OR COLOR.
 OWNER OF U.S. REG. NO. 3,235,195.
 FOR SALINE WASH; SALINE NASAL SPRAY PREPARATIONS; SALINE SOLUTIONS FOR MEDICAL PURPOSES (U.S. CLS. 6, 18, 44, 46, 51 AND 52).
 FIRST USE 6-28-2008; IN COMMERCE 6-28-2008.
 BRIAN NEVILLE, EXAMINING ATTORNEY

CLASS 5—(Continued).

SN 77-562,092. UBIMED, L.L.C., MIAMI, FL. FILED 9-4-2008.

CLEANIZE

THE MARK CONSISTS OF STANDARD CHARACTERS WITHOUT CLAIM TO ANY PARTICULAR FONT, STYLE, SIZE, OR COLOR.
 OWNER OF U.S. REG. NO. 3,235,195.
 FOR EYE WASH; SALINE SOLUTIONS FOR MEDICAL PURPOSES (U.S. CLS. 6, 18, 44, 46, 51 AND 52).
 FIRST USE 6-28-2008; IN COMMERCE 6-28-2008.
 BRIAN NEVILLE, EXAMINING ATTORNEY

SN 77-562,177. COUNTRYSIDE STOVE & CHIMNEY, INC., ARCADE, NY. FILED 9-4-2008.



THE MARK CONSISTS OF THE STYLIZED WORDS "HEARTH FRESH"
 FOR TEA TREE OIL TO PURIFY AND DISINFECT THE AIR AND CONTAMINATED SURFACES (U.S. CLS. 6, 18, 44, 46, 51 AND 52).
 JACQUELINE A. LAVINE, EXAMINING ATTORNEY

SN 77-562,650. LIFEMED MEDIA, INC., WESTPORT, CT. FILED 9-4-2008.

DLIFE

THE MARK CONSISTS OF STANDARD CHARACTERS WITHOUT CLAIM TO ANY PARTICULAR FONT, STYLE, SIZE, OR COLOR.
 OWNER OF U.S. REG. NOS. 3,104,923, 3,127,706 AND OTHERS.
 FOR DIETARY AND NUTRITIONAL SUPPLEMENTS (U.S. CLS. 6, 18, 44, 46, 51 AND 52).
 CORY BOONE, EXAMINING ATTORNEY

CLASS 5—(Continued).

SN 77-562,794. WOODWARD LABORATORIES, INC., ALISO VIEJO, CA. FILED 9-4-2008.

NoroClens

THE MARK CONSISTS OF STANDARD CHARACTERS WITHOUT CLAIM TO ANY PARTICULAR FONT, STYLE, SIZE, OR COLOR.

FOR ALCOHOL-FREE HAND SANITIZER THAT KILLS NOROVIRUS (U.S. CLS. 6, 18, 44, 46, 51 AND 52).
MARTHA FROMM, EXAMINING ATTORNEY

SN 77-562,952. FIZOGEN PRECISION TECHNOLOGIES, INC., WELLINGTON, FL. FILED 9-5-2008.

MRE

THE MARK CONSISTS OF STANDARD CHARACTERS WITHOUT CLAIM TO ANY PARTICULAR FONT, STYLE, SIZE, OR COLOR.

FOR DIETARY AND NUTRITIONAL SUPPLEMENTS (U.S. CLS. 6, 18, 44, 46, 51 AND 52).
SHAUNIA CARLYLE, EXAMINING ATTORNEY

SN 77-563,606. BRIAN R STEARNS, BROOMFIELD, CO. FILED 9-5-2008.



THE COLOR(S) RED, WHITE, SILVER, BLACK, ORANGE IS/ARE CLAIMED AS A FEATURE OF THE MARK.
THE MARK CONSISTS OF A STICK FIGURE WITH

CLASS 5—(Continued).

ROCKET AND STARS. THE ROCKET AND STARS ARE LOCATED IN THE CIRCLE HEAD AREA. THE COLOR RED APPEARS IN THE NOSE CONE AND BOOSTERS OF THE ROCKET. THE COLOR ORANGE APPEARS IN THE FLAMES COMING OUT OF THE ROCKET. THE COLOR SILVER APPEARS IN THE BODY OF THE ROCKET AND IN THE BODY OF THE STICK FIGURE. THE COLOR WHITE APPEARS IN THE STARS. THE COLOR BLACK APPEARS IN THE REFLECTION ON THE BODY OF THE ROCKET AND INSIDE THE STICK FIGURE'S HEAD.

FOR VITAMIN FORTIFIED BEVERAGES (U.S. CLS. 6, 18, 44, 46, 51 AND 52).
SIMON TENG, EXAMINING ATTORNEY

SN 77-563,614. THE ROCKING CHAIR LLC, TEANECK, NJ. FILED 9-5-2008.

THE ROCKING CHAIR

THE MARK CONSISTS OF STANDARD CHARACTERS WITHOUT CLAIM TO ANY PARTICULAR FONT, STYLE, SIZE, OR COLOR.

FOR DIETARY AND NUTRITIONAL SUPPLEMENTS (U.S. CLS. 6, 18, 44, 46, 51 AND 52).
DAVON HATCHETT, EXAMINING ATTORNEY

SN 77-563,781. HENRY'S HOLDINGS, LLC, COMMERCE, CA. FILED 9-5-2008.

SUN HARVEST

THE MARK CONSISTS OF STANDARD CHARACTERS WITHOUT CLAIM TO ANY PARTICULAR FONT, STYLE, SIZE, OR COLOR.

OWNER OF U.S. REG. NOS. 3,125,951 AND 3,440,589.
FOR MINERAL SUPPLEMENTS; NUTRITIONAL SUPPLEMENTS; VITAMINS (U.S. CLS. 6, 18, 44, 46, 51 AND 52).

ALYSSA STEEL, EXAMINING ATTORNEY

SN 77-564,144. FIZOGEN PRECISION TECHNOLOGIES, INC., WELLINGTON, FL. FILED 9-7-2008.

WARHEAD

THE MARK CONSISTS OF STANDARD CHARACTERS WITHOUT CLAIM TO ANY PARTICULAR FONT, STYLE, SIZE, OR COLOR.

FOR DIETARY AND NUTRITIONAL SUPPLEMENTS (U.S. CLS. 6, 18, 44, 46, 51 AND 52).
SHAUNIA CARLYLE, EXAMINING ATTORNEY

CLASS 5—(Continued).

SN 77-564,146. FIZOGEN PRECISION TECHNOLOGIES, INC., WELLINGTON, FL. FILED 9-7-2008.

MINI-GUN

THE MARK CONSISTS OF STANDARD CHARACTERS WITHOUT CLAIM TO ANY PARTICULAR FONT, STYLE, SIZE, OR COLOR.
FOR DIETARY AND NUTRITIONAL SUPPLEMENTS (U.S. CLS. 6, 18, 44, 46, 51 AND 52).
SHAUNIA CARLYLE, EXAMINING ATTORNEY

SN 77-564,263. ALVIN KAPLAN, ARMONK, NY. FILED 9-8-2008.

NO MORE SKID MARKS

THE MARK CONSISTS OF STANDARD CHARACTERS WITHOUT CLAIM TO ANY PARTICULAR FONT, STYLE, SIZE, OR COLOR.
FOR UNDERWEAR LINERS (U.S. CLS. 6, 18, 44, 46, 51 AND 52).
RUSS HERMAN, EXAMINING ATTORNEY

SN 77-564,275. ALVIN KAPLAN, ARMONK, NY. FILED 9-8-2008.

NO MORE TIRE TRACKS

THE MARK CONSISTS OF STANDARD CHARACTERS WITHOUT CLAIM TO ANY PARTICULAR FONT, STYLE, SIZE, OR COLOR.
FOR UNDERWEAR LINERS (U.S. CLS. 6, 18, 44, 46, 51 AND 52).
RUSS HERMAN, EXAMINING ATTORNEY

CLASS 5—(Continued).

SN 77-564,636. SUPERNUS PHARMACEUTICALS, INC., ROCKVILLE, MD. FILED 9-8-2008.

EPLIGA

THE MARK CONSISTS OF STANDARD CHARACTERS WITHOUT CLAIM TO ANY PARTICULAR FONT, STYLE, SIZE, OR COLOR.
FOR PHARMACEUTICAL PREPARATIONS OR SUBSTANCES FOR THE TREATMENT AND PREVENTION OF CENTRAL NERVOUS SYSTEM AND PERIPHERAL NERVOUS SYSTEM DISEASES AND DISORDERS, PSYCHIATRIC AND NEUROLOGICAL DISEASES AND DISORDERS (U.S. CLS. 6, 18, 44, 46, 51 AND 52).
LESLEY LAMOTHE, EXAMINING ATTORNEY

SN 77-564,701. SUPERNUS PHARMACEUTICALS, INC., ROCKVILLE, MD. FILED 9-8-2008.

TROKESA

THE MARK CONSISTS OF STANDARD CHARACTERS WITHOUT CLAIM TO ANY PARTICULAR FONT, STYLE, SIZE, OR COLOR.
FOR PHARMACEUTICAL PREPARATIONS OR SUBSTANCES FOR THE TREATMENT AND PREVENTION OF CENTRAL NERVOUS SYSTEM AND PERIPHERAL NERVOUS SYSTEM DISEASES AND DISORDERS, PSYCHIATRIC AND NEUROLOGICAL DISEASES AND DISORDERS (U.S. CLS. 6, 18, 44, 46, 51 AND 52).
LESLEY LAMOTHE, EXAMINING ATTORNEY

SN 77-564,722. DOCTORS CHOICE SUPPLEMENTS, SAUK CITY, WI. FILED 9-8-2008.

FIDO-VITE

THE MARK CONSISTS OF STANDARD CHARACTERS WITHOUT CLAIM TO ANY PARTICULAR FONT, STYLE, SIZE, OR COLOR.
FOR ANIMAL FEED ADDITIVE FOR USE AS A NUTRITIONAL SUPPLEMENT FOR MEDICAL PURPOSES; ANIMAL FEED SUPPLEMENTS; DIETARY SUPPLEMENTS FOR ANIMALS; FEED SUPPLEMENTS FOR DOGS (U.S. CLS. 6, 18, 44, 46, 51 AND 52).
FIRST USE 9-1-2008; IN COMMERCE 9-1-2008.
CHRISTINA SOBRAL, EXAMINING ATTORNEY

CLASS 5—(Continued).

SN 77-564,740. C.B. FLEET INVESTMENT CORPORATION,
WILMINGTON, DE. FILED 9-8-2008.

PEDIA-LAX

THE MARK CONSISTS OF STANDARD CHARACTERS
WITHOUT CLAIM TO ANY PARTICULAR FONT, STYLE,
SIZE, OR COLOR.

OWNER OF U.S. REG. NO. 3,445,751.
FOR DIETARY FIBER SUPPLEMENTS (U.S. CLS. 6, 18,
44, 46, 51 AND 52).
ROBIN CHOSID, EXAMINING ATTORNEY

CLASS 5—(Continued).

SN 77-565,313. EVOL NUTRITION ASSOCIATES, INC.,
DALLAS, GA. FILED 9-9-2008.

Planet X

THE MARK CONSISTS OF STANDARD CHARACTERS
WITHOUT CLAIM TO ANY PARTICULAR FONT, STYLE,
SIZE, OR COLOR.

FOR VITAMIN SUPPLEMENTS (U.S. CLS. 6, 18, 44, 46,
51 AND 52).
FIRST USE 5-25-2007; IN COMMERCE 5-25-2007.
CARRIE GENOVESE, EXAMINING ATTORNEY

SN 77-564,851. MEDA PHARMACEUTICALS INC., SOMER-
SET, NJ. FILED 9-8-2008.



THE MARK CONSISTS OF A STYLIZED LETTER "S".
FOR PHARMACEUTICALS FOR THE RELIEF OF
DISCOMFORT ASSOCIATED WITH ACUTE, PAINFUL
MUSCULOSKELETAL CONDITIONS IN ADULTS (U.S.
CLS. 6, 18, 44, 46, 51 AND 52).

FIRST USE 9-17-2007; IN COMMERCE 9-17-2007.
STEPHEN AQUILA, EXAMINING ATTORNEY

SN 77-565,490. DUSUKI, LLC, SAN CLEMENTE, CA. FILED
9-9-2008.

VivaBar

THE MARK CONSISTS OF STANDARD CHARACTERS
WITHOUT CLAIM TO ANY PARTICULAR FONT, STYLE,
SIZE, OR COLOR.

FOR DIETARY AND NUTRITIONAL SUPPLEMENTS;
DIETARY AND NUTRITIONALLY FORTIFIED FOOD
PRODUCTS ADAPTED FOR MEDICAL USE; DIETARY
FOOD SUPPLEMENTS; DIETARY SUPPLEMENTS FOR
HUMAN CONSUMPTION; FOOD SUPPLEMENTS; HER-
BAL SUPPLEMENTS; HOMEOPATHIC SUPPLEMENTS;
MEAL REPLACEMENT BARS; MINERAL NUTRI-
TIONAL SUPPLEMENTS; NATURAL HERBAL SUPPLE-
MENTS; NUTRACEUTICALS FOR USE AS A DIETARY
SUPPLEMENT; NUTRITIONAL ADDITIVES FOR MED-
ICAL PURPOSES FOR USE IN FOODS AND DIETARY
SUPPLEMENTS FOR HUMAN CONSUMPTION; NUTRI-
TIONAL ENERGY BARS FOR USE AS A MEAL SUB-
STITUTE; NUTRITIONAL SUPPLEMENTS; PROTEIN
SUPPLEMENTS; VITAMIN AND MINERAL FORMED
AND PACKAGED AS BARS; VITAMIN AND MINERAL
PREPARATIONS FOR USE AS INGREDIENTS IN THE
FOOD AND PHARMACEUTICAL INDUSTRY (U.S. CLS.
6, 18, 44, 46, 51 AND 52).

JESSICA A. POWERS, EXAMINING ATTORNEY

SN 77-565,004. THRESHOLD ENTERPRISES LTD, SCOTTS
VALLEY, CA. FILED 9-8-2008.

HOTFLASH

THE MARK CONSISTS OF STANDARD CHARACTERS
WITHOUT CLAIM TO ANY PARTICULAR FONT, STYLE,
SIZE, OR COLOR.

SEC. 2(F).
FOR DIETARY SUPPLEMENTS, NUTRITIONAL SUP-
PLEMENTS, FOOD SUPPLEMENTS AND HERBAL SUP-
PLEMENTS, NAMELY, TABLETS, CAPSULES AND
LIQUIDS (U.S. CLS. 6, 18, 44, 46, 51 AND 52).
FIRST USE 7-7-1997; IN COMMERCE 7-17-1997.

MARIA-VICTORIA SUAREZ, EXAMINING ATTORNEY

SN 77-565,503. MALAVA BEVERAGES, LLC, NEWPORT
BEACH, CA. FILED 9-9-2008.

NOVOCAINE

THE MARK CONSISTS OF STANDARD CHARACTERS
WITHOUT CLAIM TO ANY PARTICULAR FONT, STYLE,
SIZE, OR COLOR.

FOR NUTRITIONALLY FORTIFIED BEVERAGES
(U.S. CLS. 6, 18, 44, 46, 51 AND 52).

ELISSA GARBER KON, EXAMINING ATTORNEY

CLASS 5—(Continued).

SN 77-565,527. HEALINGUSA LLC, SCOTTSDALE, AZ. FILED 9-9-2008.

HEALINGUSA

THE MARK CONSISTS OF STANDARD CHARACTERS WITHOUT CLAIM TO ANY PARTICULAR FONT, STYLE, SIZE, OR COLOR.

FOR NATURAL HEALTH PRODUCTS, NAMELY, DIETARY SUPPLEMENTS (U.S. CLS. 6, 18, 44, 46, 51 AND 52).

DEIRDRE ROBERTSON, EXAMINING ATTORNEY

CLASS 5—(Continued).

SN 77-565,894. B. F. ASCHER & COMPANY, INC., LENEXA, KS. FILED 9-9-2008.

HYDROCORTIFOAM

THE MARK CONSISTS OF STANDARD CHARACTERS WITHOUT CLAIM TO ANY PARTICULAR FONT, STYLE, SIZE, OR COLOR.

FOR MEDICATED SKIN CARE PREPARATIONS, NAMELY, LOTIONS (U.S. CLS. 6, 18, 44, 46, 51 AND 52).

JAMES A. RAUEN, EXAMINING ATTORNEY

SN 77-565,627. RESPA PHARMACEUTICALS, INC., ADDISON, IL. FILED 9-9-2008.

Vita-Respa

THE MARK CONSISTS OF STANDARD CHARACTERS WITHOUT CLAIM TO ANY PARTICULAR FONT, STYLE, SIZE, OR COLOR.

OWNER OF U.S. REG. NOS. 3,166,134 AND 3,249,962. THE FOREIGN WORDING IN THE MARK TRANSLATES INTO ENGLISH AS LIFE.

FOR NUTRITIONAL SUPPLEMENTS; VITAMIN SUPPLEMENTS; VITAMIN TABLETS; VITAMINS (U.S. CLS. 6, 18, 44, 46, 51 AND 52).

FIRST USE 4-1-2008; IN COMMERCE 4-1-2008. EMILY CHUO, EXAMINING ATTORNEY

SN 77-566,138. AMAZON HERB CO., JUPITER, FL. FILED 9-9-2008.

TASTES GOOD. FEELS GOOD.
DOES GOOD.

THE MARK CONSISTS OF STANDARD CHARACTERS WITHOUT CLAIM TO ANY PARTICULAR FONT, STYLE, SIZE, OR COLOR.

FOR DIETARY SUPPLEMENTS (U.S. CLS. 6, 18, 44, 46, 51 AND 52).

TRACY WHITTAKER-BROWN, EXAMINING ATTORNEY

SN 77-565,676. ARMSTRONG, JOHN PHILIP, NAPLES, FL. FILED 9-9-2008.

ECOLOGIE

THE MARK CONSISTS OF STANDARD CHARACTERS WITHOUT CLAIM TO ANY PARTICULAR FONT, STYLE, SIZE, OR COLOR.

FOR NUTRITIONALLY FORTIFIED BEVERAGES; VITAMIN FORTIFIED BEVERAGES (U.S. CLS. 6, 18, 44, 46, 51 AND 52).

JENNIFER MARTIN, EXAMINING ATTORNEY

SN 77-566,354. MCCORD RESEARCH, INC., IOWA CITY, IA. FILED 9-10-2008.

Living Well at One Hundred

THE MARK CONSISTS OF STANDARD CHARACTERS WITHOUT CLAIM TO ANY PARTICULAR FONT, STYLE, SIZE, OR COLOR.

FOR DIETARY AND NUTRITIONAL SUPPLEMENTS (U.S. CLS. 6, 18, 44, 46, 51 AND 52).

CARRIE GENOVESE, EXAMINING ATTORNEY

CLASS 5—(Continued).

SN 77-566,368. MCCORD RESEARCH, INC., IOWA CITY, IA.
FILED 9-10-2008.

Daily Longevity Routine

THE MARK CONSISTS OF STANDARD CHARACTERS WITHOUT CLAIM TO ANY PARTICULAR FONT, STYLE, SIZE, OR COLOR.

NO CLAIM IS MADE TO THE EXCLUSIVE RIGHT TO USE "DAILY", APART FROM THE MARK AS SHOWN.

FOR DIETARY AND NUTRITIONAL SUPPLEMENTS (U.S. CLS. 6, 18, 44, 46, 51 AND 52).

CARRIE GENOVESE, EXAMINING ATTORNEY

SN 77-566,379. MCCORD RESEARCH, INC., IOWA CITY, IA.
FILED 9-10-2008.

Longevity is a Journey to Good Health

THE MARK CONSISTS OF STANDARD CHARACTERS WITHOUT CLAIM TO ANY PARTICULAR FONT, STYLE, SIZE, OR COLOR.

FOR DIETARY AND NUTRITIONAL SUPPLEMENTS (U.S. CLS. 6, 18, 44, 46, 51 AND 52).

CARRIE GENOVESE, EXAMINING ATTORNEY

SN 77-566,390. MCCORD RESEARCH, INC., IOWA CITY, IA.
FILED 9-10-2008.

Daily Ritual Supplements

THE MARK CONSISTS OF STANDARD CHARACTERS WITHOUT CLAIM TO ANY PARTICULAR FONT, STYLE, SIZE, OR COLOR.

NO CLAIM IS MADE TO THE EXCLUSIVE RIGHT TO USE "DAILY" OR "SUPPLEMENTS", APART FROM THE MARK AS SHOWN.

FOR DIETARY AND NUTRITIONAL SUPPLEMENTS (U.S. CLS. 6, 18, 44, 46, 51 AND 52).

CARRIE GENOVESE, EXAMINING ATTORNEY

CLASS 5—(Continued).

SN 77-566,400. MCCORD RESEARCH, INC., IOWA CITY, IA.
FILED 9-10-2008.

Oleuracent DG

THE MARK CONSISTS OF STANDARD CHARACTERS WITHOUT CLAIM TO ANY PARTICULAR FONT, STYLE, SIZE, OR COLOR.

FOR DIETARY AND NUTRITIONAL SUPPLEMENTS (U.S. CLS. 6, 18, 44, 46, 51 AND 52).

CARRIE GENOVESE, EXAMINING ATTORNEY

SN 77-566,445. BELL AUTOMOTIVE PRODUCTS, INC.,
SCOTTSDALE, AZ. FILED 9-10-2008.

NATURAL EFFECTS

THE MARK CONSISTS OF STANDARD CHARACTERS WITHOUT CLAIM TO ANY PARTICULAR FONT, STYLE, SIZE, OR COLOR.

FOR AIR FRESHENERS (U.S. CLS. 6, 18, 44, 46, 51 AND 52).

ERNEST SHOSHO, EXAMINING ATTORNEY

SN 77-566,475. MILLER, LORIE, PIPERSVILLE, PA. FILED 9-10-2008.



THE MARK CONSISTS OF AN IMAGE OF A SPIDER HANGING FROM A WEB THAT IS COMING FROM A MAILBOX WITH A LINE THRU IT. THE SPIDER IS WEARING SNEAKERS AND HAS HAIR CARRYING A HOBO BAG ON A STICK. THE STYLIZED WORDS "BOOT-A-BUG" IS ABOVE THE SPIDER INSIDE AN OVAL SHAPE DESIGN.

FOR INSECT REPELLENTS (U.S. CLS. 6, 18, 44, 46, 51 AND 52).

JESSICA A. POWERS, EXAMINING ATTORNEY

CLASS 5—(Continued).

SN 77-566,913. CYTORI THERAPEUTICS, INC., SAN DIEGO, CA. FILED 9-10-2008.

INTRAVASE

THE MARK CONSISTS OF STANDARD CHARACTERS WITHOUT CLAIM TO ANY PARTICULAR FONT, STYLE, SIZE, OR COLOR.

FOR REAGENTS AND ENZYMES FOR MEDICAL USE (U.S. CLS. 6, 18, 44, 46, 51 AND 52).
MATTHEW EINSTEIN, EXAMINING ATTORNEY

CLASS 5—(Continued).

SN 77-567,163. ALACER CORPORATION, FOOTHILL RANCH, CA. FILED 9-10-2008.

SHARE THE GOOD

THE MARK CONSISTS OF STANDARD CHARACTERS WITHOUT CLAIM TO ANY PARTICULAR FONT, STYLE, SIZE, OR COLOR.

FOR BEVERAGES, NAMELY, VITAMIN ENRICHED WATER (U.S. CLS. 6, 18, 44, 46, 51 AND 52).
SHANNON TWOHIG, EXAMINING ATTORNEY

SN 77-566,949. FAULTLESS STARCH/BON AMI COMPANY, KANSAS CITY, MO. FILED 9-10-2008.



THE MARK CONSISTS OF A FIST PUNCHING A CRAB. FOR HERBICIDES, NAMELY, WEEDKILLERS (U.S. CLS. 6, 18, 44, 46, 51 AND 52).

FIRST USE 6-19-2008; IN COMMERCE 6-19-2008.
KATINA MISTER, EXAMINING ATTORNEY

SN 77-567,345. CHARLES L. SCHEL, MCCORMICK, SC. FILED 9-11-2008.

BENECELL-N

THE MARK CONSISTS OF STANDARD CHARACTERS WITHOUT CLAIM TO ANY PARTICULAR FONT, STYLE, SIZE, OR COLOR.

FOR DIETARY AND NUTRITIONAL SUPPLEMENTS (U.S. CLS. 6, 18, 44, 46, 51 AND 52).
HOWARD B. LEVINE, EXAMINING ATTORNEY

SN 77-567,382. ROCKY L MARSHALL, LEXINGTON, OK. FILED 9-11-2008.

Beer Pong Shot

THE MARK CONSISTS OF STANDARD CHARACTERS WITHOUT CLAIM TO ANY PARTICULAR FONT, STYLE, SIZE, OR COLOR.

NO CLAIM IS MADE TO THE EXCLUSIVE RIGHT TO USE "SHOT", APART FROM THE MARK AS SHOWN.

FOR AMINO ACIDS FOR NUTRITIONAL PURPOSES; DIETARY AND NUTRITIONAL SUPPLEMENTS; DIETARY BEVERAGE SUPPLEMENTS FOR HUMAN CONSUMPTION IN LIQUID AND DRY MIX FORM FOR THERAPEUTIC PURPOSES; DIETARY FOOD SUPPLEMENTS; DIETARY SUPPLEMENTAL DRINKS; DIETARY SUPPLEMENTS; DIETARY SUPPLEMENTS FOR ANIMALS; DIETARY SUPPLEMENTS FOR HUMAN CONSUMPTION; DIETARY SUPPLEMENTS FOR PETS; DIETARY SUPPLEMENTS FOR PETS IN THE NATURE OF A POWDERED DRINK MIX; FEED SUPPLEMENTS FOR ANIMALS; FOOD SUPPLEMENTS; FOOD SUPPLEMENTS, NAMELY, ANTI-OXIDANTS; GROUND FLAX-SEED FIBER FOR USE AS A DIETARY SUPPLEMENT; HERBAL SUPPLEMENTS; HOMEOPATHIC SUPPLEMENTS; LIQUID NUTRITIONAL SUPPLEMENT; MEAL

SN 77-566,970. FLAGEOLI, LTD., LAS VEGAS, NV. FILED 9-10-2008.

ProRemedy

THE MARK CONSISTS OF STANDARD CHARACTERS WITHOUT CLAIM TO ANY PARTICULAR FONT, STYLE, SIZE, OR COLOR.

FOR MEDICATED SKIN CARE PREPARATIONS (U.S. CLS. 6, 18, 44, 46, 51 AND 52).
BILL DAWE, EXAMINING ATTORNEY

CLASS 5—(Continued).

REPLACEMENT AND DIETARY SUPPLEMENT DRINK MIXES; MINERAL FOOD SUPPLEMENTS; MINERAL NUTRITIONAL SUPPLEMENTS; MINERAL SUPPLEMENTS; NATURAL HERBAL SUPPLEMENTS; NATURAL SUPPLEMENTS FOR TREATING CANDIDA; NATURAL SUPPLEMENTS FOR TREATING DEPRESSION AND ANXIETY; NATURAL SUPPLEMENTS FOR TREATING ERECTILE DYSFUNCTION; NUTRACEUTICALS FOR USE AS A DIETARY SUPPLEMENT; NUTRITIONAL DRINK MIX FOR USE AS A MEAL REPLACEMENT; NUTRITIONAL DRINKS USED FOR MEAL REPLACEMENT; NUTRITIONAL ENERGY BARS FOR USE AS A MEAL SUBSTITUTE; NUTRITIONAL SHAKES FOR USE AS A MEAL SUBSTITUTE; NUTRITIONAL SUPPLEMENT IN THE NATURE OF A NUTRIENT-DENSE, PROTEIN-BASED DRINK MIX; NUTRITIONAL SUPPLEMENTS; VITAMIN AND MINERAL SUPPLEMENTS; VITAMIN SUPPLEMENT IN TABLET FORM FOR USE IN MAKING AN EFFERVESCENT BEVERAGE WHEN ADDED TO WATER; VITAMIN SUPPLEMENTS (U.S. CLS. 6, 18, 44, 46, 51 AND 52).
ANNE E. GUSTASON, EXAMINING ATTORNEY

SN 77-567,820. THE MEDICINES COMPANY, PARSIPPANY, NJ. FILED 9-11-2008.



THE MARK CONSISTS OF THE LETTER "C" AND HORIZONTAL BARS IN STYLIZED FORM.
FOR PHARMACEUTICAL PREPARATIONS FOR TREATMENT OF HYPERTENSION (U.S. CLS. 6, 18, 44, 46, 51 AND 52).
MAUREEN DALL, EXAMINING ATTORNEY

SN 77-568,078. PROTEIN SCIENCES CORPORATION, MERIDEN, CT. FILED 9-11-2008.

PANBLOK

THE MARK CONSISTS OF STANDARD CHARACTERS WITHOUT CLAIM TO ANY PARTICULAR FONT, STYLE, SIZE, OR COLOR.
FOR PHARMACEUTICAL PREPARATION, NAMELY, AN INFLUENZA VACCINE (U.S. CLS. 6, 18, 44, 46, 51 AND 52).
ZACHARY BELLO, EXAMINING ATTORNEY

CLASS 5—(Continued).

SN 77-568,154. CLEMENT PAPPAS COMPANY, INC., CARNEYS POINT, NJ. FILED 9-11-2008.

Delsea

THE MARK CONSISTS OF STANDARD CHARACTERS WITHOUT CLAIM TO ANY PARTICULAR FONT, STYLE, SIZE, OR COLOR.
OWNER OF U.S. REG. NO. 3,361,019.
FOR VITAMIN ENRICHED WATER; VITAMIN FORTIFIED BEVERAGES (U.S. CLS. 6, 18, 44, 46, 51 AND 52).
FIRST USE 7-1-2007; IN COMMERCE 7-1-2007.
SONYA STEPHENS, EXAMINING ATTORNEY

SN 77-568,305. TOWER LABORATORIES CORPORATION, NORTH LAS VEGAS, NV. FILED 9-11-2008.

HeartTech

THE MARK CONSISTS OF STANDARD CHARACTERS WITHOUT CLAIM TO ANY PARTICULAR FONT, STYLE, SIZE, OR COLOR.
FOR MIXED VITAMIN PREPARATIONS (U.S. CLS. 6, 18, 44, 46, 51 AND 52).
MAUREEN DALL, EXAMINING ATTORNEY

SN 77-571,945. AMAZON HERB CO., JUPITER, FL. FILED 9-17-2008.

CLEAR YOUR MIND BRIGHTEN
YOUR DAY!

THE MARK CONSISTS OF STANDARD CHARACTERS WITHOUT CLAIM TO ANY PARTICULAR FONT, STYLE, SIZE, OR COLOR.
FOR DIETARY SUPPLEMENTS (U.S. CLS. 6, 18, 44, 46, 51 AND 52).
FIRST USE 1-1-2006; IN COMMERCE 1-1-2006.
TRACY WHITTAKER-BROWN, EXAMINING ATTORNEY

CLASS 5—(Continued).

SN 77-572,796. MISSION PHARMACAL COMPANY, SAN ANTONIO, TX. FILED 9-18-2008.

**CALCET-THE TINY YELLOW
TABLET**

THE MARK CONSISTS OF STANDARD CHARACTERS WITHOUT CLAIM TO ANY PARTICULAR FONT, STYLE, SIZE, OR COLOR.

OWNER OF U.S. REG. NO. 1,163,374.

NO CLAIM IS MADE TO THE EXCLUSIVE RIGHT TO USE "TINY YELLOW TABLET", APART FROM THE MARK AS SHOWN.

FOR PHARMACEUTICAL PREPARATIONS FOR A DIETARY CALCIUM SUPPLEMENT (U.S. CLS. 6, 18, 44, 46, 51 AND 52).

DOMINICK J. SALEMI, EXAMINING ATTORNEY

CLASS 5—(Continued).

SN 77-576,266. C.B. FLEET INVESTMENT CORPORATION, WILMINGTON, DE. FILED 9-23-2008.

HYDRALIFE

THE MARK CONSISTS OF STANDARD CHARACTERS WITHOUT CLAIM TO ANY PARTICULAR FONT, STYLE, SIZE, OR COLOR.

OWNER OF U.S. REG. NO. 3,197,698.

FOR PHARMACEUTICAL PREPARATIONS, NAMELY, LIQUIDS AND TABLETS FOR TREATMENT OF DEHYDRATION (U.S. CLS. 6, 18, 44, 46, 51 AND 52).

ROBIN CHOSID, EXAMINING ATTORNEY

SN 77-573,218. IMAGENETIX, SAN DIEGO, CA. FILED 9-18-2008.

Cellsorb

THE MARK CONSISTS OF STANDARD CHARACTERS WITHOUT CLAIM TO ANY PARTICULAR FONT, STYLE, SIZE, OR COLOR.

FOR INGREDIENT SOLD AND USED AS AN INTEGRAL COMPONENT OF A DIETARY SUPPLEMENT (U.S. CLS. 6, 18, 44, 46, 51 AND 52).

GIANCARLO CASTRO, EXAMINING ATTORNEY

SN 77-575,552. NOVARTIS AG, BASEL, SWITZERLAND, FILED 9-22-2008.

BRAVEO

THE MARK CONSISTS OF STANDARD CHARACTERS WITHOUT CLAIM TO ANY PARTICULAR FONT, STYLE, SIZE, OR COLOR.

FOR VACCINES FOR HUMAN USE (U.S. CLS. 6, 18, 44, 46, 51 AND 52).

WENDY GOODMAN, EXAMINING ATTORNEY

SN 77-576,275. NOVARTIS AG, BASEL, SWITZERLAND, FILED 9-23-2008.

OJUVIP

THE MARK CONSISTS OF STANDARD CHARACTERS WITHOUT CLAIM TO ANY PARTICULAR FONT, STYLE, SIZE, OR COLOR.

FOR PHARMACEUTICAL PREPARATIONS FOR THE PREVENTION AND TREATMENT OF DISORDERS OF THE NERVOUS SYSTEM, THE IMMUNE SYSTEM, THE CARDIO-VASCULAR SYSTEM, THE METABOLIC SYSTEM, THE RESPIRATORY SYSTEM, THE MUSCULO-SKELETAL SYSTEM, THE GENITOURINARY SYSTEM; FOR THE TREATMENT OF INFLAMMATORY DISORDERS; FOR USE IN DERMATOLOGY, ONCOLOGY, HEMATOLOGY AND IN TISSUE AND ORGAN TRANSPLANTATION, IN OPHTHALMOLOGY AND FOR GASTROENTEROLOGICAL DISORDERS; PHARMACEUTICAL PREPARATIONS FOR THE PREVENTION OF OCULAR DISORDERS OR DISEASES, FOR THE PREVENTION OF BACTERIA-BASED DISEASES, AND FOR THE PREVENTION OF DIABETES, AND ANTI-INFECTIVE PREPARATIONS, ANTIVIRAL PREPARATIONS, ANTIBIOTICS, ANTIFUNGAL PREPARATIONS; PHARMACEUTICAL PREPARATIONS FOR THE TREATMENT OF OCULAR DISORDERS OR DISEASES, FOR THE TREATMENT OF BACTERIA-BASED DISEASES, AND FOR THE TREATMENT OF DIABETES, AND ANTI-INFECTIVE PREPARATIONS, ANTIVIRAL PREPARATIONS, ANTIBIOTICS, ANTIFUNGAL PREPARATIONS (U.S. CLS. 6, 18, 44, 46, 51 AND 52).

WENDY GOODMAN, EXAMINING ATTORNEY

CLASS 5—(Continued).

SN 77-576,277. NOVARTIS AG, BASEL, SWITZERLAND,
FILED 9-23-2008.

JOURTIP

THE MARK CONSISTS OF STANDARD CHARACTERS WITHOUT CLAIM TO ANY PARTICULAR FONT, STYLE, SIZE, OR COLOR.

FOR PHARMACEUTICAL PREPARATIONS FOR THE PREVENTION AND TREATMENT OF DISORDERS OF THE NERVOUS SYSTEM, THE IMMUNE SYSTEM, THE CARDIO-VASCULAR SYSTEM, THE METABOLIC SYSTEM, THE RESPIRATORY SYSTEM, THE MUSCULO-SKELETAL SYSTEM, THE GENITOURINARY SYSTEM; FOR THE TREATMENT OF INFLAMMATORY DISORDERS; FOR USE IN DERMATOLOGY, ONCOLOGY, HEMATOLOGY AND IN TISSUE AND ORGAN TRANSPLANTATION, IN OPHTHALMOLOGY AND FOR GASTROENTEROLOGICAL DISORDERS; PHARMACEUTICAL PREPARATIONS FOR THE PREVENTION OF OCULAR DISORDERS OR DISEASES, FOR THE PREVENTION OF BACTERIA-BASED DISEASES, AND FOR THE PREVENTION OF DIABETES, AND ANTI-INFECTIVE PREPARATIONS, ANTIVIRAL PREPARATIONS, ANTIBIOTICS, ANTIFUNGAL PREPARATIONS; PHARMACEUTICAL PREPARATIONS FOR THE TREATMENT OF OCULAR DISORDERS OR DISEASES, FOR THE TREATMENT OF BACTERIA-BASED DISEASES, AND FOR THE TREATMENT OF DIABETES, AND ANTI-INFECTIVE PREPARATIONS, ANTIVIRAL PREPARATIONS, ANTIBIOTICS, ANTIFUNGAL PREPARATIONS (U.S. CLS. 6, 18, 44, 46, 51 AND 52).

WENDY GOODMAN, EXAMINING ATTORNEY

CLASS 5—(Continued).

SN 77-576,279. NOVARTIS AG, BASEL, SWITZERLAND,
FILED 9-23-2008.

JOUROLT

THE MARK CONSISTS OF STANDARD CHARACTERS WITHOUT CLAIM TO ANY PARTICULAR FONT, STYLE, SIZE, OR COLOR.

FOR PHARMACEUTICAL PREPARATIONS FOR THE PREVENTION AND TREATMENT OF DISORDERS OF THE NERVOUS SYSTEM, THE IMMUNE SYSTEM, THE CARDIO-VASCULAR SYSTEM, THE METABOLIC SYSTEM, THE RESPIRATORY SYSTEM, THE MUSCULO-SKELETAL SYSTEM, THE GENITOURINARY SYSTEM; FOR THE TREATMENT OF INFLAMMATORY DISORDERS; FOR USE IN DERMATOLOGY, ONCOLOGY, HEMATOLOGY AND IN TISSUE AND ORGAN TRANSPLANTATION, IN OPHTHALMOLOGY AND FOR GASTROENTEROLOGICAL DISORDERS; PHARMACEUTICAL PREPARATIONS FOR THE PREVENTION OF OCULAR DISORDERS OR DISEASES, FOR THE PREVENTION OF BACTERIA-BASED DISEASES, AND FOR THE PREVENTION OF DIABETES, AND ANTI-INFECTIVE PREPARATIONS, ANTIVIRAL PREPARATIONS, ANTIBIOTICS, ANTIFUNGAL PREPARATIONS; PHARMACEUTICAL PREPARATIONS FOR THE TREATMENT OF OCULAR DISORDERS OR DISEASES, FOR THE TREATMENT OF BACTERIA-BASED DISEASES, AND FOR THE TREATMENT OF DIABETES, AND ANTI-INFECTIVE PREPARATIONS, ANTIVIRAL PREPARATIONS, ANTIBIOTICS, ANTIFUNGAL PREPARATIONS (U.S. CLS. 6, 18, 44, 46, 51 AND 52).

WENDY GOODMAN, EXAMINING ATTORNEY

SN 77-576,280. NOVARTIS AG, BASEL, SWITZERLAND,
FILED 9-23-2008.

INTIQUESS

THE MARK CONSISTS OF STANDARD CHARACTERS WITHOUT CLAIM TO ANY PARTICULAR FONT, STYLE, SIZE, OR COLOR.

FOR PHARMACEUTICAL PREPARATIONS FOR USE IN DERMATOLOGY (U.S. CLS. 6, 18, 44, 46, 51 AND 52).

WENDY GOODMAN, EXAMINING ATTORNEY

CLASS 5—(Continued).

SN 77-576,283. NOVARTIS AG, BASEL, SWITZERLAND, FILED 9-23-2008.

IMPSOBON

THE MARK CONSISTS OF STANDARD CHARACTERS WITHOUT CLAIM TO ANY PARTICULAR FONT, STYLE, SIZE, OR COLOR.
FOR PHARMACEUTICAL PREPARATIONS FOR USE IN DERMATOLOGY (U.S. CLS. 6, 18, 44, 46, 51 AND 52).
WENDY GOODMAN, EXAMINING ATTORNEY

SN 77-577,349. NOVARTIS AG, BASEL, SWITZERLAND, FILED 9-24-2008.

ASCRIPTIN

THE MARK CONSISTS OF STANDARD CHARACTERS WITHOUT CLAIM TO ANY PARTICULAR FONT, STYLE, SIZE, OR COLOR.
FOR PHAMACEUTICAL PREPARATIONS, NAMELY, ANALGESIC PREPARATIONS (U.S. CLS. 6, 18, 44, 46, 51 AND 52).
FIRST USE 7-15-1955; IN COMMERCE 7-15-1955.
WENDY GOODMAN, EXAMINING ATTORNEY

SN 77-584,030. NOVARTIS AG, BASEL, SWITZERLAND, FILED 10-2-2008.

TYZEKA

THE MARK CONSISTS OF STANDARD CHARACTERS WITHOUT CLAIM TO ANY PARTICULAR FONT, STYLE, SIZE, OR COLOR.
OWNER OF U.S. REG. NO. 3,164,642.
FOR PHARMACEUTICAL PREPARATIONS FOR THE TREATMENT OF HEPATITIS (U.S. CLS. 6, 18, 44, 46, 51 AND 52).
FIRST USE 11-1-2006; IN COMMERCE 11-1-2006.
WENDY GOODMAN, EXAMINING ATTORNEY

CLASS 5—(Continued).

SN 77-584,034. NOVARTIS AG, BASEL, SWITZERLAND, FILED 10-2-2008.

RECLAST

THE MARK CONSISTS OF STANDARD CHARACTERS WITHOUT CLAIM TO ANY PARTICULAR FONT, STYLE, SIZE, OR COLOR.
OWNER OF U.S. REG. NO. 2,895,114.
FOR PHARMACEUTICAL PREPARATIONS FOR THE TREATMENT OF PAGET'S DISEASE, FOR THE PREVENTION AND TREATMENT OF BONE DISEASES INCLUDING THE TREATMENT OF OSTEOPOROSIS (U.S. CLS. 6, 18, 44, 46, 51 AND 52).
FIRST USE 6-1-2007; IN COMMERCE 6-1-2007.
WENDY GOODMAN, EXAMINING ATTORNEY

SN 77-584,934. DRUGTECH CORPORATION, WILMINGTON, DE. FILED 10-3-2008.

MATRIXIA

THE MARK CONSISTS OF STANDARD CHARACTERS WITHOUT CLAIM TO ANY PARTICULAR FONT, STYLE, SIZE, OR COLOR.
FOR PHARMACEUTICAL PRODUCTS FOR BUILDING AND STRENGTHENING BONES, AND FOR ORGANIC AND MINERAL BONE HEALTH (U.S. CLS. 6, 18, 44, 46, 51 AND 52).
RICHARD A. STRASER, EXAMINING ATTORNEY

SN 77-587,845. CELSIUS HOLDINGS, INC., DELRAY BEACH, FL. FILED 10-7-2008.

Vitaburn

THE MARK CONSISTS OF STANDARD CHARACTERS WITHOUT CLAIM TO ANY PARTICULAR FONT, STYLE, SIZE, OR COLOR.
FOR DIETARY AND NUTRITIONAL SUPPLEMENTS; DIETARY FOOD SUPPLEMENTS; DIETARY SUPPLEMENTS; POWDERED FRUIT-FLAVORED DIETARY SUPPLEMENT DRINK MIX; POWDERED NUTRITIONAL SUPPLEMENT DRINK MIX; VITAMIN SUPPLEMENTS (U.S. CLS. 6, 18, 44, 46, 51 AND 52).
JENNIFER MARTIN, EXAMINING ATTORNEY

CLASS 5—(Continued).

SN 77-591,317. HEALTHY PETS, INC., UNION CITY, CA.
FILED 10-13-2008.

RELEASE YOUR DOG'S INNER
PUPPY

THE MARK CONSISTS OF STANDARD CHARACTERS
WITHOUT CLAIM TO ANY PARTICULAR FONT, STYLE,
SIZE, OR COLOR.
FOR NUTRITIONAL SUPPLEMENT FOR ANIMALS
(U.S. CLS. 6, 18, 44, 46, 51 AND 52).
FIRST USE 5-10-2008; IN COMMERCE 5-10-2008.
ANDREA K. NADELMAN, EXAMINING ATTORNEY

SN 77-598,713. M D SCIENCE LAB, LLC, FORT LAUDER-
DALE, FL. FILED 10-23-2008.

SWISS NAVY

THE MARK CONSISTS OF STANDARD CHARACTERS
WITHOUT CLAIM TO ANY PARTICULAR FONT, STYLE,
SIZE, OR COLOR.
OWNER OF U.S. REG. NO. 3,407,031.
FOR HERBAL DIETARY SUPPLEMENTS (U.S. CLS. 6,
18, 44, 46, 51 AND 52).
FIRST USE 6-0-2006; IN COMMERCE 8-0-2006.
JOHN DWYER, EXAMINING ATTORNEY

SN 77-599,904. NOVARTIS AG, BASEL, SWITZERLAND,
FILED 10-24-2008.

EXCEGO

THE MARK CONSISTS OF STANDARD CHARACTERS
WITHOUT CLAIM TO ANY PARTICULAR FONT, STYLE,
SIZE, OR COLOR.
FOR ANALGESICS (U.S. CLS. 6, 18, 44, 46, 51 AND 52).
WENDY GOODMAN, EXAMINING ATTORNEY

CLASS 5—(Continued).

SN 77-608,947. T. J. SMITH & NEPHEW, LIMITED, HULL,
UNITED KINGDOM, FILED 11-6-2008.

ALLECEL

THE MARK CONSISTS OF STANDARD CHARACTERS
WITHOUT CLAIM TO ANY PARTICULAR FONT, STYLE,
SIZE, OR COLOR.
FOR MEDICAL AND SURGICAL DRESSINGS;
WOUND DRESSINGS (U.S. CLS. 6, 18, 44, 46, 51 AND 52).
RON FAIRBANKS, EXAMINING ATTORNEY

SN 77-624,855. NOVARTIS AG, BASEL, SWITZERLAND,
FILED 12-2-2008.

EXCEDRA

THE MARK CONSISTS OF STANDARD CHARACTERS
WITHOUT CLAIM TO ANY PARTICULAR FONT, STYLE,
SIZE, OR COLOR.
FOR PREPARATION FOR THE RELIEF OF PAIN (U.S.
CLS. 6, 18, 44, 46, 51 AND 52).
WENDY GOODMAN, EXAMINING ATTORNEY

SN 77-624,871. NOVARTIS AG, BASEL, SWITZERLAND,
FILED 12-2-2008.

EXCELLA

THE MARK CONSISTS OF STANDARD CHARACTERS
WITHOUT CLAIM TO ANY PARTICULAR FONT, STYLE,
SIZE, OR COLOR.
FOR PREPARATION FOR THE RELIEF OF PAIN (U.S.
CLS. 6, 18, 44, 46, 51 AND 52).
WENDY GOODMAN, EXAMINING ATTORNEY

CLASS 5—(Continued).

SN 78-927,678. ENDURANCE PRODUCTS COMPANY, TIGARD, OR. FILED 7-12-2006.

ENDUR-VM

THE MARK CONSISTS OF STANDARD CHARACTERS WITHOUT CLAIM TO ANY PARTICULAR FONT, STYLE, SIZE, OR COLOR.

OWNER OF U.S. REG. NOS. 1,444,825 AND 1,704,518. FOR DIETARY AND NUTRITIONAL SUPPLEMENTS (U.S. CLS. 6, 18, 44, 46, 51 AND 52). FIRST USE 9-18-1986; IN COMMERCE 9-18-1986. BARNEY CHARLON, EXAMINING ATTORNEY

SN 78-927,683. ENDURANCE PRODUCTS COMPANY, TIGARD, OR. FILED 7-12-2006.

ENDUR-C

THE MARK CONSISTS OF STANDARD CHARACTERS WITHOUT CLAIM TO ANY PARTICULAR FONT, STYLE, SIZE, OR COLOR.

OWNER OF U.S. REG. NOS. 1,444,825 AND 1,704,518. FOR DIETARY AND NUTRITIONAL SUPPLEMENTS (U.S. CLS. 6, 18, 44, 46, 51 AND 52). FIRST USE 9-18-1986; IN COMMERCE 9-18-1986. BARNEY CHARLON, EXAMINING ATTORNEY

SN 78-927,694. ENDURANCE PRODUCTS COMPANY, TIGARD, OR. FILED 7-12-2006.

ENDUR-B

THE MARK CONSISTS OF STANDARD CHARACTERS WITHOUT CLAIM TO ANY PARTICULAR FONT, STYLE, SIZE, OR COLOR.

OWNER OF U.S. REG. NOS. 1,444,825 AND 1,704,518. FOR DIETARY AND NUTRITIONAL SUPPLEMENTS (U.S. CLS. 6, 18, 44, 46, 51 AND 52). FIRST USE 9-18-1986; IN COMMERCE 9-18-1986. BARNEY CHARLON, EXAMINING ATTORNEY

CLASS 5—(Continued).

SN 79-051,323. SANOFI-AVENTIS, FRANCE, FILED 2-18-2008.



PRIORITY DATE OF 9-3-2007 IS CLAIMED. OWNER OF INTERNATIONAL REGISTRATION 0957186 DATED 2-18-2008, EXPIRES 2-18-2018.

NO CLAIM IS MADE TO THE EXCLUSIVE RIGHT TO USE "MALARIA", APART FROM THE MARK AS SHOWN.

THE COLOR(S) GREEN, YELLOW, ORANGE, RED AND BLUE IS/ARE CLAIMED AS A FEATURE OF THE MARK. THE MARK CONSISTS OF THE WORDING "IMPACT MALARIA" PRINTED IN BLUE, THE OVAL BASE OF THE DESIGN IS BLUE, THE HEART-SHAPED FIGURE ON THE LEFT IS GREEN AND YELLOW, THE MIDDLE HEART-SHAPED FIGURE IS ORANGE, AND THE HEART-SHAPED FIGURE ON THE RIGHT IS RED.

FOR PHARMACEUTICAL PREPARATIONS FOR THE TREATMENT AND PREVENTION OF MALARIA; SANITARY PREPARATIONS FOR MEDICAL USE; VACCINES; FOOD FOR BABIES; MEDICAL PLASTERS AND MEDICAL DRESSINGS (U.S. CLS. 6, 18, 44, 46, 51 AND 52).

PATRICIA EVANKO, EXAMINING ATTORNEY

CLASS 6—METAL GOODS

SN 76-690,827. SNAP-TITE TECHNOLOGIES, INC., WILMINGTON, DE. FILED 6-24-2008.

N-DURA

THE MARK CONSISTS OF STANDARD CHARACTERS WITHOUT CLAIM TO ANY PARTICULAR FONT, STYLE, SIZE, OR COLOR.

OWNER OF U.S. REG. NO. 976,811. FOR METAL COATINGS SOLD AS AN INTEGRAL COMPONENT OF MANUALLY OPERATED METAL VALVES (U.S. CLS. 2, 12, 13, 14, 23, 25 AND 50). FIRST USE 6-0-2000; IN COMMERCE 6-0-2000. BARBARA RUTLAND, EXAMINING ATTORNEY

CLASS 6—(Continued).

SN 76-692,916. FETTEROLF CORPORATION, SKIPPACK, PA. FILED 9-17-2008.

STACEY

THE MARK CONSISTS OF STANDARD CHARACTERS WITHOUT CLAIM TO ANY PARTICULAR FONT, STYLE, SIZE, OR COLOR.

FOR MANUALLY OPERATED METAL VALVES USED IN HANDLING PETROLEUM PRODUCTS, WATER, GAS AND CHEMICALS (U.S. CLS. 2, 12, 13, 14, 23, 25 AND 50).
FIRST USE 1-5-1979; IN COMMERCE 1-5-1979.
LINDA E. BLOHM, EXAMINING ATTORNEY

SN 77-027,201. TITFLEX CORPORATION, SPRINGFIELD, MA. FILED 10-23-2006.

FLEXSURE

THE MARK CONSISTS OF STANDARD CHARACTERS WITHOUT CLAIM TO ANY PARTICULAR FONT, STYLE, SIZE, OR COLOR.

FOR FLEXIBLE METAL TUBES, PIPES, HOSE AND ASSEMBLIES THEREOF FOR USE IN THE AEROSPACE, AUTOMOTIVE, AVIATION, CHEMICAL PROCESSING, ELECTRICAL, FOOD HANDLING, COMMERCIAL BUILDING AND RESIDENTIAL HOUSING AND MARINE INDUSTRIES (U.S. CLS. 2, 12, 13, 14, 23, 25 AND 50).
PAUL CROWLEY, EXAMINING ATTORNEY

SN 77-225,637. ALLIANCE STEEL, INC., OKLAHOMA CITY, OK. FILED 7-10-2007.



FOR PRE-ENGINEERED BUILDINGS MADE OF METAL, NAMELY, PREFABRICATED BUILDINGS MADE OF METAL; COMPONENTS FOR PRE-ENGINEERED BUILDINGS MADE OF METAL, NAMELY, METAL FRAMING, METAL BEAMS, METAL CEILING AND DOOR PANELS, METAL TRIM, METAL FLASHING AND METAL GUTTERS (U.S. CLS. 2, 12, 13, 14, 23, 25 AND 50).

FIRST USE 7-1-1971; IN COMMERCE 7-1-1971.
LESLIE RICHARDS, EXAMINING ATTORNEY

CLASS 6—(Continued).

SN 77-333,808. COMERCIAL DE HERRAMIENTAS, S.A. DE C.V., APODACA, MEXICO, FILED 11-20-2007.

TOOLCRAFT

THE MARK CONSISTS OF STANDARD CHARACTERS WITHOUT CLAIM TO ANY PARTICULAR FONT, STYLE, SIZE, OR COLOR.

FOR METAL CHAINS; METAL CLAMPS; METAL HOOKS; METAL HOSE CLAMPS; METAL OIL CANS SOLD EMPTY; METAL SHELF BRACKETS; WIRE; WIRE ROPES; METAL KEYS FOR LOCKS; METAL LOCKS; METAL LOCKS AND KEYS THEREFOR; METAL CABLE WIRE; METAL HINGES; WIRE MESH; METAL HOSES FOR PLUMBING USE; METAL TOOL BOXES (U.S. CLS. 2, 12, 13, 14, 23, 25 AND 50).
NELSON SNYDER, EXAMINING ATTORNEY

SN 77-400,620. LAXON CORPORATION, TORRANCE, CA. FILED 2-19-2008.

KEYKLASP

THE MARK CONSISTS OF STANDARD CHARACTERS WITHOUT CLAIM TO ANY PARTICULAR FONT, STYLE, SIZE, OR COLOR.

OWNER OF U.S. REG. NO. 2,596,277.
SEC. 2(F).
FOR METAL KEY HOLDERS; METAL KEY RINGS (U.S. CLS. 2, 12, 13, 14, 23, 25 AND 50).
FIRST USE 3-0-2001; IN COMMERCE 3-0-2001.
CAROLYN CATALDO, EXAMINING ATTORNEY

SN 77-409,980. ENJOU CO., LTD., TAIPAO CITY 612, TAIWAN, FILED 2-29-2008.



OWNER OF TAIWAN REG. NO. 01010802, DATED 8-16-2002, EXPIRES 8-15-2012.

THE MARK CONSISTS OF WORD "ENJOU" INSIDE A WHEEL OF A STYLIZED CASTER.

FOR METAL CASTERS AND WHEELS (U.S. CLS. 2, 12, 13, 14, 23, 25 AND 50).
HENRY S. ZAK, EXAMINING ATTORNEY

CLASS 6—(Continued).

SN 77-416,390. LF, LLC, WILMINGTON, DE. FILED 3-7-2008.

GATEHOUSE

THE MARK CONSISTS OF STANDARD CHARACTERS WITHOUT CLAIM TO ANY PARTICULAR FONT, STYLE, SIZE, OR COLOR.

FOR MAGNETIC CABINET DOOR CATCHES, NAMELY, BALL CATCHES; SASHES, NAMELY, SASH LOCKS FOR DOORS AND WINDOWS; IRONS AND MENDING PLATES FOR USE IN FURNITURE AND SMALL DOOR REPAIRS; MAIL SLOT SLEEVES; DOOR KNOCKERS; HANDRAIL BRACKETS; CLOSET PULL SOCKETS; HINGE PULLS; DOOR HOLDERS; DOOR BOLTS; SCREW EYES; HASPS; ALL PRIMARILY MADE OF METAL (U.S. CLS. 2, 12, 13, 14, 23, 25 AND 50).
ANDREA HACK, EXAMINING ATTORNEY

CLASS 6—(Continued).

SN 77-497,572. ZAGO MANUFACTURING COMPANY, INC., NEWARK, NJ. FILED 6-12-2008.

ZAGO

THE MARK CONSISTS OF STANDARD CHARACTERS WITHOUT CLAIM TO ANY PARTICULAR FONT, STYLE, SIZE, OR COLOR.

FOR METAL HARDWARE, NAMELY, METAL SEALING FASTENERS, METAL SELF-SEALING FASTENERS, SCREWS, SEAL SCREWS, PANEL SCREWS, SEAL PLUGS, NUTS (U.S. CLS. 2, 12, 13, 14, 23, 25 AND 50).
FIRST USE 5-20-1993; IN COMMERCE 5-20-1993.
SUSAN RICHARDS, EXAMINING ATTORNEY

SN 77-426,921. ZELL, LOTHAR J., MONTGOMERY, AL. FILED 3-20-2008.

POOL SPOOL

THE MARK CONSISTS OF STANDARD CHARACTERS WITHOUT CLAIM TO ANY PARTICULAR FONT, STYLE, SIZE, OR COLOR.

NO CLAIM IS MADE TO THE EXCLUSIVE RIGHT TO USE "POOL", APART FROM THE MARK AS SHOWN.
FOR HAND-OPERATED METAL RETRACTABLE REELS FOR INSTALLING, REMOVING AND STORAGE OF COVERS FOR SWIMMING POOLS (U.S. CLS. 2, 12, 13, 14, 23, 25 AND 50).
FIRST USE 2-18-2008; IN COMMERCE 2-18-2008.
RON FAIRBANKS, EXAMINING ATTORNEY

SN 77-512,001. C.F.F.F. CORP., BRIDGEVIEW, IL. FILED S.R. 7-1-2008; AM. P.R. 12-15-2008.

FF

THE MARK CONSISTS OF STANDARD CHARACTERS WITHOUT CLAIM TO ANY PARTICULAR FONT, STYLE, SIZE, OR COLOR.

OWNER OF U.S. REG. NO. 2,682,821.
FOR METAL THREADED FASTENERS (U.S. CLS. 2, 12, 13, 14, 23, 25 AND 50).
FIRST USE 1-1-1998; IN COMMERCE 1-1-1998.
JACLYN KIDWELL, EXAMINING ATTORNEY

SN 77-448,309. DMI INDUSTRIES, INC., FARGO, ND. FILED 4-15-2008.



OWNER OF U.S. REG. NOS. 2,793,814 AND 2,793,815.
NO CLAIM IS MADE TO THE EXCLUSIVE RIGHT TO USE "INDUSTRIES", APART FROM THE MARK AS SHOWN.

THE MARK CONSISTS OF THE LETTERS, "DMI", DIRECTLY ON TOP OF THE WORD, "INDUSTRIES".
FOR TOWERS FOR RENEWABLE ENERGY APPLICATIONS, NAMELY, METAL POLES FOR USE IN CONNECTION WITH RENEWABLE ENERGY APPLICATIONS (U.S. CLS. 2, 12, 13, 14, 23, 25 AND 50).
FIRST USE 5-31-2004; IN COMMERCE 5-31-2004.
JAY BESCH, EXAMINING ATTORNEY

SN 77-533,702. WIREWAY/HUSKY CORP., DENVER, NC. FILED 7-29-2008.

EZ-MATRIX

THE MARK CONSISTS OF STANDARD CHARACTERS WITHOUT CLAIM TO ANY PARTICULAR FONT, STYLE, SIZE, OR COLOR.

OWNER OF U.S. REG. NOS. 1,906,297 AND 1,978,674.
FOR PARTITIONS OF METAL (U.S. CLS. 2, 12, 13, 14, 23, 25 AND 50).
ANDREA BUTLER, EXAMINING ATTORNEY

CLASS 6—(Continued).

SN 77-535,729. PEERLESS INDUSTRIES, INC., MELROSE PARK, IL. FILED 7-31-2008.

SLIMLINE

THE MARK CONSISTS OF STANDARD CHARACTERS WITHOUT CLAIM TO ANY PARTICULAR FONT, STYLE, SIZE, OR COLOR.

OWNER OF U.S. REG. NO. 1,553,605.
FOR METAL TELEVISION WALL MOUNTS (U.S. CLS. 2, 12, 13, 14, 23, 25 AND 50).
CAROLYN CATALDO, EXAMINING ATTORNEY

SN 77-557,165. L. B. FOSTER COMPANY, PITTSBURGH, PA. FILED 8-27-2008.

ENDURA-JOINT

THE MARK CONSISTS OF STANDARD CHARACTERS WITHOUT CLAIM TO ANY PARTICULAR FONT, STYLE, SIZE, OR COLOR.

FOR BONDED INSULATED RAIL JOINTS (U.S. CLS. 2, 12, 13, 14, 23, 25 AND 50).
DEZMONA MIZELLE, EXAMINING ATTORNEY

SN 77-562,369. TECNOCAP LLC, GLEN DALE, WV. FILED 9-4-2008.

UNISHELL

THE MARK CONSISTS OF STANDARD CHARACTERS WITHOUT CLAIM TO ANY PARTICULAR FONT, STYLE, SIZE, OR COLOR.

FOR CLOSURES MADE OF METAL FOR CONTAINERS (U.S. CLS. 2, 12, 13, 14, 23, 25 AND 50).
FIRST USE 12-31-1991; IN COMMERCE 12-31-1991.
JOHN E. MICHOS, EXAMINING ATTORNEY

CLASS 6—(Continued).

SN 77-563,583. THE GAGE CORPORATION, INT., SPARTA, WI. FILED 9-5-2008.

GAGECARVE

THE MARK CONSISTS OF STANDARD CHARACTERS WITHOUT CLAIM TO ANY PARTICULAR FONT, STYLE, SIZE, OR COLOR.

OWNER OF U.S. REG. NOS. 2,206,974, 3,041,182 AND OTHERS.

FOR ARCHITECTURAL AND DECORATIVE BUILDING MATERIALS HAVING METAL FINISHES, NAMELY, PANELS, TILES, AND CLADDING FOR INTERIOR AND EXTERIOR BUILDING USE; WALL, DOOR AND ELEVATOR SURFACE PANELS, TILES, AND CLADDING, ALL OF THE FOREGOING HAVING METAL FINISHES AND USED FOR BUILDING PURPOSES (U.S. CLS. 2, 12, 13, 14, 23, 25 AND 50).
FIRST USE 8-0-2008; IN COMMERCE 8-0-2008.

DAVID MILLER, EXAMINING ATTORNEY

SN 77-563,749. HCI STEEL BUILDING SYSTEMS, INC., ARLINGTON, WA. FILED 9-5-2008.

HCI

THE MARK CONSISTS OF STANDARD CHARACTERS WITHOUT CLAIM TO ANY PARTICULAR FONT, STYLE, SIZE, OR COLOR.

FOR PRE-FABRICATED METAL BUILDINGS (U.S. CLS. 2, 12, 13, 14, 23, 25 AND 50).
FIRST USE 10-0-1982; IN COMMERCE 10-0-1982.

ALEXANDER L. POWERS, EXAMINING ATTORNEY

SN 77-565,896. RACHATA LEELAPRACHAKUL, SAMPHANTHAWONG., THAILAND, FILED 9-9-2008.

EXTUBA

THE MARK CONSISTS OF THE WORD "EXTUBA" SURROUNDED BY A RECTANGLE.

FOR PIPEWORK OF METAL; PIPEWORK OF ALLOY METAL; METAL PIPES; STAINLESS STEEL PIPES (U.S. CLS. 2, 12, 13, 14, 23, 25 AND 50).

JAMES A. RAUEN, EXAMINING ATTORNEY

CLASS 6—(Continued).

SN 77-566,185. TUBELITE INC., WALKER, MI. FILED 9-9-2008.

FORCEFRONT

THE MARK CONSISTS OF STANDARD CHARACTERS WITHOUT CLAIM TO ANY PARTICULAR FONT, STYLE, SIZE, OR COLOR.

FOR DOORS, WINDOWS, CURTAINWALLS, AND STORE-FRONT FRAMING, ALL PRIMARILY OF METAL (U.S. CLS. 2, 12, 13, 14, 23, 25 AND 50).

WILLIAM ROSSMAN, EXAMINING ATTORNEY



SN 77-566,268. CLOPAY BUILDING PRODUCTS COMPANY, INC., MASON, OH. FILED 9-10-2008.

ULTRAGRAIN

THE MARK CONSISTS OF STANDARD CHARACTERS WITHOUT CLAIM TO ANY PARTICULAR FONT, STYLE, SIZE, OR COLOR.

FOR DOORS OF METAL; METAL GARAGE DOORS (U.S. CLS. 2, 12, 13, 14, 23, 25 AND 50).

JENNIFER VASQUEZ, EXAMINING ATTORNEY



SN 77-568,115. SAUL ZAENTZ COMPANY, THE, BERKELEY, CA. FILED 9-11-2008.

SARUMAN

THE MARK CONSISTS OF STANDARD CHARACTERS WITHOUT CLAIM TO ANY PARTICULAR FONT, STYLE, SIZE, OR COLOR.

OWNER OF U.S. REG. NOS. 2,813,983, 3,375,758 AND OTHERS.

FOR ENAMEL KEYCHAINS OF METAL (U.S. CLS. 2, 12, 13, 14, 23, 25 AND 50).

FIRST USE 11-11-2003; IN COMMERCE 2-13-2008.

ELISSA GARBER KON, EXAMINING ATTORNEY

CLASS 6—(Continued).

SN 77-578,579. FOLDING GUARD COMPANY, BEDFORD PARK, IL. FILED 9-25-2008.

HARDGUARD

THE MARK CONSISTS OF STANDARD CHARACTERS WITHOUT CLAIM TO ANY PARTICULAR FONT, STYLE, SIZE, OR COLOR.

FOR METAL GUARD BARRIERS FOR MACHINE SAFETY AND ACCESS CONTROL, NAMELY, METAL PERIMETER AND MACHINE GUARDING UNITS (U.S. CLS. 2, 12, 13, 14, 23, 25 AND 50).

KELLY BOULTON, EXAMINING ATTORNEY



SN 77-580,299. BLOCK AND COMPANY, INC., WHEELING, IL. FILED 9-26-2008.

STEELMASTER

THE MARK CONSISTS OF STANDARD CHARACTERS WITHOUT CLAIM TO ANY PARTICULAR FONT, STYLE, SIZE, OR COLOR.

OWNER OF U.S. REG. NOS. 3,488,158 AND 3,498,227. FOR METAL CASH DRAWERS AND KEY CABINETS (U.S. CLS. 2, 12, 13, 14, 23, 25 AND 50).

RONALD MCMORROW, EXAMINING ATTORNEY



SN 77-607,242. CHROME HEARTS LLC, HOLLYWOOD, CA. FILED 11-4-2008.



OWNER OF U.S. REG. NO. 2,954,539.

THE MARK CONSISTS OF THE LETTERS "C" AND "H" IN AN "OLD ENGLISH FONT".

FOR DECORATIVE HARDWARE, NAMELY, METAL DOORKNOBS, METAL DOOR HANDLES, METAL DRAWER PULLS, METAL HINGES, AND METAL FASTENERS, NAMELY, BOLTS, SCREWS AND RIVETS (U.S. CLS. 2, 12, 13, 14, 23, 25 AND 50).

JENNIFER MARTIN, EXAMINING ATTORNEY

CLASS 6—(Continued).

SN 77-609,832. CLOPAY BUILDING PRODUCTS COMPANY, INC., MASON, OH. FILED 11-7-2008.

CANYON RIDGE

THE MARK CONSISTS OF STANDARD CHARACTERS WITHOUT CLAIM TO ANY PARTICULAR FONT, STYLE, SIZE, OR COLOR.

FOR METAL GARAGE DOORS (U.S. CLS. 2, 12, 13, 14, 23, 25 AND 50).

JENNIFER VASQUEZ, EXAMINING ATTORNEY

SN 79-045,074. VIMETCO MANAGEMENT GMBH, SWITZERLAND, FILED 9-12-2007.

vimetco 

PRIORITY DATE OF 5-10-2007 IS CLAIMED.

OWNER OF INTERNATIONAL REGISTRATION 0940579 DATED 9-12-2007, EXPIRES 9-12-2017.

FOR COMMON METALS AND THEIR ALLOYS, BUILDING MATERIALS OF METAL, NAMELY, SEMI-FINISHED PROFILES OF ALUMINUM OR ALUMINUM ALLOYS FOR USE IN WINDOWS, DOORS AND SIMILAR BUILDING MATERIALS, NOT INCLUDING USE FOR METAL ROOFING AND METAL WALL PANELS, NON-ELECTRIC CABLES AND WIRES OF COMMON METAL, PIPES AND TUBES MADE OF METAL, ALUMINUM SIDING, ALUMINUM ALLOYS, ALUMINUM INGOTS, ALUMINUM SHEETS, ALUMINUM PLATES AND EXTRUSIONS, ALUMINUM FOIL, ORES, NAMELY, BAUXITE AND ALUMINUM ORE (U.S. CLS. 2, 12, 13, 14, 23, 25 AND 50).

LYDIA BELZER, EXAMINING ATTORNEY

SN 79-051,367. JFE STEEL KABUSHIKI KAISHA; INTELLECTUAL PROPERTY DEPT., JAPAN, FILED 1-18-2008.

Mighty Seam

THE MARK CONSISTS OF STANDARD CHARACTERS WITHOUT CLAIM TO ANY PARTICULAR FONT, STYLE, SIZE, OR COLOR.

PRIORITY DATE OF 10-4-2007 IS CLAIMED.

OWNER OF INTERNATIONAL REGISTRATION 0957322 DATED 1-18-2008, EXPIRES 1-18-2018.

FOR STEEL IN SHEET, PIPE, TUBE, PLATE, BAR, BILLET, BLOOM, SLAB AND RAIL FORM; BUILDING AND CONSTRUCTION MATERIALS OF METAL, NAMELY, METAL DOOR FRAMES, STEEL FRAMES FOR BUILDING, METAL WINDOW FRAMES, METAL GREENHOUSE FRAMES, METAL CEILING PANELS, METAL ROOFING PANELS, WALL PANELS OF METAL, METAL DOOR PANELS, METAL FENCE PANELS; METAL JUNCTIONS AND METAL JOINTS FOR PIPES; METAL FLANGES; NAILS, PEGS, WASHERS, NUTS, SCREWS, PLUGS, BOLTS AND RIVETS, ALL MADE OF METAL (U.S. CLS. 2, 12, 13, 14, 23, 25 AND 50).

RONALD DELGIZZI, EXAMINING ATTORNEY

CLASS 6—(Continued).

SN 79-053,788. DEUTSCHE EDELSTAHLWERKE GMBH, FED REP GERMANY, FILED 3-14-2008.

DEUTSCHE EDELSTAHLWERKE

Providing special steel solutions



PRIORITY DATE OF 1-16-2008 IS CLAIMED.

OWNER OF INTERNATIONAL REGISTRATION 0964186 DATED 3-14-2008, EXPIRES 3-14-2018.

NO CLAIM IS MADE TO THE EXCLUSIVE RIGHT TO USE "DEUTSCHE EDELSTAHLWERKE", APART FROM THE MARK AS SHOWN.

THE COLOR(S) BLUE, GREY AND BLACK IS/ARE CLAIMED AS A FEATURE OF THE MARK.

THE MARK CONSISTS OF THE WORDING "DEUTSCHE EDELSTAHLWERKE" IN BLUE AND THE WORDING "PROVIDING SPECIAL STEEL SOLUTIONS" IN GREY WITH THE DESIGN OF FOUR GREY TRIANGLES WITHIN A BLUE HEXAGON OUTLINED IN BLACK.

THE FOREIGN WORDING IN THE MARK TRANSLATES INTO ENGLISH AS GERMAN SPECIAL STEEL WORKS.

FOR CRUDE AND SEMI-WROUGHT COMMON METALS, IN PARTICULAR STEEL, STAINLESS STEEL AND BRIGHT STEEL; STEEL, NAMELY, HALF-FINISHED PRODUCTS OF STEEL IN THE FORM OF RODS, PLATES, SHEETS, BILLETS, BLOCKS, WIRE, PROFILES, AND RINGS; AUXILIARY WELDING MATERIALS OF METAL, NAMELY, METAL WELDING RODS, WELDING WIRE (U.S. CLS. 2, 12, 13, 14, 23, 25 AND 50).

KRISTIN DAHLING, EXAMINING ATTORNEY

SN 79-054,279. HUNAN HUATIAN ALUMINIUM CO., LTD., CHINA, FILED 2-12-2008.



OWNER OF INTERNATIONAL REGISTRATION 0965418 DATED 2-12-2008, EXPIRES 2-12-2018.

THE MARK CONSISTS OF THREE STYLED LETTER "H" "T" "B".

FOR ALUMINUM AND ITS ALLOYS; ALUMINUM FOIL; ALUMINUM INGOTS; CASTINGS, FOILS, POWDER, AND ROLLED, DRAWN OR EXTRUDED SEMI-FINISHED ARTICLES OF ALUMINUM OR ITS ALLOYS; CLAD STEEL PLATES AND SHEETS; METAL NAME PLATES; METAL LICENSE PLATES; STEEL PLATES AND SHEETS; SLABS OF METAL INCLUDING THOSE FROM ALLOY STEEL AND TITANIUM; BARS FOR METAL RAILINGS; STEEL IN SHEET, ROD, BAR FORM; ALUMINUM TAPE USED TO JOIN PANELS FOR USE IN WALL, ATTIC, CEILING AND FLOORING APPLICATIONS IN THE BUILDING INDUSTRY; METAL CEILING TILES; CEILING SUPPORTS OF METAL; METAL SUSPENDED CEILING SYSTEMS COMPRISING PANELS; MAGNESIUM AND ITS ALLOYS; COPPER PANELS FOR CIRCUIT BOARDS; BUILDING MATERIALS, NAMELY COMPOSITE PANELS COMPOSED PRIMARILY OF METAL; METAL FIRE RESISTANT SAFES; TITANIUM ALLOY; TITANIUM UNWROUGHT OR SEMI-WROUGHT; METALLIC PIPES (U.S. CLS. 2, 12, 13, 14, 23, 25 AND 50).

CURTIS FRENCH, EXAMINING ATTORNEY

CLASS 6—(Continued).

SN 79-054,779. ZHEJIANG JIAXING ZHONGDA; GROUP CO., LTD., CHINA, FILED 3-13-2008.



PRIORITY DATE OF 11-7-2007 IS CLAIMED.
OWNER OF INTERNATIONAL REGISTRATION 0966958
DATED 3-13-2008, EXPIRES 3-13-2018.

THE MARK CONSISTS OF TWO CHINESE CHARACTERS ON THE LEFT AND THEIR PINYIN IN THE RIGHT.

THE ENGLISH TRANSLATION OF THE FOREIGN WORD(S) IN THE MARK IS: THE FIRST CHINESE CHARACTER MEANS "CENTRAL SECTION; MIDDLE PART"; THE SECOND CHINESE CHARACTER TRANSLATES TO "REACH OR EXPRESS"; THE MARK HAS NO MEANING IN BOTH ENGLISH AND CHINESE WHEN READ TOGETHER.

THE TWO CHINESE CHARACTERS CONTAINED IN THE MARK ARE TRANSLITERATED AS "ZHONG DA".

FOR LATHS OF METAL; PIPES OF METAL; BUILDING MATERIALS OF METAL, NAMELY, METAL REINFORCEMENT MATERIALS FOR BUILDING, STEEL FRAMES FOR BUILDING, METAL TRIM FOR BUILDING, SOFFITS, FASCIA AND COMPOSITE PANELS COMPOSED PRIMARILY OF METAL; STEEL WIRE; CLIPS OF METAL FOR CABLES AND PIPES; PEGS OF METAL; BUILDING OR FURNITURE JOINERY FITTINGS OF NICKEL-SILVER; HARDWARE OF METAL, NAMELY, PULLEYS, SPRINGS, NUTS, WASHERS, KARABINERS, LOAD TRANSFER DOWELS, BUCKLES OF COMMON METAL, HIGH SECURITY LOCKS AND SHEET METAL PLATES PRIMARY FOR THE CASINO AND GAMING INDUSTRY; HANDLING PALLETS OF METAL; CONTAINERS OF METAL FOR THE STORAGE AND TRANSPORTATION OF GOODS (U.S. CLS. 2, 12, 13, 14, 23, 25 AND 50).

CHARISMA HAMPTON, EXAMINING ATTORNEY

CLASS 7—MACHINERY

SN 76-678,868. MORI SEIKI CO., LTD., NARA, JAPAN, FILED 6-28-2007.



THE MARK CONSISTS OF STANDARD CHARACTERS WITHOUT CLAIM TO ANY PARTICULAR FONT, STYLE, SIZE, OR COLOR.

FOR METAL WORKING MACHINES, NAMELY, LATHES, VERTICAL MACHINING CENTERS, HORIZONTAL MACHINING CENTERS, AND TURNING CENTERS (U.S. CLS. 13, 19, 21, 23, 31, 34 AND 35).

FIRST USE 9-6-2006; IN COMMERCE 9-6-2006.
SIMON TENG, EXAMINING ATTORNEY

CLASS 7—(Continued).

SN 77-222,208. JENN FENG INDUSTRIAL CO., LTD., TAOYUAN HSIEN, TAIWAN, FILED 7-5-2007.



OWNER OF U.S. REG. NO. 2,024,472.

NO CLAIM IS MADE TO THE EXCLUSIVE RIGHT TO USE "PRO", APART FROM THE MARK AS SHOWN.

FOR WATER PUMP ASSEMBLIES AND SHAFTS FOR SWIMMING POOLS, SPAS, BATHS AND WHIRLPOOLS; WATER PUMPS FOR LAND VEHICLES, USE IN MOTORS AND ENGINES, SPAS, BATHS, WHIRLPOOLS, SWIMMING POOLS, WATER FILTERING UNITS; STARTERS FOR ENGINES; POWER SAW BLADES; CHAIN SAW ACCESSORIES, NAMELY, CHAIN SAW CUTTING CHAIN, CHAIN SAW BARS, CHAIN SAW SPROCKETS, CHAIN SAW FILES, GRINDING DISCS, CUTTING DISCS; TRIMMER ACCESSORIES, NAMELY, LINES, HEADS, AND BLADES, AND REPLACEMENT PARTS THEREOF; ELECTRIC LAWN, POWER-OPERATED GRASS/WEED, POWER-OPERATED LAWN AND GARDEN STRING TRIMMER ACCESSORIES, NAMELY, LINES, HEADS, AND BLADES, AND REPLACEMENT PARTS THEREOF; PNEUMATIC OR ELECTRIC POWER TOOLS AND THEIR PLUG-IN TOOLS, NAMELY, ELECTRIC HAND-HELD DRILLS AND FOUNDATION DRILLING MACHINES; HAMMERS, NAMELY, PNEUMATIC HAMMERS, SCREWDRIVERS; POWER-OPERATED SCREWDRIVERS, AIR-POWERED SCREW DRIVERS; IMPACT WRENCHES, PILE DRIVERS, HAND-HELD POWER DRIVEN GRINDERS, POWER-OPERATED POLISHERS, POWER-OPERATED SAWS, NAMELY, SABER SAWS, CHAIN SAWS, CLEARING SAWS, JIG SAWS, CIRCULAR SAWS, CUT-OFF SAWS, RECIPROCATING SAWS, POLE SAWS AND BAND SAWS; PORTABLE SAWMILLS; AIR COMPRESSORS; PLANNING MACHINES; ELECTRIC PLANNERS; CUTTERS MACHINE, NAMELY, FODDER CUTTING MACHINES; POWER TOOLS, NAMELY, ROUTERS; POWER-OPERATED STAPLE GUNS; POWER- OPERATED WALLPAPER STRIPPERS AND DRILLING HEADS AND REPLACEMENT PARTS THEREOF; VACUUM CLEANERS; EMERGENCY POWER GENERATORS, NAMELY, PORTABLE ELECTRIC POWER GENERATORS, SOLAR-POWERED ELECTRICITY GENERATORS, ELECTRIC POWER GENERATORS FOR INDOOR USE; ELECTRIC GENERATORS, AC POWER GENERATORS; DC POWER GENERATORS; PORTABLE ELECTRIC BATTERY POWERED GENERATORS; HIGH-FREQUENCY ELECTRIC GENERATORS (U.S. CLS. 13, 19, 21, 23, 31, 34 AND 35).

TINA BROWN, EXAMINING ATTORNEY

CLASS 7—(Continued).

SN 77-294,289. SWASHPUMP TECHNOLOGIES LTD, AUCKLAND 1010, NEW ZEALAND, FILED 10-2-2007.

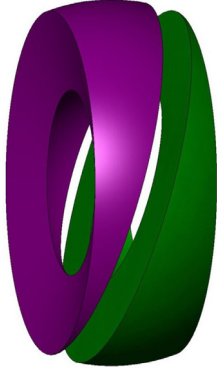

PRIORITY CLAIMED UNDER SEC. 44(D) ON NEW ZEALAND APPLICATION NO. 769881, FILED 6-5-2007, REG. NO. 769881, DATED 6-5-2007, EXPIRES 6-5-2017.

THE COLOR(S) PURPLE AND GREEN IS/ARE CLAIMED AS A FEATURE OF THE MARK.

THE MARK CONSISTS OF PURPLE AND GREEN ADJACENT RINGS.

FOR ELECTRIC PUMPS FOR PUMPING LIQUIDS AND GASES; VACUUM PUMPS; COMPRESSED AIR PUMPS, ELECTRIC AND VACUUM BEER PUMPS, ELECTRIC AND VACUUM PUMPS FOR STERILE LIQUIDS; AND PARTS THEREFORE (U.S. CLS. 13, 19, 21, 23, 31, 34 AND 35).

AMY HELLA, EXAMINING ATTORNEY

SN 77-347,520. MCALISTER. ROY E., PHOENIX, AZ. FILED 12-9-2007.

SPARKINJECTOR

THE MARK CONSISTS OF STANDARD CHARACTERS WITHOUT CLAIM TO ANY PARTICULAR FONT, STYLE, SIZE, OR COLOR.

SEC. 2(F).

FOR ENGINE PARTS, NAMELY, ELECTRONIC FUEL INJECTION MODULES; ENHANCEMENT PARTS FOR INTERNAL COMBUSTION ENGINES, NAMELY, FUEL CATALYSTS; FUEL FILTERS; FUEL INJECTOR PARTS FOR LAND AND WATER VEHICLE ENGINES; FUEL INJECTORS; FUEL PUMPS FOR LAND VEHICLES; ELECTRONIC IGNITIONS FOR VEHICLES; IGNITION DEVICES FOR MOTORS OF LAND VEHICLES; IGNITION PARTS FOR INTERNAL COMBUSTION ENGINES, NAMELY, CONDENSERS; IGNITION WIRES; IGNITIONS PARTS FOR INTERNAL COMBUSTION ENGINES, NAMELY, POINTS; LAND VEHICLE PARTS, NAMELY, SPARK PLUG WIRES; SPARK PLUG IGNITION WIRES; SPARK PLUGS; DIESEL-ENGINE HEATING PLUGS; GLOW PLUGS; GLOW PLUGS FOR DIESEL ENGINES; VEHICLE ENGINE PARTS, NAMELY, OIL TANK PLUGS AND CAPS (U.S. CLS. 13, 19, 21, 23, 31, 34 AND 35).

FIRST USE 3-7-1972; IN COMMERCE 3-7-1972.
KIMBERLY FRYE, EXAMINING ATTORNEY

CLASS 7—(Continued).

SN 77-350,544. JOHNSON, JOHN F., CHESAPEAKE, VA. FILED 12-12-2007.

PRESSURE BUSTER

THE MARK CONSISTS OF STANDARD CHARACTERS WITHOUT CLAIM TO ANY PARTICULAR FONT, STYLE, SIZE, OR COLOR.

NO CLAIM IS MADE TO THE EXCLUSIVE RIGHT TO USE "PRESSURE", APART FROM THE MARK AS SHOWN.

FOR MACHINE PARTS FOR PRESSURE WASHERS, NAMELY, A WEIGHT ATTACHED TO THE END OF A PRESSURE WASHING NOZZLE TO COUNTERBALANCE THE UPWARD FORCE ON THE NOZZLE (U.S. CLS. 13, 19, 21, 23, 31, 34 AND 35).

TINA L. SNAPP, EXAMINING ATTORNEY

SN 77-387,239. MONDEL, ZACHARIE, MARLBOROR, MA. FILED 2-2-2008.

Global Carbon Credits Exchange

THE MARK CONSISTS OF STANDARD CHARACTERS WITHOUT CLAIM TO ANY PARTICULAR FONT, STYLE, SIZE, OR COLOR.

FOR EMISSION REDUCTION UNITS FOR MOTORS AND ENGINES, NAMELY, EGR VALVES; EMISSION REDUCTION UNITS FOR MOTORS AND ENGINES, NAMELY, PCV VALVES; EMISSION REDUCTION UNITS FOR MOTORS AND ENGINES, NAMELY, CATALYTIC CONVERTERS (U.S. CLS. 13, 19, 21, 23, 31, 34 AND 35).

ALICE SUE CARRUTHERS, EXAMINING ATTORNEY

SN 77-387,853. MOELLER MANUFACTURING COMPANY, INC., PLYMOUTH, MI. FILED 2-4-2008.

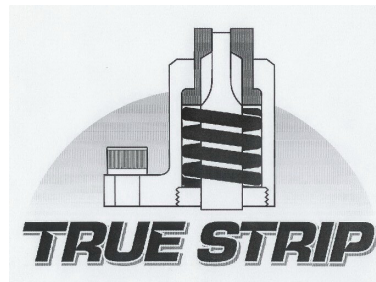

NO CLAIM IS MADE TO THE EXCLUSIVE RIGHT TO USE "STRIP" AND THE DESIGN OF THE STRIPPER MACHINE, APART FROM THE MARK AS SHOWN.

THE MARK CONSISTS OF THE WORDS "TRUE STRIP" BELOW A DEPICTION OF A ONE-PIECE MECHANICAL STRIPPER.

FOR DIE STRIPPER MACHINE FOR USE WITH MACHINE TOOL DIES, PUNCHES AND PUNCH RETAINERS (U.S. CLS. 13, 19, 21, 23, 31, 34 AND 35).

FIRST USE 2-16-2006; IN COMMERCE 2-16-2006.
HOWARD B. LEVINE, EXAMINING ATTORNEY

CLASS 7—(Continued).

SN 77-392,973. TITAN TECHNOLOGIES INTERNATIONAL, INC., HOUSTON, TX. FILED 2-8-2008.

AIRTITE

THE MARK CONSISTS OF STANDARD CHARACTERS WITHOUT CLAIM TO ANY PARTICULAR FONT, STYLE, SIZE, OR COLOR.

THE MARK "AIRTITE" HAS NO MEANING IN A FOREIGN LANGUAGE.

FOR POWER TOOLS, NAMELY, PNEUMATIC TORQUE WRENCHES, ELECTRIC TORQUE WRENCHES, PARTS THEREOF AND ACCESSORIES THEREFOR (U.S. CLS. 13, 19, 21, 23, 31, 34 AND 35).

FIRST USE 0-0-2001; IN COMMERCE 0-0-2001.
LINDA ORNDORFF, EXAMINING ATTORNEY

CLASS 7—(Continued).

SN 77-407,879. BLOHM + VOSS OIL TOOLS, LLC, TROY, MI. FILED 2-27-2008.

GrayChain

THE MARK CONSISTS OF STANDARD CHARACTERS WITHOUT CLAIM TO ANY PARTICULAR FONT, STYLE, SIZE, OR COLOR.

FOR MACHINES FOR ROTATING PIPE ABOUT THE LONGITUDINAL AXIS THEREOF IN ORDER TO THREADEDLY CONNECT AND DISCONNECT PIPE SECTIONS TO AND FROM EACH OTHER (U.S. CLS. 13, 19, 21, 23, 31, 34 AND 35).

FIRST USE 4-16-1997; IN COMMERCE 4-16-1997.
TRACY CROSS, EXAMINING ATTORNEY

SN 77-397,422. THERMATOOL CORP., EAST HAVEN, CT. FILED 2-14-2008.



NO CLAIM IS MADE TO THE EXCLUSIVE RIGHT TO USE "TECHNOLOGY", APART FROM THE MARK AS SHOWN.

THE MARK CONSISTS OF STYLIZED LETTERS "HCT" ABOVE RECTANGLE AND STYLIZED LETTERS "HAZ-CONTROL TECHNOLOGY" BELOW RECTANGLE.

FOR SOLID STATE INDUCTION WELDING MACHINES; LOAD IMPEDANCE AND FREQUENCY CONTROLLERS FOR SOLID STATE INDUCTION WELDING MACHINES (U.S. CLS. 13, 19, 21, 23, 31, 34 AND 35).

JOHN DALIER, EXAMINING ATTORNEY

SN 77-410,896. ITT CORPORATION, WHITE PLAINS, NY. FILED 3-3-2008.

AQUAFORCE

THE MARK CONSISTS OF STANDARD CHARACTERS WITHOUT CLAIM TO ANY PARTICULAR FONT, STYLE, SIZE, OR COLOR.

FOR PACKAGED PUMP SYSTEMS COMPRISED OF WATER PUMPS, PUMP MOTORS, PUMP CONTROLLERS, INSTRUMENTATION FOR MONITORING AND DETECTING PUMP OR FLUID CONDITIONS, VALVES, PIPES AND PIPE FITTINGS ASSOCIATED WITH THE PUMP SYSTEMS, ALL SOLD AS A UNIT FOR USE IN BOOSTING WATER SUPPLY PRESSURE IN HIGH-RISE BUILDINGS, INDUSTRIAL PLANTS, AGRICULTURAL AND IRRIGATIONAL IMPLEMENTATIONS, AND MUNICIPAL AND RURAL WATER DISTRICT FACILITIES (U.S. CLS. 13, 19, 21, 23, 31, 34 AND 35).

FIRST USE 1-0-2004; IN COMMERCE 1-0-2004.
YAT SYE, LEE, EXAMINING ATTORNEY

SN 77-407,863. BLOHM + VOSS OIL TOOLS, LLC, TROY, MI. FILED 2-27-2008.

GraySpin

THE MARK CONSISTS OF STANDARD CHARACTERS WITHOUT CLAIM TO ANY PARTICULAR FONT, STYLE, SIZE, OR COLOR.

FOR MACHINES FOR ROTATING PIPE ABOUT THE LONGITUDINAL AXIS THEREOF IN ORDER TO THREADEDLY CONNECT AND DISCONNECT PIPE SECTIONS TO AND FROM EACH OTHER (U.S. CLS. 13, 19, 21, 23, 31, 34 AND 35).

FIRST USE 5-1-1996; IN COMMERCE 5-1-1996.
TRACY CROSS, EXAMINING ATTORNEY

SN 77-428,056. BIL-JAX, INC., ARCHBOLD, OH. FILED 3-21-2008.

APEX SERIES

THE MARK CONSISTS OF STANDARD CHARACTERS WITHOUT CLAIM TO ANY PARTICULAR FONT, STYLE, SIZE, OR COLOR.

OWNER OF U.S. REG. NO. 3,201,049.
NO CLAIM IS MADE TO THE EXCLUSIVE RIGHT TO USE "SERIES", APART FROM THE MARK AS SHOWN.

FOR VERTICAL TELESCOPIC LIFTS (U.S. CLS. 13, 19, 21, 23, 31, 34 AND 35).

BRIAN NEVILLE, EXAMINING ATTORNEY

CLASS 7—(Continued).

SN 77-428,653. USA ZAMA, INC., FRANKLIN, TN. FILED 3-21-2008.



OWNER OF U.S. REG. NO. 1,889,618.
 THE MARK CONSISTS OF A STYLIZED VERSION OF "ZAMA" WITH THREE DIAGONAL LINES.
 FOR POWER EQUIPMENT PARTS, NAMELY, CARBURETORS FOR MULTI-PURPOSE INTERNAL COMBUSTION ENGINES (U.S. CLS. 13, 19, 21, 23, 31, 34 AND 35).
 FIRST USE 1-0-1991; IN COMMERCE 1-0-1991.
 EMILY CARLSEN, EXAMINING ATTORNEY

SN 77-428,654. USA ZAMA, INC., FRANKLIN, TN. FILED 3-21-2008.



OWNER OF U.S. REG. NO. 1,889,618.
 THE MARK CONSISTS OF A STYLIZED VERSION OF WORD "ZAMA".
 FOR POWER EQUIPMENT PARTS, NAMELY, CARBURETORS FOR MULTI-PURPOSE INTERNAL COMBUSTION ENGINES (U.S. CLS. 13, 19, 21, 23, 31, 34 AND 35).
 FIRST USE 5-0-1978; IN COMMERCE 5-0-1978.
 EMILY CARLSEN, EXAMINING ATTORNEY

SN 77-428,656. USA ZAMA, INC., FRANKLIN, TN. FILED 3-21-2008.



OWNER OF U.S. REG. NO. 1,889,618.
 NO CLAIM IS MADE TO THE EXCLUSIVE RIGHT TO USE "CARBURETOR", APART FROM THE MARK AS SHOWN.
 THE MARK CONSISTS OF A STYLIZED VERSION OF WORDS "ZAMA" AND "CARBURETOR" ON A GRID WITH DOUBLE LINES.
 FOR POWER EQUIPMENT PARTS, NAMELY, CARBURETORS FOR MULTI-PURPOSE INTERNAL COMBUSTION ENGINES (U.S. CLS. 13, 19, 21, 23, 31, 34 AND 35).
 FIRST USE 1-0-1991; IN COMMERCE 1-0-1991.
 EMILY CARLSEN, EXAMINING ATTORNEY

CLASS 7—(Continued).

SN 77-439,467. MONODE MARKING PRODUCTS, INC., MENTOR, OH. FILED 4-3-2008.



THE MARK CONSISTS OF THE WORD "VESTIGE" LOCATED ABOVE THE WORD "REVOLUTION". BOTH OF THE WORDS ARE IN DIFFERENT STYLIZED FONTS. TO THE LEFT OF THE WORDS IS A DESIGN THAT RESEMBLES A SUN WITH ONE LONG RAY OR LINE EXTENDING BETWEEN AND TO THE END OF THE WORDS "VESTIGE" AND "REVOLUTION".
 FOR MARKING LASERS, NAMELY, LASER ENGRAVING MACHINES (U.S. CLS. 13, 19, 21, 23, 31, 34 AND 35).
 THOMAS MANOR, EXAMINING ATTORNEY

SN 77-494,750. NINGBO HENGSHUAI MICROMOTOR CO., LTD., ZHEJIANG 315032, CHINA, FILED 6-9-2008.

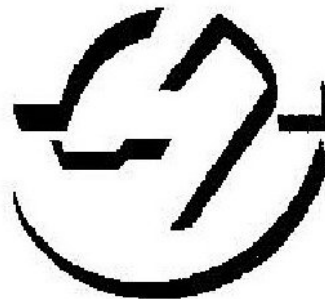

THE MARK CONSISTS OF A SEMI-CIRCLE WITH A ZIG ZAG DESIGN IN THE MIDDLE OF THE CIRCLE.
 FOR COMPRESSED AIR PUMPS; DIES FOR USE WITH MACHINE TOOLS; ELECTRIC PUMPS; FANS FOR MACHINE ENGINES; FANS FOR MOTORS AND ENGINES; FUEL PUMPS FOR LAND VEHICLES; HYDRAULIC PUMPS; OIL PUMPS FOR LAND VEHICLES; SUCTION PUMPS; VACUUM PUMPS (U.S. CLS. 13, 19, 21, 23, 31, 34 AND 35).
 FIRST USE 1-8-2002; IN COMMERCE 5-2-2008.
 INGA ERVIN, EXAMINING ATTORNEY

CLASS 7—(Continued).

SN 77-535,814. ORBIT SCREENS, INC., DELHI, IA. FILED 7-31-2008.

ORBIT SCREENS

THE MARK CONSISTS OF STANDARD CHARACTERS WITHOUT CLAIM TO ANY PARTICULAR FONT, STYLE, SIZE, OR COLOR.

NO CLAIM IS MADE TO THE EXCLUSIVE RIGHT TO USE "SCREENS", APART FROM THE MARK AS SHOWN.

FOR MATERIAL HANDLING MACHINES, NAMELY, MACHINES FOR SEPARATING TARGET MATERIALS FROM MIXTURES OF MATERIALS (U.S. CLS. 13, 19, 21, 23, 31, 34 AND 35).

FIRST USE 5-25-2002; IN COMMERCE 5-25-2002.
MARK SPARACINO, EXAMINING ATTORNEY

SN 77-548,174. MRF LTD, CHENNAI, INDIA, FILED 8-15-2008.

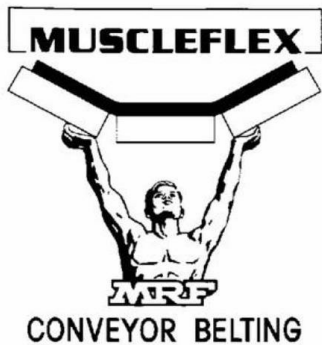

NO CLAIM IS MADE TO THE EXCLUSIVE RIGHT TO USE "CONVEYOR BELTING", APART FROM THE MARK AS SHOWN.

THE MARK CONSISTS OF THE WORD "MUSCLEFLEX" INSIDE A BOX BEING HELD UP BY A MAN HOLDING A CONVEYOR BELT WITH THE WORDS "MRF CONVEYOR BELTING" CENTERED UNDERNEATH.

FOR CONVEYOR BELTING (U.S. CLS. 13, 19, 21, 23, 31, 34 AND 35).
KATHERINE CHANG, EXAMINING ATTORNEY

SN 77-560,369. NEWMAN, JAMES B., ROSEVILLE, MI. FILED 9-2-2008.

Design for a new tool.

THE MARK CONSISTS OF STANDARD CHARACTERS WITHOUT CLAIM TO ANY PARTICULAR FONT, STYLE, SIZE, OR COLOR.

FOR TOOL BITS FOR MACHINES (U.S. CLS. 13, 19, 21, 23, 31, 34 AND 35).

AMEEN IMAM, EXAMINING ATTORNEY

CLASS 7—(Continued).

SN 77-561,253. HEB GROCERY COMPANY, L.P., SAN ANTONIO, TX. FILED 9-3-2008.

ChefStyle

OWNER OF U.S. REG. NOS. 2,887,689, 3,276,593 AND OTHERS.

FOR ELECTRIC FOOD BLENDERS; ELECTRIC CAN OPENERS; ELECTRIC COFFEE GRINDERS (U.S. CLS. 13, 19, 21, 23, 31, 34 AND 35).

BARNEY CHARLON, EXAMINING ATTORNEY

SN 77-562,573. VULCAN ENGINEERING COMPANY, HELENA, AL. FILED 9-4-2008.

MEGABOT

THE MARK CONSISTS OF STANDARD CHARACTERS WITHOUT CLAIM TO ANY PARTICULAR FONT, STYLE, SIZE, OR COLOR.

FOR INDUSTRIAL ROBOTS (U.S. CLS. 13, 19, 21, 23, 31, 34 AND 35).

PAUL E. FAHRENKOPF, EXAMINING ATTORNEY

SN 77-563,154. ERIEZ MANUFACTURING CO., ERIE, PA. FILED 9-5-2008.

ECOTOWERSORT

THE MARK CONSISTS OF STANDARD CHARACTERS WITHOUT CLAIM TO ANY PARTICULAR FONT, STYLE, SIZE, OR COLOR.

FOR MACHINES FOR SEPARATING RECYCLABLE MATERIALS (U.S. CLS. 13, 19, 21, 23, 31, 34 AND 35).

JEFF DEFORD, EXAMINING ATTORNEY

CLASS 7—(Continued).

SN 77-563,301. EUROFLEX S.R.L., SUSEGANA (TV), ITALY,
FILED 9-5-2008.



THE COLOR(S) BLUE AND WHITE IS/ARE CLAIMED AS
A FEATURE OF THE MARK.

THE MARK CONSISTS OF A STYLIZED WHITE LETTER
"E" WITHIN A BLUE OVAL WITH THE WORD "EURO-
FLEX" IN BLUE UNDERNEATH THE OVAL.

FOR CARPET CLEANING MACHINES; CARPET
CLEANING MACHINES, NAMELY, CARPET EXTRAC-
TORS; DRY-CLEANING MACHINES; ELECTRIC
CLOTHING PRESSING MACHINES; ELECTRIC VA-
CUUM CLEANERS; ELECTRICALLY POWERED STEAM
CLEANING DEVICE COMPRISING A HOSE AND NOZ-
ZLE AND A VAPOR-PRODUCING CHAMBER THAT IS
ATTACHED TO A WATER SOURCE; FLOOR CLEAN-
ING MACHINES; MULTI-PURPOSE STEAM CLEANERS;
STEAM CLEANING MACHINES; VACUUM CLEANERS
(U.S. CLS. 13, 19, 21, 23, 31, 34 AND 35).

HENRY S. ZAK, EXAMINING ATTORNEY

CLASS 7—(Continued).

SN 77-563,387. EUROFLEX S.R.L., SUSEGANA (TV), ITALY,
FILED 9-5-2008.



THE COLOR(S) BLUE AND WHITE IS/ARE CLAIMED AS
A FEATURE OF THE MARK.

THE MARK CONSISTS OF A STYLIZED WHITE LETTER
"E" WITHIN A BLUE OVAL WITH THE WORD "EURO-
FLEX" IN BLUE UNDERNEATH THE OVAL. UNDER-
NEATH THE WORD "EUROFLEX" IS A HORIZONTAL
BLUE LINE. UNDERNEATH THAT BLUE LINE ARE THE
WORDS "MAKING HOUSEWORK" AND UNDERNEATH
THOSE WORDS ARE THE WORDS "REVOLUTIONARILY
SIMPLE".

FOR CARPET CLEANING MACHINES; CARPET
CLEANING MACHINES, NAMELY, CARPET EXTRAC-
TORS; DRY-CLEANING MACHINES; ELECTRIC
CLOTHING PRESSING MACHINES; ELECTRIC VA-
CUUM CLEANERS; ELECTRICALLY POWERED STEAM
CLEANING DEVICE COMPRISING A HOSE AND NOZ-
ZLE AND A VAPOR-PRODUCING CHAMBER THAT IS
ATTACHED TO A WATER SOURCE; FLOOR CLEAN-
ING MACHINES; MULTI-PURPOSE STEAM CLEANERS;
STEAM CLEANING MACHINES; VACUUM CLEANERS
(U.S. CLS. 13, 19, 21, 23, 31, 34 AND 35).

HENRY S. ZAK, EXAMINING ATTORNEY

SN 77-563,455. EMERSON ELECTRIC CO., ST. LOUIS, MO.
FILED 9-5-2008.

RESCUE EcoTech

THE MARK CONSISTS OF STANDARD CHARACTERS
WITHOUT CLAIM TO ANY PARTICULAR FONT, STYLE,
SIZE, OR COLOR.

OWNER OF U.S. REG. NOS. 2,618,329 AND 3,084,354.
FOR ELECTRONICALLY CONTROLLED ELECTRIC
MOTORS FOR MACHINES, NAMELY, HVAC MA-
CHINES IN THE NATURE OF FURNACES, AIR HAND-
LERS AND AIR CONDITIONERS (U.S. CLS. 13, 19, 21, 23,
31, 34 AND 35).

ELISSA GARBER KON, EXAMINING ATTORNEY

CLASS 7—(Continued).

SN 77-563,465. EMERSON ELECTRIC CO., ST. LOUIS, MO. FILED 9-5-2008.

EcoTech

THE MARK CONSISTS OF STANDARD CHARACTERS WITHOUT CLAIM TO ANY PARTICULAR FONT, STYLE, SIZE, OR COLOR.

FOR ELECTRONICALLY CONTROLLED ELECTRIC MOTORS FOR MACHINES, NAMELY, HVAC MACHINES IN THE NATURE OF FURNACES, AIR HANDLERS AND AIR CONDITIONERS (U.S. CLS. 13, 19, 21, 23, 31, 34 AND 35).

ELISSA GARBER KON, EXAMINING ATTORNEY

CLASS 7—(Continued).

SN 77-564,792. EUROFLEX S.R.L., SUSEGANA (TV), ITALY, FILED 9-8-2008.



THE COLOR(S) BLUE, BLACK AND WHITE IS/ARE CLAIMED AS A FEATURE OF THE MARK.

THE MARK CONSISTS OF THE STYLIZED EYE OF A RAPTOR. THERE IS A STYLIZED EYE COLORED WHITE, BLUE AND BLACK INSIDE THE WHITE FEATHERED HEAD SEGMENT OF A RAPTOR.

FOR CARPET CLEANING MACHINES; CARPET CLEANING MACHINES, NAMELY, CARPET EXTRACTORS; DRY-CLEANING MACHINES; ELECTRIC CLOTHING PRESSING MACHINES; ELECTRIC VACUUM CLEANERS; ELECTRICALLY POWERED STEAM CLEANING DEVICE COMPRISING A HOSE AND NOZZLE AND A VAPOR-PRODUCING CHAMBER THAT IS ATTACHED TO A WATER SOURCE; FLOOR CLEANING MACHINES; MULTI-PURPOSE STEAM CLEANERS; STEAM CLEANING MACHINES; VACUUM CLEANERS (U.S. CLS. 13, 19, 21, 23, 31, 34 AND 35).

HENRY S. ZAK, EXAMINING ATTORNEY

SN 77-564,378. TIRE SERVICE EQUIPMENT COMPANY, INC., PHOENIX, AZ. FILED 9-8-2008.

Guardian

THE MARK CONSISTS OF STANDARD CHARACTERS WITHOUT CLAIM TO ANY PARTICULAR FONT, STYLE, SIZE, OR COLOR.

FOR MACHINES FOR PHYSICALLY DESTROYING COMPUTER HARD DRIVES (U.S. CLS. 13, 19, 21, 23, 31, 34 AND 35).

FIRST USE 6-1-2006; IN COMMERCE 6-1-2006.
KELLEY WELLS, EXAMINING ATTORNEY

SN 77-565,381. ALAMO GROUP INC., SEGUIN, TX. FILED 9-9-2008.

SAMURAI

SN 77-564,724. DUPERON CORPORATION, SAGINAW, MI. FILED 9-8-2008.

FLEXRAKE PRODIGY

THE MARK CONSISTS OF STANDARD CHARACTERS WITHOUT CLAIM TO ANY PARTICULAR FONT, STYLE, SIZE, OR COLOR.

OWNER OF U.S. REG. NO. 2,866,373.
FOR MACHINERY FOR USE IN REMOVING REFUSE FROM STREAMS OF FLOWING WATER AT LOW FLOW RATES OF 1MGD OR LESS (U.S. CLS. 13, 19, 21, 23, 31, 34 AND 35).

WILLIAM P. SHANAHAN, EXAMINING ATTORNEY

THE MARK CONSISTS OF STANDARD CHARACTERS WITHOUT CLAIM TO ANY PARTICULAR FONT, STYLE, SIZE, OR COLOR.

FOR BOOM MOWERS (U.S. CLS. 13, 19, 21, 23, 31, 34 AND 35).

SUNG IN, EXAMINING ATTORNEY

CLASS 7—(Continued).

SN 77-565,548. WARNER-LAMBERT COMPANY LLC, NEW YORK, NY. FILED 9-9-2008.

CLASS 7—(Continued).

SN 77-567,047. REXNORD INDUSTRIES, LLC, MILWAUKEE, WI. FILED 9-10-2008.

CAP 8

THE MARK CONSISTS OF STANDARD CHARACTERS WITHOUT CLAIM TO ANY PARTICULAR FONT, STYLE, SIZE, OR COLOR.

FOR CAPSULE FILLING MACHINES (U.S. CLS. 13, 19, 21, 23, 31, 34 AND 35).

ZACHARY BELLO, EXAMINING ATTORNEY

VICTORY

THE MARK CONSISTS OF STANDARD CHARACTERS WITHOUT CLAIM TO ANY PARTICULAR FONT, STYLE, SIZE, OR COLOR.

FOR FLEXIBLE, MECHANICAL COUPLINGS FOR MACHINES (U.S. CLS. 13, 19, 21, 23, 31, 34 AND 35).

DEIRDRE ROBERTSON, EXAMINING ATTORNEY

SN 77-565,827. MULTIQUIP, INC., CARSON, CA. FILED 9-9-2008.

SN 77-571,101. ORECK HOLDINGS, LLC, NASHVILLE, TN. FILED 9-16-2008.

SLH

THE MARK CONSISTS OF STANDARD CHARACTERS WITHOUT CLAIM TO ANY PARTICULAR FONT, STYLE, SIZE, OR COLOR.

FOR CONSTRUCTION EQUIPMENT, NAMELY, SELF-LEVELING HANDLES FOR CONCRETE SAWS OR OTHER EQUIPMENT WITH TILT FUNCTIONS MAINTAINING THE HANDLE AT COMFORTABLE OPERATOR'S HEIGHT (U.S. CLS. 13, 19, 21, 23, 31, 34 AND 35).

WANDA KAY PRICE, EXAMINING ATTORNEY

HALO

THE MARK CONSISTS OF STANDARD CHARACTERS WITHOUT CLAIM TO ANY PARTICULAR FONT, STYLE, SIZE, OR COLOR.

FOR VACUUM CLEANERS (U.S. CLS. 13, 19, 21, 23, 31, 34 AND 35).

DANNEAN HETZEL, EXAMINING ATTORNEY

SN 77-566,862. PETRA SOLAR, INC., SOUTH PLAINFIELD, NJ. FILED 9-10-2008.

SN 77-586,552. SHOP VAC CORPORATION, WILLIAMSPORT, PA. FILED 10-6-2008.

DEMOCRATIZING SOLAR

THE MARK CONSISTS OF STANDARD CHARACTERS WITHOUT CLAIM TO ANY PARTICULAR FONT, STYLE, SIZE, OR COLOR.

NO CLAIM IS MADE TO THE EXCLUSIVE RIGHT TO USE "SOLAR", APART FROM THE MARK AS SHOWN.

FOR SOLAR-POWERED ELECTRICITY GENERATORS (U.S. CLS. 13, 19, 21, 23, 31, 34 AND 35).

DOMINIC FATHY, EXAMINING ATTORNEY

CARMASTER

THE MARK CONSISTS OF STANDARD CHARACTERS WITHOUT CLAIM TO ANY PARTICULAR FONT, STYLE, SIZE, OR COLOR.

FOR VACUUM CLEANERS (U.S. CLS. 13, 19, 21, 23, 31, 34 AND 35).

WILLIAM ROSSMAN, EXAMINING ATTORNEY

CLASS 7—(Continued).

SN 77-597,188. SHOP VAC CORPORATION, WILLIAMSPORT, PA. FILED 10-21-2008.

KVAC

THE MARK CONSISTS OF STANDARD CHARACTERS WITHOUT CLAIM TO ANY PARTICULAR FONT, STYLE, SIZE, OR COLOR.

FOR VACUUM CLEANERS (U.S. CLS. 13, 19, 21, 23, 31, 34 AND 35).

WILLIAM ROSSMAN, EXAMINING ATTORNEY

SN 79-044,904. KAYABA INDUSTRY CO., LTD.; (KAYABA KOGYO KABUSHIKI KAISHA), JAPAN, FILED 5-30-2007.

KYB

OWNER OF INTERNATIONAL REGISTRATION 0833558 DATED 2-6-2004, EXPIRES 2-6-2014.

OWNER OF U.S. REG. NOS. 1,012,891, 1,543,284 AND 1,797,530.

FOR CUTTER LOADERS; ROCK DRILLS; TRUCK CRANES; CONCRETE MIXERS; POWER JACKS; HYDRAULIC JACKS; WINCHES; DISINTEGRATORS FOR CHEMICAL PROCESSING; AGITATING MACHINES FOR CHEMICAL PROCESSING; MIXING OR BLENDING MACHINES FOR CHEMICAL PROCESSING; RICE AND BARLEY POLISHING MACHINES; AGRICULTURAL MACHINES, NAMELY, AGRICULTURAL SEED PLANTING MACHINES, CULTIVATORS, HARVESTERS, DISK HARROW; FOOD MIXING MACHINES FOR COMMERCIAL USE; FOOD PEELING MACHINES FOR INDUSTRIAL PURPOSES; DISH WASHING MACHINES FOR INDUSTRIAL PURPOSES; FOOD CUTTING, CHOPPING AND SLICING MACHINES FOR COMMERCIAL USE; HYDRAULIC ACTUATORS BEING MACHINE ELEMENTS NOT FOR LAND VEHICLES; CYLINDERS, NAMELY, MACHINE ELEMENTS NOT FOR LAND VEHICLES, USED FOR BUILDING AND CONSTRUCTION MACHINES AND AGRICULTURAL MACHINES; REDUCTION GEARS BEING MACHINE ELEMENTS NOT FOR LAND VEHICLES; HYDRAULIC SPEED CHANGE GEARS BEING NOT FOR LAND VEHICLES; POWER TRANSMISSIONS AND GEARINGS FOR MACHINES BEING MACHINE ELEMENTS NOT FOR LAND VEHICLES; SHOCK ABSORBERS BEING MACHINE ELEMENTS NOT FOR LAND VEHICLES; OIL BUFFERS BEING MACHINE ELEMENTS NOT FOR LAND VEHICLES; DISC BRAKES, BEING MACHINE ELEMENTS NOT FOR LAND VEHICLES; BRAKE PADS, BEING MACHINE ELEMENTS NOT FOR LAND VEHICLES; BRAKES, BEING MACHINE ELEMENTS NOT FOR LAND VEHICLES; PISTON PUMPS, VANE PUMPS AND GEAR PUMPS; RELIEF BALL VALVES AND CHECK BALL VALVES, BEING MACHINE ELEMENTS NOT FOR LAND VEHICLES; LAWNMOWERS; WASTE CRUSHING MACHINES; ROPEWAYS FOR CARGO OR FREIGHT HANDLING; RAM TENSIONERS FOR SHIPS, NAMELY, A POWER OPERATED LIFT USED TO TRANSPORT CARGO BETWEEN SHIPS; STEERING PUMPS (U.S. CLS. 13, 19, 21, 23, 31, 34 AND 35).

ERNEST SHOSHO, EXAMINING ATTORNEY

CLASS 7—(Continued).

SN 79-053,693. VE.TRA.CO S.R.L., ITALY, FILED 4-8-2008.



OWNER OF INTERNATIONAL REGISTRATION 0894016 DATED 8-16-2005, EXPIRES 8-16-2015.

WORD VETRACO PRODUCED IN ANY CHARACTER, PRECEDED BY A LETTER "V"; THE RIGHT-HAND PART OF SAID LETTER "V" IS PROLONGED HORIZONTALLY OVER THE ENTIRE WORD, ENDING IN A HALF-CIRCLE AND ALMOST DEFINING A FRAME CONTAINING THE SAID WORD; THE LEFT-HAND PART OF SAID LETTER "V" IS THICKER THAN THE OTHER, AND SURMOUNTED BY A STYLIZED FOUR-POINT STAR.

FOR MACHINES FOR COSMETIC PRODUCTION; INDUSTRIAL AUTOMATION IN THE NATURE OF MELTING, EMULSIFYING, DISPENSING, FILLING, CAPPING, AND SEALING COSMETIC PACKAGING MACHINES (U.S. CLS. 13, 19, 21, 23, 31, 34 AND 35).

EMILY CARLSEN, EXAMINING ATTORNEY

CLASS 8—HAND TOOLS

SN 76-692,722. GROSS, ALICIA JO, FREEPORT, IL. FILED 9-9-2008.

BACKBAR \$AVER

THE MARK CONSISTS OF STANDARD CHARACTERS WITHOUT CLAIM TO ANY PARTICULAR FONT, STYLE, SIZE, OR COLOR.

NO CLAIM IS MADE TO THE EXCLUSIVE RIGHT TO USE "BACKBAR", APART FROM THE MARK AS SHOWN. FOR HAND TOOLS, NAMELY, HAND-OPERATED PUMPS FOR USE IN THE BEAUTY INDUSTRY (U.S. CLS. 23, 28 AND 44).

MEGHAN REINHART, EXAMINING ATTORNEY

SN 77-144,877. GANCZAR, MICHAEL F., HEADINGLEY, MANITOBA, CANADA, FILED 3-30-2007.

MUDPAL

THE MARK CONSISTS OF STANDARD CHARACTERS WITHOUT CLAIM TO ANY PARTICULAR FONT, STYLE, SIZE, OR COLOR.

PRIORITY CLAIMED UNDER SEC. 44(D) ON CANADA APPLICATION NO. 1320643, FILED 10-18-2006, REG. NO. TMA728179, DATED 11-10-2008, EXPIRES 11-10-2023.

FOR HAND TOOLS, NAMELY, PORTABLE SCRAPPERS FOR CLEANING FOOTWEAR (U.S. CLS. 23, 28 AND 44).

CYNTHIA SLOAN, EXAMINING ATTORNEY

CLASS 8—(Continued).

SN 77-493,216. MARTIN, PHILLIP S., DBA BLUE RIDGE KNIVES, MARION, VA. FILED 6-6-2008.

CRIPPLE CREEK U.S.A.

THE MARK CONSISTS OF STANDARD CHARACTERS WITHOUT CLAIM TO ANY PARTICULAR FONT, STYLE, SIZE, OR COLOR.

NO CLAIM IS MADE TO THE EXCLUSIVE RIGHT TO USE "U.S.A.", APART FROM THE MARK AS SHOWN. FOR KNIVES (U.S. CLS. 23, 28 AND 44). DOMINIC FATHY, EXAMINING ATTORNEY

SN 77-531,760. CLYDE ALAN HOLLIS, DBA D/B/A IMPERIAL WEAPONS, JACKSON, TN. FILED 7-25-2008.



NO CLAIM IS MADE TO THE EXCLUSIVE RIGHT TO USE "ARMS", APART FROM THE MARK AS SHOWN.

THE MARK CONSISTS OF A SHINY METALLIC-APPEARING SHIELD WITH ITS FACE DIVIDED INTO FOUR BLACKENED QUADRANTS, A STYLIZED LETTER "L" APPEARING IN THE TOP LEFT QUADRANT AND A STYLIZED LETTER "A" APPEARING IN THE BOTTOM RIGHT QUADRANT, WITH A SCROLL DESIGN EMBELLISHED CIRCLE IN THE MIDDLE, THE SHADOW OF THE SHIELD APPEARING TO THE RIGHT, AND THE STYLIZED WORDS "LEGACY ARMS" BENEATH THE SHIELD. FOR MEDIEVAL AND HISTORIC REPRODUCTIONS OF SWORDS, DAGGERS, AND KNIVES (U.S. CLS. 23, 28 AND 44).

SANJEEV VOHRA, EXAMINING ATTORNEY

CLASS 8—(Continued).

SN 77-555,846. HESSLER WORLDWIDE, LLC, TOWN & COUNTRY, MO. FILED 8-26-2008.

SHARP SELECT

THE MARK CONSISTS OF STANDARD CHARACTERS WITHOUT CLAIM TO ANY PARTICULAR FONT, STYLE, SIZE, OR COLOR.

NO CLAIM IS MADE TO THE EXCLUSIVE RIGHT TO USE "SHARP", APART FROM THE MARK AS SHOWN. FOR KNIVES (U.S. CLS. 23, 28 AND 44). KIMBERLY FRYE, EXAMINING ATTORNEY

SN 77-555,901. HESSLER WORLDWIDE, LLC, TOWN & COUNTRY, MO. FILED 8-26-2008.

PARING PARTNER

THE MARK CONSISTS OF STANDARD CHARACTERS WITHOUT CLAIM TO ANY PARTICULAR FONT, STYLE, SIZE, OR COLOR.

NO CLAIM IS MADE TO THE EXCLUSIVE RIGHT TO USE "PARING", APART FROM THE MARK AS SHOWN. FOR KNIVES (U.S. CLS. 23, 28 AND 44). KIMBERLY FRYE, EXAMINING ATTORNEY

SN 77-562,917. YIH CHENG FACTORY CO., LTD., TAI-CHUNG, TAIWAN, FILED 9-4-2008.

Toolcom

THE MARK CONSISTS OF STANDARD CHARACTERS WITHOUT CLAIM TO ANY PARTICULAR FONT, STYLE, SIZE, OR COLOR.

FOR BITS FOR HAND DRILLS; CROWBARS; HAND TOOLS, NAMELY, CLAMPS; HAND TOOLS, NAMELY, HAMMERS; HAND TOOLS, NAMELY, SCREWDRIVERS; HAND TOOLS, NAMELY, SOCKET WRENCHES; HAND TOOLS, NAMELY, WRENCHES; HAND TOOLS, NAMELY, DRILLS; PLIERS (U.S. CLS. 23, 28 AND 44).

SAIMA MAKHDOOM, EXAMINING ATTORNEY

CLASS 8—(Continued).

SN 77-564,104. DER JIH INDUSTRIAL CO., LTD., TAI-CHUNG, TAIWAN, FILED 9-7-2008.



THE MARK CONSISTS OF STYLIZED DESIGN OF LETTERS "D" AND "J".

FOR GARDENING SHEARS AND SCISSORS; HAND TOOLS, NAMELY, SAWS; HAND TOOLS, NAMELY, SCREWDRIVERS; HAND TOOLS, NAMELY, SOCKET WRENCHES; HAND TOOLS, NAMELY, WIRE STRIPPERS; HAND TOOLS, NAMELY, WRENCHES; PLIERS; PRUNING SHEARS; TWEEZERS (U.S. CLS. 23, 28 AND 44).

SKYE YOUNG, EXAMINING ATTORNEY

SN 77-564,418. SMD TRADING CO., LTD, IRVINE, CA. FILED 9-8-2008.

CPLA

THE MARK CONSISTS OF STANDARD CHARACTERS WITHOUT CLAIM TO ANY PARTICULAR FONT, STYLE, SIZE, OR COLOR.

FOR BIODEGRADABLE CUTLERY, NAMELY, KNIVES, FORKS AND SPOONS (U.S. CLS. 23, 28 AND 44).

KIMBERLY PERRY, EXAMINING ATTORNEY

SN 77-565,820. YOU LU ENTERPRISE CO., LTD., TAI-CHUNG CITY, TAIWAN, FILED 9-9-2008.

ULIXES

THE MARK CONSISTS OF THE TERM "ULIXES" IN STYLIZED FONT WITH THE "X" IN "ULIXES" SEPARATED AT THE CENTER INTO FOUR EQUAL PARTS.

THE ENGLISH TRANSLATION OF "ULIXES" IS "ODYSSEUS".

FOR MANUALLY OPERATED HAND TOOLS, NAMELY, SCREWDRIVERS, NUT DRIVERS, WRENCHES, SOCKET WRENCHES, SOCKET SETS, HAMMERS (U.S. CLS. 23, 28 AND 44).

FIRST USE 9-8-2008; IN COMMERCE 9-8-2008.

ESTHER BELENKER, EXAMINING ATTORNEY

CLASS 8—(Continued).

SN 77-566,249. BINKOSKI, JAMES P., WATERTOWN, CT. FILED 9-10-2008.

THE TICK KEY

THE MARK CONSISTS OF STANDARD CHARACTERS WITHOUT CLAIM TO ANY PARTICULAR FONT, STYLE, SIZE, OR COLOR.

NO CLAIM IS MADE TO THE EXCLUSIVE RIGHT TO USE "TICK", APART FROM THE MARK AS SHOWN.

FOR HAND TOOL, NAMELY, TICK REMOVAL DEVICE (U.S. CLS. 23, 28 AND 44).

FIRST USE 7-1-2007; IN COMMERCE 7-5-2007.

LINDA LAVACHE, EXAMINING ATTORNEY

SN 77-572,419. KONINKLIJKE PHILIPS ELECTRONICS N.V., EINDHOVEN, NETHERLANDS, FILED 9-17-2008.

FLEX & PIVOT ACTION

THE MARK CONSISTS OF STANDARD CHARACTERS WITHOUT CLAIM TO ANY PARTICULAR FONT, STYLE, SIZE, OR COLOR.

FOR ELECTRIC SHAVERS, BLADES FOR ELECTRIC SHAVERS, HAIR CLIPPERS, HAIR AND BEARD TRIMMERS; PARTS OF THE AFORESAID GOODS (U.S. CLS. 23, 28 AND 44).

PATRICIA EVANKO, EXAMINING ATTORNEY

CLASS 9—ELECTRICAL AND SCIENTIFIC APPARATUS

SN 76-544,938. PDP SYSTEMS, INC., FREMONT, CA. FILED 9-2-2003.



NO CLAIM IS MADE TO THE EXCLUSIVE RIGHT TO USE "MEMORY", APART FROM THE MARK AS SHOWN. FOR COMPUTER MEMORY HARDWARE (U.S. CLS. 21, 23, 26, 36 AND 38).

FIRST USE 2-18-2003; IN COMMERCE 4-1-2003.

BARBARA GAYNOR, EXAMINING ATTORNEY

CLASS 9—(Continued).

SN 76-601,324. SMARTRONIX, INC., CALIFORNIA, MD.
FILED 7-8-2004.

SMARTRONIX

THE MARK CONSISTS OF STANDARD CHARACTERS WITHOUT CLAIM TO ANY PARTICULAR FONT, STYLE, SIZE, OR COLOR.

OWNER OF U.S. REG. NOS. 3,056,872 AND 3,174,547.

FOR HARDWARE AND SOFTWARE FOR RUGGED COMPUTERS, NAMELY, HARDWARE AND SOFTWARE USED TO ENHANCE, PROTECT, AND INTEGRATE EQUIPMENT AND DATA FOR DEPLOYED AND AUSTERE ENVIRONMENTS, NAMELY, WIDE POWER RANGES, NIGHT VISION PROTECTION, RUGGEDIZATION, AND ENVIRONMENTAL HARDENING FOR COMPUTERS, NETWORKING ADAPTERS, HARD DRIVES, PERIPHERALS, RADIOS, HEADS-UP OR HEAD MOUNTED DISPLAYS, GLOBAL POSITIONING SYSTEMS, RANGE FINDERS, POWER SYSTEMS, UNMANNED VEHICLES, TARGET DESIGNATORS, ENVIRONMENTAL SENSORS, NAMELY, TEMPERATURE, HUMIDITY, SHOCK, VIBRATION, WIND SPEED, INCLINATION, HUMAN VITAL SIGN SENSORS, AND WEAPONS THAT MAY BE USED IN DEPLOYED AND AUSTERE ENVIRONMENTS; DEPLOYABLE COMPUTER AND RADIO SYSTEMS, NAMELY, DATA ENCRYPTION SUITES, NETWORK SECURITY SUITES, MISSION PLANNING CENTERS, SATELLITE COMMUNICATIONS (SATCOM) AND LINE OF SIGHT (LOS) RADIO SUITES, GROUND CONTROL STATIONS AND MOBILE DATA CENTERS, ALL COMPOSED OF HARDWARE USED TO ENHANCE, PROTECT, AND INTEGRATE EQUIPMENT AND DATA FOR DEPLOYED AND AUSTERE ENVIRONMENTS; COMPUTER AND NETWORK TEST AND MANAGEMENT TOOLS, NAMELY, TEST TOOLS USED TO ANALYZE, CONTROL, SIMULATE, AND TROUBLE-SHOOT NETWORKS, NETWORK INTERFACES, AND COMPUTER INTERFACES, NAMELY, TOOLS TO TEST ELECTRICAL SIGNALS AND DATA FLOW ACROSS NETWORKS, COMPUTER CABLES AND/OR WIRELESS MEDIUMS; MANAGEMENT AND CONTROL TOOLS THAT FILTER, COLLECT, OR MODIFY NETWORK OR INTERFACE DATA; AND WEB APPLICATIONS AND INTEGRATED BUSINESS SOLUTIONS SOFTWARE, NAMELY, ENTERPRISE RESOURCE PLANNING BUSINESS SOFTWARE FOR USE IN SUPPLY CHAIN MANAGEMENT, FINANCIAL MANAGEMENT, PROJECT MANAGEMENT, HUMAN RESOURCES AND CUSTOMER RELATIONSHIP MANAGEMENT; COLLABORATIVE PORTAL AND WORKFLOW SOLUTIONS SOFTWARE FOR USE IN THE MANAGEMENT OF STRUCTURED AND UNSTRUCTURED DATA, CONFIGURATION MANAGEMENT, ENTERPRISE SEARCH, AND INFORMATION AND KNOWLEDGE CLASSIFICATION AND DISSEMINATION; GEOSPATIAL SOFTWARE APPLICATIONS FOR USE IN GATHERING, STORING, ANALYZING, INTEGRATING, AND DISPLAYING GEOGRAPHIC DATA SETS; NETWORK SECURITY SOFTWARE FOR USE IN MONITORING, DETECTING, ANALYZING, AND PROTECTING NETWORK ASSETS; AND VIRTUALIZATION SOFTWARE FOR USE IN SERVER CONSOLIDATION, SECURE REMOTE COMPUTING, AND APPLICATION OR SERVICE PROVISIONING (U.S. CLS. 21, 23, 26, 36 AND 38).

NICHOLAS ALTREE, EXAMINING ATTORNEY

CLASS 9—(Continued).

SN 76-666,401. 6115187 CANADA INC. MONTREAL, PROVINCE OF QUEBEC, CANADA, FILED 9-22-2006.

ENABLING PANORAMIC TECHNOLOGY

THE MARK CONSISTS OF STANDARD CHARACTERS WITHOUT CLAIM TO ANY PARTICULAR FONT, STYLE, SIZE, OR COLOR.

NO CLAIM IS MADE TO THE EXCLUSIVE RIGHT TO USE "PANORAMIC TECHNOLOGY", APART FROM THE MARK AS SHOWN.

FOR PANORAMIC IMAGING OPTICAL SYSTEMS COMPRISING LENSES AND ELECTRONIC DEVICES AND PANORAMIC IMAGING SOFTWARE FOR CAPTURING, VISUALIZING, STITCHING, ANALYZING, EDITING, PUBLISHING AND PRINTING PANORAMIC IMAGES (U.S. CLS. 21, 23, 26, 36 AND 38).

FIRST USE 6-1-2006; IN COMMERCE 6-1-2006.

TINA KUAN, EXAMINING ATTORNEY

SN 76-676,702. REFEREE ENTERPRISES, INC., RACINE, WI.
FILED 5-11-2007.



THE STIPLING IN THE DRAWING IS FOR SHADING PURPOSES ONLY.

FOR DIGITAL VISUAL PRODUCTS, NAMELY, PRE-RECORDED DVDS AND DOWNLOADABLE VIDEO MATERIAL VIA THE INTERNET, FEATURING ACTUAL VISUAL REPRESENTATIONS OF OFFICIATING TECHNIQUES AND POSITIONING IN SPORTING EVENTS FOR INSTRUCTIONAL PURPOSES (U.S. CLS. 21, 23, 26, 36 AND 38).

ROBIN CHOSID, EXAMINING ATTORNEY

SN 76-685,866. WILLIAMS-PYRO, INC., FORT WORTH, TX.
FILED 1-17-2008.



THE ENGLISH TRANSLATION OF THE WORD "DURADERO" IN THE MARK IS LASTING.

FOR ELECTRONIC CONTROL AND MONITORING MODULES, WHICH DETERMINE THE STATUS OF THE ELECTRICAL POWER SYSTEMS OF A MICRO-POWER GRID, INCLUDING ALL SOURCES OF POWER, GENERATORS, BATTERIES, WIND TURBINES, PHOTO VOLTAIC ARRAYS, FLY WHEELS, FUEL CELLS, AND OTHER DEVICES AND ANY LOADS CONNECTED TO THE MICRO-POWER GRID WHICH MAY CONSUME POWER, TO DYNAMICALLY MATCH THE POWER SOURCES TO LOADS TO MORE EFFICIENTLY AND RELIABLY PROVIDE POWER AND REDUCE POWER COSTS (U.S. CLS. 21, 23, 26, 36 AND 38).

PAUL E. FAHRENKOPF, EXAMINING ATTORNEY

CLASS 9—(Continued).

SN 76-694,020. THE UNITED METHODIST PUBLISHING HOUSE, NASHVILLE, TN. FILED 11-3-2008.



NO CLAIM IS MADE TO THE EXCLUSIVE RIGHT TO USE "VIDEO VIGNETTES", APART FROM THE MARK AS SHOWN.

THE MARK CONSISTS OF THE TERM "VERACITY" SURROUNDED BY AN OVAL BORDER MADE UP OF CURVING LINES. UNDERNEATH THE TERM "VERACITY" IS THE WORDING "VIDEO VIGNETTES" WHICH APPEARS AS PART OF THE BORDER.

FOR PRE-RECORDED DVD'S WITHIN THE FIELD OF RELIGION (U.S. CLS. 21, 23, 26, 36 AND 38).

FIRST USE 6-0-2007; IN COMMERCE 6-0-2007.

COURTNEY MCCORMICK, EXAMINING ATTORNEY

SN 76-694,021. THE UNITED METHODIST PUBLISHING HOUSE, NASHVILLE, TN. FILED 11-3-2008.

VERACITY

THE MARK CONSISTS OF STANDARD CHARACTERS WITHOUT CLAIM TO ANY PARTICULAR FONT, STYLE, SIZE, OR COLOR.

FOR PRE-RECORDED DVD'S WITHIN THE FIELD OF RELIGION (U.S. CLS. 21, 23, 26, 36 AND 38).

FIRST USE 6-0-2007; IN COMMERCE 6-0-2007.

COURTNEY MCCORMICK, EXAMINING ATTORNEY

SN 77-027,353. SHIM, JUNG HOON, NONHYUNDONG KANGNAMGU, REPUBLIC OF KOREA, FILED 10-23-2006.

mouve

FOR APPARATUS FOR RECORDING, TRANSMISSION OR REPRODUCTION OF SOUND AND IMAGES; MP3 PLAYERS, PMP PLAYERS, NAMELY, PORTABLE MEDIA PLAYERS; PORTABLE GAME MACHINE, NAMELY, HAND-HELD UNIT FOR PLAYING ELECTRONIC GAMES FOR USE WITH AN EXTERNAL DISPLAY SCREEN OR MONITOR; MOBILE PHONE, CORDLESS TELEPHONE, CORDED PHONE, WIRED AND WIRELESS HEADPHONES; TELEPHONE HEADSETS; MOBILE PHONE AND MP3 PLAYER ACCESSORIES, NAMELY, SPEAKER SYSTEMS, HEADPHONES, EARPHONES, DONGLES IN THE NATURE OF USB (UNIVERSAL SERIAL BUS) HARDWARE FOR LIMITING AND PERMITTING USE OF MOBILE PHONES AND MP3 PLAYERS, FM RADIO TRANSMITTERS, FLEXIBLE DISPLAYS FOR MOBILE PHONES AND MP3 PLAYERS FOR SHOWING CONTENTS THROUGH A SCREEN AND PLAYING AUDIO/VISUAL RECORDINGS; PROTECTIVE FILMS FOR MP3 PLAYERS, NAMELY, PROTECTIVE COVERS SPECIALLY ADAPTED FOR MP3 PLAYERS; PROTECTIVE FILMS FOR MOBILE PHONES, NAMELY, PROTECTIVE COVERS SPECIALLY ADAPTED FOR MOBILE PHONES; MOBILE PHONE AND MP3 PLAYER ARMBAND ACCESSORIES, NAMELY, CARRYING CASES FOR MOBILE PHONES AND MP3 PLAYERS THAT ARE SPECIALLY ADAPTED FOR CARRYING THE MOBILE PHONE AND MP3 PLAYER ON THE ARM VIA AN ARMBAND; MOBILE PHONE AND MP3 PLAYER ACCESSORIES, NAMELY, SPECIALLY ADAPTED NECK STRAPS AND LANYARD TYPE NECK STRAPS FOR MOBILE PHONES AND MP3 PLAYERS WHICH RESTRAIN MOBILE PHONES AND MP3 PLAYERS FROM MOVEMENT ON A WEARER, KEYBOARD, SPEAKER HEADPHONES, ACCESSORIES FOR TELEVISION, NAMELY, PROGRAMMABLE DIGITAL TELEVISION RECORDERS, REMOTE CONTROLS FOR TELEVISIONS, AND TELEVISION ANTENNAS; AUDIO AND VISUAL APPARATUS, NAMELY, DVD PLAYERS AND VIDEO CASSETTE RECORDERS AND CD PLAYERS (U.S. CLS. 21, 23, 26, 36 AND 38).

CLASS 9—(Continued).

CIALY ADAPTED FOR MP3 PLAYERS; PROTECTIVE FILMS FOR MOBILE PHONES, NAMELY, PROTECTIVE COVERS SPECIALLY ADAPTED FOR MOBILE PHONES; MOBILE PHONE AND MP3 PLAYER ARMBAND ACCESSORIES, NAMELY, CARRYING CASES FOR MOBILE PHONES AND MP3 PLAYERS THAT ARE SPECIALLY ADAPTED FOR CARRYING THE MOBILE PHONE AND MP3 PLAYER ON THE ARM VIA AN ARMBAND; MOBILE PHONE AND MP3 PLAYER ACCESSORIES, NAMELY, SPECIALLY ADAPTED NECK STRAPS AND LANYARD TYPE NECK STRAPS FOR MOBILE PHONES AND MP3 PLAYERS WHICH RESTRAIN MOBILE PHONES AND MP3 PLAYERS FROM MOVEMENT ON A WEARER, KEYBOARD, SPEAKER HEADPHONES, ACCESSORIES FOR TELEVISION, NAMELY, PROGRAMMABLE DIGITAL TELEVISION RECORDERS, REMOTE CONTROLS FOR TELEVISIONS, AND TELEVISION ANTENNAS; AUDIO AND VISUAL APPARATUS, NAMELY, DVD PLAYERS AND VIDEO CASSETTE RECORDERS AND CD PLAYERS (U.S. CLS. 21, 23, 26, 36 AND 38).

APRIL HESIK, EXAMINING ATTORNEY

SN 77-048,693. DIGONIS, MICHAEL K., CITY ISLAND, NY. FILED 11-21-2006.

HYBRID ON DEMAND

THE MARK CONSISTS OF STANDARD CHARACTERS WITHOUT CLAIM TO ANY PARTICULAR FONT, STYLE, SIZE, OR COLOR.

NO CLAIM IS MADE TO THE EXCLUSIVE RIGHT TO USE "HYBRID", APART FROM THE MARK AS SHOWN.

FOR IDLE STOP MICROPROCESSORS USED FOR AUTOMOBILES AND APPLIED TO CONVENTIONAL ENGINE DRIVEN VEHICLES TO SHUT OFF AN ENGINE WHILE A VEHICLE IS STOPPED AND TO RESTART AN ENGINE WHEN A VEHICLE IS TO MOVE (U.S. CLS. 21, 23, 26, 36 AND 38).

WILLIAM ROSSMAN, EXAMINING ATTORNEY

SN 77-069,443. HIGH END SYSTEMS, INC., AUSTIN, TX. FILED 12-21-2006.

COLLAGE

THE MARK CONSISTS OF STANDARD CHARACTERS WITHOUT CLAIM TO ANY PARTICULAR FONT, STYLE, SIZE, OR COLOR.

FOR SOFTWARE FOR PROJECTING PANORAMIC IMAGES THROUGH MULTIPLE MULTIPARAMETER AUTOMATED LIGHTING FIXTURES (U.S. CLS. 21, 23, 26, 36 AND 38).

FIRST USE 12-1-2006; IN COMMERCE 12-1-2006. SHANNON TWOHIG, EXAMINING ATTORNEY

CLASS 9—(Continued).

SN 77-070,830. FREESTYLE AUDIO, LLC, SAN DIEGO, CA.
FILED 12-22-2006.

LIQUID MP3

THE MARK CONSISTS OF STANDARD CHARACTERS WITHOUT CLAIM TO ANY PARTICULAR FONT, STYLE, SIZE, OR COLOR.

NO CLAIM IS MADE TO THE EXCLUSIVE RIGHT TO USE "MP3", APART FROM THE MARK AS SHOWN.

FOR AUDIO EQUIPMENT, NAMELY, MP3 PLAYERS AND EARPHONES, ARMBAND HOLDERS SPECIALLY ADAPTED FOR SECURING THE MP3 PLAYER, ALL OF THE FOREGOING SOLD ON-LINE AND THROUGH AUTHORIZED DEALERS (U.S. CLS. 21, 23, 26, 36 AND 38).

HEATHER BIDDULPH, EXAMINING ATTORNEY

SN 77-080,613. VYRO GAMES LTD., DUBLIN 2, IRELAND,
FILED 1-11-2007.

RELAX TO WIN

THE MARK CONSISTS OF STANDARD CHARACTERS WITHOUT CLAIM TO ANY PARTICULAR FONT, STYLE, SIZE, OR COLOR.

FOR BIOSENSORS FOR STRESS MANAGEMENT FOR LIFE STYLE AND ENTERTAINMENT PURPOSES; MOBILE PHONES, PERSONAL COMPUTERS AND OTHER COMPUTING DEVICES, NAMELY, GAMING CONSOLES FOR USE WITH AN EXTERNAL DISPLAY SCREEN OR MONITOR AND COMPUTER SOFTWARE FOR GENERATING AND DISPLAYING DATA OUTCOMES FOR BIO-ANALYSIS AND GAMING (U.S. CLS. 21, 23, 26, 36 AND 38).

CAROLYN CATALDO, EXAMINING ATTORNEY

SN 77-098,454. LITERA CORPORATION, MCLEANSVILLE,
NC. FILED 2-2-2007.

METADACT

THE MARK CONSISTS OF STANDARD CHARACTERS WITHOUT CLAIM TO ANY PARTICULAR FONT, STYLE, SIZE, OR COLOR.

FOR COMPUTER PROGRAMMES FOR DOCUMENT MANAGEMENT (U.S. CLS. 21, 23, 26, 36 AND 38).

PAUL MORENO, EXAMINING ATTORNEY

CLASS 9—(Continued).

SN 77-117,109. THE NEON EDGE INC., WEST BERLIN, NJ.
FILED 2-27-2007.

LedGlow

THE MARK CONSISTS OF STANDARD CHARACTERS WITHOUT CLAIM TO ANY PARTICULAR FONT, STYLE, SIZE, OR COLOR.

FOR AUTOMOTIVE LIGHTING PRODUCTS THAT ARE USED ON THE INTERIOR AND THE EXTERIOR OF THE VEHICLE, NAMELY, LEDS (U.S. CLS. 21, 23, 26, 36 AND 38).

FIRST USE 1-1-2007; IN COMMERCE 2-1-2007.
TAMARA FRAZIER, EXAMINING ATTORNEY

SN 77-128,581. WMS GAMING INC., WAUKEGAN, IL.
FILED 3-12-2007.

SWINGIN' AND SPINNIN'

THE MARK CONSISTS OF STANDARD CHARACTERS WITHOUT CLAIM TO ANY PARTICULAR FONT, STYLE, SIZE, OR COLOR.

FOR GAMING MACHINES THAT GENERATE OR DISPLAY WAGER OUTCOMES; GAMING SOFTWARE THAT GENERATES OR DISPLAYS WAGER OUTCOMES OF GAMING MACHINES (U.S. CLS. 21, 23, 26, 36 AND 38).

LESLEY LAMOTHE, EXAMINING ATTORNEY

SN 77-145,989. ARC WIRELESS SOLUTIONS, INC., WHEAT
RIDGE, CO. FILED 4-2-2007.

ARC VLPA

THE MARK CONSISTS OF STANDARD CHARACTERS WITHOUT CLAIM TO ANY PARTICULAR FONT, STYLE, SIZE, OR COLOR.

FOR ANTENNAS, NOT FOR USE IN AIRCRAFT APPLICATIONS (U.S. CLS. 21, 23, 26, 36 AND 38).

FIRST USE 3-9-2007; IN COMMERCE 3-9-2007.
KIMBERLY FRYE, EXAMINING ATTORNEY

CLASS 9—(Continued).

SN 77-162,892. ARC WIRELESS SOLUTIONS, INC., WHEAT RIDGE, CO. FILED 4-23-2007.

ARC IES

THE MARK CONSISTS OF STANDARD CHARACTERS WITHOUT CLAIM TO ANY PARTICULAR FONT, STYLE, SIZE, OR COLOR.

FOR ANTENNAS AND ANTENNA MOUNTING BRACKETS SOLD AS A UNIT, NOT FOR AIRCRAFT APPLICATIONS (U.S. CLS. 21, 23, 26, 36 AND 38).

KIMBERLY FRYE, EXAMINING ATTORNEY

CLASS 9—(Continued).

CREATING A COMPASS DESIGN. THE COLOR WHITE APPEARS WITHIN THE COMPASS DESIGN AND IS INTENDED TO INDICATE A BACKGROUND AREA. THE COLOR WHITE IS NOT CLAIMED AS A FEATURE OF THE MARK. BELOW THE COMPASS DESIGN IS THE WORDING "ADVENTURE CENTRAL". THE WORD "ADVENTURE" IS IN GARNET LOWER CASED LETTERS AND THE WORD "CENTRAL" IS IN CHARTREUSE CAPITAL LETTERS FOLLOWED BY THE PHRASE "CONNECTING THE WORLD TO GREAT ADVENTURES" IN BLACK LETTERS.

FOR COMPUTER E-COMMERCE SOFTWARE TO ALLOW USERS TO PERFORM ELECTRONIC BUSINESS TRANSACTIONS VIA A GLOBAL COMPUTER NETWORK; COMPUTER SOFTWARE FOR PROVIDING AN ON-LINE DATABASE IN THE FIELD OF TRANSACTION PROCESSING TO UPLOAD TRANSACTIONAL DATA, PROVIDE STATISTICAL ANALYSIS, AND PRODUCE NOTIFICATIONS AND REPORTS (U.S. CLS. 21, 23, 26, 36 AND 38).

WENDY GOODMAN, EXAMINING ATTORNEY

SN 77-181,342. TMC CO., LTD., CHEONAN-SI, REPUBLIC OF KOREA, FILED 5-15-2007.

P-Route

OWNER OF REPUBLIC OF KOREA REG. NO. 40-0747404, DATED 5-20-2008, EXPIRES 5-20-2018.

THE COLOR(S) BLACK AND RED IS/ARE CLAIMED AS A FEATURE OF THE MARK.

THE MARK CONSISTS OF THE LETTER "P" IN BLACK SEPARATED BY A BLACK HYPHEN FROM THE WORD "ROUTE" IN RED.

FOR SHIPBOARD AND OFFSHORE CABLES, NAMELY, ELECTRICAL MARINE CABLES FOR USE ON SHIPBOARD, FIXED OR FLOATING PLATFORMS AND MOBILE OFFSHORE DRILLING UNITS (U.S. CLS. 21, 23, 26, 36 AND 38).

KATHERINE CHANG, EXAMINING ATTORNEY

SN 77-247,867. MERIDIAN 7, INC., DBA ADVENTURE CENTRAL, INC., DENVER, CO. FILED 8-6-2007.

acOFFICE
powered by adventure central

NO CLAIM IS MADE TO THE EXCLUSIVE RIGHT TO USE "ADVENTURE", APART FROM THE MARK AS SHOWN.

THE COLOR(S) GARNET, CHARTREUSE AND BLACK IS/ARE CLAIMED AS A FEATURE OF THE MARK.

THE MARK CONSISTS OF THE LETTERS "AC" IN GARNET FOLLOWED BY A COMPASS DESIGN THAT CONSISTS OF FOUR CHARTREUSE ARROWS BENEATH FOUR GARNET ARROWS WITH A CENTRAL GARNET CIRCLE IN THE CENTER THAT REPRESENTS THE LETTER "O" FOLLOWED BY THE LETTERS "FFICE" IN CHARTREUSE. THE COLOR WHITE APPEARS WITHIN THE COMPASS DESIGN AND IS INTENDED TO INDICATE A BACKGROUND AREA. THE COLOR WHITE IS NOT CLAIMED AS A FEATURE OF THE MARK. BELOW "ACOFFICE" IS THE WORDING "POWERED BY ADVENTURE CENTRAL" IN BLACK LETTERS.

FOR COMPUTER E-COMMERCE SOFTWARE TO ALLOW USERS TO PERFORM ELECTRONIC BUSINESS TRANSACTIONS VIA A GLOBAL COMPUTER NETWORK (U.S. CLS. 21, 23, 26, 36 AND 38).

WENDY GOODMAN, EXAMINING ATTORNEY

SN 77-247,691. MERIDIAN 7, INC., DBA ADVENTURE CENTRAL, INC., DENVER, CO. FILED 8-6-2007.

adventure
CENTRAL
Connecting the World to Great Adventures

NO CLAIM IS MADE TO THE EXCLUSIVE RIGHT TO USE "ADVENTURE", APART FROM THE MARK AS SHOWN.

THE COLOR(S) GARNET, CHARTREUSE, AND BLACK IS/ARE CLAIMED AS A FEATURE OF THE MARK.

THE MARK CONSISTS OF FOUR LARGE CHARTREUSE ARROWS CONNECTED BY TWO POINTS TO FORM A DIAMOND SHAPE; FOUR SMALLER GARNET ARROWS SIT BETWEEN THE CHARTREUSE ARROWS WITH A FLOATING CHARTREUSE CIRCLE IN THE CENTER

SN 77-247,882. MERIDIAN 7, INC., DBA ADVENTURE CENTRAL, INC., DENVER, CO. FILED 8-6-2007.

acCONNECT
powered by adventure central

NO CLAIM IS MADE TO THE EXCLUSIVE RIGHT TO USE "ADVENTURE", APART FROM THE MARK AS SHOWN.

THE COLOR(S) GARNET, CHARTREUSE AND BLACK IS/ARE CLAIMED AS A FEATURE OF THE MARK.

THE MARK CONSISTS OF THE LETTERS "AC" IN GARNET FOLLOWED BY A COMPASS DESIGN THAT CONSISTS OF FOUR CHARTREUSE ARROWS BENEATH

CLASS 9—(Continued).

FOUR GARNET ARROWS WITH A CENTRAL GARNET CIRCLE IN THE CENTER THAT REPRESENTS THE LETTER "O" FOLLOWED BY THE LETTERS "NNEC" IN CHARTREUSE AND THEN THE LETTER "T" IN GARNET. THE COLOR WHITE APPEARS WITHIN THE COMPASS DESIGN AND IS INTENDED TO INDICATE A BACKGROUND AREA. THE COLOR WHITE IS NOT CLAIMED AS A FEATURE OF THE MARK. BELOW "ACONNECT" IS THE WORDING "POWERED BY ADVENTURE CENTRAL" IN BLACK LETTERS.

FOR COMPUTER E-COMMERCE SOFTWARE TO ALLOW USERS TO PERFORM ELECTRONIC BUSINESS TRANSACTIONS VIA A GLOBAL COMPUTER NETWORK (U.S. CLS. 21, 23, 26, 36 AND 38).

WENDY GOODMAN, EXAMINING ATTORNEY

CLASS 9—(Continued).

SN 77-270,545. METABOLIC EFFECT, INC., WINSTON-SALEM, NC. FILED 9-4-2007.

ME METABOLIC EFFECT

THE MARK CONSISTS OF STANDARD CHARACTERS WITHOUT CLAIM TO ANY PARTICULAR FONT, STYLE, SIZE, OR COLOR.

OWNER OF U.S. REG. NO. 3,308,303.

FOR PRE-RECORDED CDS, VIDEO TAPES, LASER DISKS, DVDS AND DOWNLOADABLE AUDIO/VISUAL FILES FEATURING EDUCATION AND TRAINING IN THE FIELD OF HEALTH, FITNESS AND EXERCISE (U.S. CLS. 21, 23, 26, 36 AND 38).

JASON LOTT, EXAMINING ATTORNEY

SN 77-250,043. WILSON, GRAEME A, LONDON, UNITED KINGDOM, FILED 8-8-2007.

The Projects

THE MARK CONSISTS OF STANDARD CHARACTERS WITHOUT CLAIM TO ANY PARTICULAR FONT, STYLE, SIZE, OR COLOR.

FOR DOWNLOADABLE MP3 FILES AND MP3 RECORDINGS FEATURING MUSIC; COMPACT DISCS FEATURING MUSIC; PHONOGRAPH RECORDS FEATURING MUSIC (U.S. CLS. 21, 23, 26, 36 AND 38).

FIRST USE 1-1-2001; IN COMMERCE 4-1-2003.

JIM RINGLE, EXAMINING ATTORNEY

SN 77-270,727. KISP, INC., TORONTO, CANADA, FILED 9-4-2007.

KITS COLLABORATOR

SN 77-259,525. INTERTEST, INC., COLUMBIA, NJ. FILED 8-20-2007.

WEBVIEWER

THE MARK CONSISTS OF STANDARD CHARACTERS WITHOUT CLAIM TO ANY PARTICULAR FONT, STYLE, SIZE, OR COLOR.

FOR ULTRA-VIOLET INSPECTION CAMERAS, NAMELY, MAGNETIC PENETRANT TESTING CAMERAS FOR FINDING FLAWS IN METAL (U.S. CLS. 21, 23, 26, 36 AND 38).

SUSAN LESLIE DUBOIS, EXAMINING ATTORNEY

THE MARK CONSISTS OF STANDARD CHARACTERS WITHOUT CLAIM TO ANY PARTICULAR FONT, STYLE, SIZE, OR COLOR.

PRIORITY CLAIMED UNDER SEC. 44(D) ON CANADA APPLICATION NO. 1,337,992, FILED 3-5-2007, REG. NO. TMA706160, DATED 1-30-2008, EXPIRES 1-30-2023.

FOR COMPUTER SOFTWARE DESIGNED TO PROVIDE FOR THE SOURCING, SPECIFICATION, VISUALIZATION AND QUOTING OF OFFICE FURNITURE PRODUCTS AND SOLUTIONS (U.S. CLS. 21, 23, 26, 36 AND 38).

FIRST USE 6-0-2005; IN COMMERCE 6-0-2005.

INGA ERVIN, EXAMINING ATTORNEY

CLASS 9—(Continued).

SN 77-291,735. C-COM SATELLITE SYSTEMS INC., OTTAWA, CANADA, FILED 9-28-2007.

INETVU

THE MARK CONSISTS OF STANDARD CHARACTERS WITHOUT CLAIM TO ANY PARTICULAR FONT, STYLE, SIZE, OR COLOR.

PRIORITY CLAIMED UNDER SEC. 44(D) ON CANADA APPLICATION NO. 1365261, FILED 9-26-2007, REG. NO. TMA724416, DATED 9-25-2008, EXPIRES 9-25-2023.

FOR TELECOMMUNICATIONS PRODUCTS, NAMELY, MOBILE SATELLITE RECEIVERS, SATELLITE DISHES, ANTENNAS, SATELLITE ANTENNA PLATFORMS, SATELLITE CONTROLLERS AND TUNERS, SATELLITE AND CONTROLLER CASES, AND ELECTRONIC PARTS AND FITTINGS FOR THE AFORESAID; COMPUTER SOFTWARE FOR THE OPERATION OF MOBILE SATELLITE RECEIVERS, CONTROLLERS AND DISHES AND FOR ELECTRONIC PARTS AND FITTINGS THEREFOR (U.S. CLS. 21, 23, 26, 36 AND 38).

FIRST USE 1-0-2003; IN COMMERCE 1-0-2003.
ALEX KEAM, EXAMINING ATTORNEY

CLASS 9—(Continued).

SN 77-303,014. SONY COMPUTER ENTERTAINMENT EUROPE LIMITED, LONDON, UNITED KINGDOM, FILED 10-12-2007.

NUCLEUS

THE MARK CONSISTS OF STANDARD CHARACTERS WITHOUT CLAIM TO ANY PARTICULAR FONT, STYLE, SIZE, OR COLOR.

PRIORITY CLAIMED UNDER SEC. 44(D) ON UNITED KINGDOM APPLICATION NO. 2452513, FILED 4-13-2007, REG. NO. 2452513, DATED 6-13-2008, EXPIRES 4-13-2017.

FOR COMPUTER GAME SOFTWARE; VIDEO GAME SOFTWARE; ELECTRONIC GAME PROGRAMS (U.S. CLS. 21, 23, 26, 36 AND 38).

JOHN E. MICHOS, EXAMINING ATTORNEY

SN 77-303,168. EMC CORPORATION, HOPKINTON, MA, FILED 10-12-2007.

EMC

THE MARK CONSISTS OF STANDARD CHARACTERS WITHOUT CLAIM TO ANY PARTICULAR FONT, STYLE, SIZE, OR COLOR.

OWNER OF U.S. REG. NOS. 2,689,894, 2,932,656 AND OTHERS.

FOR COMPUTERS; COMPUTER FILE SERVERS; STORAGE AREA NETWORK (SAN) HARDWARE AND OPERATING SOFTWARE; NETWORK ATTACHED STORAGE (NAS) HARDWARE AND OPERATING SOFTWARE; COMPUTER DATA STORAGE AND RETRIEVAL APPARATUS, COMPRISING PROCESSORS, NETWORKS, MEMORIES, OPERATING SOFTWARE AND DATA STORAGE UNITS; COMPUTER HARDWARE AND COMPUTER SOFTWARE FOR DATA SECURITY AND DATA STORAGE SECURITY; SOFTWARE FOR DATA STORAGE AND INFORMATION MANAGEMENT; SOFTWARE FOR DATA ARCHIVING; SOFTWARE FOR DATA BACKUP AND RECOVERY; COMPUTER SOFTWARE FOR BUSINESS COLLABORATION AND WORK FLOW MANAGEMENT; COMPUTER SOFTWARE FOR CONTENT MANAGEMENT; COMPUTER SOFTWARE FOR DATA MOBILITY IN DATA STORAGE DEVICES; COMPUTER SOFTWARE FOR APPLICATION MANAGEMENT, NETWORK AND TELECOMMUNICATIONS MANAGEMENT, SERVER MANAGEMENT, AND STORAGE RESOURCE MANAGEMENT; COMPUTER SOFTWARE FOR VIRTUALIZATION OF COMPUTER DATA; SOFTWARE FOR DOCUMENT CAPTURE, IDENTIFICATION, SHARING, AND MANAGEMENT; COMPUTER SOFTWARE FOR BUSINESS COLLABORATION AND WORK FLOW MANAGEMENT (U.S. CLS. 21, 23, 26, 36 AND 38).

FIRST USE 0-0-1979; IN COMMERCE 0-0-1979.
DANNEAN HETZEL, EXAMINING ATTORNEY

SN 77-302,808. SONY COMPUTER ENTERTAINMENT EUROPE LIMITED, LONDON, UNITED KINGDOM, FILED 10-12-2007.

AQUAVITA

THE MARK CONSISTS OF STANDARD CHARACTERS WITHOUT CLAIM TO ANY PARTICULAR FONT, STYLE, SIZE, OR COLOR.

PRIORITY CLAIMED UNDER SEC. 44(D) ON UNITED KINGDOM APPLICATION NO. 2452508, FILED 4-13-2007, REG. NO. 2452508, DATED 5-30-2008, EXPIRES 4-13-2017.

FOR COMPUTER GAME SOFTWARE; VIDEO GAME SOFTWARE; ELECTRONIC GAME PROGRAMS (U.S. CLS. 21, 23, 26, 36 AND 38).

JOHN E. MICHOS, EXAMINING ATTORNEY

CLASS 9—(Continued).

SN 77-306,318. DIAPHORM TECHNOLOGIES, LLC, SALEM, NH. FILED 10-17-2007.

MAX PRO-ARMOR

THE MARK CONSISTS OF STANDARD CHARACTERS WITHOUT CLAIM TO ANY PARTICULAR FONT, STYLE, SIZE, OR COLOR.

FOR PROTECTIVE ARMOR FOR PERSONAL, VEHICLE AND STRUCTURAL APPLICATIONS, NAMELY, BODY ARMOR AND PROTECTIVE ARMOR PANELS FOR PROTECTING AGAINST BALLISTIC PROJECTILES AND EXPLOSIVE FRAGMENTS INSTALLED IN OR ATTACHED TO VEHICLES, BUILDINGS OR OTHER STRUCTURES (U.S. CLS. 21, 23, 26, 36 AND 38).

MICHELE SWAIN, EXAMINING ATTORNEY

SN 77-322,825. FINALDATA INC., SEOUL, REPUBLIC OF KOREA, FILED 11-6-2007.

FINALShield

OWNER OF REPUBLIC OF KOREA REG. NO. 0763262, DATED 10-1-2008, EXPIRES 10-1-2018.

THE COLOR(S) DARK BLUE AND BLUE IS/ARE CLAIMED AS A FEATURE OF THE MARK.

THE MARK CONSISTS OF THE WORD "FINAL" IN DARK BLUE AND UPPER-CASE AND THE WORD "SHIELD" IN BLUE WHERE THE LETTER "S" IS UPPER-CASE AND THE LETTERS "HIELD" ARE LOWER-CASE.

FOR DEVICE TO BLOCK RADIO FREQUENCY (RF) COMMUNICATION SIGNALS WHILE ACQUIRING DATA FROM MOBILE DEVICES (U.S. CLS. 21, 23, 26, 36 AND 38).

ESTHER BELENKER, EXAMINING ATTORNEY

CLASS 9—(Continued).

SN 77-330,598. FORESIGHT CORPORATION, DUBLIN, OH. FILED 11-15-2007.

BI Bridge

THE MARK CONSISTS OF STANDARD CHARACTERS WITHOUT CLAIM TO ANY PARTICULAR FONT, STYLE, SIZE, OR COLOR.

NO CLAIM IS MADE TO THE EXCLUSIVE RIGHT TO USE "BI", APART FROM THE MARK AS SHOWN.

FOR DATA EXTRACTION FACILITY COMPUTER SOFTWARE USED TO MAKE REAL TIME AND NEAR REAL TIME TRANSACTIONAL DETAIL AND SUMMARY DATA AVAILABLE FOR BUSINESS ORGANIZATIONS TO EXPAND THEIR KNOWLEDGE OF BUSINESS ACTIVITY RELATED INFORMATION TO IMPROVE BUSINESS DECISIONS BASED ON THIS KNOWLEDGE AND TO FEED VARIOUS SOFTWARE APPLICATIONS MORE TIMELY DATA (U.S. CLS. 21, 23, 26, 36 AND 38).

NATALIE POLZER, EXAMINING ATTORNEY

SN 77-332,570. BECHER, YITSCHAK, SCOTTSDALE, AZ. AND BECHER, PNINA, SCOTTSDALE, AZ. FILED 11-18-2007.

**Goldberg Variations -
Sleeping Aid Since 1685**

THE MARK CONSISTS OF STANDARD CHARACTERS WITHOUT CLAIM TO ANY PARTICULAR FONT, STYLE, SIZE, OR COLOR.

NO CLAIM IS MADE TO THE EXCLUSIVE RIGHT TO USE "GOLDBERG VARIATIONS", APART FROM THE MARK AS SHOWN.

FOR MUSIC RECORDINGS SOLD AS A KIT WITH A MASK (U.S. CLS. 21, 23, 26, 36 AND 38).

ROBERT LAVACHE, EXAMINING ATTORNEY

CLASS 9—(Continued).

SN 77-333,092. SPEEDO HOLDINGS BV, 1082 MD AMSTERDAM, NETHERLANDS, FILED 11-19-2007.

AQUABEAT

THE MARK CONSISTS OF STANDARD CHARACTERS WITHOUT CLAIM TO ANY PARTICULAR FONT, STYLE, SIZE, OR COLOR.

PRIORITY CLAIMED UNDER SEC. 44(D) ON ERP N CMNTY TM OFC APPLICATION NO. 006445241, FILED 11-16-2007, REG. NO. 006445241, DATED 10-23-2008, EXPIRES 11-16-2012.

FOR MP3 PLAYERS; BAGS AND CASES ADAPTED OR SHAPED TO CONTAIN MP3 PLAYERS; HEADPHONES; EARPHONES; AUDIO SPEAKERS; CHARGERS FOR ELECTRIC BATTERIES; FLASH MEMORY CARDS; APPARATUS FOR RECORDING, TRANSMISSION AND/OR REPRODUCTION OF SOUNDS, IMAGES OR OTHER DATA (U.S. CLS. 21, 23, 26, 36 AND 38).

PATRICIA EVANKO, EXAMINING ATTORNEY

SN 77-334,847. GENERITON CO., LTD., HSINCHU CITY, TAIWAN, FILED 11-21-2007.

Generit^{ion}

PRIORITY CLAIMED UNDER SEC. 44(D) ON TAIWAN APPLICATION NO. 096037711, FILED 8-7-2007.

THE MARK CONSISTS OF THE WORD "GENERITON" WHEREIN LETTERS OF "IT" ARE IN ITALIC TYPE, WITH A SQUARE SHADING IN THE BACKGROUND.

FOR ACCESS CONTROL AND ALARM MONITORING SYSTEMS; ADAPTER RINGS FOR ATTACHING OBJECTIVES ON CAMERAS; AUDIO CIRCUIT BOARDS; AUTOMATIC CASH REGISTERS; AUTOMATIC COMBUSTION CONTROL MACHINES AND INSTRUMENTS; AUTOMATIC CONTROLLERS FOR REVOLVING DOORS; AUTOMATIC ELECTRICAL DISTRIBUTION APPARATUS; BLANK DISKETTES; CAMERAS SHUTTERS; CARBON DIOXIDE DETECTORS; CELLULAR TELEPHONES; CHROMATOGRAPHY COLUMNS FOR USE IN PURIFICATION IN THE LABORATORY; CHRONOGRAPHS FOR USE AS SPECIALIZED TIME RECORDING APPARATUS; CIGAR LIGHTERS FOR AUTOMOBILES; CINEMATOGRAPHIC CAMERAS; CLINOMETER; CLINOMETERS; COLLAPSIBLE LIGHT DIRECTORS AND DIFFUSERS FOR USE WITH PHOTOGRAPHIC LIGHTING EQUIPMENT FOR PROFESSIONAL AND HIGH-END PHOTOGRAPHY; COLOR FILTERS FOR TELEVISION AND MOTION PICTURE FILM CAMERAS; COMMERCIAL SAFETY NETS; COMMUNICATION HUBS; COMMUNICATIONS SERVERS; COMPACT DISC CASES; COMPACT DISC PLAYERS; COMPACT DISCS; COMPARATORS; COMPONENT FEATURE OF AN OSCILLOSCOPE, NAMELY, AN ELECTRICAL SIGNAL ACQUISITION MODE; COMPUTER CENTRAL PROCESSING UNITS; COMPUTER CHASSIS; COMPUTER CHIPS; COMPUTER CURSOR CONTROL DEVICES, NAMELY, TRACKBALLS; COMPUTER DATABASE MANAGEMENT SOFTWARE FOR USE IN PERSONALIZING THE CONTENT OF EMAIL COMMUNICATIONS; COMPUTER E-COMMERCE SOFTWARE TO ALLOW USERS TO PERFORM ELECTRONIC BUSINESS TRANSACTIONS VIA A GLOBAL COMPUTER NETWORK; COMPUTER FIRMWARE FOR USE IN DATABASE MANAGEMENT; COMPUTER FIRMWARE FOR USE AS A SPREADSHEET; COMPUTER FIRMWARE FOR WORD PROCESSING; COMPUTER HARD DISCS; COMPUTER JOYSTICKS; COMPUTER PERIPHERAL APPARATUS; COMPUTER PRINTERS; COMPU-

CLASS 9—(Continued).

TER SOFTWARE FOR USE IN RELATION TO DIGITAL ANIMATION AND SPECIAL EFFECTS OF IMAGES; DIGITAL PHONES; EARPHONES; EARPHONES AND HEADPHONES; ELECTRIC WIRES AND CABLES; ELECTRONIC APPARATUS FOR THE REMOTE CONTROL OF INDUSTRIAL OPERATIONS; ELECTRONIC DESK CALCULATORS; ELECTROPLATING MACHINES; ELECTROSTATIC COATING MACHINES; ELECTROSTATIC EMISSION CONTROL DEVICES, NAMELY, ELECTROSTATIC PRECIPITATORS FOR REDUCING PARTICULATE EMISSION IN INDUSTRIAL APPLICATIONS; HANDS FREE KITS FOR PHONES; HAND-HELD DEVICE COMPRISED OF CHEMICAL AND HEAT SENSORS FOR THE DETECTION OF EXPLOSIVES; HARD DRIVES FOR COMPUTERS; HEAT DETECTION SYSTEMS COMPRISED OF FIBER OPTIC LINEAR LOOP CONFIGURATIONS, HEAT DETECTORS, MONITORS; HELMET SAFETY LIGHTS; HIGH FREQUENCY SWITCHES; HIGH PRESSURE MANOMETERS; LABORATORY EQUIPMENT AND SUPPLIES, NAMELY, INCUBATORS; OPACIMETER; OPEN-WIRE TRANSMISSION MACHINES AND APPARATUS; OPTICAL SEMICONDUCTOR AMPLIFIERS; OPTICAL SHUTTERS; PORTABLE ELECTRONIC RECORDER FOR MEASURING AND RECORDING MULTIPLE VOLTAGE, CURRENT AND THERMOCOUPLE READINGS FROM VARIOUS TRANSDUCERS; REMOTE CURSOR CONTROLS FOR COMPUTERS (U.S. CLS. 21, 23, 26, 36 AND 38).

PAUL E. FAHRENKOPF, EXAMINING ATTORNEY

SN 77-345,193. SUN MICROSYSTEMS, INC., SANTA CLARA, CA. FILED 12-5-2007.

OPENDS

THE MARK CONSISTS OF STANDARD CHARACTERS WITHOUT CLAIM TO ANY PARTICULAR FONT, STYLE, SIZE, OR COLOR.

FOR COMPUTER HARDWARE; COMPUTER PROGRAMS, NAMELY, COMPUTER PROGRAMS FOR TESTING COMPATIBILITY OF COMPUTER PROGRAMS; COMPUTER PROGRAMS FOR USE IN COMPUTER NETWORKING; COMPUTER PROGRAMS FOR USE IN COMPUTER EMULATION; COMPUTER PROGRAMS FOR USE IN ELECTRONIC MAIL; COMPUTER PROGRAMS FOR USE IN OPERATING VOICE MAIL AND VOICE MESSAGING; COMPUTER PROGRAMS FOR CREATING GRAPHICAL INTERFACES; COMPUTER PROGRAMS FOR USE IN DATABASE MANAGEMENT; COMPUTER PROGRAMS FOR USE IN PROJECT MANAGEMENT; COMPUTER PROGRAMS FOR DOCUMENT PROCESSING; COMPUTER PROGRAMS FOR WORD PROCESSING; COMPUTER PROGRAMS FOR PREPARING SPREADSHEETS; COMPUTER PROGRAMS FOR USE IN COMPUTER SECURITY; COMPUTER PROGRAMS FOR USE IN THE DEVELOPMENT OF COMPUTER PROGRAMS, PROGRAMMING LANGUAGES, TOOLKITS AND COMPILERS; COMPUTER PROGRAMS FOR USE IN DEVELOPING, COMPILING AND EXECUTING OTHER COMPUTER PROGRAMS ON COMPUTERS, COMPUTER NETWORKS, AND GLOBAL COMMUNICATIONS NETWORKS; COMPUTER PROGRAMS FOR USE IN NAVIGATING, BROWSING, TRANSFERRING INFORMATION, AND DISTRIBUTING AND VIEWING OTHER COMPUTER PROGRAMS ON COMPUTERS, COMPUTER NETWORKS AND GLOBAL COMMUNICATIONS NETWORKS; COMPUTER PROGRAMS FOR RECORDING, PROCESSING, RECEIVING, REPRODUCING, TRANSMITTING, MODIFYING, COMPRESSING, DECOMPRESSING, BROADCASTING, MERGING, AND/OR ENHANCING SOUND, VIDEO,

CLASS 9—(Continued).

IMAGES, GRAPHICS, AND/OR DATA; COMPUTER OPERATING SYSTEM PROGRAMS; COMPUTER UTILITY PROGRAMS; COMPUTER PROGRAMS FOR USE WITH COMPUTER SERVERS; COMPUTER TELEPHONY SOFTWARE; COMPUTER PROGRAMS USED IN ACCESSING DATABASES; COMPUTER GAME PROGRAMS; COMPUTER SOFTWARE AND FIRMWARE FOR THE MANAGEMENT, TRANSMISSION AND STORAGE OF DATA AND INFORMATION; COMPUTER PROGRAMS TO ENABLE THE TRANSMISSION OF PHOTOGRAPHS, MUSIC, AND IMAGES TO MOBILE TELEPHONES; DOWNLOADABLE ELECTRONIC PUBLICATIONS IN THE NATURE OF USER MANUALS, WHITE PAPERS, AND TECHNICAL DOCUMENTATION, NAMELY, REPORTS, ARTICLES, ANNOUNCEMENTS, DATA SHEETS, AND ELECTRONIC SLIDE PRESENTATIONS RELATED TO PLANNING, DEPLOYING, INSTALLING, CONFIGURING AND RUNNING COMPUTER HARDWARE AND SOFTWARE, IN THE FIELD OF COMPUTER HARDWARE AND SOFTWARE DEVELOPMENT (U.S. CLS. 21, 23, 26, 36 AND 38).

SOPHIA S. KIM, EXAMINING ATTORNEY

SN 77-345,846. WESTMARK INTERNATIONAL, INC., BURTONSVILLE, MD. FILED 12-6-2007.

MY FITTING BELT

THE MARK CONSISTS OF STANDARD CHARACTERS WITHOUT CLAIM TO ANY PARTICULAR FONT, STYLE, SIZE, OR COLOR.

NO CLAIM IS MADE TO THE EXCLUSIVE RIGHT TO USE "FITTING", APART FROM THE MARK AS SHOWN, FOR MEASURING TAPES (U.S. CLS. 21, 23, 26, 36 AND 38).

ESTHER BELENKER, EXAMINING ATTORNEY

SN 77-346,295. FOOD OF LOVE, LLC, LAS VEGAS, NV. FILED 12-7-2007.

FOOD of LOVE

THE MARK CONSISTS OF STANDARD CHARACTERS WITHOUT CLAIM TO ANY PARTICULAR FONT, STYLE, SIZE, OR COLOR.

NO CLAIM IS MADE TO THE EXCLUSIVE RIGHT TO USE "FOOD", APART FROM THE MARK AS SHOWN.

FOR DIGITAL MATERIALS, NAMELY, CDS AND DVDS FEATURING RECIPES, COOKING VIDEOS, COOKING INSTRUCTION; DIGITAL MEDIA, NAMELY, CDS, AND DVDS FEATURING RECIPES, COOKING VIDEOS, COOKING INSTRUCTIONS; PRE-RECORDED CDS, VIDEO TAPES, LASER DISKS AND DVDS FEATURING RECIPES, COOKING VIDEOS, COOKING INSTRUCTIONS; ELECTRONIC PUBLICATIONS, NAMELY, COOKBOOKS FEATURING RECIPES AND RECIPE DEMOS RECORDED ON COMPUTER MEDIA (U.S. CLS. 21, 23, 26, 36 AND 38).

STEPHEN AQUILA, EXAMINING ATTORNEY

CLASS 9—(Continued).

SN 77-365,727. UNIVERSITY OF UTAH, SALT LAKE CITY, UT. FILED 1-7-2008.

MEMnagerie

THE MARK CONSISTS OF STANDARD CHARACTERS WITHOUT CLAIM TO ANY PARTICULAR FONT, STYLE, SIZE, OR COLOR.

FOR SILICON CHIPS (U.S. CLS. 21, 23, 26, 36 AND 38).
MICHAEL WIENER, EXAMINING ATTORNEY

SN 77-367,713. ADVANCED LITHIUM ELECTROCHEMISTRY CO., LTD., DBA ADVANCED LITHIUM ELECTROCHEMISTRY CO., LTD., TAOYUAN COUNTY, TAIWAN, FILED 1-9-2008.

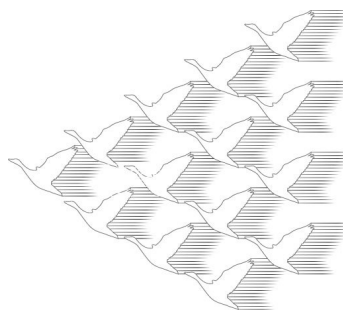

THE MARK CONSISTS OF FLYING BIRDS, FOR ELECTRIC BATTERIES FOR VEHICLES, ACCUMULATORS FOR VEHICLES, BATTERIES, BATTERY CHARGERS, ELECTRODES, BATTERY JARS, BATTERY BOXES, ELECTRIC BATTERIES, HIGH VOLTAGE BATTERIES, ACCUMULATORS, ACCUMULATOR BOXES, ACCUMULATOR JARS, CATHODES (U.S. CLS. 21, 23, 26, 36 AND 38).

FIRST USE 10-11-2007; IN COMMERCE 12-21-2007.
SEAN CROWLEY, EXAMINING ATTORNEY

SN 77-369,470. CUMMINS-ALLISON CORP., MT. PROSPECT, IL. FILED 1-11-2008.

IQ CF SENSORS

THE MARK CONSISTS OF STANDARD CHARACTERS WITHOUT CLAIM TO ANY PARTICULAR FONT, STYLE, SIZE, OR COLOR.

NO CLAIM IS MADE TO THE EXCLUSIVE RIGHT TO USE "CF SENSORS", APART FROM THE MARK AS SHOWN.

FOR CURRENCY AUTHENTICATING SENSORS (U.S. CLS. 21, 23, 26, 36 AND 38).

HEATHER SAPP, EXAMINING ATTORNEY

CLASS 9—(Continued).

SN 77-373,450. VISIBLE ASSETS, INC., MISSISSAUGA, CANADA, FILED 1-16-2008.

SAFARI

THE MARK CONSISTS OF STANDARD CHARACTERS WITHOUT CLAIM TO ANY PARTICULAR FONT, STYLE, SIZE, OR COLOR.

FOR COMPUTER NETWORKING HARDWARE, NAMELY, COMPUTER NETWORK ROUTERS, COMPUTER SERVERS, AND COMPUTER SOFTWARE SYSTEMS, ALL FOR USE FOR MOBILE ASSET MANAGEMENT, NAMELY, TRACKING PRODUCT LOCATION AND PHYSICAL STATUS, IN GPS-EQUIPPED VEHICLES (U.S. CLS. 21, 23, 26, 36 AND 38).

SANJEEV VOHRA, EXAMINING ATTORNEY

CLASS 9—(Continued).

SN 77-381,388. KHANAL, SANJAYA, QUARTZ HILL, CA. AND UPRETI, PRASHANT, SUNNYVALE, CA. FILED 1-26-2008.

MeMR

THE MARK CONSISTS OF STANDARD CHARACTERS WITHOUT CLAIM TO ANY PARTICULAR FONT, STYLE, SIZE, OR COLOR.

FOR SECURED INTERNET PROTOCOL ENABLED DEVICE WITH THE CAPABILITY TO READ, WRITE, SCAN, STORE, TRANSMIT AND RECEIVE MEDICAL RECORDS THROUGH WIRELESS MEDIUMS OR WIRED MEDIUMS (U.S. CLS. 21, 23, 26, 36 AND 38).

KIMBERLY PERRY, EXAMINING ATTORNEY

SN 77-374,576. D. MACD. MARKETING, LLC, LYME, CT. FILED 1-17-2008.

CenterLine Optics

THE MARK CONSISTS OF STANDARD CHARACTERS WITHOUT CLAIM TO ANY PARTICULAR FONT, STYLE, SIZE, OR COLOR.

NO CLAIM IS MADE TO THE EXCLUSIVE RIGHT TO USE "OPTICS", APART FROM THE MARK AS SHOWN.

FOR READING EYEGLASSES, SUNGLASSES, EYEGLASS FRAMES, SUNGLASSES FRAMES; EYEGLASS AND SUNGLASSES ACCESSORIES, NAMELY, EYEGLASS AND SUNGLASS CASES (U.S. CLS. 21, 23, 26, 36 AND 38).

FIRST USE 2-24-2003; IN COMMERCE 2-24-2003.
REBECCA SMITH, EXAMINING ATTORNEY

SN 77-381,393. UPRETI, PRASHANT, SUNNYVALE, CA. AND KHANAL, SANJAYA, QUARTZ HILL, CA. FILED 1-26-2008.

MyMR

THE MARK CONSISTS OF STANDARD CHARACTERS WITHOUT CLAIM TO ANY PARTICULAR FONT, STYLE, SIZE, OR COLOR.

FOR SECURED INTERNET PROTOCOL ENABLED DEVICE WITH THE CAPABILITY TO READ, WRITE, SCAN, STORE, TRANSMIT AND RECEIVE MEDICAL RECORDS THROUGH WIRELESS MEDIUMS OR WIRED MEDIUMS (U.S. CLS. 21, 23, 26, 36 AND 38).

KIMBERLY PERRY, EXAMINING ATTORNEY

SN 77-376,828. HARMAN INTERNATIONAL INDUSTRIES, INCORPORATED, NORTHRIDGE, CA. FILED 1-21-2008.

HIQNET

THE MARK CONSISTS OF STANDARD CHARACTERS WITHOUT CLAIM TO ANY PARTICULAR FONT, STYLE, SIZE, OR COLOR.

OWNER OF U.S. REG. NO. 3,406,616.

FOR COMPUTER SOFTWARE FOR REMOTE CONTROL OF ONE OR MORE AUDIO PRODUCTS, NAMELY, MICROPHONES, MIXERS, AMPLIFIERS, SIGNAL PROCESSORS AND SPEAKERS THAT IS USED FOR CONTROL AND CONFIGURING SAID AUDIO PRODUCTS IN A NETWORKED SYSTEM (U.S. CLS. 21, 23, 26, 36 AND 38).

FIRST USE 9-19-2005; IN COMMERCE 9-19-2005.
MARTHA SANTOMARTINO, EXAMINING ATTORNEY

SN 77-383,151. FREEPORT-MCMORAN COPPER AND GOLD, INC., PHOENIX, AZ. FILED 1-29-2008.

ARDVARC

THE MARK CONSISTS OF STANDARD CHARACTERS WITHOUT CLAIM TO ANY PARTICULAR FONT, STYLE, SIZE, OR COLOR.

FOR INDUSTRIAL AUTOMATION CONTROL SYSTEM KITS FOR MINING EQUIPMENT, NAMELY, DRILL EQUIPMENT, COMPRISING HARDWARE, SOFTWARE AND ELECTRICAL CONTROLLERS FOR CONTROLLING AND MONITORING FUNCTIONS AND COMPONENTS OF DRILL MACHINES, NAMELY, TRAMMING, HYDRAULICS, LEVELING, DRILLING, AND COLLECTING AND PROCESSING DATA GENERATED AS A RESULT (U.S. CLS. 21, 23, 26, 36 AND 38).

ALLISON SCHRODY, EXAMINING ATTORNEY

CLASS 9—(Continued).

SN 77-388,537. MONOSCOOP, B.V., ALKMAAR, NETHERLANDS, FILED 2-5-2008.



NO CLAIM IS MADE TO THE EXCLUSIVE RIGHT TO USE "BINGO", APART FROM THE MARK AS SHOWN.

THE COLOR(S) YELLOW, ORANGE AND RED IS/ARE CLAIMED AS A FEATURE OF THE MARK.

THE MARK CONSISTS OF STYLIZED THREE DIMENSIONAL YELLOW AND ORANGE LETTERING WITH DARK RED OUTLINE.

FOR GAMING DEVICES, NAMELY, GAMING MACHINES, SLOT MACHINES, BINGO MACHINES, WITH OR WITHOUT VIDEO OUTPUT; COMPUTER SOFTWARE AND FIRMWARE FOR GAMES OF CHANCE ON ANY COMPUTERIZED PLATFORM, INCLUDING DEDICATED GAMING CONSOLES, VIDEO BASED SLOT MACHINES, REEL BASED SLOT MACHINES, AND VIDEO LOTTERY TERMINALS (U.S. CLS. 21, 23, 26, 36 AND 38).

AMY ALFIERI, EXAMINING ATTORNEY

SN 77-388,558. MONOSCOOP, B.V., ALKMAAR, NETHERLANDS, FILED 2-5-2008.



THE COLOR(S) ORANGE, BLACK, YELLOW, WHITE, GRAY, TAN AND BROWN IS/ARE CLAIMED AS A FEATURE OF THE MARK.

THE MARK CONSISTS OF STYLIZED THREE DIMENSIONAL ORANGE LETTERING WITH BLACK AND YELLOW OUTLINE. THE TERM "SAN" APPEARS OVER A BLACK BULL DESIGN WITH WHITE HORN LIKE DESIGNS PROTRUDING FROM EITHER SIDE OF THE BULL. THE TERM "FERMIN" APPEARS OVER A BROWN BULL'S HEAD WITH WHITE AND BROWN HORNS AND WHITE CLOUDS OF SMOKE OUTLINED IN GRAY. EXCEPT FOR THE CLOUDS OF SMOKE, THE WORDING AND DESIGN APPEAR AGAINST A TAN BACKGROUND OUTLINED IN BROWN.

THE ENGLISH TRANSLATION OF THE WORD "SAN FERMIN" IN THE MARK IS "SAINT FERMIN".

FOR GAMING DEVICES, NAMELY, GAMING MACHINES, SLOT MACHINES, BINGO MACHINES, WITH OR WITHOUT VIDEO OUTPUT; COMPUTER SOFTWARE AND FIRMWARE FOR GAMES OF CHANCE ON ANY COMPUTERIZED PLATFORM, INCLUDING DEDICATED GAMING CONSOLES, VIDEO BASED SLOT MACHINES, REEL BASED SLOT MACHINES, AND VIDEO LOTTERY TERMINALS (U.S. CLS. 21, 23, 26, 36 AND 38).

AMY ALFIERI, EXAMINING ATTORNEY

CLASS 9—(Continued).

SN 77-388,691. KNIGHT CAPITAL GROUP, INC., JERSEY CITY, NJ. FILED 2-5-2008.

Knight Direct EMS

THE MARK CONSISTS OF STANDARD CHARACTERS WITHOUT CLAIM TO ANY PARTICULAR FONT, STYLE, SIZE, OR COLOR.

OWNER OF U.S. REG. NOS. 3,238,037, 3,332,616 AND 3,420,180.

FOR COMPUTER SOFTWARE PROGRAMS FOR FACILITATING AND MANAGING THE ELECTRONIC EXECUTION OF TRADING EQUITIES AND CURRENCIES, FOR USE IN THE FIELD OF ELECTRONIC DIRECT MARKET ACCESS TO SECURITIES, FINANCIAL SERVICES AND PRODUCTS, AND RELATED FINANCIAL MARKET NEWS AND INFORMATION (U.S. CLS. 21, 23, 26, 36 AND 38).

MARK T. MULLEN, EXAMINING ATTORNEY

SN 77-395,604. VITAE CARING FOUNDATION, JEFFERSON CITY, MO. FILED 2-13-2008.

VITAE CARING FOUNDATION

THE MARK CONSISTS OF STANDARD CHARACTERS WITHOUT CLAIM TO ANY PARTICULAR FONT, STYLE, SIZE, OR COLOR.

NO CLAIM IS MADE TO THE EXCLUSIVE RIGHT TO USE "FOUNDATION", APART FROM THE MARK AS SHOWN.

THE ENGLISH TRANSLATION OF "VITAE" IN THE MARK IS LIVES.

FOR PRERECORDED VIDEO AND AUDIO MEDIA FEATURING PRO-LIFE ISSUES (U.S. CLS. 21, 23, 26, 36 AND 38).

FIRST USE 0-0-2002; IN COMMERCE 0-0-2002.

CARYN GLASSER, EXAMINING ATTORNEY

SN 77-396,792. MR. CHRISTMAS INCORPORATED, NEW YORK, NY. FILED 2-14-2008.

ILLUMINEYES

THE MARK CONSISTS OF STANDARD CHARACTERS WITHOUT CLAIM TO ANY PARTICULAR FONT, STYLE, SIZE, OR COLOR.

FOR EYEGLASSES (U.S. CLS. 21, 23, 26, 36 AND 38).

GRETTA YAO, EXAMINING ATTORNEY

CLASS 9—(Continued).

SN 77-399,853. VENTIS CORPORATION, CARSON CITY, NV. FILED 2-18-2008.

Ventis

THE MARK CONSISTS OF STANDARD CHARACTERS WITHOUT CLAIM TO ANY PARTICULAR FONT, STYLE, SIZE, OR COLOR.

FOR ANTENNAS, ANTENNA SYSTEMS AND ANTENNA RECEIVERS, NAMELY, DIRECTIONAL AND OMNI DIRECTIONAL ANTENNAS AND DIRECTION-FINDING SYSTEMS, NAMELY, COMPUTER HARDWARE; ANTENNA AND RADAR SOFTWARE, NAMELY, BROADBAND RADIO FREQUENCY AND WIRELESS SOFTWARE; BROADBAND RADIO FREQUENCY AND WIRELESS HARDWARE (U.S. CLS. 21, 23, 26, 36 AND 38).

LEIGH CAROLINE CASE, EXAMINING ATTORNEY

CLASS 9—(Continued).

SN 77-402,074. SNAP-ON INCORPORATED, KENOSHA, WI. FILED 2-20-2008.

WITECH

THE MARK CONSISTS OF STANDARD CHARACTERS WITHOUT CLAIM TO ANY PARTICULAR FONT, STYLE, SIZE, OR COLOR.

FOR WIRELESS AUTOMOBILE DIAGNOSTIC APPARATUS FOR ENGINE SYSTEMS, TRANSMISSIONS, SUSPENSIONS, AND OTHER SUCH ELECTRONICALLY CONTROLLED SYSTEMS IN VEHICLES (U.S. CLS. 21, 23, 26, 36 AND 38).

JOHN E. MICHOS, EXAMINING ATTORNEY

SN 77-402,753. HITACHI HOME ELECTRONICS (AMERICA), INC., CHULA VISTA, CA. FILED 2-21-2008.

CINEMA48

THE MARK CONSISTS OF STANDARD CHARACTERS WITHOUT CLAIM TO ANY PARTICULAR FONT, STYLE, SIZE, OR COLOR.

FOR TELEVISIONS; APPARATUS FOR TRANSMITTING, REPRODUCING AND REPLAYING IMAGES, NAMELY, TELEVISION RECEIVERS, TELEVISION DISPLAY MONITORS AND PARTS THEREFORE; COMPUTER MICROPROCESSORS AND COMPUTER SOFTWARE FOR USE IN CONNECTION WITH TELEVISION RECEIVERS AND DISPLAY MONITORS FOR REPLAYING, CONTROLLING, AND ENHANCING AUDIOVISUAL IMAGES AND SOUND QUALITIES (U.S. CLS. 21, 23, 26, 36 AND 38).

RUSS HERMAN, EXAMINING ATTORNEY

SN 77-400,942. YELLE, JUSTIN, MENDON, NY. FILED 2-19-2008.



NO CLAIM IS MADE TO THE EXCLUSIVE RIGHT TO USE "RECORDS", APART FROM THE MARK AS SHOWN.

THE STIPPLING IS FOR SHADING PURPOSES ONLY.

THE MARK CONSISTS OF A DESIGN RESEMBLING A SIDEWAYS SIGN LANGUAGE LETTER "K" FEATURING LINING THAT RESEMBLES FADER BARS OF AN AUDIO BOARD. THE DESIGN APPEARS ABOVE THE STYLIZED WORD "KAOTIC", IN WHICH THE DOT OVER THE LETTER "I" IS REPLACED WITH A SMALLER VERSION OF THE SIDEWAYS SIGN LANGUAGE LETTER "K" DESIGN. BELOW THE WORD "KAOTIC" IS THE STYLIZED WORD "RECORDS" WITH A HORIZONTAL LINE CONNECTING TO THE LOWER LEFT LEG OF THE FIRST LETTER "R" IN THE WORD "RECORDS" AND A HORIZONTAL LINE CONNECTING TO THE TOP RIGHT CURVE OF THE LETTER "S" IN "RECORDS".

FOR MUSICAL SOUND RECORDINGS (U.S. CLS. 21, 23, 26, 36 AND 38).

FIRST USE 10-0-2001; IN COMMERCE 9-0-2006.

KAELIE KUNG, EXAMINING ATTORNEY

SN 77-407,460. PENTAX OF AMERICA, MONTVALE, NJ. FILED 2-27-2008.

Pentax I-Scan

THE MARK CONSISTS OF STANDARD CHARACTERS WITHOUT CLAIM TO ANY PARTICULAR FONT, STYLE, SIZE, OR COLOR.

FOR COMPUTER SOFTWARE AND HARDWARE FOR MANAGING AND ANALYZING ENDOSCOPIC EXAMINATION DATA AND CONTROLLING ENDOSCOPIC EQUIPMENT (U.S. CLS. 21, 23, 26, 36 AND 38).

MARCIE MILONE, EXAMINING ATTORNEY

CLASS 9—(Continued).

SN 77-407,469. PENTAX OF AMERICA, MONTVALE, NJ. FILED 2-27-2008.

Pentax I-Platform

THE MARK CONSISTS OF STANDARD CHARACTERS WITHOUT CLAIM TO ANY PARTICULAR FONT, STYLE, SIZE, OR COLOR.

FOR COMPUTER SOFTWARE AND HARDWARE FOR MANAGING AND ANALYZING ENDOSCOPIC EXAMINATION DATA AND CONTROLLING ENDOSCOPIC EQUIPMENT (U.S. CLS. 21, 23, 26, 36 AND 38).

MARCIE MILONE, EXAMINING ATTORNEY

SN 77-409,747. SUNGARD BUSINESS SYSTEMS LLC, WILMINGTON, DE. FILED 2-29-2008.

OMNI

THE MARK CONSISTS OF STANDARD CHARACTERS WITHOUT CLAIM TO ANY PARTICULAR FONT, STYLE, SIZE, OR COLOR.

OWNER OF U.S. REG. NOS. 2,343,626, 3,395,864 AND OTHERS.

FOR COMPUTER SOFTWARE USED BY PENSION AND BENEFIT PLAN ADMINISTRATORS FOR RECORD KEEPING, PROCESSING, MANAGEMENT, AND ADMINISTRATION OF PENSION AND BENEFIT PLANS (U.S. CLS. 21, 23, 26, 36 AND 38).

KATHY DE JONGE, EXAMINING ATTORNEY

SN 77-411,087. RMI CORPORATION, DBA RAZA MICRO-ELECTRONICS, INC., CUPERTINO, CA. FILED 3-3-2008.

HMP Processor

THE MARK CONSISTS OF STANDARD CHARACTERS WITHOUT CLAIM TO ANY PARTICULAR FONT, STYLE, SIZE, OR COLOR.

NO CLAIM IS MADE TO THE EXCLUSIVE RIGHT TO USE "PROCESSOR", APART FROM THE MARK AS SHOWN.

FOR SEMICONDUCTOR CHIPS; SEMICONDUCTOR DEVICES; SEMICONDUCTORS; ELECTRONIC CHIPS FOR THE MANUFACTURER OF INTEGRATED CIRCUITS; ELECTRONIC INTEGRATED CIRCUITS; INTEGRATED CIRCUITS; INTEGRATED CIRCUITS AND INTEGRATED CIRCUIT CORES FOR USE IN WIRELESS COMMUNICATIONS AND WIRELESS COMMUNICATION EQUIPMENT AND APPARATI AND DIGITAL SIGNAL PROCESSORS (DSP); LARGE SCALE INTEGRATED CIRCUITS (U.S. CLS. 21, 23, 26, 36 AND 38).

FIRST USE 11-18-2008; IN COMMERCE 11-18-2008.

HANNO RITTNER, EXAMINING ATTORNEY

CLASS 9—(Continued).

SN 77-411,673. CELLCO PARTNERSHIP, DBA VERIZON WIRELESS, BASKING RIDGE, NJ. FILED 3-3-2008.

VESSEL

THE MARK CONSISTS OF STANDARD CHARACTERS WITHOUT CLAIM TO ANY PARTICULAR FONT, STYLE, SIZE, OR COLOR.

FOR WIRELESS COMMUNICATION DEVICE FEATURING VOICE, DATA AND IMAGE TRANSMISSION INCLUDING VOICE, TEXT AND PICTURE MESSAGING, A VIDEO AND STILL IMAGE CAMERA, ALSO FUNCTIONAL TO PURCHASE MUSIC, GAMES, VIDEO AND SOFTWARE APPLICATIONS OVER THE AIR FOR DOWNLOADING TO THE DEVICE (U.S. CLS. 21, 23, 26, 36 AND 38).

ESTHER BELENKER, EXAMINING ATTORNEY

SN 77-411,676. CELLCO PARTNERSHIP, DBA VERIZON WIRELESS, BASKING RIDGE, NJ. FILED 3-3-2008.

TORRENT

THE MARK CONSISTS OF STANDARD CHARACTERS WITHOUT CLAIM TO ANY PARTICULAR FONT, STYLE, SIZE, OR COLOR.

FOR WIRELESS COMMUNICATIONS DEVICE FEATURING VOICE, DATA AND IMAGE TRANSMISSION INCLUDING VOICE, TEXT AND PICTURE MESSAGING, A VIDEO AND STILL IMAGE CAMERA, ALSO FUNCTIONAL TO PURCHASE MUSIC, GAMES, VIDEO AND SOFTWARE APPLICATIONS OVER THE AIR FOR DOWNLOADING TO THE DEVICE (U.S. CLS. 21, 23, 26, 36 AND 38).

ESTHER BELENKER, EXAMINING ATTORNEY

SN 77-411,874. NANOMETRICS INCORPORATED, MILPITAS, CA. FILED 3-3-2008.

IMPULSE

THE MARK CONSISTS OF STANDARD CHARACTERS WITHOUT CLAIM TO ANY PARTICULAR FONT, STYLE, SIZE, OR COLOR.

THE MARK "IMPULSE" HAS NO MEANING IN A FOREIGN LANGUAGE.

FOR THIN FILM, STRUCTURE, AND WAFER SURFACE MEASUREMENT DEVICES, NAMELY, METROLOGY AND INSPECTION TOOLS THAT ARE DESIGNED TO FIT INSIDE OR BE MOUNTED ONTO AND CONTROL PRODUCTION EQUIPMENT AND METROLOGY EQUIPMENT USED IN THE MANUFACTURE OF INTEGRATED CIRCUITS (U.S. CLS. 21, 23, 26, 36 AND 38).

FIRST USE 7-11-2008; IN COMMERCE 7-11-2008.

MICHAEL KEATING, EXAMINING ATTORNEY

CLASS 9—(Continued).

SN 77-413,573. TEAM FINANCIAL MANAGEMENT SYSTEMS, INC., OMAHA, NE. FILED 3-5-2008.

Team Software

THE MARK CONSISTS OF STANDARD CHARACTERS WITHOUT CLAIM TO ANY PARTICULAR FONT, STYLE, SIZE, OR COLOR.

NO CLAIM IS MADE TO THE EXCLUSIVE RIGHT TO USE "SOFTWARE", APART FROM THE MARK AS SHOWN.

FOR COMPUTER SOFTWARE FOR USE IN THE BUILDING SERVICES CONTRACTING AND SECURITY INDUSTRIES FOR USE IN BIDDING AND ESTIMATING, PERSONNEL SCHEDULING, PROJECT AND WORK SCHEDULING, INVENTORY MANAGEMENT, TIMEKEEPING, PAYROLL, ACCOUNTING AND JOB COSTING (U.S. CLS. 21, 23, 26, 36 AND 38).

JOHN SCHUYLER YARD, EXAMINING ATTORNEY

SN 77-413,638. DENSO WAVE INCORPORATED, TOKYO, JAPAN, FILED 3-5-2008.

SQRC

THE MARK CONSISTS OF STANDARD CHARACTERS WITHOUT CLAIM TO ANY PARTICULAR FONT, STYLE, SIZE, OR COLOR.

OWNER OF JAPAN REG. NO. 5101116, DATED 12-28-2007, EXPIRES 12-28-2017.

FOR 2-DIMENSIONAL CODE SCANNERS, NAMELY, BAR CODE SCANNERS AND 2D CODE SCANNERS; 2-DIMENSIONAL CODE HANDY TERMINALS, NAMELY, MOBILE DATA TERMINALS WITH INCORPORATED 2-DIMENSIONAL CODE SCANNERS; 2-DIMENSIONAL CODE GENERATION SOFTWARE; PRINTERS, AND LASER POINTERS (U.S. CLS. 21, 23, 26, 36 AND 38).

KATHERINE E. HALMEN, EXAMINING ATTORNEY

SN 77-414,477. BARRETT PRODUCTIONS, INC., MISSOULA, MT. FILED 3-6-2008.

FLY FISHING AMERICA

THE MARK CONSISTS OF STANDARD CHARACTERS WITHOUT CLAIM TO ANY PARTICULAR FONT, STYLE, SIZE, OR COLOR.

FOR PRE-RECORDED VIDEO TAPES AND DVDS FEATURING A SERIES OF PROGRAMS ON FLY FISHING (U.S. CLS. 21, 23, 26, 36 AND 38).

FIRST USE 12-31-1992; IN COMMERCE 12-31-1992.
ANGELA M. MICHELI, EXAMINING ATTORNEY

CLASS 9—(Continued).

SN 77-414,770. D2C GAMES, INC., SAN MATEO, CA. FILED 3-6-2008.

EASY. FUN. TOGETHER.

THE MARK CONSISTS OF STANDARD CHARACTERS WITHOUT CLAIM TO ANY PARTICULAR FONT, STYLE, SIZE, OR COLOR.

FOR INTERACTIVE ENTERTAINMENT SOFTWARE AND RELATED INSTRUCTION MANUALS SOLD TOGETHER AS A UNIT, NAMELY, VIDEO GAME SOFTWARE AND MANUALS SOLD AS A UNIT; COMPUTER GAME SOFTWARE AND MANUALS SOLD AS A UNIT; COMPUTER AND VIDEO GAME ROM CARTRIDGES, CD-ROMS, DVDS AND FLASH MEMORY CARDS FEATURING GAMES, FILMS, ANIMATIONS, MUSIC, AND MANUALS SOLD AS A UNIT; DOWNLOADABLE COMPUTER GAMES AND VIDEO GAME SOFTWARE; AND DOWNLOADABLE SOFTWARE FOR PLAYING VIDEO GAMES AND COMPUTER GAMES (U.S. CLS. 21, 23, 26, 36 AND 38).

PAULA MAHONEY, EXAMINING ATTORNEY

SN 77-414,793. D2C GAMES, INC., SAN MATEO, CA. FILED 3-6-2008.

FACEMAKER

THE MARK CONSISTS OF STANDARD CHARACTERS WITHOUT CLAIM TO ANY PARTICULAR FONT, STYLE, SIZE, OR COLOR.

FOR INTERACTIVE ENTERTAINMENT SOFTWARE AND RELATED INSTRUCTION MANUALS SOLD TOGETHER AS A UNIT, NAMELY, VIDEO GAME SOFTWARE AND MANUALS SOLD AS A UNIT; COMPUTER GAME SOFTWARE AND MANUALS SOLD AS A UNIT; COMPUTER AND VIDEO GAME ROM CARTRIDGES, CD-ROMS, DVDS AND FLASH MEMORY CARDS FEATURING GAMES, FILMS, ANIMATIONS, MUSIC, AND MANUALS SOLD AS A UNIT; DOWNLOADABLE COMPUTER GAMES AND VIDEO GAME SOFTWARE; AND DOWNLOADABLE SOFTWARE FOR PLAYING VIDEO GAMES AND COMPUTER GAMES (U.S. CLS. 21, 23, 26, 36 AND 38).

PAULA MAHONEY, EXAMINING ATTORNEY

CLASS 9—(Continued).

SN 77-414,999. INTEGRATED SOFTWARE SPECIALISTS, INC., SCHAUMBURG, IL. FILED 3-6-2008.

iJustice

THE MARK CONSISTS OF STANDARD CHARACTERS WITHOUT CLAIM TO ANY PARTICULAR FONT, STYLE, SIZE, OR COLOR.

FOR COMPUTER SOFTWARE FOR COURT CASE MANAGEMENT AND CRIMINAL JUSTICE AUTOMATION FOR LOCAL, MUNICIPAL, STATE AND FEDERAL GOVERNMENT (U.S. CLS. 21, 23, 26, 36 AND 38).
KRISTIN DAHLING, EXAMINING ATTORNEY

SN 77-415,354. EVEREADY BATTERY COMPANY, INC., ST. LOUIS, MO. FILED 3-6-2008.

ENERGIZER HARD CASE OUTDOOR

THE MARK CONSISTS OF STANDARD CHARACTERS WITHOUT CLAIM TO ANY PARTICULAR FONT, STYLE, SIZE, OR COLOR.

OWNER OF U.S. REG. NOS. 2,670,053, 3,064,346 AND OTHERS.

NO CLAIM IS MADE TO THE EXCLUSIVE RIGHT TO USE "HARD CASE OUTDOOR", APART FROM THE MARK AS SHOWN.

FOR SOLAR CELLS; SOLAR BATTERIES; BATTERY CHARGERS INCORPORATING SOLAR CELLS (U.S. CLS. 21, 23, 26, 36 AND 38).

NANCY CLARKE, EXAMINING ATTORNEY

SN 77-416,939. BLUE PILLAR, INC., ALPHARETTA, GA. FILED 3-8-2008.

AURORA

THE MARK CONSISTS OF STANDARD CHARACTERS WITHOUT CLAIM TO ANY PARTICULAR FONT, STYLE, SIZE, OR COLOR.

FOR INVENTORY MANAGEMENT TOOL, NAMELY, COMPUTER SOFTWARE THAT PROVIDES WEB BASED ACCESS TO APPLICATIONS AND SERVICES THROUGH A WEB OPERATING SYSTEM OR PORTAL INTERFACE FOR EMERGENCY POWER MANAGEMENT SYSTEMS (U.S. CLS. 21, 23, 26, 36 AND 38).

VIVIAN MICZNIK FIRST, EXAMINING ATTORNEY

CLASS 9—(Continued).

SN 77-419,862. ETS-LINDGREN, L.P., CEDAR PARK, TX. FILED 3-12-2008.



THE COLOR(S) RED IS/ARE CLAIMED AS A FEATURE OF THE MARK.

THE MARK CONSISTS OF A STYLIZED LOGO COMPRISING A SET OF CONCENTRIC ARCS DELIMITED BY THE BOUNDARIES OF A RHOMBUS. THE ARCS ARE RED.

FOR ANTENNAS FOR RADIATING OR RECEIVING ELECTROMAGNETIC FIELDS; ELECTROMAGNETIC FIELD PROBES FOR MEASURING AN ELECTROMAGNETIC FIELD; ELECTROMAGNETIC MEASUREMENT SOFTWARE THAT ENABLES A USER TO HAVE COMPUTER CONTROL OF AN ELECTROMAGNETIC MEASUREMENT CONFIGURATION; ELECTROMAGNETIC TEST CHAMBERS FOR MAKING ELECTROMAGNETIC MEASUREMENTS OF SCATTERING OBJECTS, ELECTRICAL DEVICES, OR ANTENNAS; RADIO FREQUENCY (RF) ANECHOIC RADIATION ABSORBENT MATERIAL (RAM) TO ABSORB RADIO FREQUENCY (RF) ENERGY IN AN ELECTROMAGNETIC TEST CHAMBER; POSITIONERS TO POSITION AN OBJECT, DEVICE OR ANTENNA IN AN ELECTROMAGNETIC TEST CHAMBER, NAMELY, TURNTABLES THAT ROTATE, ANTENNA SCANNING TOWERS THAT MOVE UP AND DOWN, AND MULTI-AXIS POSITIONERS; FIBER OPTIC INSTRUMENTS, NAMELY, CAMERAS; POWERLINE AND SIGNAL FILTERS FOR FILTERING POWER LINES AND SIGNAL LINES RESPECTIVELY TO PREVENT SIGNALS ORIGINATING FROM AN EXTERIOR OF AN ELECTROMAGNETIC TEST CHAMBER FROM ENTERING THE TEST CHAMBER; HELMHOLTZ COILS USED TO PRODUCE A MAGNETIC FIELD OF A CONTROLLED MAGNITUDE IN A DEFINED AREA OR TO NULLIFY THE EARTH'S MAGNETIC FIELD IN A DEFINED AREA; TRANSVERSE ELECTROMAGNETIC (TEM) DEVICES, NAMELY, ELECTRIC FIELD GENERATORS FOR GENERATING AN ELECTRIC FIELD OF HORIZONTAL AND/OR VERTICAL POLARIZATION AND TEM TEST CELLS FOR RADIATED EMISSIONS AND RADIATED IMMUNITY TESTS OF ELECTRICAL DEVICES SUCH AS CELL PHONES; LINE IMPEDANCE STABILIZATION NETWORKS TO PROVIDE IMPEDANCE MATCHING IN AN ELECTROMAGNETIC TEST CHAMBER; ACOUSTICALLY ISOLATED ENCLOSURES TO PROVIDE SOUND ISOLATION BETWEEN THE INTERIOR AND EXTERIOR OF THE ENCLOSURE; ACOUSTIC TEST CHAMBERS TO MAKE ACOUSTIC MEASUREMENTS OF OBJECTS AND ACOUSTICALLY RADIATING DEVICES (U.S. CLS. 21, 23, 26, 36 AND 38).
FIRST USE 12-31-2000; IN COMMERCE 12-31-2000.
JAMES LOVELACE, EXAMINING ATTORNEY

CLASS 9—(Continued).

SN 77-423,943. GP2 INC., BURLINGTON, ONTARIO, CANADA, FILED 3-17-2008.

The logo for GP2 Inc. features the letters "GP2" in a large, bold, sans-serif font, followed by "INC." in a smaller, all-caps, sans-serif font. The text is black on a white background.

NO CLAIM IS MADE TO THE EXCLUSIVE RIGHT TO USE "INC.", APART FROM THE MARK AS SHOWN.

THE MARK CONSISTS OF STYLIZED LETTERS AND NUMBER "GP2" AND THE LETTERS "INC."

FOR CABLES, NAMELY, COAXIAL, TWINAXIAL, AND COMPOSITE CABLES AND CONNECTORS THEREFOR FOR USE IN MUSICAL INSTRUMENTS AND MUSICAL SIGNAL INPUT/OUTPUT EQUIPMENT; ADAPTER, NAMELY, AN ADAPTER USED TO CONNECT AUDIO, VIDEO, AND ELECTRONIC DEVICES (U.S. CLS. 21, 23, 26, 36 AND 38).

MICHAEL ENGEL, EXAMINING ATTORNEY

CLASS 9—(Continued).

SN 77-423,962. GP2 INC., BURLINGTON, ONTARIO, CANADA, FILED 3-17-2008.

The logo for GP2 Inc. features the letters "GP2" in a large, bold, sans-serif font, followed by "Inc." in a smaller, all-caps, sans-serif font. The text is black on a white background.

THE MARK CONSISTS OF STANDARD CHARACTERS WITHOUT CLAIM TO ANY PARTICULAR FONT, STYLE, SIZE, OR COLOR.

NO CLAIM IS MADE TO THE EXCLUSIVE RIGHT TO USE "INC.", APART FROM THE MARK AS SHOWN.

FOR CABLES, NAMELY, COAXIAL, TWINAXIAL, AND COMPOSITE CABLES AND CONNECTORS THEREFOR FOR USE IN MUSICAL INSTRUMENTS AND MUSICAL SIGNAL INPUT/OUTPUT EQUIPMENT; ADAPTER, NAMELY, AN ADAPTER USED TO CONNECT AUDIO, VIDEO, AND ELECTRONIC DEVICES (U.S. CLS. 21, 23, 26, 36 AND 38).

MICHAEL ENGEL, EXAMINING ATTORNEY

SN 77-426,173. BSP SOFTWARE LLC, ROLLING MEADOWS, IL. FILED 3-19-2008.

The logo for BSP Software consists of the words "BSP SOFTWARE" in a bold, all-caps, sans-serif font. The text is black on a white background.

THE MARK CONSISTS OF STANDARD CHARACTERS WITHOUT CLAIM TO ANY PARTICULAR FONT, STYLE, SIZE, OR COLOR.

NO CLAIM IS MADE TO THE EXCLUSIVE RIGHT TO USE "SOFTWARE", APART FROM THE MARK AS SHOWN.

FOR BUSINESS ADMINISTRATION AND MANAGEMENT SOFTWARE IN THE FIELDS OF BUSINESS INTELLIGENCE AND ORGANIZATION PERFORMANCE MANAGEMENT (U.S. CLS. 21, 23, 26, 36 AND 38).

FIRST USE 12-26-2006; IN COMMERCE 12-26-2006.

VIVIAN MICZNIK FIRST, EXAMINING ATTORNEY

SN 77-430,536. SENTRANA INC., BETHESDA, MD. FILED 3-25-2008.

The logo for Rule Studio consists of the words "RULE STUDIO" in a bold, all-caps, sans-serif font. The text is black on a white background.

THE MARK CONSISTS OF STANDARD CHARACTERS WITHOUT CLAIM TO ANY PARTICULAR FONT, STYLE, SIZE, OR COLOR.

NO CLAIM IS MADE TO THE EXCLUSIVE RIGHT TO USE "RULE", APART FROM THE MARK AS SHOWN.

FOR COMPUTER SOFTWARE, NAMELY, A BUSINESS-FRIENDLY USER INTERFACE USED TO MANAGE, EDIT, DESIGN AND DEVELOP LOGICAL RULES THAT HAVE BEEN CODIFIED FOR CERTAIN BUSINESS PROCESSES SUCH AS PRICING PLANS, PRICING DECISIONS, PROCESS COMPLIANCE AND POLICY GUIDELINES IN LARGE-SCALE ENTERPRISES AND INSTITUTIONS (U.S. CLS. 21, 23, 26, 36 AND 38).

MARY BOAGNI, EXAMINING ATTORNEY

SN 77-423,949. KOPIN CORPORATION, TAUNTON, MA. FILED 3-17-2008.

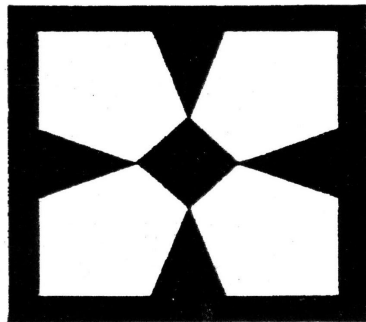

OWNER OF U.S. REG. NOS. 1,488,253 AND 1,502,629. THE MARK CONSISTS OF A SQUARE AND PENTAGONAL DESIGNS WITHIN THE SQUARE.

FOR HETEROJUNCTION BIPOLAR TRANSISTOR WAFERS; PSEUDOMORPHIC HIGH ELECTRON MOBILITY TRANSISTOR WAFERS; IMAGING AND DISPLAY PRODUCTS, NAMELY, LIQUID CRYSTAL DISPLAYS FOR USE BY ELECTRONICS MANUFACTURERS AS COMPONENTS IN CAMCORDERS, DIGITAL CAMERAS, CELLULAR TELEPHONES, GLOBAL POSITIONING SYSTEMS, MEDICAL INSTRUMENTS, SECURITY DEVICES, WEAPON SIGHTS AND VIEWING DEVICES, HEAD-MOUNTED DISPLAY DEVICES, AND VIDEO EYEWEAR (U.S. CLS. 21, 23, 26, 36 AND 38).

FIRST USE 2-15-1987; IN COMMERCE 2-15-1987.

JIM RINGLE, EXAMINING ATTORNEY

CLASS 9—(Continued).

SN 77-432,725. KONAMI GAMING, INC., LAS VEGAS, NV.
FILED 3-27-2008.

KING OF ILLUSIONS

THE MARK CONSISTS OF STANDARD CHARACTERS WITHOUT CLAIM TO ANY PARTICULAR FONT, STYLE, SIZE, OR COLOR.

OWNER OF U.S. REG. NOS. 2,958,285, 3,140,283 AND 3,143,111.

FOR ELECTRONIC GAME PROGRAMS; GAMING EQUIPMENT, NAMELY, SLOT MACHINES WITH OR WITHOUT VIDEO OUTPUT; GAMING MACHINES; MACHINES FOR PLAYING GAMES OF CHANCE; SLOT MACHINES (U.S. CLS. 21, 23, 26, 36 AND 38).

G. MAYERSCHOFF, EXAMINING ATTORNEY

SN 77-432,763. HOLLYLAND CO., LTD., HONG KONG
S.A.R., HONG KONG, FILED 3-27-2008.

eneMega

PRIORITY CLAIMED UNDER SEC. 44(D) ON HONG KONG APPLICATION NO. 300990180, FILED 1-30-2008, REG. NO. 300990180, DATED 11-9-2007, EXPIRES 11-9-2017.

THE MARK CONSISTS OF SMALL LETTERS OF "ENE" AND TOGETHER WITH "MEGA" WITH THE CAPITAL LETTER OF "M".

FOR BATTERIES, NAMELY, RECHARGEABLE BATTERIES, DRY CELLS, AND ELECTRIC CELLS, AND BATTERY CHARGERS (U.S. CLS. 21, 23, 26, 36 AND 38).

KELLY CHOE, EXAMINING ATTORNEY

CLASS 9—(Continued).

SN 77-435,726. KNOWLEDGE EQUITY, INC., PORTLAND, OR. FILED 3-31-2008.

PIXETELL

THE MARK CONSISTS OF STANDARD CHARACTERS WITHOUT CLAIM TO ANY PARTICULAR FONT, STYLE, SIZE, OR COLOR.

FOR COMPUTER SOFTWARE FOR AUDIO AND VIDEO CAPTURE AND PLAYBACK; COMPUTER PROGRAMS FOR EDITING IMAGES, SOUND AND VIDEO; COMPUTER SOFTWARE FOR ANIMATION, EDITING, CLASSIFYING, ARCHIVING, SEARCHING, VIEWING, AND RETRIEVING MULTIMEDIA AND COLLABORATIVE CONTENT; COMPUTER SOFTWARE FOR DISTRIBUTING MULTIMEDIA CONTENT; COMPUTER SOFTWARE FOR GENERATING AND MANIPULATING DIGITAL INFORMATION FOR USE IN TRAINING AND ADVERTISING APPLICATIONS; COMPUTER SOFTWARE FOR MANIPULATING DIGITAL INFORMATION FOR USE IN MEDIA APPLICATIONS; COMPUTER SOFTWARE FOR MULTIMODAL COMMUNICATION AND INTERACTION, NAMELY, COMPUTER SOFTWARE FOR INTEGRATING MEDIA FROM DIFFERENT FORMATS INTO A SINGULAR PRESENTATION MODE; AND MULTIMODAL INTERACTION SOFTWARE, NAMELY, VISUAL AND VOICE MODALITY FOR MEDIA PRESENTATIONS (U.S. CLS. 21, 23, 26, 36 AND 38).

FIRST USE 12-27-2007; IN COMMERCE 12-27-2007.

JOHN WILKE, EXAMINING ATTORNEY

SN 77-436,844. BLACK & DECKER CORPORATION, THE,
TOWSON, MD. FILED 4-1-2008.

 **BLACK & DECKER**

OWNER OF U.S. REG. NOS. 1,533,156, 2,228,814 AND OTHERS.

THE MARK CONSISTS OF A STRIPED HEXAGON AND "BLACK & DECKER".

FOR CARPENTER'S LEVELS; SENSORS, NAMELY, ELECTRONIC SONIC TAPE MEASURER AND WALL STUD FINDERS; MEASURING APPARATUS, NAMELY, BEVELS, LASER DISTANCE METERS, DIGITAL TAPE MEASURER AND POWERED TAPE MEASURER (U.S. CLS. 21, 23, 26, 36 AND 38).

FIRST USE 9-1-2003; IN COMMERCE 9-1-2003.

JAMES LOVELACE, EXAMINING ATTORNEY

CLASS 9—(Continued).

SN 77-439,792. VIA TECHNOLOGIES, INC., FREMONT, CA. FILED 4-4-2008.

VIA NANO

THE MARK CONSISTS OF STANDARD CHARACTERS WITHOUT CLAIM TO ANY PARTICULAR FONT, STYLE, SIZE, OR COLOR.

OWNER OF U.S. REG. NOS. 2,090,399, 3,173,119 AND 3,223,777.

FOR COMPUTERS, NAMELY, PERSONAL COMPUTERS, PORTABLE COMPUTERS, MICROCOMPUTERS, DESKTOP COMPUTERS, HAND HELD COMPUTERS; COMPUTER SYSTEM COMPONENTS, PARTS AND FITTINGS, NAMELY, SEMICONDUCTORS, MICROPROCESSORS, GRAPHICS PROCESSORS, SIGNAL PROCESSORS, VIDEO PROCESSORS, INTEGRATED CIRCUITS, COMPUTER CHIPS, SILICON CHIPS, COMPUTER MOTHERBOARDS, COMPUTER GRAPHICS BOARDS, COMPUTER INTERFACE BOARDS, COMPUTER EXPANSION BOARDS, MICRO CIRCUITS, CIRCUIT BOARDS, COMPUTER NETWORK ADAPTERS, COMPUTER PARALLEL PORTS, COMPUTER CHASSIS, COMPUTER MEMORY CARDS, MEMORY CHIPS, SYSTEM PLATFORMS COMPRISED OF MAINBOARD AND CENTRAL PROCESSING UNIT (CPU), CONTROLLERS, GRAPHIC CARDS, MULTIMEDIA ACCELERATOR BOARDS, COMPUTER MEMORIES, COMPUTER PRINTERS, COMPUTER CARD ADAPTERS, MODEMS, COMPUTER CURSOR CONTROL DEVICES, NAMELY, COMPUTER MOUSE, LIGHT PENS, TOUCH PADS AND TRACKBALLS; COMPUTER HARD DRIVES, ELECTRONIC COMPUTER LOCKS, COMPUTER SPEAKERS, DISC DRIVES, BLANK DATA STORAGE DISCS, COMPUTER PERIPHERALS, COMPUTER KEYBOARDS, CRT MONITORS, DVI DISPLAYS, LCD PANELS, HDTV DISPLAYS, GPS NAVIGATIONAL DISPLAYS AND AUTOMOTIVE VISUAL DISPLAYS, COMPUTER CARRYING CASES; INTERACTIVE COMPUTER KIOSKS USED IN RETAIL, ENTERTAINMENT AND HOSPITALITY ESTABLISHMENTS FOR DIRECTORY INFORMATION ASSISTANCE; ACCESSORIES AND SUBASSEMBLIES NOT INCLUDED IN OTHER CLASSES IN THE NATURE OF PARALLEL COMMUNICATION INTERFACE ADAPTER CARDS, SERIAL COMMUNICATION CARDS, SYNCHRONOUS COMMUNICATION CARDS, TELECOMMUNICATIONS HUBS AND SWITCHES, TERMINAL ADAPTERS, HUBS, ROUTERS, SERVERS, COMPUTER CABLES, ELECTRONIC CONVERTERS; COMPUTER UTILITY SOFTWARE, OPERATING SYSTEM SOFTWARE, DEVICE DRIVER SOFTWARE FOR EMBEDDED HOST AND PERIPHERAL DEVICES, COMPUTER GRAPHICAL UTILITIES PROGRAMS, FILE FORMAT CONVERSION UTILITY SOFTWARE, SOFTWARE FOR SPREAD SPECTRUM MODULATION AND DEMODULATION ERROR CORRECTION AND ENCODING AND DECODING, COMPUTER SOFTWARE TO ENABLE CONNECTION TO DATABASES AND THE INTERNET; SOFTWARE FOR STORAGE, TRANSMISSION, RECEPTION, REPRODUCTION, OPERATION, PROCESSING, GENERATION OF VIDEO, GRAPHICS, ELECTRONIC MESSAGES, VOICE MESSAGES, DATA, SENSORY SIGNALS, SOUND AND IMAGES IN THE NATURE PORTABLE COMPUTERS AND ELECTRONIC ORGANIZERS; SOFTWARE TO MANIPULATE, DISSEMINATE, SEARCH AND RETRIEVE INFORMATION; DATA SYNCHRONIZATION PROGRAMS; COMPUTER SOFTWARE FOR THE AUTO-

CLASS 9—(Continued).

MATIC CONFIGURATION OF COMPUTER NETWORKS; DIAGNOSTIC TEST SOFTWARE; SECURITY SOFTWARE FOR INFORMATION ACCESS CONTROL AND SECURE COMMUNICATIONS; COMPUTER SOFTWARE TO OPERATE THE AFORESAID HARDWARE, NAMELY, COMPUTER MOTHERBOARDS, COMPUTER MODEMS; PRINTED AND ELECTRONIC INSTRUCTIONAL MATERIALS, SPECIFICATION SHEETS, DATA SHEETS, COMPUTER REFERENCE MANUALS AND DOCUMENTS PROVIDING INSTRUCTION IN THE USE AND OPERATION OF THE AFORESAID SOLD AS A UNIT (U.S. CLS. 21, 23, 26, 36 AND 38).

LEIGH CAROLINE CASE, EXAMINING ATTORNEY

SN 77-442,414. DEUTSCHE TELEKOM, BONN, FED REP GERMANY, FILED 4-8-2008.

web'n'walk Stick

THE MARK CONSISTS OF STANDARD CHARACTERS WITHOUT CLAIM TO ANY PARTICULAR FONT, STYLE, SIZE, OR COLOR.

OWNER OF FED REP GERMANY REG. NO. 30758553, DATED 2-6-2008, EXPIRES 9-30-2017.

OWNER OF U.S. REG. NOS. 3,250,718, 3,257,839 AND OTHERS.

NO CLAIM IS MADE TO THE EXCLUSIVE RIGHT TO USE "STICK", APART FROM THE MARK AS SHOWN.

FOR MOBILE PHONES; COMPUTER APPLICATION SOFTWARE FOR MOBILE PHONES; ELECTRIC, ELECTRONIC, OPTICAL, MEASURING, SIGNALING, CONTROLLING AND TEACHING APPARATUS AND INSTRUMENTS, ALL FOR USE WITH TELECOMMUNICATIONS, NAMELY, APPARATUS FOR PRODUCING SOUND, IMAGES OR DATA, BLANK MAGNETIC AND OPTICAL DATA CARRIERS; DATA PROCESSORS AND COMPUTERS, NAMELY, MICROCOMPUTERS, MINICOMPUTERS, COMPUTER CENTRAL PROCESSORS, COMPUTER MONITORS, COMPUTER KEYBOARDS, COMPUTER TERMINALS, COMPUTER OPERATING SYSTEMS; COMPUTER PROGRAMS AND DATABASES FOR USE IN OPERATING TELECOMMUNICATIONS AND BUSINESS MANAGEMENT SYSTEMS AND RELATED INSTRUCTION MANUALS SOLD AS A UNIT; COMPUTER PROGRAMS FOR CONTROLLING COMMUNICATIONS NETWORK HARDWARE; SOFTWARE USED FOR THE PROVISION OF ONLINE INFORMATION SERVICES, NETWORK MANAGEMENT SOFTWARE, COMPUTER PROXY MANAGEMENT FOR USE WITH OTHER SOFTWARE PROGRAMS, COMPUTER PROGRAMS FOR ACCESSING A GLOBAL COMPUTER NETWORK AND INTERACTIVE COMPUTER COMMUNICATIONS NETWORK; AUDIO, VIDEO AND DATA COMMUNICATIONS SYSTEMS, NAMELY, DIGITAL AND ANALOGUE SIGNAL TRANSMITTERS, RECEIVERS AND CONVERTERS, RADIO AND TELEPHONE TRANSMITTERS, RECEIVERS AND SERVERS, STATIONARY, WIRELESS AND CELLULAR TELEPHONE SYSTEMS AND ANSWERING MACHINES, TELECOMMUNICATION TRANSMISSION, RECEIVING AND STORAGE APPARATUS, TELECOMMUNICATIONS TRANSMITTING SETS, DATA TRANSMITTERS, FACSIMILE MACHINES, ELECTRONIC MAIL APPARATUS FOR ELECTRONIC EXCHANGE OF DATA IMAGES AND MESSAGES; AUDIO AND VIDEO RECORDINGS IN THE FIELD OF TELECOMMUNICATIONS, INFORMATION TECHNOLOGY, SAFETY; MACHINE READABLE, MAGNETICALLY ENCODED CARDS, NAMELY, TELEPHONE CALLING CARDS SMART CARDS; DATA PROCESSORS AND READERS, WORD PROCESSORS, MAGNETIC CODED CARD READERS, MAGNETIC ENCODED CARDS, ELECTRONIC ENCRYPTION UNITS, BLANK DATA MAGNETIC AND OPTICAL CARRIERS AND COMPONENT PARTS THEREOF; INTERCOMS; TELEPHONES, TELEPHONE SWITCHES, TELEPHONE

CLASS 9—(Continued).

ANSWERING MACHINES, TELEPHONE TRANSMITTERS, TELEPHONE NETWORKS COMPRISED OF TELEPHONES AND TELEPHONE WIRES, TELEPRINTERS, TELETYPEWRITERS, AND PARTS THEREOF, NAMELY, CALLER IDENTIFICATION BOXES; RADIO TELEPHONE EQUIPMENT AND ACCESSORIES, NAMELY, CALL BOXES, TELEPHONES, DIALING ASSEMBLIES, TELEPHONE UNITS, AUDIO OPERATED ELECTRIC RELAYS, SIGNALING DEVICES IN THE NATURE OF SIGNAL WHISTLES AND BELLS, RADIO AND TELEPHONE RECEIVERS, TELEPHONE TERMINATION EQUIPMENT, FILTERS FOR RADIO INTERFERENCE SUPPRESSION, VOLTAGE SURGE PROTECTORS, AND ELECTRONIC APPARATUS FOR CONTROLLING ACCESS TO TELECOMMUNICATIONS NETWORKS; TELEMETERS; WIRELESS AND CELLULAR TELEPHONES, PAGERS, PAGING EQUIPMENT, PORTABLE COMPUTERS; PERSONAL COMMUNICATIONS EQUIPMENT, NAMELY, PERSONAL DIGITAL ASSISTANTS (PDAS); CALCULATORS; SATELLITE PROCESSORS, AUDIO AND VIDEO RECORDINGS IN THE FIELD OF NEWS, SPORTS, ENTERTAINMENT, CULTURE, BUSINESS AND FINANCE, WEATHER AND TRAVEL (U.S. CLS. 21, 23, 26, 36 AND 38).

PAUL F. GAST, EXAMINING ATTORNEY

SN 77-450,287. CONMARK INC., LAWRENCEVILLE, GA.
FILED 4-16-2008.

FreeEye

THE MARK CONSISTS OF STANDARD CHARACTERS WITHOUT CLAIM TO ANY PARTICULAR FONT, STYLE, SIZE, OR COLOR.

FOR AN ELECTRONIC SYSTEM COMPRISED OF COMPUTER HARDWARE AND SOFTWARE FOR MEASURING FREENESS, NAMELY, THE DRAINAGE OF PULP SUSPENSION IN THE INDUSTRIAL PRODUCTION PROCESS OF PAPER AND PULP (U.S. CLS. 21, 23, 26, 36 AND 38).

ANTHONY RINKER, EXAMINING ATTORNEY

CLASS 9—(Continued).

SN 77-451,482. HONESTMAN PRODUCTIONS, INC., POOLESVILLE, MD. FILED 4-17-2008.



OWNER OF U.S. REG. NO. 2,671,281.

THE MARK CONSISTS OF THE WORD "HONESTMAN" WITH A STYLIZED UPPER-CASE "H" SHOWING A TREBLE CLEF FORMING THE LEFT STEM OF THE "H", AND THE FINAL CURVE OF THE TREBLE CLEF FORMING THE CROSS-BAR OF THE "H", AND LOWERCASE LETTERS ON A WHITE MUSIC STAFF, WITH THE WORDS "HONESTY AND INTEGRITY IN MUSIC" IN WHITE LETTERS UNDERNEATH THE STAFF FLUSH WITH THE RIGHT SIDE OF THE STAFF.

FOR DIGITAL MEDIA, NAMELY, PRE-RECORDED VIDEO CASSETTES, DIGITAL VIDEO DISCS, DIGITAL VERSATILE DISCS, DOWNLOADABLE AUDIO AND VIDEO RECORDINGS, DVDS, AND HIGH DEFINITION DIGITAL DISKS FEATURING MUSIC PERFORMANCES (U.S. CLS. 21, 23, 26, 36 AND 38).

FIRST USE 10-3-1984; IN COMMERCE 10-3-1984.

KELLY CHOE, EXAMINING ATTORNEY

SN 77-453,748. ASM TECHNOLOGY SINGAPORE PTE LTD, SINGAPORE, SINGAPORE, FILED 4-21-2008.

DREAMPAK

THE MARK CONSISTS OF STANDARD CHARACTERS WITHOUT CLAIM TO ANY PARTICULAR FONT, STYLE, SIZE, OR COLOR.

FOR INTEGRATED CIRCUIT PACKAGES AND SEMICONDUCTOR DEVICES (U.S. CLS. 21, 23, 26, 36 AND 38).

HEATHER BIDDULPH, EXAMINING ATTORNEY

SN 77-456,645. IGT, RENO, NV. FILED 4-24-2008.

BIDDING FRENZY

THE MARK CONSISTS OF STANDARD CHARACTERS WITHOUT CLAIM TO ANY PARTICULAR FONT, STYLE, SIZE, OR COLOR.

NO CLAIM IS MADE TO THE EXCLUSIVE RIGHT TO USE "BIDDING", APART FROM THE MARK AS SHOWN.

FOR GAMING MACHINES, NAMELY, DEVICES WHICH ACCEPT A WAGER (U.S. CLS. 21, 23, 26, 36 AND 38).

WILLIAM VERHOSEK, EXAMINING ATTORNEY

CLASS 9—(Continued).

SN 77-467,768. SOUTHWIRE COMPANY, CARROLLTON, GA. FILED 5-7-2008.

SAG10

THE MARK CONSISTS OF STANDARD CHARACTERS WITHOUT CLAIM TO ANY PARTICULAR FONT, STYLE, SIZE, OR COLOR.

OWNER OF U.S. REG. NO. 2,274,196.

FOR SOFTWARE THAT PREPARES SAG AND TENSION DATA FOR AERIAL CONDUCTORS (U.S. CLS. 21, 23, 26, 36 AND 38).

FIRST USE 10-15-1986; IN COMMERCE 10-15-1986.
CYNTHIA TRIPI, EXAMINING ATTORNEY

SN 77-469,301. SEQUENCE DESIGN, INC., SANTA CLARA, CA. FILED 5-8-2008.

PowerCanvas

THE MARK CONSISTS OF STANDARD CHARACTERS WITHOUT CLAIM TO ANY PARTICULAR FONT, STYLE, SIZE, OR COLOR.

FOR SOFTWARE THAT ANALYZES AND MINIMIZES POWER IN THE DESIGN OF INTEGRATED CIRCUITS (U.S. CLS. 21, 23, 26, 36 AND 38).

KATHERINE STOIDES, EXAMINING ATTORNEY

SN 77-472,235. SAIA-BURGESS INC., VANDALLA, OH. FILED 5-12-2008.

LEDEX

THE MARK CONSISTS OF STANDARD CHARACTERS WITHOUT CLAIM TO ANY PARTICULAR FONT, STYLE, SIZE, OR COLOR.

OWNER OF U.S. REG. NO. 3,182,151.

FOR SOLENOIDS; SOLENOID ASSEMBLY WITH INTEGRATED ELECTRONICS, NAMELY, DRIVE ELECTRONICS; ELECTROMAGNETIC ACTUATORS; BRUSHLESS TORQUE ACTUATORS; SOLENOID-OPERATED SWITCHES AND VALVES (U.S. CLS. 21, 23, 26, 36 AND 38).

FIRST USE 10-1-1945; IN COMMERCE 10-1-1945.
KARANENDRA S. CHHINA, EXAMINING ATTORNEY

CLASS 9—(Continued).

SN 77-480,747. VENOM, LLC, SAN FRANCISCO, CA. FILED 5-21-2008.

DEADLOCKE

THE MARK CONSISTS OF STANDARD CHARACTERS WITHOUT CLAIM TO ANY PARTICULAR FONT, STYLE, SIZE, OR COLOR.

FOR CD TRADING CARDS; TRADING CARDS RECORDED ON COMPUTER DISCS; COMPUTER GAME JOYSTICKS; VIDEO GAME JOYSTICKS; BINOCULARS; CALCULATORS; CAMERAS, NAMELY, 35-MM CAMERAS, DIGITAL CAMERAS, DISPOSABLE CAMERAS AND VIDEO CAMERAS; CARRYING CASES FOR AUDIO CASSETTES, VIDEO CASSETTES, COMPACT DISCS, VIDEO DISCS, COMPUTER GAME SOFTWARE, COMPUTER GAME DISCS, VIDEO GAME SOFTWARE, VIDEO GAME DISCS AND VIDEO GAME CARTRIDGES; CD PLAYERS; PRE-RECORDED AUDIO CASSETTES AND COMPACT DISCS FEATURING MUSIC; COMPUTER GAME PROGRAMS; COMPUTER GAME SOFTWARE; VIDEO GAME SOFTWARE AND CARTRIDGES FOR USE WITH GAMING CONSOLES; VIDEO GAME SOFTWARE FOR USE WITH CELL PHONES; VIDEO GAME SOFTWARE AND CARTRIDGES FOR USE WITH HAND-HELD VIDEOGAME DEVICES; COMPUTER VIDEO GAME SOFTWARE; DOWNLOADABLE ON-LINE INTERACTIVE ELECTRONIC GAMES VIA THE INTERNET OR WIRELESS DEVICES; COMPUTER GAME CARTRIDGES; COMPUTER GAME CASSETTES; COMPUTER GAME DISCS; COMPUTER GAME TAPES; COMPUTER GAME PROGRAMS FOR USE IN CONNECTION WITH MULTIPLAYER INTERACTIVE GAMES PLAYED OVER THE INTERNET; COMPUTER PROGRAMS FOR TRACKING THE STATUS OF VARIOUS USERS OF ONLINE INTERACTIVE GAMING SERVICES; COMPUTER GAME PROGRAMS FOR MATCHING ONLINE GAME PLAYERS WITH OTHER PLAYERS OF SIMILAR SKILL LEVELS; COMPUTER GAME SOFTWARE; COMPUTER HARDWARE, COMPUTER PERIPHERALS; DOWNLOADABLE VIDEOGAME SOFTWARE; DOWNLOADABLE ONLINE INTERACTIVE COMPUTER GAME PROGRAMS HAVING SINGLE AND MULTIPLAYER CAPABILITY; DOWNLOADABLE RINGTONES VIA THE INTERNET AND WIRELESS DEVICES; DOWNLOADABLE MUSIC VIA THE INTERNET AND WIRELESS DEVICES; DOWNLOADABLE ELECTRONIC GAMES VIA THE INTERNET AND WIRELESS DEVICES; DVD PLAYERS; HEADPHONES; INTERACTIVE COMPUTER GAME SOFTWARE AND INSTRUCTIONAL MATERIALS PACKAGED AS A UNIT; INTERACTIVE VIDEO GAME SOFTWARE AND INSTRUCTIONAL MATERIALS PACKAGED AS A UNIT; INTERACTIVE MULTIMEDIA COMPUTER GAME PROGRAMS; INTERACTIVE VIDEO GAME SOFTWARE AND INSTRUCTIONAL MATERIALS PACKAGED AS A UNIT; KEYBOARDS; PREPAID MAGNETICALLY ENCODED TELEPHONE CALLING CARDS; PREPAID MAGNETICALLY ENCODED CARDS FOR PLAYING VIDEO GAMES, COMPUTER GAMES, AND ON-LINE INTERACTIVE GAMES; MAGNETICALLY-ENCODED CREDIT CARDS; DECORATIVE MAGNETS; MOUSE PADS; PRE-RECORDED CD-ROMS FEATURING GAMES; PRE-RECORDED COMPUTER GAME DISCS FEATURING GAMES; PRE-RECORDED VIDEO TAPES, CD-ROMS, DVDS, VIDEO DISCS, AND COMPACT DISCS FEATURING FILMS; PRE-RECORDED PHONOGRAPH RECORDS FEATURING MUSIC FOR FILMS; PRE-RECORDED VIDEO TAPES, CD-ROMS, DVDS AND COMPACT DISCS FEATURING ANIMATED CAR-

CLASS 9—(Continued).

TOONS; PRE-RECORDED VIDEO GAME CARTRIDGES; SUNGLASSES; EYEGLASS CASES; SWIMMING GOGGLES; DIVING GOGGLES; GOGGLES FOR SPORTS; PROTECTION AND SAFETY APPARATUS, NAMELY, INFLATABLE FLOATATION DEVICES AND SWIM FLOATS; TELEPHONES; VIDEO GAME CARTRIDGES; VIDEO GAME DISCS; VIDEO GAME MACHINES FOR USE WITH TELEVISION SETS; SOUND RECORDINGS FEATURING MUSIC FOR FANTASY FILMS; VIDEO RECORDINGS FEATURING FANTASY FILMS; GRADUATED RULERS, PROTRACTORS (U.S. CLS. 21, 23, 26, 36 AND 38).

ELISSA GARBER KON, EXAMINING ATTORNEY

CLASS 9—(Continued).

SN 77-492,075. MOOREHEAD COMMUNICATIONS, INC., DBA THE CELLULAR CONNCTION, MARION, IN. FILED 6-5-2008.

The Cellular Connection

SN 77-483,877. ARISTOCRAT TECHNOLOGIES AUSTRALIA PTY LTD, LANE COVE, NSW, AUSTRALIA, FILED 5-27-2008.

ORIENTAL VOYAGE

THE MARK CONSISTS OF STANDARD CHARACTERS WITHOUT CLAIM TO ANY PARTICULAR FONT, STYLE, SIZE, OR COLOR.

PRIORITY CLAIMED UNDER SEC. 44(D) ON AUSTRALIA APPLICATION NO. 1214358, FILED 12-10-2007, REG. NO. 1214358, DATED 12-10-2007, EXPIRES 12-10-2017.

FOR GAMING MACHINES, COMPUTER HARDWARE AND SOFTWARE ASSOCIATED THEREWITH (U.S. CLS. 21, 23, 26, 36 AND 38).

GRETTA YAO, EXAMINING ATTORNEY

THE MARK CONSISTS OF STANDARD CHARACTERS WITHOUT CLAIM TO ANY PARTICULAR FONT, STYLE, SIZE, OR COLOR.

NO CLAIM IS MADE TO THE EXCLUSIVE RIGHT TO USE "CELLULAR", APART FROM THE MARK AS SHOWN. FOR CELLULAR TELEPHONES; HEADSETS FOR TELEPHONES; PRE-PAID TELEPHONE CALLING CARDS, MAGNETICALLY ENCODED; SATELLITE DISHES (U.S. CLS. 21, 23, 26, 36 AND 38).

FIRST USE 11-17-1998; IN COMMERCE 11-17-1998.

KARANENDRA S. CHHINA, EXAMINING ATTORNEY

SN 77-492,565. EGIS TECHNOLOGY INC., TAIPEI 114, TAIWAN, FILED 6-6-2008.

SN 77-489,790. XM SATELLITE RADIO INC., WASHINGTON, DC. FILED 6-3-2008.

XMP3

THE MARK CONSISTS OF STANDARD CHARACTERS WITHOUT CLAIM TO ANY PARTICULAR FONT, STYLE, SIZE, OR COLOR.

OWNER OF U.S. REG. NOS. 2,547,677, 2,621,205 AND OTHERS.

FOR DIGITAL AUDIO RADIO RECEIVERS, PARTS AND ACCESSORIES, NAMELY, HEADPHONES, REMOTE CONTROLLERS, ADAPTER KITS COMPRISING AN ANTENNA, DC POWER ADAPTER AND CABLE USED FOR CONNECTING THE RECEIVER TO CAR AUDIO APPARATUS, AND ADAPTER KITS COMPRISING AN ANTENNA, AC POWER ADAPTER AND CABLE USED FOR CONNECTING THE RECEIVER TO HOME AUDIO APPARATUS (U.S. CLS. 21, 23, 26, 36 AND 38).

DARRYL SPRUILL, EXAMINING ATTORNEY

SwipeOne

THE MARK CONSISTS OF STANDARD CHARACTERS WITHOUT CLAIM TO ANY PARTICULAR FONT, STYLE, SIZE, OR COLOR.

FOR COMPUTER SOFTWARE AND FIRMWARE FOR THE ENCRYPTION; DECRYPTION; COMPRESSION; PROTECTION; RETENTION AND TRANSMISSION OF DATA; PROTECT INFORMATION STORED IN COMPUTER WITH FINGERPRINT RECOGNITION; DOWNLOADABLE ELECTRONIC PUBLICATIONS, NAMELY, MANUALS, HANDBOOKS, AND GUIDES FEATURING INFORMATION RELATING TO COMPUTER SOFTWARE AND FIRMWARE FOR THE ENCRYPTION, DECRYPTION, COMPRESSION, PROTECTION, RETENTION AND TRANSMISSION OF DATA, FILES AND INFORMATION RECORDED ON ELECTRONIC MEDIA (U.S. CLS. 21, 23, 26, 36 AND 38).

CAROLYN GRAY, EXAMINING ATTORNEY

CLASS 9—(Continued).

SN 77-494,859. HATCH INC., WINSTON SALEM, NC. FILED 6-10-2008.



NO CLAIM IS MADE TO THE EXCLUSIVE RIGHT TO USE "LEARNING SYSTEM", APART FROM THE MARK AS SHOWN.

FOR EDUCATIONAL KIT COMPRISED PRIMARILY OF CLASSROOM COMPUTER WHITEBOARD WITH INTEGRATED PROJECTOR, COMPUTER, KEYBOARD, MOUSE, SPEAKERS, COMPUTER SOFTWARE, AND TEACHING MANUALS ALL SOLD TOGETHER AS A UNIT, DESIGNED TO PROMOTE PRE-LITERACY AND MATHEMATIC CONCEPT ACQUISITION IN PRE-SCHOOL AND KINDERGARTEN CLASSROOMS (U.S. CLS. 21, 23, 26, 36 AND 38).

FIRST USE 3-28-2008; IN COMMERCE 3-28-2008.
ANGELA GAW, EXAMINING ATTORNEY

CLASS 9—(Continued).

SN 77-499,958. ALDIS, INC., OAK RIDGE, TN. FILED 6-16-2008.

SPECTRA 360

THE MARK CONSISTS OF STANDARD CHARACTERS WITHOUT CLAIM TO ANY PARTICULAR FONT, STYLE, SIZE, OR COLOR.

FOR TECHNOLOGICALLY ADVANCED TRAFFIC LIGHT APPARATUS AND COMPUTERIZED IMAGING SOFTWARE FOR ENVIRONMENTALLY CONSCIOUS MANAGEMENT OF VEHICULAR TRAFFIC FLOW, MONITORING TRAFFIC VIOLATIONS, AND MANAGEMENT OF TRAFFIC FLOW TO ALLOW RIGHT-OF-WAY TO SAFETY AND EMERGENCY VEHICLES (U.S. CLS. 21, 23, 26, 36 AND 38).

TAMARA FRAZIER, EXAMINING ATTORNEY

SN 77-495,334. INTERNATIONAL TECHNIDYNE CORPORATION, EDISON, NJ. FILED 6-10-2008.

ITC ENSEMBLE

THE MARK CONSISTS OF STANDARD CHARACTERS WITHOUT CLAIM TO ANY PARTICULAR FONT, STYLE, SIZE, OR COLOR.

OWNER OF U.S. REG. NOS. 2,899,627 AND 3,444,852.
FOR COMPUTER SOFTWARE USED FOR DATABASE MANAGEMENT IN THE FIELD OF CLINICAL ANALYSIS OF BLOOD DIAGNOSTICS FOR HUMANS OR ANIMALS; COMPUTER SOFTWARE FOR ANALYSIS AND MANAGEMENT OF HUMAN OR ANIMAL PATIENT MEDICAL INFORMATION IN THE FIELD OF CLINICAL ANALYSIS OF BLOOD DIAGNOSTICS (U.S. CLS. 21, 23, 26, 36 AND 38).

SUZANNE BLANE, EXAMINING ATTORNEY

SN 77-499,960. ALDIS, INC., OAK RIDGE, TN. FILED 6-16-2008.

GRIDSMART

THE MARK CONSISTS OF STANDARD CHARACTERS WITHOUT CLAIM TO ANY PARTICULAR FONT, STYLE, SIZE, OR COLOR.

FOR TECHNOLOGICALLY ADVANCED TRAFFIC LIGHT APPARATUS AND COMPUTERIZED IMAGING SOFTWARE FOR ENVIRONMENTALLY CONSCIOUS MANAGEMENT OF VEHICULAR TRAFFIC FLOW, MONITORING TRAFFIC VIOLATIONS, AND MANAGEMENT OF TRAFFIC FLOW TO ALLOW RIGHT-OF-WAY TO SAFETY AND EMERGENCY VEHICLES (U.S. CLS. 21, 23, 26, 36 AND 38).

FIRST USE 7-10-2008; IN COMMERCE 7-10-2008.
TAMARA FRAZIER, EXAMINING ATTORNEY

SN 77-499,952. ALDIS, INC., OAK RIDGE, TN. FILED 6-16-2008.

ULTRA 360

THE MARK CONSISTS OF STANDARD CHARACTERS WITHOUT CLAIM TO ANY PARTICULAR FONT, STYLE, SIZE, OR COLOR.

FOR TECHNOLOGICALLY ADVANCED TRAFFIC LIGHT APPARATUS AND COMPUTERIZED IMAGING SOFTWARE FOR ENVIRONMENTALLY CONSCIOUS MANAGEMENT OF VEHICULAR TRAFFIC FLOW, MONITORING TRAFFIC VIOLATIONS, AND MANAGEMENT OF TRAFFIC FLOW TO ALLOW RIGHT-OF-WAY TO SAFETY AND EMERGENCY VEHICLES (U.S. CLS. 21, 23, 26, 36 AND 38).

TAMARA FRAZIER, EXAMINING ATTORNEY

SN 77-500,767. HOOKLOGIC, INC., NEW YORK, NY. FILED 6-17-2008.

TRAVELHOOK

THE MARK CONSISTS OF STANDARD CHARACTERS WITHOUT CLAIM TO ANY PARTICULAR FONT, STYLE, SIZE, OR COLOR.

FOR COMPUTER SOFTWARE FOR USE IN DATABASE MANAGEMENT IN THE FIELD OF MARKETING (U.S. CLS. 21, 23, 26, 36 AND 38).

FIRST USE 4-1-2005; IN COMMERCE 4-1-2005.
MARK T. MULLEN, EXAMINING ATTORNEY

CLASS 9—(Continued).

SN 77-500,791. HOOKLOGIC, INC., NEW YORK, NY. FILED 6-17-2008.

HOOKLOGIC

THE MARK CONSISTS OF STANDARD CHARACTERS WITHOUT CLAIM TO ANY PARTICULAR FONT, STYLE, SIZE, OR COLOR.

FOR COMPUTER SOFTWARE FOR USE IN DATABASE MANAGEMENT IN THE FIELD OF MARKETING (U.S. CLS. 21, 23, 26, 36 AND 38).

FIRST USE 5-1-2008; IN COMMERCE 5-1-2008.
MARK T. MULLEN, EXAMINING ATTORNEY

SN 77-500,819. MIKE LOWE MUSIC, PHILADELPHIA, PA. FILED 6-17-2008.



THE COLOR(S) BLUE, BLACK, WHITE, BROWN, AND CHROME IS/ARE CLAIMED AS A FEATURE OF THE MARK.

THE COLOR BLUE APPEARS IN THE DESIGN OF THE GANESA FIGURE; THE COLOR BLACK APPEARS IN THE EYES AND THE DETAIL ON THE GANESA FIGURE, THE DESIGN OF THE GUITAR TO THE RIGHT OF THE GANESA FIGURE, THE NECK AND FRETS OF THE GUITARS, THE DETAIL ON THE DRUMSTICKS, AND THE MOUTHPIECE FOR THE MICROPHONE; THE COLOR WHITE APPEARS IN THE TUSKS AND THE EYES OF THE GANESA FIGURE AND THE DETAIL IN THE NECKS AND FRETS OF THE GUITARS; THE COLOR BROWN APPEARS IN THE DESIGN OF THE GUITARS; AND THE COLOR CHROME APPEARS IN THE DESIGN OF THE MICROPHONE.

FOR PRE-RECORDED CDS FEATURING MUSIC (U.S. CLS. 21, 23, 26, 36 AND 38).

FIRST USE 0-0-2005; IN COMMERCE 0-0-2005.
SUSAN RICHARDS, EXAMINING ATTORNEY

CLASS 9—(Continued).

SN 77-501,205. IGT, RENO, NV. FILED 6-17-2008.

BONUS BELLS

THE MARK CONSISTS OF STANDARD CHARACTERS WITHOUT CLAIM TO ANY PARTICULAR FONT, STYLE, SIZE, OR COLOR.

FOR GAMING MACHINES, NAMELY, DEVICES WHICH ACCEPT A WAGER (U.S. CLS. 21, 23, 26, 36 AND 38).

PATRICIA EVANKO, EXAMINING ATTORNEY

SN 77-502,167. SWITCH2HEALTH CORPORATION, NORTH BRUNSWICK, NJ. FILED 6-18-2008.

SWITCH2HEALTH

THE MARK CONSISTS OF STANDARD CHARACTERS WITHOUT CLAIM TO ANY PARTICULAR FONT, STYLE, SIZE, OR COLOR.

FOR WEARABLE DEVICE TO MOTIVATE INDIVIDUALS TO BEGIN, MAINTAIN, OR INCREASE THEIR LEVEL OF PHYSICAL ACTIVITY, NAMELY, MOTION SENSORS FOR MEASURING OR INDICATING PHYSICAL ACTIVITY (U.S. CLS. 21, 23, 26, 36 AND 38).

FIRST USE 4-17-2008; IN COMMERCE 4-17-2008.
ZHALEH DELANEY, EXAMINING ATTORNEY

SN 77-503,528. DISPLAYWARE LLC, SEATTLE, WA. FILED 6-19-2008.

DIGPAD

THE MARK CONSISTS OF STANDARD CHARACTERS WITHOUT CLAIM TO ANY PARTICULAR FONT, STYLE, SIZE, OR COLOR.

FOR ELECTRONIC APPARATUS, NAMELY, STAND ALONE DISPLAYS FOR CONNECTING PORTABLE MEDIA PLAYERS TO AN IN-STORE KIOSK; COMPUTER SOFTWARE FOR DELIVERING CONTENT TO PORTABLE MEDIA PLAYERS FROM AN IN-STORE KIOSK (U.S. CLS. 21, 23, 26, 36 AND 38).

FIRST USE 5-0-2008; IN COMMERCE 5-0-2008.
MARY ROSSMAN, EXAMINING ATTORNEY

CLASS 9—(Continued).

SN 77-505,625. RYAN STOUT, YORKTOWN, IN. FILED 6-23-2008.

CLASS 9—(Continued).

SN 77-507,977. MACK DAWG PRODUCTIONS, LLC, RENO, NV. FILED 6-25-2008.

Xtreme 16

MACK DAWG PRODUCTIONS

THE MARK CONSISTS OF STANDARD CHARACTERS WITHOUT CLAIM TO ANY PARTICULAR FONT, STYLE, SIZE, OR COLOR.

NO CLAIM IS MADE TO THE EXCLUSIVE RIGHT TO USE "SIXTEEN", APART FROM THE MARK AS SHOWN. FOR BATTERIES (U.S. CLS. 21, 23, 26, 36 AND 38). FIRST USE 10-0-2007; IN COMMERCE 1-15-2008. SUZANNE BLANE, EXAMINING ATTORNEY

THE MARK CONSISTS OF STANDARD CHARACTERS WITHOUT CLAIM TO ANY PARTICULAR FONT, STYLE, SIZE, OR COLOR.

OWNER OF U.S. REG. NO. 2,612,535. NO CLAIM IS MADE TO THE EXCLUSIVE RIGHT TO USE "PRODUCTIONS", APART FROM THE MARK AS SHOWN.

FOR DOWNLOADABLE MOTION PICTURES AND TELEVISION SHOWS ABOUT SNOWBOARDING (U.S. CLS. 21, 23, 26, 36 AND 38). REGINA DRUMMOND, EXAMINING ATTORNEY

SN 77-506,901. DATABASE SYSTEMS CORP, PHOENIX, AZ. FILED 6-24-2008.

Call Reassurance

POWER MONKEY

THE MARK CONSISTS OF STANDARD CHARACTERS WITHOUT CLAIM TO ANY PARTICULAR FONT, STYLE, SIZE, OR COLOR.

NO CLAIM IS MADE TO THE EXCLUSIVE RIGHT TO USE CALL, APART FROM THE MARK AS SHOWN. FOR COMPUTER TELEPHONY SOFTWARE (U.S. CLS. 21, 23, 26, 36 AND 38). FIRST USE 3-1-2005; IN COMMERCE 3-1-2005. TRACY CROSS, EXAMINING ATTORNEY

SN 77-509,402. POWERTRAVELLER LIMITED, ALTON HAMPSHIRE, ENGLAND, FILED 6-26-2008.

SN 77-507,946. TRIPP & ASSOCIATES, INC., PLYMOUTH, MN. FILED 6-25-2008.

LIGHT IT UP

THE MARK CONSISTS OF STANDARD CHARACTERS WITHOUT CLAIM TO ANY PARTICULAR FONT, STYLE, SIZE, OR COLOR.

FOR VIDEO AND COMPUTER GAME CONTROLLERS; MUSICAL INSTRUMENT SHAPED INTERFACES FOR VIDEO GAMES AND COMPUTERS (U.S. CLS. 21, 23, 26, 36 AND 38). CHRISTINE BLOMQUIST, EXAMINING ATTORNEY

THE MARK CONSISTS OF STANDARD CHARACTERS WITHOUT CLAIM TO ANY PARTICULAR FONT, STYLE, SIZE, OR COLOR.

NO CLAIM IS MADE TO THE EXCLUSIVE RIGHT TO USE "POWER", APART FROM THE MARK AS SHOWN.

FOR APPARATUSES FOR RECORDING, TRANSMITTING OR REPRODUCING SOUNDS OR IMAGES; BLANK MAGNETIC DATA CARRIERS; MODEMS; TELEPHONE CONNECTIONS, NAMELY, PLUGS AND SOCKETS; TELEPHONE APPARATUSES; LAP TOP COMPUTERS; BATTERIES; BATTERY CHARGERS; ELECTRIC CABLES; COMPUTERS AND COMPUTER PERIPHERAL DEVICES; ENCODERS; PORTABLE TELEPHONES; TRANSMITTERS OF ELECTRONIC SIGNALS; TELECOMMUNICATION TRANSMITTERS; ELECTRIC TERMINALS, NAMELY, TELEPHONE TERMINALS (U.S. CLS. 21, 23, 26, 36 AND 38). ANGELA GAW, EXAMINING ATTORNEY

CLASS 9—(Continued).

SN 77-509,408. POWERTRAVELLER LIMITED, ALTON HAMPSHIRE, ENGLAND, FILED 6-26-2008.

CLASS 9—(Continued).

SN 77-511,125. ARISTOCRAT TECHNOLOGIES AUSTRALIA PTY LTD, LANE COVE, NSW, AUSTRALIA, FILED 6-30-2008.

POWER CHIMP

THE MARK CONSISTS OF STANDARD CHARACTERS WITHOUT CLAIM TO ANY PARTICULAR FONT, STYLE, SIZE, OR COLOR.

NO CLAIM IS MADE TO THE EXCLUSIVE RIGHT TO USE "POWER", APART FROM THE MARK AS SHOWN.

FOR APPARATUSES FOR RECORDING, TRANSMITTING OR REPRODUCING SOUNDS OR IMAGES; BLANK MAGNETIC DATA CARRIERS; MODEMS; TELEPHONE CONNECTIONS, NAMELY, PLUGS AND SOCKETS; TELEPHONE APPARATUSES; LAP TOP COMPUTERS; BATTERIES; BATTERY CHARGERS; ELECTRIC CABLES; COMPUTERS AND COMPUTER PERIPHERAL DEVICES; ENCODERS; PORTABLE TELEPHONES; TRANSMITTERS OF ELECTRONIC SIGNALS; TELECOMMUNICATION TRANSMITTERS; ELECTRIC TERMINALS, NAMELY, TELEPHONE TERMINALS (U.S. CLS. 21, 23, 26, 36 AND 38).

ANGELA GAW, EXAMINING ATTORNEY

HAPPY 88

THE MARK CONSISTS OF STANDARD CHARACTERS WITHOUT CLAIM TO ANY PARTICULAR FONT, STYLE, SIZE, OR COLOR.

PRIORITY CLAIMED UNDER SEC. 44(D) ON AUSTRALIA APPLICATION NO. 1218690, FILED 1-10-2008, REG. NO. 1218690, DATED 1-10-2008, EXPIRES 1-10-2018.

FOR GAMING MACHINES (U.S. CLS. 21, 23, 26, 36 AND 38).

SHAUNIA CARLYLE, EXAMINING ATTORNEY

SN 77-510,684. ANTEC, INC., FREMONT, CA. FILED 6-28-2008.

SN 77-511,129. ARISTOCRAT TECHNOLOGIES AUSTRALIA PTY LTD, LANE COVE, NSW, AUSTRALIA, FILED 6-30-2008.

**FORTUNE OF ATHENA**

THE MARK CONSISTS OF STYLIZED LETTERS "SKELETON", WHEREIN THE LETTER "S" CONSISTS OF BONE-LIKE SECTIONS JOINED TOGETHER BY JOINTS REPRESENTED BY CIRCLES.

FOR COMPUTER PRODUCTS AND ACCESSORIES, NAMELY, CARRYING CASES FOR COMPUTERS AND CASES FOR COMPUTER ACCESSORIES, NAMELY, DVD-ROMS, CD-ROMS, CD BURNERS, DVD BURNERS, HARD DISK DRIVES, FLOPPY DISK DRIVES, ENCLOSURES FOR COMPUTERS, POWER SUPPLIES, INTERNAL AND EXTERNAL COOLING FANS, SMART MEDIA CARD READERS AND WRITERS, IC MEMORY CARD READERS AND WRITERS, SCANNERS, MOTHER BOARDS, COMPUTER MONITORS, VIDEO MONITORS (U.S. CLS. 21, 23, 26, 36 AND 38).

SETH A. RAPPAPORT, EXAMINING ATTORNEY

THE MARK CONSISTS OF STANDARD CHARACTERS WITHOUT CLAIM TO ANY PARTICULAR FONT, STYLE, SIZE, OR COLOR.

PRIORITY CLAIMED UNDER SEC. 44(D) ON AUSTRALIA APPLICATION NO. 1218691, FILED 1-10-2008.

OWNER OF AUSTRALIA REG. NO. 1218691, DATED 1-10-2008, EXPIRES 1-10-2018.

FOR GAMING MACHINES (U.S. CLS. 21, 23, 26, 36 AND 38).

SHAUNIA CARLYLE, EXAMINING ATTORNEY

CLASS 9—(Continued).

SN 77-511,638. ADVENT SOLAR, INC., ALBUQUERQUE, NM. FILED 6-30-2008.

ADVENT

THE MARK CONSISTS OF STANDARD CHARACTERS WITHOUT CLAIM TO ANY PARTICULAR FONT, STYLE, SIZE, OR COLOR.

OWNER OF U.S. REG. NO. 3,199,627.

FOR DEVICES FOR CONVERTING SOLAR RADIATION TO ELECTRICAL ENERGY, NAMELY, SOLAR CELLS, SOLAR MODULES, SOLAR CELL CONNECTORS, SOLAR CELL INTERCONNECTS, SOLAR CELL MOUNTING BRACKETS, SOLAR CELL INVERTERS, SOLAR CELL PANELS, SOLAR CELL MODULES, SOLAR CELL SYSTEMS COMPRISING SOLAR CELLS, SOLAR MODULES, SOLAR CELL CONNECTORS, SOLAR CELL INTERCONNECTS, SOLAR CELL MOUNTING BRACKETS, AND SOLAR CELL INVERTERS, PHOTOVOLTAIC CELLS, PHOTOVOLTAIC MODULES, PHOTOVOLTAIC CELL CONNECTORS, PHOTOVOLTAIC CELL INTERCONNECTS, PHOTOVOLTAIC CELL MOUNTING BRACKETS, PHOTOVOLTAIC INVERTORS, PHOTOVOLTAIC PANELS, PHOTOVOLTAIC MODULES, AND PHOTOVOLTAIC SYSTEMS COMPRISING PHOTOVOLTAIC CELLS, PHOTOVOLTAIC MODULES, PHOTOVOLTAIC CELL CONNECTORS, PHOTOVOLTAIC CELL INTERCONNECTS, PHOTOVOLTAIC CELL MOUNTING BRACKETS, AND PHOTOVOLTAIC INVERTORS (U.S. CLS. 21, 23, 26, 36 AND 38).

FIRST USE 12-1-2005; IN COMMERCE 12-1-2005.
TRACY CROSS, EXAMINING ATTORNEY

CLASS 9—(Continued).

SN 77-516,935. NEWPORT CORPORATION, IRVINE, CA. FILED 7-8-2008.

HYBRYX

THE MARK CONSISTS OF STANDARD CHARACTERS WITHOUT CLAIM TO ANY PARTICULAR FONT, STYLE, SIZE, OR COLOR.

FOR ELECTRONIC INSTRUMENTS FOR USE IN REMOTE INSPECTION, MEASUREMENT AND PROCESSING OF INDUSTRIAL COMPONENTS USING REMOTE VISUAL DEVICES, NAMELY, AIR BEARING STAGES, NAMELY, MOTION CONTROL AND POSITIONING DEVICES FOR USE IN AUTOMATED INSPECTION OF SEMICONDUCTORS AND OTHER PRODUCTS WITH HIGH-RESOLUTION MICROSTRUCTURES, SUCH AS FLAT PANEL DISPLAYS, SEMICONDUCTOR WAFERS AND PHOTOVOLTAIC PANELS (U.S. CLS. 21, 23, 26, 36 AND 38).

JASON TURNER, EXAMINING ATTORNEY

SN 77-518,567. NEWPORT CORPORATION, IRVINE, CA. FILED 7-10-2008.

SOLARYX

SN 77-511,803. COMPUTRAC, L.L.C., BALL GROUND, GA. FILED 6-30-2008.

COMPU-CART

THE MARK CONSISTS OF STANDARD CHARACTERS WITHOUT CLAIM TO ANY PARTICULAR FONT, STYLE, SIZE, OR COLOR.

FOR MOBILE PRESENTATION UNIT CONSISTING OF A VISUAL PROJECTOR AND AUDIO SYSTEM MOUNTED ON A CART SMALL ENOUGH TO BE ROLLED FROM ONE CLASSROOM TO ANOTHER (U.S. CLS. 21, 23, 26, 36 AND 38).

FIRST USE 4-25-2005; IN COMMERCE 4-25-2005.
MARGARET POWER, EXAMINING ATTORNEY

THE MARK CONSISTS OF STANDARD CHARACTERS WITHOUT CLAIM TO ANY PARTICULAR FONT, STYLE, SIZE, OR COLOR.

FOR LASER EQUIPMENT, NAMELY, THIN FILM PHOTOVOLTAIC SCRIBE TOOLS CONSISTING OF SCRIBE STATIONS WITH INTEGRAL STAGES, MOTION CONTROL AND POSITIONING DEVICES AND TOOLS FOR LASER SCRIBING AND EDGE DELETION OF SEMICONDUCTOR PHOTOVOLTAIC THIN FILM THAT HAS BEEN DEPOSITED ONTO A GLASS SHEET, FOR USE IN THIN FILM PHOTOVOLTAIC RESEARCH, PROCESS DEVELOPMENT AND PRODUCTION (U.S. CLS. 21, 23, 26, 36 AND 38).

JASON TURNER, EXAMINING ATTORNEY

CLASS 9—(Continued).

SN 77-520,376. TDK KABUSHIKI KAISHA, DBA TDK CORPORATION, TOKYO, JAPAN, FILED 7-11-2008.

TDK-Lambda

OWNER OF U.S. REG. NOS. 1,805,891, 2,999,590 AND OTHERS.

THE MARK CONSISTS OF THE WORDING "TDK-LAMBDA" IN STYLIZED FORM.

FOR POWER SUPPLIES, SWITCHING POWER SUPPLIES AND UNINTERRUPTIBLE POWER SUPPLIES, AND PARTS AND FITTINGS THEREFOR, NAMELY, ELECTRICAL PLUGS; DC-DC CONVERTERS AND DC-AC INVERTERS AND PARTS AND FITTINGS THEREFOR, NAMELY, ELECTRICAL PLUGS; ELECTRICAL NOISE FILTERS AND PARTS AND FITTINGS THEREFOR, NAMELY, ADAPTER PLUGS; ELECTRICAL POWER CONTROLLERS; ELECTRICAL POWER DISTRIBUTION BLOCKS; ROTARY CONVERTERS; PHASE MODIFIERS (U.S. CLS. 21, 23, 26, 36 AND 38).

ELIZABETH KAJUBI, EXAMINING ATTORNEY

SN 77-523,510. PURE ENERGY VISIONS INC., RICHMOND HILL, CANADA, FILED 7-16-2008.

PURE ENERGY

PRIORITY CLAIMED UNDER SEC. 44(D) ON CANADA APPLICATION NO. 1379434, FILED 1-16-2008.

OWNER OF U.S. REG. NOS. 1,914,097 AND 3,422,802.

NO CLAIM IS MADE TO THE EXCLUSIVE RIGHT TO USE "ENERGY", APART FROM THE MARK AS SHOWN.

FOR BATTERIES AND BATTERY CHARGERS (U.S. CLS. 21, 23, 26, 36 AND 38).

FIRST USE 1-0-2008; IN COMMERCE 1-0-2008.

YAT SYE, LEE, EXAMINING ATTORNEY

SN 77-524,349. ETECH GROUP INTERNATIONAL LIMITED, MELBOURNE, AUSTRALIA, FILED 7-17-2008.

DYNAMIC LEARNSPACE

THE MARK CONSISTS OF STANDARD CHARACTERS WITHOUT CLAIM TO ANY PARTICULAR FONT, STYLE, SIZE, OR COLOR.

FOR COMPUTER SOFTWARE FOR THE MANAGEMENT OF ELECTRONIC COURSE MATERIALS AND ELECTRONIC COMMUNICATIONS BETWEEN STUDENTS, TEACHERS AND PARENTS IN SCHOOLS, TERTIARY EDUCATION PROGRAMS AND COMMERCIAL BUSINESS APPLICATIONS (U.S. CLS. 21, 23, 26, 36 AND 38).

LINDA LAVACHE, EXAMINING ATTORNEY

CLASS 9—(Continued).

SN 77-525,347. LANDCADD, INC., DBA CADVISOR, FRANKTOWN, CO. FILED 7-17-2008.



The logo for WebStores Ltd.com features a green arrow pointing up and to the right, followed by the text "WebStores Ltd.com" in a green, sans-serif font.

NO CLAIM IS MADE TO THE EXCLUSIVE RIGHT TO USE "WEBSTORESLTD.COM", APART FROM THE MARK AS SHOWN.

THE COLOR(S) GREEN AND BLACK IS/ARE CLAIMED AS A FEATURE OF THE MARK.

THE MARK CONSISTS OF A REVERSED OUT ARROW IN GREEN AND BLACK FOLLOWED BY THE WORD "WEBSTORESLTD.COM" WHERE THE FIRST "E" IN "WEBSTORES" IS A STYLIZED E IN REVERSED GREEN AND THE INITIALS "LTD" ARE IN GREEN SCRIPT AND THE LETTERS "W BSTORES .COM" ARE WRITTEN IN BLACK.

FOR COMPUTER E-COMMERCE SOFTWARE TO ALLOW USERS TO PERFORM ELECTRONIC BUSINESS TRANSACTIONS VIA A GLOBAL COMPUTER NETWORK (U.S. CLS. 21, 23, 26, 36 AND 38).

FIRST USE 6-8-2008; IN COMMERCE 6-8-2008.

SHAUNIA CARLYLE, EXAMINING ATTORNEY

SN 77-525,349. GENVAULT CORPORATION, CARLSBAD, CA. FILED 7-17-2008.

GENTEGRA

THE MARK CONSISTS OF STANDARD CHARACTERS WITHOUT CLAIM TO ANY PARTICULAR FONT, STYLE, SIZE, OR COLOR.

FOR DRY STATE ROOM TEMPERATURE STORAGE AND TRANSPORT EQUIPMENT FOR SCIENTIFIC AND LABORATORY USE, NAMELY, TUBES AND PLATES FOR STORAGE AND TRANSPORT OF NUCLEIC ACIDS AND PROTEIN-CONTAINING BIOSAMPLES (U.S. CLS. 21, 23, 26, 36 AND 38).

KELLY CHOE, EXAMINING ATTORNEY

CLASS 9—(Continued).

SN 77-527,037. DOV, SHARON, RAMAT GAN, ISRAEL, FILED 7-21-2008.

Contact Mind

THE MARK CONSISTS OF STANDARD CHARACTERS WITHOUT CLAIM TO ANY PARTICULAR FONT, STYLE, SIZE, OR COLOR.

NO CLAIM IS MADE TO THE EXCLUSIVE RIGHT TO USE "CONTACT", APART FROM THE MARK AS SHOWN.

FOR COMPUTER SOFTWARE AND HARDWARE FOR BUSINESS MANAGEMENT, FOR INFORMATION MANAGEMENT, FOR CUSTOMER RELATIONSHIP MANAGEMENT, FOR TASK MANAGEMENT (U.S. CLS. 21, 23, 26, 36 AND 38).

REBECCA GILBERT, EXAMINING ATTORNEY

SN 77-529,934. CHERISHED VOICES, LLC, CARLSBAD, CA. FILED 7-23-2008.



NO CLAIM IS MADE TO THE EXCLUSIVE RIGHT TO USE "VOICES", APART FROM THE MARK AS SHOWN.

THE COLOR(S) LIGHT BLUE, BROWN, AND PINK IS/ ARE CLAIMED AS A FEATURE OF THE MARK.

THE COLORS LIGHT BLUE, BROWN, AND PINK ARE CLAIMED AS A FEATURE OF THE MARK. THE COLOR LIGHT BLUE APPEARS IN THE WORDING "CHERISHED" AND IN THE BLANKET, CD, AND BOOK DESIGN ELEMENTS. THE COLOR BROWN APPEARS IN THE WORDING "VOICES" AND IN THE CHILD AND BOOK DESIGN ELEMENTS. THE COLOR PINK APPEARS IN THE CHILD DESIGN ELEMENT ON THE CHILD'S CHEEKS. THE COLOR WHITE IS NOT CLAIMED AS A FEATURE OF THE MARK AND CONSTITUTES BACKGROUND.

FOR PRERECORDED PERSONALIZED CHILDREN'S AUDIO BOOKS FEATURING CHILDREN'S STORIES RECORDED ON CD (U.S. CLS. 21, 23, 26, 36 AND 38).

FIRST USE 5-9-2008; IN COMMERCE 6-15-2008.

JENNIFER HETU, EXAMINING ATTORNEY

SN 77-532,077. CYBEREDA CORP., SAN JOSE, CA. FILED 7-26-2008.

PCSIM

THE MARK CONSISTS OF STANDARD CHARACTERS WITHOUT CLAIM TO ANY PARTICULAR FONT, STYLE, SIZE, OR COLOR.

FOR ELECTRONIC DESIGN AUTOMATION SOFTWARE FOR USE IN SEMICONDUCTOR INTEGRATED CIRCUIT DESIGN (U.S. CLS. 21, 23, 26, 36 AND 38).

STEVEN PEREZ, EXAMINING ATTORNEY

CLASS 9—(Continued).

SN 77-533,809. PICIS, INC., WAKEFIELD, MA. FILED 7-29-2008.

INSIGHT ANESTHESIA

THE MARK CONSISTS OF STANDARD CHARACTERS WITHOUT CLAIM TO ANY PARTICULAR FONT, STYLE, SIZE, OR COLOR.

NO CLAIM IS MADE TO THE EXCLUSIVE RIGHT TO USE "ANESTHESIA", APART FROM THE MARK AS SHOWN.

FOR COMPUTER SOFTWARE FOR TRACKING AND REPORTING INFORMATION RELATED TO PATIENT CARE, HOSPITAL ADMINISTRATION, HOSPITAL OPERATION, HOSPITAL DEPARTMENT MANAGEMENT, AND PATIENT BILLING (U.S. CLS. 21, 23, 26, 36 AND 38).

AMOS T. MATTHEWS, JR., EXAMINING ATTORNEY

SN 77-533,837. PICIS, INC., WAKFIELD, MA. FILED 7-29-2008.

INSIGHT CRITICAL CARE

THE MARK CONSISTS OF STANDARD CHARACTERS WITHOUT CLAIM TO ANY PARTICULAR FONT, STYLE, SIZE, OR COLOR.

NO CLAIM IS MADE TO THE EXCLUSIVE RIGHT TO USE "CRITICAL CARE", APART FROM THE MARK AS SHOWN.

FOR COMPUTER SOFTWARE FOR TRACKING AND REPORTING INFORMATION RELATED TO PATIENT CARE, HOSPITAL ADMINISTRATION, HOSPITAL OPERATION, HOSPITAL DEPARTMENT MANAGEMENT, AND PATIENT BILLING (U.S. CLS. 21, 23, 26, 36 AND 38).

AMOS T. MATTHEWS, JR., EXAMINING ATTORNEY

SN 77-534,142. TAQUA, LLC, RICHARDSON, TX. FILED 7-29-2008.

TAQUA MOBILEWORKS

THE MARK CONSISTS OF STANDARD CHARACTERS WITHOUT CLAIM TO ANY PARTICULAR FONT, STYLE, SIZE, OR COLOR.

OWNER OF U.S. REG. NOS. 2,463,564 AND 3,440,290.

THE ENGLISH TRANSLATION OF TAQUA IN THE MARK IS "EMERGING WITH GREAT FORCE."

FOR MOBILE SWITCHING APPLICATIONS HARDWARE AND SOFTWARE WITH INTEGRATED ENHANCED VOICE APPLICATIONS (U.S. CLS. 21, 23, 26, 36 AND 38).

CHRISTINA SOBRAL, EXAMINING ATTORNEY

CLASS 9—(Continued).

SN 77-534,190. FIRECOM, A DIVISION OF SONETICS CORPORATION, PORTLAND, OR. FILED 7-29-2008.



NO CLAIM IS MADE TO THE EXCLUSIVE RIGHT TO USE "INTEGRATED COMMUNICATION SYSTEMS", APART FROM THE MARK AS SHOWN.

THE MARK CONSISTS OF THE WORD "FIRECOM" WITH A FLAME DIVIDING "FIRE" AND COM WITH THE WORDS "INTEGRATED COMMUNICATION SYSTEMS" UNDER THE WORD "FIRECOM". THE PRECEDING WORDS ARE ENCLOSED IN AN ELLIPSE.

FOR COMMUNICATIONS HEADSETS FOR USE WITH COMMUNICATION RADIOS, INTERCOM SYSTEMS, OR OTHER COMMUNICATIONS NETWORK TRANSCIVERS; INTERCOMS (U.S. CLS. 21, 23, 26, 36 AND 38).

FIRST USE 4-1-2006; IN COMMERCE 4-1-2006.
SUNG IN, EXAMINING ATTORNEY

SN 77-540,208. MICROFLUIDICS CORPORATION, NEWTON, MA. FILED 8-6-2008.

INNOVATE WITH US

THE MARK CONSISTS OF STANDARD CHARACTERS WITHOUT CLAIM TO ANY PARTICULAR FONT, STYLE, SIZE, OR COLOR.

FOR EQUIPMENT FOR TEMPERATURE PRESSURE AND FLOW MONITORING ANALYSIS AND PROCESSING OF FLUIDS, NAMELY, DEAGGLOMERATION AND DISPERSION OF UNIFORM SUBMICRON PARTICLES AND CREATION OF STABLE EMULSIONS AND DISPERSIONS (U.S. CLS. 21, 23, 26, 36 AND 38).

MARTHA SANTOMARTINO, EXAMINING ATTORNEY

SN 77-540,310. PROXTALKER.COM LLC, WOODBURY, CT. FILED 8-6-2008.

LOGAN

THE MARK CONSISTS OF STANDARD CHARACTERS WITHOUT CLAIM TO ANY PARTICULAR FONT, STYLE, SIZE, OR COLOR.

FOR ELECTRONIC COMMUNICATION AIDS, FOR SPEECH-CHALLENGED OR OTHERWISE SIMILARLY CHALLENGED PERSONS, BY IDENTIFICATION AND SEQUENTIAL SELECTION OF GRAPHIC SYMBOLS EACH COOPERATING WITH A CORRESPONDING ACTUATOR TO PRODUCE A SERIES OF AUDIO SIGNALS CORRESPONDING TO THE PERSON'S SELECTION OF SYMBOLS (U.S. CLS. 21, 23, 26, 36 AND 38).

FIRST USE 7-25-2005; IN COMMERCE 7-25-2007.
LINDA MICKLEBURGH, EXAMINING ATTORNEY

CLASS 9—(Continued).

SN 77-541,430. CASE MASTER, INC., PORT ORANGE, FL. FILED 8-7-2008.

Case Master Pro

THE MARK CONSISTS OF STANDARD CHARACTERS WITHOUT CLAIM TO ANY PARTICULAR FONT, STYLE, SIZE, OR COLOR.

NO CLAIM IS MADE TO THE EXCLUSIVE RIGHT TO USE "CASE AND PRO", APART FROM THE MARK AS SHOWN.

FOR COMPUTER SOFTWARE FOR DEBIT COLLECTION AND LAW FIRM CASE MANAGEMENT AND ACCOUNTING (U.S. CLS. 21, 23, 26, 36 AND 38).

FIRST USE 8-23-2005; IN COMMERCE 8-23-2005.
TRACY FLETCHER, EXAMINING ATTORNEY

SN 77-542,354. BTU INTERNATIONAL, INC., NORTH BILLERICA, MA. FILED 8-8-2008.



THE MARK CONSISTS OF THE WORD "MERIDIAN" AND THE "A" IS IN THE SHAPE OF A PYRAMID.

FOR THERMAL PROCESSING APPARATUS FOR PROCESSING SOLAR CELLS AND SEMICONDUCTOR WAFERS (U.S. CLS. 21, 23, 26, 36 AND 38).

RENEE SERVANCE, EXAMINING ATTORNEY

SN 77-543,523. ESRMCO INC., WILMINGTON, DE. FILED 8-11-2008.



NO CLAIM IS MADE TO THE EXCLUSIVE RIGHT TO USE "BATTERY", APART FROM THE MARK AS SHOWN.

THE COLOR(S) BLACK IS NOT A FEATURE OF THE MARK AND MERELY INDICATES A TRANSPARENT BACKGROUND. THE COLORS RED AND WHITE IS/ARE CLAIMED AS A FEATURE OF THE MARK.

THE MARK CONSISTS OF THE WORDING "GENERAL BATTERY" IN WHITE ITALICS WITH TWO CONCENTRIC RED STARS UNDER "GENERAL" AND A RED SWIRL ENCIrcLING AND PARTIALLY INTERSECTING "BATTERY". THE BLACK RECTANGLE IS NOT A FEATURE OF THE MARK AND MERELY INDICATES A TRANSPARENT BACKGROUND.

FOR ELECTRICAL STORAGE BATTERIES (U.S. CLS. 21, 23, 26, 36 AND 38).

FIRST USE 12-1-1989; IN COMMERCE 12-1-1989.
MICHELE SWAIN, EXAMINING ATTORNEY

CLASS 9—(Continued).

SN 77-545,922. PRIME FACTORS, INC., EUGENE, OR. FILED 8-13-2008.

Prime Factors

THE MARK CONSISTS OF STANDARD CHARACTERS WITHOUT CLAIM TO ANY PARTICULAR FONT, STYLE, SIZE, OR COLOR.

SEC. 2(F).
FOR COMPUTER PROGRAMS FOR THE SECURE TRANSMISSION AND ENCRYPTION OF ELECTRONIC DATA; COMPUTER PROGRAMS FOR THE CALCULATION AND ENCRYPTION OF DATA STORED ON BANK CARDS; COMPUTER SOFTWARE COMPONENTS FOR USE IN THE ENCRYPTION OF ELECTRONIC DATA (U.S. CLS. 21, 23, 26, 36 AND 38).

FIRST USE 6-0-1982; IN COMMERCE 6-0-1982.
NICHOLAS COLEMAN, EXAMINING ATTORNEY

SN 77-546,756. SHI INTERNATIONAL CORP., PISCATAWAY, NJ. FILED 8-14-2008.



THE MARK CONSISTS OF THE LITERAL ELEMENT "SHI" APPEARING INSIDE OF A DIAGONAL OVAL DESIGN.

FOR COMPUTER SOFTWARE THAT PROVIDES WEB-BASED ACCESS TO APPLICATIONS AND SERVICES THROUGH A WEB OPERATING SYSTEM OR PORTAL INTERFACE; COMPUTER E-COMMERCE SOFTWARE TO ALLOW USERS TO PERFORM ELECTRONIC BUSINESS TRANSACTIONS VIA A GLOBAL COMPUTER NETWORK (U.S. CLS. 21, 23, 26, 36 AND 38).

FIRST USE 12-31-2000; IN COMMERCE 12-31-2000.
KATHERINE E. HALMEN, EXAMINING ATTORNEY

SN 77-547,036. SHAMIR INSIGHT, INC., SAN DIEGO, CA. FILED 8-14-2008.

SHAMIR ELEMENT

THE MARK CONSISTS OF STANDARD CHARACTERS WITHOUT CLAIM TO ANY PARTICULAR FONT, STYLE, SIZE, OR COLOR.

FOR EYEGLASS LENSES (U.S. CLS. 21, 23, 26, 36 AND 38).

SUE LAWRENCE, EXAMINING ATTORNEY

CLASS 9—(Continued).

SN 77-551,106. UBISOFT ENTERTAINMENT, RENNES, FRANCE, FILED 8-20-2008.



NO CLAIM IS MADE TO THE EXCLUSIVE RIGHT TO USE "FITNESS COACH", APART FROM THE MARK AS SHOWN.

THE COLOR(S) WHITE, GREEN, GRAY IS/ARE CLAIMED AS A FEATURE OF THE MARK.

THE MARK CONSISTS OF THE WORDS "MY FITNESS COACH" WRITTEN WITH WHITE, GREY AND GREEN.

FOR GAME SOFTWARE AND ELECTRONIC GAME PROGRAMS, NAMELY, SOFTWARE GAMES RECORDED ON CD-ROM AND DIGITAL VIDEO DISCS FOR COMPUTERS; SOFTWARE GAMES RECORDED ON CD-ROMS, DIGITAL VIDEO DISCS, AND CARTRIDGES FOR CONSOLE AND INDIVIDUAL, PORTABLE GAMING SYSTEMS; SOFTWARE GAMES THAT ARE DOWNLOADABLE FROM A REMOTE COMPUTER SITE AND ELECTRONIC GAME SOFTWARE FOR MOBILE PHONES, PERSONAL DIGITAL ASSISTANTS, AND HANDHELD COMPUTERS (U.S. CLS. 21, 23, 26, 36 AND 38).

KIMBERLY PERRY, EXAMINING ATTORNEY

SN 77-551,453. INTEGRISYS GROUP, LLC, CHICAGO, IL. FILED 8-20-2008.

LIVSYSTEM

THE MARK CONSISTS OF STANDARD CHARACTERS WITHOUT CLAIM TO ANY PARTICULAR FONT, STYLE, SIZE, OR COLOR.

FOR COMPUTER SOFTWARE APPLICATION FOR MAKING CHANGES AND CUSTOMIZING HOME AUTOMATION SOFTWARE TO THE SPECIFIC NEEDS OF THE USER (U.S. CLS. 21, 23, 26, 36 AND 38).

MARY MUNSON, EXAMINING ATTORNEY

SN 77-551,476. INTEGRISYS GROUP, LLC, CHICAGO, IL. FILED 8-20-2008.

LIVCONFIGURATOR

THE MARK CONSISTS OF STANDARD CHARACTERS WITHOUT CLAIM TO ANY PARTICULAR FONT, STYLE, SIZE, OR COLOR.

FOR COMPUTER SOFTWARE APPLICATION FOR MAKING CHANGES AND CUSTOMIZING HOME AUTOMATION SOFTWARE TO THE SPECIFIC NEEDS OF THE USER (U.S. CLS. 21, 23, 26, 36 AND 38).

MARY MUNSON, EXAMINING ATTORNEY

CLASS 9—(Continued).

SN 77-551,934. TECHNOLOGY FOR BUSINESS CORPORATION, MANHATTAN BEACH, CA. FILED 8-20-2008.

tCare

THE MARK CONSISTS OF STANDARD CHARACTERS WITHOUT CLAIM TO ANY PARTICULAR FONT, STYLE, SIZE, OR COLOR.

FOR COMPUTER SOFTWARE STORED ON A DVD USED FOR MANAGEMENT OF INTERNET, TELEPHONE, AND NETWORK COMMUNICATION BETWEEN MEDICAL PERSONNEL, PATIENTS, INSURANCE CARRIERS, AND OTHERS IN THE HEALTHCARE INDUSTRY (U.S. CLS. 21, 23, 26, 36 AND 38).

FIRST USE 6-20-2008; IN COMMERCE 7-8-2008.
LINDA E. BLOHM, EXAMINING ATTORNEY

SN 77-551,947. TECHNOLOGY FOR BUSINESS CORPORATION, MANHATTAN BEACH, CA. FILED 8-20-2008.

tContact

THE MARK CONSISTS OF STANDARD CHARACTERS WITHOUT CLAIM TO ANY PARTICULAR FONT, STYLE, SIZE, OR COLOR.

FOR COMPUTER SOFTWARE STORED ON A DVD USED FOR MANAGEMENT OF CONTACT CENTERS AND CALL CENTERS, FEATURING CALLBACK OPTION, QUEUE POSITION, CALL ROUTING, FAXBACK OPTIONS, FAX ROUTING, AUTOMATED TRANSCRIPTIONS, REPORTING, LOAD MANAGEMENT AND POST CALL SURVEYS (U.S. CLS. 21, 23, 26, 36 AND 38).

FIRST USE 6-20-2008; IN COMMERCE 7-8-2008.
LINDA E. BLOHM, EXAMINING ATTORNEY

SN 77-552,180. TERADYNE, INC., NORTH READING, MA. FILED 8-21-2008.



THE COLOR(S) ORANGE AND BLUE IS/ARE CLAIMED AS A FEATURE OF THE MARK.

THE MARK CONSISTS OF AN ORANGE AND BLUE SWIRL FOLLOWED BY THE WORD "NEPTUNE" IN BLUE. FOR TEST EQUIPMENT FOR ELECTRONIC DEVICES, NAMELY, MASS STORAGE DEVICES (U.S. CLS. 21, 23, 26, 36 AND 38).

KEVON CHISOLM, EXAMINING ATTORNEY

CLASS 9—(Continued).

SN 77-552,599. DAYTONA STORAGE, INC., DBA DAYTONA STORAGE, INC. NORTHVILLE, MI. FILED 8-21-2008.



THE MARK CONSISTS OF A STYLIZED LETTER "V" WITH THE STYLIZED LETTER "X" DRAWN ON THE "V". FOR COMPUTER HARDWARE FOR HIGH-SPEED PROCESSING AND STORAGE OF DATA USING MULTIPLE CPUS (U.S. CLS. 21, 23, 26, 36 AND 38).

FIRST USE 8-19-2008; IN COMMERCE 8-19-2008.
WENDY GOODMAN, EXAMINING ATTORNEY

SN 77-555,277. DAYMEN PHOTO MARKETING LP, MARKHAM, ONTARIO, CANADA, FILED 8-25-2008.

VIVID

THE MARK CONSISTS OF STANDARD CHARACTERS WITHOUT CLAIM TO ANY PARTICULAR FONT, STYLE, SIZE, OR COLOR.

FOR BAGS, HARD AND SOFT COVERED CASES, BACKPACKS WITH ROLLING WHEELS, BACKPACKS WITHOUT ROLLING WHEELS, BELT PACKS, POCKETS AND POUCHES, ALL DESIGNED FOR CARRYING PHOTOGRAPHIC EQUIPMENT AND PHOTOGRAPHIC ACCESSORIES, NAMELY, LENSES, FILM, FLASHES, TRIPODS, CABLES, CORDS AND BATTERIES; WAIST HARNESSES AND SHOULDER HARNESSES DESIGNED FOR USE WITH THE FOREGOING GOODS (U.S. CLS. 21, 23, 26, 36 AND 38).

INGRID C. EULIN, EXAMINING ATTORNEY

CLASS 9—(Continued).

SN 77-556,486. CORKBOARD, LLC., BROOKLYN, NY. FILED 8-27-2008.

CORKBOARD

THE MARK CONSISTS OF STANDARD CHARACTERS WITHOUT CLAIM TO ANY PARTICULAR FONT, STYLE, SIZE, OR COLOR.

FOR COMPUTER SOFTWARE THAT PROVIDES MOBILE AND WEB-BASED ACCESS TO WISHLISTS AND BOOKMARKING ENABLING USERS TO TRANSMIT, SHARE, AND ORGANIZE PRODUCTS, EVENTS, SERVICES, LOCATIONS AND IDEAS ON MULTIPLE COMPUTER AND NETWORK PLATFORMS; COMPUTER SOFTWARE THAT PROVIDES MOBILE AND WEB-BASED ACCESS TO WISHLISTS AND BOOKMARKING ENABLING USERS TO SHARE THEIR WISHLISTS AND BOOKMARKS WITH OTHER USERS; COMPUTER SOFTWARE THAT PROVIDES MOBILE AND WEB-BASED ACCESS TO WISHLISTS AND BOOKMARKING ENABLING USERS TO ENTER INTO TRANSACTIONS FOR PRODUCTS, EVENTS, AND SERVICES CONTAINED IN THEIR OWN OR SHARED WISHLISTS AND BOOKMARKS (U.S. CLS. 21, 23, 26, 36 AND 38).

MIDGE BUTLER, EXAMINING ATTORNEY

SN 77-556,692. STUDIO MB, L.L.C., NEW VERNON, NJ. FILED 8-27-2008.

FANTASY BOTANICALS

THE MARK CONSISTS OF STANDARD CHARACTERS WITHOUT CLAIM TO ANY PARTICULAR FONT, STYLE, SIZE, OR COLOR.

NO CLAIM IS MADE TO THE EXCLUSIVE RIGHT TO USE "BOTANICALS", APART FROM THE MARK AS SHOWN.

FOR DOWNLOADABLE ELECTRONIC PUBLICATIONS IN THE NATURE OF ELECTRONIC PUBLICATIONS, NAMELY, E-BOOKS AND MANUALS, IN THE FIELD OF GARDENING (U.S. CLS. 21, 23, 26, 36 AND 38).

CHARISMA HAMPTON, EXAMINING ATTORNEY

SN 77-556,952. IGT, RENO, NV. FILED 8-27-2008.

TOO HOT TO HANDLE

THE MARK CONSISTS OF STANDARD CHARACTERS WITHOUT CLAIM TO ANY PARTICULAR FONT, STYLE, SIZE, OR COLOR.

FOR GAMING MACHINES, NAMELY, DEVICES WHICH ACCEPT A WAGER (U.S. CLS. 21, 23, 26, 36 AND 38).

MICHELE SWAIN, EXAMINING ATTORNEY

CLASS 9—(Continued).

SN 77-556,954. IGT, RENO, NV. FILED 8-27-2008.

GREENBACK ATTACK

THE MARK CONSISTS OF STANDARD CHARACTERS WITHOUT CLAIM TO ANY PARTICULAR FONT, STYLE, SIZE, OR COLOR.

FOR GAMING MACHINES, NAMELY, DEVICES WHICH ACCEPT A WAGER (U.S. CLS. 21, 23, 26, 36 AND 38).

MICHELE SWAIN, EXAMINING ATTORNEY

SN 77-557,095. HARPERCOLLINS PUBLISHERS LLC, NEW YORK, NY. FILED 8-27-2008.

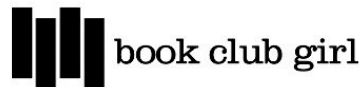

FOR MOUSE PADS; CELLULAR TELEPHONE COVERS AND CELLULAR TELEPHONE FACE COVERS; DECORATIVE MAGNETS (U.S. CLS. 21, 23, 26, 36 AND 38).

SIMON TENG, EXAMINING ATTORNEY

CLASS 9—(Continued).

SN 77-557,268. BARTRON MEDICAL IMAGING, LLC, NEW HAVEN, CT. FILED 8-27-2008.

BARTRON MEDICAL IMAGING
MED-SEG

THE MARK CONSISTS OF STANDARD CHARACTERS WITHOUT CLAIM TO ANY PARTICULAR FONT, STYLE, SIZE, OR COLOR.

NO CLAIM IS MADE TO THE EXCLUSIVE RIGHT TO USE "MEDICAL IMAGING", APART FROM THE MARK AS SHOWN.

FOR COMPUTER HARDWARE; COMPUTER HARDWARE AND COMPUTER PERIPHERAL DEVICES; COMPUTER PROGRAMS FOR ANALYZING X-RAY IMAGES AND IMAGES OF CELLS, BACTERIA AND PATHOGENS; COMPUTER SOFTWARE AND HARDWARE FOR ANALYZING X-RAY IMAGES AND IMAGES OF CELLS, BACTERIA AND PATHOGENS; COMPUTER SOFTWARE FOR ANALYZING X-RAY IMAGES AND IMAGES OF CELLS, BACTERIA AND PATHOGENS; COMPUTER SOFTWARE PLATFORMS FOR ANALYZING X-RAY IMAGES AND IMAGES OF CELLS, BACTERIA AND PATHOGENS; COMPUTERS AND COMPUTER HARDWARE (U.S. CLS. 21, 23, 26, 36 AND 38).

ANDREA K. NADELMAN, EXAMINING ATTORNEY



SN 77-557,307. BARKER, MOREEN, DBA BARKOR ENTERPRISES, TALLAHASSEE, FL. FILED 8-27-2008.



United Records

NO CLAIM IS MADE TO THE EXCLUSIVE RIGHT TO USE "RECORDS", APART FROM THE MARK AS SHOWN.

THE MARK CONSISTS OF A VINYL RECORD WITH A MINIATURE GLOBE LOCATED IN THE CENTER OF THE RECORD. THE WORDS "UNITED RECORDS" APPEAR AT THE BOTTOM OF THE RECORD IN A STYLIZED FONT.

FOR DOWNLOADABLE MUSIC AND RING TONES VIA THE INTERNET AND WIRELESS DEVICES; MUSICAL SOUND RECORDINGS; PRE-RECORDED CDS FEATURING MUSIC (U.S. CLS. 21, 23, 26, 36 AND 38).

TARA PATE, EXAMINING ATTORNEY

CLASS 9—(Continued).

SN 77-557,343. SOYO, INC., ONTARIO, CA. FILED 8-27-2008.

SlimAce

THE MARK CONSISTS OF STANDARD CHARACTERS WITHOUT CLAIM TO ANY PARTICULAR FONT, STYLE, SIZE, OR COLOR.

FOR PORTABLE EXTERNAL HARD DRIVE (U.S. CLS. 21, 23, 26, 36 AND 38).

LYDIA BELZER, EXAMINING ATTORNEY



SN 77-557,349. IGT, RENO, NV. FILED 8-27-2008.

BUBBLE UP

THE MARK CONSISTS OF STANDARD CHARACTERS WITHOUT CLAIM TO ANY PARTICULAR FONT, STYLE, SIZE, OR COLOR.

FOR GAMING MACHINES, NAMELY, DEVICES WHICH ACCEPT A WAGER (U.S. CLS. 21, 23, 26, 36 AND 38).

MICHELE SWAIN, EXAMINING ATTORNEY



SN 77-557,495. ALIENWARE COPORATION, MIAMI, FL. FILED 8-27-2008.



THE MARK CONSISTS OF SYMBOLS THAT ARE MEANT TO REPRESENT ALIEN LETTERS

FOR COMPUTERS (U.S. CLS. 21, 23, 26, 36 AND 38).

FIRST USE 11-0-2007; IN COMMERCE 11-0-2007.

JENNIFER HETU, EXAMINING ATTORNEY



SN 77-557,500. ALIENWARE COPORATION, MIAMI, FL. FILED 8-27-2008.



THE MARK CONSISTS OF SYMBOLS THAT ARE MEANT TO REPRESENT ALIEN LETTERS.

FOR COMPUTERS (U.S. CLS. 21, 23, 26, 36 AND 38).

JENNIFER HETU, EXAMINING ATTORNEY

CLASS 9—(Continued).

SN 77-557,502. ALIENWARE COPORATION, MIAMI, FL. FILED 8-27-2008.



THE MARK CONSISTS OF SYMBOLS THAT ARE MEANT TO REPRESENT ALIEN LETTERS. THE SYMBOLS/CHARACTERS HAVE NO MEANING IN A FOREIGN LANGUAGE. FOR COMPUTERS (U.S. CLS. 21, 23, 26, 36 AND 38). JENNIFER HETU, EXAMINING ATTORNEY

SN 77-557,540. PARIS TECHNOLOGIES, INC., DOYLES-TOWN, PA. FILED 8-28-2008.

OLATION

THE MARK CONSISTS OF STANDARD CHARACTERS WITHOUT CLAIM TO ANY PARTICULAR FONT, STYLE, SIZE, OR COLOR. OWNER OF U.S. REG. NO. 2,267,583. FOR COMPUTER SOFTWARE FOR DOCUMENT MANAGEMENT AND ANALYTICAL FUNCTIONS IN THE AREAS OF FINANCE, MARKETING AND PRODUCTION (U.S. CLS. 21, 23, 26, 36 AND 38). DAYNA BROWNE, EXAMINING ATTORNEY

SN 77-557,576. IGT, RENO, NV. FILED 8-28-2008.

KILLER CASH

THE MARK CONSISTS OF STANDARD CHARACTERS WITHOUT CLAIM TO ANY PARTICULAR FONT, STYLE, SIZE, OR COLOR. FOR GAMING MACHINES, NAMELY, DEVICES WHICH ACCEPT A WAGER (U.S. CLS. 21, 23, 26, 36 AND 38). MICHELE SWAIN, EXAMINING ATTORNEY

CLASS 9—(Continued).

SN 77-558,741. CHEMPLEX INDUSTRIES, INC., PALM CITY, FL. FILED 8-29-2008.

SpectroMicro

THE MARK CONSISTS OF STANDARD CHARACTERS WITHOUT CLAIM TO ANY PARTICULAR FONT, STYLE, SIZE, OR COLOR. FOR LABORATORY EQUIPMENT, NAMELY, SAMPLE CUPS DESIGNED TO HOLD SMALL QUANTITIES OF SAMPLE MATERIAL FOR SPECTROCHEMICAL ANALYSIS (U.S. CLS. 21, 23, 26, 36 AND 38). FIRST USE 1-1-2007; IN COMMERCE 1-1-2007. WENDY GOODMAN, EXAMINING ATTORNEY

SN 77-558,750. DIGICHART, INC., NASHVILLE, TN. FILED 8-29-2008.

BIRTHWAY

THE MARK CONSISTS OF STANDARD CHARACTERS WITHOUT CLAIM TO ANY PARTICULAR FONT, STYLE, SIZE, OR COLOR. FOR MEDICAL COMPUTER SOFTWARE FOR USE WITH PATIENT MONITORING EQUIPMENT FOR RECEIVING, PROCESSING, TRANSMITTING, DISPLAYING, AND PRINTING PATIENT DATA (U.S. CLS. 21, 23, 26, 36 AND 38). STEPHANIE ALI, EXAMINING ATTORNEY

SN 77-558,758. DIGICHART, INC., NASHVILLE, TN. FILED 8-29-2008.

BIRTHWRITE

THE MARK CONSISTS OF STANDARD CHARACTERS WITHOUT CLAIM TO ANY PARTICULAR FONT, STYLE, SIZE, OR COLOR. FOR MEDICAL COMPUTER SOFTWARE FOR USE WITH PATIENT MONITORING EQUIPMENT FOR RECEIVING, PROCESSING, TRANSMITTING, DISPLAYING, AND PRINTING PATIENT DATA (U.S. CLS. 21, 23, 26, 36 AND 38). STEPHANIE ALI, EXAMINING ATTORNEY

CLASS 9—(Continued).

SN 77-558,762. HEWLETT-PACKARD DEVELOPMENT COMPANY, L.P., HOUSTON, TX. FILED 8-29-2008.

ECO HIGHLIGHTS

THE MARK CONSISTS OF STANDARD CHARACTERS WITHOUT CLAIM TO ANY PARTICULAR FONT, STYLE, SIZE, OR COLOR.

NO CLAIM IS MADE TO THE EXCLUSIVE RIGHT TO USE "ECO", APART FROM THE MARK AS SHOWN.

FOR COMPUTERS, PERSONAL COMPUTERS, COMPUTER HARDWARE, COMPUTER SERVERS, COMPUTER PERIPHERALS, PRINTERS, SCANNERS, PHOTOCOPIERS, FACSIMILE MACHINES, COMPUTER MONITORS, FLAT PANEL DISPLAY SCREENS, COMPUTER KEYBOARDS, TELEVISIONS, DIGITAL MEDIA RECEIVERS, PERSONAL DIGITAL ASSISTANTS, DIGITAL PRINTING PRESSES (U.S. CLS. 21, 23, 26, 36 AND 38).

MORGAN WYNNE, EXAMINING ATTORNEY

SN 77-558,766. DIGICHART, INC., NASHVILLE, TN. FILED 8-29-2008.

BIRTHSMART

THE MARK CONSISTS OF STANDARD CHARACTERS WITHOUT CLAIM TO ANY PARTICULAR FONT, STYLE, SIZE, OR COLOR.

FOR MEDICAL COMPUTER SOFTWARE FOR USE WITH PATIENT MONITORING EQUIPMENT FOR RECEIVING, PROCESSING, TRANSMITTING, DISPLAYING, AND PRINTING PATIENT DATA (U.S. CLS. 21, 23, 26, 36 AND 38).

STEPHANIE ALI, EXAMINING ATTORNEY

CLASS 9—(Continued).

SN 77-558,863. JOTMATE, INC., MIAMI, FL. FILED 8-29-2008.

EDISONBOOK

THE MARK CONSISTS OF STANDARD CHARACTERS WITHOUT CLAIM TO ANY PARTICULAR FONT, STYLE, SIZE, OR COLOR.

FOR COMPUTER SOFTWARE AND FIRMWARE, NAMELY, COMPUTER DATABASE MANAGEMENT SOFTWARE FOR USE IN THE MEDICAL AND SCIENTIFIC FIELDS; COMPUTER SOFTWARE AND FIRMWARE FOR CREATING SEARCHABLE DATABASES OF INFORMATION AND DATA; COMPUTER SOFTWARE AND FIRMWARE FOR THE CAPTURE, COLLECTION, EDITING, ORGANIZING, MODIFYING, BOOKMARKING, TRANSMISSION, STORAGE, TIME STAMPING, AUTHENTICATION AND SHARING OF DATA AND INFORMATION; COMPUTER SOFTWARE AND FIRMWARE FOR COMPILING, ANALYZING AND EVALUATING DATA IN MULTIPLE FORMATS (U.S. CLS. 21, 23, 26, 36 AND 38).

AMY ALFIERI, EXAMINING ATTORNEY

SN 77-559,015. TORRENT, INC., NEEDHAM, MA. FILED 8-29-2008.

Signal Armor

THE MARK CONSISTS OF STANDARD CHARACTERS WITHOUT CLAIM TO ANY PARTICULAR FONT, STYLE, SIZE, OR COLOR.

NO CLAIM IS MADE TO THE EXCLUSIVE RIGHT TO USE "SIGNAL", APART FROM THE MARK AS SHOWN.

FOR PROTECTIVE SHIELDING, BEING A COMPONENT OF CONNECTION CABLE FOR USE WITH COMPUTER PERIPHERALS, HOME AUDIO EQUIPMENT, HOME VIDEO EQUIPMENT, AND VIDEO AND COMPUTER GAMES (U.S. CLS. 21, 23, 26, 36 AND 38).

FIRST USE 8-21-2008; IN COMMERCE 8-21-2008.

DARRYL SPRUILL, EXAMINING ATTORNEY

SN 77-559,110. DOUBLE-TAKE SOFTWARE, INC., SOUTH-BOROUGH, MA. FILED 8-29-2008.

LIVEWIRE

THE MARK CONSISTS OF STANDARD CHARACTERS WITHOUT CLAIM TO ANY PARTICULAR FONT, STYLE, SIZE, OR COLOR.

FOR COMPUTER SOFTWARE FOR DATA BACKUP AND RECOVERY (U.S. CLS. 21, 23, 26, 36 AND 38).

PAUL MORENO, EXAMINING ATTORNEY

CLASS 9—(Continued).

SN 77-559,187. CEJAY ENGINEERING, INC., BONITA SPRINGS, FL. FILED 8-29-2008.

VAPS

THE MARK CONSISTS OF STANDARD CHARACTERS WITHOUT CLAIM TO ANY PARTICULAR FONT, STYLE, SIZE, OR COLOR.

FOR POWER SUPPLIES (U.S. CLS. 21, 23, 26, 36 AND 38).
FLORENTINA BLANDU, EXAMINING ATTORNEY

SN 77-559,293. EDSHARE, INC., BROOKLINE, MA. FILED 8-29-2008.

EdShare

THE MARK CONSISTS OF STANDARD CHARACTERS WITHOUT CLAIM TO ANY PARTICULAR FONT, STYLE, SIZE, OR COLOR.

FOR COMPUTER SOFTWARE FOR THE COLLECTION, EDITING, ORGANIZING, MODIFYING, BOOK MARKING, TRANSMISSION, STORAGE AND SHARING OF DATA AND INFORMATION (U.S. CLS. 21, 23, 26, 36 AND 38).

JENNIFER VASQUEZ, EXAMINING ATTORNEY

SN 77-559,404. EDSHARE, INC., BROOKLINE, MA. FILED 8-29-2008.



THE COLOR(S) DARK GREEN, LIGHT GREEN, RED AND WHITE IS/ARE CLAIMED AS A FEATURE OF THE MARK.

THE MARK CONSISTS OF A STYLIZED RED APPLE WITH A DARK GREEN LEAF OUTLINED IN WHITE WITH THE WORDS "ED" AND "SHARE" INSCRIBED WITHIN THE APPLE IN WHITE TEXT. THE APPLE IS IMPOSED OVER A LIGHT GREEN STYLIZED APPLE SKEWED SLIGHTLY TO THE LEFT.

FOR COMPUTER SOFTWARE FOR THE COLLECTION, EDITING, ORGANIZING, MODIFYING, BOOK MARKING, TRANSMISSION, STORAGE AND SHARING OF DATA AND INFORMATION (U.S. CLS. 21, 23, 26, 36 AND 38).

JENNIFER VASQUEZ, EXAMINING ATTORNEY

CLASS 9—(Continued).

SN 77-559,546. STARR, W. HARVEY, DBA STARR LABS, SAN DIEGO, CA. FILED 8-30-2008.

iTar

THE MARK CONSISTS OF STANDARD CHARACTERS WITHOUT CLAIM TO ANY PARTICULAR FONT, STYLE, SIZE, OR COLOR.

FOR COMPUTER GRAPHICS SOFTWARE; ELECTRONIC GAME SOFTWARE; GRAPHICAL USER INTERFACE SOFTWARE (U.S. CLS. 21, 23, 26, 36 AND 38).
GINA FINK, EXAMINING ATTORNEY

SN 77-559,676. PETROFF, MICHAEL L, ARCADIA, CA. FILED 8-31-2008.

Audio Bionics

THE MARK CONSISTS OF STANDARD CHARACTERS WITHOUT CLAIM TO ANY PARTICULAR FONT, STYLE, SIZE, OR COLOR.

NO CLAIM IS MADE TO THE EXCLUSIVE RIGHT TO USE "AUDIO", APART FROM THE MARK AS SHOWN.

FOR EARPHONES AND HEADPHONES (U.S. CLS. 21, 23, 26, 36 AND 38).

DAVID COLLIER, EXAMINING ATTORNEY

SN 77-559,724. IGT, RENO, NV. FILED 9-1-2008.

2ND DRAW ROYAL

THE MARK CONSISTS OF STANDARD CHARACTERS WITHOUT CLAIM TO ANY PARTICULAR FONT, STYLE, SIZE, OR COLOR.

FOR GAMING MACHINES, NAMELY, DEVICES WHICH ACCEPT A WAGER (U.S. CLS. 21, 23, 26, 36 AND 38).

MICHELE SWAIN, EXAMINING ATTORNEY

CLASS 9—(Continued).

SN 77-559,786. ROSENBERG, STEVEN ERIC, OR YEHUDA, ISRAEL, FILED 9-1-2008.

Deep Soul

THE MARK CONSISTS OF STANDARD CHARACTERS WITHOUT CLAIM TO ANY PARTICULAR FONT, STYLE, SIZE, OR COLOR.

FOR DOWNLOADABLE MUSIC, POEMS, LYRICS AND BOOKS VIA THE INTERNET AND WIRELESS DEVICES (U.S. CLS. 21, 23, 26, 36 AND 38).

ANGELA M. MICHELI, EXAMINING ATTORNEY

CLASS 9—(Continued).

SN 77-559,938. BREGENZER, DERRICK, BATTLE CREEK, MI. FILED 9-2-2008.

CREATIVE TURNTABLE

THE MARK CONSISTS OF STANDARD CHARACTERS WITHOUT CLAIM TO ANY PARTICULAR FONT, STYLE, SIZE, OR COLOR.

FOR COMPACT DISCS AND LONG-PLAYING PHONOGRAPH RECORDS FEATURING MUSIC (U.S. CLS. 21, 23, 26, 36 AND 38).

DAVON HATCHETT, EXAMINING ATTORNEY

SN 77-559,796. ROSENBERG, STEVEN ERIC, OR YEHUDA, ISRAEL, FILED 9-1-2008.

Creative In Life

THE MARK CONSISTS OF STANDARD CHARACTERS WITHOUT CLAIM TO ANY PARTICULAR FONT, STYLE, SIZE, OR COLOR.

FOR DOWNLOADABLE MUSIC, POEMS, LYRICS AND BOOKS VIA THE INTERNET AND WIRELESS DEVICES (U.S. CLS. 21, 23, 26, 36 AND 38).

FIRST USE 10-4-2008; IN COMMERCE 10-4-2008.

ANGELA M. MICHELI, EXAMINING ATTORNEY

SN 77-559,942. RADIO FREQUENCY SYSTEMS, INC., MERIDEN, CT. FILED 9-2-2008.

RFS SLIMLINE

THE MARK CONSISTS OF STANDARD CHARACTERS WITHOUT CLAIM TO ANY PARTICULAR FONT, STYLE, SIZE, OR COLOR.

OWNER OF U.S. REG. NOS. 1,576,092, 2,566,829 AND OTHERS.

SEC. 2(F) AS TO "SLIMLINE".

FOR ANTENNAS USED IN WIRELESS COMMUNICATION SYSTEMS (U.S. CLS. 21, 23, 26, 36 AND 38).

FIRST USE 1-26-1999; IN COMMERCE 1-26-1999.

LYDIA BELZER, EXAMINING ATTORNEY

SN 77-559,860. ION GEOPHYSICAL CORPORATION, HOUSTON, TX. FILED 9-2-2008.

DIGIFIN

THE MARK CONSISTS OF STANDARD CHARACTERS WITHOUT CLAIM TO ANY PARTICULAR FONT, STYLE, SIZE, OR COLOR.

FOR MARINE SEISMIC EXPLORATION DEVICE POSITIONING EQUIPMENT AND INSTRUMENT, NAMELY, ACOUSTICAL TRANSMITTER AND RECEIVER ASSEMBLY STEERING DEVICE (U.S. CLS. 21, 23, 26, 36 AND 38).

DAVON HATCHETT, EXAMINING ATTORNEY

SN 77-560,303. PRIORA CASH FLOW MANAGEMENT LLC, APPLETON, WI. FILED 9-2-2008.

Financialyzer

THE MARK CONSISTS OF STANDARD CHARACTERS WITHOUT CLAIM TO ANY PARTICULAR FONT, STYLE, SIZE, OR COLOR.

FOR FINANCIAL MANAGEMENT SOFTWARE FOR BUSINESSES AND OTHER ENTITIES (U.S. CLS. 21, 23, 26, 36 AND 38).

KATHERINE STOIDES, EXAMINING ATTORNEY

CLASS 9—(Continued).

SN 77-560,352. NATIONAL OCEANIC AND ATMOSPHERIC ADMINISTRATION, WASHINGTON, DC. FILED 9-2-2008.



OWNER OF U.S. REG. NOS. 3,236,080 AND 3,478,025.
 NO CLAIM IS MADE TO THE EXCLUSIVE RIGHT TO USE "INTEGRATED OCEAN OBSERVING SYSTEM", APART FROM THE MARK AS SHOWN.
 THE COLOR(S) BLUE AND BLACK IS/ARE CLAIMED AS A FEATURE OF THE MARK.
 THE MARK CONSISTS OF THE ACRONYM "IOOS". EACH LETTER OF THE ACRONYM IS DIVIDED IN HALF. FOR THE LETTERS "I" AND "S", THE LEFT-SIDE IS IN BLACK WHILE THE RIGHT SIDE IS IN BLUE. FOR THE LETTERS "O", BOTH SIDES CONSIST OF SHADES OF BLUE AND BLACK. THE TWO "O" LETTERS IN THE ACRONYM CONSIST OF GLOBE IMAGES WITH THE CONTINENTS BEING BLACK AND THE OCEAN BEING BLUE. AT THE BOTTOM IS THE PHRASE "INTEGRATED OCEAN OBSERVING SYSTEM" ALL IN BLUE EXCEPT THAT THE FIRST LETTER OF EACH OF THOSE WORDS IS IN BLACK.
 FOR ELECTRONIC PUBLICATIONS, NAMELY, BROCHURES, INFORMATIONAL SHEETS, MANUALS, BOOKS, AND TEACHING MATERIALS FEATURING OPEN OCEANS, COASTAL WATERS, AND GREAT LAKES INFORMATION RECORDED ON COMPUTER MEDIA (U.S. CLS. 21, 23, 26, 36 AND 38).
 FIRST USE 5-0-2008; IN COMMERCE 5-0-2008.
 SIMON TENG, EXAMINING ATTORNEY

CLASS 9—(Continued).

SN 77-560,499. ARUZE CORPORATION, TOKYO, JAPAN, FILED 9-2-2008.



THE NON-LATIN CHARACTERS IN THE MARK TRANSLITERATE TO "SHEN LONG", AND THIS MEANS DRAGON GOD IN ENGLISH.
 FOR SLOT MACHINES AND REPLACEMENT PARTS THEREFOR; VIDEO SLOT MACHINES AND REPLACEMENT PARTS THEREFOR; GAMING MACHINES AND REPLACEMENT PARTS THEREFOR; GAMING MACHINES WITH A LIQUID CRYSTAL DISPLAY AND REPLACEMENT PARTS THEREFOR; MECHANICAL REEL TYPE SLOT MACHINES WITH A LIQUID CRYSTAL DISPLAY AND REPLACEMENT PARTS THEREFOR; MEDIA STORAGE COMPUTER SOFTWARE FOR ELECTRONIC CIRCUITS, OPTICAL DISKS, MAGNETIC TAPES, MAGNETIC DISKS, MAGNETIC CARDS, OPTICAL-MAGNETIC DISKS, CD-ROMS, ROM-CARTRIDGES AND DVDS, NAMELY, COMPUTER SOFTWARE FOR CONTROLLING SLOT MACHINES AND GAME MACHINES; COMPUTER GAME SOFTWARE FOR GAME MACHINES AND SLOT MACHINES (U.S. CLS. 21, 23, 26, 36 AND 38).
 HAI-LY LAM, EXAMINING ATTORNEY

SN 77-560,793. INTENSE DYNAMIC ACOUSTICS LLC, LIVINGSTON MANOR, NY. FILED 9-2-2008.

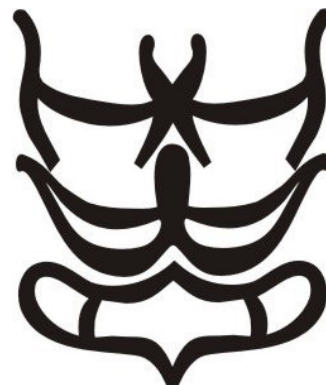

THE MARK CONSISTS OF A STYLIZED MIRROR IMAGE OF THE LETTERS "I", "D", "A", MIRRORED ALONG A VERTICAL LINE DOWN THE CENTER.
 FOR LOUDSPEAKER CABINETS (U.S. CLS. 21, 23, 26, 36 AND 38).
 FIRST USE 4-26-2007; IN COMMERCE 5-2-2007.
 KIM SAITO, EXAMINING ATTORNEY

CLASS 9—(Continued).

SN 77-561,009. WINNINGER, THOMAS J., EDINA, MN. FILED 9-3-2008.

THOMAS J. WINNINGER

ABSOLUTE SKILLS



NO CLAIM IS MADE TO THE EXCLUSIVE RIGHT TO USE "SKILLS", APART FROM THE MARK AS SHOWN.

THE COLOR(S) BLACK, RED AND WHITE IS/ARE CLAIMED AS A FEATURE OF THE MARK.

THE MARK CONSISTS OF THE WORD "ABSOLUTE" IN ABADI MT CONDENSED EXTRA BOLD CAPS IN BLACK FOLLOWED BY THE WORD "SKILLS" IN ABADI MT CONDENSED EXTRA BOLD CAPS IN RED WITH SOLID BLACK RECTANGULAR BOX RUNNING THE LENGTH OF THE TYPE UNDER THE WORDS "ABSOLUTE SKILLS".

FOR DIGITAL MEDIA, NAMELY, CDS, DVDS, DOWNLOADABLE AUDIO FILES, DOWNLOADABLE MULTIMEDIA FILES, VIDEO CASSETTES, DOWNLOADABLE AUDIO AND VIDEO RECORDINGS AND HIGH DEFINITION DIGITAL DISKS ALL FEATURING MOTIVATIONAL SPEAKING, BUSINESS TRAINING, AND INSTRUCTIONAL AND EDUCATIONAL TRAINING IN THE FIELDS OF BUSINESS AND CORPORATE GROWTH AND PERFORMANCE, INCLUDING SALES, MARKETING, HIRING, BRANDING AND LEADERSHIP SKILLS (U.S. CLS. 21, 23, 26, 36 AND 38).

TRACY FLETCHER, EXAMINING ATTORNEY

SN 77-561,257. RED.COM, INC., EASTSOUND, WA. FILED 9-3-2008.

RED 3D

THE MARK CONSISTS OF STANDARD CHARACTERS WITHOUT CLAIM TO ANY PARTICULAR FONT, STYLE, SIZE, OR COLOR.

NO CLAIM IS MADE TO THE EXCLUSIVE RIGHT TO USE "3D", APART FROM THE MARK AS SHOWN.

FOR CAMERAS, CAMERA LENSES, PROJECTORS, EYEGLASSES AND SOFTWARE, ALL FOR USE IN THE RECORDING AND PLAYBACK OF 3D IMAGES (U.S. CLS. 21, 23, 26, 36 AND 38).

FRANK LATTUCA, EXAMINING ATTORNEY

CLASS 9—(Continued).

SN 77-561,288. INTENTIONAL FACEMASK LP, EDMOND, OK. FILED 9-3-2008.

INTENTIONAL FACEMASK

THE MARK CONSISTS OF STANDARD CHARACTERS WITHOUT CLAIM TO ANY PARTICULAR FONT, STYLE, SIZE, OR COLOR.

FOR BASEBALL BATTING HELMETS; CATCHERS' HELMETS; CHIN STRAPS FOR FOOTBALL HELMETS; DECORATIVE AND FANCIFUL ITEMS FOR COVERING OF, AND FOR USE IN CONNECTION WITH PROTECTIVE HELMETS; FOOTBALL HELMETS; HOCKEY HELMETS; PROTECTIVE FACE-SHIELDS FOR PROTECTIVE HELMETS; PROTECTIVE HELMETS; PROTECTIVE HELMETS FOR SPORTS; SAFETY HELMETS; SPORTS HELMETS (U.S. CLS. 21, 23, 26, 36 AND 38).

DAVON HATCHETT, EXAMINING ATTORNEY

SN 77-561,311. OAKLEY, INC., FOOTHILL RANCH, CA. FILED 9-3-2008.

OAKLEY JUPITER

THE MARK CONSISTS OF STANDARD CHARACTERS WITHOUT CLAIM TO ANY PARTICULAR FONT, STYLE, SIZE, OR COLOR.

OWNER OF U.S. REG. NOS. 1,521,599 AND 1,552,583.

FOR PROTECTIVE EYEWEAR, NAMELY, SPECTACLES, PRESCRIPTION EYEWEAR, ANTI GLARE GLASSES AND SUNGLASSES AND THEIR PARTS AND ACCESSORIES, NAMELY, REPLACEMENT LENSES, FRAMES, EARSTEMS, AND NOSE PIECES; CASES SPECIALLY ADAPTED FOR SPECTACLES AND SUNGLASSES AND THEIR PARTS AND ACCESSORIES (U.S. CLS. 21, 23, 26, 36 AND 38).

GEORGE LORENZO, EXAMINING ATTORNEY

SN 77-561,328. OAKLEY, INC., FOOTHILL RANCH, CA. FILED 9-3-2008.

COMMIT

THE MARK CONSISTS OF STANDARD CHARACTERS WITHOUT CLAIM TO ANY PARTICULAR FONT, STYLE, SIZE, OR COLOR.

FOR PROTECTIVE EYEWEAR, NAMELY, SPECTACLES, PRESCRIPTION EYEWEAR, ANTI GLARE GLASSES AND SUNGLASSES AND THEIR PARTS AND ACCESSORIES, NAMELY, REPLACEMENT LENSES, FRAMES, EARSTEMS, AND NOSE PIECES; CASES SPECIALLY ADAPTED FOR SPECTACLES AND SUNGLASSES AND THEIR PARTS AND ACCESSORIES (U.S. CLS. 21, 23, 26, 36 AND 38).

GEORGE LORENZO, EXAMINING ATTORNEY

CLASS 9—(Continued).

SN 77-561,336. OAKLEY, INC., FOOTHILL RANCH, CA. FILED 9-3-2008.

RESTLESS

THE MARK CONSISTS OF STANDARD CHARACTERS WITHOUT CLAIM TO ANY PARTICULAR FONT, STYLE, SIZE, OR COLOR.

FOR PROTECTIVE EYEWEAR, NAMELY, SPECTACLES, PRESCRIPTION EYEWEAR, ANTI GLARE GLASSES AND SUNGLASSES AND THEIR PARTS AND ACCESSORIES, NAMELY, REPLACEMENT LENSES, FRAMES, EARSTEMS, AND NOSE PIECES; CASES SPECIALLY ADAPTED FOR SPECTACLES AND SUNGLASSES AND THEIR PARTS AND ACCESSORIES (U.S. CLS. 21, 23, 26, 36 AND 38).

GEORGE LORENZO, EXAMINING ATTORNEY

CLASS 9—(Continued).

SN 77-561,609. WILLIAM T. WILKINSON, MEDIA, PA. FILED 9-3-2008.

SUPER 7

THE MARK CONSISTS OF STANDARD CHARACTERS WITHOUT CLAIM TO ANY PARTICULAR FONT, STYLE, SIZE, OR COLOR.

FOR DIGITAL MATERIALS, NAMELY, CDS, DVDS, VIDEOS, AND DOWNLOADABLE AUDIO FILES, FEATURING WORKOUT EXERCISE (U.S. CLS. 21, 23, 26, 36 AND 38).

JOHN SCHUYLER YARD, EXAMINING ATTORNEY

SN 77-561,349. OAKLEY, INC., FOOTHILL RANCH, CA. FILED 9-3-2008.

IMPATIENT

THE MARK CONSISTS OF STANDARD CHARACTERS WITHOUT CLAIM TO ANY PARTICULAR FONT, STYLE, SIZE, OR COLOR.

FOR PROTECTIVE EYEWEAR, NAMELY, SPECTACLES, PRESCRIPTION EYEWEAR, ANTI GLARE GLASSES AND SUNGLASSES AND THEIR PARTS AND ACCESSORIES, NAMELY, REPLACEMENT LENSES, FRAMES, EARSTEMS, AND NOSE PIECES; CASES SPECIALLY ADAPTED FOR SPECTACLES AND SUNGLASSES AND THEIR PARTS AND ACCESSORIES (U.S. CLS. 21, 23, 26, 36 AND 38).

GEORGE LORENZO, EXAMINING ATTORNEY

SN 77-561,649. ION GEOPHYSICAL CORPORATION, HOUSTON, TX. FILED 9-3-2008.

DIGIBIRD

THE MARK CONSISTS OF STANDARD CHARACTERS WITHOUT CLAIM TO ANY PARTICULAR FONT, STYLE, SIZE, OR COLOR.

FOR MARINE SEISMIC EXPLORATION DEVICE POSITIONING EQUIPMENT AND INSTRUMENT, NAMELY, ACOUSTICAL TRANSMITTER AND RECEIVER ASSEMBLY STEERING DEVICE (U.S. CLS. 21, 23, 26, 36 AND 38).

DAVON HATCHETT, EXAMINING ATTORNEY

SN 77-561,368. OAKLEY, INC., FOOTHILL RANCH, CA. FILED 9-3-2008.

HERETIC

THE MARK CONSISTS OF STANDARD CHARACTERS WITHOUT CLAIM TO ANY PARTICULAR FONT, STYLE, SIZE, OR COLOR.

FOR PROTECTIVE EYEWEAR, NAMELY, SPECTACLES, PRESCRIPTION EYEWEAR, ANTI GLARE GLASSES AND SUNGLASSES AND THEIR PARTS AND ACCESSORIES, NAMELY, REPLACEMENT LENSES, FRAMES, EARSTEMS, AND NOSE PIECES; CASES SPECIALLY ADAPTED FOR SPECTACLES AND SUNGLASSES AND THEIR PARTS AND ACCESSORIES (U.S. CLS. 21, 23, 26, 36 AND 38).

GEORGE LORENZO, EXAMINING ATTORNEY

SN 77-561,665. EXCEPTIONAL INNOVATION, WESTERVILLE, OH. FILED 9-3-2008.

life|tuner

OWNER OF U.S. REG. NOS. 3,383,149, 3,393,248 AND 3,438,063.

NO CLAIM IS MADE TO THE EXCLUSIVE RIGHT TO USE "TUNER", APART FROM THE MARK AS SHOWN.

THE MARK CONSISTS OF THE WORD "LIFE" FOLLOWED BY A VERTICAL BAR KNOWN AS THE PIPE SYMBOL FOLLOWED BY THE WORD "TUNER".

FOR DIGITAL ENTERTAINMENT DEVICE COMPRISING MULTIPLE TV TUNERS (U.S. CLS. 21, 23, 26, 36 AND 38).

EDWARD NELSON, EXAMINING ATTORNEY

CLASS 9—(Continued).

SN 77-561,969. DIRK ELLER, SAN ANTONIO, TX. FILED 9-4-2008.

BETTER THAN LIVE

THE MARK CONSISTS OF STANDARD CHARACTERS WITHOUT CLAIM TO ANY PARTICULAR FONT, STYLE, SIZE, OR COLOR.

FOR CONSUMER ELECTRONIC PRODUCTS, NAMELY, AUDIO AMPLIFIERS, AUDIO SPEAKERS, AUDIO RECEIVERS, ELECTRICAL AUDIO AND SPEAKER CABLES AND CONNECTORS, HOME THEATER SYSTEMS, AUDIO DECODERS, VIDEO DECODERS, SPEAKERS, POWER CONVERSION DEVICES, POWER CONVERTERS, AND POWER INVERTERS; TELEVISIONS; RADIOS; VIDEO CASSETTE RECORDERS AND PLAYERS; COMPACT DISC PLAYERS; DIGITAL AUDIO TAPE RECORDERS; VIDEO TRANSMISSION APPARATUS; DIGITAL MEDIA, NAMELY, PRE-RECORDED VIDEO CASSETTES, DIGITAL VIDEO DISCS, DIGITAL VERSATILE DISCS, DOWNLOADABLE AUDIO AND VIDEO RECORDINGS, DVDS, AND HIGH DEFINITION DIGITAL DISKS FEATURING MUSIC, TELEVISION PROGRAMS, MOVIES, AND RADIO PROGRAMS; DIGITAL AUDIO PLAYERS; PORTABLE DIGITAL AUDIO PLAYERS; DIGITAL MEDIA SERVERS; DIGITAL MEDIA RECEIVERS; DIGITAL MEDIA STREAMING DEVICES; DOWNLOADABLE MP3 FILES, MP3 RECORDINGS, ON-LINE DISCUSSION BOARDS, WEBCASTS AND PODCASTS FEATURING MUSIC, AUDIO BOOKS AND NEWS BROADCASTS; COMPUTERS, COMPUTER HARDWARE AND COMPUTER SOFTWARE FOR THE BROADCAST, DOWNLOAD, STORAGE, MANIPULATION AND PLAYBACK OF MUSIC, SOUND RECORDINGS, AND AUDIO-VISUAL RECORDINGS; CD, DVD AND HARD DRIVE-BASED PLAYERS FOR MUSIC, SOUND RECORDINGS, AUDIO-VISUAL RECORDINGS; AUDIO AMPLIFIERS; AUDIO CIRCUIT BOARDS; VIDEO CIRCUIT BOARDS; AUDIO-VISUAL RECEIVERS; AUDIO RECORDERS; VIDEO RECORDERS; COMPUTER PROGRAMS FOR EDITING VIDEO, IMAGES, AND SOUND; COMPUTER SOFTWARE FEATURING MUSICAL SOUND RECORDINGS AND MUSICAL VIDEO RECORDINGS; APPARATUS FOR BROADCASTING, RECORDING, TRANSMISSION OR REPRODUCTION OF SOUND OR IMAGES; DOWNLOADABLE MUSICAL SOUND RECORDINGS (U.S. CLS. 21, 23, 26, 36 AND 38).

LOURDES AYALA, EXAMINING ATTORNEY

SN 77-562,023. NOKEENA NETWORKS, INC., SANTA CLARA, CA. FILED 9-4-2008.

NOKEENA

THE MARK CONSISTS OF STANDARD CHARACTERS WITHOUT CLAIM TO ANY PARTICULAR FONT, STYLE, SIZE, OR COLOR.

THE FOREIGN WORDING IN THE MARK TRANSLATES INTO ENGLISH AS SHE SAW OR IF SOMEONE SAW FROM TAMIL OR MALAYALAM.

FOR COMPUTER NETWORK VIDEO SWITCHES (U.S. CLS. 21, 23, 26, 36 AND 38).

ELISSA GARBER KON, EXAMINING ATTORNEY

CLASS 9—(Continued).

SN 77-562,156. SHERWOOD KING, DBA OLD TAPPAN NETWORK ASSOCIATES, INC., OLD TAPPAN, NJ. FILED 9-4-2008.

"Quality...Commitment...Purpose"

THE MARK CONSISTS OF STANDARD CHARACTERS WITHOUT CLAIM TO ANY PARTICULAR FONT, STYLE, SIZE, OR COLOR.

FOR COMPUTER NETWORKING HARDWARE (U.S. CLS. 21, 23, 26, 36 AND 38).

TIMOTHY FINNEGAN, EXAMINING ATTORNEY

SN 77-562,552. MAK TECHNOLOGIES, CAMBRIDGE, MA. FILED 9-4-2008.

VR-VANTAGE

THE MARK CONSISTS OF STANDARD CHARACTERS WITHOUT CLAIM TO ANY PARTICULAR FONT, STYLE, SIZE, OR COLOR.

OWNER OF U.S. REG. NOS. 2,365,543, 2,665,792 AND 3,294,977.

FOR COMPUTER SOFTWARE USED TO MODEL, CREATE AND EDIT TACTICAL AND STRATEGIC SIMULATION TRAINING ENVIRONMENTS; COMPUTER SOFTWARE DEVELOPMENT TOOLS FOR USE IN GENERATING IMAGES IN TACTICAL AND STRATEGIC SIMULATION TRAINING ENVIRONMENTS; AND USER MANUALS SOLD AS A UNIT THEREWITH (U.S. CLS. 21, 23, 26, 36 AND 38).

HEATHER BIDDULPH, EXAMINING ATTORNEY

SN 77-562,802. MOYER, ADAM ROBERT, DBA KNOCK-AROUND SUNGLASSES, SAN DIEGO, CA. FILED 9-4-2008.

Knockaround

THE MARK CONSISTS OF THE WORD "KNOCK-AROUND" IN STYLIZED LETTERING.

FOR SUNGLASSES (U.S. CLS. 21, 23, 26, 36 AND 38).

FIRST USE 9-20-2005; IN COMMERCE 10-20-2005.

PAUL CROWLEY, EXAMINING ATTORNEY

CLASS 9—(Continued).

SN 77-562,822. BALLY GAMING, INC., DBA BALLY TECHNOLOGIES, LAS VEGAS, NV. FILED 9-4-2008.

BLAZING STARS

THE MARK CONSISTS OF STANDARD CHARACTERS WITHOUT CLAIM TO ANY PARTICULAR FONT, STYLE, SIZE, OR COLOR.

FOR GAMING DEVICES, NAMELY, SLOT MACHINES WITH OR WITHOUT VIDEO OUTPUT (U.S. CLS. 21, 23, 26, 36 AND 38).

DAVID TOOLEY, EXAMINING ATTORNEY

SN 77-562,890. GERUVIM, CHICAGO, IL. FILED 9-4-2008.

GERUVÎM

THE MARK CONSISTS OF THE STYLIZED TEXT "GERUVÎM".

FOR CELL PHONE BATTERY CHARGERS; CELL PHONES; COMPUTERS; DIGITAL CAMERAS; VIDEO CAMERAS (U.S. CLS. 21, 23, 26, 36 AND 38).

FIRST USE 8-8-2008; IN COMMERCE 8-8-2008.
NELSON SNYDER, EXAMINING ATTORNEY

CLASS 9—(Continued).

SN 77-562,913. PUTIAN MUNICIPAL NEW DEVELOPING GIFT CO., LTD., PUTIAN CITY, CHINA, FILED 9-4-2008.



THE MARK CONSISTS OF THE WORD "XXLP" IS AN INVENTED WORD AND HAS NO MEANING OR SIGNIFICANCE IN THE RELEVANT TRADE OR IN ANY LANGUAGES.

FOR NOTEBOOK COMPUTERS; POCKET CALCULATORS; PHOTOCOPIERS; FACSIMILE MACHINES; WEIGHING EQUIPMENT, NAMELY, SCALES AND BALANCES; RADIOS; TELEPHONE APPARATUS; GALVANIC BATTERIES; DIRECTIONAL COMPASSES; TIME CLOCKS (U.S. CLS. 21, 23, 26, 36 AND 38).

SAIMA MAKHDOOM, EXAMINING ATTORNEY

SN 77-562,965. PROCREATE INC., ANACORTES, WA. FILED 9-5-2008.

REVOLUTIONARY SUPPORT

THE MARK CONSISTS OF STANDARD CHARACTERS WITHOUT CLAIM TO ANY PARTICULAR FONT, STYLE, SIZE, OR COLOR.

FOR ELECTRONIC AND/OR MECHANICAL ACCESSORIES FOR PORTABLE AND HANDHELD DIGITAL ELECTRONIC DEVICES, NAMELY, STANDS, HOLSTERS AND/OR DOCKING STATIONS SPECIALLY DESIGNED FOR HOLDING PORTABLE AND HANDHELD DIGITAL ELECTRONIC DEVICES, AND BATTERY CHARGERS, ELECTRICAL CONNECTORS, WIRES, CABLES, ADAPTERS AND REMOTE CONTROLS FOR PORTABLE AND HANDHELD DIGITAL ELECTRONIC DEVICES (U.S. CLS. 21, 23, 26, 36 AND 38).

JACQUELINE A. LAVINE, EXAMINING ATTORNEY

CLASS 9—(Continued).

SN 77-562,967. PROCREATE INC., ANACORTES, WA. FILED 9-5-2008.

PODIUM

THE MARK CONSISTS OF STANDARD CHARACTERS WITHOUT CLAIM TO ANY PARTICULAR FONT, STYLE, SIZE, OR COLOR.

FOR ELECTRONIC AND/OR MECHANICAL ACCESSORIES FOR PORTABLE AND HANDHELD DIGITAL ELECTRONIC DEVICES, NAMELY, STANDS, HOLDERS AND/OR DOCKING STATIONS SPECIALLY DESIGNED FOR HOLDING PORTABLE AND HANDHELD DIGITAL ELECTRONIC DEVICES, AND BATTERY CHARGERS, ELECTRICAL CONNECTORS, WIRES, CABLES, ADAPTERS AND REMOTE CONTROLS FOR PORTABLE AND HANDHELD DIGITAL ELECTRONIC DEVICES (U.S. CLS. 21, 23, 26, 36 AND 38).

JACQUELINE A. LAVINE, EXAMINING ATTORNEY

SN 77-562,969. PROCREATE INC., ANACORTES, WA. FILED 9-5-2008.

FLYPOD

THE MARK CONSISTS OF STANDARD CHARACTERS WITHOUT CLAIM TO ANY PARTICULAR FONT, STYLE, SIZE, OR COLOR.

FOR ELECTRONIC AND/OR MECHANICAL ACCESSORIES FOR PORTABLE AND HANDHELD DIGITAL ELECTRONIC DEVICES, NAMELY, STANDS, HOLDERS AND/OR DOCKING STATIONS SPECIALLY DESIGNED FOR HOLDING PORTABLE AND HANDHELD DIGITAL ELECTRONIC DEVICES, AND BATTERY CHARGERS, ELECTRICAL CONNECTORS, WIRES, CABLES, ADAPTERS AND REMOTE CONTROLS FOR PORTABLE AND HANDHELD DIGITAL ELECTRONIC DEVICES (U.S. CLS. 21, 23, 26, 36 AND 38).

JACQUELINE A. LAVINE, EXAMINING ATTORNEY

SN 77-563,106. GDS AMPLIFICATION LLC, DBA GDS AMPLIFICATION LLC, FENTON, MI. FILED 9-5-2008.

Bigtone

THE MARK CONSISTS OF STANDARD CHARACTERS WITHOUT CLAIM TO ANY PARTICULAR FONT, STYLE, SIZE, OR COLOR.

FOR (BASED ON USE IN COMMERCE) AUDIO SPEAKERS (BASED ON INTENT TO USE) GUITAR PEDALS (U.S. CLS. 21, 23, 26, 36 AND 38).

FIRST USE 0-0-2006; IN COMMERCE 0-0-2006.

SUSAN RICHARDS, EXAMINING ATTORNEY

CLASS 9—(Continued).

SN 77-563,147. JAMCAM SYSTEMS, INC., MILL VALLEY, CA. FILED 9-5-2008.

JAMCAM

THE MARK CONSISTS OF STANDARD CHARACTERS WITHOUT CLAIM TO ANY PARTICULAR FONT, STYLE, SIZE, OR COLOR.

FOR CONSUMER ELECTRONIC PRODUCTS, NAMELY, VIDEO CAMERAS (U.S. CLS. 21, 23, 26, 36 AND 38).

JEFF DEFORD, EXAMINING ATTORNEY

SN 77-563,149. RURO INCORPORATED, FREDERICK, MD. FILED 9-5-2008.

ElegantDS

THE MARK CONSISTS OF STANDARD CHARACTERS WITHOUT CLAIM TO ANY PARTICULAR FONT, STYLE, SIZE, OR COLOR.

FOR COMPUTER SOFTWARE FOR RAPID BUILDING AND DEPLOYMENT OF WEB APPLICATIONS THAT MAY BE DOWNLOADED FROM A GLOBAL COMPUTER NETWORK (U.S. CLS. 21, 23, 26, 36 AND 38).

FIRST USE 4-1-2007; IN COMMERCE 8-1-2007.

JEFF DEFORD, EXAMINING ATTORNEY

SN 77-563,187. DM RECORDS, INC., DBA BELLMARK RECORDS, LIGHTHOUSE POINT, FL. FILED 9-5-2008.

Bellmark Records

THE MARK CONSISTS OF STANDARD CHARACTERS WITHOUT CLAIM TO ANY PARTICULAR FONT, STYLE, SIZE, OR COLOR.

NO CLAIM IS MADE TO THE EXCLUSIVE RIGHT TO USE "RECORDS", APART FROM THE MARK AS SHOWN.

FOR DOWNLOADABLE MUSICAL SOUND RECORDINGS; PRE-RECORDED CDS FEATURING MUSICAL PERFORMANCES; PRE-RECORDED CDS, VIDEO TAPES, LASER DISKS AND DVDS FEATURING MUSICAL PERFORMANCES (U.S. CLS. 21, 23, 26, 36 AND 38).

FIRST USE 9-1-1990; IN COMMERCE 9-1-1990.

DOUGLAS LEE, EXAMINING ATTORNEY

CLASS 9—(Continued).

SN 77-563,242. THE TIFFEN COMPANY, LLC, HAUPPAUGE, NY. FILED 9-5-2008.

FLYER-LE RED

THE MARK CONSISTS OF STANDARD CHARACTERS WITHOUT CLAIM TO ANY PARTICULAR FONT, STYLE, SIZE, OR COLOR.

OWNER OF U.S. REG. NO. 3,085,030.

NO CLAIM IS MADE TO THE EXCLUSIVE RIGHT TO USE "RED", APART FROM THE MARK AS SHOWN.

FOR FILM AND VIDEO CAMERA MOUNTING APPARATUS, NAMELY, A PLATFORM WHICH HOLDS THE CAMERA, BATTERY AND MONITOR AND AN ARM FOR ADJUSTABLY MOVING THE PLATFORM; OPERATOR-SUPPORTED FILM AND VIDEO CAMERA STABILIZERS AND COMPONENTS THEREOF, NAMELY, VEST, MONITOR, POWER SUPPLY, ARTICULATED ARM, BOOM, POST, LIFT, GIMBAL, SPEAKER, INFRARED REMOTE, CONNECTOR AND CASE ALL SOLD AS A UNIT (U.S. CLS. 21, 23, 26, 36 AND 38).

TASNEEM HUSSAIN, EXAMINING ATTORNEY

CLASS 9—(Continued).

SN 77-563,414. SOTTERA, INC., SCOTTSDALE, AZ. FILED 9-5-2008.

NPRO

THE MARK CONSISTS OF STANDARD CHARACTERS WITHOUT CLAIM TO ANY PARTICULAR FONT, STYLE, SIZE, OR COLOR.

FOR SMOKING SIMULATORS, NAMELY, ELECTRONIC CIGARETTES WITHOUT TOBACCO, NOT FOR MEDICAL PURPOSES (U.S. CLS. 21, 23, 26, 36 AND 38).

FIRST USE 8-15-2008; IN COMMERCE 8-15-2008.

EMILY CARLSEN, EXAMINING ATTORNEY

SN 77-563,265. BLOOM, IAN, SILVER SPRING, MD. FILED 9-5-2008.

Crimson

THE MARK CONSISTS OF STANDARD CHARACTERS WITHOUT CLAIM TO ANY PARTICULAR FONT, STYLE, SIZE, OR COLOR.

FOR DOWNLOADABLE COMPUTER SOFTWARE FOR MANAGING, CREATING, VIEWING, AND EDITING VIDEOTAPE RECORDINGS AND MOTION PICTURE FILMS, AND DOWNLOADABLE INSTRUCTION MANUALS AND INSTRUCTIONAL VIDEO RECORDINGS SOLD AS A UNIT THEREWITH (U.S. CLS. 21, 23, 26, 36 AND 38).

FIRST USE 4-3-2008; IN COMMERCE 4-3-2008.

ROBIN MITTLER, EXAMINING ATTORNEY

SN 77-563,524. KING SHOW GAMES INC., MINNETONKA, MN. FILED 9-5-2008.

HOT ROLL

THE MARK CONSISTS OF STANDARD CHARACTERS WITHOUT CLAIM TO ANY PARTICULAR FONT, STYLE, SIZE, OR COLOR.

FOR GAMBLING MACHINES; GAMING DEVICES, NAMELY, GAMING MACHINES, SLOT MACHINES, BINGO MACHINES, WITH OR WITHOUT VIDEO OUTPUT; GAMING EQUIPMENT, NAMELY, SLOT MACHINES WITH OR WITHOUT VIDEO OUTPUT; GAMING MACHINES; GAMING MACHINES INCLUDING SLOT MACHINES OR VIDEO LOTTERY TERMINALS; GAMING MACHINES THAT GENERATE OR DISPLAY WAGER OUTCOMES; GAMING MACHINES, NAMELY, SLOT MACHINES AND VIDEO LOTTERY TERMINALS; GAMING MACHINES, NAMELY, DEVICES WHICH ACCEPT A WAGER; GAMING MACHINES, NAMELY, ELECTRONIC SLOT AND BINGO MACHINES; GAMING SOFTWARE THAT GENERATES OR DISPLAYS WAGER OUTCOMES OF GAMING MACHINES; SLOT MACHINES (U.S. CLS. 21, 23, 26, 36 AND 38).

KEVON CHISOLM, EXAMINING ATTORNEY

SN 77-563,297. BRAUER, CHARLES, CARMEL, CA. FILED 9-5-2008.

HedgeTools

THE MARK CONSISTS OF STANDARD CHARACTERS WITHOUT CLAIM TO ANY PARTICULAR FONT, STYLE, SIZE, OR COLOR.

FOR COMPUTER SOFTWARE DESKTOP APPLICATION THAT GIVES A PORTFOLIO MANAGER A REAL-TIME VIEW OF WHAT IS OCCURRING ON THE MAJOR FINANCIAL EXCHANGES (U.S. CLS. 21, 23, 26, 36 AND 38).

JILL C. ALT, EXAMINING ATTORNEY

CLASS 9—(Continued).

SN 77-563,543. KING SHOW GAMES INC., MINNETONKA, MN. FILED 9-5-2008.

CHERRY CASH

THE MARK CONSISTS OF STANDARD CHARACTERS WITHOUT CLAIM TO ANY PARTICULAR FONT, STYLE, SIZE, OR COLOR.

FOR GAMBLING MACHINES; GAMING DEVICES, NAMELY, GAMING MACHINES, SLOT MACHINES, BINGO MACHINES, WITH OR WITHOUT VIDEO OUTPUT; GAMING EQUIPMENT, NAMELY, SLOT MACHINES WITH OR WITHOUT VIDEO OUTPUT; GAMING MACHINES; GAMING MACHINES INCLUDING SLOT MACHINES OR VIDEO LOTTERY TERMINALS; GAMING MACHINES THAT GENERATE OR DISPLAY WAGER OUTCOMES; GAMING MACHINES, NAMELY, SLOT MACHINES AND VIDEO LOTTERY TERMINALS; GAMING MACHINES, NAMELY, DEVICES WHICH ACCEPT A WAGER; GAMING MACHINES, NAMELY, ELECTRONIC SLOT AND BINGO MACHINES; GAMING SOFTWARE THAT GENERATES OR DISPLAYS WAGER OUTCOMES OF GAMING MACHINES; SLOT MACHINES (U.S. CLS. 21, 23, 26, 36 AND 38).

KEVON CHISOLM, EXAMINING ATTORNEY

SN 77-563,566. BRATTA, VITO, DBA VAVOOM MUSIC, WEST ORANGE, NJ. FILED 9-5-2008.

WHITE LION

THE MARK CONSISTS OF STANDARD CHARACTERS WITHOUT CLAIM TO ANY PARTICULAR FONT, STYLE, SIZE, OR COLOR.

FOR SERIES OF MUSICAL SOUND RECORDINGS (U.S. CLS. 21, 23, 26, 36 AND 38).

FIRST USE 7-1-1985; IN COMMERCE 7-1-1985.

THEODORE MCBRIDE, EXAMINING ATTORNEY

CLASS 9—(Continued).

SN 77-563,588. KING SHOW GAMES INC., MINNETONKA, MN. FILED 9-5-2008.

**PLANES, TRAINS AND
AUTOMOBILES**

THE MARK CONSISTS OF STANDARD CHARACTERS WITHOUT CLAIM TO ANY PARTICULAR FONT, STYLE, SIZE, OR COLOR.

FOR GAMBLING MACHINES; GAMING DEVICES, NAMELY, GAMING MACHINES, SLOT MACHINES, BINGO MACHINES, WITH OR WITHOUT VIDEO OUTPUT; GAMING EQUIPMENT, NAMELY, SLOT MACHINES WITH OR WITHOUT VIDEO OUTPUT; GAMING MACHINES; GAMING MACHINES INCLUDING SLOT MACHINES OR VIDEO LOTTERY TERMINALS; GAMING MACHINES THAT GENERATE OR DISPLAY WAGER OUTCOMES; GAMING MACHINES, NAMELY, SLOT MACHINES AND VIDEO LOTTERY TERMINALS; GAMING MACHINES, NAMELY, DEVICES WHICH ACCEPT A WAGER; GAMING MACHINES, NAMELY, ELECTRONIC SLOT AND BINGO MACHINES; GAMING SOFTWARE THAT GENERATES OR DISPLAYS WAGER OUTCOMES OF GAMING MACHINES; SLOT MACHINES (U.S. CLS. 21, 23, 26, 36 AND 38).

KEVON CHISOLM, EXAMINING ATTORNEY

SN 77-563,661. RIGHTCHANGE.COM, INC., CONCORD, NC. FILED 9-5-2008.

RIGHT CHANGE

THE MARK CONSISTS OF STANDARD CHARACTERS WITHOUT CLAIM TO ANY PARTICULAR FONT, STYLE, SIZE, OR COLOR.

FOR DOWNLOADABLE ELECTRONIC PUBLICATIONS, NAMELY, NEWSLETTERS, IN THE FIELDS OF POLITICS, POLITICAL CAMPAIGNS, MEDIA RELATIONS, PUBLIC POLICY, NETWORKING, AND THE LEGISLATIVE PROCESS (U.S. CLS. 21, 23, 26, 36 AND 38).

TEJBIR SINGH, EXAMINING ATTORNEY

SN 77-563,731. IGT, RENO, NV. FILED 9-5-2008.

LIGHTNING RICHES

THE MARK CONSISTS OF STANDARD CHARACTERS WITHOUT CLAIM TO ANY PARTICULAR FONT, STYLE, SIZE, OR COLOR.

OWNER OF U.S. REG. NOS. 2,137,934, 3,209,563 AND OTHERS.

FOR GAMING MACHINES, NAMELY, DEVICES WHICH ACCEPT A WAGER (U.S. CLS. 21, 23, 26, 36 AND 38).

MICHELE SWAIN, EXAMINING ATTORNEY

CLASS 9—(Continued).

SN 77-563,851. FANORAMICS, GROVE, OK. FILED 9-5-2008.

CLASS 9—(Continued).

SN 77-564,044. SHENZHEN STATE MICRO TECHNOLOGY CO., LTD, SHENZHEN, CHINA, FILED 9-7-2008.

FANORAMICS

SMIT

THE MARK CONSISTS OF STANDARD CHARACTERS WITHOUT CLAIM TO ANY PARTICULAR FONT, STYLE, SIZE, OR COLOR.

FOR SPORTING EVENT ELECTRONIC NOVELTY DEVICE COMPRISED OF A LAPTOP COMPUTER, ELECTRONIC TRANSMITTER AND MULTIPLE ELECTRONIC RECEIVERS WHICH CAN LIGHT UP, FLASH, VIBRATE, AND GENERATE SOUND, BOTH LIVE AND PRERECORDED, FOR PURPOSES OF CROWD ENTERTAINMENT (U.S. CLS. 21, 23, 26, 36 AND 38).

KATHLEEN M. VANSTON, EXAMINING ATTORNEY

THE MARK CONSISTS OF SMIT.

FOR COMPUTER PERIPHERAL DEVICES; INTEGRATED CIRCUITS; INTERFACES FOR COMPUTERS; MODEMS; RECONFIGURABLE PROCESSORS FOR USE IN WIRELESS COMMUNICATION HANDSETS AND NETWORK EQUIPMENT IN THE FIELD OF WIDEBAND COMMUNICATIONS; AMUSEMENT APPARATUS ADAPTED FOR USE WITH AN EXTERNAL DISPLAY SCREEN OR MONITOR; APPARATUS FOR RECORDING, TRANSMISSION, PROCESSING AND REPRODUCTION OF SOUND, IMAGES OR DATA; ELECTRIC NAVIGATIONAL INSTRUMENTS; PORTABLE TELEPHONES (U.S. CLS. 21, 23, 26, 36 AND 38).

FIRST USE 8-6-1993; IN COMMERCE 8-26-2006.

CAROLYN GRAY, EXAMINING ATTORNEY

SN 77-563,998. B & H FOTO & ELECTRONICS CORP., NEW YORK, NY. FILED 9-6-2008.

SN 77-564,046. SHENZHEN STATE MICRO TECHNOLOGY CO., LTD, SHENZHEN, CHINA, FILED 9-7-2008.

XUMA

@SMIT

THE MARK CONSISTS OF STANDARD CHARACTERS WITHOUT CLAIM TO ANY PARTICULAR FONT, STYLE, SIZE, OR COLOR.

FOR DIGITAL PICTURE FRAMES; BATTERY CHARGERS FOR MP3 PLAYERS; POWER ADAPTERS FOR USB POWERED DEVICES; POWER ADAPTERS FOR DIGITAL PICTURE FRAMES; EARPHONES FOR AUDIO PLAYERS; AUDIO PLAYER EARPHONE REPLACEMENT SLEEVES; BATTERIES FOR MP3 PLAYERS; MP3 PLAYER REPLACEMENT BATTERY AND TOOLS THEREFOR, SOLD AS A UNIT (U.S. CLS. 21, 23, 26, 36 AND 38).

FIRST USE 10-0-2007; IN COMMERCE 10-0-2007.

DAVID HOFFMAN, EXAMINING ATTORNEY

THE MARK CONSISTS OF @SMIT.

FOR COMPUTER PERIPHERAL DEVICES; INTEGRATED CIRCUITS; INTERFACES FOR COMPUTERS; MODEMS; RECONFIGURABLE PROCESSORS FOR USE IN WIRELESS COMMUNICATION HANDSETS AND NETWORK EQUIPMENT IN THE FIELD OF WIDEBAND COMMUNICATIONS; AMUSEMENT APPARATUS ADAPTED FOR USE WITH AN EXTERNAL DISPLAY SCREEN OR MONITOR; APPARATUS FOR RECORDING, TRANSMISSION, PROCESSING AND REPRODUCTION OF SOUND, IMAGES OR DATA; ELECTRIC NAVIGATIONAL INSTRUMENTS; PORTABLE TELEPHONES (U.S. CLS. 21, 23, 26, 36 AND 38).

FIRST USE 8-6-1993; IN COMMERCE 8-26-2006.

CAROLYN GRAY, EXAMINING ATTORNEY

CLASS 9—(Continued).

SN 77-564,075. FANG BIAN, ELMHURST, NY. FILED 9-7-2008.

Audioman

THE MARK CONSISTS OF STANDARD CHARACTERS WITHOUT CLAIM TO ANY PARTICULAR FONT, STYLE, SIZE, OR COLOR.

FOR AUDIO CASSETTE AND CD PLAYERS; DIGITAL AUDIO PLAYERS; DIGITAL AUDIO TAPE PLAYERS; MP3 PLAYERS; MP4 PLAYERS; PORTABLE DVD PLAYERS; PORTABLE LISTENING DEVICES, NAMELY, MP3 PLAYERS; PORTABLE MEDIA PLAYERS; RECORD PLAYERS; RECORD PLAYERS FOR DIGITAL COMPACT DISKS (U.S. CLS. 21, 23, 26, 36 AND 38).

KARANENDRA S. CHHINA, EXAMINING ATTORNEY

SN 77-564,180. DELTA SECURITY COMPANY GROUP LIMITED, CENTRAL, HONG KONG, FILED 9-8-2008.



THE MARK CONSISTS OF A SMALL TRIANGLE WITH A POINTING ARROW FORMING A BIG TRIANGLE IN BLACK COLOUR SURROUNDED BY A ROUND CIRCLE.

FOR BLANK MAGNETIC DISKS; VIDEO TELEPHONES; AUDIO-VIDEO RECEIVERS; CAMCORDERS; ELECTRICAL INDUCTORS; AMPLIFIERS; ELECTRICAL TRANSDUCER; POWER SUPPLIES; BURGLAR ALARMS; ANTI-INTRUSION ALARMS; FIRE ALARMS; ELECTRIC BUZZERS; SMOKE DETECTORS; HOME AND OFFICE AUTOMATION SYSTEMS COMPRISING WIRELESS AND WIRED CONTROLLERS, CONTROLLED DEVICES, AND SOFTWARE FOR LIGHTING, HVAC, SECURITY, SAFETY AND OTHER HOME AND OFFICE MONITORING AND CONTROL APPLICATIONS; BLANK INTEGRATED CIRCUIT CARDS; COMPUTER HARDWARE AND SOFTWARE FOR SETTING UP AND CONFIGURING WIDE AREA NETWORKS; COMPUTER HARDWARE AND SOFTWARE FOR SETTING UP AND CONFIGURING LOCAL AREA NETWORKS; COMPUTER NETWORK ADAPTERS, SWITCHES, ROUTERS AND HUBS; COMPUTER NETWORK BRIDGES; COMPUTER HARDWARE, NAMELY, WIRELESS NETWORK REPEATERS; COMPUTER HARDWARE, NAMELY, WIRELESS NETWORK EXTENDERS; VPN (VIRTUAL PRIVATE NETWORK) HARDWARE; OPTICAL FIBRES, TELEPHONE RECEIVERS, SWITCHBOARDS, TELEPHONE AND TELEGRAPH WIRES, VIDEO TELEPHONES; DIGITAL VIDEO RECORDERS; VIDEO RECORDERS; VIDEO CAMERAS; CCTV (CLOSED CAPTION TELEVISION) (U.S. CLS. 21, 23, 26, 36 AND 38).

FIRST USE 3-15-2002; IN COMMERCE 6-30-2005.

JACQUELINE A. LAVINE, EXAMINING ATTORNEY

CLASS 9—(Continued).

SN 77-564,269. QUINTESSENCE PUBLISHING COMPANY, INC., HANOVER PARK, IL. FILED 9-8-2008.

QUINTESSENCE

THE MARK CONSISTS OF STANDARD CHARACTERS WITHOUT CLAIM TO ANY PARTICULAR FONT, STYLE, SIZE, OR COLOR.

OWNER OF U.S. REG. NOS. 1,739,770 AND 1,741,261. FOR DVDS FEATURING INFORMATION ABOUT DENTISTRY (U.S. CLS. 21, 23, 26, 36 AND 38).

DAVON HATCHETT, EXAMINING ATTORNEY

SN 77-564,308. HOWARD HUGHES MEDICAL INSTITUTE, CHEVY CHASE, MD. FILED 9-8-2008.

HMMER

THE MARK CONSISTS OF STANDARD CHARACTERS WITHOUT CLAIM TO ANY PARTICULAR FONT, STYLE, SIZE, OR COLOR.

FOR COMPUTER SOFTWARE FOR SEARCHING AND ANALYZING BIOLOGICAL PROTEIN AND DNA SEQUENCES; DOWNLOADABLE COMPUTER SOFTWARE FOR SEARCHING AND ANALYZING BIOLOGICAL PROTEIN AND DNA SEQUENCES (U.S. CLS. 21, 23, 26, 36 AND 38).

FIRST USE 4-17-1995; IN COMMERCE 4-17-1995.

RAMONA ORTIGA, EXAMINING ATTORNEY

SN 77-564,404. FRESH, LLC, BRENTWOOD, TN. FILED 9-8-2008.

Digital 45

THE MARK CONSISTS OF STANDARD CHARACTERS WITHOUT CLAIM TO ANY PARTICULAR FONT, STYLE, SIZE, OR COLOR.

NO CLAIM IS MADE TO THE EXCLUSIVE RIGHT TO USE "DIGITAL", APART FROM THE MARK AS SHOWN.

FOR DIGITAL MEDIA, NAMELY, PRE-RECORDED VIDEO CASSETTES, DIGITAL VIDEO DISCS, DIGITAL VERSATILE DISCS, DOWNLOADABLE AUDIO AND VIDEO RECORDINGS, DVDS, AND HIGH DEFINITION DIGITAL DISKS FEATURING SOUND RECORDINGS, A MUSIC VIDEO PLAYABLE ON DVD PLAYERS AND PORTABLE MP3 PLAYERS, ELECTRONIC PRESS KIT AND ARTIST PHOTOGRAPHS AND ALBUM ARTWORK (U.S. CLS. 21, 23, 26, 36 AND 38).

DAVID MILLER, EXAMINING ATTORNEY

CLASS 9—(Continued).

SN 77-564,428. M. BILT ENTERPRISES, INC., DBA WELL BILT INDUSTRIES, WILLISTON, FL. FILED 9-8-2008.

HERCUL EZE

THE MARK CONSISTS OF STANDARD CHARACTERS WITHOUT CLAIM TO ANY PARTICULAR FONT, STYLE, SIZE, OR COLOR.
FOR ELECTRIC DOOR OPENERS AND CLOSERS (U.S. CLS. 21, 23, 26, 36 AND 38).
FIRST USE 1-3-2006; IN COMMERCE 1-3-2006.
ELIZABETH KAJUBI, EXAMINING ATTORNEY

CLASS 9—(Continued).

SN 77-564,642. 15TH STREET DISTRIBUTORS, INC., MIAMI, FL. FILED 9-8-2008.

IHNK - I HAVE NO KING

THE MARK CONSISTS OF STANDARD CHARACTERS WITHOUT CLAIM TO ANY PARTICULAR FONT, STYLE, SIZE, OR COLOR.
FOR SUNGLASSES (U.S. CLS. 21, 23, 26, 36 AND 38).
BRENDAN MCCAULEY, EXAMINING ATTORNEY

SN 77-564,436. OLDFIELD TUBE AMPLIFICATION, LLC, CHARLOTTE, NC. FILED 9-8-2008.

OLDFIELD

THE MARK CONSISTS OF THE STYLIZED TEXT "OLDFIELD", WITH A HORIZONTAL BAR UNDER "LDFIELD".
FOR CUSTOM VACUUM TUBE GUITAR AMPLIFIERS (U.S. CLS. 21, 23, 26, 36 AND 38).
FIRST USE 1-1-2005; IN COMMERCE 1-1-2005.
ANNE E. GUSTASON, EXAMINING ATTORNEY

SN 77-564,644. SPECIALTY AUTO PARTS U.S.A., INC., WARREN, MI. FILED 9-8-2008.

PERFECT LAUNCH

THE MARK CONSISTS OF STANDARD CHARACTERS WITHOUT CLAIM TO ANY PARTICULAR FONT, STYLE, SIZE, OR COLOR.
FOR ELECTRONIC TIMERS; ELECTRONIC TIMERS FOR PRACTICING AND IMPROVING REACTION TIMES AND START TIMES FOR COMPETITIVE RACES (U.S. CLS. 21, 23, 26, 36 AND 38).
BILL DAWE, EXAMINING ATTORNEY

SN 77-564,542. STRATEGIC SYSTEMS & TECHNOLOGY CORP., ALPHARETTA, GA. FILED 9-8-2008.

HIGHGROUND

THE MARK CONSISTS OF STANDARD CHARACTERS WITHOUT CLAIM TO ANY PARTICULAR FONT, STYLE, SIZE, OR COLOR.
FOR COMPUTER SOFTWARE FOR WORK ORDER MANAGEMENT RELATING TO FACILITIES PROJECTS, REPAIRS, FIELD SERVICE, AND PREVENTATIVE MAINTENANCE (U.S. CLS. 21, 23, 26, 36 AND 38).
SIMON TENG, EXAMINING ATTORNEY

SN 77-564,716. THE FONT BUREAU, INC., BOSTON, MA. FILED 9-8-2008.

DISPATCH

THE MARK CONSISTS OF STANDARD CHARACTERS WITHOUT CLAIM TO ANY PARTICULAR FONT, STYLE, SIZE, OR COLOR.
FOR PRINTING FONTS THAT CAN BE DOWNLOADED PROVIDED BY MEANS OF ELECTRONIC TRANSMISSION; TYPEFACE FONTS RECORDED ON MAGNETIC MEDIA (U.S. CLS. 21, 23, 26, 36 AND 38).
FIRST USE 3-15-1993; IN COMMERCE 3-15-1993.
LINDA M. KING, EXAMINING ATTORNEY

CLASS 9—(Continued).

SN 77-564,764. THOMPSON ENVIRONMENTAL MONITORING AND CONTROL, LLC, MELBOURNE, FL. FILED 9-8-2008.

RANGER

THE MARK CONSISTS OF STANDARD CHARACTERS WITHOUT CLAIM TO ANY PARTICULAR FONT, STYLE, SIZE, OR COLOR.

FOR AUTOMATED PROCESS CONTROL SYSTEM, NAMELY, MICRO-PROCESSOR BASED HARDWARE AND SOFTWARE USED TO MONITOR THE STATUS OF INDUSTRIAL MACHINERY, NAMELY, TURBINES, GENERATORS AND COMPRESSORS; AUTOMATED PROCESS CONTROL SYSTEM, NAMELY, MICRO-PROCESSOR BASED HARDWARE AND SOFTWARE USED TO MONITOR THE STATUS OF INDUSTRIAL PROCESSES, NAMELY, POWER GENERATION, ELECTRICAL DISTRIBUTION AND OIL AND GAS PROCESSING; COMPUTER HARDWARE AND SOFTWARE SYSTEM FOR REMOTELY MONITORING ENVIRONMENTAL CONDITIONS AND CONTROLLING DEVICES WITHIN A BUILDING, FACILITY, GROUNDS, OR DESIGNATED SPATIAL AREA; ELECTRONIC APPARATUS FOR THE REMOTE CONTROL OF INDUSTRIAL OPERATIONS (U.S. CLS. 21, 23, 26, 36 AND 38).

FIRST USE 1-1-2008; IN COMMERCE 4-1-2008.

KATHERINE E. HALMEN, EXAMINING ATTORNEY

SN 77-564,773. MODEL METRICS, LLC, CHICAGO, IL. FILED 9-8-2008.

EXPENSE2GO

THE MARK CONSISTS OF STANDARD CHARACTERS WITHOUT CLAIM TO ANY PARTICULAR FONT, STYLE, SIZE, OR COLOR.

FOR COMPUTER SOFTWARE APPLICATION, NAMELY, EXPENSE REPORTING AND MANAGEMENT APPLICATION FOR HAND HELD DEVICES (U.S. CLS. 21, 23, 26, 36 AND 38).

FIRST USE 7-1-2008; IN COMMERCE 7-1-2008.

GINA HAYES, EXAMINING ATTORNEY

SN 77-564,782. EXAMSOFT WORLDWIDE, INC., DEERFIELD BEACH, FL. FILED 9-8-2008.

KNOX-IT

THE MARK CONSISTS OF STANDARD CHARACTERS WITHOUT CLAIM TO ANY PARTICULAR FONT, STYLE, SIZE, OR COLOR.

FOR USB (UNIVERSAL SERIAL BUS) OPERATING SOFTWARE (U.S. CLS. 21, 23, 26, 36 AND 38).

MARCIE MILONE, EXAMINING ATTORNEY

CLASS 9—(Continued).

SN 77-564,822. THE FONT BUREAU, INC., BOSTON, MA. FILED 9-8-2008.

ECRU

THE MARK CONSISTS OF STANDARD CHARACTERS WITHOUT CLAIM TO ANY PARTICULAR FONT, STYLE, SIZE, OR COLOR.

THE FOREIGN WORDING IN THE MARK TRANSLATES INTO ENGLISH AS UNBLEACHED FROM FRENCH.

FOR PRINTING FONTS THAT CAN BE DOWNLOADED PROVIDED BY MEANS OF ELECTRONIC TRANSMISSION; TYPEFACE FONTS RECORDED ON MAGNETIC MEDIA (U.S. CLS. 21, 23, 26, 36 AND 38).

FIRST USE 3-15-1993; IN COMMERCE 3-15-1993.

LINDA M. KING, EXAMINING ATTORNEY

SN 77-564,861. THE FONT BUREAU, INC., BOSTON, MA. AND CARBAGA, LESLIE, BOSTON, MA. FILED 9-8-2008.

GRAFFITI

THE MARK CONSISTS OF STANDARD CHARACTERS WITHOUT CLAIM TO ANY PARTICULAR FONT, STYLE, SIZE, OR COLOR.

SEC. 2(F).

FOR PRINTING FONTS THAT CAN BE DOWNLOADED PROVIDED BY MEANS OF ELECTRONIC TRANSMISSION; TYPEFACE FONTS RECORDED ON MAGNETIC MEDIA (U.S. CLS. 21, 23, 26, 36 AND 38).

FIRST USE 2-15-1992; IN COMMERCE 2-15-1992.

LINDA M. KING, EXAMINING ATTORNEY

SN 77-564,882. THE FONT BUREAU, INC., BOSTON, MA. AND CABARGA, LESLIE, BOSTON, MA. FILED 9-8-2008.

NEON STREAM

THE MARK CONSISTS OF STANDARD CHARACTERS WITHOUT CLAIM TO ANY PARTICULAR FONT, STYLE, SIZE, OR COLOR.

FOR PRINTING FONTS THAT CAN BE DOWNLOADED PROVIDED BY MEANS OF ELECTRONIC TRANSMISSION; TYPEFACE FONTS RECORDED ON MAGNETIC MEDIA (U.S. CLS. 21, 23, 26, 36 AND 38).

FIRST USE 2-15-1995; IN COMMERCE 2-15-1995.

LINDA M. KING, EXAMINING ATTORNEY

CLASS 9—(Continued).

SN 77-564,919. INCREDIMAIL LTD., TEL AVIV, ISRAEL, FILED 9-8-2008.

PHOTOJOY

THE MARK CONSISTS OF STANDARD CHARACTERS WITHOUT CLAIM TO ANY PARTICULAR FONT, STYLE, SIZE, OR COLOR.

FOR DOWNLOADABLE SOFTWARE FOR DISPLAY OF PHOTOS AND IMAGES IN TWO OR THREE DIMENSIONS WITH THE POSSIBILITY OF ADDING SPECIAL FORMATS, DESIGNS OR VISUAL EFFECTS TO SUCH DISPLAYS, USED MAINLY FOR DESIGNING OF COMPUTER SCREEN WALLPAPERS, SCREEN COLLAGES AND SCREENSAVERS (U.S. CLS. 21, 23, 26, 36 AND 38).
AMY C. KEAN, EXAMINING ATTORNEY

SN 77-564,932. TONELUX DESIGNS, LIMITED, WOODBRIDGE, VA. FILED 9-8-2008.

EQUALUX

THE MARK CONSISTS OF STANDARD CHARACTERS WITHOUT CLAIM TO ANY PARTICULAR FONT, STYLE, SIZE, OR COLOR.

FOR AUDIO AMPLIFIERS; AUDIO ELECTRONIC COMPONENTS, NAMELY, SURROUND SOUND SYSTEMS; AUDIO MIXERS; AUDIO PROCESSING EQUIPMENT, NAMELY, LIMITERS AND COMPRESSORS (U.S. CLS. 21, 23, 26, 36 AND 38).
GINA HAYES, EXAMINING ATTORNEY

SN 77-564,936. TONELUX DESIGNS, LIMITED, WOODBRIDGE, VA. FILED 9-8-2008.

DYNALUX

THE MARK CONSISTS OF STANDARD CHARACTERS WITHOUT CLAIM TO ANY PARTICULAR FONT, STYLE, SIZE, OR COLOR.

FOR AUDIO AMPLIFIERS; AUDIO ELECTRONIC COMPONENTS, NAMELY, SURROUND SOUND SYSTEMS; AUDIO MIXERS; AUDIO PROCESSING EQUIPMENT, NAMELY, LIMITERS AND COMPRESSORS (U.S. CLS. 21, 23, 26, 36 AND 38).
GINA HAYES, EXAMINING ATTORNEY

CLASS 9—(Continued).

SN 77-564,964. KING SHOW GAMES INC., MINNETONKA, MN. FILED 9-8-2008.



NO CLAIM IS MADE TO THE EXCLUSIVE RIGHT TO USE "AMERICAN", APART FROM THE MARK AS SHOWN. THE MARK CONSISTS OF HEARTS WITH A UNITED STATES FLAG DESIGN ON A FIELD OF STRIPES AND STARS.

FOR GAMBLING MACHINES; GAMING DEVICES, NAMELY, GAMING MACHINES, SLOT MACHINES, BINGO MACHINES, WITH OR WITHOUT VIDEO OUTPUT; GAMING EQUIPMENT, NAMELY, SLOT MACHINES WITH OR WITHOUT VIDEO OUTPUT; GAMING MACHINES; GAMING MACHINES INCLUDING SLOT MACHINES OR VIDEO LOTTERY TERMINALS; GAMING MACHINES THAT GENERATE OR DISPLAY WAGER OUTCOMES; GAMING MACHINES, NAMELY SLOT MACHINES AND VIDEO LOTTERY TERMINALS; GAMING MACHINES, NAMELY, DEVICES WHICH ACCEPT A WAGER; GAMING MACHINES, NAMELY, ELECTRONIC SLOT AND BINGO MACHINES; GAMING SOFTWARE THAT GENERATES OR DISPLAYS WAGER OUTCOMES OF GAMING MACHINES; SLOT MACHINES (U.S. CLS. 21, 23, 26, 36 AND 38).

KEVON CHISOLM, EXAMINING ATTORNEY

SN 77-564,974. THE FONT BUREAU, INC., BOSTON, MA. AND CABARGA, LESLIE, BOSTON, MA. FILED 9-8-2008.

BADTYP

THE MARK CONSISTS OF STANDARD CHARACTERS WITHOUT CLAIM TO ANY PARTICULAR FONT, STYLE, SIZE, OR COLOR.

SEC. 2(F).
FOR PRINTING FONTS THAT CAN BE DOWNLOADED PROVIDED BY MEANS OF ELECTRONIC TRANSMISSION; TYPEFACE FONTS RECORDED ON MAGNETIC MEDIA (U.S. CLS. 21, 23, 26, 36 AND 38).
FIRST USE 3-15-1993; IN COMMERCE 3-15-1993.
LINDA M. KING, EXAMINING ATTORNEY

CLASS 9—(Continued).

SN 77-564,976. TNS INTERNATIONAL CORP., MIAMI, FL.
FILED 9-8-2008.



OWNER OF U.S. REG. NOS. 3,357,258 AND 3,466,347.
THE COLOR(S) BLUE AND ORANGE IS/ARE CLAIMED
AS A FEATURE OF THE MARK.

THE MARK CONSISTS OF AN ABSTRACT TRIANGLE FORMED FROM GEOMETRIC FIGURES AND THE WORD "LUXO" APPEARING IN BLUE LETTERS BELOW THE ABSTRACT TRIANGLE. THE COLOR BLUE APPEARS ON THE WORD "LUXO" AND THE ABSTRACT OVAL AND POLYGON IN THE LARGER TRIANGLE, AND THE COLOR ORANGE APPEARS IN THE CENTER OF THE LETTER "O" IN THE WORD "LUXO" AND IN THE ABSTRACT TRIANGLE WHICH IS PART OF THE LARGER TRIANGLE.

THE FOREIGN WORDING IN THE MARK TRANSLATES INTO ENGLISH AS "LUXURY"

FOR HOLSTER FOR CARRYING MOBILE PHONES, PAGERS AND PERSONAL DIGITAL ASSISTANTS; CARRYING CASES FOR MOBILE PHONES; ACCESSORIES FOR MOBILE PHONES, NAMELY, NECK STRAPS, HAND STRAPS AND LANYARDS; CARRYING BAGS AND CASES, NAMELY, BAGS AND CASES FOR CARRYING CAMERAS, CELL PHONES, LAPTOPS, GAME CONSOLE, PAGERS, MUSIC DEVICES, NAMELY, MP3 AND MP4 PLAYERS (U.S. CLS. 21, 23, 26, 36 AND 38).

FIRST USE 4-30-2007; IN COMMERCE 4-30-2007.

JOHN WILKE, EXAMINING ATTORNEY

SN 77-565,121. ROSUM CORPORATION, MOUNTAIN VIEW,
CA. FILED 9-8-2008.

FEMTOSYNCH

THE MARK CONSISTS OF STANDARD CHARACTERS WITHOUT CLAIM TO ANY PARTICULAR FONT, STYLE, SIZE, OR COLOR.

FOR COMPUTER HARDWARE AND SOFTWARE FOR ESTABLISHING POSITION AND TIME BASED ON RECEIVED WIRELESS TELEVISION SIGNALS (U.S. CLS. 21, 23, 26, 36 AND 38).

SUSAN STIGLITZ, EXAMINING ATTORNEY

CLASS 9—(Continued).

SN 77-565,245. DEM SOLUTIONS LTD., EDINBURGH,
SCOTLAND, FILED 9-9-2008.

EDEM EDEM EDEM

THE MARK CONSISTS OF STANDARD CHARACTERS WITHOUT CLAIM TO ANY PARTICULAR FONT, STYLE, SIZE, OR COLOR.

OWNER OF ENGLAND REG. NO. 2399747, DATED 5-12-2006, EXPIRES 8-19-2015.

FOR COMPUTER SOFTWARE FOR SIMULATION, ANALYSIS AND VIZUALIZATION OF PARTICULATE FLOWS PROVIDING HIGH-RESOLUTION INFORMATION ON PARTICLE KINEMATICS, MOMENTUM, HEAT AND MASS TRANSFER (U.S. CLS. 21, 23, 26, 36 AND 38).

SUSAN STIGLITZ, EXAMINING ATTORNEY

SN 77-565,304. TRANSPARENT LANGUAGE, INC., NA-
SHUA, NH. FILED 9-9-2008.



THE MARK CONSISTS OF THE WORD "BYKI" WITH A STYLIZED "I".

FOR EDUCATIONAL SOFTWARE FEATURING INSTRUCTION IN FOREIGN LANGUAGES (U.S. CLS. 21, 23, 26, 36 AND 38).

FIRST USE 9-4-2008; IN COMMERCE 9-4-2008.

SUSAN STIGLITZ, EXAMINING ATTORNEY

SN 77-565,348. N.F. STRING & SON, INC., HARRISBURG,
PA. FILED 9-9-2008.

DREAM CHANGER

THE MARK CONSISTS OF STANDARD CHARACTERS WITHOUT CLAIM TO ANY PARTICULAR FONT, STYLE, SIZE, OR COLOR.

NO CLAIM IS MADE TO THE EXCLUSIVE RIGHT TO USE "CHANGER", APART FROM THE MARK AS SHOWN.

FOR SELF-SERVICE COIN PROCESSING MACHINES THAT RECEIVE LOOSE COINS AND GENERATE A RECEIPT REDEEMABLE FOR CASH (U.S. CLS. 21, 23, 26, 36 AND 38).

REBECCA SMITH, EXAMINING ATTORNEY

CLASS 9—(Continued).

SN 77-565,446. MODEL METRICS, LLC, CHICAGO, IL. FILED 9-9-2008.

SEARCH2GO

THE MARK CONSISTS OF STANDARD CHARACTERS WITHOUT CLAIM TO ANY PARTICULAR FONT, STYLE, SIZE, OR COLOR.

FOR COMPUTER SOFTWARE APPLICATION, NAMELY, AN APPLICATION THAT ENABLES USERS OF HAND HELD DEVICES TO SEARCH DATABASES (U.S. CLS. 21, 23, 26, 36 AND 38).

GINA HAYES, EXAMINING ATTORNEY

CLASS 9—(Continued).

SN 77-565,613. NAVICO, INC., TULSA, OK. FILED 9-9-2008.

INSIGHT USA

THE MARK CONSISTS OF STANDARD CHARACTERS WITHOUT CLAIM TO ANY PARTICULAR FONT, STYLE, SIZE, OR COLOR.

NO CLAIM IS MADE TO THE EXCLUSIVE RIGHT TO USE "USA", APART FROM THE MARK AS SHOWN.

FOR COMPUTER SOFTWARE FOR USE IN GLOBAL POSITIONING (GPS) AND MAPPING SYSTEMS THAT OPERATE UPON INFORMATION RECEIVED FROM SATELLITES IN ORBIT AROUND THE EARTH, LAND-BASED TRANSMITTERS, AND DATA MEDIA (U.S. CLS. 21, 23, 26, 36 AND 38).

JOHN WILKE, EXAMINING ATTORNEY

SN 77-565,456. MODEL METRICS, LLC, CHICAGO, IL. FILED 9-9-2008.

LEAD2GO

THE MARK CONSISTS OF STANDARD CHARACTERS WITHOUT CLAIM TO ANY PARTICULAR FONT, STYLE, SIZE, OR COLOR.

FOR COMPUTER SOFTWARE APPLICATION, NAMELY, AN APPLICATION THAT PERMITS USERS OF HAND HELD DEVICES TO TRANSFER CERTAIN INFORMATION INTO AN ELECTRONIC FORM (U.S. CLS. 21, 23, 26, 36 AND 38).

GINA HAYES, EXAMINING ATTORNEY

SN 77-565,629. NAVICO, INC., TULSA, OK. FILED 9-9-2008.

LAKE INSIGHT

THE MARK CONSISTS OF STANDARD CHARACTERS WITHOUT CLAIM TO ANY PARTICULAR FONT, STYLE, SIZE, OR COLOR.

FOR COMPUTER SOFTWARE FOR USE IN GLOBAL POSITIONING (GPS) AND MAPPING SYSTEMS THAT OPERATE UPON INFORMATION RECEIVED FROM SATELLITES IN ORBIT AROUND THE EARTH, LAND-BASED TRANSMITTERS, AND DATA MEDIA (U.S. CLS. 21, 23, 26, 36 AND 38).

JOHN WILKE, EXAMINING ATTORNEY

SN 77-565,461. MODEL METRICS, LLC, CHICAGO, IL. FILED 9-9-2008.

DITTO2GO

THE MARK CONSISTS OF STANDARD CHARACTERS WITHOUT CLAIM TO ANY PARTICULAR FONT, STYLE, SIZE, OR COLOR.

FOR COMPUTER SOFTWARE APPLICATION, NAMELY, AN APPLICATION THAT PERMITS USERS OF HAND HELD DEVICES TO TRANSFER INFORMATION INTO AN ELECTRONIC FORM (U.S. CLS. 21, 23, 26, 36 AND 38).

GINA HAYES, EXAMINING ATTORNEY

SN 77-565,638. NAVICO, INC., TULSA, OK. FILED 9-9-2008.

NAUTIC INSIGHT

THE MARK CONSISTS OF STANDARD CHARACTERS WITHOUT CLAIM TO ANY PARTICULAR FONT, STYLE, SIZE, OR COLOR.

FOR COMPUTER SOFTWARE FOR USE IN GLOBAL POSITIONING (GPS) AND MAPPING SYSTEMS THAT OPERATE UPON INFORMATION RECEIVED FROM SATELLITES IN ORBIT AROUND THE EARTH, LAND-BASED TRANSMITTERS, AND DATA MEDIA (U.S. CLS. 21, 23, 26, 36 AND 38).

JOHN WILKE, EXAMINING ATTORNEY

CLASS 9—(Continued).

SN 77-565,736. THERMO FISHER SCIENTIFIC (ASHEVILLE) LLC, ASHEVILLE, NC. FILED 9-9-2008.

CONTAINMENT · COMFORT · CONVENIENCE

THE MARK CONSISTS OF THE WORDS "CONTAINMENT", "COMFORT" AND "CONVENIENCE" SEPARATED BY DOTS.

FOR RESEARCH, LABORATORY, AND PHARMACEUTICAL PRODUCTION EQUIPMENT, NAMELY, BIOLOGICAL SAFETY CABINETS AND CLEAN BENCHES (U.S. CLS. 21, 23, 26, 36 AND 38).

REBECCA SMITH, EXAMINING ATTORNEY

SN 77-565,771. JASON JACOBSON, DBA MURDER 4 HIRE, CHICAGO, IL. FILED 9-9-2008.

MURDER 4 HIRE

THE MARK CONSISTS OF STANDARD CHARACTERS WITHOUT CLAIM TO ANY PARTICULAR FONT, STYLE, SIZE, OR COLOR.

FOR AUDIO AND VIDEO RECORDINGS FEATURING MUSIC (U.S. CLS. 21, 23, 26, 36 AND 38).

FIRST USE 3-31-2007; IN COMMERCE 3-31-2007.

KARANENDRA S. CHHINA, EXAMINING ATTORNEY

SN 77-565,819. LITERACY PARTNERS, NEW YORK, NY. FILED 9-9-2008.

**EVERYONE DESERVES A CHANCE
TO READ.**

THE MARK CONSISTS OF STANDARD CHARACTERS WITHOUT CLAIM TO ANY PARTICULAR FONT, STYLE, SIZE, OR COLOR.

FOR PRE-RECORDED VIDEO CASSETTES, CD-ROMS, DVDS, AND AUDIO CASSETTES FEATURING INFORMATION ON LITERACY, ADULT EDUCATION, READING, WRITING, MATH, SOCIAL STUDIES, SCIENCE, FINANCIAL AND HEALTH LITERACY, EMPLOYMENT PREPARATION, GED EXAM PREPARATION, ENGLISH FOR SPEAKERS OF OTHER LANGUAGES, AND FAMILY LITERACY; DOWNLOADABLE ELECTRONIC PUBLICATIONS IN THE NATURE OF NEWSLETTERS, PAMPHLETS, BROCHURES, WORKBOOKS AND TEACHING MATERIALS IN THE FIELD OF LITERACY, ADULT EDUCATION, READING, WRITING, MATH, SOCIAL STUDIES, SCIENCE, FINANCIAL AND HEALTH LITERACY, EMPLOYMENT PREPARATION, GED EXAM PREPARATION, ENGLISH FOR SPEAKERS OF OTHER LANGUAGES, AND FAMILY LITERACY (U.S. CLS. 21, 23, 26, 36 AND 38).

CHERYL CLAYTON, EXAMINING ATTORNEY

CLASS 9—(Continued).

SN 77-565,883. GAIAM AMERICAS, INC., LOUISVILLE, CO. FILED 9-9-2008.

SHORT CUTS

THE MARK CONSISTS OF STANDARD CHARACTERS WITHOUT CLAIM TO ANY PARTICULAR FONT, STYLE, SIZE, OR COLOR.

FOR DIGITAL MATERIALS, NAMELY, DVDS, CDS, MP3 RECORDINGS, DOWNLOADABLE AUDIO FILES, AND DOWNLOADABLE AUDIO-VISUAL FILES FEATURING EXERCISE AND FITNESS INSTRUCTION (U.S. CLS. 21, 23, 26, 36 AND 38).

ANGELA M. MICHELI, EXAMINING ATTORNEY

SN 77-565,922. SNIPITRON, LLC, CHICAGO, IL. FILED 9-9-2008.

cubeSYNC

THE MARK CONSISTS OF STANDARD CHARACTERS WITHOUT CLAIM TO ANY PARTICULAR FONT, STYLE, SIZE, OR COLOR.

FOR COMPUTER SOFTWARE FOR THE COLLECTION, EDITING, ORGANIZING, MODIFYING, BOOK MARKING, TRANSMISSION, STORAGE AND SHARING OF DATA AND INFORMATION (U.S. CLS. 21, 23, 26, 36 AND 38).

SANDRA MANIOS, EXAMINING ATTORNEY

SN 77-565,939. CAMBRIA COVE LLC, TOPKEA, KS. FILED 9-9-2008.

CAMBRIA COVE

THE MARK CONSISTS OF STANDARD CHARACTERS WITHOUT CLAIM TO ANY PARTICULAR FONT, STYLE, SIZE, OR COLOR.

FOR DIGITAL PHOTO FRAMES FOR DISPLAYING DIGITAL PICTURES, VIDEO CLIPS AND MUSIC; LAPTOP PROTECTIVE SLEEVES; BATTERY CHARGING STATIONS FOR OFFICE ELECTRONICS; COMPUTER STORAGE DEVICES, NAMELY, FLASH DRIVES (U.S. CLS. 21, 23, 26, 36 AND 38).

ANGELA M. MICHELI, EXAMINING ATTORNEY

CLASS 9—(Continued).

SN 77-565,977. GAIAM AMERICAS, INC., LOUISVILLE, CO. FILED 9-9-2008.

WALK AWAY THE POUNDS

THE MARK CONSISTS OF STANDARD CHARACTERS WITHOUT CLAIM TO ANY PARTICULAR FONT, STYLE, SIZE, OR COLOR.

OWNER OF U.S. REG. NOS. 2,618,871, 2,872,069 AND 3,080,081.

FOR DIGITAL MATERIALS, NAMELY, DVDS, FEATURING EXERCISE AND FITNESS INSTRUCTION (U.S. CLS. 21, 23, 26, 36 AND 38).

FIRST USE 3-0-2001; IN COMMERCE 3-0-2001.

ANGELA M. MICHELI, EXAMINING ATTORNEY

SN 77-566,004. LIBERTY SPORT, INC., FAIRFIELD, NJ. FILED 9-9-2008.

MIL

THE MARK CONSISTS OF STANDARD CHARACTERS WITHOUT CLAIM TO ANY PARTICULAR FONT, STYLE, SIZE, OR COLOR.

FOR INTERCHANGEABLE LENSES FOR EYEGLASSES, SUNGLASSES, READING GLASSES, CLIP-ON SUNGLASSES, GOGGLES FOR SPORTS AND SAFETY GOGGLES; SPECIFICALLY DESIGNED FRAMES FOR EYEGLASSES, SUNGLASSES, READING GLASSES, CLIP-ON SUNGLASSES, GOGGLES FOR SPORTS AND SAFETY GOGGLES DESIGNED TO FIT INTERCHANGEABLE LENSES; CASES FOR AFOREMENTIONED LENSES AND FRAMES (U.S. CLS. 21, 23, 26, 36 AND 38).

JOHN DWYER, EXAMINING ATTORNEY

SN 77-566,014. LIBERTY SPORT, INC., FAIRFIELD, NJ. FILED 9-9-2008.

MILS

THE MARK CONSISTS OF STANDARD CHARACTERS WITHOUT CLAIM TO ANY PARTICULAR FONT, STYLE, SIZE, OR COLOR.

FOR INTERCHANGEABLE LENSES FOR EYEGLASSES, SUNGLASSES, READING GLASSES, CLIP-ON SUNGLASSES, GOGGLES FOR SPORTS AND SAFETY GOGGLES; SPECIFICALLY DESIGNED FRAMES FOR EYEGLASSES, SUNGLASSES, READING GLASSES, CLIP-ON SUNGLASSES, GOGGLES FOR SPORTS AND SAFETY GOGGLES DESIGNED TO FIT INTERCHANGEABLE LENSES; CASES FOR AFOREMENTIONED LENSES AND FRAMES (U.S. CLS. 21, 23, 26, 36 AND 38).

JOHN DWYER, EXAMINING ATTORNEY

CLASS 9—(Continued).

SN 77-566,040. RELIASOFT CORPORATION, TUCSON, AZ. FILED 9-9-2008.

DOE++

THE MARK CONSISTS OF STANDARD CHARACTERS WITHOUT CLAIM TO ANY PARTICULAR FONT, STYLE, SIZE, OR COLOR.

FOR COMPUTER SOFTWARE FOR DESIGN OF EXPERIMENTS (DOE), NAMELY, FOR USE IN FACILITATING TRADITIONAL DESIGN OF EXPERIMENTS (DOE) TECHNIQUES FOR STUDYING THE FACTORS THAT MAY AFFECT A PRODUCT OR PROCESS IN ORDER TO IDENTIFY SIGNIFICANT FACTORS AND OPTIMIZE DESIGNS, AS WELL AS SUPPORT FOR RELIABILITY DOE, WHICH PROVIDES THE PROPER TREATMENT FOR INTERVAL AND RIGHT CENSORED DATA (U.S. CLS. 21, 23, 26, 36 AND 38).

FIRST USE 7-0-2002; IN COMMERCE 3-0-2008.

SANDRA MANIOS, EXAMINING ATTORNEY

SN 77-566,122. HELEN OF TROY LIMITED, ST. MICHAEL, BARBADOS, FILED 9-9-2008.

Caruso

THE MARK CONSISTS OF STANDARD CHARACTERS WITHOUT CLAIM TO ANY PARTICULAR FONT, STYLE, SIZE, OR COLOR.

OWNER OF U.S. REG. NO. 2,435,545. SEC. 2(F). FOR ELECTRIC HAIR CURLERS (U.S. CLS. 21, 23, 26, 36 AND 38).

FIRST USE 6-0-1997; IN COMMERCE 6-0-1997.

CHERYL CLAYTON, EXAMINING ATTORNEY

SN 77-566,218. TSUREN LLC, VORHEES, NJ. FILED 9-10-2008.

DENAQ

THE MARK CONSISTS OF STANDARD CHARACTERS WITHOUT CLAIM TO ANY PARTICULAR FONT, STYLE, SIZE, OR COLOR.

FOR ACCUMULATORS; ACCUMULATORS AND BATTERIES; ADAPTERS; BATTERIES; BATTERIES AND BATTERY CHARGERS; BATTERIES, ELECTRIC; BATTERY CHARGERS; ELECTRIC ACCUMULATORS; ELECTRIC BATTERIES; POWER SUPPLIES; POWER SUPPLY CONNECTORS AND ADAPTORS FOR USE WITH PORTABLE ELECTRONIC DEVICES; RECHARGEABLE ELECTRIC BATTERIES; RECHARGERS FOR ELECTRIC ACCUMULATORS (U.S. CLS. 21, 23, 26, 36 AND 38).

FIRST USE 9-2-2008; IN COMMERCE 9-2-2008.

ANGELA M. MICHELI, EXAMINING ATTORNEY

CLASS 9—(Continued).

SN 77-566,331. LITERACY PARTNERS, NEW YORK, NY. FILED 9-10-2008.



THE MARK CONSISTS OF THE IMAGE OF SIX HANDS REACHING UPWARD TOWARD AN OPEN BOOK.

FOR PRE-RECORDED VIDEO CASSETTES, CD-ROMS, DVDS, AND AUDIO CASSETTES FEATURING INFORMATION ON LITERACY, ADULT EDUCATION, READING, WRITING, MATH, SOCIAL STUDIES, SCIENCE, FINANCIAL AND HEALTH LITERACY, EMPLOYMENT PREPARATION, GED EXAM PREPARATION, ENGLISH FOR SPEAKERS OF OTHER LANGUAGES, AND FAMILY LITERACY; DOWNLOADABLE ELECTRONIC PUBLICATIONS IN THE NATURE OF NEWSLETTERS, PAMPHLETS, BROCHURES, WORKBOOKS AND TEACHING MATERIALS IN THE FIELD OF LITERACY, ADULT EDUCATION, READING, WRITING, MATH, SOCIAL STUDIES, SCIENCE, FINANCIAL AND HEALTH LITERACY, EMPLOYMENT PREPARATION, GED EXAM PREPARATION, ENGLISH FOR SPEAKERS OF OTHER LANGUAGES, AND FAMILY LITERACY (U.S. CLS. 21, 23, 26, 36 AND 38).

CHERYL CLAYTON, EXAMINING ATTORNEY

SN 77-566,538. VEHICLE TRACKING SOLUTIONS, LLC, DEER PARK, NY. FILED 9-10-2008.



THE MARK CONSISTS OF THE WORDS "SILENT PASSENGER" IN BOLD LETTERS WITH A BLACK FILLED IN SWIRL UNDER THE WORD "PASSENGER" WITH SEVEN WHITE DASHES SPACED EVENLY IN THE SWIRL.

FOR COMPUTER SOFTWARE FOR VEHICLE FLEET MANAGEMENT USING GPS (GLOBAL POSITIONING SYSTEM) TECHNOLOGY TO COLLECT, STORE AND DISPLAY VEHICLE EVENTS TO INCLUDE ENGINE AND ACCESSORY STATUS, SPEED, LOCATION AND STOPS IN REAL TIME (U.S. CLS. 21, 23, 26, 36 AND 38).

MARY ROSSMAN, EXAMINING ATTORNEY

CLASS 9—(Continued).

SN 77-566,594. CHICAGO DIGITAL POWER, INC., ELK GROVE VILLAGE, IL. FILED 9-10-2008.



THE MARK CONSISTS OF THE LETTERS "CDP" IS A STYLIZED TYPE.

FOR BATTERIES; BATTERIES AND BATTERY CHARGERS; BATTERIES AND BATTERY CHARGERS FOR INTRAVENOUS FLUID DELIVERY APPARATUS; BATTERIES FOR LIGHTING; BATTERIES FOR POKET-LAMPS; BATTERIES FOR VEHICLES; BATTERIES, ELECTRIC; BATTERIES, ELECTRIC, FOR VEHICLES; BATTERY BOXES; BATTERY CABLES; BATTERY CASES; BATTERY CHARGE DEVICES; BATTERY CHARGERS; BATTERY PACKS; BATTERY POWER SUPPLIES FOR MEDICAL VENTILATORS; CELL PHONE BATTERY CHARGERS; CELL PHONE BATTERY CHARGERS FOR USE IN VEHICLES; CHARGERS FOR ELECTRIC BATTERIES; CONSUMER ELECTRONIC PRODUCTS, NAMELY, AUDIO AMPLIFIERS, AUDIO SPEAKERS, AUDIO RECEIVERS, ELECTRICAL AUDIO AND SPEAKER CABLES AND CONNECTORS, HOME THEATER SYSTEMS, AUDIO DECODERS, VIDEO DECODERS, SPEAKERS, POWER CONVERSION DEVICES, POWER CONVERTERS, AND POWER INVERTERS; DC/AC POWER CONVERTERS; DRY CELLS AND BATTERIES; ELECTRIC BATTERIES; ELECTRIC STORAGE BATTERIES; ELECTRIC VOLTAGE TRANSFORMERS; ELECTRICAL CELLS AND BATTERIES; ELECTRICAL PLUG DEVICE ENABLING CONNECTION AND DISCONNECTION OF POWER AND/OR CONTROL CABLES; ELECTRICAL POWER CONNECTORS; ELECTRICAL POWER DISTRIBUTION BLOCKS; ELECTRICAL POWER DISTRIBUTION UNITS; ELECTRICAL POWER EXTENSION CORDS; ELECTRICAL STORAGE BATTERIES; ELECTRICAL SWITCHGEAR, NAMELY, VOLTAGE BOOSTING DEVICES FOR ELECTRIC POWER LINES; ELECTRONIC CONTROLLERS FOR USE WITH POWER CONVERTERS; ELECTRONIC MAGNETOSTRICTIVE EQUIPMENT, NAMELY, A WAVE GENERATOR, WAVE SENSOR AND WAVE ANALYZER; EMERGENCY AUTO KITS COMPRISED OF A HAND HELD SPOTLIGHT AND BATTERY CHARGER; INVERTERS; LITHIUM IRON PHOSPHATE BATTERIES; LITHIUM PHOSPHATE BATTERIES; LOUD SPEAKER SYSTEMS; LOUDSPEAKER SYSTEMS; MOBILE TELEPHONE BATTERIES; NICKEL-CADMIUM STORAGE BATTERIES; PLATES FOR BATTERIES; POWER AMPLIFIERS; POWER CABLES; POWER CONTROLLERS; POWER DISTRIBUTING BOXES; POWER LINE CONDITIONERS; POWER SUPPLIES; POWER SUPPLIES FOR LIGHTS, SIRENS AND PUBLIC ADDRESS SYSTEMS; POWER SUPPLY CONNECTORS AND ADAPTORS FOR USE WITH PORTABLE ELECTRONIC DEVICES; POWER SWITCHES; POWER TRANSFORMERS FOR AMPLIFICATION; POWER WIRES; RECHARGEABLE ELECTRIC BATTERIES; RENEWABLE BATTERY SYSTEM TO PROVIDE BACKUP POWER; SOLAR BATTERIES; SOLAR RECHARGING BATTERY PACK FOR DIGITAL CAMERAS; STATIC VOLTAGE REGULATORS; TELECOMMUNICATIONS EQUIPMENT AND SOFTWARE, NAMELY, FIBER-OPTIC TRANSCEIVERS, FIBER OPTIC REPEATERS, CONVERTERS AND OPTIMIZERS, WAVE DIVISION MULTIPLEXERS, FREE-SPACE OPTICS TRANSMISSION SYSTEMS, SWITCHES INCLUDING ETHERNET

CLASS 9—(Continued).

SWITCHES AND ROUTERS, FIBER-TO-THE-HOME AND ETHERNET-OVER-VDSL ACCESS AGGREGATORS, TERMINATORS AND REPEATERS, AND REMOTE PRESENCE MANAGEMENT PRODUCTS, NAMELY, SWITCHES, AND CONSOLE, ALARM, SENSOR AND POWER MANAGEMENT DEVICES; VOLTAGE REGULATORS; VOLTAGE REGULATORS FOR ELECTRIC POWER; VOLTAGE STABILIZERS; VOLTAGE STABILIZING POWER SUPPLY; VOLTAGE STABILIZERS; VOLTAGE SURGE PROTECTORS; VOLTAGE SURGE SUPPRESSORS; WET CELL BATTERIES (U.S. CLS. 21, 23, 26, 36 AND 38).

TRACY FLETCHER, EXAMINING ATTORNEY

CLASS 9—(Continued).

SN 77-566,961. VANCO INTERNATIONAL, LLC, BATAVIA, IL. FILED 9-10-2008.



SN 77-566,806. ROCKET GAMING SYSTEMS, LLC, GROVE, OK. FILED 9-10-2008.

CHOCOLATE DELIGHT

THE MARK CONSISTS OF STANDARD CHARACTERS WITHOUT CLAIM TO ANY PARTICULAR FONT, STYLE, SIZE, OR COLOR.

FOR GAMING MACHINES, NAMELY, BINGO-RELATED GAMES AND SLOT MACHINES (U.S. CLS. 21, 23, 26, 36 AND 38).

COLLEEN DOMBROW, EXAMINING ATTORNEY

NO CLAIM IS MADE TO THE EXCLUSIVE RIGHT TO USE "POWER", APART FROM THE MARK AS SHOWN.

THE COLOR(S) RED, BROWN, BLACK, AND SILVER IS/ARE CLAIMED AS A FEATURE OF THE MARK.

THE MARK CONSISTS OF THE WORDS "RAPID LINK" ARE STACKED ON THE LEFT. THE BOTTOM HALF OF THE LETTERS IN "RAPID" ARE BROWN, THE TOP HALF ARE RED; THE WORD "LINK" IS BROWN; A SHORT CORD WITH AN ELECTRIC PLUG AT THE END EXTEND FROM THE LOWER PART OF THE "L" IN "LINK", THE CORD IS BROWN, CHANGING TO RED AS IT GETS CLOSE TO THE PLUG; THE PLUG IS RED; TO THE RIGHT THE WORD "POWER" IS WRITTEN IN LETTERS HAVING THE TOP HALF RED AND THE BOTTOM HALF BROWN; THE WORDS "IN-WALL POWER JUST GOT EASY" ARE BLACK, UNDERLINED IN BLACK AND ARE WRITTEN BELOW THE LETTERS "OWER" IN "POWER"; THE WORDS "RAPID", "LINK", "POWER", AND THE CORD AND ELECTRIC PLUG ARE ALL OUTLINED IN BLACK AND SILVER.

FOR IN-WALL POWER SUPPLY (U.S. CLS. 21, 23, 26, 36 AND 38).

CARRIE GENOVESE, EXAMINING ATTORNEY

SN 77-566,933. SIG-TEC CORPORATION, CHANHASSEN, MN. FILED 9-10-2008.

APPSTARTER

THE MARK CONSISTS OF STANDARD CHARACTERS WITHOUT CLAIM TO ANY PARTICULAR FONT, STYLE, SIZE, OR COLOR.

FOR COMPUTER SOFTWARE FOR COMPUTER NETWORK SECURITY (U.S. CLS. 21, 23, 26, 36 AND 38).

FIRST USE 8-1-2006; IN COMMERCE 8-1-2006.

PAUL F. GAST, EXAMINING ATTORNEY

SN 77-566,996. AVATRON SOFTWARE, INC., VANCOUVER, WA. FILED 9-10-2008.

AVATRON

THE MARK CONSISTS OF STANDARD CHARACTERS WITHOUT CLAIM TO ANY PARTICULAR FONT, STYLE, SIZE, OR COLOR.

FOR COMPUTER APPLICATION SOFTWARE FOR MOBILE PHONES (U.S. CLS. 21, 23, 26, 36 AND 38).

FIRST USE 4-12-2008; IN COMMERCE 4-12-2008.

DAVID COLLIER, EXAMINING ATTORNEY

CLASS 9—(Continued).

SN 77-567,023. AVATRON SOFTWARE, INC., VANCOUVER, WA. FILED 9-10-2008.

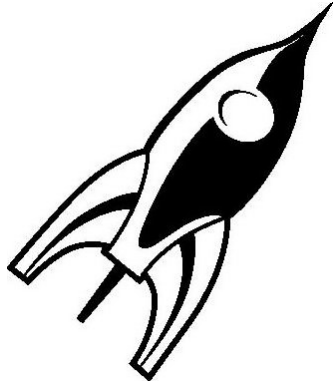

THE MARK CONSISTS OF RISING ROCKET SHIP. FOR COMPUTER APPLICATION SOFTWARE FOR MOBILE PHONES (U.S. CLS. 21, 23, 26, 36 AND 38). FIRST USE 4-12-2008; IN COMMERCE 4-12-2008. DAVID COLLIER, EXAMINING ATTORNEY

CLASS 9—(Continued).

SN 77-567,083. ADRIAN LOPEZ, INC., WEST ORANGE, NJ. FILED 9-10-2008.

LOSERMC

THE MARK CONSISTS OF STANDARD CHARACTERS WITHOUT CLAIM TO ANY PARTICULAR FONT, STYLE, SIZE, OR COLOR. FOR MOTORCYCLE HELMETS (U.S. CLS. 21, 23, 26, 36 AND 38). MICHAEL WEBSTER, EXAMINING ATTORNEY

SN 77-567,089. ZEMNO LLC, ENCINO, CA. FILED 9-10-2008.

DeskBook

THE MARK CONSISTS OF STANDARD CHARACTERS WITHOUT CLAIM TO ANY PARTICULAR FONT, STYLE, SIZE, OR COLOR. FOR COMPUTER PERIPHERALS (U.S. CLS. 21, 23, 26, 36 AND 38). LEIGH CAROLINE CASE, EXAMINING ATTORNEY

SN 77-567,033. AVATRON SOFTWARE, INC., VANCOUVER, WA. FILED 9-10-2008.



THE MARK CONSISTS OF FOLDER ICON BROADCASTING COMMUNICATION WAVES. FOR COMPUTER APPLICATION SOFTWARE FOR MOBILE PHONES (U.S. CLS. 21, 23, 26, 36 AND 38). FIRST USE 4-12-2008; IN COMMERCE 4-12-2008. DAVID COLLIER, EXAMINING ATTORNEY

SN 77-567,090. IBARRA-BRITO GROUP, INC., SALT LAKE CITY, UT. FILED 9-10-2008.

EXPRESSPENCIL

THE MARK CONSISTS OF STANDARD CHARACTERS WITHOUT CLAIM TO ANY PARTICULAR FONT, STYLE, SIZE, OR COLOR. FOR SOFTWARE, NAMELY, A PAYMENT CALCULATOR FOR THE PURCHASE OR LEASE OF AN AUTOMOBILE (U.S. CLS. 21, 23, 26, 36 AND 38). MICHAEL KEATING, EXAMINING ATTORNEY

CLASS 9—(Continued).

SN 77-567,104. ZEMNO LLC, ENCINO, CA. FILED 9-10-2008.

ModBay

THE MARK CONSISTS OF STANDARD CHARACTERS WITHOUT CLAIM TO ANY PARTICULAR FONT, STYLE, SIZE, OR COLOR.

FOR COMPUTER PERIPHERALS (U.S. CLS. 21, 23, 26, 36 AND 38).
LEIGH CAROLINE CASE, EXAMINING ATTORNEY

SN 77-567,120. ZEMNO LLC, ENCINO, CA. FILED 9-10-2008.

ZEMNO

THE MARK CONSISTS OF STANDARD CHARACTERS WITHOUT CLAIM TO ANY PARTICULAR FONT, STYLE, SIZE, OR COLOR.

FOR COMPUTER PERIPHERALS (U.S. CLS. 21, 23, 26, 36 AND 38).
LEIGH CAROLINE CASE, EXAMINING ATTORNEY

SN 77-567,223. INNERSPEC TECHNOLOGIES, LYNCHBURG, VA. FILED 9-10-2008.

POWERUT

THE MARK CONSISTS OF STANDARD CHARACTERS WITHOUT CLAIM TO ANY PARTICULAR FONT, STYLE, SIZE, OR COLOR.

FOR ELECTRONIC CIRCUIT CARDS FOR USE IN HIGH-POWER ULTRASONIC TESTING; SOFTWARE FOR USE IN CONTROLLING AND OPERATING ELECTRONIC INSTRUMENTS USED IN CONDUCTING HIGH-POWER ULTRASONIC TESTING (U.S. CLS. 21, 23, 26, 36 AND 38).
FIRST USE 7-7-2007; IN COMMERCE 7-7-2007.

MICHAEL TANNER, EXAMINING ATTORNEY

CLASS 9—(Continued).

SN 77-567,306. KIRIENKO, NIKOLAI Y, CASTRO VALLEY, CA. FILED 9-11-2008.

Crohnology

THE MARK CONSISTS OF STANDARD CHARACTERS WITHOUT CLAIM TO ANY PARTICULAR FONT, STYLE, SIZE, OR COLOR.

FOR MEDICAL SOFTWARE FOR THE CHRONOLOGICAL TRACKING OF PATIENT SYMPTOMS EXPERIENCED IN THE CLINICAL SCOPE OF CROHN'S DISEASE (U.S. CLS. 21, 23, 26, 36 AND 38).
MIDGE BUTLER, EXAMINING ATTORNEY

SN 77-567,325. DEERFIELD COMMUNICATIONS INC., GAYLORD, MI. FILED 9-11-2008.

MAILFLOW

THE MARK CONSISTS OF STANDARD CHARACTERS WITHOUT CLAIM TO ANY PARTICULAR FONT, STYLE, SIZE, OR COLOR.

FOR COMPUTER SOFTWARE FOR ARCHIVING AND MANAGING E-MAILS (U.S. CLS. 21, 23, 26, 36 AND 38).
GEOFFREY FOSDICK, EXAMINING ATTORNEY

SN 77-567,494. MOGOMOTO PROTOTYPE LLC, CAMAS, WA. FILED 9-11-2008.



THE MARK CONSISTS OF A STYLIZED "M".
FOR CAMERA CASES (U.S. CLS. 21, 23, 26, 36 AND 38).
MIDGE BUTLER, EXAMINING ATTORNEY

CLASS 9—(Continued).

SN 77-567,708. TRANSPARENT LANGUAGE, INC., NASHUA, NH. FILED 9-11-2008.

Learn it FAST...Know it
FOREVER!

THE MARK CONSISTS OF STANDARD CHARACTERS WITHOUT CLAIM TO ANY PARTICULAR FONT, STYLE, SIZE, OR COLOR.

FOR EDUCATIONAL SOFTWARE FEATURING INSTRUCTION IN FOREIGN LANGUAGES (U.S. CLS. 21, 23, 26, 36 AND 38).

FIRST USE 9-4-2008; IN COMMERCE 9-4-2008.
SUSAN STIGLITZ, EXAMINING ATTORNEY

SN 77-567,749. MICROFLUIDICS CORPORATION, NEWTON, MA. FILED 9-11-2008.

BECAUSE THE STAKES
COULDN'T BE HIGHER

THE MARK CONSISTS OF STANDARD CHARACTERS WITHOUT CLAIM TO ANY PARTICULAR FONT, STYLE, SIZE, OR COLOR.

FOR EQUIPMENT FOR TEMPERATURE PRESSURE AND FLOW MONITORING ANALYSIS AND PROCESSING OF FLUIDS, NAMELY, DEAGGLOMERATION AND DISPERSION OF UNIFORM SUBMICRON PARTICLES AND CREATION OF STABLE EMULSIONS AND DISPERSIONS (U.S. CLS. 21, 23, 26, 36 AND 38).

MARTHA SANTOMARTINO, EXAMINING ATTORNEY

SN 77-568,043. BUSTEK LLC, SAN JOSE, CA. FILED 9-11-2008.

SERIALTEK

THE MARK CONSISTS OF STANDARD CHARACTERS WITHOUT CLAIM TO ANY PARTICULAR FONT, STYLE, SIZE, OR COLOR.

FOR COMPUTER COMPONENT TESTING EQUIPMENT, NAMELY, PROTOCOL ANALYZERS FOR DATA BUSES, ERROR INJECTORS FOR DATA BUSES, TRAFFIC GENERATORS FOR DATA BUSES, HOST EMULATORS FOR DATA BUSES, AND DEVICE EMULATORS FOR DATA BUSES (U.S. CLS. 21, 23, 26, 36 AND 38).

KEVON CHISOLM, EXAMINING ATTORNEY

CLASS 9—(Continued).

SN 77-568,239. SENUSION INC., SAN JOSE, CA. FILED 9-11-2008.

NetSSM

THE MARK CONSISTS OF STANDARD CHARACTERS WITHOUT CLAIM TO ANY PARTICULAR FONT, STYLE, SIZE, OR COLOR.

FOR COMPUTER SOFTWARE FOR INTEGRATION OF COMPUTER SYSTEMS AND SENSOR NETWORKS OVER IP AND LEGACY PROTOCOLS AND OVER WIRED AND WIRELESS NETWORKS; SOFTWARE ENABLING SENSOR PROTOCOL INTEGRATION FOR POLICY BASED AUTOMATION OF SENSOR AND SYSTEMS INTEROPERABILITY (U.S. CLS. 21, 23, 26, 36 AND 38).

FIRST USE 10-15-2007; IN COMMERCE 11-12-2007.
H. M. FISHER, EXAMINING ATTORNEY

SN 77-568,310. NEXPAK CORPORATION, DULUTH, GA. FILED 9-11-2008.

AUDIBLEPAK

THE MARK CONSISTS OF STANDARD CHARACTERS WITHOUT CLAIM TO ANY PARTICULAR FONT, STYLE, SIZE, OR COLOR.

FOR PLASTIC SECURITY CONTAINER WITH INTEGRATED LOCK THAT HOLDS PRELOADED MEDIA PLAYER (U.S. CLS. 21, 23, 26, 36 AND 38).

JUDITH HELFMAN, EXAMINING ATTORNEY

CLASS 9—(Continued).

SN 77-568,343. FANG BIAN, ELMHURST, NY. FILED 9-11-2008.

HIFIMAN

THE MARK CONSISTS OF STANDARD CHARACTERS WITHOUT CLAIM TO ANY PARTICULAR FONT, STYLE, SIZE, OR COLOR.

FOR AUDIO CASSETTE AND CD PLAYERS; AUDIO CASSETTE PLAYERS; CAR CASSETTE PLAYERS; CASSETTE PLAYERS; CD PLAYERS; COMBINATION VIDEO PLAYERS AND RECORDERS; COMPACT DISC PLAYERS; COMPACT DISC PLAYERS; DIGITAL AUDIO PLAYERS; DIGITAL AUDIO TAPE PLAYERS; DVD PLAYERS; FITTED PLASTIC FILMS KNOWN AS SKINS FOR COVERING AND PROVIDING A SCRATCH PROOF BARRIER OR PROTECTION FOR ELECTRONIC DEVICES, NAMELY, MP3 PLAYERS, MOBILE TELEPHONES, SMART TELEPHONES, DIGITAL CAMERAS, GLOBAL POSITIONING SYSTEMS AND PERSONAL DIGITAL ASSISTANTS; KARAOKE PLAYERS; LOUD-SPEAKERS, HEADPHONES, MICROPHONES AND CD PLAYERS; MEDIA PLAYERS; MP3 PLAYERS; MP4 PLAYERS; PLAYER-OPERATED ELECTRONIC CONTROLLERS FOR ELECTRONIC VIDEO GAME MACHINES; PORTABLE DVD PLAYERS; PORTABLE LISTENING DEVICES, NAMELY, MP3 PLAYERS; PORTABLE MEDIA PLAYERS; PROTECTIVE CARRYING CASES FOR PORTABLE MUSIC PLAYERS, NAMELY, MP3 PLAYERS (U.S. CLS. 21, 23, 26, 36 AND 38).
KARANENDRA S. CHHINA, EXAMINING ATTORNEY

SN 77-569,079. DOMAILLE ENGINEERING, LLC, ROCHESTER, MN. FILED 9-12-2008.

ABRASAVE

THE MARK CONSISTS OF STANDARD CHARACTERS WITHOUT CLAIM TO ANY PARTICULAR FONT, STYLE, SIZE, OR COLOR.

FOR POLISHING FIXTURE FOR OPTIC FIBERS (U.S. CLS. 21, 23, 26, 36 AND 38).
BRIAN NEVILLE, EXAMINING ATTORNEY

SN 77-569,107. IGT, RENO, NV. FILED 9-12-2008.

AQUAMARINE

THE MARK CONSISTS OF STANDARD CHARACTERS WITHOUT CLAIM TO ANY PARTICULAR FONT, STYLE, SIZE, OR COLOR.

FOR GAMING MACHINES, NAMELY, DEVICES WHICH ACCEPT A WAGER (U.S. CLS. 21, 23, 26, 36 AND 38).
MICHELE SWAIN, EXAMINING ATTORNEY

CLASS 9—(Continued).

SN 77-569,111. IGT, RENO, NV. FILED 9-12-2008.

GARNET

THE MARK CONSISTS OF STANDARD CHARACTERS WITHOUT CLAIM TO ANY PARTICULAR FONT, STYLE, SIZE, OR COLOR.

FOR GAMING MACHINES, NAMELY, DEVICES WHICH ACCEPT A WAGER (U.S. CLS. 21, 23, 26, 36 AND 38).
MICHELE SWAIN, EXAMINING ATTORNEY

SN 77-569,207. IGT, RENO, NV. FILED 9-12-2008.

2ND CHANCE ROYAL

THE MARK CONSISTS OF STANDARD CHARACTERS WITHOUT CLAIM TO ANY PARTICULAR FONT, STYLE, SIZE, OR COLOR.

FOR GAMING MACHINES, NAMELY, DEVICES WHICH ACCEPT A WAGER (U.S. CLS. 21, 23, 26, 36 AND 38).
MICHELE SWAIN, EXAMINING ATTORNEY

SN 77-570,800. ETI SOUND SYSTEMS, INC., HUNTINGTON PARK, CA. FILED 9-16-2008.

ANARCHY

THE MARK CONSISTS OF STANDARD CHARACTERS WITHOUT CLAIM TO ANY PARTICULAR FONT, STYLE, SIZE, OR COLOR.

FOR GUITAR AMPLIFIERS, LOUD SPEAKERS (U.S. CLS. 21, 23, 26, 36 AND 38).
SUSAN RICHARDS, EXAMINING ATTORNEY

CLASS 9—(Continued).

SN 77-570,806. ETI SOUND SYSTEMS, INC., HUNTINGTON PARK, CA. FILED 9-16-2008.

MAYHEM

THE MARK CONSISTS OF STANDARD CHARACTERS WITHOUT CLAIM TO ANY PARTICULAR FONT, STYLE, SIZE, OR COLOR.

FOR GUITAR AMPLIFIERS, LOUD SPEAKERS (U.S. CLS. 21, 23, 26, 36 AND 38).

SUSAN RICHARDS, EXAMINING ATTORNEY

SN 77-570,809. ETI SOUND SYSTEMS, INC., HUNTINGTON PARK, CA. FILED 9-16-2008.

GRAIL

THE MARK CONSISTS OF STANDARD CHARACTERS WITHOUT CLAIM TO ANY PARTICULAR FONT, STYLE, SIZE, OR COLOR.

FOR GUITAR AMPLIFIERS, LOUD SPEAKERS (U.S. CLS. 21, 23, 26, 36 AND 38).

SUSAN RICHARDS, EXAMINING ATTORNEY

SN 77-571,453. OEM INCORPORATED, HOLLYWOOD, CA. FILED 9-16-2008.

JAMMIT

THE MARK CONSISTS OF STANDARD CHARACTERS WITHOUT CLAIM TO ANY PARTICULAR FONT, STYLE, SIZE, OR COLOR.

FOR EDUCATIONAL SOFTWARE FOR TEACHING OTHERS TO PLAY VARIOUS MUSICAL INSTRUMENTS; INTERACTIVE VIDEO GAME PROGRAMS; INTERACTIVE COMPUTER GAME PROGRAMS; INTERACTIVE ELECTRONIC GAME PROGRAM SOFTWARE FOR CELLULAR TELEPHONES (U.S. CLS. 21, 23, 26, 36 AND 38).

HAI-LY LAM, EXAMINING ATTORNEY

CLASS 9—(Continued).

SN 77-571,512. WARNER, MELISSA, ANAHEIM, CA. FILED 9-16-2008.

THINKPLANET

THE MARK CONSISTS OF STANDARD CHARACTERS WITHOUT CLAIM TO ANY PARTICULAR FONT, STYLE, SIZE, OR COLOR.

FOR ELECTRONIC AND MAGNETIC ID CARDS FOR USE IN CONNECTION WITH PAYMENT FOR GOODS AND SERVICES; ELECTRONIC AND MAGNETIC IDENTITY CARDS FOR USE IN CONNECTION WITH PAYMENT FOR SERVICES; ELECTRONICALLY ENCODED IDENTITY CARDS; ENCODED MAGNETIC CARDS (U.S. CLS. 21, 23, 26, 36 AND 38).

FIRST USE 9-22-2003; IN COMMERCE 9-22-2003.
SUSAN RICHARDS, EXAMINING ATTORNEY

SN 77-571,549. GAW VAN MALE SMITH MEYERS & MIROGLIO, A PROFESSIONAL CORPORATION, FAIRFIELD, CA. FILED 9-16-2008.

TRUST AIMS

THE MARK CONSISTS OF STANDARD CHARACTERS WITHOUT CLAIM TO ANY PARTICULAR FONT, STYLE, SIZE, OR COLOR.

FOR COMPUTER SOFTWARE, NAMELY, SOFTWARE FOR USE BY ATTORNEYS, ACCOUNTANTS AND ESTATE PLANNING PROFESSIONALS FOR THE MANAGEMENT OF CLIENT ASSETS (U.S. CLS. 21, 23, 26, 36 AND 38).

LESLIE RICHARDS, EXAMINING ATTORNEY

SN 77-572,661. PROCREATE INC., ANACORTES, WA. FILED 9-17-2008.

A MOBILE REVOLUTION

THE MARK CONSISTS OF STANDARD CHARACTERS WITHOUT CLAIM TO ANY PARTICULAR FONT, STYLE, SIZE, OR COLOR.

FOR ELECTRONIC AND/OR MECHANICAL ACCESSORIES FOR PORTABLE AND HANDHELD DIGITAL ELECTRONIC DEVICES, NAMELY, STANDS, HOLSTERS AND/OR DOCKING STATIONS SPECIALLY DESIGNED FOR HOLDING PORTABLE AND HANDHELD DIGITAL ELECTRONIC DEVICES, AND BATTERY CHARGERS, ELECTRICAL CONNECTORS, WIRES, CABLES, ADAPTERS AND REMOTE CONTROLS FOR PORTABLE AND HANDHELD DIGITAL ELECTRONIC DEVICES (U.S. CLS. 21, 23, 26, 36 AND 38).

JACQUELINE A. LAVINE, EXAMINING ATTORNEY

CLASS 9—(Continued).

SN 77-573,492. VERIMATRIX, INC., SAN DIEGO, CA. FILED 9-18-2008.



OWNER OF U.S. REG. NOS. 3,024,002 AND 3,496,359. THE MARK CONSISTS OF THE WORD "VERIMATRIX" WITH A CIRCULAR DESIGN ABOVE THE "TRIX" PART OF THE WORD.
 FOR COMPUTER SOFTWARE FOR USE TO ENCRYPT AND EMBED ELECTRONIC DIGITAL SIGNATURES TO CREATE AND AUTHENTICATE ELECTRONIC DIGITAL CERTIFICATES (U.S. CLS. 21, 23, 26, 36 AND 38).
 FIRST USE 8-31-2002; IN COMMERCE 8-31-2002.
 JAY FLOWERS, EXAMINING ATTORNEY

SN 77-573,755. INCIPIO TECHNOLOGIES, INC., IRVINE, CA. FILED 9-18-2008.

ORION

THE MARK CONSISTS OF STANDARD CHARACTERS WITHOUT CLAIM TO ANY PARTICULAR FONT, STYLE, SIZE, OR COLOR.
 FOR CARRYING CASES FOR PORTABLE DEVICES, NAMELY, MEDIA PLAYERS AND MOBILE DEVICES (U.S. CLS. 21, 23, 26, 36 AND 38).
 FIRST USE 6-13-2007; IN COMMERCE 6-13-2007.
 PAUL F. GAST, EXAMINING ATTORNEY

SN 77-573,758. INCIPIO TECHNOLOGIES, INC., IRVINE, CA. FILED 9-18-2008.

dermaSHOT

THE MARK CONSISTS OF STANDARD CHARACTERS WITHOUT CLAIM TO ANY PARTICULAR FONT, STYLE, SIZE, OR COLOR.
 FOR CARRYING CASES FOR PORTABLE DEVICES, NAMELY, MEDIA PLAYERS AND MOBILE DEVICES (U.S. CLS. 21, 23, 26, 36 AND 38).
 FIRST USE 6-13-2007; IN COMMERCE 6-13-2007.
 PAUL F. GAST, EXAMINING ATTORNEY

CLASS 9—(Continued).

SN 77-574,624. BALLY GAMING, INC., DBA BALLY TECHNOLOGIES, LAS VEGAS, NV. FILED 9-19-2008.

RUBY RUSH

THE MARK CONSISTS OF STANDARD CHARACTERS WITHOUT CLAIM TO ANY PARTICULAR FONT, STYLE, SIZE, OR COLOR.
 FOR GAMING DEVICES NAMELY SLOT MACHINES WITH OR WITHOUT VIDEO OUTPUT (U.S. CLS. 21, 23, 26, 36 AND 38).
 DAVID TOOLEY, EXAMINING ATTORNEY

SN 77-575,393. JWMC PRODUCTIONS, LLC, ST. CHARLES, MO. FILED 9-22-2008.

Chatham Drive



Records

NO CLAIM IS MADE TO THE EXCLUSIVE RIGHT TO USE "RECORDS", APART FROM THE MARK AS SHOWN. THE MARK CONSISTS OF A BASEBALL WITH THE LANGUAGE "CHATHAM DRIVE" ABOVE THE BALL AND THE TERM "RECORDS" BELOW THE BALL.
 FOR PRERECORDED CDS AND DVDS FEATURING MUSIC (U.S. CLS. 21, 23, 26, 36 AND 38).
 LAURIE MAYES, EXAMINING ATTORNEY

SN 77-576,295. DOUBLE-TAKE SOFTWARE, INC., SOUTH-BOROUGH, MA. FILED 9-23-2008.



THE MARK CONSISTS OF THE TERM "LIVEWIRE" IN STYLIZED LETTERS NEXT TO A SPHERE, WHICH IS SPLIT HORIZONTALLY BY A STYLIZED JAGGED LINE.
 FOR COMPUTER SOFTWARE FOR DATA BACKUP AND RECOVERY (U.S. CLS. 21, 23, 26, 36 AND 38).
 PAUL MORENO, EXAMINING ATTORNEY

CLASS 9—(Continued).

SN 77-578,169. INCIPIO TECHNOLOGIES, INC., IRVINE, CA.
FILED 9-24-2008.



THE MARK CONSISTS OF A SQUARE WITHIN A SQUARE.
FOR CARRYING CASES FOR PORTABLE DEVICES, NAMELY, MEDIA PLAYERS AND MOBILE DEVICES (U.S. CLS. 21, 23, 26, 36 AND 38).
FIRST USE 6-13-2007; IN COMMERCE 6-13-2007.
PAUL F. GAST, EXAMINING ATTORNEY

SN 77-580,245. ROCKET GAMING SYSTEMS, LLC, GROVE, OK. FILED 9-26-2008.

SWEET SENSATIONS

THE MARK CONSISTS OF STANDARD CHARACTERS WITHOUT CLAIM TO ANY PARTICULAR FONT, STYLE, SIZE, OR COLOR.
FOR GAMING MACHINES, NAMELY, BINGO-RELATED GAMES AND SLOT MACHINES (U.S. CLS. 21, 23, 26, 36 AND 38).
COLLEEN DOMBROW, EXAMINING ATTORNEY

SN 77-580,994. M. BILT ENTERPRISES, INC., DBA WELL BILT INDUSTRIES, WILLISTON, FL. FILED 9-29-2008.

HERCUL-EZE

THE MARK CONSISTS OF STANDARD CHARACTERS WITHOUT CLAIM TO ANY PARTICULAR FONT, STYLE, SIZE, OR COLOR.
FOR ELECTRIC DOOR OPENERS AND CLOSERS (U.S. CLS. 21, 23, 26, 36 AND 38).
FIRST USE 1-3-2006; IN COMMERCE 1-3-2006.
ELIZABETH KAJUBI, EXAMINING ATTORNEY

CLASS 9—(Continued).

SN 77-582,576. INCIPIO TECHNOLOGIES, INC., IRVINE, CA.
FILED 9-30-2008.

SILICRYLIC

THE MARK CONSISTS OF STANDARD CHARACTERS WITHOUT CLAIM TO ANY PARTICULAR FONT, STYLE, SIZE, OR COLOR.
FOR CARRYING CASES FOR PORTABLE DEVICES, NAMELY, MEDIA PLAYERS AND MOBILE DEVICES (U.S. CLS. 21, 23, 26, 36 AND 38).
FIRST USE 6-13-2007; IN COMMERCE 6-13-2007.
PAUL F. GAST, EXAMINING ATTORNEY

SN 77-582,677. EAST PENN MANUFACTURING CO., LYON STATION, PA. FILED 9-30-2008.

UltraBattery

THE MARK CONSISTS OF STANDARD CHARACTERS WITHOUT CLAIM TO ANY PARTICULAR FONT, STYLE, SIZE, OR COLOR.
FOR ELECTRIC STORAGE BATTERIES (U.S. CLS. 21, 23, 26, 36 AND 38).
JILL PRATER, EXAMINING ATTORNEY

SN 77-584,611. BALLY GAMING, INC., DBA BALLY TECHNOLOGIES, LAS VEGAS, NV. FILED 10-2-2008.

1,000,000 DEGREES

THE MARK CONSISTS OF STANDARD CHARACTERS WITHOUT CLAIM TO ANY PARTICULAR FONT, STYLE, SIZE, OR COLOR.
FOR GAMING DEVICES, NAMELY, SLOT MACHINES WITH OR WITHOUT VIDEO OUTPUT (U.S. CLS. 21, 23, 26, 36 AND 38).
FIRST USE 11-13-2007; IN COMMERCE 11-13-2007.
DAVID TOOLEY, EXAMINING ATTORNEY

CLASS 9—(Continued).

SN 77-584,923. SIG-TEC CORPORATION, CHANHASSEN, MN. FILED 10-3-2008.

HOT DESKTOP

THE MARK CONSISTS OF STANDARD CHARACTERS WITHOUT CLAIM TO ANY PARTICULAR FONT, STYLE, SIZE, OR COLOR.

NO CLAIM IS MADE TO THE EXCLUSIVE RIGHT TO USE "DESKTOP", APART FROM THE MARK AS SHOWN.

FOR COMPUTER LOGON MANAGEMENT SOFTWARE FOR GENERAL USE, NAMELY, SOFTWARE THAT ALLOWS USERS TO SECURELY SHARE A SINGLE COMPUTER OR GROUP ACCOUNT DESKTOP AND ANY APPLICATIONS THAT ARE OPEN IN THAT DESKTOP (U.S. CLS. 21, 23, 26, 36 AND 38).
PAUL F. GAST, EXAMINING ATTORNEY

SN 77-587,851. BALLY GAMING, INC., DBA BALLY TECHNOLOGIES, LAS VEGAS, NV. FILED 10-7-2008.

HOT & WILD

THE MARK CONSISTS OF STANDARD CHARACTERS WITHOUT CLAIM TO ANY PARTICULAR FONT, STYLE, SIZE, OR COLOR.

FOR GAMING DEVICES, NAMELY, SLOT MACHINES WITH OR WITHOUT VIDEO OUTPUT (U.S. CLS. 21, 23, 26, 36 AND 38).

DAVID TOOLEY, EXAMINING ATTORNEY

SN 77-588,826. BALLY GAMING, INC., DBA BALLY TECHNOLOGIES, LAS VEGAS, NV. FILED 10-8-2008.

COOPERTITION

THE MARK CONSISTS OF STANDARD CHARACTERS WITHOUT CLAIM TO ANY PARTICULAR FONT, STYLE, SIZE, OR COLOR.

FOR GAMING DEVICES, NAMELY, SLOT MACHINES WITH OR WITHOUT VIDEO OUTPUT (U.S. CLS. 21, 23, 26, 36 AND 38).

DAVID TOOLEY, EXAMINING ATTORNEY

CLASS 9—(Continued).

SN 77-591,040. FANG BIAN, ELMHURST, NY. FILED 10-12-2008.

HeAUDIO

THE MARK CONSISTS OF STANDARD CHARACTERS WITHOUT CLAIM TO ANY PARTICULAR FONT, STYLE, SIZE, OR COLOR.

FOR AUDIO AMPLIFIERS; EARPHONES AND HEADPHONES; HEADPHONES; LOUDSPEAKERS, HEADPHONES, MICROPHONES AND CD PLAYERS; PERSONAL HEADPHONES FOR USE WITH SOUND TRANSMITTING SYSTEMS (U.S. CLS. 21, 23, 26, 36 AND 38).

KARANENDRA S. CHHINA, EXAMINING ATTORNEY

SN 77-592,188. INCIPIO TECHNOLOGIES, INC., IRVINE, CA. FILED 10-14-2008.

TONIC

THE MARK CONSISTS OF STANDARD CHARACTERS WITHOUT CLAIM TO ANY PARTICULAR FONT, STYLE, SIZE, OR COLOR.

FOR USB CHARGER (U.S. CLS. 21, 23, 26, 36 AND 38). FIRST USE 12-7-2007; IN COMMERCE 12-7-2007.

PAUL F. GAST, EXAMINING ATTORNEY

SN 77-592,571. INCIPIO TECHNOLOGIES, INC., IRVINE, CA. FILED 10-14-2008.

DUROSHOT

THE MARK CONSISTS OF STANDARD CHARACTERS WITHOUT CLAIM TO ANY PARTICULAR FONT, STYLE, SIZE, OR COLOR.

FOR CARRYING CASES FOR PORTABLE DEVICES, NAMELY, CELL PHONES AND MEDIA PLAYERS (U.S. CLS. 21, 23, 26, 36 AND 38).

FIRST USE 10-1-2008; IN COMMERCE 10-1-2008.

PAUL F. GAST, EXAMINING ATTORNEY

CLASS 9—(Continued).

SN 77-595,587. BALLY GAMING, INC., DBA BALLY TECHNOLOGIES, LAS VEGAS, NV. FILED 10-18-2008.

FIREBALL FRENZY

THE MARK CONSISTS OF STANDARD CHARACTERS WITHOUT CLAIM TO ANY PARTICULAR FONT, STYLE, SIZE, OR COLOR.

FOR GAMING DEVICES, NAMELY, SLOT MACHINES WITH OR WITHOUT VIDEO OUTPUT (U.S. CLS. 21, 23, 26, 36 AND 38).

DAVID TOOLEY, EXAMINING ATTORNEY

SN 77-597,376. EURASIA CONCEPTS, INC., LOS ANGELES, CA. FILED 10-21-2008.

Flash Heat

THE MARK CONSISTS OF STANDARD CHARACTERS WITHOUT CLAIM TO ANY PARTICULAR FONT, STYLE, SIZE, OR COLOR.

NO CLAIM IS MADE TO THE EXCLUSIVE RIGHT TO USE "HEAT", APART FROM THE MARK AS SHOWN.

FOR ELECTRIC HAIR CURLERS; ELECTRIC HAIR CURLING IRONS; ELECTRIC HAIR STRAIGHTENING IRONS; ELECTRIC HAND-HELD HAIR STYLING IRONS; ELECTRIC IRONS FOR STYLING HAIR (U.S. CLS. 21, 23, 26, 36 AND 38).

MARGERY A. TIERNEY, EXAMINING ATTORNEY

SN 77-601,056. RED.COM, INC., EASTSOUND, WA. FILED 10-27-2008.

SCARLET SYSTEM

THE MARK CONSISTS OF STANDARD CHARACTERS WITHOUT CLAIM TO ANY PARTICULAR FONT, STYLE, SIZE, OR COLOR.

NO CLAIM IS MADE TO THE EXCLUSIVE RIGHT TO USE "SYSTEM", APART FROM THE MARK AS SHOWN.

FOR MODULAR CAMERA SYSTEMS AND ACCESSORIES, SOLD INDIVIDUALLY OR AS A UNIT, COMPRISED OF CAMERAS, CAMERA LENSES, ELECTRONIC VIEWFINDERS, PROCESSING MODULES, IMAGING MODULES, FLASH MEMORY CARDS, ELECTRONIC MEMORIES, HARD DRIVES FOR VIDEO RECORDERS, VIDEO MONITORS AND FLAT PANEL DISPLAY SCREENS, ALL FOR USE IN THE CREATION, STORAGE, DELIVERY, MANIPULATION, RECORDING, PLAYBACK OR VIEWING OF VIDEO, MUSIC, GRAPHICS, PHOTOS, AUDIO, TEXT, AND MULTIMEDIA DATA (U.S. CLS. 21, 23, 26, 36 AND 38).

FRANK LATTUCA, EXAMINING ATTORNEY

CLASS 9—(Continued).

SN 77-602,461. BALLY GAMING, INC., DBA BALLY TECHNOLOGIES, LAS VEGAS, NV. FILED 10-28-2008.

HOT N' WILD

THE MARK CONSISTS OF STANDARD CHARACTERS WITHOUT CLAIM TO ANY PARTICULAR FONT, STYLE, SIZE, OR COLOR.

FOR GAMING DEVICES, NAMELY, SLOT MACHINES WITH OR WITHOUT VIDEO OUTPUT (U.S. CLS. 21, 23, 26, 36 AND 38).

DAVID TOOLEY, EXAMINING ATTORNEY

SN 77-605,914. SECURE MEDIA SYSTEMS, LLC, STERLING HEIGHTS, MI. FILED 11-3-2008.

MusicWarden

THE MARK CONSISTS OF STANDARD CHARACTERS WITHOUT CLAIM TO ANY PARTICULAR FONT, STYLE, SIZE, OR COLOR.

FOR COMPUTER E-COMMERCE SOFTWARE TO ALLOW USERS TO PERFORM ELECTRONIC BUSINESS TRANSACTIONS VIA A GLOBAL COMPUTER NETWORK; COMPUTER HARDWARE AND SOFTWARE FOR PROCESSING DIGITAL MUSIC FILES; MEDIA PLAYERS; MP3 PLAYERS (U.S. CLS. 21, 23, 26, 36 AND 38).

FIRST USE 8-25-2007; IN COMMERCE 8-25-2007.

AISHA SALEM, EXAMINING ATTORNEY

CLASS 9—(Continued).

SN 77-608,076. INCREDIMAIL LTD., TEL AVIV, ISRAEL, FILED 11-5-2008.

INCREDIBLEMAIL

THE MARK CONSISTS OF STANDARD CHARACTERS WITHOUT CLAIM TO ANY PARTICULAR FONT, STYLE, SIZE, OR COLOR.

FOR COMPUTER SOFTWARE, NAMELY, DESKTOP INFORMATION MANAGER PROGRAMS PROVIDING ELECTRONIC MAIL, PERSONAL CALENDAR, GROUP SCHEDULING, PERSONAL INFORMATION MANAGEMENT, TASK MANAGEMENT, BROWSING AND SHARING OF DOCUMENTS; COMPUTER SOFTWARE FOR MANAGING, VIEWING, AND EDITING FILES AND DOCUMENTS, ELECTRONIC MAIL MESSAGES AND PRIVATE NETWORK AND GLOBAL COMPUTER NETWORK COMMUNICATIONS; COMPUTER PROGRAMS FOR DOWNLOADING GRAPHIC AND TEXT FILES FROM PRIVATE NETWORK AND GLOBAL COMPUTER NETWORK COMMUNICATIONS; AND COMPUTER PROGRAMS FOR MEETING AND EVENT SCHEDULING, MANAGING GROUP CALENDARS, TASK DELEGATION AND REPORTING, RECORDING NOTES, TRANSFERRING DATA TO AND FROM DATABASES AND TO AND FROM COMPUTER PROGRAMS, AND COMPUTER FILES; ADDRESS BOOK PROGRAMS (U.S. CLS. 21, 23, 26, 36 AND 38).

AMY C. KEAN, EXAMINING ATTORNEY

SN 77-609,658. THE FONT BUREAU, INC., BOSTON, MA. FILED 11-7-2008.

IBIS

THE MARK CONSISTS OF STANDARD CHARACTERS WITHOUT CLAIM TO ANY PARTICULAR FONT, STYLE, SIZE, OR COLOR.

FOR PRINTING FONTS THAT CAN BE DOWNLOADED PROVIDED BY MEANS OF ELECTRONIC TRANSMISSION; TYPEFACE FONTS RECORDED ON MAGNETIC MEDIA (U.S. CLS. 21, 23, 26, 36 AND 38).

LINDA M. KING, EXAMINING ATTORNEY

CLASS 9—(Continued).

SN 77-612,668. ICSYNERGY INTERNATIONAL, LP, PLANO, TX. FILED 11-12-2008.

ICLITE

THE MARK CONSISTS OF STANDARD CHARACTERS WITHOUT CLAIM TO ANY PARTICULAR FONT, STYLE, SIZE, OR COLOR.

FOR COMPUTER SOFTWARE FOR INTEGRATING APPLICATIONS WITH IDENTITY MANAGEMENT PROGRAMS IN THE FIELD OF ENTERPRISE IDENTITY MANAGEMENT, ACCESS CONTROL AND SECURITY FOR APPLICATIONS, NETWORKS AND INFRASTRUCTURE (U.S. CLS. 21, 23, 26, 36 AND 38).

ANDREA SAUNDERS, EXAMINING ATTORNEY

SN 77-617,782. FLASHBRIDGE CORPORATION, DBA FLASHBRIDGE, IRVINE, CA. FILED 11-19-2008.

Flashbridge

THE MARK CONSISTS OF STANDARD CHARACTERS WITHOUT CLAIM TO ANY PARTICULAR FONT, STYLE, SIZE, OR COLOR.

FOR COMPUTER MEMORY HARDWARE (U.S. CLS. 21, 23, 26, 36 AND 38).

JORDAN BAKER, EXAMINING ATTORNEY

SN 78-260,472. MEMOREX INTERNATIONAL INC., KOWLOON, HONG KONG, FILED 6-10-2003.

PRECISION

THE MARK CONSISTS OF STANDARD CHARACTERS WITHOUT CLAIM TO ANY PARTICULAR FONT, STYLE, SIZE, OR COLOR.

FOR AUDIO AND VIDEO EQUIPMENT, NAMELY, BLANK AUDIO AND VIDEO TAPES; BLANK OPTICAL RECORDING MEDIA, NAMELY, RECORDABLE AND REWRITEABLE CDS, DVDS AND DVD-RAM, AND DRIVES AND WRITERS THEREFORE; COMPUTER DISK DRIVES, OPTICAL DISK DRIVES; COMPUTER MEMORY CARDS; COMPUTER CARD READERS; PCMCIA CARDS AND ADAPTERS; BUSINESS CARD LABEL MAKING KIT COMPRISING COMPUTER SOFTWARE FOR CREATING AND PRINTING LABELS FOR BUSINESS CARD FORMAT COMPACT DISCS, A LABEL APPLICATOR, AND BLANK LABELS; COMPACT DISC LABEL MAKING KIT COMPRISING COMPUTER SOFTWARE FOR CREATING AND PRINTING LABELS FOR 8 CM FORMAT COMPACT DISCS, A LABEL APPLICATOR, AND BLANK LABELS; CD/DVD LABEL MAKER KIT COMPRISING COMPUTER SOFTWARE FOR CREATING AND PRINTING LABELS FOR CDS AND DVDS, A LABEL APPLICATOR, JEWEL CASE INSERT CARDS AND BLANK LABELS; CD/DVD SCRATCH

CLASS 9—(Continued).

REPAIR KIT COMPRISING CD/DVD CLEANING CLOTHS AND CLEANING SOLUTION; CD CLEANING AND REPAIR KIT COMPRISING A MOTORIZED CONTAINER FOR HOLDING A ROTATING COMPACT DISCS, CLEANING SOLUTION AND WIPES; CD LASER LENS CLEANERS, NAMELY, A COMPACT DISC FOR CLEANING CD LASER LENSES; BLANK FLOPPY COMPUTER DISKETTES, BLANK AUDIO MINI-DISCS; CARRYING CASES AND BOXES FOR STORING MEMORY CARDS; CARRYING CASES, BOXES, SLEEVES AND WALLETS FOR MAGNETIC AND OPTICAL RECORDING MEDIA; AUDIO AND VIDEO CASSETTE RECORDER CLEANING KITS COMPRISING HEAD CLEANING CASSETTE CARTRIDGES AND CLEANING SOLUTION; COMPUTER MICE AND KEYBOARDS; MONITOR GLARE FILTERS; COMPUTER HARDWARE AND PERIPHERALS; COMPUTER SOFTWARE, NAMELY, DRIVERS FOR OPERATING COMPUTER HARDWARE AND PERIPHERALS; BATTERIES; RECHARGEABLE BATTERIES; BATTERY CHARGERS (U.S. CLS. 21, 23, 26, 36 AND 38).

ESTHER A. BORSUK, EXAMINING ATTORNEY

CLASS 9—(Continued).

SN 78-766,315. ZAHARA MOSSMAN LLC, MIAMI BEACH, FL. FILED 12-5-2005.



NO CLAIM IS MADE TO THE EXCLUSIVE RIGHT TO USE "PODCAST REALTY", APART FROM THE MARK AS SHOWN.

THE MARK CONSISTS OF THE WORDS "PODCAST REALTY" WITH A STYLIZED DESIGN OF A BUILDING AND A MEGAPHONE.

FOR SEARCHABLE DATABASE FOR PROPERTY LISTINGS WHICH COMPRISE INFORMATION IN DOWNLOADABLE AUDIO AND VISUAL FORM; PROPERTY LISTINGS COMPRISING INFORMATION IN DOWNLOADABLE AUDIO AND VISUAL FORM; PROPERTY LISTINGS IN DOWNLOADABLE AUDIO AND VISUAL FORM (U.S. CLS. 21, 23, 26, 36 AND 38).

FIRST USE 10-5-2005; IN COMMERCE 10-5-2005.

ANNE FARRELL, EXAMINING ATTORNEY

SN 78-627,250. OBJECTMETHOD SOFTWARE, INC., CHICAGO, IL. FILED 5-10-2005.

OXIDE

SN 78-790,476. RADIODETECTION LIMITED, BRISTOL, UNITED KINGDOM, FILED 1-12-2006.

STRIKEALERT

THE MARK CONSISTS OF STANDARD CHARACTERS WITHOUT CLAIM TO ANY PARTICULAR FONT, STYLE, SIZE, OR COLOR.

FOR COMPUTER SOFTWARE, NAMELY, COMPUTER PROGRAMS FOR OPERATING SYSTEMS, COMPUTER SOFTWARE DEVELOPMENT TOOLS, COMMUNICATIONS SOFTWARE FOR CONNECTING GLOBAL COMPUTER NETWORKS, COMPUTER SOFTWARE COMPILING PROGRAMS, NAMELY SOFTWARE FOR APPLICATION AND DATABASE INTEGRATION; DATA COMPRESSION SOFTWARE, DATABASE MANAGEMENT SOFTWARE FOR GENERAL USE, INSTRUCTIONAL MANUALS FOR ALL OF THE FOREGOING SOLD AS A UNIT THEREWITH (U.S. CLS. 21, 23, 26, 36 AND 38).

JOHN KELLY, EXAMINING ATTORNEY

THE MARK CONSISTS OF STANDARD CHARACTERS WITHOUT CLAIM TO ANY PARTICULAR FONT, STYLE, SIZE, OR COLOR.

PRIORITY CLAIMED UNDER SEC. 44(D) ON ERPNCMNTY TM OFC APPLICATION NO. 004539581, FILED 7-13-2005, REG. NO. 004539581, DATED 1-30-2008, EXPIRES 7-12-2015.

FOR ELECTRONIC SIGNAL SEARCHING FEATURE SOLD AS A COMPONENT PART OF ELECTRONIC TEST AND SIGNAL EQUIPMENT FOR USE IN LOCATING BURIED POWER CABLES (U.S. CLS. 21, 23, 26, 36 AND 38).

FIRST USE 6-30-2005; IN COMMERCE 6-30-2005.

ANDREW RHIM, EXAMINING ATTORNEY

CLASS 9—(Continued).

SN 78-794,757. LG ELECTRONICS INC., SEOUL, REPUBLIC OF KOREA, FILED 1-19-2006.



OWNER OF REPUBLIC OF KOREA REG. NO. 0686618, DATED 11-21-2006, EXPIRES 11-21-2016.

NO CLAIM IS MADE TO THE EXCLUSIVE RIGHT TO USE "LCOS LIQUID CRYSTAL ON SILICON", APART FROM THE MARK AS SHOWN.

FOR TELEVISION RECEIVERS; MP3 PLAYERS; RECORDED MESSAGE SENDERS; COMPACT DISC PLAYERS; COMPUTERS; NOTEBOOK COMPUTERS; TABLET PC; RADIOS; HANDSETS, NAMELY, TELEPHONE HANDSETS; WALKIE-TALKIES; SATELLITE TELEPHONES; LAND LINE TELEPHONES; DIGITAL CELLULAR PHONES; PERSONAL DIGITAL ASSISTANT (PDA); VIDEO CASSETTE PLAYERS; VIDEOPHONES; DRY CELL BATTERIES; DIGITAL CAMERAS (U.S. CLS. 21, 23, 26, 36 AND 38).

RICHARD A. STRASER, EXAMINING ATTORNEY

CLASS 9—(Continued).

SN 78-916,428. NILES AUDIO CORPORATION, MIAMI, FL. FILED 6-26-2006.



THE MARK CONSISTS OF STYLIZED "I" ENCLOSED IN AN ELLIPSE WITH THE MARK "iWARE" APPEARING TO THE RIGHT.

FOR ELECTRONIC DOCKING STATIONS, BATTERY CHARGERS, WIRED REMOTE CONTROLS, AND ELECTRONIC MEMORY CARD READERS FOR USE WITH HANDHELD DIGITAL ELECTRONIC DEVICES FOR RECORDING, ORGANIZING, TRANSMITTING, MANIPULATING, AND REVIEWING TEXT, DATA, AUDIO AND VIDEO FILES; COMPUTER SOFTWARE FOR INTEGRATING HANDHELD DIGITAL ELECTRONIC DEVICES WITH WHOLE HOUSE AUDIO AND/OR VIDEO SYSTEMS; ELECTRICAL CONNECTORS FOR USE WITH HANDHELD DIGITAL ELECTRONIC DEVICES FOR RECORDING, ORGANIZING, TRANSMITTING, MANIPULATING, AND REVIEWING TEXT, DATA, AUDIO AND VIDEO FILES, NAMELY, WIRES, CABLES, AND ADAPTORS; STANDS SPECIALLY DESIGNED FOR HOLDING PORTABLE AND HANDHELD DIGITAL ELECTRONIC DEVICES (U.S. CLS. 21, 23, 26, 36 AND 38).
SUNG IN, EXAMINING ATTORNEY

SN 78-804,784. GILLERMAN, JOANN, OAKLAND, CA. AND ROBERT TERRY, OAKLAND, CA. FILED 2-1-2006.

LIAISON SYSTEMS LIVE
INTERACTIVE ANIMAL
IDENTIFICATION SYSTEM AND
OBSERVATION NETWORK

THE MARK CONSISTS OF STANDARD CHARACTERS WITHOUT CLAIM TO ANY PARTICULAR FONT, STYLE, SIZE, OR COLOR.

NO CLAIM IS MADE TO THE EXCLUSIVE RIGHT TO USE "SYSTEMS LIVE INTERACTIVE ANIMAL IDENTIFICATION SYSTEM AND OBSERVATION NETWORK", APART FROM THE MARK AS SHOWN.

FOR AN ELECTRONIC SPOTTING SCOPE AND ACCOMPANYING COMPUTER HARDWARE FOR USE IN IDENTIFYING AND PROVIDING BIOLOGICAL INFORMATION CONCERNING SPECIFIC ANIMALS (U.S. CLS. 21, 23, 26, 36 AND 38).

FIRST USE 5-12-2005; IN COMMERCE 5-12-2005.
JOHN DWYER, EXAMINING ATTORNEY

SN 78-953,623. FORMING TECHNOLOGIES INCORPORATED, OAKVILLE, CANADA, FILED 8-16-2006.

FASTINCREMENTAL

THE MARK CONSISTS OF STANDARD CHARACTERS WITHOUT CLAIM TO ANY PARTICULAR FONT, STYLE, SIZE, OR COLOR.

PRIORITY CLAIMED UNDER SEC. 44(D) ON CANADA APPLICATION NO. 1313005, FILED 8-15-2006.

FOR COMPUTER AIDED ENGINEERING SOFTWARE USED PRIMARILY IN THE METAL STAMPING AND FORMING INDUSTRIES AND IN AUTOMOTIVE STYLING (U.S. CLS. 21, 23, 26, 36 AND 38).

JENNIFER VASQUEZ, EXAMINING ATTORNEY

CLASS 9—(Continued).

SN 78-959,027. EXPERT KNOWLEDGE SYSTEMS, LLC, WHITE PLAINS, NY. FILED 8-23-2006.

EXPERT KNOWLEDGE SYSTEMS

THE MARK CONSISTS OF STANDARD CHARACTERS WITHOUT CLAIM TO ANY PARTICULAR FONT, STYLE, SIZE, OR COLOR.

SEC. 2(F).

FOR COMPUTER SOFTWARE FOR ANALYSIS OF DATA IN THE FIELD OF MEDICINE, HEALTH, CLINICAL RESEARCH AND PHARMACEUTICAL PREPARATIONS; COMPUTER SOFTWARE FOR PRESENTATION OF DATA IN THE FIELD OF MEDICINE, HEALTH, CLINICAL RESEARCH AND PHARMACEUTICAL PREPARATIONS (U.S. CLS. 21, 23, 26, 36 AND 38).

FIRST USE 7-0-1996; IN COMMERCE 7-0-1996.

BONNIE LUKEN, EXAMINING ATTORNEY

SN 79-050,413. SUMCO CORPORATION, JAPAN, FILED 1-30-2008.

FORMOSA SUMCO TECHNOLOGY

THE MARK CONSISTS OF STANDARD CHARACTERS WITHOUT CLAIM TO ANY PARTICULAR FONT, STYLE, SIZE, OR COLOR.

PRIORITY DATE OF 7-31-2007 IS CLAIMED.

OWNER OF INTERNATIONAL REGISTRATION 0954791 DATED 1-30-2008, EXPIRES 1-30-2018.

OWNER OF U.S. REG. NOS. 2,880,968 AND 2,992,782.

NO CLAIM IS MADE TO THE EXCLUSIVE RIGHT TO USE "FORMOSA" AND "TECHNOLOGY", APART FROM THE MARK AS SHOWN.

THE FOREIGN WORDING IN THE MARK TRANSLATES INTO ENGLISH AS "TAIWAN".

FOR SOLAR CELLS; SILICON WAFERS FOR SOLAR CELLS; SEMICONDUCTOR WAFERS, NAMELY, COMPOUND SEMICONDUCTOR WAFERS, SOI (SILICON-ON-INSULATOR) WAFERS, AND STRAINED SILICON WAFERS; SEMICONDUCTOR SILICON WAFERS; SINGLE-CRYSTAL SILICON WAFERS; INGOTS OF SEMICONDUCTOR SILICON FOR MAKING SILICON WAFERS; SINGLE-CRYSTAL SILICON INGOTS FOR INTEGRATED CIRCUITS (U.S. CLS. 21, 23, 26, 36 AND 38).

MICHAEL WIENER, EXAMINING ATTORNEY

CLASS 9—(Continued).

SN 79-050,578. ICABLEHOLDER.COM PTY LIMITED, AUSTRALIA, FILED 9-25-2007.

 The logo for icableholder features the word "icableholder" in a lowercase, sans-serif font. The letter "o" in "holder" is replaced by a stylized orange circle with a white dot in the center, resembling a cable connector or a stylized 'o'.

PRIORITY DATE OF 8-26-2007 IS CLAIMED.
OWNER OF INTERNATIONAL REGISTRATION 0955247 DATED 9-25-2007, EXPIRES 9-25-2017.

THE COLOR(S) ORANGE, BLACK AND WHITE IS/ARE CLAIMED AS A FEATURE OF THE MARK.

THE MARK CONSISTS OF THE COLOR BLACK APPEARING IN THE WORDING "ICABLEHOLDER", THE COLOR ORANGE APPEARING IN THE STYLIZED CABLE HOLDER THAT APPEARS IN THE PLACE OF THE LETTER "O" IN "HOLDER" AND THE COLOR WHITE APPEARING IN THE ORANGE CABLE HOLDER DESIGN.

FOR A HOLDER FOR THE ORGANIZATION OF COMPUTER NETWORK CABLES FOR USE IN HOTELS, OFFICES, CONFERENCE FACILITIES, AND BUSINESS FACILITIES (U.S. CLS. 21, 23, 26, 36 AND 38).

SUZANNE BLANE, EXAMINING ATTORNEY

SN 79-051,969. LEISURETECH ELECTRONICS PTY LTD, ROSEBERY, AUSTRALIA, FILED 2-15-2008.

 The logo for forté electronics features the word "forté" in a large, elegant, cursive script font. Below it, the word "electronics" is written in a smaller, lowercase, sans-serif font.

PRIORITY DATE OF 2-4-2008 IS CLAIMED.

OWNER OF INTERNATIONAL REGISTRATION 0958970 DATED 2-15-2008, EXPIRES 2-15-2018.

NO CLAIM IS MADE TO THE EXCLUSIVE RIGHT TO USE "ELECTRONICS", APART FROM THE MARK AS SHOWN.

FOR AUDIO SYSTEMS AND MULTI-ROOM AUDIO SYSTEMS COMPRISING AN APPARATUS FOR RECORDING, TRANSMITTING AND REPRODUCING SOUND AND AUDIO VISUAL SIGNALS BY ANALOGUE OR DIGITAL MEANS, POWER MODULES, VOLUME CONTROLS, KEYPADS, HUBS, INTERCOMS AND POWER SUPPLIES (U.S. CLS. 21, 23, 26, 36 AND 38).

PATRICIA EVANKO, EXAMINING ATTORNEY

CLASS 9—(Continued).

SN 79-053,353. KONINKLIJKE PHILIPS ELECTRONICS N.V.,
BA EINDHOVEN, NETHERLANDS, FILED 11-22-2007.

APRICO.TV

THE MARK CONSISTS OF STANDARD CHARACTERS WITHOUT CLAIM TO ANY PARTICULAR FONT, STYLE, SIZE, OR COLOR.

PRIORITY DATE OF 6-1-2007 IS CLAIMED.
OWNER OF INTERNATIONAL REGISTRATION 0962969 DATED 11-22-2007, EXPIRES 11-22-2017.

THE TERM "APRICO" HAS NO MEANING IN A FOREIGN LANGUAGE.

FOR APPARATUS FOR RECORDING, TRANSMISSION AND REPRODUCTION OF SOUND OR IMAGES, NAMELY DVD VIDEO PLAYERS AND RECORDERS, AUDIO AND VIDEO PLAYERS AND RECORDERS, SET TOP BOXES, SATELLITE RECEIVERS, TELEVISION RECEIVERS, DIGITAL TELEVISION RECEIVERS, CABLE TELEVISION RECEIVERS AND DECODERS; REMOTE CONTROL UNITS FOR THESE GOODS; COMPUTERS, VIDEO GAME CONSOLES FOR USE WITH AN EXTERNAL DISPLAY SCREEN OR MONITOR; COMPUTER SOFTWARE AND INTERFACES FOR PROCESSING, ENCODING, DELIVERING AND CREATING PERSONAL TV CHANNELS BY COMBINING CONTENT FROM OTHER BROADCAST CHANNELS AND STREAMING RESOURCES FOR CONTENT AND AD PLACEMENT; ELECTRONIC PROGRAMMING GUIDES, NAMELY, COMPUTER PROGRAMS FEATURING INTERACTIVE ELECTRONIC PROGRAM GUIDE FOR A MULTICHANNEL AND ON-DEMAND AUDIO/VIDEO DISTRIBUTION NETWORK SUCH AS A CABLE TELEVISION DISTRIBUTION NETWORK (U.S. CLS. 21, 23, 26, 36 AND 38).

KELLY MCCOY, EXAMINING ATTORNEY

CLASS 9—(Continued).

SN 79-053,653. ACTIONS SEMICONDUCTOR CO., LTD.,
GUANGDONG, CHINA, FILED 5-19-2008.

炬力

OWNER OF INTERNATIONAL REGISTRATION 0963798 DATED 5-19-2008, EXPIRES 5-19-2018.

THE NON-LATIN CHARACTERS IN THE MARK TRANSLITERATE TO "JU LI", AND THIS HAS NO MEANING IN A FOREIGN LANGUAGE.

FOR INTEGRATED CIRCUITS (U.S. CLS. 21, 23, 26, 36 AND 38).

SEAN CROWLEY, EXAMINING ATTORNEY

SN 79-057,799. SUMMERMIND PUBLISHING S.L., SPAIN,
FILED 7-21-2008.

SN 79-053,652. ACTIONS SEMICONDUCTOR CO., LTD.,
GUANGDONG, CHINA, FILED 5-19-2008.



OWNER OF INTERNATIONAL REGISTRATION 0963797 DATED 5-19-2008, EXPIRES 5-19-2018.

THE MARK CONSISTS OF A STYLIZED LETTER "X" FORMED BY TWO SEMICIRCLES.

FOR INTEGRATED CIRCUITS (U.S. CLS. 21, 23, 26, 36 AND 38).

SEAN CROWLEY, EXAMINING ATTORNEY



PRIORITY DATE OF 4-9-2008 IS CLAIMED.
OWNER OF INTERNATIONAL REGISTRATION 0974491 DATED 7-21-2008, EXPIRES 7-21-2018.

NO CLAIM IS MADE TO THE EXCLUSIVE RIGHT TO USE "MOBILE", APART FROM THE MARK AS SHOWN.

THE COLOR(S) RED AND BLACK IS/ARE CLAIMED AS A FEATURE OF THE MARK.

THE MARK CONSISTS OF THE COLOR RED APPEARS IN THE WORDING "GEO" AND AS A STYLIZED GLOBE; THE COLOR BLACK APPEARS IN THE STYLIZED WORDING "MOBILE."

FOR COMPUTER PROGRAM INTENDED FOR MOBILE TELEPHONES, FOR USE AS A NAVIGATOR FOR BLIND PEOPLE (U.S. CLS. 21, 23, 26, 36 AND 38).

AISHA SALEM, EXAMINING ATTORNEY

CLASS 9—(Continued).

SN 79-058,489. TAIZHOU SOPRAY SOLAR CO., LTD., CHINA, FILED 6-27-2008.



OWNER OF INTERNATIONAL REGISTRATION 0976293 DATED 6-27-2008, EXPIRES 6-27-2018.

THE MARK CONSISTS OF THE STYLIZED LETTERS "TZSR" ENCOMPASSED BY AN INCOMPLETE CIRCLE, WITH A SHADED CIRCLE APPEARING ABOVE THE LETTER "T" IN "TZSR".

FOR MONOCRYSTALLINE SILICON SOLAR CELL MATERIAL FOR ELECTRICITY GENERATION; POLY-CRYSTALLINE SILICON SOLAR CELL MATERIAL FOR ELECTRICITY GENERATION; QUARTZ CRYSTAL FILTERS AND OSCILLATORS FOR USE IN THE FIELD OF COMMUNICATIONS EQUIPMENT; SOLAR BATTERIES; ACCUMULATOR JARS; SILICON WAFERS (U.S. CLS. 21, 23, 26, 36 AND 38).

ELI HELLMAN, EXAMINING ATTORNEY

SN 79-060,835. MYFC AB, SWEDEN, FILED 9-3-2008.

THE MARK CONSISTS OF STANDARD CHARACTERS WITHOUT CLAIM TO ANY PARTICULAR FONT, STYLE, SIZE, OR COLOR.

OWNER OF INTERNATIONAL REGISTRATION 0981926 DATED 9-3-2008, EXPIRES 9-3-2018.

FOR BATTERY CHARGERS; BATTERIES FOR TORCHES; ELECTRIC BATTERIES; CHARGERS FOR ELECTRIC BATTERIES (U.S. CLS. 21, 23, 26, 36 AND 38).

JEAN IM, EXAMINING ATTORNEY

CLASS 10—MEDICAL APPARATUS

SN 76-692,794. REDITHOTICS, INC., BROOKFIELD, CT, FILED 9-10-2008.

THE MARK CONSISTS OF STANDARD CHARACTERS WITHOUT CLAIM TO ANY PARTICULAR FONT, STYLE, SIZE, OR COLOR.

FOR ORTHOTIC INSERTS FOR FOOTWEAR (U.S. CLS. 26, 39 AND 44).

CARYN GLASSER, EXAMINING ATTORNEY

CLASS 10—(Continued).

SN 77-011,376. BODY VIBE INTERNATIONAL, LLC, SCOTTSDALE, AZ, FILED 10-1-2006.

THE MARK CONSISTS OF STANDARD CHARACTERS WITHOUT CLAIM TO ANY PARTICULAR FONT, STYLE, SIZE, OR COLOR.

OWNER OF U.S. REG. NOS. 958,119 AND 2,523,015.

NO CLAIM IS MADE TO THE EXCLUSIVE RIGHT TO USE "BODY" AND "INTERNATIONAL", APART FROM THE MARK AS SHOWN.

FOR EXERCISE MACHINES FOR THERAPEUTIC PURPOSES, NAMELY, EXERCISE MACHINES FOR ENHANCING TOTAL BODY HEALTH AND WELLNESS THROUGH MUSCLE TONING, FAT BURNING, CELLULITE REDUCTION, ENHANCING BONE DENSITY, LYMPHATIC DRAINING DETOXIFICATION, INCREASING BLOOD CIRCULATION, INCREASING OXYGEN UPTAKE AND DELIVERY TO TISSUES, AND INCREASING METABOLISM (U.S. CLS. 26, 39 AND 44).

FIRST USE 1-0-2006; IN COMMERCE 1-0-2006.

JIM RINGLE, EXAMINING ATTORNEY

SN 77-351,960. BIONESS INC., VALENCIA, CA, FILED 12-14-2007.

OWNER OF U.S. REG. NOS. 3,144,345 AND 3,144,347.

THE MARK CONSISTS OF THE WORD "BIONESS" AND AN ASTERISK DESIGN.

FOR ELECTRONIC STIMULATOR FOR NEUROSTIMULATION, NEUROMODULATION, NEUROREHABILITATION, AND NEURORECOVERY AND AUXILIARY DEVICES FOR THE SAME, NAMELY, REMOTE CONTROL DEVICES, CHARGER, CHARGING COILS, IMPLANTATION TOOLS, STIMULATING PROBES (U.S. CLS. 26, 39 AND 44).

FIRST USE 8-0-2004; IN COMMERCE 8-0-2004.

LINDA MICKLEBURGH, EXAMINING ATTORNEY

SN 77-406,422. KALYPTO MEDICAL, INC., HASTINGS, MN, FILED 2-26-2008.

THE MARK CONSISTS OF STANDARD CHARACTERS WITHOUT CLAIM TO ANY PARTICULAR FONT, STYLE, SIZE, OR COLOR.

NO CLAIM IS MADE TO THE EXCLUSIVE RIGHT TO USE "MEDICAL", APART FROM THE MARK AS SHOWN.

FOR MEDICAL DEVICES, NAMELY, A NEGATIVE PRESSURE WOUND THERAPY DEVICE USED TO PROMOTE WOUND HEALING (U.S. CLS. 26, 39 AND 44).

JORDAN BAKER, EXAMINING ATTORNEY

CLASS 10—(Continued).

SN 77-421,282. ARKRAY, INC., KYOTO, JAPAN, FILED 3-13-2008.

ASSURELANCE

THE MARK CONSISTS OF STANDARD CHARACTERS WITHOUT CLAIM TO ANY PARTICULAR FONT, STYLE, SIZE, OR COLOR.

OWNER OF U.S. REG. NO. 2,352,631.
 FOR MEDICAL DIAGNOSTIC APPARATUS, NAMELY, DIAGNOSTIC APPARATUS FOR URINE ANALYSIS, DIAGNOSTIC APPARATUS FOR BLOOD ANALYSIS, DIAGNOSTIC APPARATUS FOR BREATH ANALYSIS, DIAGNOSTIC BODY FLUID OSMOMETERS, DIAGNOSTIC APPARATUS FOR PHENOLSULFONPHTHALEIN TESTING, DIAGNOSTIC APPARATUS FOR MEASURING GLUCOSE, DIAGNOSTIC APPARATUS FOR MEASURING GLYCOHEMOGLOBIN, DIAGNOSTIC APPARATUS FOR MEASURING ELECTROLYTES, DIAGNOSTIC APPARATUS FOR MEASURING AMMONIA, DIAGNOSTIC APPARATUS FOR MEASURING KETONE-BODY, DIAGNOSTIC APPARATUS FOR MEASURING GLYCATED ALBUMIN, AND DIAGNOSTIC APPARATUS FOR MEASURING SALT INCLUDED IN BONES; ELECTRODES FOR MEDICAL USE; MEDICAL DIAGNOSTIC DEVICES FOR MEASURING BLOOD GLUCOSE LEVEL; MEDICAL ELECTRODES, NAMELY, TEST ELECTRODES FOR USE AS SENSORS OF BLOOD GLUCOSE; APPARATUS FOR TAKING BLOOD SAMPLES; LANCETS; BLOOD LANCETS; LANCET DEVICES FOR OBTAINING BLOOD OR CAPILLARY BLOOD; NEEDLES FOR MEDICAL PURPOSES; INJECTORS FOR MEDICAL PURPOSES (U.S. CLS. 26, 39 AND 44).

ROBERT LAVACHE, EXAMINING ATTORNEY

SN 77-430,596. MIAMI MEDICAL EQUIPMENT & SUPPLY CORP., MIAMI, FL. FILED 3-25-2008.

BURESET

THE MARK CONSISTS OF STANDARD CHARACTERS WITHOUT CLAIM TO ANY PARTICULAR FONT, STYLE, SIZE, OR COLOR.

FOR DISPOSABLE CALIBRATED SYRINGE FOR INTRAVENOUS USE (U.S. CLS. 26, 39 AND 44).
 FIRST USE 10-29-1985; IN COMMERCE 10-29-1985.
 JENNY PARK, EXAMINING ATTORNEY

CLASS 10—(Continued).

SN 77-436,719. BOSTON SCIENTIFIC SCIMED, INC., MAPLE GROVE, MN. FILED 4-1-2008.

TRIUMPH

THE MARK CONSISTS OF STANDARD CHARACTERS WITHOUT CLAIM TO ANY PARTICULAR FONT, STYLE, SIZE, OR COLOR.

FOR URETERAL STENTS (U.S. CLS. 26, 39 AND 44).
 KATINA MISTER, EXAMINING ATTORNEY

SN 77-449,831. SIEMENS MEDICAL SOLUTIONS USA, INC., MALVERN, PA. FILED 4-16-2008.

In-Line KView

THE MARK CONSISTS OF STANDARD CHARACTERS WITHOUT CLAIM TO ANY PARTICULAR FONT, STYLE, SIZE, OR COLOR.

THE WORDING "IN-LINE KVIEW" HAS NO MEANING IN A FOREIGN LANGUAGE.
 FOR MEDICAL IMAGING SYSTEM COMPRISED OF RADIATION THERAPY APPARATUS, USING KILOVOLTAGE IMAGING FOR OPTIMIZATION OF PATIENT TREATMENT (U.S. CLS. 26, 39 AND 44).
 SUE LAWRENCE, EXAMINING ATTORNEY

SN 77-474,106. J. VAILLANCOURT CORP. LTD., VERCHERES, QUEBEC, CANADA, FILED 5-14-2008.

ORTHOZIP

OWNER OF CANADA REG. NO. TMA729282, DATED 11-24-2008, EXPIRES 11-24-2023.

FOR ORTHOPEDIC BRACES AND SPLINTS; THERMOPLASTIC CASTS FOR ORTHOPEDIC PURPOSES (U.S. CLS. 26, 39 AND 44).
 DAVID ELTON, EXAMINING ATTORNEY

CLASS 10—(Continued).

SN 77-475,600. OCUSENSE, INC., SAN DIEGO, CA. FILED 5-15-2008.

TEAR TESTING MADE SIMPLE

THE MARK CONSISTS OF STANDARD CHARACTERS WITHOUT CLAIM TO ANY PARTICULAR FONT, STYLE, SIZE, OR COLOR.

NO CLAIM IS MADE TO THE EXCLUSIVE RIGHT TO USE "TEAR TESTING", APART FROM THE MARK AS SHOWN.

FOR MEDICAL DIAGNOSTIC APPARATUS AND SPECIMEN COLLECTION STRIPS THEREFOR (U.S. CLS. 26, 39 AND 44).

DAVID ELTON, EXAMINING ATTORNEY

SN 77-486,338. PROTEOR, SAINT APOLLINAIRE, FRANCE, FILED 5-29-2008.

AFLEX

THE MARK CONSISTS OF STANDARD CHARACTERS WITHOUT CLAIM TO ANY PARTICULAR FONT, STYLE, SIZE, OR COLOR.

FOR ORTHOTICS COMPONENTS, NAMELY, FLEXIBLE JOINTS (U.S. CLS. 26, 39 AND 44).

JENNIFER VASQUEZ, EXAMINING ATTORNEY

SN 77-512,383. AMCOR FLEXIBLES INC., MUNDELEIN, IL. FILED 7-1-2008.

TOWER-TEAR

THE MARK CONSISTS OF STANDARD CHARACTERS WITHOUT CLAIM TO ANY PARTICULAR FONT, STYLE, SIZE, OR COLOR.

OWNER OF U.S. REG. NO. 2,855,712.
FOR DISPOSABLE MEDICAL STERILIZATION PACKAGES, NAMELY, FLEXIBLE PLASTIC POUCHES (U.S. CLS. 26, 39 AND 44).

FIRST USE 11-2-1962; IN COMMERCE 11-2-1962.
GINA HAYES, EXAMINING ATTORNEY

CLASS 10—(Continued).

SN 77-513,880. PACESETTER, INC., DBA ST. JUDE MEDICAL CARDIAC RHYTHM MANAGEMENT DIVISION, SYLMAR, CA. FILED 7-2-2008.

QUARTET

THE MARK CONSISTS OF STANDARD CHARACTERS WITHOUT CLAIM TO ANY PARTICULAR FONT, STYLE, SIZE, OR COLOR.

FOR MEDICAL INSTRUMENTS, NAMELY, CARDIAC STIMULATION LEADS (U.S. CLS. 26, 39 AND 44).

CHARISMA HAMPTON, EXAMINING ATTORNEY

SN 77-524,700. ARES TRADING S.A., AUBONNE, SWITZERLAND, FILED 7-17-2008.

REBISMART

THE MARK CONSISTS OF STANDARD CHARACTERS WITHOUT CLAIM TO ANY PARTICULAR FONT, STYLE, SIZE, OR COLOR.

OWNER OF SWITZERLAND REG. NO. 568107, DATED 2-14-2008, EXPIRES 2-14-2018.

OWNER OF U.S. REG. NOS. 1,807,009, 3,179,304 AND OTHERS.

FOR MEDICAL APPARTUS AND INSTRUMENTS, NAMELY, INJECTION DEVICE FOR PHARMACEUTICALS (U.S. CLS. 26, 39 AND 44).

TINA BROWN, EXAMINING ATTORNEY

SN 77-529,382. REA, JAMES, VENTURA, CA. FILED 7-23-2008.

DRAGONFLY

THE MARK CONSISTS OF STANDARD CHARACTERS WITHOUT CLAIM TO ANY PARTICULAR FONT, STYLE, SIZE, OR COLOR.

FOR MEDICAL ELECTRODES (U.S. CLS. 26, 39 AND 44).

FIRST USE 2-11-2008; IN COMMERCE 6-3-2008.

HEATHER BIDDULPH, EXAMINING ATTORNEY

CLASS 10—(Continued).

SN 77-533,496. JOHN M. AGEE, DBA HAND BIOMECHANICS LAB, SACRAMENTO, CA. FILED 7-29-2008.

TURNKEY FCS

THE MARK CONSISTS OF STANDARD CHARACTERS WITHOUT CLAIM TO ANY PARTICULAR FONT, STYLE, SIZE, OR COLOR.

NO CLAIM IS MADE TO THE EXCLUSIVE RIGHT TO USE "FCS", APART FROM THE MARK AS SHOWN.

FOR MEDICAL DEVICES, NAMELY, A FINGER FIXATOR FOR A DISLOCATED MIDDLE PHALANX OR A FRACTURED DIGIT (U.S. CLS. 26, 39 AND 44).
ALEXANDER L. POWERS, EXAMINING ATTORNEY

SN 77-535,554. ATOM MEDICAL CORPORATION, TOKYO, JAPAN, FILED 7-31-2008.

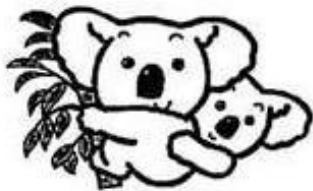

OWNER OF JAPAN REG. NO. 2245032, DATED 7-30-1990, EXPIRES 7-30-2010.

THE MARK CONSISTS OF TWO KOALAS AND A BRANCH WITH LEAVES.

FOR INCUBATORS FOR BABIES (U.S. CLS. 26, 39 AND 44).

JAY BESCH, EXAMINING ATTORNEY

SN 77-551,270. PACESETTER, INC., DBA ST. JUDE MEDICAL CARDIAC RHYTHM MANAGEMENT DIVISION, SYLMAR, CA. FILED 8-20-2008.

MERLIN@HOME

THE MARK CONSISTS OF STANDARD CHARACTERS WITHOUT CLAIM TO ANY PARTICULAR FONT, STYLE, SIZE, OR COLOR.

OWNER OF U.S. REG. NO. 3,473,632.

FOR MEDICAL APPARATUS AND EQUIPMENT, NAMELY, TRANSTELEPHONIC MONITOR THAT IS FOR USE IN ELECTRONIC ACQUISITION, CAPTURE AND TRANSMISSION OF MEDICAL DEVICE STATUS AND PATIENT MEDICAL AND PHYSIOLOGICAL DATA USED IN CONNECTION WITH IMPLANTABLE CARDIAC DEVICES, AND EXTERNAL OR IMPLANTABLE CARDIAC THERAPEUTIC OR DIAGNOSTIC DEVICES, EXCLUDING BALLOON CATHETERS AND STENTS (U.S. CLS. 26, 39 AND 44).

FIRST USE 8-1-2008; IN COMMERCE 8-1-2008.

FRANK LATTUCA, EXAMINING ATTORNEY

CLASS 10—(Continued).

SN 77-552,414. HISTOLOGICS LLC, HENDERSON, NV. FILED 8-21-2008.

KYLON

THE MARK CONSISTS OF STANDARD CHARACTERS WITHOUT CLAIM TO ANY PARTICULAR FONT, STYLE, SIZE, OR COLOR.

FOR MEDICAL DEVICES FOR USE IN PERFORMING BIOPSIES, NAMELY, FABRIC COMPRISED OF HOOK SHAPED FIBERS USED TO OBTAIN A BIOPSY FROM A BODY SURFACE OR CAVITY (U.S. CLS. 26, 39 AND 44).
HAI-LY LAM, EXAMINING ATTORNEY

SN 77-554,578. B.Y.O.G., HUNTINGTON BEACH, CA. FILED 8-25-2008.



NO CLAIM IS MADE TO THE EXCLUSIVE RIGHT TO USE "GOWN", APART FROM THE MARK AS SHOWN.

THE STIPPLING IS FOR SHADING PURPOSES ONLY.

THE MARK CONSISTS OF THE STYLIZED LETTERS AND WORDS "B.Y.O.G. BRING YOUR OWN GOWN". THE STYLIZED WORDS ARE INSIDE A RECTANGULAR SHAPE DESIGN WITH ROUNDED CORNERS. THE LETTER "B" IS SURROUNDED BY A HALF CIRCLE.

FOR MEDICAL GOWNS (U.S. CLS. 26, 39 AND 44).

FIRST USE 6-14-2007; IN COMMERCE 10-15-2007.

ROBIN CHOSID, EXAMINING ATTORNEY

SN 77-556,145. CVS PHARMACY, INC., WOONSOCKET, RI. FILED 8-26-2008.



OWNER OF U.S. REG. NOS. 919,941 AND 2,573,942.

THE MARK CONSISTS OF THE WORDS "CVS/PHARMACY" LOCATED ABOVE THE WORD "PEAS" WITH A DESIGN OF A PEAPOD POSITIONED ON ANGLE LOCATED DIRECTLY TO THE RIGHT OF THE WORD "PEAS".

FOR REUSABLE THERAPEUTIC PACKS FOR MEDICAL USE (U.S. CLS. 26, 39 AND 44).

MARK SPARACINO, EXAMINING ATTORNEY

CLASS 10—(Continued).

SN 77-557,556. SNYDER, JON, J. DBA NEUROS MEDICAL, KIRTLAND, OH. FILED 8-28-2008.

NEUROS Medical

THE MARK CONSISTS OF STANDARD CHARACTERS WITHOUT CLAIM TO ANY PARTICULAR FONT, STYLE, SIZE, OR COLOR.

NO CLAIM IS MADE TO THE EXCLUSIVE RIGHT TO USE "MEDICAL", APART FROM THE MARK AS SHOWN. FOR MEDICAL DEVICES, NAMELY, NEUROSTIMULATION FOR USE IN CHRONIC PAIN, MOTOR CONTROL, AND SPASTICITY APPLICATIONS (U.S. CLS. 26, 39 AND 44).

JILL C. ALT, EXAMINING ATTORNEY

SN 77-559,857. AXELSON, RENAE, J. ANCHORAGE, AK. FILED 9-2-2008.

Jointeaze

THE MARK CONSISTS OF STANDARD CHARACTERS WITHOUT CLAIM TO ANY PARTICULAR FONT, STYLE, SIZE, OR COLOR.

FOR CHEMICALLY ACTIVATED HOT AND COLD GEL PACKS FOR MEDICAL PURPOSES; CHEMICALLY ACTIVATED HOT AND/OR COLD COMPRESSES; MEDICAL ICE PACKS; NON-MEDICATED COMPRESSES; THERMAL PACKS FOR FIRST AID PURPOSES (U.S. CLS. 26, 39 AND 44).

AMY C. KEAN, EXAMINING ATTORNEY

SN 77-560,216. ZAGULA, MATTHEW J., DBA COMFORT STEPZ, GEORGETOWN, KY. FILED 9-2-2008.

Comfort Stepz

THE MARK CONSISTS OF STANDARD CHARACTERS WITHOUT CLAIM TO ANY PARTICULAR FONT, STYLE, SIZE, OR COLOR.

NO CLAIM IS MADE TO THE EXCLUSIVE RIGHT TO USE "COMFORT", APART FROM THE MARK AS SHOWN. FOR ORTHOTIC INSERTS FOR FOOTWEAR; ORTHOTICS FOR FEET (U.S. CLS. 26, 39 AND 44).

EDWARD NELSON, EXAMINING ATTORNEY

CLASS 10—(Continued).

SN 77-561,541. EARPOWER LLC, HOUSTON, TX. FILED 9-3-2008.

EarPower

THE MARK CONSISTS OF STANDARD CHARACTERS WITHOUT CLAIM TO ANY PARTICULAR FONT, STYLE, SIZE, OR COLOR.

FOR HEARING AIDS (U.S. CLS. 26, 39 AND 44).
LYDIA BELZER, EXAMINING ATTORNEY

SN 77-561,832. WILLIAM T. WILKINSON, MEDIA, PA. FILED 9-3-2008.

HEALTHY HANDS

THE MARK CONSISTS OF STANDARD CHARACTERS WITHOUT CLAIM TO ANY PARTICULAR FONT, STYLE, SIZE, OR COLOR.

NO CLAIM IS MADE TO THE EXCLUSIVE RIGHT TO USE "HANDS", APART FROM THE MARK AS SHOWN. FOR PHYSICAL EXERCISE APPARATUS, FOR MEDICAL PURPOSES (U.S. CLS. 26, 39 AND 44).

JOHN SCHUYLER YARD, EXAMINING ATTORNEY

SN 77-561,877. A LEG UP LLC, SEATTLE, WA. FILED 9-3-2008.

A LEG UP

THE MARK CONSISTS OF STANDARD CHARACTERS WITHOUT CLAIM TO ANY PARTICULAR FONT, STYLE, SIZE, OR COLOR.

FOR MEDICAL DEVICES, NAMELY, NON-MOTORIZED SCOOTERS, NAMELY, KNEE SCOOTERS AND KNEE WALKERS (U.S. CLS. 26, 39 AND 44).

FIRST USE 6-10-2004; IN COMMERCE 6-10-2004.

ROBIN CHOSID, EXAMINING ATTORNEY

CLASS 10—(Continued).

SN 77-562,171. LEMAITRE VASCULAR, INC., BURLINGTON, MA. FILED 9-4-2008.

ENDORE

THE MARK CONSISTS OF STANDARD CHARACTERS WITHOUT CLAIM TO ANY PARTICULAR FONT, STYLE, SIZE, OR COLOR.

FOR STENT DELIVERY SYSTEMS; SURGICAL DEVICES AND INSTRUMENTS; SURGICAL INSTRUMENTS AND APPARATUS; SYNTHETIC STENT GRAFTS (U.S. CLS. 26, 39 AND 44).

ARETHA SOMERVILLE, EXAMINING ATTORNEY

CLASS 10—(Continued).

SN 77-563,729. DMS HOLDINGS, INC., DBA MABIS HEALTHCARE AND DURO-MED INDUSTRIES, LAKE FOREST, IL. FILED 9-5-2008.

RediScan

THE MARK CONSISTS OF STANDARD CHARACTERS WITHOUT CLAIM TO ANY PARTICULAR FONT, STYLE, SIZE, OR COLOR.

FOR DURABLE MEDICAL GOODS, NAMELY, THERMOMETERS (U.S. CLS. 26, 39 AND 44).

NELSON SNYDER, EXAMINING ATTORNEY

SN 77-562,222. SOARING BENEFIT LIMITED, TAIPEI HSIEN, TAIWAN, FILED 9-4-2008.

Kinderlux

THE MARK CONSISTS OF STANDARD CHARACTERS WITHOUT CLAIM TO ANY PARTICULAR FONT, STYLE, SIZE, OR COLOR.

FOR THERMOMETERS FOR MEDICAL PURPOSES, ELECTRIC BLANKETS FOR MEDICAL PURPOSES, NASAL ASPIRATORS, NASAL LAVAGE VESSEL, ELECTRIC VAPORIZER FOR UPPER RESPIRATORY CONDITIONS, BREAST PUMPS (U.S. CLS. 26, 39 AND 44).

FIRST USE 7-18-2008; IN COMMERCE 8-2-2008.
KIM SAITO, EXAMINING ATTORNEY

SN 77-565,239. COVIDIEN AG, NEUHAUSEN AM RHEINFALL, SWITZERLAND, FILED 9-9-2008.

GATORGUARD

THE MARK CONSISTS OF STANDARD CHARACTERS WITHOUT CLAIM TO ANY PARTICULAR FONT, STYLE, SIZE, OR COLOR.

FOR CONTAINERS FOR MEDICAL WASTE (U.S. CLS. 26, 39 AND 44).

FIRST USE 10-31-1999; IN COMMERCE 10-31-1999.
IRA J. GOODSaid, EXAMINING ATTORNEY

SN 77-562,284. LEMAITRE VASCULAR, INC., BURLINGTON, MA. FILED 9-4-2008.

TAARGET

THE MARK CONSISTS OF STANDARD CHARACTERS WITHOUT CLAIM TO ANY PARTICULAR FONT, STYLE, SIZE, OR COLOR.

FOR MEDICAL STENTS; STENT DELIVERY SYSTEMS; STENTS; SYNTHETIC STENT GRAFTS (U.S. CLS. 26, 39 AND 44).

ARETHA SOMERVILLE, EXAMINING ATTORNEY

SN 77-565,747. CHI-SAN, LLC, SAN RAFAEL, CA. FILED 9-9-2008.

CHI-SAN

THE MARK CONSISTS OF STANDARD CHARACTERS WITHOUT CLAIM TO ANY PARTICULAR FONT, STYLE, SIZE, OR COLOR.

FOR MEDICAL DEVICES, NAMELY, PADS FOR RESPIRATOR MASKS (U.S. CLS. 26, 39 AND 44).

JENNIFER MARTIN, EXAMINING ATTORNEY

CLASS 10—(Continued).

SN 77-565,829. AMERICAN BREAST CARE, INC., MARIETTA, GA. FILED 9-9-2008.

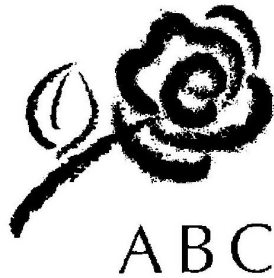

THE MARK CONSISTS OF A DESIGN OF A ROSE WITH THE LETTERS "ABC" UNDERNEATH IT.

FOR MEDICAL APPARATUS, NAMELY, POST MASTECTOMY BREAST PROSTHESIS (U.S. CLS. 26, 39 AND 44).

FIRST USE 4-1-2003; IN COMMERCE 4-1-2003.

ARETHA SOMERVILLE, EXAMINING ATTORNEY

SN 77-565,998. INTERNATIONAL TECHNIDYNE CORPORATION, EDISON, NJ. FILED 9-9-2008.

PROTIME INRHYTHM

THE MARK CONSISTS OF STANDARD CHARACTERS WITHOUT CLAIM TO ANY PARTICULAR FONT, STYLE, SIZE, OR COLOR.

OWNER OF U.S. REG. NO. 2,016,285.

FOR MEDICAL DEVICE, NAMELY, COAGULATION MEASURING INSTRUMENT, CUVETTE AND LANCETS FOR MEASURING BLOOD COAGULATION TIME (U.S. CLS. 26, 39 AND 44).

SUSAN RICHARDS, EXAMINING ATTORNEY

CLASS 10—(Continued).

SN 77-566,061. IMDP, LAS VEGAS, NV. FILED 9-9-2008.



NO CLAIM IS MADE TO THE EXCLUSIVE RIGHT TO USE "LLC", APART FROM THE MARK AS SHOWN.

THE MARK CONSISTS OF THE LETTER "P", THE LETTER "A", THE LETTER "D", THE LETTER "T", THE LETTER "E", THE LETTER "S", THE LETTER "T", THE LETTER "L", THE LETTER "L", AND THE LETTER "C". A GRAPHICAL ELECTRONIC SPIKE RUNS FROM THE LETTER "A" TO THE LETTER "E" AND FORMS THE CROSSBAR FOR THE LETTER "A" AND THE LETTER "E".

FOR MEDICAL DIAGNOSTIC APPARATUS, ANALYTICAL APPARATUS FOR MEDICAL PURPOSES AND BLOOD PRESSURE MEASURING APPARATUS (U.S. CLS. 26, 39 AND 44).

JAMES GRIFFIN, EXAMINING ATTORNEY

SN 77-566,248. CRITICAL CARE INNOVATIONS, INC., CHANTILLY, VA. FILED 9-10-2008.

COLORMARK

THE MARK CONSISTS OF STANDARD CHARACTERS WITHOUT CLAIM TO ANY PARTICULAR FONT, STYLE, SIZE, OR COLOR.

FOR MEDICAL ULTRASOUND VIBRATOR USED FOR DELIVERY OF PHARMACEUTICALS AND ACQUISITION OF TISSUES THROUGH NEEDLES, PROBES AND CATHETERS (U.S. CLS. 26, 39 AND 44).

APRIL ROACH, EXAMINING ATTORNEY

SN 77-566,304. BLISS PRODCUTS, LLC, MIAMI, FL. FILED 9-10-2008.

LOVERBAND

THE MARK CONSISTS OF STANDARD CHARACTERS WITHOUT CLAIM TO ANY PARTICULAR FONT, STYLE, SIZE, OR COLOR.

FOR ADULT SEXUAL STIMULATION AIDS, NAMELY, HARNESSSES (U.S. CLS. 26, 39 AND 44).

FIRST USE 9-16-2008; IN COMMERCE 11-14-2008.

PAUL E. FAHRENKOPF, EXAMINING ATTORNEY

CLASS 10—(Continued).

SN 77-566,306. SWEE HIN TEOH, SINGAPORE, SINGAPORE, AND SOI KHOON YEW, SINGAPORE, SINGAPORE, FILED 9-10-2008.

Osteoplug

THE MARK CONSISTS OF STANDARD CHARACTERS WITHOUT CLAIM TO ANY PARTICULAR FONT, STYLE, SIZE, OR COLOR.

FOR BONE IMPLANTS COMPOSED OF ARTIFICIAL MATERIALS (U.S. CLS. 26, 39 AND 44).
FIRST USE 6-1-2006; IN COMMERCE 6-29-2007.
GILBERT SWIFT, EXAMINING ATTORNEY

CLASS 10—(Continued).

SN 77-567,189. PATHOLASE, INC., CHICO, CA. FILED 9-10-2008.

PINPOINTE

THE MARK CONSISTS OF STANDARD CHARACTERS WITHOUT CLAIM TO ANY PARTICULAR FONT, STYLE, SIZE, OR COLOR.

FOR MEDICAL DEVICES, NAMELY, LIGHT-BASED MEDICAL DEVICES FOR TREATING INFECTION (U.S. CLS. 26, 39 AND 44).
ROBIN CHOSID, EXAMINING ATTORNEY

SN 77-566,370. VENTOR TECHNOLOGIES LTD., NETANYA, ISRAEL, FILED 9-10-2008.

VENTOR

THE MARK CONSISTS OF STANDARD CHARACTERS WITHOUT CLAIM TO ANY PARTICULAR FONT, STYLE, SIZE, OR COLOR.

FOR SUBCUTANEOUS VALVES FOR IMPLANTATION (U.S. CLS. 26, 39 AND 44).
ERIN FALK, EXAMINING ATTORNEY

SN 77-567,194. PATHOLASE, INC., CHICO, CA. FILED 9-10-2008.

PATHOLASE

THE MARK CONSISTS OF STANDARD CHARACTERS WITHOUT CLAIM TO ANY PARTICULAR FONT, STYLE, SIZE, OR COLOR.

FOR MEDICAL DEVICES, NAMELY, LIGHT-BASED MEDICAL DEVICES FOR TREATING INFECTION (U.S. CLS. 26, 39 AND 44).
ROBIN CHOSID, EXAMINING ATTORNEY

SN 77-566,904. DESCENT CONTROL SYSTEMS, INC., WEST JORDAN, UT. FILED 9-10-2008.

QuikSlyde

THE MARK CONSISTS OF STANDARD CHARACTERS WITHOUT CLAIM TO ANY PARTICULAR FONT, STYLE, SIZE, OR COLOR.

FOR STRETCHERS USED FOR PATIENT TRANSPORT AND FOR TRANSPORTING MEDICAL EQUIPMENT ATTACHED TO PATIENTS, FOR USE IN EVACUATING HOSPITALS (U.S. CLS. 26, 39 AND 44).
CARYN GLASSER, EXAMINING ATTORNEY

SN 77-567,334. YELATMA INSTRUMENT-MAKING ENTERPRISE, RYAZAN, RUSSIAN FED., FILED 9-11-2008.



THE COLOR(S) GREEN IS/ARE CLAIMED AS A FEATURE OF THE MARK.

THE MARK CONSISTS OF THE STYLIZED WORD "ELAMED" ENCLOSED WITHIN A RECTANGULAR SHAPE. A PLURALITY OF HORIZONTAL LINES/RAYS EXTENDS FROM THE RIGHT SIDE OF THE RECTANGULAR SHAPE, BENEATH THE LETTERS "AMED" OF THE WORD "ELAMED". A CIRCULAR SHAPE IS PRESENT TO THE LEFT OF THE FIRST LETTER "E." THE CIRCULAR SHAPE IS ALSO ENCLOSED WITHIN A RECTANGULAR SHAPE. A SCHEMATIC REPRESENTATION OF A FIR TREE, RESEMBLING TWO TRIANGLES IS POSITIONED TO THE LEFT OF THE FIRST LETTER "E", OVER THE

CLASS 10—(Continued).

CIRCLE. THE FIR TREE COMPRISES A BENT LINE EXTENDING DOWN THE CENTER OF THE FIR TREE, SAID BENT LINE SHARPLY BENDING FROM GENERALLY VERTICAL TO HORIZONTAL TOWARD THE BOTTOM OF THE FIR TREE. THE FIR TREE IS TALLER THAN THE HEIGHT OF THE CIRCULAR SHAPE AND THE HEIGHT OF THE RECTANGULAR SHAPE, AND THUS OBSCURES PARTS OF THE CIRCULAR SHAPE AND PARTS OF THE RECTANGULAR SHAPE. ALL ELEMENTS OF THE MARK APPEAR IN THE COLOR GREEN.

FOR APPARATUS FOR MAGNET THERAPY; APPARATUS FOR PHYSICAL TRAINING FOR MEDICAL USE; CASES FITTED FOR MEDICAL INSTRUMENTS AND/OR FOR USE BY DOCTORS; ELECTRODES FOR MEDICAL USE; ELECTROMAGNETIC DRUG DELIVERY APPARATUS FOR MEDICAL USE; ELECTROMEDICAL REHABILITATIVE AND PAIN MANAGEMENT PRODUCTS FOR CLINICAL AND HOME USE, NAMELY, ELECTRICAL NERVE AND MUSCLE STIMULATORS, ULTRASONIC STIMULATORS, MAGNET THERAPY STIMULATORS AND LASER THERAPY STIMULATORS; MAGNETS FOR MEDICAL PURPOSES; MASSAGE APPARATUS; MEDICAL DIAGNOSTIC APPARATUS, ANALYTICAL APPARATUS FOR MEDICAL PURPOSES AND BLOOD PRESSURE MEASURING APPARATUS; MEDICAL ELECTRODES; MEDICAL INSTRUMENTS FOR USE IN PATIENT REHABILITATION USING MAGNETIC AND/OR ELECTRIC STIMULI; SURGICAL DEVICES AND INSTRUMENTS; SURGICAL INSTRUMENTS AND APPARATUS (U.S. CLS. 26, 39 AND 44).

FIRST USE 0-0-2002; IN COMMERCE 2-0-2008.
GEOFFREY FOSDICK, EXAMINING ATTORNEY

SN 77-567,404. HEARTWARE, INC., MIAMI LAKES, FL. FILED 9-11-2008.



OWNER OF U.S. REG. NO. 3,151,263.

THE MARK CONSISTS OF THE WORD "HEARTWARE" TO THE LEFT AND ABOVE WHICH IS A FANCIFUL DESIGN COMPRISED OF DOTS IN THE SHAPE OF THE TOP OF A HEART.

FOR CIRCULATORY ASSIST PUMPS FOR USE AS VENTRICULAR ASSIST DEVICES IMPLANTED BY CARDIO AND VASCULAR SURGEONS (U.S. CLS. 26, 39 AND 44).

LINDA E. BLOHM, EXAMINING ATTORNEY

SN 77-568,208. PASQUALE, MICHEAL, HONOLULU, HI. FILED 9-11-2008.

Boob-A-Rang

THE MARK CONSISTS OF STANDARD CHARACTERS WITHOUT CLAIM TO ANY PARTICULAR FONT, STYLE, SIZE, OR COLOR.

FOR SURGICAL INSTRUMENTS FOR USE IN BREAST AUGMENTATION AND BUTTOCK AUGMENTATION (U.S. CLS. 26, 39 AND 44).

CYNTHIA TRIPI, EXAMINING ATTORNEY

CLASS 10—(Continued).

SN 77-575,329. SYNERGY USA, LLC., HOLLYWOOD, FL. FILED 9-22-2008.

VEINOTENS

THE MARK CONSISTS OF STANDARD CHARACTERS WITHOUT CLAIM TO ANY PARTICULAR FONT, STYLE, SIZE, OR COLOR.

FOR ELECTROTHERAPY PULSE MASSAGER AND TRANSCUTANEOUS ELECTRICAL NERVE STIMULATOR (U.S. CLS. 26, 39 AND 44).

MARK T. MULLEN, EXAMINING ATTORNEY

SN 77-582,478. CHI-SAN, LLC, SAN RAFAEL, CA. FILED 9-30-2008.



THE MARK CONSISTS OF AN INTERLOCKING DESIGN OF THE LETTERS "M", "L" AND "C".

FOR MEDICAL DEVICES, NAMELY, PADS FOR RESPIRATOR MASKS (U.S. CLS. 26, 39 AND 44).

JENNIFER MARTIN, EXAMINING ATTORNEY

SN 77-595,370. DEPUY, INC., WARSAW, IN. FILED 10-17-2008.

TiCellix

THE MARK CONSISTS OF STANDARD CHARACTERS WITHOUT CLAIM TO ANY PARTICULAR FONT, STYLE, SIZE, OR COLOR.

FOR ORTHOPAEDIC IMPLANTS MADE OF ARTIFICIAL MATERIALS AND PARTS THEREOF (U.S. CLS. 26, 39 AND 44).

CYNTHIA TRIPI, EXAMINING ATTORNEY

CLASS 10—(Continued).

SN 77-605,423. KOWA COMPANY, LTD., NAGOYA, JAPAN, FILED 10-31-2008.

ECHORUS

THE MARK CONSISTS OF STANDARD CHARACTERS WITHOUT CLAIM TO ANY PARTICULAR FONT, STYLE, SIZE, OR COLOR.

OWNER OF JAPAN REG. NO. 5178694, DATED 11-7-2008, EXPIRES 11-7-2018.

FOR MEDICAL MACHINES AND APPARATUS, NAMELY, ULTRASONOGRAPH; AND PARTS THERE-OF (U.S. CLS. 26, 39 AND 44).

FRED MANDIR, EXAMINING ATTORNEY

CLASS 10—(Continued).

SN 79-053,600. BSN MEDICAL GMBH, FED REP GERMANY, FILED 2-1-2008.

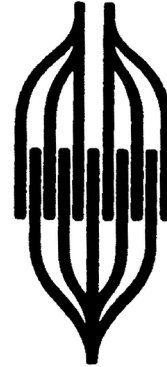

OWNER OF INTERNATIONAL REGISTRATION 0963640 DATED 2-1-2008, EXPIRES 2-1-2018.

OWNER OF U.S. REG. NOS. 829,854 AND 988,578.

THE MARK CONSISTS OF A MISCELLANEOUS DESIGN WITH AN OVERALL STYLIZED SPINDLE SHAPE, INCLUDING TWO SIMILAR HALF OVAL PIECES WITH INTERDIGITATING LINES AND BANDS.

FOR ORTHOPAEDIC BANDAGES AND HOSIERY, NAMELY, MEDICAL COMPRESSION STOCKINGS, TIGHTS AND SOCKS, MEDICAL SUPPORT STOCKINGS, TIGHTS AND SOCKS, SUPPORTS FOR MEDICAL AND ORTHOPAEDIC USE IN THE NATURE OF ELASTIC SINGLETTS FOR CHEST AND ABDOMEN SUPPORT, AND COMPRESSION SLEEVES IN THE NATURE OF SUPPORTS FOR ARMS FOR MEDICAL AND ORTHOPAEDIC PURPOSES; ADHESIVE TAPES AND ELASTIC SUPPORT, COMPRESSION BANDAGES FOR MEDICAL PURPOSES (U.S. CLS. 26, 39 AND 44).

LAURA HAMMEL, EXAMINING ATTORNEY

SN 79-052,741. OSACHI CO., LTD., NAGANO 394-0085, JAPAN, FILED 11-16-2007.

PAINVISION

SN 79-061,535. VASCULAR ENHANCEMENT; TECHNOLOGY PTY LTD, AUSTRALIA, FILED 8-8-2008.

OWNER OF INTERNATIONAL REGISTRATION 0961255 DATED 11-16-2007, EXPIRES 11-16-2017.

THE COLOR(S) BLACK AND RED IS/ARE CLAIMED AS A FEATURE OF THE MARK.

THE MARK CONSISTS OF THE STYLIZED WORD "PAINVISION", WITH THE EXCEPTION OF THE LETTER "V". THE WORDING IS BLACK. THE LETTER "V" IS RED. THE WHITE IN THE DRAWING REPRESENTS BACKGROUND AREAS AND IS NOT PART OF THE MARK.

FOR MEDICAL DEVICES AND ANALYZING APPARATUS FOR MEDICAL PURPOSES, ALL IN THE NATURE OF MEDICAL DEVICES FOR APPLYING ELECTRICAL STIMULATION AND OBJECTIVELY MEASURING A PATIENT'S PAIN BY QUANTIFYING THE RESULTS OF SUCH STIMULATION (U.S. CLS. 26, 39 AND 44).

MAUREEN DALL, EXAMINING ATTORNEY

V-PUMP

THE MARK CONSISTS OF STANDARD CHARACTERS WITHOUT CLAIM TO ANY PARTICULAR FONT, STYLE, SIZE, OR COLOR.

OWNER OF INTERNATIONAL REGISTRATION 0983608 DATED 8-8-2008, EXPIRES 8-8-2018.

FOR PERSONAL MEDICAL DEVICES FOR IMPROVING BLOOD CIRCULATION AND PREVENTING DEEP VEIN THROMBOSIS (U.S. CLS. 26, 39 AND 44).

DANNEAN HETZEL, EXAMINING ATTORNEY

**CLASS 11—ENVIRONMENTAL CONTROL AP-
PARATUS**

SN 76-688,144. HAMPTON PRODUCTS INTERNATIONAL CORPORATION, FOOTHILL RANCH, CA. FILED 3-28-2008.



OWNER OF U.S. REG. NO. 2,722,070.
NO CLAIM IS MADE TO THE EXCLUSIVE RIGHT TO USE "LIGHTING", APART FROM THE MARK AS SHOWN. FOR WALL AND CEILING LIGHTING FIXTURES FOR EXTERIOR AND/OR INTERIOR USE, AND EXTERIOR SECURITY LIGHTING FIXTURES WITHOUT A PHOTO SENSOR AND/OR A MOTION SENSOR; EXTERIOR SECURITY LIGHTING FIXTURES WITH A PHOTO SENSOR AND/OR A MOTION SENSOR (U.S. CLS. 13, 21, 23, 31 AND 34).
JULIE GUTTADAURO, EXAMINING ATTORNEY

SN 76-690,669. KING TECHNOLOGY, INC., HOPKINS, MN. FILED 6-19-2008.

MINERAL HYBRID

NO CLAIM IS MADE TO THE EXCLUSIVE RIGHT TO USE "MINERAL", APART FROM THE MARK AS SHOWN. FOR WATER TREATMENT EQUIPMENT IN THE NATURE OF CYCLERS FOR WATER TREATMENT CHEMICALS, NAMELY, ALGAECIDES AND BACTERICIDES FOR SWIMMING POOLS, SPAS, AND HOT TUBS; SALT-WATER CHLORINE GENERATOR FOR SWIMMING POOLS, SPAS, AND HOT TUBS (U.S. CLS. 13, 21, 23, 31 AND 34).
FIRST USE 1-16-2006; IN COMMERCE 1-16-2006.
DAVID TAYLOR, EXAMINING ATTORNEY

SN 76-690,670. KING TECHNOLOGY, INC., HOPKINS, MN. FILED 6-19-2008.

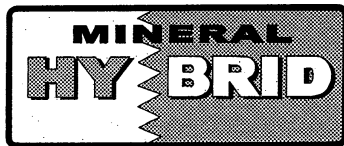

NO CLAIM IS MADE TO THE EXCLUSIVE RIGHT TO USE "MINERAL", APART FROM THE MARK AS SHOWN. THE MARK COMPRISES THE WORDS MINERAL IN DARKEN BOLD LETTERS, THE LETTERS "HY" IN SHADE ON A PLAIN BACKGROUND AND THE LETTERS "BRID" ON A SHADED BACKGROUND WITH A VERTICAL ZIG-ZAG LINE SEPARATING THE LETTERS "HY" WITH THE LETTERS "BRID" AND THE TWO BACKGROUNDS. FOR WATER TREATMENT EQUIPMENT IN THE NATURE OF CYCLERS FOR WATER TREATMENT CHEMICALS, NAMELY, ALGAECIDES AND BACTERICIDES FOR SWIMMING POOLS, SPAS, AND HOT TUBS; SALT-WATER CHLORINE GENERATOR FOR SWIMMING POOLS, SPAS, AND HOT TUBS (U.S. CLS. 13, 21, 23, 31 AND 34).
FIRST USE 1-16-2006; IN COMMERCE 1-16-2006.
DAVID TAYLOR, EXAMINING ATTORNEY

CLASS 11—(Continued).

SN 76-690,904. FRIDGE GUARD INC., FARGO, ND. FILED 6-27-2008.



NO CLAIM IS MADE TO THE EXCLUSIVE RIGHT TO USE "FRIDGE" AND "EFFECTIVE UP TO THREE MONTHS", APART FROM THE MARK AS SHOWN. THE MARK CONSISTS OF A COSTUMED POLAR BEAR HOLDING A COSTUMED PENGUIN STANDING IN SNOW, ALL IN A SHADED CIRCLE, WITH THE TERMS "GLOBAL COOLING" ABOVE THE DESIGN, THE TERMS "BUY FRIDGE GUARD" BELOW, AND A RECTANGLE WITH THE WORDS "EFFECTIVE UP TO THREE MONTHS" OVERLAPPING ON THE RIGHT SIDE OF THE CIRCLE. FOR REFRIGERATOR AND AIR COOLER AIR FILTERS FOR CONTROLLING ODORS AND EXCESS HUMIDITY (U.S. CLS. 13, 21, 23, 31 AND 34).
FIRST USE 2-4-2008; IN COMMERCE 2-4-2008.
HELENE LIWINSKI, EXAMINING ATTORNEY

SN 76-691,920. TNTJ CORPORATION, GARLAND, TX. FILED 8-8-2008.

My Eyes!

THE MARK CONSISTS OF STANDARD CHARACTERS WITHOUT CLAIM TO ANY PARTICULAR FONT, STYLE, SIZE, OR COLOR.
FOR ELECTRIC MASCARA WARMER (U.S. CLS. 13, 21, 23, 31 AND 34).
ARETHA SOMERVILLE, EXAMINING ATTORNEY

CLASS 11—(Continued).

SN 76-692,406. EVERSTAR MERCHANDISE CO., LTD, TAIPEI, TAIWAN, FILED 8-27-2008.



THE MARK CONSISTS OF THE WORDING "DIOD-TECH" IN A STYLIZED FONT SHADED TO SIMULATE A METALLIC OR REFLECTIVE SURFACE. TWO SIMILARLY SHADED CURVED BANDS APPEAR BELOW AND ABOVE THE WORDING. THE PHRASE "CHANGE IT FOR GOOD!" APPEARS BENEATH THE WORD "TECH" IN SMALLER BLOCK LETTERS.

FOR LED LIGHT BULBS (U.S. CLS. 13, 21, 23, 31 AND 34).
STEVEN PEREZ, EXAMINING ATTORNEY

SN 76-692,407. EVERSTAR MERCHANDISE CO., LTD, TAIPEI, TAIWAN, FILED 8-27-2008.



THE MARK CONSISTS OF THE WORDING "DIOD-TECH" IN A STYLIZED FONT SHADED TO SIMULATE A METALLIC OR REFLECTIVE SURFACE. TWO SIMILARLY SHADED CURVED BANDS APPEAR BELOW AND ABOVE THE WORDING.

FOR LED LIGHT BULBS (U.S. CLS. 13, 21, 23, 31 AND 34).
STEVEN PEREZ, EXAMINING ATTORNEY

SN 77-051,082. GOW, THOMAS W., COON RAPIDS, MN, FILED 11-27-2006.

REVOLUTION

THE MARK CONSISTS OF STANDARD CHARACTERS WITHOUT CLAIM TO ANY PARTICULAR FONT, STYLE, SIZE, OR COLOR.

FOR LIGHTING FIXTURES (U.S. CLS. 13, 21, 23, 31 AND 34).
JULIE GUTTADAURO, EXAMINING ATTORNEY

CLASS 11—(Continued).

SN 77-139,648. STREAMLINE WATER SOLUTIONS, LLC, SCOTTSDALE, AZ. FILED 3-25-2007.



NO CLAIM IS MADE TO THE EXCLUSIVE RIGHT TO USE WATER, APART FROM THE MARK AS SHOWN.

THE APPLICANT CLAIMS COLOR AS A FEATURE OF THE MARK, NAMELY, AQUA (LIGHT BLUE) AND BLACK.

THE MARK CONSISTS OF THREE WAVY BLUE LINES, STACKED HORIZONTALLY WITH A SMALL SPACE BETWEEN EACH LINE, FOLLOWED BY THE WORD "STREAMLINE", WITH THE FIRST LETTER OF "STREAMLINE" A CAPITAL "S" AND ALL THE LETTERS SET OUT IN THE COLOR BLACK, THEN FOLLOWED BY THE WORD WATER, WITH THE FIRST LETTER A CAPITAL "W" AND ALL THE LETTERS SET OUT IN THE COLOR AQUA (LIGHT BLUE), WITH NO SPACING BETWEEN "STREAMLINE" AND "WATER".

FOR WATER PURIFYING UNITS, FOR POTABLE WATER FOR DOMESTIC AND COMMERCIAL USE (U.S. CLS. 13, 21, 23, 31 AND 34).

FIRST USE 9-1-2006; IN COMMERCE 9-12-2006.
ODESSA BIBBINS, EXAMINING ATTORNEY

SN 77-146,006. ENTEGRIS, INC., CHASKA, MN. FILED 4-2-2007.

TORRENTO

THE MARK CONSISTS OF STANDARD CHARACTERS WITHOUT CLAIM TO ANY PARTICULAR FONT, STYLE, SIZE, OR COLOR.

FOR FLUID FILTRATION UNITS FOR INDUSTRIAL USE IN THE SEMICONDUCTOR INDUSTRY (U.S. CLS. 13, 21, 23, 31 AND 34).

KAREN SEVERSON, EXAMINING ATTORNEY

SN 77-150,047. PROFESSIONAL ENERGY SOLUTIONS, INC., TAMPA, FL. FILED 4-5-2007.

ZEROENERGY

THE MARK CONSISTS OF STANDARD CHARACTERS WITHOUT CLAIM TO ANY PARTICULAR FONT, STYLE, SIZE, OR COLOR.

THE WORDING "ZEROENERGY" HAS NO MEANING IN A FOREIGN LANGUAGE.

FOR THERMOSYPHON HEAT RECOVERY UNIT (U.S. CLS. 13, 21, 23, 31 AND 34).
NAKIA HENRY, EXAMINING ATTORNEY

CLASS 11—(Continued).

SN 77-385,651. MAAX US CORP., TORONTO, ONTARIO, CANADA, FILED 1-31-2008.

PEARL BATHS

THE MARK CONSISTS OF STANDARD CHARACTERS WITHOUT CLAIM TO ANY PARTICULAR FONT, STYLE, SIZE, OR COLOR.

OWNER OF U.S. REG. NO. 2,039,952.

NO CLAIM IS MADE TO THE EXCLUSIVE RIGHT TO USE "BATHS", APART FROM THE MARK AS SHOWN.

FOR WATER DISTRIBUTION APPARATUS AND SANITARY INSTALLATIONS, NAMELY, WHIRLPOOL BATHS, BATH TUBS, SHOWER BASES, TUB SHOWERS AND SHOWERS (U.S. CLS. 13, 21, 23, 31 AND 34).

SANI KHOURI, EXAMINING ATTORNEY

SN 77-407,198. GLOBAL FLOW PRODUCTS, LLC, DBA AMERICAN HVAC PRODUCTS, TULSA, OK. FILED 2-27-2008.

AMERICAN HVAC PRODUCTS

THE MARK CONSISTS OF STANDARD CHARACTERS WITHOUT CLAIM TO ANY PARTICULAR FONT, STYLE, SIZE, OR COLOR.

NO CLAIM IS MADE TO THE EXCLUSIVE RIGHT TO USE "HVAC PRODUCTS", APART FROM THE MARK AS SHOWN.

SEC. 2(F).

FOR HVAC ACCESSORIES, NAMELY, TANKS, VALVES, DIFFUSERS, HEAT EXCHANGERS, AIR SEPARATORS, AND PUMP CONNECTORS (U.S. CLS. 13, 21, 23, 31 AND 34).

FIRST USE 10-7-2002; IN COMMERCE 10-7-2002.
MELVIN AXILBUND, EXAMINING ATTORNEY

SN 77-429,292. KOHLER CO., KOHLER, WI. FILED 3-24-2008.

UNDERScore

THE MARK CONSISTS OF STANDARD CHARACTERS WITHOUT CLAIM TO ANY PARTICULAR FONT, STYLE, SIZE, OR COLOR.

FOR BATHTUBS (U.S. CLS. 13, 21, 23, 31 AND 34).

FIRST USE 4-11-2008; IN COMMERCE 4-11-2008.

NAPOLEON SHARMA, EXAMINING ATTORNEY

CLASS 11—(Continued).

SN 77-430,562. AIR-CURE DYNAMICS, INC., DBA D/B/A CEILCOTE AIR POLLUTION CONTROL, STRONGSVILLE, OH. FILED 3-25-2008.



THE MARK CONSISTS OF A WHIRLPOOL DESIGN. FOR ENVIRONMENTAL CONTROL EQUIPMENT FOR REMOVING POLLUTANTS FROM LIQUIDS AND GASES, NAMELY, IONIZED PARTICULATE SCRUBBERS FOR REMOVING PARTICULATES FROM THE AIR, COUNTERCURRENT SCRUBBERS, CROSSFLOW SCRUBBERS, FLUIDIZED-BED SCRUBBERS, IONIZING WET SCRUBBERS, PACKAGED SCRUBBERS, VENTURI SCRUBBERS, SIEVE TRAY SCRUBBERS, TOWER AND SCRUBBER PACKING MADE OF POLYPROPYLENE, POLYETHYLENE, PVC AND PVDF FOR USE IN AIR AND WATER PURIFYING EQUIPMENT SUCH AS PACKED TOWERS, GAS ABSORPTION TOWERS AND LIQUID DESORPTION TOWERS, MIST ELIMINATORS FOR COLLECTING LIQUID DROPLETS FROM GAS STREAMS; AIR PURIFICATION UNITS; AIR PURIFIERS; AIR PURIFYING UNITS FOR COMMERCIAL USE; AIR PURIFYING UNITS FOR INDUSTRIAL USE; VENTILATING EXHAUST FANS; ELECTRIC FANS FOR COMMERCIAL AND INDUSTRIAL USE, NAMELY, CENTRIFUGAL FANS AND AXIAL FANS FOR VENTILATION OF CORROSIVE AIR (U.S. CLS. 13, 21, 23, 31 AND 34).

ANNE FARRELL, EXAMINING ATTORNEY

SN 77-430,999. KOHLER CO., KOHLER, WI. FILED 3-25-2008.

CREVASSE

THE MARK CONSISTS OF STANDARD CHARACTERS WITHOUT CLAIM TO ANY PARTICULAR FONT, STYLE, SIZE, OR COLOR.

FOR SINKS (U.S. CLS. 13, 21, 23, 31 AND 34).

FIRST USE 4-11-2008; IN COMMERCE 4-11-2008.

KOURTNEE HODGES, EXAMINING ATTORNEY

CLASS 11—(Continued).

SN 77-431,334. KOHLER CO., KOHLER, WI. FILED 3-25-2008.

MIROVIA

THE MARK CONSISTS OF STANDARD CHARACTERS WITHOUT CLAIM TO ANY PARTICULAR FONT, STYLE, SIZE, OR COLOR.

FOR LAVATORIES (U.S. CLS. 13, 21, 23, 31 AND 34).
FIRST USE 4-11-2008; IN COMMERCE 4-11-2008.
KOURTNEE HODGES, EXAMINING ATTORNEY

SN 77-451,587. BSH HOME APPLIANCES CORPORATION,
HUNTINGTON BEACH, CA. FILED 4-18-2008.

AIRFRESH FILTER

THE MARK CONSISTS OF STANDARD CHARACTERS WITHOUT CLAIM TO ANY PARTICULAR FONT, STYLE, SIZE, OR COLOR.

NO CLAIM IS MADE TO THE EXCLUSIVE RIGHT TO USE "FILTER", APART FROM THE MARK AS SHOWN.

FOR HOUSEHOLD AND KITCHEN MACHINES AND EQUIPMENT, NAMELY, COOLING DEVICES, NAMELY, REFRIGERATORS, FREEZERS, COMBINATION REFRIGERATOR-FREEZERS, DEEP FREEZERS, ICE MAKING MACHINES; REPLACEMENT PARTS THEREFOR (U.S. CLS. 13, 21, 23, 31 AND 34).

HANNO RITTNER, EXAMINING ATTORNEY

SN 77-463,634. OZONE INTERNATIONAL, LLC, BAINBRIDGE ISLAND, WA. FILED 5-1-2008.

DUALSTREAM

THE MARK CONSISTS OF STANDARD CHARACTERS WITHOUT CLAIM TO ANY PARTICULAR FONT, STYLE, SIZE, OR COLOR.

FOR OZONE GENERATORS AND SANITIZERS FOR DISINFECTING GOODS, NAMELY, DEVICES THAT SPRAY OZONE-INFUSED WATER ONTO GOODS (U.S. CLS. 13, 21, 23, 31 AND 34).

LEIGH CAROLINE CASE, EXAMINING ATTORNEY

CLASS 11—(Continued).

SN 77-469,219. BSH HOME APPLIANCES CORPORATION, HUNTINGTON BEACH, CA. FILED 5-8-2008.

**XXL PROFESSIONAL
CONTINUOUS GRATES**

THE MARK CONSISTS OF STANDARD CHARACTERS WITHOUT CLAIM TO ANY PARTICULAR FONT, STYLE, SIZE, OR COLOR.

OWNER OF U.S. REG. NO. 3,118,016.

NO CLAIM IS MADE TO THE EXCLUSIVE RIGHT TO USE "PROFESSIONAL CONTINUOUS GRATES", APART FROM THE MARK AS SHOWN.

FOR HOUSEHOLD AND KITCHEN MACHINES AND EQUIPMENT, NAMELY, HEATING, STEAM PRODUCING, AND COOKING DEVICES, NAMELY, COOKING, BAKING, FRYING, GRILLING, TOASTING, THAWING, AND HOT-KEEPING APPARATUS, NAMELY, DOMESTIC COOKING OVENS, ELECTRIC AND GAS RANGES, COOKTOPS, WARMING DRAWERS SOLD AS PARTS OF OVENS, RANGES AND COOKTOPS; REPLACEMENT PARTS THEREFOR IN INTERNATIONAL CLASS 011 (U.S. CLS. 13, 21, 23, 31 AND 34).

HANNO RITTNER, EXAMINING ATTORNEY

SN 77-502,600. CAPTIVE-AIRE SYSTEMS, INC., RALEIGH, NC. FILED 6-19-2008.

CORE

THE MARK CONSISTS OF STANDARD CHARACTERS WITHOUT CLAIM TO ANY PARTICULAR FONT, STYLE, SIZE, OR COLOR.

FOR COMMERCIAL EXHAUST HOOD FOR KITCHENS (U.S. CLS. 13, 21, 23, 31 AND 34).

FIRST USE 10-0-2008; IN COMMERCE 10-0-2008.

WILLIAM P. SHANAHAN, EXAMINING ATTORNEY

SN 77-539,869. SUNWAY INTERNATIONAL INC., SAN DIEGO, CA. FILED 8-5-2008.



THE COLOR(S) LIGHT BLUE, DARK BLUE, YELLOW, ORANGE, GREEN, AND WHITE IS/ARE CLAIMED AS A FEATURE OF THE MARK.

THE MARK CONSISTS OF A LITERAL ELEMENT, "SUNWAY" IN STYLIZED LETTERING, AND A DESIGN ELEMENT CONSISTING OF A BALL, WHEREIN THE STYLIZED LETTER "S" APPEARS IN THE COLOR YELLOW THAT FADES INTO THE COLOR ORANGE AND WHEREIN FURTHER THE LETTER "S" IS WRAPPED AROUND THE BALL SUCH THAT THE "S" FORMS AN

CLASS 11—(Continued).

INTEGRAL PART OF THE EXTERIOR LAYER OF THE BALL, WHEREIN STILL FURTHER THE BALL APPEARS IN THE COLOR GREEN WITH SMALL REFLECTIONS OF LIGHT IN THE COLOR WHITE ON THE TOP AND LOWER PORTIONS OF THE BALL, AND WHEREIN THE BALL AND THE INTEGRATED LETTER "S" ARE SURROUNDED BY A CIRCULAR, AURA-LIKE LAYER APPEARING IN THE COLOR LIGHT BLUE, AND WHEREIN THE BALL WITH THE INTEGRATED LETTER "S" APPEAR ABOVE THE STYLIZED WORD "SUNWAY" WHOSE LETTER "S" APPEARS IN UPPERCASE IN THE COLOR YELLOW FADING TO ORANGE WHILE THE REMAINING LETTERS APPEAR IN LOWERCASE IN THE COLOR YELLOW FADING TO ORANGE, AND WHERE THE DESIGN AND LITERAL ELEMENTS ARE ALL SUPERIMPOSED UPON A RECTANGULAR BACKGROUND APPEARING IN THE COLOR DARK BLUE.

FOR LED (LIGHT EMITTING DIODE) LIGHTING FIXTURES; RED LED FLASHLIGHTS FOR ILLUMINATION PURPOSES (U.S. CLS. 13, 21, 23, 31 AND 34).

RONALD DELGIZZI, EXAMINING ATTORNEY

SN 77-549,088. DANThERM AIR HANDLING INC., SPARTANBURG, SC. FILED 8-18-2008.

ECOCOOLING

THE MARK CONSISTS OF STANDARD CHARACTERS WITHOUT CLAIM TO ANY PARTICULAR FONT, STYLE, SIZE, OR COLOR.

FOR AIR CONDITIONERS AND HEAT EXCHANGERS FOR THE TELECOMMUNICATIONS INDUSTRY (U.S. CLS. 13, 21, 23, 31 AND 34).

AMY ALFIERI, EXAMINING ATTORNEY

SN 77-554,402. BAILEY, WAYNE E., FREDERICKSBURG, VA. FILED 8-24-2008.

sol lucet

THE MARK CONSISTS OF STANDARD CHARACTERS WITHOUT CLAIM TO ANY PARTICULAR FONT, STYLE, SIZE, OR COLOR.

NO CLAIM IS MADE TO THE EXCLUSIVE RIGHT TO USE "SOL", APART FROM THE MARK AS SHOWN.

THE ENGLISH TRANSLATION OF "SOL LUCET" IS SUN OR SUN SHINING.

FOR HEATING SYSTEMS FOR RESIDENTIAL AND COMMERCIAL BUILDINGS COMPRISED OF BOILERS, VALVES, PIPES, MANIFOLDS, SOLAR PANELS, CONTROL PANEL, SWITCHES AND ELECTRIC WIRE, ALL SOLD AS A UNIT (U.S. CLS. 13, 21, 23, 31 AND 34).

SKYE YOUNG, EXAMINING ATTORNEY

CLASS 11—(Continued).

SN 77-562,674. RANDOLPH, O. L., IRVING, TX. FILED 9-4-2008.

BEAV-IT

THE MARK CONSISTS OF STANDARD CHARACTERS WITHOUT CLAIM TO ANY PARTICULAR FONT, STYLE, SIZE, OR COLOR.

FOR PLUMBING FITTINGS, NAMELY, WATER CUT-OFF VALVES FOR USE IN TOILETS (U.S. CLS. 13, 21, 23, 31 AND 34).

MICHAEL LITZAU, EXAMINING ATTORNEY

SN 77-565,301. NATURE'S COOLING SOLUTIONS, LLC, BRENTWOOD, TN. FILED 9-9-2008.

NATURE'S COOLING SOLUTIONS

THE MARK CONSISTS OF STANDARD CHARACTERS WITHOUT CLAIM TO ANY PARTICULAR FONT, STYLE, SIZE, OR COLOR.

FOR ELECTRIC FANS (U.S. CLS. 13, 21, 23, 31 AND 34).

SUNG IN, EXAMINING ATTORNEY

SN 77-565,786. FERGUSON ENTERPRISES, INC., NEWPORT NEWS, VA. FILED 9-9-2008.

BRADENTON

THE MARK CONSISTS OF STANDARD CHARACTERS WITHOUT CLAIM TO ANY PARTICULAR FONT, STYLE, SIZE, OR COLOR.

FOR PLUMBING FIXTURES, NAMELY, SINKS, PED-ESTAL SINKS, BATH TUBS, FAUCETS AND TOILETS (U.S. CLS. 13, 21, 23, 31 AND 34).

SOPHIA S. KIM, EXAMINING ATTORNEY

CLASS 11—(Continued).

SN 77-565,875. FERGUSON ENTERPRISES, INC., NEWPORT NEWS, VA. FILED 9-9-2008.

CORDOBA

THE MARK CONSISTS OF STANDARD CHARACTERS WITHOUT CLAIM TO ANY PARTICULAR FONT, STYLE, SIZE, OR COLOR.
OWNER OF U.S. REG. NO. 3,535,254.
FOR PLUMBING FIXTURES, NAMELY, FAUCETS AND BATH TUBS (U.S. CLS. 13, 21, 23, 31 AND 34).
KELLY BOULTON, EXAMINING ATTORNEY

SN 77-565,907. FERGUSON ENTERPRISES, INC., NEWPORT NEWS, VA. FILED 9-9-2008.

KEY WEST

THE MARK CONSISTS OF STANDARD CHARACTERS WITHOUT CLAIM TO ANY PARTICULAR FONT, STYLE, SIZE, OR COLOR.
FOR PLUMBING FIXTURES, NAMELY, FAUCETS AND BATH TUBS (U.S. CLS. 13, 21, 23, 31 AND 34).
KELLY BOULTON, EXAMINING ATTORNEY

SN 77-565,925. FERGUSON ENTERPRISES, INC., NEWPORT NEWS, VA. FILED 9-9-2008.

MARICOPA

THE MARK CONSISTS OF STANDARD CHARACTERS WITHOUT CLAIM TO ANY PARTICULAR FONT, STYLE, SIZE, OR COLOR.
FOR PLUMBING FIXTURES, NAMELY, SINKS, PED-ESTAL SINKS, BATH TUBS, FAUCETS AND TOILETS (U.S. CLS. 13, 21, 23, 31 AND 34).
KELLY BOULTON, EXAMINING ATTORNEY

CLASS 11—(Continued).

SN 77-565,941. COMFORT SYSTEMS USA, INC., HOUSTON, TX. FILED 9-9-2008.

HELIOS

THE MARK CONSISTS OF STANDARD CHARACTERS WITHOUT CLAIM TO ANY PARTICULAR FONT, STYLE, SIZE, OR COLOR.
FOR SOLAR COLLECTORS USED IN HEATING RESIDENTIAL AND COMMERCIAL BUILDINGS (U.S. CLS. 13, 21, 23, 31 AND 34).
NAKIA HENRY, EXAMINING ATTORNEY

SN 77-565,947. COMFORT SYSTEMS USA, INC., HOUSTON, TX. FILED 9-9-2008.



THE MARK CONSISTS OF THE LITERAL ELEMENT OF "HELIOS" WITH THE "O" BEING THE SUN.
FOR SOLAR COLLECTORS USED IN HEATING RESIDENTIAL AND COMMERCIAL BUILDINGS (U.S. CLS. 13, 21, 23, 31 AND 34).
NAKIA HENRY, EXAMINING ATTORNEY

SN 77-566,032. FILLMAN, RICHARD, LITTLE RIVER, SC. FILED 9-9-2008.

SCENTBLASTER

THE MARK CONSISTS OF STANDARD CHARACTERS WITHOUT CLAIM TO ANY PARTICULAR FONT, STYLE, SIZE, OR COLOR.
FOR ELECTRICAL DEVICE USED FOR EMITTING FRAGRANCES IN AIR DUCTS OF HOMES (U.S. CLS. 13, 21, 23, 31 AND 34).
DAVID I, EXAMINING ATTORNEY

CLASS 11—(Continued).

SN 77-566,052. SUNOVIA ENERGY TECHNOLOGIES, INC., SARASOTA, FL. FILED 9-9-2008.

IMPULSE

THE MARK CONSISTS OF STANDARD CHARACTERS WITHOUT CLAIM TO ANY PARTICULAR FONT, STYLE, SIZE, OR COLOR.

FOR TEMPORARY LIGHTING SYSTEM USED IN CASE OF POWER OUTAGES, COMPRISED OF LED LIGHTS, ELECTRIC POWER SENSORS, AND PANEL FIXTURES (U.S. CLS. 13, 21, 23, 31 AND 34).

JAMES GRIFFIN, EXAMINING ATTORNEY

CLASS 11—(Continued).

SN 77-571,612. PERLMUTTER, THOM, PORTSMOUTH, RI. FILED 9-16-2008.

U-R-IN CONTROL

THE MARK CONSISTS OF STANDARD CHARACTERS WITHOUT CLAIM TO ANY PARTICULAR FONT, STYLE, SIZE, OR COLOR.

FOR MOBILE MALE URINE RETENTION DEVICE, NAMELY A DISPOSABLE SEALING PLASTIC BAG FOR USE BY A MALE TO QUICKLY RELIEVE A FULL BLADDER IN A PRIVATE LOCATION (U.S. CLS. 13, 21, 23, 31 AND 34).

JAMES A. RAUEN, EXAMINING ATTORNEY

SN 77-566,407. STANDEX INTERNATIONAL CORPORATION, SALEM, NH. FILED 9-10-2008.

CombiKing

THE MARK CONSISTS OF STANDARD CHARACTERS WITHOUT CLAIM TO ANY PARTICULAR FONT, STYLE, SIZE, OR COLOR.

FOR OVENS, PARTS AND FITTINGS FOR OVENS (U.S. CLS. 13, 21, 23, 31 AND 34).

LESLEY LAMOTHE, EXAMINING ATTORNEY

SN 78-902,480. LG ELECTRONICS INC., SEOUL, REPUBLIC OF KOREA, FILED 6-7-2006.

ECO V

THE MARK CONSISTS OF STANDARD CHARACTERS WITHOUT CLAIM TO ANY PARTICULAR FONT, STYLE, SIZE, OR COLOR.

OWNER OF REPUBLIC OF KOREA REG. NO. 0693236, DATED 1-9-2007, EXPIRES 1-9-2017.

NO CLAIM IS MADE TO THE EXCLUSIVE RIGHT TO USE "ECO", APART FROM THE MARK AS SHOWN.

FOR AIR CONDITIONERS (U.S. CLS. 13, 21, 23, 31 AND 34).

ALYSSA STEEL, EXAMINING ATTORNEY

SN 77-568,427. DENTSPLY INTERNATIONAL INC., YORK, PA. FILED 9-12-2008.

CERAMFIRE

THE MARK CONSISTS OF STANDARD CHARACTERS WITHOUT CLAIM TO ANY PARTICULAR FONT, STYLE, SIZE, OR COLOR.

FOR DENTAL OVENS (U.S. CLS. 13, 21, 23, 31 AND 34).

HENRY S. ZAK, EXAMINING ATTORNEY

SN 78-938,354. AVERD CO., LTD., ILSANDONG-KU, REPUBLIC OF KOREA, FILED 7-26-2006.

DREAMSTAR

THE MARK CONSISTS OF STANDARD CHARACTERS WITHOUT CLAIM TO ANY PARTICULAR FONT, STYLE, SIZE, OR COLOR.

FOR ELECTRIC LIGHTING FIXTURES; FLUORESCENT LAMP TUBES; LAMPS (U.S. CLS. 13, 21, 23, 31 AND 34).

SANJEEV VOHRA, EXAMINING ATTORNEY

CLASS 11—(Continued).

SN 79-053,163. JOSPER, S.A., SPAIN, FILED 2-15-2008.

JOSPER

THE MARK CONSISTS OF STANDARD CHARACTERS WITHOUT CLAIM TO ANY PARTICULAR FONT, STYLE, SIZE, OR COLOR.

PRIORITY DATE OF 10-22-2007 IS CLAIMED.
OWNER OF INTERNATIONAL REGISTRATION 0962443 DATED 2-15-2008, EXPIRES 2-15-2018.

FOR COOKING APPARATUS, NAMELY, KITCHEN ELECTRIC RANGES, GAS RANGES, CHARCOAL OVEN GRILLS, BARBECUE OVEN GRILLS; BARBECUE OVEN GRILLS WITH HEAT RECUPERATORS; DIRECT-FIRED CHARCOAL COOKERS AND OVENS, NAMELY, CHARCOAL GRILLS AND GAS COOKING OVENS (U.S. CLS. 13, 21, 23, 31 AND 34).

CHARISMA HAMPTON, EXAMINING ATTORNEY

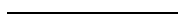

SN 79-053,359. RENTSCHLER REVEN-LÜFTUNGSSYSTEME GMBH, FED REP GERMANY, FILED 3-19-2008.

X-CYCLONE

THE MARK CONSISTS OF STANDARD CHARACTERS WITHOUT CLAIM TO ANY PARTICULAR FONT, STYLE, SIZE, OR COLOR.

PRIORITY DATE OF 11-24-2007 IS CLAIMED.
OWNER OF INTERNATIONAL REGISTRATION 0962976 DATED 3-19-2008, EXPIRES 3-19-2018.

FOR EXTRACTOR HOODS AND VENTILATION CEILINGS IN THE NATURE OF MULTIPLE EXTRACTOR HOODS MADE OF STAINLESS STEEL, ALUMINUM, COPPER OR SHEET STEEL; AIR CONDITIONING, AIR COOLING AND VENTILATION APPARATUS AND INSTRUMENTS; VENTILATION AND AIR-CONDITIONING INSTALLATIONS; AIR FILTERS FOR AIR CONDITIONING UNITS AND EXTRACTOR HOODS; SEPARATORS FOR THE CLEANING AND PURIFICATION OF AIR AND GASES; INDUSTRIAL AIR FILTER MACHINES (U.S. CLS. 13, 21, 23, 31 AND 34).

SHANNON TWOHIG, EXAMINING ATTORNEY



SN 79-053,851. NUOVA SIMONELLI SPA, ITALY, FILED 2-26-2008.

COMPETIZIONE

THE MARK CONSISTS OF STANDARD CHARACTERS WITHOUT CLAIM TO ANY PARTICULAR FONT, STYLE, SIZE, OR COLOR.

PRIORITY DATE OF 12-20-2007 IS CLAIMED.
OWNER OF INTERNATIONAL REGISTRATION 0964338 DATED 2-26-2008, EXPIRES 2-26-2018.

THE ENGLISH TRANSLATION OF THE WORD "COMPETIZIONE" IN THE MARK IS "COMPETITION".

FOR ELECTRIC ESPRESSO MACHINES, TEMPERATURE CONTROLLED BEVERAGE DISPENSERS IN THE NATURE OF COFFEE AND DRINK DISPENSERS, ICE CREAM MAKING MACHINES, REFRIGERATORS, REFRIGERATED DRINK DISPENSERS (U.S. CLS. 13, 21, 23, 31 AND 34).

LAURA HAMMEL, EXAMINING ATTORNEY

CLASS 11—(Continued).

SN 79-053,852. NUOVA SIMONELLI SPA, ITALY, FILED 2-26-2008.

TALENTO

THE MARK CONSISTS OF STANDARD CHARACTERS WITHOUT CLAIM TO ANY PARTICULAR FONT, STYLE, SIZE, OR COLOR.

PRIORITY DATE OF 12-20-2007 IS CLAIMED.
OWNER OF INTERNATIONAL REGISTRATION 0964339 DATED 2-26-2008, EXPIRES 2-26-2018.

THE ENGLISH TRANSLATION OF THE WORD "TALENTO" IN THE MARK IS "TALENT".

FOR ELECTRIC ESPRESSO MACHINES, TEMPERATURE CONTROLLED BEVERAGE DISPENSERS IN THE NATURE OF COFFEE AND DRINK DISPENSERS, ICE CREAM MAKING MACHINES, REFRIGERATORS, REFRIGERATED DRINK DISPENSERS (U.S. CLS. 13, 21, 23, 31 AND 34).

LAURA HAMMEL, EXAMINING ATTORNEY



SN 79-053,929. FDV - FIRME DI VETRO S.P.A., SALZANO (VENEZIA), ITALY, FILED 1-31-2008.

FdV • FIRME DI VETRO

PRIORITY DATE OF 12-18-2007 IS CLAIMED.
OWNER OF INTERNATIONAL REGISTRATION 0964561 DATED 1-31-2008, EXPIRES 1-31-2018.

OWNER OF U.S. REG. NO. 2,896,835.
NO CLAIM IS MADE TO THE EXCLUSIVE RIGHT TO USE "DI VETRO", APART FROM THE MARK AS SHOWN.
THE ENGLISH TRANSLATION OF THE FOREIGN WORD(S) IN THE MARK IS: "FDV" SIGNATURES OF GLASS.

FOR LAMPS, NAMELY, ELECTRIC AND GAS LAMPS, HALOGEN LAMPS, TABLE LAMPS, HANGING LAMPS, MODULAR LAMPS, WALL LAMPS, CHANDELIERS AND REPLACEMENT LAMP PARTS THEREFOR (U.S. CLS. 13, 21, 23, 31 AND 34).

HELENE LIWINSKI, EXAMINING ATTORNEY

CLASS 11—(Continued).

SN 79-058,561. ZHONGSHAN HUAYI LAMPS GROUP; CO., LTD, ZHONGSHAN CITY, CHINA, FILED 7-4-2008.



OWNER OF INTERNATIONAL REGISTRATION 0976473 DATED 7-4-2008. EXPIRES 7-4-2018.

NO CLAIM IS MADE TO THE EXCLUSIVE RIGHT TO USE "LAMPS", APART FROM THE MARK AS SHOWN.

THE COLOR(S) BLUE, BLACK AND ORANGE IS/ARE CLAIMED AS A FEATURE OF THE MARK.

THE MARK CONSISTS OF THE COLORS BLUE, BLACK AND ORANGE, WITH THE COLORS BLUE AND ORANGE APPEARING IN THE WORDING "HY"; THE WORDING "HUAYI LAMPS" AND THE TWO CHINESE CHARACTERS WHOSE TRANSLITERATION IS "HUAYI" APPEAR IN BLACK.

THE NON-LATIN CHARACTERS IN THE MARK TRANSLITERATE TO "HUA YI" AND "HUA" MEANS PROSPEROUS IN ENGLISH, "YI" MEANS ART IN ENGLISH AND THE COMBINATION OF THE TWO CHARACTERS HAS NO MEANING IN A FOREIGN LANGUAGE.

FOR READING LAMPS; WALL LAMPS; LAMPS; FLARES; STREET LAMPS; CEILING LAMPS; LIGHT DIFFUSERS; CHINESE LANTERNS; ELECTRIC LIGHTS FOR CHRISTMAS TREES (U.S. CLS. 13, 21, 23, 31 AND 34).

ROBERT STRUCK, EXAMINING ATTORNEY

CLASS 12—VEHICLES

SN 76-180,585. MICHIGAN WHEEL CORPORATION, GRAND RAPIDS, MI. FILED 12-13-2000.

VORTEX

FOR MARINE PROPELLERS (U.S. CLS. 19, 21, 23, 31, 35 AND 44).

FIRST USE 2-1-2001; IN COMMERCE 2-7-2001.

JOHN SCHUYLER YARD, EXAMINING ATTORNEY

SN 76-535,746. TREADWAYS, LLC, EAST NORRITON, PA. FILED 8-11-2003.

SPORT TOUR SUV

SEC. 2(F).

FOR TIRES (U.S. CLS. 19, 21, 23, 31, 35 AND 44).

FIRST USE 12-0-2003; IN COMMERCE 12-0-2003.

JASON LOTT, EXAMINING ATTORNEY

CLASS 12—(Continued).

SN 76-692,650. ALEXANDER MARINE CO., LTD., KAOHSIUNG, TAIWAN, FILED 9-9-2008.



S B O W

THE COLOR(S) GREY, NAVY BLUE, MEDIUM BLUE, LIGHT BLUE AND WHITE IS/ARE CLAIMED AS A FEATURE OF THE MARK.

THE MARK CONSISTS OF THE LETTERS "S B O W". CENTERED ABOVE IS A DOUBLE-BORDERED CIRCLE CONTAINING A STYLIZED "S" REPRESENTING THE BOW OF A VESSEL, AND TWO HORIZONTAL LINES DEPICTING WAVES. THE COLOR GREY APPEARS IN THE LETTERS "S B O W"; THE COLOR NAVY BLUE APPEARS IN THE OUTER OUTLINE OF THE CIRCLE AND WITHIN THE UPPER HALF OF THE BACKGROUND SHADING; THE COLORS MEDIUM AND LIGHT BLUE APPEARS IN THE LOWER HALF OF THE CIRCLE AS THE SHADED BACKGROUND; THE COLOR WHITE APPEARS IN THE STYLIZED "S" AND HORIZONTAL LINES, THE INNER BORDER OF THE CIRCLE AND AS SHADING IN THE BACKGROUND.

FOR YACHTS (U.S. CLS. 19, 21, 23, 31, 35 AND 44).

FIRST USE 7-10-2008; IN COMMERCE 7-10-2008.

CARYN GLASSER, EXAMINING ATTORNEY

SN 76-692,651. ALEXANDER MARINE CO., LTD., KAOHSIUNG, TAIWAN, FILED 9-9-2008.

S B O W

THE MARK CONSISTS OF THE CAPITAL LETTERS "SBOW", THE FIRST LETTER OF WHICH WORD IS BOLDER THAN THE OTHERS.

FOR YACHTS (U.S. CLS. 19, 21, 23, 31, 35 AND 44).

FIRST USE 7-10-2008; IN COMMERCE 7-10-2008.

CARYN GLASSER, EXAMINING ATTORNEY

CLASS 12—(Continued).

SN 77-359,624. TAN-EI-SYA CO., LTD., IMIZU, TOYAMA 936-0036, JAPAN, FILED 12-26-2007.



THE COLOR(S) RED AND BLACK IS/ARE CLAIMED AS A FEATURE OF THE MARK.

THE MARK CONSISTS OF A RED GEOMETRIC SHAPE TO THE LEFT OF THE CAPITAL LETTER "T"; THE REMAINDER OF THE MARK CONSISTS OF STYLIZED BLACK LETTERS.

FOR AUTOMOBILES AND TRUCKS AND STRUCTURAL PARTS THEREFOR; VEHICLE ALLOY WHEELS, INCLUDING ALUMINUM OR MAGNESIUM WHEELS FOR VEHICLES (U.S. CLS. 19, 21, 23, 31, 35 AND 44).

JOHN SCHUYLER YARD, EXAMINING ATTORNEY

CLASS 12—(Continued).

SN 77-396,655. CYCLES ARGON-18 INC., MONTREAL, CANADA, FILED 2-14-2008.



THE MARK CONSISTS OF STANDARD CHARACTERS WITHOUT CLAIM TO ANY PARTICULAR FONT, STYLE, SIZE, OR COLOR.

FOR BICYCLES AND STRUCTURAL PARTS THEREFOR, NAMELY, FRAMES AND BICYCLE PARTS, NAMELY, FORKS, SEAT POST, STEM, HANDLEBARS, BRAKES, RIMS FOR WHEELS, CRANKS, WHEELS, SADDLES, GEAR WHEELS (U.S. CLS. 19, 21, 23, 31, 35 AND 44).

FIRST USE 0-0-1989; IN COMMERCE 11-16-1999.
DANIEL CAPSHAW, EXAMINING ATTORNEY

SN 77-363,534. FORD MOTOR COMPANY OF CANADA, LIMITED, OAKVILLE, ONTARIO, CANADA, FILED 1-3-2008.

POWERED BY YOU

THE MARK CONSISTS OF STANDARD CHARACTERS WITHOUT CLAIM TO ANY PARTICULAR FONT, STYLE, SIZE, OR COLOR.

OWNER OF CANADA REG. NO. TMA729624, DATED 11-27-2008, EXPIRES 11-27-2023.

FOR LAND MOTOR VEHICLES, NAMELY, AUTOMOBILES AND THEIR STRUCTURAL PARTS AND ENGINES (U.S. CLS. 19, 21, 23, 31, 35 AND 44).

BRIAN PINO, EXAMINING ATTORNEY

SN 77-399,277. HORTON, INC., ROSEVILLE, MN. FILED 2-18-2008.

DM ADVANTAGE

THE MARK CONSISTS OF STANDARD CHARACTERS WITHOUT CLAIM TO ANY PARTICULAR FONT, STYLE, SIZE, OR COLOR.

OWNER OF U.S. REG. NO. 2,341,640.
FOR CLUTCHES FOR LAND VEHICLES (U.S. CLS. 19, 21, 23, 31, 35 AND 44).

CHRIS WELLS, EXAMINING ATTORNEY

SN 77-380,346. ALTO PRODUCTS CORPORATION, ALTMORE, AL. FILED 1-25-2008.

CASESAVER

THE MARK CONSISTS OF STANDARD CHARACTERS WITHOUT CLAIM TO ANY PARTICULAR FONT, STYLE, SIZE, OR COLOR.

FOR METAL COVERS USED TO COVER AUTOMOTIVE SHOCK PARTS (U.S. CLS. 19, 21, 23, 31, 35 AND 44).

FIRST USE 10-1-2000; IN COMMERCE 10-1-2001.
CAROLINE WOOD, EXAMINING ATTORNEY

SN 77-403,205. TRW AUTOMOTIVE LTDA., LIMEIRA, BRAZIL, FILED 2-21-2008.



OWNER OF U.S. REG. NO. 2,365,527.

THE MARK CONSISTS OF THE WORD "VARGA," IN CAPITAL LETTERS, POSITIONED INTERMEDIATE A PAIR OF STRAIGHT, HORIZONTALLY EXTENDING, PARALLEL LINES. THE WORD "VARGA" AND THE PAIR OF PARALLEL LINES ARE CIRCUMSCRIBED BY AN ELONGATED, OBLONG BORDER.

SEC. 2(F).

FOR BRAKE AND BRAKE PARTS FOR VEHICLES, NAMELY, MODULES, ABS, DISC BRAKES, BRAKE ROTORS, BRAKE PADS, DRUM BRAKES, BOOSTERS, MASTER CYLINDERS, BRAKE AIR COMPRESSORS, BRAKE AIR VALVES AND WHEEL CYLINDERS (U.S. CLS. 19, 21, 23, 31, 35 AND 44).

KOURTNEE HODGES, EXAMINING ATTORNEY

CLASS 12—(Continued).

SN 77-405,090. FIELD & STREAM LICENSES COMPANY, WESTPORT, CT. FILED 2-25-2008.



NO CLAIM IS MADE TO THE EXCLUSIVE RIGHT TO USE "FIELD TESTED" AND "GUIDE APPROVED", APART FROM THE MARK AS SHOWN.

THE MARK CONSISTS OF THE WORDING "FIELD TESTED GUIDE APPROVED" AND THE STYLIZED VIEW OF A CANOE WITH PADDLES WITHIN A CIRCLE.

FOR KAYAKS, CANOES, CARTOP KAYAK AND CANOE CARRIER KITS, KAYAK AND CANOE EQUIPMENT, NAMELY, KAYAK AND CANOE PADDLES AND OARS (U.S. CLS. 19, 21, 23, 31, 35 AND 44).

KIMBERLY FRYE, EXAMINING ATTORNEY

SN 77-407,053. FIELD & STREAM LICENSES COMPANY, WESTPORT, CT. FILED 2-27-2008.



OWNER OF U.S. REG. NOS. 2,352,120, 2,699,103 AND OTHERS.

NO CLAIM IS MADE TO THE EXCLUSIVE RIGHT TO USE "FIELD TESTED," "1871," AND "GUIDE APPROVED", APART FROM THE MARK AS SHOWN.

THE MARK CONSISTS OF THE DESIGN OF AN EAGLE ABOVE THE WORDING "FIELD & STREAM FIELD TESTED 1871 GUIDE APPROVED." A BROKEN HORIZONTAL LINE APPEARS BELOW THE WORDING "FIELD & STREAM" AND ABOVE THE WORDING "FIELD TESTED GUIDE APPROVED". THE NUMBER 1871 APPEARS IN THE MIDDLE OF THE BREAK IN THE LINE.

FOR KAYAKS, CANOES, PONTOON BOATS, INFLATABLE RAFTS FOR CAMPING AND FISHING, FISHING BOATS, CARTOP CARRIER KITS FOR KAYAKS AND CANOES, PADDLES AND OARS, KAYAK, CANOE AND BOAT ACCESSORIES, NAMELY, FITTED CANVAS COVERS AND ENCLOSURES, AND WATER DEFLECTING SKIRTS (U.S. CLS. 19, 21, 23, 31, 35 AND 44).

DAVID ELTON, EXAMINING ATTORNEY

CLASS 12—(Continued).

SN 77-420,464. BIXLER'S MARINE INC, RINGWOOD, NJ. FILED 3-12-2008.



NO CLAIM IS MADE TO THE EXCLUSIVE RIGHT TO USE "SOFTCHOCKS", APART FROM THE MARK AS SHOWN.

THE STIPLING IS FOR SHADING PURPOSES ONLY.

THE MARK CONSISTS OF THE STYLIZED TEXT "SOFTCHOCKS BY BIXLER'S" WITH A BOAT HULL DESIGN ABOVE THE TEXT "SOFTCHOCK".

FOR BOAT CHOCKS TO AFFIX AN INFLATABLE TENDER TO A LARGER BOAT OR DOCK (U.S. CLS. 19, 21, 23, 31, 35 AND 44).

REBECCA POVARCHUK, EXAMINING ATTORNEY

SN 77-433,400. GOLFCART HEADGEAR, LLC, JACKSONVILLE, FL. FILED 3-27-2008.

CART CAPZ

THE MARK CONSISTS OF STANDARD CHARACTERS WITHOUT CLAIM TO ANY PARTICULAR FONT, STYLE, SIZE, OR COLOR.

NO CLAIM IS MADE TO THE EXCLUSIVE RIGHT TO USE "CART", APART FROM THE MARK AS SHOWN.

FOR AFTERMARKET STRUCTURAL REPLACEMENT PARTS FOR MOTORIZED GOLF CARTS, NAMELY, REPLACEMENT DOMED ROOFS WITH ADDITIONAL STORAGE CAPACITY AND VISUAL ADVERTISING SPACE NOT IN THE NATURE OF FITTED COVERS (U.S. CLS. 19, 21, 23, 31, 35 AND 44).

ANDREA HACK, EXAMINING ATTORNEY

SN 77-444,305. HOBIE CAT COMPANY, OCEANSIDE, CA. FILED 4-9-2008.

MIRAGEDRIVE

THE MARK CONSISTS OF STANDARD CHARACTERS WITHOUT CLAIM TO ANY PARTICULAR FONT, STYLE, SIZE, OR COLOR.

FOR WATER VEHICLE PARTS, NAMELY, HUMAN POWERED PROPULSION SYSTEMS FOR KAYAKS COMPRISED OF PEDALS, A POWER TRANSFER MECHANISM AND UNDERWATER FLIPPERS (U.S. CLS. 19, 21, 23, 31, 35 AND 44).

KATHERINE CHANG, EXAMINING ATTORNEY

CLASS 12—(Continued).

SN 77-448,204. MOTOR WHEEL COMMERCIAL VEHICLE SYSTEMS, INC., CANTON, MI. FILED 4-15-2008.

CENTRISET

THE MARK CONSISTS OF STANDARD CHARACTERS WITHOUT CLAIM TO ANY PARTICULAR FONT, STYLE, SIZE, OR COLOR.
 FOR WHEEL HUBS AND HUB COMPONENTS, NAMELY, WHEEL STUBS, WHEEL BEARINGS AND BEARING CUPS (U.S. CLS. 19, 21, 23, 31, 35 AND 44).
 FIRST USE 12-8-2007; IN COMMERCE 12-8-2007.
 GINA FINK, EXAMINING ATTORNEY

CLASS 12—(Continued).

SN 77-460,243. HANGZHOU YUHANG INTERNATIONAL TRADING INC., LINPING TOWN,HANGZHOU, CHINA, FILED 4-29-2008.



THE MARK CONSISTS OF A TRIANGLE BELOW WHICH ARE THE LETTERS O.G.C IN A STYLIZED FONT. INSIDE THE TRIANGLE IS A DESIGN OF A MAN RIDING A MOTORCYCLE BELOW WHICH ARE A NUT, SCREW AND FASTENERS WHICH SPELL THE LETTERS O.G.C.
 FOR CLUTCH MECHANISMS FOR MOTOR CARS; CLUTCHES FOR LAND VEHICLES; HUB CAPS; HUBS FOR MOTORCYCLE VEHICLE WHEELS; BRAKES FOR LAND VEHICLES; BRAKING SYSTEMS FOR VEHICLES AND PARTS THEREOF; MOTORS FOR LAND VEHICLES; REARVIEW MIRRORS; AUTOMOBILES; AUTOMOBILES AND STRUCTURAL PARTS THEREFOR; MOTORCYCLES; MOTORCYCLES AND STRUCTURAL PARTS THEREFOR; DIRECTIONAL SIGNALS FOR VEHICLES; TURN SIGNALS FOR VEHICLES; MOTORIZED TAILGATES FOR TRUCKS (U.S. CLS. 19, 21, 23, 31, 35 AND 44).
 FIRST USE 4-1-2008; IN COMMERCE 4-1-2008.
 ERNEST SHOSHO, EXAMINING ATTORNEY

SN 77-451,127. JB DESIGN, INC., BERE A, OH. FILED 4-17-2008.

CLASSICS FOREVER

THE MARK CONSISTS OF STANDARD CHARACTERS WITHOUT CLAIM TO ANY PARTICULAR FONT, STYLE, SIZE, OR COLOR.
 FOR EXHAUST COMPONENTS, NAMELY, EXHAUST PIPES, MUFFLERS, MANIFOLDS AND HEADERS (U.S. CLS. 19, 21, 23, 31, 35 AND 44).
 BENJAMIN OKEKE, EXAMINING ATTORNEY

SN 77-509,363. AMERICAN RACING EQUIPMENT, LLC, RANCHO DOMINGUEZ, CA. FILED 6-26-2008.

AMERICAN RACING PRO SERIES

THE MARK CONSISTS OF STANDARD CHARACTERS WITHOUT CLAIM TO ANY PARTICULAR FONT, STYLE, SIZE, OR COLOR.
 OWNER OF U.S. REG. NOS. 863,444, 2,001,979 AND OTHERS.
 NO CLAIM IS MADE TO THE EXCLUSIVE RIGHT TO USE "RACING PRO SERIES", APART FROM THE MARK AS SHOWN.
 FOR AUTOMOTIVE VEHICLE WHEELS (U.S. CLS. 19, 21, 23, 31, 35 AND 44).
 FIRST USE 2-11-2003; IN COMMERCE 2-11-2003.
 TRACY CROSS, EXAMINING ATTORNEY

CLASS 12—(Continued).

SN 77-526,108. EAGLE SPECIALTY VEHICLES GROUP, LLC,
AMELIA, OH. FILED 7-18-2008.

COUPE DE FLEUR

THE MARK CONSISTS OF STANDARD CHARACTERS WITHOUT CLAIM TO ANY PARTICULAR FONT, STYLE, SIZE, OR COLOR.

NO CLAIM IS MADE TO THE EXCLUSIVE RIGHT TO USE "DE FLEUR", APART FROM THE MARK AS SHOWN. THE ENGLISH TRANSLATION OF THE FRENCH TERMINOLOGY "DE FLEUR" IS OF FLOWERS.

FOR FUNERAL VEHICLES, NAMELY, FLOWER COACHES, HEARSEs AND TRUCKS (U.S. CLS. 19, 21, 23, 31, 35 AND 44).

RAUL CORDOVA, EXAMINING ATTORNEY

SN 77-526,129. EAGLE SPECIALTY VEHICLES GROUP, LLC,
AMELIA, OH. FILED 7-18-2008.

ECHELON LIMITED

THE MARK CONSISTS OF STANDARD CHARACTERS WITHOUT CLAIM TO ANY PARTICULAR FONT, STYLE, SIZE, OR COLOR.

NO CLAIM IS MADE TO THE EXCLUSIVE RIGHT TO USE "LIMITED", APART FROM THE MARK AS SHOWN.

FOR FUNERAL VEHICLES, NAMELY, FUNERAL COACHES, HEARSEs (U.S. CLS. 19, 21, 23, 31, 35 AND 44).

RAUL CORDOVA, EXAMINING ATTORNEY

SN 77-526,148. EAGLE SPECIALTY VEHICLES GROUP, LLC,
AMELIA, OH. FILED 7-18-2008.

ECHELON-L LIMITED

THE MARK CONSISTS OF STANDARD CHARACTERS WITHOUT CLAIM TO ANY PARTICULAR FONT, STYLE, SIZE, OR COLOR.

NO CLAIM IS MADE TO THE EXCLUSIVE RIGHT TO USE "LIMITED", APART FROM THE MARK AS SHOWN.

FOR FUNERAL VEHICLES, NAMELY, FUNERAL COACHES, HEARSEs (U.S. CLS. 19, 21, 23, 31, 35 AND 44).

RAUL CORDOVA, EXAMINING ATTORNEY

CLASS 12—(Continued).

SN 77-534,486. GUARDIAN INDUSTRIES CORP., AUBURN
HILLS, MI. FILED 7-30-2008.

PRIVAGREEN

THE MARK CONSISTS OF STANDARD CHARACTERS WITHOUT CLAIM TO ANY PARTICULAR FONT, STYLE, SIZE, OR COLOR.

OWNER OF U.S. REG. NO. 2,166,281.
FOR FINISHED GLASS WINDOWS FOR VEHICLES (U.S. CLS. 19, 21, 23, 31, 35 AND 44).

PAULA MAHONEY, EXAMINING ATTORNEY

SN 77-536,578. MELFE, RICHARD, CARLSBAD, CA. FILED
7-31-2008.

VENETO SCOOTERS

THE MARK CONSISTS OF STANDARD CHARACTERS WITHOUT CLAIM TO ANY PARTICULAR FONT, STYLE, SIZE, OR COLOR.

NO CLAIM IS MADE TO THE EXCLUSIVE RIGHT TO USE "SCOOTERS", APART FROM THE MARK AS SHOWN. FOR MOTORIZED SCOOTERS (U.S. CLS. 19, 21, 23, 31, 35 AND 44).

MEGHAN REINHART, EXAMINING ATTORNEY

SN 77-544,704. HUSTED, JOEL, FOREST, VA. FILED 8-12-
2008.

ZINGER

THE MARK CONSISTS OF STANDARD CHARACTERS WITHOUT CLAIM TO ANY PARTICULAR FONT, STYLE, SIZE, OR COLOR.

FOR POWERED WHEELCHAIRS; SYSTEMS CONSISTING PRIMARILY OF MOTORS AND BATTERIES FOR POWERING OTHERWISE MANUAL WHEELCHAIRS (U.S. CLS. 19, 21, 23, 31, 35 AND 44).

FIRST USE 8-11-2008; IN COMMERCE 8-11-2008.
MICHAEL SOUDERS, EXAMINING ATTORNEY

CLASS 12—(Continued).

SN 77-548,189. MRF LTD, CHENNAI, INDIA, FILED 8-15-2008.

MUSCLELIFT

THE MARK CONSISTS OF STANDARD CHARACTERS WITHOUT CLAIM TO ANY PARTICULAR FONT, STYLE, SIZE, OR COLOR.

FOR TIRES, INNER TUBES, MUD FLAPS AND RUBBER TREADS, ALL OF THE FOREGOING FOR VEHICLES (U.S. CLS. 19, 21, 23, 31, 35 AND 44).

KATHERINE CHANG, EXAMINING ATTORNEY

CLASS 12—(Continued).

SN 77-557,317. JAMES WILLIAM CHILSON, WEST COVINA, CA. FILED 8-27-2008.

Samurai Shifter

THE MARK CONSISTS OF STANDARD CHARACTERS WITHOUT CLAIM TO ANY PARTICULAR FONT, STYLE, SIZE, OR COLOR.

NO CLAIM IS MADE TO THE EXCLUSIVE RIGHT TO USE "SHIFTER", APART FROM THE MARK AS SHOWN.

FOR GEAR LEVER KNOBS (U.S. CLS. 19, 21, 23, 31, 35 AND 44).

TARA PATE, EXAMINING ATTORNEY

SN 77-548,206. MRF LTD, CHENNAI, INDIA, FILED 8-15-2008.

LIFT X

THE MARK CONSISTS OF STANDARD CHARACTERS WITHOUT CLAIM TO ANY PARTICULAR FONT, STYLE, SIZE, OR COLOR.

FOR TIRES, INNER TUBES, MUD FLAPS AND RUBBER TREADS, ALL OF THE FOREGOING FOR VEHICLES (U.S. CLS. 19, 21, 23, 31, 35 AND 44).

KATHERINE CHANG, EXAMINING ATTORNEY

SN 77-559,162. SHIMANO INC., SAKAI CITY, JAPAN, FILED 8-29-2008.



SN 77-548,216. MRF LTD, CHENNAI, INDIA, FILED 8-15-2008.

LIFT XL

THE MARK CONSISTS OF STANDARD CHARACTERS WITHOUT CLAIM TO ANY PARTICULAR FONT, STYLE, SIZE, OR COLOR.

FOR TIRES, INNER TUBES, MUD FLAPS, AND RUBBER TREADS, ALL OF THE FOREGOING FOR VEHICLES (U.S. CLS. 19, 21, 23, 31, 35 AND 44).

KATHERINE CHANG, EXAMINING ATTORNEY

THE MARK CONSISTS OF A SERIES OF CURVED AND ARCHED LINES.

FOR ELECTRIC BICYCLES, BICYCLES, AND THEIR PARTS AND FITTINGS, NAMELY, HUBS, INTERNAL GEAR HUBS, BICYCLE DYNAMOS HUBS, HUB QUICK RELEASE LEVERS, HUB QUICK RELEASE DEVICES, GEAR RELEASE LEVERS, GEAR SHIFT LEVERS, FRONT DERAILLEURS, REAR DERAILLEURS, CHAIN GUIDES, FREEWHEELS, SPROCKETS, PULLEYS, CHAINS, CHAIN DEFLECTORS, SHIFT CABLES, CRANKS, CRANK SETS, CHAIN WHEELS, PEDALS, TOE CLIPS, BRAKE LEVERS, FRONT BRAKES, REAR BRAKES, BRAKE CABLES, BRAKE SHOES, RIMS, WHEELS, SPOKES, SPOKE CLIPS, BOTTOM BRACKETS, SEAT PILLARS, SEAT PILLAR QUICK RELEASES, HEAD PARTS FOR FRAME-FORK ASSEMBLY, SUSPENSIONS, HANDLEBARS, HANDLEBAR STEMS, GRIPS FOR HANDLEBARS, BAR ENDS, SEAT POSTS, SADDLES, DERAILLEURS CONTROLLED BY COMPUTER, WHEEL BAGS FOR BICYCLES, GEAR POSITION INDICATORS FOR BICYCLES (U.S. CLS. 19, 21, 23, 31, 35 AND 44).

HAI-LY LAM, EXAMINING ATTORNEY

CLASS 12—(Continued).

SN 77-560,888. MORROW, DAVID D., SAN DIEGO, CA.
FILED 9-2-2008.

Soft Cruise

THE MARK CONSISTS OF STANDARD CHARACTERS
WITHOUT CLAIM TO ANY PARTICULAR FONT, STYLE,
SIZE, OR COLOR.
FOR BICYCLES (U.S. CLS. 19, 21, 23, 31, 35 AND 44).
KATHLEEN LORENZO, EXAMINING ATTORNEY

SN 77-563,276. AERO INDUSTRIES, INC., INDIANAPOLIS,
IN. FILED 9-5-2008.

CONESTOGA 2

THE MARK CONSISTS OF STANDARD CHARACTERS
WITHOUT CLAIM TO ANY PARTICULAR FONT, STYLE,
SIZE, OR COLOR.
OWNER OF U.S. REG. NO. 2,051,284.
FOR TARPING AND COVER SYSTEMS SPECIALLY
ADAPTED FOR TRAILERS AND HAULING VEHICLES,
COMPRISED OF A FITTED TARPAULIN, BOWS AND
DRIVE MECHANISMS MOUNTED TO THE TRAILER
OR VEHICLE (U.S. CLS. 19, 21, 23, 31, 35 AND 44).
FIRST USE 9-2-2005; IN COMMERCE 3-3-2007.
LINDA LAVACHE, EXAMINING ATTORNEY

SN 77-563,651. CAROSELLI, HENRY M., MANHATTAN
BEAACH, CA. FILED 9-5-2008.

RODSTER

THE MARK CONSISTS OF STANDARD CHARACTERS
WITHOUT CLAIM TO ANY PARTICULAR FONT, STYLE,
SIZE, OR COLOR.
FOR AUTOMOTIVE BODY KITS COMPRISING EX-
TERNAL STRUCTURAL PARTS OF AUTOMOBILES
(U.S. CLS. 19, 21, 23, 31, 35 AND 44).
FIRST USE 4-27-1996; IN COMMERCE 4-27-1996.
ALLISON SCHRODY, EXAMINING ATTORNEY

CLASS 12—(Continued).

SN 77-563,664. COMPLETE WHEEL SOURCE, INC., GRAND
JUNCTION, CO. FILED 9-5-2008.

MotoGrip

THE MARK CONSISTS OF STANDARD CHARACTERS
WITHOUT CLAIM TO ANY PARTICULAR FONT, STYLE,
SIZE, OR COLOR.
FOR TIRES FOR ALL-TERRAIN VEHICLES (U.S. CLS.
19, 21, 23, 31, 35 AND 44).
DORITT L. CARROLL, EXAMINING ATTORNEY

SN 77-564,137. JANKOWSKI, DAVID, M, DBA ORBITAL
EXPEDITIONS, HOUSTON, TX. FILED 9-7-2008.

Orbital Expeditions

THE MARK CONSISTS OF STANDARD CHARACTERS
WITHOUT CLAIM TO ANY PARTICULAR FONT, STYLE,
SIZE, OR COLOR.
FOR SPACE VEHICLES (U.S. CLS. 19, 21, 23, 31, 35
AND 44).
CHERYL CLAYTON, EXAMINING ATTORNEY

SN 77-564,710. CIRRUS DESIGN CORPORATION, DULUTH,
MN. FILED 9-8-2008.

Flying 2.0

THE MARK CONSISTS OF STANDARD CHARACTERS
WITHOUT CLAIM TO ANY PARTICULAR FONT, STYLE,
SIZE, OR COLOR.
NO CLAIM IS MADE TO THE EXCLUSIVE RIGHT TO
USE "FLYING", APART FROM THE MARK AS SHOWN.
FOR AIRPLANES AND STRUCTURAL PARTS
THEREFOR (U.S. CLS. 19, 21, 23, 31, 35 AND 44).
CARYN GLASSER, EXAMINING ATTORNEY

CLASS 12—(Continued).

SN 77-564,742. ALISON STROLLERS INC., DBA ALISON STROLLERS, MARKHAM, CANADA, FILED 9-8-2008.



THE MARK CONSISTS OF "ALISON" AND TWO HEARTS.

FOR BABY CARRIAGES; BABY CARRIAGES; BABY STROLLERS; CANOPIES FOR BABY STROLLERS; COVERS FOR BABY STROLLERS; PRAMS; RUBBER BABY BUGGY BUMPERS; STROLLERS; UMBRELLAS TO BE AFFIXED TO BABY STROLLER (U.S. CLS. 19, 21, 23, 31, 35 AND 44).

FIRST USE 12-20-2007; IN COMMERCE 2-12-2008.
SUE LAWRENCE, EXAMINING ATTORNEY

CLASS 12—(Continued).

SN 77-566,034. ELECTRO-YAK, LLC, DBA VOLT BOATS, LOS ANGELES, CA. FILED 9-9-2008.

VOLT BOATS

THE MARK CONSISTS OF STANDARD CHARACTERS WITHOUT CLAIM TO ANY PARTICULAR FONT, STYLE, SIZE, OR COLOR.

NO CLAIM IS MADE TO THE EXCLUSIVE RIGHT TO USE "BOATS", APART FROM THE MARK AS SHOWN.

FOR BOATS; KAYAKS; KAYAK-LIKE BOATS; CANOES (U.S. CLS. 19, 21, 23, 31, 35 AND 44).

JAMES GRIFFIN, EXAMINING ATTORNEY

SN 77-566,063. ELECTRO-YAK, LLC, DBA VOLT BOATS, LOS ANGELES, CA. FILED 9-9-2008.

VOLT

THE MARK CONSISTS OF STANDARD CHARACTERS WITHOUT CLAIM TO ANY PARTICULAR FONT, STYLE, SIZE, OR COLOR.

FOR BOATS; KAYAKS; KAYAK-LIKE BOATS; CANOES (U.S. CLS. 19, 21, 23, 31, 35 AND 44).

JAMES GRIFFIN, EXAMINING ATTORNEY

SN 77-564,901. ALISON STROLLERS INC., DBA ALISON STROLLERS, MARKHAM, CANADA, FILED 9-8-2008.



THE MARK CONSISTS OF STYLIZED CHARACTERS, "WIZ".

FOR BABY CARRIAGES; BABY CARRIAGES; BABY STROLLERS; CANOPIES FOR BABY STROLLERS; COVERS FOR BABY STROLLERS; PRAMS; RUBBER BABY BUGGY BUMPERS; STROLLERS; UMBRELLAS TO BE AFFIXED TO BABY STROLLER (U.S. CLS. 19, 21, 23, 31, 35 AND 44).

FIRST USE 12-20-2007; IN COMMERCE 2-12-2008.
SUE LAWRENCE, EXAMINING ATTORNEY

SN 77-566,072. THE COAST DISTRIBUTION SYSTEM, INC., MORGAN HILL, CA. FILED 9-9-2008.

SIBERIAN

THE MARK CONSISTS OF STANDARD CHARACTERS WITHOUT CLAIM TO ANY PARTICULAR FONT, STYLE, SIZE, OR COLOR.

FOR TRAILER HITCHES (U.S. CLS. 19, 21, 23, 31, 35 AND 44).

LEIGH CAROLINE CASE, EXAMINING ATTORNEY

CLASS 12—(Continued).

SN 77-566,494. MARTIN RACING PERFORMANCE, INC., MIAMI, FL. FILED 9-10-2008.



THE MARK CONSISTS OF THE LETTERS "MRP" WHERE THE RIGHT "LEG" OF THE LETTER "M" IS ALSO THE LEFT "LEG" OF THE LETTER "R" AND THERE IS A STAR IN THE UPPER LEFT CORNER OF THE LETTER "M".

FOR MOTORCYCLES AND STRUCTURAL PARTS THEREFOR; MOTORIZED SCOOTERS; SCOOTERS (U.S. CLS. 19, 21, 23, 31, 35 AND 44).

FIRST USE 1-1-2005; IN COMMERCE 1-1-2005.

KATHERINE E. HALMEN, EXAMINING ATTORNEY

SN 77-566,529. MARTIN RACING PERFORMANCE, INC., MIAMI, FL. FILED 9-10-2008.

**MRP Martin Racing
Performance**

THE MARK CONSISTS OF STANDARD CHARACTERS WITHOUT CLAIM TO ANY PARTICULAR FONT, STYLE, SIZE, OR COLOR.

NO CLAIM IS MADE TO THE EXCLUSIVE RIGHT TO USE "RACING PERFORMANCE", APART FROM THE MARK AS SHOWN.

FOR MOTORCYCLES AND STRUCTURAL PARTS THEREFOR; MOTORIZED SCOOTERS; SCOOTERS (U.S. CLS. 19, 21, 23, 31, 35 AND 44).

FIRST USE 1-1-2005; IN COMMERCE 1-1-2005.

KATHERINE E. HALMEN, EXAMINING ATTORNEY

SN 77-566,566. SNAP-LOC INDUSTRIAL EQUIPMENT LLC, LAS VEGAS, NV. FILED 9-10-2008.

LOC-DOWN

THE MARK CONSISTS OF STANDARD CHARACTERS WITHOUT CLAIM TO ANY PARTICULAR FONT, STYLE, SIZE, OR COLOR.

FOR AUTOMOTIVE AFTERMARKET PARTS, NAMELY, TRUCK BED EXTENDER AND STORAGE BOX; AUTOMOTIVE BODY KITS COMPRISING EXTERNAL STRUCTURAL PARTS OF AUTOMOBILES; AUTOMOTIVE CARGO RACK; METAL PARTS FOR VEHICLES, NAMELY, AUTOMOTIVE EXTERIOR AND INTERIOR METAL DECORATIVE AND PROTECTIVE TRIM (U.S. CLS. 19, 21, 23, 31, 35 AND 44).

FIRST USE 9-1-2008; IN COMMERCE 9-1-2008.

BARBARA A. GOLD, EXAMINING ATTORNEY

CLASS 12—(Continued).

SN 77-568,315. TRIGO, KEVIN A, WILBRAHAM, MA. FILED 9-11-2008.

CROOKHOOK

THE MARK CONSISTS OF STANDARD CHARACTERS WITHOUT CLAIM TO ANY PARTICULAR FONT, STYLE, SIZE, OR COLOR.

FOR AUTOMOBILE BUMPERS; AUTOMOBILES AND STRUCTURAL PARTS THEREFOR; AUTOMOTIVE BODY KITS COMPRISING EXTERNAL STRUCTURAL PARTS OF AUTOMOBILES; LAND VEHICLES AND STRUCTURAL PARTS THEREFOR (U.S. CLS. 19, 21, 23, 31, 35 AND 44).

JULIE GUTTADAURO, EXAMINING ATTORNEY

SN 77-587,322. MARIN MOUNTAIN BIKES, INC., NOVATO, CA. FILED 10-7-2008.

ALCHEMIST

THE MARK CONSISTS OF STANDARD CHARACTERS WITHOUT CLAIM TO ANY PARTICULAR FONT, STYLE, SIZE, OR COLOR.

FOR BICYCLES (U.S. CLS. 19, 21, 23, 31, 35 AND 44).

FIRST USE 7-15-2008; IN COMMERCE 7-15-2008.

DAWN HAN, EXAMINING ATTORNEY

SN 78-547,926. TREK BICYCLE CORPORATION, WATERLOO, WI. FILED 1-14-2005.

Doodlebug

THE MARK CONSISTS OF STANDARD CHARACTERS WITHOUT CLAIM TO ANY PARTICULAR FONT, STYLE, SIZE, OR COLOR.

FOR BICYCLE TRAILERS (U.S. CLS. 19, 21, 23, 31, 35 AND 44).

FIRST USE 8-1-2004; IN COMMERCE 8-1-2004.

ALEX KEAM, EXAMINING ATTORNEY

CLASS 12—(Continued).

SN 78-724,465. ATC TECHNOLOGY CORPORATION, DOWNERS GROVE, IL. FILED 9-30-2005.



OWNER OF U.S. REG. NOS. 2,662,147, 2,939,046 AND OTHERS.

NO CLAIM IS MADE TO THE EXCLUSIVE RIGHT TO USE "CORP.", APART FROM THE MARK AS SHOWN.

THE MARK CONSISTS OF THE WORDING "AFTERMARKET TECHNOLOGY CORP." AND A DESIGN OF TWO ARROWS POINTING CLOCKWISE AND ENCIRCLING THE LETTERS "ATC".

SEC. 2(F) AS TO "AFTERMARKET TECHNOLOGY CORP."

FOR TRANSMISSIONS FOR AUTOMOBILES, AND REPLACEMENT PARTS THEREOF; ENGINES FOR AUTOMOBILES (U.S. CLS. 19, 21, 23, 31, 35 AND 44).

SUSAN RICHARDS, EXAMINING ATTORNEY

CLASS 12—(Continued).

SN 79-045,783. LUK LAMELLEN UND KUPPLUNGSBAU; BETEILIGUNGS KG, FED REP GERMANY, FILED 9-26-2007.



PRIORITY DATE OF 3-26-2007 IS CLAIMED. OWNER OF INTERNATIONAL REGISTRATION 0942474 DATED 9-26-2007, EXPIRES 9-26-2017.

FOR PARTS OF LAND VEHICLES, NAMELY, DRIVE CHAINS FOR LAND VEHICLES; TOOTHED CHAINS, NAMELY, TRANSMISSION CHAINS; AUTOMATIC GEAR-BOXES AND AUTOMATIC TRANSFER GEAR-BOXES; TORQUE TRANSMISSION EQUIPMENT FOR MOTORS OF LAND VEHICLES, NAMELY, TORQUE CONVERTERS; TRANSMISSIONS FOR LAND VEHICLES AND PARTS THEREOF, NAMELY, LOCK-UP CLUTCH DISCS, AUTOMATIC TRANSMISSIONS, DIAPHRAGM SPRINGS, WAVE DISCS, BRAKE BANDS AND HYBRID DRIVES; PARTS OF LAND VEHICLES, NAMELY, DUAL MASS FLYWHEELS, VIBRATION ABSORBERS, VIBRATION DAMPERS, BEARINGS, NAMELY, CLUTCH RELEASE BEARINGS, V-BELT PULLEYS, V-BELT PULLEY DAMPERS, DRIVE SHAFTS, MOTOR VEHICLE STEERING MECHANISMS, HYDRAULIC VALVES, HYBRID DRIVES AND DRIVE GEARS FOR MOTOR VEHICLES; CLUTCH ASSEMBLIES AND PARTS THEREOF FOR LAND VEHICLES, NAMELY, CLUTCHES, CLUTCH DISCS, CLUTCH FACINGS, DRIVE BELT PULLEY BAFFLES, CLUTCH ACTUATORS, INERTIA FLY WHEEL CLUTCHES, CLUTCH RELEASE MECHANISMS; ELECTRO-MECHANICAL, HYDRAULIC AND PNEUMATIC ACTUATORS FOR THE AUTOMATED OR AUTOMATIC ACTUATION, STEERING AND CONTROL OF LAND VEHICLE TRANSMISSIONS AND CLUTCHES (U.S. CLS. 19, 21, 23, 31, 35 AND 44).

MICHAEL WEBSTER, EXAMINING ATTORNEY

SN 79-052,140. BIKE ALERT PLC, LEWISHAM, LONDON, UNITED KINGDOM, FILED 3-20-2008.



PRIORITY DATE OF 2-21-2008 IS CLAIMED. OWNER OF INTERNATIONAL REGISTRATION 0959423 DATED 3-20-2008, EXPIRES 3-20-2018.

OWNER OF U.S. REG. NOS. 3,237,531, 3,385,664 AND 3,385,713.

THE COLOR(S) RED, BLACK AND WHITE IS/ARE CLAIMED AS A FEATURE OF THE MARK.

THE MARK CONSISTS OF THE WORDING "JT" IN RED AND OUTLINED IN WHITE AND THE WORDING "TWINSTAR" IN WHITE OUTLINED IN RED, INSIDE OF A BLACK RECTANGULAR BACKGROUND WITH A RED BORDER.

FOR PARTS FOR MOTORCYCLES, ALL-TERRAIN VEHICLES, AND MOTORIZED SCOOTERS, NAMELY, SPROCKETS, DRIVE CHAINS, HOUSINGS, SUPPORTS AND MOUNTINGS FOR FILTERS (U.S. CLS. 19, 21, 23, 31, 35 AND 44).

NICHOLAS COLEMAN, EXAMINING ATTORNEY

CLASS 13—FIREARMS

SN 77-407,094. FIELD & STREAM LICENSES COMPANY,
WESTPORT, CT. FILED 2-27-2008.



OWNER OF U.S. REG. NOS. 2,352,120, 2,699,103 AND OTHERS.

NO CLAIM IS MADE TO THE EXCLUSIVE RIGHT TO USE "FIELD TESTED," "1871," AND "GUIDE APPROVED", APART FROM THE MARK AS SHOWN.

THE MARK CONSISTS OF THE DESIGN OF AN EAGLE ABOVE THE WORDING "FIELD & STREAM FIELD TESTED 1871 GUIDE APPROVED." A BROKEN HORIZONTAL LINE APPEARS BELOW THE WORDING "FIELD & STREAM" AND ABOVE THE WORDING "FIELD TESTED GUIDE APPROVED". THE NUMBER 1871 APPEARS IN THE MIDDLE OF THE BREAK IN THE LINE.

FOR HUNTING RIFLES, HUNTING GUN CARTRIDGES, AMMUNITION, SHOT GUN SHELLS, CLEANING IMPLEMENTS FOR FIREARMS, NAMELY, BRUSHES, RODS, PULL-THROUGHS, CLOSER CUPS, SHELL EXTRACTORS, DECAPPERS, CLEANING RODS FOR RIFLES, FIREARM SIGHTS, GUN AND RIFLE CASES, GUN AND RIFLE SLINGS GUN LOCKS, RIFLE COVERS, TRIPODS AND STANDS FOR FIREARMS (U.S. CLS. 2 AND 9).

DAVID ELTON, EXAMINING ATTORNEY

SN 77-560,187. FARMI, S.A., EIBAR-GUIPUZCOA, SPAIN,
FILED 9-2-2008.



THE MARK CONSISTS OF A STYLIZED LETTER "O" TO THE LEFT OF THE WORD "NORICA" WHICH CONTAINS THE SAME STYLIZED LETTER "O".

FOR FIREARMS, AUTOMATIC CARBINES, COMPRESSED AIR AND CO2 PISTOLS, STARTER PISTOLS (U.S. CLS. 2 AND 9).

TARA PATE, EXAMINING ATTORNEY

CLASS 13—(Continued).

SN 77-585,921. STI INTERNATIONAL, INC, GEORGETOWN,
TX. FILED 10-6-2008.

Perfect 10

THE MARK CONSISTS OF STANDARD CHARACTERS WITHOUT CLAIM TO ANY PARTICULAR FONT, STYLE, SIZE, OR COLOR.

FOR FIREARMS (U.S. CLS. 2 AND 9).

ELISSA GARBER KON, EXAMINING ATTORNEY

SN 78-859,533. CROSMAN CORPORATION, EAST BLOOMFIELD, NY. FILED 4-13-2006.

VISIBLE IMPACT

THE MARK CONSISTS OF STANDARD CHARACTERS WITHOUT CLAIM TO ANY PARTICULAR FONT, STYLE, SIZE, OR COLOR.

OWNER OF U.S. REG. NOS. 1,716,028 AND 2,605,660.

FOR NON-TELESCOPIC GUNS SIGHTS SOLD AS AN INTEGRAL COMPONENT OF GUNS (U.S. CLS. 2 AND 9).

FIRST USE 10-24-2008; IN COMMERCE 10-31-2008.

REBECCA POVARCHUK, EXAMINING ATTORNEY

CLASS 13—(Continued).

SN 79-051,529, BIG GAME AB C/O ALTHÉN & CO RE-
KLAMBYRÅ AB, SWEDEN, FILED 3-14-2008.



PRIORITY DATE OF 11-27-2007 IS CLAIMED.
OWNER OF INTERNATIONAL REGISTRATION 0957736
DATED 3-14-2008, EXPIRES 3-14-2018.

NO CLAIM IS MADE TO THE EXCLUSIVE RIGHT TO
USE "GUN & RIFLE MAKER SWEDEN", APART FROM
THE MARK AS SHOWN.

THE COLOR(S) DARK GRAY AND BLACK IS/ARE
CLAIMED AS A FEATURE OF THE MARK.

THE COLOR DARK GRAY APPEARS IN THE BACK-
GROUND OF THE MARK AND IN THE SHADING OF THE
WORDING "VO" AND THE COLOR BLACK APPEARS IN
THE WORDING "VO GUN & RIFLE MAKER SWEDEN".

THE WORDING "VO" IN THE MARK HAS NO MEANING
IN A FOREIGN LANGUAGE.

FOR FIREARMS, INCLUDING RIFLES; AMMUNI-
TION AND PROJECTILES; EXPLOSIVES; FIREWORKS
(U.S. CLS. 2 AND 9).

SEAN CROWLEY, EXAMINING ATTORNEY

CLASS 14—(Continued).

SN 77-422,797. DISNEY ENTERPRISES, INC., BURBANK,
CA. FILED 3-14-2008.

ZETA BETA ZETA

THE MARK CONSISTS OF STANDARD CHARACTERS
WITHOUT CLAIM TO ANY PARTICULAR FONT, STYLE,
SIZE, OR COLOR.

FOR JEWELRY, WATCHES, KEY CHAINS OF PRE-
CIOUS METAL AND CLOCKS (U.S. CLS. 2, 27, 28 AND
50).

CAROLYN GRAY, EXAMINING ATTORNEY

SN 77-435,805. KENNETH COLE PRODUCTIONS (LIC), INC.,
NASSAU, BAHAMAS, FILED 3-31-2008.

LE TIGRE

THE MARK CONSISTS OF STANDARD CHARACTERS
WITHOUT CLAIM TO ANY PARTICULAR FONT, STYLE,
SIZE, OR COLOR.

OWNER OF U.S. REG. NO. 1,186,863.

THE ENGLISH TRANSLATION OF THE WORD "LE
TIGRE" IN THE MARK IS "THE TIGER".

FOR JEWELRY; JEWELRY CASES, KEY CHAINS OF
PRECIOUS METAL; CLOCKS AND WATCHES (U.S. CLS.
2, 27, 28 AND 50).

TINA L. SNAPP, EXAMINING ATTORNEY

CLASS 14—JEWELRY

SN 77-253,234. BALDWIN, DONNA K, DBA DONNA K,
WHEAT RIDGE, CO. FILED 8-12-2007.

DONNA K

THE MARK CONSISTS OF STANDARD CHARACTERS
WITHOUT CLAIM TO ANY PARTICULAR FONT, STYLE,
SIZE, OR COLOR.

FOR JEWELRY, EXCLUDING WATCHES (U.S. CLS. 2,
27, 28 AND 50).

FIRST USE 8-20-2005; IN COMMERCE 8-20-2005.
TAMARA FRAZIER, EXAMINING ATTORNEY

SN 77-435,851. KENNETH COLE PRODUCTIONS (LIC), INC.,
NASSAU, BAHAMAS, FILED 3-31-2008.

Le TIGRE

OWNER OF U.S. REG. NO. 1,186,863.

THE ENGLISH TRANSLATION OF THE WORD "LE
TIGRE" IN THE MARK IS "THE TIGER".

FOR JEWELRY; JEWELRY CASES, KEY CHAINS OF
PRECIOUS METAL; CLOCKS AND WATCHES (U.S. CLS.
2, 27, 28 AND 50).

TINA L. SNAPP, EXAMINING ATTORNEY

CLASS 14—(Continued).

SN 77-435,877. KENNETH COLE PRODUCTIONS (LIC), INC.,
NASSAU, BAHAMAS, FILED 3-31-2008.



OWNER OF U.S. REG. NO. 1,186,863.
THE ENGLISH TRANSLATION OF THE WORD "LE
TIGRE" IN THE MARK IS "THE TIGER".
FOR JEWELRY; JEWELRY CASES, KEY CHAINS OF
PRECIOUS METAL; CLOCKS AND WATCHES (U.S. CLS.
2, 27, 28 AND 50).
TINA L. SNAPP, EXAMINING ATTORNEY

SN 77-471,448. FISH ENTERPRISES LIMITED, LONDON,
ENGLAND, FILED 5-12-2008.

Nicole Barr

OWNER OF GREAT BRITAIN REG. NO. 2321085, DATED
1-18-2003, EXPIRES 1-18-2013.
THE NAME(S), PORTRAIT(S), AND/OR SIGNATURE(S)
SHOWN IN THE MARK DOES NOT IDENTIFY A PARTI-
CULAR LIVING INDIVIDUAL.
THE MARK CONSISTS OF THE WORDS "NICOLE BARR"
IN STYLIZED FORM.
FOR JEWELRY (U.S. CLS. 2, 27, 28 AND 50).
JENNIFER MARTIN, EXAMINING ATTORNEY

SN 77-524,805. OLIVER SMITH JEWELER, SCOTTSDALE,
AZ. FILED 7-17-2008.

Build Your Collection

THE MARK CONSISTS OF STANDARD CHARACTERS
WITHOUT CLAIM TO ANY PARTICULAR FONT, STYLE,
SIZE, OR COLOR.
NO CLAIM IS MADE TO THE EXCLUSIVE RIGHT TO
USE "COLLECTION", APART FROM THE MARK AS
SHOWN.
FOR JEWELRY (U.S. CLS. 2, 27, 28 AND 50).
ESTHER A. BORSUK, EXAMINING ATTORNEY

CLASS 14—(Continued).

SN 77-544,096. AVILON, SAGE T., DBA OWNER, SALEM,
OR. AND HOLMAN, MIRANDA R., DBA OWNER,
SALEM, OR. FILED 8-11-2008.

Mirajoel Creations

THE MARK CONSISTS OF STANDARD CHARACTERS
WITHOUT CLAIM TO ANY PARTICULAR FONT, STYLE,
SIZE, OR COLOR.

NO CLAIM IS MADE TO THE EXCLUSIVE RIGHT TO
USE "CREATIONS", APART FROM THE MARK AS
SHOWN.

FOR BRACELETS; EARRINGS; EQUINE NECKLACES;
JEWELRY, NAMELY, ANKLETS (U.S. CLS. 2, 27, 28 AND
50).

THOMAS MANOR, EXAMINING ATTORNEY

SN 77-551,652. ELENA KRIEGNER, INC., NEW YORK, NY.
FILED 8-20-2008.

THE MARK CONSISTS OF THE ABBREVIATION "ELI",
WHICH STANDS FOR ELENA KRIEGNER.
FOR JEWELRY (U.S. CLS. 2, 27, 28 AND 50).
FIRST USE 4-4-2008; IN COMMERCE 4-12-2008.
SUSAN RICHARDS, EXAMINING ATTORNEY

SN 77-554,789. TRUONG, NHAT, DBA GOLDEN GOWN
JEWELRY DESIGN, WESTMINSTER, CA. FILED 8-25-
2008.

GOLDEN GOWN JEWELRY DESIGN

THE MARK CONSISTS OF STANDARD CHARACTERS
WITHOUT CLAIM TO ANY PARTICULAR FONT, STYLE,
SIZE, OR COLOR.

NO CLAIM IS MADE TO THE EXCLUSIVE RIGHT TO
USE "JEWELRY DESIGN", APART FROM THE MARK AS
SHOWN.

FOR JEWELRY (U.S. CLS. 2, 27, 28 AND 50).
CAROLYN CATALDO, EXAMINING ATTORNEY

CLASS 14—(Continued).

SN 77-555,753. WISEMAN, ZACHARY DAVID, WASHINGTON, DC. FILED 8-26-2008.



NO CLAIM IS MADE TO THE EXCLUSIVE RIGHT TO USE "KNOT", APART FROM THE MARK AS SHOWN.
 THE MARK CONSISTS OF A STYLIZED LETTER "A" WHICH IS USED AS THE FIRST LETTER OF THE WORD: "ARCHIMEDES" FOLLOWED BY THE WORD: "KNOT".
 FOR JEWELRY (U.S. CLS. 2, 27, 28 AND 50).
 NELSON SNYDER, EXAMINING ATTORNEY

SN 77-559,591. CONCEPT MANAGEMENT INTERNATIONAL INC., LOS ANGELES, CA. FILED 8-31-2008.

STRAND DENMARK

THE MARK CONSISTS OF STANDARD CHARACTERS WITHOUT CLAIM TO ANY PARTICULAR FONT, STYLE, SIZE, OR COLOR.
 NO CLAIM IS MADE TO THE EXCLUSIVE RIGHT TO USE "DENMARK", APART FROM THE MARK AS SHOWN.
 FOR JEWELLERY AND WATCHES (U.S. CLS. 2, 27, 28 AND 50).
 JOHN E. MICHOS, EXAMINING ATTORNEY

SN 77-560,033. JINCHUAN GROUP LTD., JINCHANG, GAN-SU PROVINCE, CHINA, FILED 9-2-2008.



THE MARK CONSISTS OF THE LETTERS "JNMC" IN STYLIZED LETTERING.
 FOR INGOTS OF PRECIOUS METAL; IRIIDIUM AND ITS ALLOYS; PRECIOUS METALS AND THEIR ALLOYS; GOLD AND ITS ALLOYS; OSMIUM AND ITS ALLOYS; PALLADIUM AND ITS ALLOYS; PLATINUM AND ITS ALLOYS; RHODIUM AND ITS ALLOYS; RUTHENIUM AND ITS ALLOYS; SILVER AND ITS ALLOYS; RINGS BEING JEWELRY (U.S. CLS. 2, 27, 28 AND 50).
 TARA PATE, EXAMINING ATTORNEY

CLASS 14—(Continued).

SN 77-560,543. MANTSOURANIS, STEVEN, DBA QUANTUM EYES JEWELRY, SOCIAL CIRCLE, GA. FILED 9-2-2008.

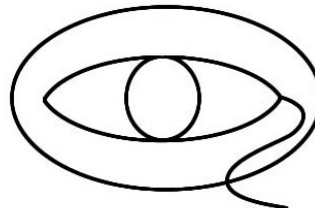

THE MARK CONSISTS OF AN OVAL SHAPE WITH AN INTERNAL EYE, THE EYE LASH COMES DOWN TO COMPLETE THE LETTER "Q".
 FOR JEWELRY (U.S. CLS. 2, 27, 28 AND 50).
 AMY KERTGATE, EXAMINING ATTORNEY

SN 77-561,732. PEACE STORE, INC., SANTA BARBARA, CA. FILED 9-3-2008.

PEACE STORE WATCHES

THE MARK CONSISTS OF STANDARD CHARACTERS WITHOUT CLAIM TO ANY PARTICULAR FONT, STYLE, SIZE, OR COLOR.
 OWNER OF U.S. REG. NO. 3,289,139.
 NO CLAIM IS MADE TO THE EXCLUSIVE RIGHT TO USE "STORE WATCHES", APART FROM THE MARK AS SHOWN.
 FOR JEWELRY WATCHES; POCKET WATCHES; STOP WATCHES; WATCH BANDS; WATCH BANDS AND STRAPS; WATCH BOXES; WATCH BRACELETS; WATCH CHAINS; WATCHES; WATCHES AND JEWELRY; WATCHES AND JEWELRY; WATCHES AND STRAPS FOR WATCHES (U.S. CLS. 2, 27, 28 AND 50).
 NANCY CLARKE, EXAMINING ATTORNEY

SN 77-561,746. PEACE STORE, INC., SANTA BARBARA, CA. FILED 9-3-2008.

PEACE TIME WATCHES

THE MARK CONSISTS OF STANDARD CHARACTERS WITHOUT CLAIM TO ANY PARTICULAR FONT, STYLE, SIZE, OR COLOR.
 NO CLAIM IS MADE TO THE EXCLUSIVE RIGHT TO USE "WATCHES", APART FROM THE MARK AS SHOWN.
 FOR JEWELRY WATCHES; POCKET WATCHES; STOP WATCHES; WATCH BANDS; WATCH BANDS AND STRAPS; WATCH BOXES; WATCH BRACELETS; WATCH CHAINS; WATCHES; WATCHES AND JEWELRY; WATCHES AND JEWELRY; WATCHES AND STRAPS FOR WATCHES (U.S. CLS. 2, 27, 28 AND 50).
 NANCY CLARKE, EXAMINING ATTORNEY

CLASS 14—(Continued).

SN 77-562,841. TIRE'D WATCH CO., LLC, MANHASSET, NY.
FILED 9-4-2008.

Rapide

THE MARK CONSISTS OF STANDARD CHARACTERS WITHOUT CLAIM TO ANY PARTICULAR FONT, STYLE, SIZE, OR COLOR.

THE FOREIGN WORDING IN THE MARK TRANSLATES INTO ENGLISH AS RAPID.

FOR WATCHES (U.S. CLS. 2, 27, 28 AND 50).
LANA PHAM, EXAMINING ATTORNEY

CLASS 14—(Continued).

SN 77-564,533. JEWELAMERICA, INC., LONG ISLAND CITY, NY. FILED 9-8-2008.

PRIMASTAR

THE MARK CONSISTS OF STANDARD CHARACTERS WITHOUT CLAIM TO ANY PARTICULAR FONT, STYLE, SIZE, OR COLOR.

FOR JEWELRY (U.S. CLS. 2, 27, 28 AND 50).
JOHN WILKE, EXAMINING ATTORNEY

SN 77-564,721. DOWNES-WHARTON, KATE, CHICAGO, IL.
FILED 9-8-2008.

SN 77-564,443. GEOCENTRAL, INC., MASON, OH. FILED 9-8-2008.

GEOJEWELRY

THE MARK CONSISTS OF STANDARD CHARACTERS WITHOUT CLAIM TO ANY PARTICULAR FONT, STYLE, SIZE, OR COLOR.

FOR JEWELRY (U.S. CLS. 2, 27, 28 AND 50).
FIRST USE 1-31-2000; IN COMMERCE 1-31-2000.
FRANK LATTUCA, EXAMINING ATTORNEY

Jewelsies

THE COLOR(S) GREEN IS/ARE CLAIMED AS A FEATURE OF THE MARK.

THE MARK CONSISTS OF THE WORD "JEWELSIES" IN GREEN AND MELANIE FONT.

FOR JEWELRY (U.S. CLS. 2, 27, 28 AND 50).
ELLEN B. AWRICH, EXAMINING ATTORNEY

SN 77-564,481. DONALD SEUNG-YEUP RHEE, IRVINE, CA.
FILED 9-8-2008.

POPITS

THE MARK CONSISTS OF STANDARD CHARACTERS WITHOUT CLAIM TO ANY PARTICULAR FONT, STYLE, SIZE, OR COLOR.

OWNER OF U.S. REG. NOS. 3,013,708, 3,064,202 AND 3,496,930.

FOR JEWELRY, NAMELY, BRACELETS, PENDANTS, AND CHARMS (U.S. CLS. 2, 27, 28 AND 50).

FIRST USE 5-2-2008; IN COMMERCE 5-2-2008.
APRIL HESIK, EXAMINING ATTORNEY

SN 77-565,558. OCCHIPINTI, JUDIT, TUJUNGA, CA. FILED 9-9-2008.

ora d oro

THE MARK CONSISTS OF STANDARD CHARACTERS WITHOUT CLAIM TO ANY PARTICULAR FONT, STYLE, SIZE, OR COLOR.

NO CLAIM IS MADE TO THE EXCLUSIVE RIGHT TO USE "D ORO", APART FROM THE MARK AS SHOWN.

THE FOREIGN WORDING "D ORO" IN THE MARK MEANS "OF GOLD".

FOR JEWELRY, NAMELY, RINGS, BRACELETS, EARRINGS, NECKLACES, CHARMS (U.S. CLS. 2, 27, 28 AND 50).

CORY BOONE, EXAMINING ATTORNEY

CLASS 14—(Continued).

SN 77-565,619. LEVITATION JEWELRY LLC, CHAMPAIGN, IL. FILED 9-9-2008.

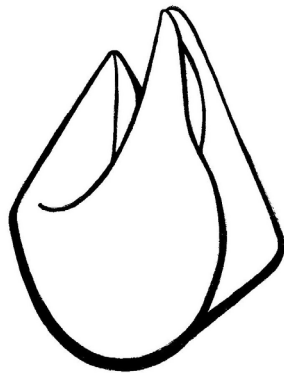

THE MARK CONSISTS OF FORTUNE COOKIE. FOR JEWELRY (U.S. CLS. 2, 27, 28 AND 50). JOHN E. MICHOS, EXAMINING ATTORNEY

SN 77-565,642. LEVITATION JEWELRY LLC, CHAMPAIGN, IL. FILED 9-9-2008.

LEVITATION JEWELRY

THE MARK CONSISTS OF STANDARD CHARACTERS WITHOUT CLAIM TO ANY PARTICULAR FONT, STYLE, SIZE, OR COLOR.
NO CLAIM IS MADE TO THE EXCLUSIVE RIGHT TO USE "JEWELRY", APART FROM THE MARK AS SHOWN. FOR JEWELRY (U.S. CLS. 2, 27, 28 AND 50). JOHN E. MICHOS, EXAMINING ATTORNEY

CLASS 14—(Continued).

SN 77-565,755. CHROME HEARTS LLC, HOLLYWOOD, CA. FILED 9-9-2008.

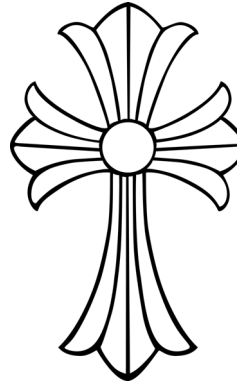

OWNER OF U.S. REG. NOS. 3,385,415 AND 3,385,449. THE MARK CONSISTS OF A CROSS DESIGN . FOR JEWELRY, NAMELY, RINGS, EARRINGS, PENDANTS, NECKLACES, BRACELETS, CUFF BRACELETS, CUFF LINKS, WATCH BRACELETS AND KEY RINGS MADE OF PRECIOUS METALS (U.S. CLS. 2, 27, 28 AND 50).
FIRST USE 1-2-1989; IN COMMERCE 1-2-1989. JENNIFER MARTIN, EXAMINING ATTORNEY

SN 77-565,813. DANECRAFT, INC., PROVIDENCE, RI. FILED 9-9-2008.

LIFE.YOURS

THE MARK CONSISTS OF STANDARD CHARACTERS WITHOUT CLAIM TO ANY PARTICULAR FONT, STYLE, SIZE, OR COLOR.
FOR JEWELRY (U.S. CLS. 2, 27, 28 AND 50). MICHAEL WIENER, EXAMINING ATTORNEY

SN 77-565,978. MIMIMACK, LLC, BROOKFIELD, WI. FILED 9-9-2008.

Spec-tickles

THE MARK CONSISTS OF STANDARD CHARACTERS WITHOUT CLAIM TO ANY PARTICULAR FONT, STYLE, SIZE, OR COLOR.
FOR JEWELRY FOR AFFIXING TO EYE GLASSES (U.S. CLS. 2, 27, 28 AND 50).
FIRST USE 7-1-2007; IN COMMERCE 6-18-2008. ANGELA M. MICHELI, EXAMINING ATTORNEY

CLASS 14—(Continued).

SN 77-566,078. ESPOSITO, MICHELE, CALABASAS, CA.
FILED 9-9-2008.

Not Just
ANY OLD DAY
It's Your SPECIAL DAY

THE MARK CONSISTS OF THE STYLIZED WORDING "NOT JUST ANY OLD DAY IT'S YOUR SPECIAL DAY", WITH THE WORDS "NOT JUST ANY OLD DAY" UNDERLINED.

FOR BRACELETS; BRACELETS OF PRECIOUS METAL; CHARMS; JEWELRY; JEWELRY CHAINS; KEY CHAINS OF PRECIOUS METAL; KEY RINGS OF PRECIOUS METAL; NECKLACES; PENDANTS; PINS (U.S. CLS. 2, 27, 28 AND 50).

FIRST USE 2-1-2008; IN COMMERCE 3-1-2008.
EVELYN BRADLEY, EXAMINING ATTORNEY

SN 77-566,213. CLASSIC DESIGNS INC., MONTGOMERY, TX. FILED 9-10-2008.

NEST

THE MARK CONSISTS OF STANDARD CHARACTERS WITHOUT CLAIM TO ANY PARTICULAR FONT, STYLE, SIZE, OR COLOR.

FOR EARRINGS; JEWELRY; NECKLACES; RINGS (U.S. CLS. 2, 27, 28 AND 50).

FIRST USE 0-0-2005; IN COMMERCE 0-0-2005.
ANGELA M. MICHELI, EXAMINING ATTORNEY

SN 77-568,075. FREDERICK GOLDMAN, INC., NEW YORK, NY. FILED 9-11-2008.

COFFEE

THE MARK CONSISTS OF STANDARD CHARACTERS WITHOUT CLAIM TO ANY PARTICULAR FONT, STYLE, SIZE, OR COLOR.

FOR JEWELRY (U.S. CLS. 2, 27, 28 AND 50).
ANDREA SAUNDERS, EXAMINING ATTORNEY

CLASS 14—(Continued).

SN 77-609,113. FABRIKANT-TARA INTERNATIONAL, LLC, NEW YORK, NY. FILED 11-6-2008.

FACETS OF LOVE

THE MARK CONSISTS OF STANDARD CHARACTERS WITHOUT CLAIM TO ANY PARTICULAR FONT, STYLE, SIZE, OR COLOR.

FOR JEWELRY (U.S. CLS. 2, 27, 28 AND 50).
PRISCILLA MILTON, EXAMINING ATTORNEY

SN 79-041,771. CHOPARD INTERNATIONAL SA, SWITZERLAND, FILED 7-2-2007.

GRAND CRU

THE MARK CONSISTS OF STANDARD CHARACTERS WITHOUT CLAIM TO ANY PARTICULAR FONT, STYLE, SIZE, OR COLOR.

PRIORITY DATE OF 1-31-2007 IS CLAIMED.

OWNER OF INTERNATIONAL REGISTRATION 0932419 DATED 7-2-2007, EXPIRES 7-2-2017.

FOR JEWELRY, NAMELY, RINGS, BRACELETS, CHAINS, NECKLACES, PENDANTS, EARRINGS, BROOCHES; CUFF LINKS, TIE PINS; GOODS IN PRECIOUS METALS, THEIR ALLOYS OR GOODS COATED THEREWITH, NAMELY, KEY RINGS; HOROLOGICAL AND CHRONOMETRIC INSTRUMENTS, NAMELY, WATCHES, CHRONOGRAPH WATCHES, CHRONOMETERS, ALARM CLOCKS; WATCH PARTS AND ACCESSORIES, NAMELY, WATCH CASES, WATCH STRAPS, WATCH DIALS, WATCH MOVEMENTS, WATCH GLASSES (U.S. CLS. 2, 27, 28 AND 50).

FRED CARL, EXAMINING ATTORNEY

SN 79-053,337. PATEK, PHILIPPE SA, SWITZERLAND, FILED 5-2-2008.

OSCILL-O-MAX

THE MARK CONSISTS OF STANDARD CHARACTERS WITHOUT CLAIM TO ANY PARTICULAR FONT, STYLE, SIZE, OR COLOR.

PRIORITY DATE OF 12-4-2007 IS CLAIMED.

OWNER OF INTERNATIONAL REGISTRATION 0962934 DATED 5-2-2008, EXPIRES 5-2-2018.

FOR PRECIOUS METALS AND THEIR ALLOYS; GOODS MADE OF OR COATED WITH PRECIOUS METALS INCLUDED IN THIS CLASS, NAMELY, FIGURINES OF PRECIOUS METAL, KEY CHAINS OF PRECIOUS METAL, ORNAMENTS OF PRECIOUS METAL; JEWELRY, PRECIOUS STONES; HOROLOGICAL AND CHRONOMETRIC INSTRUMENTS; TIMEPIECES AND PARTS THEREOF, WATCHES AND PARTS THEREOF, CLOCK AND WATCH MOVEMENTS, TIMEPIECE MOVEMENTS; PARTS OF TIMEPIECES, NAMELY, REGULATING DEVICES FOR TIMEPIECES, SPRINGS FOR TIMEPIECES, HAIRSPRINGS FOR TIMEPIECES; ESCAPEMENTS FOR TIMEPIECES, AND PENDULUMS FOR TIMEPIECES (U.S. CLS. 2, 27, 28 AND 50).

SONYA STEPHENS, EXAMINING ATTORNEY

CLASS 14—(Continued).

SN 79-053,338. PATEK, PHILIPPE SA, SWITZERLAND, FILED 5-2-2008.

CLASS 15—(Continued).

SN 77-553,760. JAMES TRUSSART, DBA JAMES TRUSSART CUSTOM GUITARS, LOS ANGELES, CA. FILED 8-22-2008.

OSCILLOMAX

THE MARK CONSISTS OF STANDARD CHARACTERS WITHOUT CLAIM TO ANY PARTICULAR FONT, STYLE, SIZE, OR COLOR.

PRIORITY DATE OF 12-4-2007 IS CLAIMED.

OWNER OF INTERNATIONAL REGISTRATION 0962936 DATED 5-2-2008, EXPIRES 5-2-2018.

FOR PRECIOUS METALS AND THEIR ALLOYS; GOODS MADE OF OR COATED WITH PRECIOUS METALS INCLUDED IN THIS CLASS, NAMELY, FIGURINES OF PRECIOUS METAL, KEY CHAINS OF PRECIOUS METAL, ORNAMENTS OF PRECIOUS METAL; JEWELRY, PRECIOUS STONES; HOROLOGICAL AND CHRONOMETRIC INSTRUMENTS; TIMEPIECES AND PARTS THEREOF, WATCHES AND PARTS THEREOF, CLOCK AND WATCH MOVEMENTS, TIMEPIECE MOVEMENTS; PARTS OF TIMEPIECES, NAMELY, REGULATING DEVICES FOR TIMEPIECES, SPRINGS FOR TIMEPIECES, HAIRSPRINGS FOR TIMEPIECES; ESCAPEMENTS FOR TIMEPIECES, AND PENDULUMS FOR TIMEPIECES (U.S. CLS. 2, 27, 28 AND 50).
SONYA STEPHENS, EXAMINING ATTORNEY

JAMES TRUSSART

THE MARK CONSISTS OF STANDARD CHARACTERS WITHOUT CLAIM TO ANY PARTICULAR FONT, STYLE, SIZE, OR COLOR.

THE NAME(S), PORTRAIT(S), AND/OR SIGNATURE(S) SHOWN IN THE MARK IDENTIFIES "JAMES TRUSSART", WHOSE CONSENT(S) TO REGISTER IS MADE OF RECORD.

FOR MUSICAL INSTRUMENTS, NAMELY, GUITARS AND BASSES; VIOLINS (U.S. CLS. 2, 21 AND 36).
FIRST USE 0-0-1984; IN COMMERCE 0-0-1984.
MARK SHINER, EXAMINING ATTORNEY

CLASS 15—MUSICAL INSTRUMENTS

SN 77-538,838. ALADDIN MUSICAL INSTRUMENT (U.S.A.) CORP. LIMITED, GUANGZHOU PROVINCE, CHINA, FILED 8-4-2008.

SN 77-565,724. GEORGE'S DRUM SHOP, INC., COPLEY, OH. FILED 9-9-2008.



THE MARK CONSISTS OF THE WORDING, "ALADDIN", WHICH APPEARS BELOW THE DESIGN FEATURING A PAIR OF STYLIZED WINGS.

FOR CASES FOR MUSICAL INSTRUMENTS; DRUMS; ELECTRIC AND ELECTRONIC MUSICAL INSTRUMENTS; GUITARS; MUSICAL INSTRUMENTS; MUSICAL INSTRUMENTS, NAMELY, STEEL DRUMS, BASS GUITARS, STRING BASSES, GONGS, LUTES, MUSICAL CHIMES, RATTLES, PEDAL STEEL GUITARS, RHYTHM MACHINES; STANDS FOR MUSICAL INSTRUMENTS; STRING INSTRUMENTS; STRINGS FOR JAPANESE STYLE STRINGED INSTRUMENTS; STRINGS FOR WESTERN MUSICAL INSTRUMENTS; TUNERS FOR MUSICAL INSTRUMENTS (U.S. CLS. 2, 21 AND 36).
KELLY CHOE, EXAMINING ATTORNEY

2 x 4

THE MARK CONSISTS OF STANDARD CHARACTERS WITHOUT CLAIM TO ANY PARTICULAR FONT, STYLE, SIZE, OR COLOR.

FOR PERCUSSION INSTRUMENTS (U.S. CLS. 2, 21 AND 36).
FIRST USE 9-9-2008; IN COMMERCE 9-9-2008.
ZACHARY BELLO, EXAMINING ATTORNEY

CLASS 16—PAPER GOODS AND PRINTED MATTER

SN 76-689,731. SPEARING MAGAZINE, LLC, CRYSTAL BEACH, FL. FILED 5-15-2008.



NO CLAIM IS MADE TO THE EXCLUSIVE RIGHT TO USE "SPEARING MAGAZINE", APART FROM THE MARK AS SHOWN.

THE MARK CONSISTS OF THE LITERAL ELEMENT "SPEARING MAGAZINE" AND A DESIGN ELEMENT CONSISTING OF THE SILHOUETTES OF THREE, DIFFERENT SIZED SUPERIMPOSED LEFT-FACING FISH, WHERE THE FISH AND THE WORD "SPEARING" APPEAR ABOVE A SPEAR GUN AND THE WORD "MAGAZINE" APPEARS ON THE SPEAR GUN BARREL AND BENEATH THE WORD "SPEARING".

FOR MAGAZINE FEATURING ARTICLES AND INFORMATION DIRECTED TO THE SUBJECT OF SPEAR FISHING (U.S. CLS. 2, 5, 22, 23, 29, 37, 38 AND 50).

FIRST USE 5-1-2008; IN COMMERCE 5-1-2008.

RONALD DELGIZZI, EXAMINING ATTORNEY

SN 76-692,586. UNITED METHODIST PUBLISHING HOUSE, THE, NASHVILLE, TN. FILED 9-4-2008.

EVERYONE'S ENGLISH VERSION

THE MARK CONSISTS OF STANDARD CHARACTERS WITHOUT CLAIM TO ANY PARTICULAR FONT, STYLE, SIZE, OR COLOR.

NO CLAIM IS MADE TO THE EXCLUSIVE RIGHT TO USE "ENGLISH VERSION", APART FROM THE MARK AS SHOWN.

FOR SERIES OF BIBLES (U.S. CLS. 2, 5, 22, 23, 29, 37, 38 AND 50).

COURTNEY MCCORMICK, EXAMINING ATTORNEY

SN 77-128,242. CHARISM, CPR, LLC, LAFAYETTE, LA. FILED 3-12-2007.

DEEPMATH

THE MARK CONSISTS OF STANDARD CHARACTERS WITHOUT CLAIM TO ANY PARTICULAR FONT, STYLE, SIZE, OR COLOR.

FOR PRINTED INSTRUCTIONAL, EDUCATIONAL AND TEACHING MATERIALS IN THE FIELD OF MATHEMATICS (U.S. CLS. 2, 5, 22, 23, 29, 37, 38 AND 50).

FIRST USE 12-31-2000; IN COMMERCE 12-31-2000.

KELLY MCCOY, EXAMINING ATTORNEY

CLASS 16—(Continued).

SN 77-145,849. WALLBUSTERS, L.L.C., FENTON, MI. FILED 4-2-2007.

WALLBUSTER

THE MARK CONSISTS OF STANDARD CHARACTERS WITHOUT CLAIM TO ANY PARTICULAR FONT, STYLE, SIZE, OR COLOR.

FOR PHOTOGRAPHIC PRINTS (U.S. CLS. 2, 5, 22, 23, 29, 37, 38 AND 50).

FIRST USE 1-15-2007; IN COMMERCE 2-15-2007.

BERNICE MIDDLETON, EXAMINING ATTORNEY

SN 77-175,646. ROBERTO DE ASSIS MOREIRA E CIA LTDA, PORTO ALEGRE, BRAZIL, FILED 5-8-2007.

RONALDINHO GAÚCHO

THE MARK CONSISTS OF STANDARD CHARACTERS WITHOUT CLAIM TO ANY PARTICULAR FONT, STYLE, SIZE, OR COLOR.

THE NAME "RONALDINHO GAÚCHO" IDENTIFIES A LIVING INDIVIDUAL WHOSE CONSENT IS OF RECORD.

FOR PAPER, CARDBOARD AND GOODS MADE FROM THESE MATERIALS, NOT INCLUDED IN OTHER CLASSES, NAMELY, NOTEBOOKS; PRINTED MATTER, NAMELY, BOOKS AND MAGAZINES IN THE FIELD OF SPORTS AND CULTURAL EVENTS, CROSS-WORD PUZZLES, COMIC STRIPS, COMIC BOOKS; BOOKBINDING MATERIAL, NAMELY, TAPE, WIRE, AND CLOTH FOR BOOKBINDING; PHOTOGRAPHS; STATIONERY; ADHESIVES FOR STATIONERY FOR HOUSEHOLD PURPOSES; ARTISTS' MATERIALS, NAMELY, PENS AND PENCILS; PRINTERS' TYPE; PRINTING BLOCKS (U.S. CLS. 2, 5, 22, 23, 29, 37, 38 AND 50).

FRED MANDIR, EXAMINING ATTORNEY

SN 77-194,948. SMURZYNSKI, INC., DBA UNIQUE FABRICATING, CENTRAL POINT, OR. FILED 5-31-2007.

Unique Fabricating

THE MARK CONSISTS OF STANDARD CHARACTERS WITHOUT CLAIM TO ANY PARTICULAR FONT, STYLE, SIZE, OR COLOR.

NO CLAIM IS MADE TO THE EXCLUSIVE RIGHT TO USE "FABRICATING", APART FROM THE MARK AS SHOWN.

FOR ADHESIVE-BACKED LETTERS AND NUMBERS FOR USE IN MAKING SIGNS (U.S. CLS. 2, 5, 22, 23, 29, 37, 38 AND 50).

DAVID TAYLOR, EXAMINING ATTORNEY

CLASS 16—(Continued).

SN 77-210,517. U.S. CORRUGATED, INC., KENNESAW,, GA. FILED 6-20-2007.

U.S. Corrugated, Inc.

THE MARK CONSISTS OF STANDARD CHARACTERS WITHOUT CLAIM TO ANY PARTICULAR FONT, STYLE, SIZE, OR COLOR.

NO CLAIM IS MADE TO THE EXCLUSIVE RIGHT TO USE "CORRUGATED, INC.", APART FROM THE MARK AS SHOWN.

SEC. 2(F).

FOR PAPER, CARDBOARD AND CORRUGATED PAPER AND CARDBOARD, BOTH BEARING PRINTING AND THOSE HAVING NO PRINTING THEREON, NAMELY, LINERBOARD FOR CORRUGATED CARDBOARD, SHEET PAPER, AND WRAPPING PAPER; CARDBOARD; CARDBOARD AND CORRUGATED CARDBOARD BOXES FOR DISPLAYS, BINS, PACKAGING, MOVING; RELATED PAPER PRODUCTS, NAMELY, BOXES, BINS, LIDS, AND PACKAGING PAPERS (U.S. CLS. 2, 5, 22, 23, 29, 37, 38 AND 50).

FIRST USE 9-26-2006; IN COMMERCE 9-26-2006.

LESLIE RICHARDS, EXAMINING ATTORNEY

SN 77-249,516. SHANGHAI LOTUS STATIONERY CO., LTD., SHANGHAI, CHINA, FILED 8-7-2007.

TrueColor

THE MARK CONSISTS OF STANDARD CHARACTERS WITHOUT CLAIM TO ANY PARTICULAR FONT, STYLE, SIZE, OR COLOR.

FOR WRITING IMPLEMENTS; METAL AND PLASTIC PENS; MECHANICAL PENCILS; MARKERS AND HIGHLIGHTERS; ARTISTS' PENCILS AND MARKERS; AND CORRECTION FLUIDS FOR DOCUMENTS (U.S. CLS. 2, 5, 22, 23, 29, 37, 38 AND 50).

WENDY GOODMAN, EXAMINING ATTORNEY

SN 77-256,893. PILLOWGRAMS, ORMOND BEACH, FL. FILED 8-16-2007.

PILLOWGRAMS

THE MARK CONSISTS OF STANDARD CHARACTERS WITHOUT CLAIM TO ANY PARTICULAR FONT, STYLE, SIZE, OR COLOR.

FOR STATIONERY AND GREETING CARDS, NAMELY, PILLOW-SHAPED MESSAGES AND MAILERS CAPABLE OF BEING SENT THROUGH THE MAIL (U.S. CLS. 2, 5, 22, 23, 29, 37, 38 AND 50).

INGRID C. EULIN, EXAMINING ATTORNEY

CLASS 16—(Continued).

SN 77-267,380. RYAN, KYLE A, SHORELINE, WA. FILED 8-29-2007.

STICKEYS

THE MARK CONSISTS OF STANDARD CHARACTERS WITHOUT CLAIM TO ANY PARTICULAR FONT, STYLE, SIZE, OR COLOR.

FOR ADHESIVE LABELS FOR KEYS (U.S. CLS. 2, 5, 22, 23, 29, 37, 38 AND 50).

MICHAEL LITZAU, EXAMINING ATTORNEY

SN 77-270,717. BOHANNON, ROBERT C, CHAPEL HILL, NC. FILED 9-4-2007.

The Testimony

THE MARK CONSISTS OF STANDARD CHARACTERS WITHOUT CLAIM TO ANY PARTICULAR FONT, STYLE, SIZE, OR COLOR.

FOR RELIGIOUS BOOKS (U.S. CLS. 2, 5, 22, 23, 29, 37, 38 AND 50).

THEODORE MCBRIDE, EXAMINING ATTORNEY

CLASS 16—(Continued).

SN 77-294,473. DEUTSCHE TELEKOM AG, BONN 53113, FED REP GERMANY, FILED 10-2-2007.



PRIORITY CLAIMED UNDER SEC. 44(D) ON FED REP GERMANY APPLICATION NO. 30722313238, FILED 4-3-2007, REG. NO. 30722313, DATED 12-14-2007, EXPIRES 4-30-2017.

OWNER OF U.S. REG. NOS. 3,312,794, 3,348,739 AND 3,348,740.

THE MARK CONSISTS OF THE TERM "CONGSTAR" BELOW AN INCOMPLETE CIRCLE AND AN INCOMPLETE STAR WITHIN THE CIRCLE.

THE TERM IN THE MARK DOES NOT HAVE ANY MEANING IN A FOREIGN LANGUAGE.

FOR (BASED ON SECTION 44(E)) PRINTED MATTER, NAMELY, TELEPHONE DIRECTORIES, SERIES OF BOOKS, NEWSLETTERS, PAMPHLETS, BROCHURES, MAGAZINES AND PAPERBACKS, ALL IN THE FIELD OF TELECOMMUNICATIONS, PRINTED AND STAMPED PLASTIC AND CARDBOARD GREETING, BLANK, NOTE, AND INDEX CARDS, NOTE PAPER AND ENVELOPES, NAMETAGS AND LABELS MADE FROM PAPER OR CARDBOARD, NOTEBOOKS, NOTE PADS, STATIONERY, PAPER, NAMELY, BOND PAPER AND ART PAPER, ADDRESS BOOKS, STUDENT CALENDARS, FOLDERS FOR LETTERS AND LOOSE PAPERS, STATIONERY CLEAR HOLE TAB REINFORCEMENTS, RUBBER STAMPS AND IMPRESSION STAMPS, PAPER WEIGHTS, LETTER OPENERS, DRAWING AND UNGRADUATED RULERS, ERASERS, STAPLERS, PAPER CLIPS, BLOTTING PADS, DESK FILE TRAYS, DESK STANDS AND HOLDERS FOR HOLDING STATIONERY AND OFFICE IMPLEMENTS, PRINTED INSTRUCTIONAL AND TEACHING MATERIALS, ALL IN THE FIELDS OF TELECOMMUNICATIONS, INFORMATION TECHNOLOGY, SAFETY, NEWS, SPORTS, ENTERTAINMENT, CULTURE, BUSINESS AND FINANCE, WEATHER AND TRAVEL, BOOKMARKERS, STENCILS, SCRATCH PICTURES, PVC STICKERS, BLACKBOARDS, CHALK STICKS AND ADHESIVES FOR STATIONERY OR HOUSEHOLD PURPOSES. (BASED ON SECTION 1(B)) GIFT-WRAP PAPER; DIARIES, STAMP ALBUMS AND PHOTO-ALBUMS; DRAWING AND PAINTING MATERIALS, NAMELY, PENCILS, DRAWING PENCILS, PENS, DRAWING PENS, PAINT TRAYS, PAINTING SETS FOR CHILDREN, ARTS AND CRAFT PAINT KITS, AND PENCIL CASES; NON-MAGNETICALLY ENCODED PREPAID TELEPHONE CALLING CARDS (U.S. CLS. 2, 5, 22, 23, 29, 37, 38 AND 50).
MARLENE BELL, EXAMINING ATTORNEY

CLASS 16—(Continued).

SN 77-368,386. GREAT ALASKAN TOURSAVER, LLC, ANCHORAGE, AK. FILED 1-10-2008.

TourSaver

THE MARK CONSISTS OF STANDARD CHARACTERS WITHOUT CLAIM TO ANY PARTICULAR FONT, STYLE, SIZE, OR COLOR.

SEC. 2(F).

FOR GUIDE BOOKS FEATURING TRAVEL COUPONS; TRAVEL BOOKS; VOUCHER BOOKS (U.S. CLS. 2, 5, 22, 23, 29, 37, 38 AND 50).

FIRST USE 12-10-2000; IN COMMERCE 12-10-2000.

RONALD MCMORROW, EXAMINING ATTORNEY

SN 77-369,065. GIVING TREE, LLC, DBA GIVING TREE, THOMPSONS STATION, TN. FILED 1-10-2008.



THE COLOR(S) GREEN, LIGHT BLUE, AND ORANGE IS/ ARE CLAIMED AS A FEATURE OF THE MARK.

THE MARK CONSISTS OF THE WORDING "GIVING-TREE" AND THE IMAGE OF A TREE COMPRISED OF CIRCLES, WITH THE WORD "GIVING" IN GREEN, THE WORD "TREE" IN LIGHT BLUE, AND FOUR SMALL ORANGE CIRCLES, THREE MEDIUM-SIZED LIGHT BLUE CIRCLES, AND FOUR LARGE GREEN CIRCLES.

FOR GIFT CARDS (U.S. CLS. 2, 5, 22, 23, 29, 37, 38 AND 50).

FIRST USE 10-1-2007; IN COMMERCE 10-1-2007.

MARY MUNSON, EXAMINING ATTORNEY

SN 77-378,111. JONES, STEFANY W., DBA STEFANY J., BALA CYNWYD, PA. FILED 1-23-2008.

Stefany J.

THE MARK CONSISTS OF STANDARD CHARACTERS WITHOUT CLAIM TO ANY PARTICULAR FONT, STYLE, SIZE, OR COLOR.

FOR STICKERS; STICKERS AND DECALCOMANIAS; STICKERS AND TRANSFERS; POSTCARDS (U.S. CLS. 2, 5, 22, 23, 29, 37, 38 AND 50).

SHAUNIA CARLYLE, EXAMINING ATTORNEY

CLASS 16—(Continued).

SN 77-382,808. GOLDEN LADDER PRODUCTIONS, LTD., AUSTIN, TX. FILED 1-29-2008.

The Gen Y Guy

THE MARK CONSISTS OF STANDARD CHARACTERS WITHOUT CLAIM TO ANY PARTICULAR FONT, STYLE, SIZE, OR COLOR.

NO CLAIM IS MADE TO THE EXCLUSIVE RIGHT TO USE "GEN Y", APART FROM THE MARK AS SHOWN.

FOR PRINTED INSTRUCTIONAL, EDUCATIONAL, AND TEACHING MATERIALS IN THE FIELD OF EMPLOYMENT TRENDS AND PROFESSIONAL DEVELOPMENT; PRINTED LECTURES; BOOKS IN THE FIELD OF EMPLOYMENT TRENDS AND PROFESSIONAL DEVELOPMENT; PUBLICATIONS, NAMELY, BROCHURES, BOOKLETS, AND TEACHING MATERIALS IN THE FIELD OF EMPLOYMENT TRENDS AND PROFESSIONAL DEVELOPMENT (U.S. CLS. 2, 5, 22, 23, 29, 37, 38 AND 50).

JENNIFER DIXON, EXAMINING ATTORNEY

CLASS 16—(Continued).

SN 77-385,630. RAKONTUR LLC, MIAMI BEACH, FL. FILED 1-31-2008.

COCAINE COWBOYS

THE MARK CONSISTS OF STANDARD CHARACTERS WITHOUT CLAIM TO ANY PARTICULAR FONT, STYLE, SIZE, OR COLOR.

NO CLAIM IS MADE TO THE EXCLUSIVE RIGHT TO USE "COCAINE", APART FROM THE MARK AS SHOWN.

FOR SERIES OF NON-FICTION BOOKS IN THE FIELDS OF HISTORY AND CULTURE; CALENDARS; POSTERS; ART PRINTS, BANK CHECKS AND CHECK BOOKS; POSTCARDS AND GREETING CARDS; BUMPER STICKERS AND DECALS; DESK SETS; PENS; PENCILS; STATIONERY AND ENVELOPES; PAPER PARTY DECORATIONS, FAVORS, DISPOSABLE NAPKINS; PAPER FOR WRAPPING AND PACKAGING; MONEY CLIPS; AND COMPUTER GAME INSTRUCTION MANUALS (U.S. CLS. 2, 5, 22, 23, 29, 37, 38 AND 50).

JEFF DEFORD, EXAMINING ATTORNEY

SN 77-383,290. SPARKNOTES LLC, NEW YORK, NY. FILED 1-29-2008.

ULTIMATE STYLE

THE MARK CONSISTS OF STANDARD CHARACTERS WITHOUT CLAIM TO ANY PARTICULAR FONT, STYLE, SIZE, OR COLOR.

NO CLAIM IS MADE TO THE EXCLUSIVE RIGHT TO USE "STYLE", APART FROM THE MARK AS SHOWN.

FOR PUBLICATIONS, NAMELY, A SERIES OF INSTRUCTION, LESSON, ACTIVITY AND EXERCISE BOOKS IN THE FIELDS OF VOCABULARY, WRITING, SPELLING, GRAMMAR, JOURNAL WRITING, RESEARCH PAPER WRITING, ESSAYS, SHORT STORIES, LITERATURE, LANGUAGE AND POETRY (U.S. CLS. 2, 5, 22, 23, 29, 37, 38 AND 50).

FIRST USE 3-31-2005; IN COMMERCE 3-31-2005.

DAVID HOFFMAN, EXAMINING ATTORNEY

SN 77-386,243. ARKHAM LABS, LLC, BURLESON, TX. FILED 2-1-2008.

LORE ETERNAL WAR

THE MARK CONSISTS OF STANDARD CHARACTERS WITHOUT CLAIM TO ANY PARTICULAR FONT, STYLE, SIZE, OR COLOR.

NO CLAIM IS MADE TO THE EXCLUSIVE RIGHT TO USE "WAR", APART FROM THE MARK AS SHOWN.

FOR TRADING CARDS AND BOOKS ON THE SUBJECT OF CHARACTERS IN TRADING CARDS (U.S. CLS. 2, 5, 22, 23, 29, 37, 38 AND 50).

GENE MACIOL, EXAMINING ATTORNEY

CLASS 16—(Continued).

SN 77-393,125. HEARTFELT STORIES, COLUMBUS, OH. FILED 2-9-2008.



THE COLOR(S) BLACK AND YELLOW IS/ARE CLAIMED AS A FEATURE OF THE MARK.

THE MARK CONSISTS OF A HEART WITH A BLACK OUTLINE AND YELLOW INSIDE THE BODY OF THE HEART.

FOR A SERIES OF BOOKS, WRITTEN ARTICLES, HANDOUTS AND WORKSHEETS IN THE FIELD OF LIFE LESSONS, CORE VALUES AND EDUCATIONAL STORIES FOR CHILDREN (U.S. CLS. 2, 5, 22, 23, 29, 37, 38 AND 50).

FIRST USE 0-0-2007; IN COMMERCE 0-0-2007.
MORGAN WYNNE, EXAMINING ATTORNEY

SN 77-395,731. VITAE CARING FOUNDATION, JEFFERSON CITY, MO. FILED 2-13-2008.

VITAE CARING FOUNDATION

THE MARK CONSISTS OF STANDARD CHARACTERS WITHOUT CLAIM TO ANY PARTICULAR FONT, STYLE, SIZE, OR COLOR.

NO CLAIM IS MADE TO THE EXCLUSIVE RIGHT TO USE "FOUNDATION", APART FROM THE MARK AS SHOWN.

THE ENGLISH TRANSLATION OF "VITAE" IN THE MARK IS LIVES.

FOR PRINTED MATERIALS, NAMELY, PAMPHLETS, BROCHURES, AND NEWSLETTERS IN THE FIELD OF PRO-LIFE ISSUES (U.S. CLS. 2, 5, 22, 23, 29, 37, 38 AND 50).

FIRST USE 0-0-2002; IN COMMERCE 0-0-2002.
CARYN GLASSER, EXAMINING ATTORNEY

CLASS 16—(Continued).

SN 77-396,970. EVANS, GLENDA PAULETTA, SILVER SPRING, MD. FILED 2-14-2008.

The Urban Sophisticate

THE MARK CONSISTS OF STANDARD CHARACTERS WITHOUT CLAIM TO ANY PARTICULAR FONT, STYLE, SIZE, OR COLOR.

FOR SERIES OF FICTION BOOKS; SERIES OF NON-FICTION BOOKS IN THE FIELD OF LIFE PLANNING AND LIFE COACHING (U.S. CLS. 2, 5, 22, 23, 29, 37, 38 AND 50).

PRISCILLA MILTON, EXAMINING ATTORNEY

SN 77-400,298. FRANCO-TYP-POSTALIA GMBH, BIRKENWERDER, FED REP GERMANY, FILED 2-19-2008.

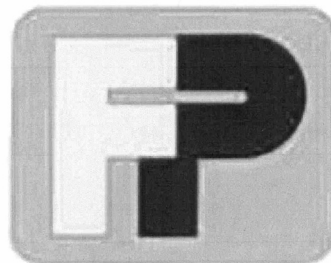

PRIORITY CLAIMED UNDER SEC. 44(D) ON FED REP GERMANY APPLICATION NO. 307630943, FILED 9-26-2007, REG. NO. 30763094, DATED 1-16-2008, EXPIRES 9-30-2017.

THE COLOR(S) LIGHT SILVER, SILVER AND BLACK IS/ARE CLAIMED AS A FEATURE OF THE MARK.

THE MARK CONSISTS OF A RECTANGULAR SHAPE WITH ROUNDED CORNERS IN THE COLOR SILVER, THE CAPITAL LETTER "F" BEING IN THE COLOR LIGHT SILVER AND POSITIONED ON THE LEFT-SIDE OF THE RECTANGULAR SHAPE, THE CAPITAL LETTER "P" BEING IN THE COLOR BLACK AND POSITIONED NEXT TO THE "F" ON THE RIGHT-SIDE OF THE RECTANGULAR SHAPE.

FOR FRANKING MACHINES; AND FRANKING SYSTEMS COMPRISED OF FRANKING MACHINES, AUTOMATIC FEEDER MODULES, SEPARATORS, DYNAMIC SCALES, INTEGRATED STATIC SCALES, LABEL DISPENSERS, MOISTENING DEVICES, AND ENVELOP SEALERS (U.S. CLS. 2, 5, 22, 23, 29, 37, 38 AND 50).

FIRST USE 9-30-2005; IN COMMERCE 9-30-2005.
BILL DAWE, EXAMINING ATTORNEY

CLASS 16—(Continued).

SN 77-408,513. ARTISTIC PURSUITS INC., ARVADA, CO. FILED 2-28-2008.



NO CLAIM IS MADE TO THE EXCLUSIVE RIGHT TO USE "ARTISTIC", APART FROM THE MARK AS SHOWN. FOR EDUCATIONAL BOOKS FEATURING ELEMENTARY, MIDDLE, AND HIGH SCHOOL ART (U.S. CLS. 2, 5, 22, 23, 29, 37, 38 AND 50). FIRST USE 1-5-2001; IN COMMERCE 2-15-2001. SETH A. RAPPAPORT, EXAMINING ATTORNEY

CLASS 16—(Continued).

SN 77-428,657. USA ZAMA, INC., FRANKLIN, TN. FILED 3-21-2008.



OWNER OF U.S. REG. NO. 1,889,618. THE MARK CONSISTS OF A STYLIZED VERSION OF WORD "ZAMA" WITH DOUBLE LINES. FOR INSTRUCTION MANUALS FOR USE WITH CARBURETORS (U.S. CLS. 2, 5, 22, 23, 29, 37, 38 AND 50). FIRST USE 10-0-2006; IN COMMERCE 10-0-2006. EMILY CARLSEN, EXAMINING ATTORNEY

SN 77-413,192. WEST 16TH STREET MAP CO., INC., DBA RED MAPS, NEW YORK, NY. FILED 3-5-2008.

THE RED MAP

THE MARK CONSISTS OF STANDARD CHARACTERS WITHOUT CLAIM TO ANY PARTICULAR FONT, STYLE, SIZE, OR COLOR. OWNER OF U.S. REG. NO. 3,238,569. NO CLAIM IS MADE TO THE EXCLUSIVE RIGHT TO USE "MAP", APART FROM THE MARK AS SHOWN. SEC. 2(F). FOR MAPS AND TRAVEL GUIDES (U.S. CLS. 2, 5, 22, 23, 29, 37, 38 AND 50). FIRST USE 4-29-1998; IN COMMERCE 5-8-1998. ANN E. SAPPENFIELD, EXAMINING ATTORNEY

SN 77-428,773. SHULTERBRANDT, SHARLISE, DBA LIFE TIMES INVITATIONS FOR ALL THE TIMES OF YOUR LIFE, MONTGOMERY VILLAGE, MD. FILED 3-21-2008.

**LIFE TIMES
Invitations for all the
times of your life**

THE MARK CONSISTS OF STANDARD CHARACTERS WITHOUT CLAIM TO ANY PARTICULAR FONT, STYLE, SIZE, OR COLOR. NO CLAIM IS MADE TO THE EXCLUSIVE RIGHT TO USE "INVITATIONS", APART FROM THE MARK AS SHOWN. FOR PRINTED INVITATIONS (U.S. CLS. 2, 5, 22, 23, 29, 37, 38 AND 50). GISELLE AGOSTO, EXAMINING ATTORNEY

SN 77-421,891. COOLER CONCEPTS, INC., PLYMOUTH, MN. FILED 3-14-2008.

PERMA TRANS

THE MARK CONSISTS OF STANDARD CHARACTERS WITHOUT CLAIM TO ANY PARTICULAR FONT, STYLE, SIZE, OR COLOR. FOR HEAT TRANSFER PAPER, NAMELY, SPECIALIZED PAPER FORMULATED TO BE IMPRINTED WITH AN IMAGE THAT IS SUBSEQUENTLY TRANSFERRED FROM THE PAPER TO FABRIC (U.S. CLS. 2, 5, 22, 23, 29, 37, 38 AND 50). FIRST USE 3-12-2008; IN COMMERCE 3-12-2008. CYNTHIA TRIPI, EXAMINING ATTORNEY

SN 77-433,284. KLABIN S/A, SÃO PAULO, BRAZIL, FILED 3-27-2008.

KLAFOLD

THE MARK CONSISTS OF STANDARD CHARACTERS WITHOUT CLAIM TO ANY PARTICULAR FONT, STYLE, SIZE, OR COLOR. PRIORITY CLAIMED UNDER SEC. 44(D) ON BRAZIL APPLICATION NO. 829523553, FILED 11-1-2007. FOR PAPERBOARD; CARDBOARD; CORRUGATED BOARD (U.S. CLS. 2, 5, 22, 23, 29, 37, 38 AND 50). ANTHONY RINKER, EXAMINING ATTORNEY

CLASS 16—(Continued).

SN 77-435,137. PINE PRODUCTIONS, BOULDER CITY, NV.
FILED 3-29-2008.

G-Rated Vegas

THE MARK CONSISTS OF STANDARD CHARACTERS WITHOUT CLAIM TO ANY PARTICULAR FONT, STYLE, SIZE, OR COLOR.

NO CLAIM IS MADE TO THE EXCLUSIVE RIGHT TO USE "VEGAS", APART FROM THE MARK AS SHOWN.

FOR MAGAZINES FEATURING INFORMATION ON FAMILY-FRIENDLY ENTERTAINMENT, RECREATION, EDUCATION AND OTHER TOPICS OF INTEREST TO PARENTS OR RELATIVES VISITING AND LIVING IN LAS VEGAS NV, NAMELY SIGHTSEEING (U.S. CLS. 2, 5, 22, 23, 29, 37, 38 AND 50).
DAVID MURRAY, EXAMINING ATTORNEY

CLASS 16—(Continued).

SN 77-442,519. WEST 16TH STREET MAP CO., INC., DBA RED MAPS, NEW YORK, NY. FILED 4-8-2008.

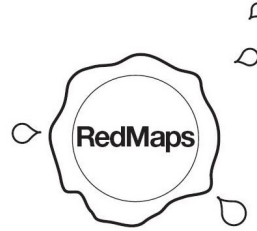

OWNER OF U.S. REG. NO. 3,238,569.

THE MARK CONSISTS OF THE WORDS "RED MAPS" CONTAINED WITHIN A CIRCLE WHICH IS SURROUNDED BY A DEPICTION OF AN INKSTAIN. THERE ARE FOUR DROPLET SHAPES ON THE OUTSIDE OF THE INKSTAIN.

SEC. 2(F) "REDMAPS" HAS BECOME DISTINCTIVE OF THE GOODS/SERVICES THROUGH THE APPLICANT'S SUBSTANTIALLY EXCLUSIVE AND CONTINUOUS USE IN COMMERCE FOR AT LEAST THE FIVE YEARS IMMEDIATELY BEFORE THE DATE OF THIS STATEMENT.

FOR MAPS AND TRAVEL GUIDES (U.S. CLS. 2, 5, 22, 23, 29, 37, 38 AND 50).

FIRST USE 4-3-2008; IN COMMERCE 4-4-2008.

ANN E. SAPPENFIELD, EXAMINING ATTORNEY

SN 77-443,062. ANGELA MARTIN MCCLUNG, DBA AMO, GREENSBORO, NC. FILED 4-8-2008.

Redneckognize

AMO

THE MARK CONSISTS OF STANDARD CHARACTERS WITHOUT CLAIM TO ANY PARTICULAR FONT, STYLE, SIZE, OR COLOR.

FOR BOOKS IN THE FIELD OF PERSONAL RELATIONSHIPS (U.S. CLS. 2, 5, 22, 23, 29, 37, 38 AND 50).

KIMBERLY PERRY, EXAMINING ATTORNEY

SN 77-441,078. DENNIS TIERNEY/ROB BUTI, PLYMOUTH, MI. FILED 4-6-2008.

Run...It's What I do

THE MARK CONSISTS OF STANDARD CHARACTERS WITHOUT CLAIM TO ANY PARTICULAR FONT, STYLE, SIZE, OR COLOR.

FOR PROMOTIONAL PRODUCTS, NAMELY, DECALS (U.S. CLS. 2, 5, 22, 23, 29, 37, 38 AND 50).

TOBY BULLOFF, EXAMINING ATTORNEY

SN 77-453,610. LB BRANDS, LLC, PORT CLYDE, ME. FILED 4-21-2008.

LINDA BEAN'S

THE MARK CONSISTS OF STANDARD CHARACTERS WITHOUT CLAIM TO ANY PARTICULAR FONT, STYLE, SIZE, OR COLOR.

THE NAME(S), PORTRAIT(S), AND/OR SIGNATURE(S) SHOWN IN THE MARK IDENTIFIES LINDA L. BEAN, WHOSE CONSENT(S) TO REGISTER IS SUBMITTED.

FOR COOK BOOKS (U.S. CLS. 2, 5, 22, 23, 29, 37, 38 AND 50).

TIMOTHY FINNEGAN, EXAMINING ATTORNEY

CLASS 16—(Continued).

SN 77-460,944. COFFMAN, MARY F., SENECA, SC. AND COFFMAN, GEORGE M., SENECA, SC. FILED 4-29-2008.

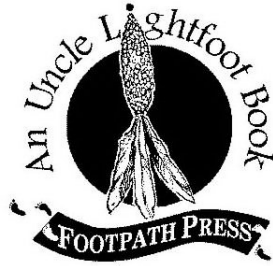

NO CLAIM IS MADE TO THE EXCLUSIVE RIGHT TO USE "BOOK" AND "PRESS", APART FROM THE MARK AS SHOWN.

THE MARK CONSISTS OF IN PART, A STYLIZED CORN STALK AND FIVE FOOTPRINTS.

FOR PUBLICATIONS, NAMELY, CHILDREN'S BOOKS (U.S. CLS. 2, 5, 22, 23, 29, 37, 38 AND 50).

JAY FLOWERS, EXAMINING ATTORNEY

SN 77-461,507. AVEC ERIC, LLC, NEW YORK, NY. FILED 4-30-2008.

AVEC ERIC

THE MARK CONSISTS OF STANDARD CHARACTERS WITHOUT CLAIM TO ANY PARTICULAR FONT, STYLE, SIZE, OR COLOR.

THE ENGLISH TRANSLATION OF "AVEC" IS "WITH".

FOR BOOKS, MANUALS AND NEWSLETTERS IN THE FIELDS OF FOOD, WINE, BEVERAGES, COOKING, BAKING, ENTERTAINING, RECIPES, DIET, NUTRITIONAL ADVICE, DINING AND RESTAURANT INFORMATION, KITCHEN DESIGN, EQUIPMENT AND ACCESSORIES, ETIQUETTE AND TRAVEL; DIARIES; CALENDARS; AND POSTERS (U.S. CLS. 2, 5, 22, 23, 29, 37, 38 AND 50).

LESLIE RICHARDS, EXAMINING ATTORNEY

CLASS 16—(Continued).

SN 77-464,493. SOUL MESSAGES, ATASCADERO, CA. FILED 5-2-2008.



THE COLOR(S) RED, DARK RED, LIGHT RED, WHITE AND BLACK IS/ARE CLAIMED AS A FEATURE OF THE MARK.

THE MARK CONSISTS OF THE DESIGN OF RED HEART CONTAINING THE WORD "CHERISH" IN BLACK TEXT WITH WHITE OUTLINE AND TINY BLACK HEART IN PLACE OF THE DOT ON THE "I". THE RED HEART CONTAINS A LIGHT RED BORDER AROUND ITS PERIMETER. A DARK RED TEARDROP WITH A WHITE BORDER DESCENDS FROM THE LETTER "E" IN "CHERISH".

FOR PET MEMORIAL AND BURIAL KIT FOR SMALL CREATURES CONTAINING TWO PAPIER MACHE BURIAL BOXES, FABRIC POUCH, SILK CLOTH, PAPER PHOTO FRAME, ARTIFICIAL STONE HEART, FLAMELESS CANDLE, FLOWER SEED PACKET, ARTIFICIAL FLOWER AND INSTRUCTIONS IN A DECORATIVE REUSABLE PLASTIC CONTAINER (U.S. CLS. 2, 5, 22, 23, 29, 37, 38 AND 50).

SONYA STEPHENS, EXAMINING ATTORNEY

SN 77-474,047. LONGS DRUG STORES CALIFORNIA, INC. WALNUT CREEK, CA. FILED 5-14-2008.

Island Accents

THE MARK CONSISTS OF "ISLAND" OVER "ACCENTS" IN SCRIPT.

FOR PLASTIC TRASH BAGS (U.S. CLS. 2, 5, 22, 23, 29, 37, 38 AND 50).

WILLIAM BRECKENFELD, EXAMINING ATTORNEY

CLASS 16—(Continued).

SN 77-476,983. MEREDITH CORPORATION, DES MOINES, IA. FILED 5-16-2008.

AMERICAN BABY

THE MARK CONSISTS OF STANDARD CHARACTERS WITHOUT CLAIM TO ANY PARTICULAR FONT, STYLE, SIZE, OR COLOR.

OWNER OF U.S. REG. NOS. 1,496,741, 1,908,875 AND 2,550,825.

NO CLAIM IS MADE TO THE EXCLUSIVE RIGHT TO USE "BABY", APART FROM THE MARK AS SHOWN.

FOR BOOKS ON TOPICS OF INTEREST TO EXPECTANT PARENTS AND PARENTS OF YOUNG CHILDREN; DECALS; AND BOOK ENDS (U.S. CLS. 2, 5, 22, 23, 29, 37, 38 AND 50).

BRIDGETT SMITH, EXAMINING ATTORNEY

SN 77-480,753. VENOM, LLC, SAN FRANCISCO, CA. FILED 5-21-2008.

DEADLOCKE

THE MARK CONSISTS OF STANDARD CHARACTERS WITHOUT CLAIM TO ANY PARTICULAR FONT, STYLE, SIZE, OR COLOR.

FOR ARTS AND CRAFT ACTIVITY KITS CONTAINING STAMPER MARKERS, RUBBER STAMPERS, INK PAD, COLORED PENCILS AND STAMPER HOLDER PACKAGED AS A UNIT; ADDRESS BOOKS; ART PRINTS; PENCILS; PENS; ARTIST'S BRUSHES; PAINTING BRUSHES; WRITING BRUSHES; DRAWING BRUSHES; ARTS AND CRAFT DRAWING KITS COMPOSED PRIMARILY OF PAPER, PENCILS, PENS, CRAYONS, MARKERS AND STENCILS; ARTS AND CRAFT DRAWING KITS COMPOSED PRIMARILY OF VARIOUS COMBINATIONS OF PAPER, PENCILS, PENS, CRAYONS MARKER, PAPER STICKERS AND STENCILS; ARTS AND CRAFT PAINT KITS COMPOSED PRIMARILY OF VARIOUS COMBINATIONS OF PAPER, PAINTS, ADHESIVES, PAPER STICKERS AND MARKERS; BANK CHECKS; BANNERS MADE OF PAPER; BLANK NOTE CARDS; BOOKBINDING MATERIAL, NAMELY, CLOTH FOR BOOKBINDING, BOOKBINDINGS, WIRE AND TAPE; BOOK MARKS; BOOK PLATES; BOOKS CONTAINING PUZZLES AND GAMES; BOOKS FEATURING PHOTOGRAPHIC PRINTS; ROLE PLAYING GAME EQUIPMENT IN THE NATURE OF GAME BOOK MANUALS; BOOKS ON FANTASY; BOOKENDS; CALENDARS; CARDBOARD; CARDBOARD FIGURES; CHILDREN'S ACTIVITY BOOKS; CHILDREN'S ACTIVITY SETS COMPOSED OF PUZZLE AND MAZE BOOKS; COIN ALBUMS; COLLECTOR ALBUMS FOR STAMPS; COLLECTORS ALBUMS FOR COINS; COLLECTORS ALBUMS FOR TRADING CARDS; COLORING BOOKS; COMIC BOOKS; COMIC MAGAZINES; COMPOSITION BOOKS; COOKBOOKS; COPY BOOKS; CORRESPONDENCE NOTE PAPER; DECORATIVE RUBBER STAMPS; DESK ACCESSORIES, NAMELY, DESK BASKETS, DESK FILE TRAYS, DESK PADS, DESK SETS, AND DESK CALENDARS; DESK PADS; DESK STANDS FOR PENS; DESK STANDS FOR PENCILS; DESK STANDS FOR INK; DESK STANDS FOR CALENDARS; DESK HOLDERS FOR PENS, PENCILS, TAPE, AND PAPER CLIPS; DESK TOP ORGANIZERS; DECORATIVE PENCIL-TOP ORNAMENTS; DIARIES; ERASERS; MAGAZINES IN THE FIELD OF FANTASY AND SCIENCE

CLASS 16—(Continued).

FICTION; FLAGS MADE OF PAPER; GIFT BOOKS FEATURING ARTWORK FROM MOTION PICTURE FILMS; GIFT BOOKS FEATURING ARTWORK FROM STAGE PRODUCTIONS; GIFTBOOKS FEATURING ARTWORK FROM VIDEO GAMES; GIFT BOXES MADE OF PAPER; GIFT WRAPPING PAPER; GLUE FOR STATIONERY AND HOUSEHOLD USE; GREETING CARDS; GUEST BOOKS; INSTRUCTION MANUALS FOR COMPUTER GAMES; INSTRUCTION MANUALS FOR ROLE PLAYING GAMES; INSTRUCTION MANUALS FOR TABLE TOP GAMES; INSTRUCTION MANUALS FOR GAMES OF CHANCE; INSTRUCTION MANUALS FOR CARD GAMES; INSTRUCTION MANUALS FOR CHESS GAMES; INSTRUCTION MANUALS FOR BACKGAMMON GAMES; INSTRUCTION MANUALS FOR TRIVIA GAMES; PRINTED GUIDES AND ROLE PLAYING GAME CHARTS USED IN ASSOCIATION WITH COMPUTER GAMES AND MULTIPLAYER INTERACTIVE GAMES; INSTRUCTIONAL MANUALS AND STRATEGY GUIDES FOR GAMES; PAPER; PRINTED INVITATIONS; IRON-ON TRANSFERS; PLASTIC TRANSFERS; IRON-ON PAPER PATCHES FOR CLOTHING; LITHOGRAPHIC PRINTS; LITHOGRAPHS; OFFICE SUPPLIES, NAMELY, ADHESIVE MATERIALS FOR OFFICE USE, ADHESIVE TAPE DISPENSERS, BINDERS FOR OFFICE USE, CORRECTING FLUID FOR TYPE, PAPER AND OFFICE HOLE PUNCHERS, OFFICE STATIONERY AND STAPLERS; NON-MAGNETIC CARDS FOR USE AS CREDIT CARDS; MEMORANDUM BOARDS; NON-ELECTRONIC PERSONAL DAY PLANNERS AND ORGANIZERS; NON-ELECTRONIC MONTHLY PLANNERS AND ORGANIZERS; NON-ELECTRONIC YEARLY PLANNERS AND ORGANIZERS; NON-MAGNETICALLY CODED TELEPHONE CALLING CARDS; MARKERS; NOTEBOOKS; NOTEPAD AND PENCIL SETS; NOTEPADS; ORGANIZERS FOR STATIONERY USE; PARTY ORNAMENTS MADE OF PAPER; ORIGINAL ARTWORK PRINTS; PAINTING SETS FOR CHILDREN; PAPER DOORKNOB HANGERS; PAPER MACHE FIGURES; PAPER NAPKINS; PAPER PARTY DECORATIONS; PAPER RIBBONS; PAPER TABLE CLOTHS; PAPERWEIGHTS; PATTERNS FOR MAKING COSTUMES; PENCILS; PENCIL CASES; PENCIL SHARPENERS; PENS; PARTY ORNAMENTS OF PAPER; PERSONAL ORGANIZERS; PHOTOGRAPH ALBUMS; PHOTOGRAPHIC PRINTS; PICTURE BOOKS; PLASTIC PAGES FOR HOLDING TRADING CARDS; PLASTIC MATERIALS FOR PACKAGING, NAMELY, GIFT WRAP, PLASTIC TRADING CARD HOLDERS AND PLASTIC BAGS; PRE-PAID, NON-MAGNETICALLY ENCODED CARDS FOR PLAYING VIDEO GAMES, COMPUTER GAMES AND ON-LINE INTERACTIVE GAMES; POP-UP BOOKS, POSTCARDS; POSTER BOOKS; POSTERS; PRINTED INSTRUCTIONAL, EDUCATIONAL AND TEACHING MATERIALS IN THE FIELD OF FANTASY; PRINTED PAPER PATTERNS; RUB DOWN TRANSFERS; SCHOOL SUPPLIES, NAMELY, WRITING INSTRUMENTS, PENS, PENCILS, ERASERS, MARKERS, CRAYONS, HIGHLIGHTERS, FOLDERS, NOTEBOOKS, NOTE PADS, PAPER, PAPER CLIPS, NON-ELECTRIC PENCIL SHARPENERS AND GLUE; SCHOOL SUPPLY KITS COMPOSED PRIMARILY OF VARIOUS COMBINATIONS OF SELECTED SCHOOL SUPPLIES, NAMELY, WRITING INSTRUMENTS, PENS, PENCILS, ERASERS, MARKERS, CRAYONS, HIGHLIGHTERS, FOLDERS, NOTEBOOKS, NOTE PADS, PAPER, PROTRACTORS, PAPER CLIPS, NON-ELECTRIC PENCIL SHARPENERS, GLUE AND BOOK MARKS; SCRAPBOOK ALBUMS; SKETCHBOOKS; STAMP ALBUMS; STATIONERY; STATIONERY SETS COMPOSED OF PAPER, ENVELOPES, SEALS AND NOTEPADS; STATIONERY-TYPE PORTFOLIOS; STENCILS; STICKER BOOKS; STICKERS; TEMPORARY TATTOOS; TRADING CARD SOFT DRINK BOTTLE CAPS; TRADING CARDS; TRADING CARD DISCS OF PAPER; TRADING CARD DISCS OF CARDBOARD; TRIVIA CARDS; TRAVEL GUIDE BOOKS; WALL CHARTS IN THE FIELD OF FANTASY; WRIT-

CLASS 16—(Continued).

ING PADS; ARTS AND CRAFT ACTIVITY KITS CONSISTING OF MODELING MATERIALS AND COMPOUNDS FOR USE BY CHILDREN; GRAPHIC ART REPRODUCTIONS; PRINTED ART REPRODUCTIONS; KITS CONSISTING PRIMARILY OF COLORING BOOKS AND CRAYONS; KITS CONSISTING PRIMARILY OF COLOR-BY-NUMBER BOOKS AND CRAYONS; KITS CONSISTING PRIMARILY OF COLORING BOOKS AND COLORED PENCILS; KITS CONSISTING PRIMARILY OF COLOR-BY-NUMBER BOOK AND COLORED PENCILS; PRINTED HOLOGRAMS (U.S. CLS. 2, 5, 22, 23, 29, 37, 38 AND 50).

ELISSA GARBER KON, EXAMINING ATTORNEY

CLASS 16—(Continued).

SN 77-505,003. SCOTT HELTERBRIDLE, DBA REVNJENZ, CINCINNATI, OH. FILED 6-22-2008.

COME RACE AND PLAY NOW!

SN 77-491,276. BASINET, MICHAEL J., BONSALE, CA. FILED 6-4-2008.

SHIP 2 STORAGE

THE MARK CONSISTS OF STANDARD CHARACTERS WITHOUT CLAIM TO ANY PARTICULAR FONT, STYLE, SIZE, OR COLOR.

NO CLAIM IS MADE TO THE EXCLUSIVE RIGHT TO USE "STORAGE", APART FROM THE MARK AS SHOWN, FOR BOXES OF CARDBOARD OR PAPER; FILE BOXES FOR STORAGE OF BUSINESS AND PERSONAL RECORD (U.S. CLS. 2, 5, 22, 23, 29, 37, 38 AND 50).
JASON BLAIR, EXAMINING ATTORNEY

THE MARK CONSISTS OF STANDARD CHARACTERS WITHOUT CLAIM TO ANY PARTICULAR FONT, STYLE, SIZE, OR COLOR.

FOR TRADING CARDS (U.S. CLS. 2, 5, 22, 23, 29, 37, 38 AND 50).

FIRST USE 6-19-2008; IN COMMERCE 6-19-2008.
MATTHEW MCDOWELL, EXAMINING ATTORNEY

SN 77-503,057. THE PARENTING GROUP, INC., WINTER PARK, FL. FILED 6-19-2008.



OWNER OF U.S. REG. NOS. 1,578,948, 2,026,010 AND 2,715,993.

THE COLOR(S) KELLY GREEN AND TEAL IS/ARE CLAIMED AS A FEATURE OF THE MARK.

THE MARK CONSISTS OF THE LETTERING "TPG", ABOVE THE WORDING "THE PARENTING GROUP". THE COLOR KELLY GREEN APPEARS IN THE LETTERS "T" AND "G". THE COLOR TEAL APPEARS IN THE LETTER "P" AND IN THE WORDING "THE PARENTING GROUP".

SEC. 2(F) "THE PARENTING GROUP".

FOR MAGAZINES AND BOOKS IN THE FIELDS OF HEALTH, PREGNANCY, PRE-NATAL AND POST-NATAL CARE, CHILD BIRTH, BABY CARE, DIET, EXERCISE AND FEATURING OTHER INFORMATION FOR AND ABOUT PARENTS AND EXPECTANT PARENTS (U.S. CLS. 2, 5, 22, 23, 29, 37, 38 AND 50).

KIM MONINGHOFF, EXAMINING ATTORNEY

SN 77-505,055. EDWARDS, JEFF, ROUND ROCK, TX. FILED 6-23-2008.

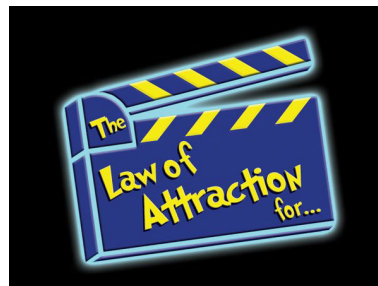

THE COLOR(S) THE COLORS BLUE, LIGHT BLUE, YELLOW AND BLACK ARE CLAIMED AS A FEATURE OF THE MARK. IS/ARE CLAIMED AS A FEATURE OF THE MARK.

THE MARK CONSISTS OF A BLUE CLAPBOARD WITH YELLOW STRIPES. THE CLAPBOARD IS OUTLINED IN LIGHT BLUE. THE WORDS "THE LAW OF ATTRACTION FOR..." APPEARS IN YELLOW WITHIN THE CLAPBOARD. THE CLAPBOARD APPEARS ON A SOLID BLACK BACKGROUND.

FOR SERIES OF NON-FICTION BOOKS IN THE FIELD OF CURRENT AFFAIRS, BUSINESS, NAMELY, SALES, MARKETING, STARTING A BUSINESS, CAREERS AND EMPLOYMENT, HEALTH AND FITNESS, HISTORY, HUMOR, PSYCHOLOGY, RELATIONSHIPS, SELF-HELP, SCIENCE, AND SPORTS (U.S. CLS. 2, 5, 22, 23, 29, 37, 38 AND 50).

GIANCARLO CASTRO, EXAMINING ATTORNEY

CLASS 16—(Continued).

SN 77-519,242. CCP HF, REYKJAVIK, ICELAND, FILED 7-10-2008.

Gangrel

THE MARK CONSISTS OF STANDARD CHARACTERS WITHOUT CLAIM TO ANY PARTICULAR FONT, STYLE, SIZE, OR COLOR.

FOR ROLE PLAYING GAME EQUIPMENT IN THE NATURE OF GAME BOOK MANUALS; SERIES OF FICTION BOOKS (U.S. CLS. 2, 5, 22, 23, 29, 37, 38 AND 50).

FIRST USE 6-1-1991; IN COMMERCE 6-1-1991, ROSELLE HERRERA, EXAMINING ATTORNEY

SN 77-532,545. ENDURANCE MAGAZINE, LLC, DURHAM, NC. FILED 7-28-2008.

Endurance^{magazine}

NO CLAIM IS MADE TO THE EXCLUSIVE RIGHT TO USE "MAGAZINE", APART FROM THE MARK AS SHOWN.

THE MARK CONSISTS OF THE WORD "MAGAZINE" WRITTEN ABOVE AND TO THE RIGHT OF THE WORD "ENDURANCE".

SEC. 2(F).

FOR CALENDARS; MAGAZINES FEATURING ENDURANCE SPORTS (U.S. CLS. 2, 5, 22, 23, 29, 37, 38 AND 50).

FIRST USE 4-1-2003; IN COMMERCE 4-1-2003, KEVIN DINALLO, EXAMINING ATTORNEY

SN 77-539,723. WHOLE FOODS MARKET IP, L.P., AUSTIN, TX. FILED 8-5-2008.

THE WHOLE DEAL

THE MARK CONSISTS OF STANDARD CHARACTERS WITHOUT CLAIM TO ANY PARTICULAR FONT, STYLE, SIZE, OR COLOR.

OWNER OF U.S. REG. NOS. 1,557,320, 1,961,586 AND 3,135,943.

NO CLAIM IS MADE TO THE EXCLUSIVE RIGHT TO USE "DEAL", APART FROM THE MARK AS SHOWN.

FOR PRINTED MATTER, NAMELY, NEWSLETTERS AND INFORMATIONAL FLYERS PERTAINING TO MONEY SAVING TIPS, RECIPES, MENU PLANNERS, SHOPPING, AND NUTRITION (U.S. CLS. 2, 5, 22, 23, 29, 37, 38 AND 50).

REGINA DRUMMOND, EXAMINING ATTORNEY

CLASS 16—(Continued).

SN 77-551,546. TRACKING TECHNOLOGIES, LLC, WEST-BROOK, ME. FILED 8-20-2008.



THE MARK CONSISTS OF THE STYLIZED WORDING "TRAKTEC" WRITTEN ON THE DESIGN OF A LABEL WITH THE LOWER RIGHT CORNER OF THE LABEL LIFTED.

FOR ADDRESS LABELS; ADHESIVE LABELS; BAR CODE LABELS; BLANK OR PARTIALLY PRINTED PAPER LABELS; PAPER LABELS; PRINTED PAPER LABELS; SHIPPING LABELS (U.S. CLS. 2, 5, 22, 23, 29, 37, 38 AND 50).

FIRST USE 7-1-2008; IN COMMERCE 7-1-2008, SARA THOMAS, EXAMINING ATTORNEY

SN 77-551,769. SCHWAN'S IP, LLC, MARSHALL, MN. FILED 8-20-2008.

KIDSFIRST DAYCARE FOODS WHERE KIDS COME FIRST!

THE MARK CONSISTS OF STANDARD CHARACTERS WITHOUT CLAIM TO ANY PARTICULAR FONT, STYLE, SIZE, OR COLOR.

NO CLAIM IS MADE TO THE EXCLUSIVE RIGHT TO USE "DAYCARE FOODS", APART FROM THE MARK AS SHOWN.

FOR CATALOGS IN THE FIELD OF FROZEN FOODS (U.S. CLS. 2, 5, 22, 23, 29, 37, 38 AND 50).

MARGARET POWER, EXAMINING ATTORNEY

SN 77-553,307. MEISTER MEDIA WORLDWIDE INC., WILLOUGHBY, OH. FILED 8-22-2008.

FLORIDA GROWER

THE MARK CONSISTS OF STANDARD CHARACTERS WITHOUT CLAIM TO ANY PARTICULAR FONT, STYLE, SIZE, OR COLOR.

OWNER OF U.S. REG. NOS. 799,534, 2,858,071 AND OTHERS.

SEC. 2(F).

FOR PRINTED PERIODICALS IN THE FIELD OF AGRICULTURE (U.S. CLS. 2, 5, 22, 23, 29, 37, 38 AND 50).

FIRST USE 1-0-1998; IN COMMERCE 1-0-1998.

JIM RINGLE, EXAMINING ATTORNEY

CLASS 16—(Continued).

SN 77-554,322. CRAVING CALORIES, LLC, DRESHER, PA. FILED 8-24-2008.

Craving Calories

THE MARK CONSISTS OF STANDARD CHARACTERS WITHOUT CLAIM TO ANY PARTICULAR FONT, STYLE, SIZE, OR COLOR.

NO CLAIM IS MADE TO THE EXCLUSIVE RIGHT TO USE "CALORIES", APART FROM THE MARK AS SHOWN. FOR COOK BOOKS (U.S. CLS. 2, 5, 22, 23, 29, 37, 38 AND 50).

TRACY CROSS, EXAMINING ATTORNEY

CLASS 16—(Continued).

FOR STICKERS, BUMPER STICKERS, DECORATIVE STICKERS FOR HELMETS, STICKER ALBUMS, STICKERS, STATIONERY STICKERS, STICKERS AND STICKER ALBUMS, STICKERS AND TRANSFERS, DRY TRANSFER CHARACTERS, ENVELOPES FOR STATIONERY USE, HALLOWEEN GOODIE BAGS OF PAPER OR PLASTIC, LUNCH BAGS, LUNCH BAGS MADE OF TEXTILES, PAPER GIFT BAGS, PAPER PARTY BAGS, PARTY GOODIE BAGS OF PAPER OR PLASTIC, SANDWICH BAGS, PAPER PARTY DECORATIONS, PAPER PARTY FAVORS, PARTY ORNAMENTS OF PAPER, METALLIC PAPER PARTY DECORATIONS, PAPER NAPKINS, TABLE NAPKINS OF PAPER, STENCIL PLATES, BIRTHDAY BOOKS, BABY BOOKS, INVITATION CARDS, PRINTED INVITATION CARDS, GIFT BOXES, PICTURE BOOKS, ART PICTURES, PICTURES, PICTURE POST CARDS, WATER COLOR PICTURES, PAPER CAKE DECORATIONS, ADDRESS LABELS, ADHESIVE LABELS, CALENDAR DESK PADS, CALENDAR DESK STANDS, CALENDARS (U.S. CLS. 2, 5, 22, 23, 29, 37, 38 AND 50).

ELISSA GARBER KON, EXAMINING ATTORNEY

SN 77-555,619. DREWS, JILL, MONROEVILLE, PA. FILED 8-26-2008.



THE STIPPLING IS A FEATURE OF THE MARK.

THE MARK CONSISTS OF A LONG HAIREED GIRL, WITH CLOSED EYES, HAS A HEART SHAPED MOUTH, ROSY CHEEKS, WITH A BOW ON HER HEAD. THE STYLIZED WORD "CUTE" IS ABOVE THE GIRLS HEAD. THE STYLIZED WORDS "TO THE MAX" IS BELOW THE IMAGE OF THE GIRL. TWO SWIRLY LINES AND A HEART UNDERNEATH THE WORD "MAX!". ON EACH SIDE OF THE GIRL DRAWING, THERE ARE TWO STYLIZED VERTICAL LINES.

FOR STATIONERY, STATIONERY FOLDERS, STATIONERY WRITING PAPER AND ENVELOPES, STATIONERY TYPE PORTFOLIOS, STATIONERY STICKERS, GIFT CARDS, GREETING CARDS, POST CARDS, DECORATIVE PENCIL TOP ORNAMENTS, DECORATIVE PENCILS, DESK STANDS AND PENCIL HOLDERS, DRAWING PENCILS, EXTENSION AND ATTACHMENTS FOR PENCILS, MECHANICAL PENCILS, PEN AND PENCIL CASES AND BOXES, PEN AND PENCIL HOLDERS, PENCIL SHARPENERS, PENCILS FOR DRAWING AND PAINTING, STANDS FOR PENS AND PENCILS, PAINTING SETS FOR CHILDREN, PAINTINGS AND THEIR REPRODUCTIONS, GIFT WRAPPING PAPER, PAPER GIFT WRAPPING RIBBONS, NOTEBOOK DIVIDERS, NOTEBOOK PAPER, NOTEBOOKS, PAPER NOTEBOOKS, SCHOOL SUPPLY KITS CONTAINING VARIOUS COMBINATIONS OF SELECTED SCHOOL SUPPLIES, NAMELY, WRITING INSTRUMENTS, PENCILS, PENS, BOOKMARKS, PAPER CLIPS, ERASERS, GLUE, PENCIL SHARPENERS, MARKERS, CRAYONS, HIGH LIGHTER PENS, AND FOLDERS, RULERS, WIRE BOUND NOTEBOOKS; EDUCATIONAL PUBLICATIONS, NAMELY, EDUCATIONAL LEARNING CARDS, FLASH CARDS, ACTIVITY CARDS, WORKBOOKS, TEXTBOOKS, ACTIVITY BOOKS, STORY BOOKS, PUZZLE BOOKS, PRINTED PUZZLES, TEACHER GUIDES, MANUALS, POSTERS AND EDUCATIONAL BOOKLETS IN THE FIELD OF ELEMENTARY EDUCATION, READING, MATH, LANGUAGE ARTS, SCIENCE; POSTERS, MOUNTED POSTERS, ALBUMS

SN 77-556,261. COUNTY MUSIC ASSOCIATION, INC., NASHVILLE, TN. FILED 8-26-2008.

AMERICA'S SOLD ON COUNTRY

THE MARK CONSISTS OF STANDARD CHARACTERS WITHOUT CLAIM TO ANY PARTICULAR FONT, STYLE, SIZE, OR COLOR.

FOR EDUCATIONAL PUBLICATIONS, NAMELY, BROCHURES IN THE FIELD OF COUNTRY MUSIC (U.S. CLS. 2, 5, 22, 23, 29, 37, 38 AND 50).

FIRST USE 0-0-1997; IN COMMERCE 0-0-1997.

RON FAIRBANKS, EXAMINING ATTORNEY

SN 77-556,720. LOCAL ART RAG, WATER MILL, NY. FILED 8-27-2008.

Local Art Rag

THE MARK CONSISTS OF STANDARD CHARACTERS WITHOUT CLAIM TO ANY PARTICULAR FONT, STYLE, SIZE, OR COLOR.

NO CLAIM IS MADE TO THE EXCLUSIVE RIGHT TO USE "LOCAL ART", APART FROM THE MARK AS SHOWN.

FOR DIRECTORIES OF LOCAL ARTS AND ARTISTS (U.S. CLS. 2, 5, 22, 23, 29, 37, 38 AND 50).

FIRST USE 3-5-2008; IN COMMERCE 5-0-2008.

AMY HELLA, EXAMINING ATTORNEY

CLASS 16—(Continued).

SN 77-557,291. STUDIO MB, L.L.C., NEW VERNON, NJ. FILED 8-27-2008.



NO CLAIM IS MADE TO THE EXCLUSIVE RIGHT TO USE "LETTACE", "SEEDS", AND "USA", APART FROM THE MARK AS SHOWN.

THE COLOR(S) BLACK, WHITE, ORANGE, GREEN, BROWN, PINK AND RED IS/ARE CLAIMED AS A FEATURE OF THE MARK.

THE MARK CONSISTS OF A PERSON EMERGING OUT OF A SEED PACKET WHICH APPEARS TO BE GROWING FROM THE GROUND. THE SEED PACKET IS FEATURED IN THE COLOR WHITE WITH ALTERNATING BLACK AND WHITE HORIZONTAL LINES ALONG THE SIDE. DISPLAYED ACROSS THE TOP FRONT OF THE SEED PACKAGE IS THE STYLIZED WORD "SEEDS" IN BLACK. A PLANT APPEARS IN THE MIDDLE OF THE SEED PACKET WITH THE ROOTS APPEARING IN VARIOUS SHADES OF BROWN, ORANGE AND WHITE WITH THE FLOWERS APPEARING IN VARIOUS SHADES OF BROWN, ORANGE, RED AND GREEN. THE WORD "USA" THE NUMBERS "10" AND "02" ALL APPEAR IN THE COLOR BLACK TOWARDS THE BOTTOM OF THE SEEDS PACKET. ON EACH SIDE OF THE SEEDS PACKET TWO LARGE GREEN AND BROWN LEAVES EMERGE FROM THE VERY BOTTOM OF THE SEEDS PACKET. AT THE TOP OF THE SEEDS PACKET IS A PERSON WITH BLACK EYELASHES, A BLACK NOSE, AND PINK CHEEKS WEARING AN ORANGE SHIRT WITH ORANGE CUFFS, HOLDING A BROWN TROWEL WITH AN ORANGE HANDLE IN THE LEFT HAND. THE PERSON IS WEARING AN ORANGE HEADBAND WITH THE WORD "LETTACE" FEATURED IN THE COLOR BLACK AND A BLACK BERET WITH WHITE SHADING. THERE ARE THREE ORANGE DRIPS JUST BELOW THE RIGHT HAND.

FOR ADDRESS BOOKS AND DIARIES; PERSONALIZED WRITING JOURNALS; PICTORIAL PRINTS; PRINTED PAPER LABELS; PRINTED PAPER SIGNS; PUBLICATIONS, NAMELY, MAGAZINES AND NEWSLETTERS IN THE FIELDS OF GARDENING; TRADING CARDS (U.S. CLS. 2, 5, 22, 23, 29, 37, 38 AND 50).
CHARISMA HAMPTON, EXAMINING ATTORNEY

CLASS 16—(Continued).

SN 77-557,766. SCIACCA GREETING CARD PARTNERSHIP, RANCHO SANTA FE, CA. FILED 8-28-2008.



THE COLOR(S) BROWN, GOLD, GREY, PINK, BLACK AND WHITE IS/ARE CLAIMED AS A FEATURE OF THE MARK.

THE MARK CONSISTS OF A STYLIZED HEAD AND NECK OF A LAUGHING PONY, COLORIZED WITH BROWN FUR, GOLD MANE, WHITE BLAZE, WHITE TEETH, WHITE AROUND THE PUPILS, PINK TONGUE, PINK INSIDE THE EARS, BLACK PUPILS AND NOSTRILS, ALL OUTLINED IN BLACK; THE PONY'S HEAD IS RESTING ON OR LOOKING THROUGH THE ARC OF A HORSESHOE THAT IS COLORIZED IN GREY, WITH PARTS OF THE HORSESHOE OUTLINED IN BLACK; AND THE LITERAL ELEMENT OF THE MARK "LAUGHING PONY" IS CENTERED UNDERNEATH THE HORSESHOE IN A STYLIZED SCRIPT RESEMBLING ROPE, COLORIZED IN BROWN AND GOLD.

FOR CALENDARS; CARDS, NAMELY, GREETING CARDS, NOTE CARDS AND POSTCARDS; PERSONAL ORGANIZERS (U.S. CLS. 2, 5, 22, 23, 29, 37, 38 AND 50).
DAYNA BROWNE, EXAMINING ATTORNEY

SN 77-557,819. HUMMINGBIRD HEAVEN LLC, WHARTON, NJ. FILED 8-28-2008.

FUNTASY FUN-TO-SEE ART

THE MARK CONSISTS OF STANDARD CHARACTERS WITHOUT CLAIM TO ANY PARTICULAR FONT, STYLE, SIZE, OR COLOR.

NO CLAIM IS MADE TO THE EXCLUSIVE RIGHT TO USE "ART", APART FROM THE MARK AS SHOWN.

FOR BOOKS IN THE FIELD OF ART AND POETRY; PAINTINGS (U.S. CLS. 2, 5, 22, 23, 29, 37, 38 AND 50).
ROBERT STRUCK, EXAMINING ATTORNEY

CLASS 16—(Continued).

SN 77-558,028. INFORMEDRX, INC., LISLE, IL. FILED 8-28-2008.

RXOUTLOOK

THE MARK CONSISTS OF STANDARD CHARACTERS WITHOUT CLAIM TO ANY PARTICULAR FONT, STYLE, SIZE, OR COLOR.

FOR NEWSLETTER DEALING WITH THE SUBJECT OF DRUGS AND PHARMACEUTICALS (U.S. CLS. 2, 5, 22, 23, 29, 37, 38 AND 50).

MICHAEL WIENER, EXAMINING ATTORNEY



SN 77-558,319. CYGNUS BUSINESS MEDIA, INC., FORT ATKINSON, WI. FILED 8-28-2008.

PAVEMENT MAINTENANCE & RECONSTRUCTION

THE MARK CONSISTS OF STANDARD CHARACTERS WITHOUT CLAIM TO ANY PARTICULAR FONT, STYLE, SIZE, OR COLOR.

SEC. 2(F).

FOR MAGAZINES FEATURING INFORMATION IN THE FIELDS OF PAVING, SEALCOATING, PAVEMENT MARKING, AND THE SWEEPING INDUSTRY (U.S. CLS. 2, 5, 22, 23, 29, 37, 38 AND 50).

FIRST USE 8-0-1996; IN COMMERCE 8-0-1996.

MARIA-VICTORIA SUAREZ, EXAMINING ATTORNEY

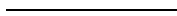

SN 77-558,452. DOWN TO EARTH DESIGNS, INC., PORTLAND, OR. FILED 8-28-2008.

G NAPPIES

THE MARK CONSISTS OF STANDARD CHARACTERS WITHOUT CLAIM TO ANY PARTICULAR FONT, STYLE, SIZE, OR COLOR.

OWNER OF U.S. REG. NOS. 3,072,077 AND 3,072,195.

NO CLAIM IS MADE TO THE EXCLUSIVE RIGHT TO USE "NAPPIES", APART FROM THE MARK AS SHOWN.

FOR FLUSHABLE DIAPERS CONSISTING OF A REUSABLE OUTER PANT, A DETACHABLE INNER POUCH, AND A FLUSHABLE PAD (U.S. CLS. 2, 5, 22, 23, 29, 37, 38 AND 50).

JEFFREY LOOK, EXAMINING ATTORNEY

CLASS 16—(Continued).

SN 77-559,088. DOG TBH CORPORATION, LOS ANGELES, CA. FILED 8-29-2008.

RETRIBUTION

THE MARK CONSISTS OF STANDARD CHARACTERS WITHOUT CLAIM TO ANY PARTICULAR FONT, STYLE, SIZE, OR COLOR.

FOR POSTERS, CALENDARS, NOTEBOOKS, A SERIES OF FICTION BOOKS AND NON-FICTION BOOKS IN THE FIELDS OF AUTOBIOGRAPHY, LIFE GUIDANCE, AND BOUNTY HUNTING, BINDERS, DAILY PLANNERS, PERSONAL ORGANIZERS, MEMOPADS, PENS, PENCILS, STICKERS, ERASERS, COMIC BOOKS, PENCIL CASES, WRITING PAPER, ENVELOPES, GREETING CARDS, PAPER WEIGHTS, PAPER COASTERS, PAPER MATS, MOUNTED AND UNMOUNTED PHOTOGRAPHS, POSTCARDS, TRADING CARDS, PRE-PAID NON-MAGNETIC PHONE DEBIT CARDS, PERSONAL BANK CHECKS; RUBBER STAMPS; IRON-ON TRANSFERS (U.S. CLS. 2, 5, 22, 23, 29, 37, 38 AND 50).

JERI J. FICKES, EXAMINING ATTORNEY



SN 77-559,576. CHAMBERS, LINDA E, DBA ELECTRIC MOMENTS, WILLOWBROOK, IL. FILED 8-30-2008.

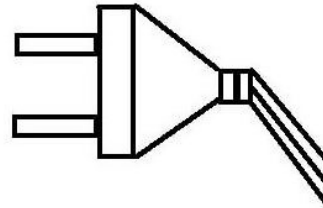

electric moments

THE MARK CONSISTS OF ELECTRICAL PLUG WITH SECTION OF CORD INCLUDES COMPANY NAME.

FOR CARDS BEARING UNIVERSAL GREETINGS (U.S. CLS. 2, 5, 22, 23, 29, 37, 38 AND 50).

WILLIAM P. SHANAHAN, EXAMINING ATTORNEY

CLASS 16—(Continued).

SN 77-559,649. NOLAN, DONALD J., JACKSONVILLE, FL. FILED 8-31-2008.

Golf Life

THE MARK CONSISTS OF STANDARD CHARACTERS WITHOUT CLAIM TO ANY PARTICULAR FONT, STYLE, SIZE, OR COLOR.

FOR WINDOW STICKERS IN THE NATURE OF DECALS (U.S. CLS. 2, 5, 22, 23, 29, 37, 38 AND 50).

FIRST USE 8-25-2008; IN COMMERCE 8-25-2008.
ESTHER BELENKER, EXAMINING ATTORNEY

SN 77-560,035. WOLFE, AMY L., CUMMING, GA. FILED 9-2-2008.

CinchEZ

THE MARK CONSISTS OF STANDARD CHARACTERS WITHOUT CLAIM TO ANY PARTICULAR FONT, STYLE, SIZE, OR COLOR.

FOR ADHESIVE BANDS FOR STATIONERY OR HOUSEHOLD PURPOSES; ADHESIVE TAPE DISPENSERS FOR HOUSEHOLD OR STATIONERY USE; ADHESIVE TAPES FOR STATIONERY OR HOUSEHOLD PURPOSES; GUMMED TAPE FOR STATIONERY OR HOUSEHOLD USE; HOLDERS FOR ADHESIVE TAPES; HOLDERS FOR SUCH STICKY TAPES (U.S. CLS. 2, 5, 22, 23, 29, 37, 38 AND 50).

LAKEISHA LEWIS, EXAMINING ATTORNEY

SN 77-560,154. THE APOSTOLATE, INC., TROY, VA. FILED 9-2-2008.

Holy Postage

THE MARK CONSISTS OF STANDARD CHARACTERS WITHOUT CLAIM TO ANY PARTICULAR FONT, STYLE, SIZE, OR COLOR.

NO CLAIM IS MADE TO THE EXCLUSIVE RIGHT TO USE "POSTAGE", APART FROM THE MARK AS SHOWN. FOR COMMEMORATIVE STAMP SHEETS (U.S. CLS. 2, 5, 22, 23, 29, 37, 38 AND 50).

FIRST USE 8-11-2008; IN COMMERCE 8-11-2008.
DAWN FELDMAN, EXAMINING ATTORNEY

CLASS 16—(Continued).

SN 77-560,462. NATIONAL OCEANIC AND ATMOSPHERIC ADMINISTRATION, WASHINGTON, DC. FILED 9-2-2008.



OWNER OF U.S. REG. NOS. 3,236,080 AND 3,478,025.

NO CLAIM IS MADE TO THE EXCLUSIVE RIGHT TO USE "INTEGRATED OCEAN OBSERVING SYSTEM", APART FROM THE MARK AS SHOWN.

THE COLOR(S) BLACK AND BLUE IS/ARE CLAIMED AS A FEATURE OF THE MARK.

THE MARK CONSISTS OF THE ACRONYM "IOOS". EACH LETTER OF THE ACRONYM IS DIVIDED IN HALF. FOR THE LETTERS "I" AND "S", THE LEFT-SIDE IS IN BLACK WHILE THE RIGHT SIDE IS IN BLUE. FOR THE LETTERS "O", BOTH SIDES CONSIST OF SHADES OF BLUE AND BLACK. THE TWO "O" LETTERS IN THE ACRONYM CONSIST OF GLOBE IMAGES WITH THE CONTINENTS BEING BLACK AND THE OCEAN BEING BLUE. AT THE BOTTOM IS THE PHRASE "INTEGRATED OCEAN OBSERVING SYSTEM" ALL IN BLUE EXCEPT THAT THE FIRST LETTER OF EACH OF THOSE WORDS IS IN BLACK.

FOR PUBLICATIONS, NAMELY, BROCHURES, BOOKLETS, AND TEACHING MATERIALS IN THE FIELD OF OPEN OCEANS, COASTAL WATERS, AND GREAT LAKES (U.S. CLS. 2, 5, 22, 23, 29, 37, 38 AND 50).

FIRST USE 5-0-2008; IN COMMERCE 5-0-2008.
SIMON TENG, EXAMINING ATTORNEY

SN 77-560,797. IVAN, ROBERT, MATAWAN, NJ. FILED 9-2-2008.

My Post

THE MARK CONSISTS OF STANDARD CHARACTERS WITHOUT CLAIM TO ANY PARTICULAR FONT, STYLE, SIZE, OR COLOR.

FOR NEWSPAPERS (U.S. CLS. 2, 5, 22, 23, 29, 37, 38 AND 50).

KIM SAITO, EXAMINING ATTORNEY

SN 77-561,653. MARYAM RAHMANI, SCOTTSDALE, AZ. FILED 9-3-2008.

RAINBOW RIDE

THE MARK CONSISTS OF STANDARD CHARACTERS WITHOUT CLAIM TO ANY PARTICULAR FONT, STYLE, SIZE, OR COLOR.

FOR CHILDREN'S BOOKS (U.S. CLS. 2, 5, 22, 23, 29, 37, 38 AND 50).

EDWARD NELSON, EXAMINING ATTORNEY

CLASS 16—(Continued).

SN 77-561,734. COLETTE BARON-REID, SEDONA, AZ. FILED 9-3-2008.

IN-VIZION

THE MARK CONSISTS OF STANDARD CHARACTERS WITHOUT CLAIM TO ANY PARTICULAR FONT, STYLE, SIZE, OR COLOR.

FOR PRINTED INSTRUCTIONAL, EDUCATIONAL, AND TEACHING MATERIALS IN THE FIELD OF MIND-BODY-SPIRIT TRAINING (U.S. CLS. 2, 5, 22, 23, 29, 37, 38 AND 50).

FIRST USE 7-17-2008; IN COMMERCE 7-17-2008.
HEATHER THOMPSON, EXAMINING ATTORNEY

CLASS 16—(Continued).

SN 77-562,719. MANUEL D. MILLS, MIDLAND, TX. FILED 9-4-2008.

AJUSTOBOOK

THE MARK CONSISTS OF STANDARD CHARACTERS WITHOUT CLAIM TO ANY PARTICULAR FONT, STYLE, SIZE, OR COLOR.

FOR BOOK HOLDER (U.S. CLS. 2, 5, 22, 23, 29, 37, 38 AND 50).

PAUL CROWLEY, EXAMINING ATTORNEY

SN 77-562,857. SIP ACADEMY USA, LLC, SALT LAKE CITY, UT. FILED 9-4-2008.

SIP ACADEMY

THE MARK CONSISTS OF STANDARD CHARACTERS WITHOUT CLAIM TO ANY PARTICULAR FONT, STYLE, SIZE, OR COLOR.

NO CLAIM IS MADE TO THE EXCLUSIVE RIGHT TO USE "ACADEMY", APART FROM THE MARK AS SHOWN.

FOR EDUCATIONAL BOOKS AND PRINTED MATERIAL FEATURING ABACUS INSTRUCTION, ART, LINGUISTICS AND PHONETICS, AND THE FIVE SENSES, ALL DESIGNED TO DEVELOP LEFT AND RIGHT BRAIN FUNCTIONALITY AND LIFE SKILLS (U.S. CLS. 2, 5, 22, 23, 29, 37, 38 AND 50).

DAVID TOOLEY, EXAMINING ATTORNEY

SN 77-562,987. NORCOM, INC., GRIFFIN, GA. FILED 9-5-2008.

SN 77-562,317. CHASE CORPORATION, BRIDGEWATER, MA. FILED 9-4-2008.

PAPER TYGER GREEN

THE MARK CONSISTS OF STANDARD CHARACTERS WITHOUT CLAIM TO ANY PARTICULAR FONT, STYLE, SIZE, OR COLOR.

OWNER OF U.S. REG. NO. 2,393,050.
NO CLAIM IS MADE TO THE EXCLUSIVE RIGHT TO USE "PAPER", APART FROM THE MARK AS SHOWN.

FOR PAPER HAVING ELECTROMAGNETIC SHIELDING CAPABILITY (U.S. CLS. 2, 5, 22, 23, 29, 37, 38 AND 50).

ANDREA SAUNDERS, EXAMINING ATTORNEY

SN 77-562,481. ATTACHED INC., BROOKLYN, NY. FILED 9-4-2008.

TRANSDOODLE

THE MARK CONSISTS OF STANDARD CHARACTERS WITHOUT CLAIM TO ANY PARTICULAR FONT, STYLE, SIZE, OR COLOR.

FOR TRANSFER PAPER SHEETS FOR TRACING A DESIGN ONTO FABRIC AND OTHER SURFACES (U.S. CLS. 2, 5, 22, 23, 29, 37, 38 AND 50).

FIRST USE 8-31-2007; IN COMMERCE 8-31-2007.
WILLIAM VERHOSEK, EXAMINING ATTORNEY



OWNER OF U.S. REG. NO. 1,619,853.

THE MARK CONSISTS OF THE WORDS "GO GREEN" IN-BETWEEN TWO CONCENTRIC CIRCLE DESIGNS AND WITH THE WORD "BASIC" (STYLIZED) IN A RECTANGLE DESIGN THAT IS CENTERED OVER THE CONCENTRIC CIRCLE DESIGNS.

FOR SCHOOL SUPPLIES AND WRITING SUPPLIES, NAMELY, NOTEBOOKS, WRITING PADS AND FILLER PAPER (U.S. CLS. 2, 5, 22, 23, 29, 37, 38 AND 50).

CARRIE GENOVESE, EXAMINING ATTORNEY

CLASS 16—(Continued).

SN 77-563,060. TAJ BOOKS INTERNATIONAL LLP, SURREY, UNITED KINGDOM, FILED 9-5-2008.

PAST AND PRESENT

THE MARK CONSISTS OF STANDARD CHARACTERS WITHOUT CLAIM TO ANY PARTICULAR FONT, STYLE, SIZE, OR COLOR.

FOR NON-FICTION BOOKS, GUIDE BOOKS, MANUALS AND CATALOGUES ON TRAVEL AND ARCHITECTURE (U.S. CLS. 2, 5, 22, 23, 29, 37, 38 AND 50).

ANDREA SAUNDERS, EXAMINING ATTORNEY

SN 77-563,159. TAVERAS, RUBEN, BROOKLYN, NY. FILED 9-5-2008.

G.O.O.N.

THE MARK CONSISTS OF STANDARD CHARACTERS WITHOUT CLAIM TO ANY PARTICULAR FONT, STYLE, SIZE, OR COLOR.

FOR T-SHIRTS, HATS, CLOTHING (U.S. CLS. 2, 5, 22, 23, 29, 37, 38 AND 50).

JEFF DEFORD, EXAMINING ATTORNEY

SN 77-563,294. LUTHERANS FOR LIFE, INC., NEVADA, IA. FILED 9-5-2008.

Teaching for Life

THE MARK CONSISTS OF STANDARD CHARACTERS WITHOUT CLAIM TO ANY PARTICULAR FONT, STYLE, SIZE, OR COLOR.

FOR PRINTED MATERIALS, NAMELY, CURRICULA IN THE FIELD OF PRO-LIFE MINISTRY (U.S. CLS. 2, 5, 22, 23, 29, 37, 38 AND 50).

FIRST USE 9-15-2006; IN COMMERCE 9-15-2006.
JENNIFER MARTIN, EXAMINING ATTORNEY

CLASS 16—(Continued).

SN 77-563,586. SUNRISE PUBLICATIONS, INC., DBA SUNRISE GREETINGS, BLOOMINGTON, IN. FILED 9-5-2008.

LOST & FOUND

THE MARK CONSISTS OF STANDARD CHARACTERS WITHOUT CLAIM TO ANY PARTICULAR FONT, STYLE, SIZE, OR COLOR.

FOR GREETING CARDS (U.S. CLS. 2, 5, 22, 23, 29, 37, 38 AND 50).

MICHAEL SOUDERS, EXAMINING ATTORNEY

SN 77-564,010. HATCH, CYNTHIA A., DBA KAIROS PUBLISHING, EAGAN, MN. FILED 9-6-2008.

KAIROS

THE MARK CONSISTS OF STANDARD CHARACTERS WITHOUT CLAIM TO ANY PARTICULAR FONT, STYLE, SIZE, OR COLOR.

THE ENGLISH TRANSLATION OF "KAIROS" IN THE MARK IS RIGHT OR OPPORTUNE MOMENT.

FOR BOOKLETS IN THE FIELD OF GRIEF AND LOSS; BOOKS IN THE FIELD OF BEREAVEMENT, RECOVERY FROM ADDICTION, RECOVERY FROM LOSS, RECOVERY FROM GRIEF AND DEVOTIONS; BROCHURES ABOUT BEREAVEMENT, RECOVERY FROM LOSS, GRIEF, VISITATION AND DEVOTIONS; PAMPHLETS IN THE FIELD OF BEREAVEMENT, RECOVERY FROM LOSS, GRIEF, VISITATION AND DEVOTIONS (U.S. CLS. 2, 5, 22, 23, 29, 37, 38 AND 50).

FIRST USE 10-10-1963; IN COMMERCE 10-10-1963.
ROBIN MITTLER, EXAMINING ATTORNEY

SN 77-564,229. VOLUNTEER USA FOUNDATION, INC., TALLAHASSEE, FL. FILED 9-8-2008.

LOVE. READ. LEARN!

THE MARK CONSISTS OF STANDARD CHARACTERS WITHOUT CLAIM TO ANY PARTICULAR FONT, STYLE, SIZE, OR COLOR.

FOR PRINTED INSTRUCTIONAL, EDUCATIONAL AND TEACHING MATERIALS IN THE FIELD OF EDUCATING CHILDREN TO READ (U.S. CLS. 2, 5, 22, 23, 29, 37, 38 AND 50).

FIRST USE 9-2-2008; IN COMMERCE 9-2-2008.

KATHLEEN LORENZO, EXAMINING ATTORNEY

CLASS 16—(Continued).

SN 77-564,374. SIP ACADEMY USA, LLC, SALT LAKE CITY, UT. FILED 9-8-2008.

SIP

THE MARK CONSISTS OF STANDARD CHARACTERS WITHOUT CLAIM TO ANY PARTICULAR FONT, STYLE, SIZE, OR COLOR.

FOR EDUCATIONAL BOOKS AND PRINTED MATERIAL FEATURING ABACUS INSTRUCTION, ART, LINGUISTICS AND PHONETICS, AND THE FIVE SENSES, ALL DESIGNED TO DEVELOP LEFT AND RIGHT BRAIN FUNCTIONALITY AND LIFE SKILLS (U.S. CLS. 2, 5, 22, 23, 29, 37, 38 AND 50).

DAVID TOOLEY, EXAMINING ATTORNEY

CLASS 16—(Continued).

SN 77-565,150. BAKER, RICK, IREDELL, TX. AND BAKER, DONNA, IREDELL, TX. FILED 9-8-2008.

Peace of the Sky

THE MARK CONSISTS OF STANDARD CHARACTERS WITHOUT CLAIM TO ANY PARTICULAR FONT, STYLE, SIZE, OR COLOR.

FOR PHOTOGRAPHS (U.S. CLS. 2, 5, 22, 23, 29, 37, 38 AND 50).

IRA J. GOODSAY, EXAMINING ATTORNEY

SN 77-564,687. CORCORAN, TODD M., BOULDER, CO. FILED 9-8-2008.

THE FIVE CHORDS TO FREEDOM

THE MARK CONSISTS OF STANDARD CHARACTERS WITHOUT CLAIM TO ANY PARTICULAR FONT, STYLE, SIZE, OR COLOR.

FOR SERIES OF BOOKS AND INSTRUCTION MANUALS RELATING TO PLAYING THE GUITAR (U.S. CLS. 2, 5, 22, 23, 29, 37, 38 AND 50).

KEVIN DINALLO, EXAMINING ATTORNEY

SN 77-565,375. PRACTICING SAFE TECHS, DENVER, CO. FILED 9-9-2008.

Practicing Safe Techs

THE MARK CONSISTS OF STANDARD CHARACTERS WITHOUT CLAIM TO ANY PARTICULAR FONT, STYLE, SIZE, OR COLOR.

FOR COMIC STRIPS APPEARING IN INTERNET WEB PAGES, NEWSPAPERS, AND MAGAZINES (U.S. CLS. 2, 5, 22, 23, 29, 37, 38 AND 50).

JOHN WILKE, EXAMINING ATTORNEY

SN 77-564,982. FINCH PAPER LLC, GLENS FALLS, NY. FILED 9-8-2008.



THE MARK CONSISTS OF A STYLIZED LETTER "F". FOR PRINTING, DUPLICATING AND COPIER PAPERS; OPAQUE OFFSET PAPER; UNCOATED BOOK AND FINE PAPER; TEXT AND COVER PAPER; DIGITAL PAPER; BOND, OFFSET AND CONVERTING PAPER (U.S. CLS. 2, 5, 22, 23, 29, 37, 38 AND 50).

FIRST USE 5-12-2008; IN COMMERCE 5-30-2008. ALLISON HOLTZ, EXAMINING ATTORNEY

SN 77-565,460. SPARKNOTES LLC, NEW YORK, NY. FILED 9-9-2008.

SPARKNOTES 101

THE MARK CONSISTS OF STANDARD CHARACTERS WITHOUT CLAIM TO ANY PARTICULAR FONT, STYLE, SIZE, OR COLOR.

OWNER OF U.S. REG. NOS. 2,490,292, 3,380,421 AND OTHERS.

FOR PUBLICATIONS, NAMELY, BOOKS AND STUDY GUIDES ON A VARIETY OF COLLEGE-LEVEL SUBJECTS, NAMELY, MATHEMATICS, ALGEBRA, SCIENCE, BIOLOGY, HISTORY, POLITICAL SCIENCE, PSYCHOLOGY, PHILOSOPHY, LITERATURE, ENGLISH, FOREIGN LANGUAGES, SOCIOLOGY AND TEST PREP (U.S. CLS. 2, 5, 22, 23, 29, 37, 38 AND 50).

FIRST USE 1-31-2004; IN COMMERCE 1-31-2004. SARA THOMAS, EXAMINING ATTORNEY

CLASS 16—(Continued).

SN 77-565,570. SMITH, ANTONIO, LITHONIA, GA. FILED 9-9-2008.

THE SELLIONAIRE

THE MARK CONSISTS OF STANDARD CHARACTERS WITHOUT CLAIM TO ANY PARTICULAR FONT, STYLE, SIZE, OR COLOR.

FOR SERIES OF NON-FICTION BOOKS IN THE FIELD OF SELFHELP, FINANCIAL, AND BUSINESS (U.S. CLS. 2, 5, 22, 23, 29, 37, 38 AND 50).

CORY BOONE, EXAMINING ATTORNEY

SN 77-565,826. LITERACY PARTNERS, NEW YORK, NY. FILED 9-9-2008.

EVERYONE DESERVES A CHANCE
TO READ.

THE MARK CONSISTS OF STANDARD CHARACTERS WITHOUT CLAIM TO ANY PARTICULAR FONT, STYLE, SIZE, OR COLOR.

FOR PUBLICATIONS, NAMELY, NEWSLETTERS, PAMPHLETS, BROCHURES, WORKBOOKS AND PRINTED TEACHING MATERIALS IN THE FIELD OF LITERACY, ADULT EDUCATION, READING, WRITING, MATH, SOCIAL STUDIES, SCIENCE, FINANCIAL AND HEALTH LITERACY, EMPLOYMENT PREPARATION, GED EXAM PREPARATION, ENGLISH FOR SPEAKERS OF OTHER LANGUAGES, AND FAMILY LITERACY; BOOKS AND PERIODICALS IN THE FIELD OF LITERACY, ADULT EDUCATION, READING, WRITING, MATH, SOCIAL STUDIES, SCIENCE, FINANCIAL AND HEALTH LITERACY, EMPLOYMENT PREPARATION, GED EXAM PREPARATION, ENGLISH FOR SPEAKERS OF OTHER LANGUAGES, AND FAMILY LITERACY (U.S. CLS. 2, 5, 22, 23, 29, 37, 38 AND 50).

CHERYL CLAYTON, EXAMINING ATTORNEY

SN 77-565,892. IMAGE ARTS, INC., MARSHFIELD, MA. FILED 9-9-2008.

WINTER BAY STUDIOS

THE MARK CONSISTS OF STANDARD CHARACTERS WITHOUT CLAIM TO ANY PARTICULAR FONT, STYLE, SIZE, OR COLOR.

NO CLAIM IS MADE TO THE EXCLUSIVE RIGHT TO USE "STUDIOS", APART FROM THE MARK AS SHOWN.

FOR GREETING CARDS (U.S. CLS. 2, 5, 22, 23, 29, 37, 38 AND 50).

FIRST USE 8-31-2007; IN COMMERCE 8-31-2007.
JAMES A. RAUEN, EXAMINING ATTORNEY

CLASS 16—(Continued).

SN 77-565,927. CAMBRIA COVE LLC, TOPKEA, KS. FILED 9-9-2008.

CAMBRIA COVE

THE MARK CONSISTS OF STANDARD CHARACTERS WITHOUT CLAIM TO ANY PARTICULAR FONT, STYLE, SIZE, OR COLOR.

FOR GREETING CARDS; BOXED CARD AND ENVELOPE SETS; NOTE CARDS; PERSONAL STATIONERY; INVITATION CARDS; NOTEBOOKS; NOTEPADS; SCRAPBOOKS; SCRAPBOOK MATERIALS, NAMELY, PAPER, STICKERS, PUNCHES, STENCILS, ADHESIVES; GIFT WRAPPING PAPERS; PAPER GIFT BAGS; PAPER OR CARDBOARD GIFT BOXES; RIBBONS AND BOWS MADE OF PAPER; PAPER NAPKINS; PAPER COASTERS; PAPER GUEST TOWELS; WRITING INSTRUMENTS; STAMP PADS; DESK ORGANIZER SETS; FILE FOLDERS; BLANK JOURNALS; DAY PLANNERS; PHOTO ALBUMS; MEMORY KEEPING ALBUMS; RUBBER STAMPS; SEALING WAX KITS COMPRISED OF SEALING WAX AND SEAL DESIGNS; FILE BOXES FOR STORAGE OF BUSINESS OR PERSONAL RECORDS; CALLING CARDS FOR IDENTIFICATION AT SOCIAL FUNCTIONS (U.S. CLS. 2, 5, 22, 23, 29, 37, 38 AND 50).

ANGELA M. MICHELI, EXAMINING ATTORNEY

SN 77-566,031. UNITED STATES ANTI-DOPING AGENCY, AKA USADA, COLORADO SPRINGS, CO. FILED 9-9-2008.



My Victory.
I compete clean.

OWNER OF U.S. REG. NOS. 3,220,102 AND 3,239,326.

THE MARK CONSISTS OF THE WORDS "MY VICTORY. I COMPETE CLEAN." IN STYLIZED LETTERS WITH THE "V" IN "VICTORY" EMPHASIZED IN A LARGER FONT AND A HORIZONTAL SLASH BENEATH THE STYLIZED MARK.

FOR NEWSLETTERS, POSTERS, POST CARDS, AND PRINTED EDUCATIONAL MATERIAL IN THE FIELD OF ANTI-DOPING (U.S. CLS. 2, 5, 22, 23, 29, 37, 38 AND 50).

FIRST USE 4-24-2008; IN COMMERCE 4-24-2008.
JILL C. ALT, EXAMINING ATTORNEY

CLASS 16—(Continued).

SN 77-566,200. LQI, LLC, DBA NAVIMAZE, LEES SUMMIT, MO. FILED 9-10-2008.

NAVIMAZE

THE MARK CONSISTS OF STANDARD CHARACTERS WITHOUT CLAIM TO ANY PARTICULAR FONT, STYLE, SIZE, OR COLOR.

FOR APPOINTMENT BOOKS; BLANK JOURNALS; CALENDARS AND DIARIES; JOURNALS CONCERNING THE TREATMENT OF CANCER PATIENTS AND FOR PATIENT RECORDATION OF MEDICAL INFORMATION AND TREATMENT PROGRESS; MEMORY BOOKS; PERSONALIZED WRITING JOURNALS (U.S. CLS. 2, 5, 22, 23, 29, 37, 38 AND 50).

ALICIA COLLINS, EXAMINING ATTORNEY

SN 77-566,217. FORESIGHT INSTITUTE INC., SEDONA, AZ. FILED 9-10-2008.

FORESIGHT EDUCATION

THE MARK CONSISTS OF STANDARD CHARACTERS WITHOUT CLAIM TO ANY PARTICULAR FONT, STYLE, SIZE, OR COLOR.

NO CLAIM IS MADE TO THE EXCLUSIVE RIGHT TO USE "EDUCATION", APART FROM THE MARK AS SHOWN.

FOR PRINTED MATERIALS, NAMELY, CURRICULA IN THE FIELD OF EDUCATION AND CREATING CHANGE IN SOCIETY (U.S. CLS. 2, 5, 22, 23, 29, 37, 38 AND 50).

FIRST USE 0-0-2007; IN COMMERCE 0-0-2007.
ANGELA M. MICHELI, EXAMINING ATTORNEY

CLASS 16—(Continued).

SN 77-566,340. LITERACY PARTNERS, NEW YORK, NY. FILED 9-10-2008.



THE MARK CONSISTS OF THE IMAGE OF SIX HANDS REACHING UPWARD TOWARD AN OPEN BOOK.

FOR PUBLICATIONS, NAMELY, NEWSLETTERS, PAMPHLETS, BROCHURES, WORKBOOKS AND PRINTED TEACHING MATERIALS IN THE FIELD OF LITERACY, ADULT EDUCATION, READING, WRITING, MATH, SOCIAL STUDIES, SCIENCE, FINANCIAL AND HEALTH LITERACY, EMPLOYMENT PREPARATION, GED EXAM PREPARATION, ENGLISH FOR SPEAKERS OF OTHER LANGUAGES, AND FAMILY LITERACY; BOOKS AND PERIODICALS IN THE FIELD OF LITERACY, ADULT EDUCATION, READING, WRITING, MATH, SOCIAL STUDIES, SCIENCE, FINANCIAL AND HEALTH LITERACY, EMPLOYMENT PREPARATION, GED EXAM PREPARATION, ENGLISH FOR SPEAKERS OF OTHER LANGUAGES, AND FAMILY LITERACY (U.S. CLS. 2, 5, 22, 23, 29, 37, 38 AND 50).

CHERYL CLAYTON, EXAMINING ATTORNEY

SN 77-566,476. STICKYFAN.COM, LLC, PORTLAND, OR. FILED 9-10-2008.



THE STIPPLING IS FOR SHADING PURPOSES ONLY. THE MARK CONSISTS OF THE STYLIZED WORDS "STICKYFAN.COM". ABOVE THE STYLIZED WORDS IS AN IMAGE OF A FROG WITH A LONG TONGUE THAT PEELS BACK THE LETTERS OF "STICKYFAN.COM".

FOR REMOVABLE, RE-USABLE, SELF-ADHESIVE, VINYL, LIFE-SIZED WALL DECALS FEATURING GRAPHICS OF INDIVIDUAL IMAGES (U.S. CLS. 2, 5, 22, 23, 29, 37, 38 AND 50).

FIRST USE 9-1-2007; IN COMMERCE 3-31-2008.
JESSICA A. POWERS, EXAMINING ATTORNEY

CLASS 16—(Continued).

SN 77-566,672. MARVEL CHARACTERS, INC., BEVERLY HILLS, CA. FILED 9-10-2008.

CARNAGE

THE MARK CONSISTS OF STANDARD CHARACTERS WITHOUT CLAIM TO ANY PARTICULAR FONT, STYLE, SIZE, OR COLOR.

FOR COMIC BOOKS; MAGAZINES FEATURING PRINTED STORIES IN ILLUSTRATED FORM AND COMIC BOOK STORIES AND ARTWORK; PRINTED PERIODICALS IN THE FIELD OF COMIC BOOK STORIES AND ARTWORK (U.S. CLS. 2, 5, 22, 23, 29, 37, 38 AND 50).

GIANCARLO CASTRO, EXAMINING ATTORNEY

CLASS 16—(Continued).

SN 77-566,688. MARVEL CHARACTERS, INC., BEVERLY HILLS, CA. FILED 9-10-2008.

DEATH'S HEAD

THE MARK CONSISTS OF STANDARD CHARACTERS WITHOUT CLAIM TO ANY PARTICULAR FONT, STYLE, SIZE, OR COLOR.

FOR COMIC BOOKS; MAGAZINES FEATURING PRINTED STORIES IN ILLUSTRATED FORM AND COMIC BOOK STORIES AND ARTWORK; PRINTED PERIODICALS IN THE FIELD OF COMIC BOOK STORIES AND ARTWORK (U.S. CLS. 2, 5, 22, 23, 29, 37, 38 AND 50).

GIANCARLO CASTRO, EXAMINING ATTORNEY

SN 77-566,680. MARVEL CHARACTERS, INC., BEVERLY HILLS, CA. FILED 9-10-2008.

DARKHAWK

THE MARK CONSISTS OF STANDARD CHARACTERS WITHOUT CLAIM TO ANY PARTICULAR FONT, STYLE, SIZE, OR COLOR.

FOR COMIC BOOKS; MAGAZINES FEATURING PRINTED STORIES IN ILLUSTRATED FORM AND COMIC BOOK STORIES AND ARTWORK; PRINTED PERIODICALS IN THE FIELD OF COMIC BOOK STORIES AND ARTWORK (U.S. CLS. 2, 5, 22, 23, 29, 37, 38 AND 50).

GIANCARLO CASTRO, EXAMINING ATTORNEY

SN 77-566,689. MARVEL CHARACTERS, INC., BEVERLY HILLS, CA. FILED 9-10-2008.

FALCON

THE MARK CONSISTS OF STANDARD CHARACTERS WITHOUT CLAIM TO ANY PARTICULAR FONT, STYLE, SIZE, OR COLOR.

FOR COMIC BOOKS; MAGAZINES FEATURING PRINTED STORIES IN ILLUSTRATED FORM AND COMIC BOOK STORIES AND ARTWORK; PRINTED PERIODICALS IN THE FIELD OF COMIC BOOK STORIES AND ARTWORK (U.S. CLS. 2, 5, 22, 23, 29, 37, 38 AND 50).

GIANCARLO CASTRO, EXAMINING ATTORNEY

SN 77-566,684. MARVEL CHARACTERS, INC., BEVERLY HILLS, CA. FILED 9-10-2008.

DAZZLER

THE MARK CONSISTS OF STANDARD CHARACTERS WITHOUT CLAIM TO ANY PARTICULAR FONT, STYLE, SIZE, OR COLOR.

FOR COMIC BOOKS; MAGAZINES FEATURING PRINTED STORIES IN ILLUSTRATED FORM AND COMIC BOOK STORIES AND ARTWORK; PRINTED PERIODICALS IN THE FIELD OF COMIC BOOK STORIES AND ARTWORK (U.S. CLS. 2, 5, 22, 23, 29, 37, 38 AND 50).

GIANCARLO CASTRO, EXAMINING ATTORNEY

SN 77-566,692. MARVEL CHARACTERS, INC., BEVERLY HILLS, CA. FILED 9-10-2008.

GIANT MAN

THE MARK CONSISTS OF STANDARD CHARACTERS WITHOUT CLAIM TO ANY PARTICULAR FONT, STYLE, SIZE, OR COLOR.

FOR COMIC BOOKS; MAGAZINES FEATURING PRINTED STORIES IN ILLUSTRATED FORM AND COMIC BOOK STORIES AND ARTWORK; PRINTED PERIODICALS IN THE FIELD OF COMIC BOOK STORIES AND ARTWORK (U.S. CLS. 2, 5, 22, 23, 29, 37, 38 AND 50).

GIANCARLO CASTRO, EXAMINING ATTORNEY

CLASS 16—(Continued).

SN 77-566,694. MARVEL CHARACTERS, INC., BEVERLY HILLS, CA. FILED 9-10-2008.

KA-ZAR

THE MARK CONSISTS OF STANDARD CHARACTERS WITHOUT CLAIM TO ANY PARTICULAR FONT, STYLE, SIZE, OR COLOR.

FOR COMIC BOOKS; MAGAZINES FEATURING PRINTED STORIES IN ILLUSTRATED FORM AND COMIC BOOK STORIES AND ARTWORK; PRINTED PERIODICALS IN THE FIELD OF COMIC BOOK STORIES AND ARTWORK (U.S. CLS. 2, 5, 22, 23, 29, 37, 38 AND 50).

GIANCARLO CASTRO, EXAMINING ATTORNEY



SN 77-566,716. MARVEL CHARACTERS, INC., BEVERLY HILLS, CA. FILED 9-10-2008.

ULTIMATUM

THE MARK CONSISTS OF STANDARD CHARACTERS WITHOUT CLAIM TO ANY PARTICULAR FONT, STYLE, SIZE, OR COLOR.

FOR COMIC BOOKS; MAGAZINES FEATURING PRINTED STORIES IN ILLUSTRATED FORM AND COMIC BOOK STORIES AND ARTWORK; PRINTED PERIODICALS IN THE FIELD OF COMIC BOOK STORIES AND ARTWORK (U.S. CLS. 2, 5, 22, 23, 29, 37, 38 AND 50).

GIANCARLO CASTRO, EXAMINING ATTORNEY



SN 77-566,718. MARVEL CHARACTERS, INC., BEVERLY HILLS, CA. FILED 9-10-2008.

GUNRUNNER

THE MARK CONSISTS OF STANDARD CHARACTERS WITHOUT CLAIM TO ANY PARTICULAR FONT, STYLE, SIZE, OR COLOR.

FOR COMIC BOOKS; MAGAZINES FEATURING PRINTED STORIES IN ILLUSTRATED FORM AND COMIC BOOK STORIES AND ARTWORK; PRINTED PERIODICALS IN THE FIELD OF COMIC BOOK STORIES AND ARTWORK (U.S. CLS. 2, 5, 22, 23, 29, 37, 38 AND 50).

GIANCARLO CASTRO, EXAMINING ATTORNEY

CLASS 16—(Continued).

SN 77-566,777. KUNICH, KENNETH, SOMERVILLE, NJ. FILED 9-10-2008.

Trip Hard!

THE MARK CONSISTS OF STANDARD CHARACTERS WITHOUT CLAIM TO ANY PARTICULAR FONT, STYLE, SIZE, OR COLOR.

FOR MAGAZINES FEATURING TRAVEL; TRAVEL BOOKS (U.S. CLS. 2, 5, 22, 23, 29, 37, 38 AND 50).

LAURIE KAUFMAN, EXAMINING ATTORNEY



SN 77-566,877. DAVID M. MOTTO, OAKLAND, CA. FILED 9-10-2008.

MOLTO MUSIC

THE MARK CONSISTS OF STANDARD CHARACTERS WITHOUT CLAIM TO ANY PARTICULAR FONT, STYLE, SIZE, OR COLOR.

NO CLAIM IS MADE TO THE EXCLUSIVE RIGHT TO USE "MUSIC", APART FROM THE MARK AS SHOWN.

THE FOREIGN WORDING IN THE MARK TRANSLATES INTO ENGLISH AS MUCH OR VERY.

FOR PRINTED INSTRUCTIONAL BOOKS IN THE FIELD OF MUSIC (U.S. CLS. 2, 5, 22, 23, 29, 37, 38 AND 50).

FIRST USE 9-1-1999; IN COMMERCE 1-4-2000.

LAURIE KAUFMAN, EXAMINING ATTORNEY



SN 77-566,942. MARTIN, JOHN T., DBA NORTH STAR TIME MANAGEMENT PRODUCTS, WEST CHESTERFIELD, NH. AND DREHER, SARAH C., SOUTH NEWFANE, VT. FILED 9-10-2008.

org-it

THE MARK CONSISTS OF STANDARD CHARACTERS WITHOUT CLAIM TO ANY PARTICULAR FONT, STYLE, SIZE, OR COLOR.

FOR CALENDAR REFILLS; CALENDAR-FINISHED PAPER; CALENDARS; CALENDARS AND DIARIES; PRINTED CALENDARS; WALL CALENDARS (U.S. CLS. 2, 5, 22, 23, 29, 37, 38 AND 50).

ALLISON SCHRODY, EXAMINING ATTORNEY

CLASS 16—(Continued).

SN 77-568,155. DARK HORSE COMICS, INC., MILWAUKIE, OR. FILED 9-11-2008.

CRIME DOES NOT PAY

THE MARK CONSISTS OF STANDARD CHARACTERS WITHOUT CLAIM TO ANY PARTICULAR FONT, STYLE, SIZE, OR COLOR.

FOR COMIC BOOKS (U.S. CLS. 2, 5, 22, 23, 29, 37, 38 AND 50).

SONYA STEPHENS, EXAMINING ATTORNEY

SN 77-570,499. THE READING FOUNDATION, DBA NATIONAL CHILDREN'S READING FOUNDATION, KENNEWICK, WA. FILED 9-15-2008.

Cradle to College

THE MARK CONSISTS OF STANDARD CHARACTERS WITHOUT CLAIM TO ANY PARTICULAR FONT, STYLE, SIZE, OR COLOR.

FOR PRINTED EDUCATIONAL PUBLICATIONS, NAMELY, BOOKS, BOOKLETS, MANUALS, PAMPHLETS, BROCHURES AND ARTICLES RELATING TO READING, READING PROFICIENCY, AND TECHNIQUES FOR TEACHING READING TO CHILDREN (U.S. CLS. 2, 5, 22, 23, 29, 37, 38 AND 50).

KIM SAITO, EXAMINING ATTORNEY

SN 77-570,584. SELF, REBECCA L., SARASOTA, FL. FILED 9-16-2008.

The Dating Pipeline

THE MARK CONSISTS OF STANDARD CHARACTERS WITHOUT CLAIM TO ANY PARTICULAR FONT, STYLE, SIZE, OR COLOR.

NO CLAIM IS MADE TO THE EXCLUSIVE RIGHT TO USE "DATING", APART FROM THE MARK AS SHOWN.

FOR A SERIES OF BOOKS AND WRITTEN ARTICLES IN THE FIELD OF DATING AND COMMUNICATION MANAGEMENT; A SERIES OF BOOKS, WRITTEN ARTICLES, HANDOUTS AND WORKSHEETS IN THE FIELD OF DATING AND COMMUNICATION MANAGEMENT (U.S. CLS. 2, 5, 22, 23, 29, 37, 38 AND 50).

TRACY CROSS, EXAMINING ATTORNEY

CLASS 16—(Continued).

SN 77-573,010. AMERICAN ACADEMY OF OPHTHALMOLOGY, INC., SAN FRANCISCO, CA. FILED 9-18-2008.

AMERICAN ACADEMY OF OPTHALMIC EXECUTIVES

THE MARK CONSISTS OF STANDARD CHARACTERS WITHOUT CLAIM TO ANY PARTICULAR FONT, STYLE, SIZE, OR COLOR.

OWNER OF U.S. REG. NOS. 2,780,893 AND 2,787,717. SEC. 2(F).

FOR PRINTED MATERIALS, NAMELY, PAMPHLETS, BULLETINS, BOOKS, BROCHURES, MANUALS, AND JOURNALS IN THE FIELDS OF EYE CARE, OPHTHALMOLOGY, AND MEDICAL PRACTICE MANAGEMENT (U.S. CLS. 2, 5, 22, 23, 29, 37, 38 AND 50).

FIRST USE 10-20-2002; IN COMMERCE 10-20-2002.

DAWN FELDMAN, EXAMINING ATTORNEY

SN 77-581,330. DOMTAR INC., MONTREAL, CANADA, FILED 9-29-2008.

Enterprise DocuFlo Plus

THE MARK CONSISTS OF STANDARD CHARACTERS WITHOUT CLAIM TO ANY PARTICULAR FONT, STYLE, SIZE, OR COLOR.

FOR PAPER (U.S. CLS. 2, 5, 22, 23, 29, 37, 38 AND 50).

ASMAT KHAN, EXAMINING ATTORNEY

SN 77-582,462. GOSPEL LIGHT PUBLICATIONS, INC., VENTURA, CA. FILED 9-30-2008.

BIBLE TUCK-IN

THE MARK CONSISTS OF STANDARD CHARACTERS WITHOUT CLAIM TO ANY PARTICULAR FONT, STYLE, SIZE, OR COLOR.

NO CLAIM IS MADE TO THE EXCLUSIVE RIGHT TO USE "BIBLE", APART FROM THE MARK AS SHOWN.

FOR PRINTED MATERIALS IN THE NATURE OF PRINTED INSTRUCTIONAL, EDUCATIONAL, AND TEACHING MATERIALS FEATURING RELIGIOUS, MORAL, OR ETHICAL TOPICS, OR RELATED INSTRUCTIONAL SUBJECT MATTER, SOLD AS AN INTEGRATED COMPONENT OF AN EDUCATIONAL AND INSTRUCTIONAL HANDBOOK (U.S. CLS. 2, 5, 22, 23, 29, 37, 38 AND 50).

FIRST USE 3-1-1988; IN COMMERCE 3-1-1988.

JORDAN BAKER, EXAMINING ATTORNEY

CLASS 16—(Continued).

SN 77-600,130. MARVEL CHARACTERS, INC., BEVERLY HILLS, CA. FILED 10-24-2008.

MORBIUS

THE MARK CONSISTS OF STANDARD CHARACTERS WITHOUT CLAIM TO ANY PARTICULAR FONT, STYLE, SIZE, OR COLOR.

FOR COMIC BOOKS; MAGAZINES FEATURING PRINTED STORIES IN ILLUSTRATED FORM AND COMIC BOOK STORIES AND ARTWORK; PRINTED PERIODICALS IN THE FIELD OF COMIC BOOK STORIES AND ARTWORK (U.S. CLS. 2, 5, 22, 23, 29, 37, 38 AND 50).

GIANCARLO CASTRO, EXAMINING ATTORNEY

CLASS 16—(Continued).

SN 77-600,142. MARVEL CHARACTERS, INC., BEVERLY HILLS, CA. FILED 10-24-2008.

SCARLET SPIDER

THE MARK CONSISTS OF STANDARD CHARACTERS WITHOUT CLAIM TO ANY PARTICULAR FONT, STYLE, SIZE, OR COLOR.

OWNER OF U.S. REG. NOS. 885,910, 2,276,140 AND OTHERS.

FOR COMIC BOOKS; MAGAZINES FEATURING PRINTED STORIES IN ILLUSTRATED FORM AND COMIC BOOK STORIES AND ARTWORK; PRINTED PERIODICALS IN THE FIELD OF COMIC BOOK STORIES AND ARTWORK (U.S. CLS. 2, 5, 22, 23, 29, 37, 38 AND 50).

GIANCARLO CASTRO, EXAMINING ATTORNEY

SN 77-600,136. MARVEL CHARACTERS, INC., BEVERLY HILLS, CA. FILED 10-24-2008.

NIGHT THRASHER

THE MARK CONSISTS OF STANDARD CHARACTERS WITHOUT CLAIM TO ANY PARTICULAR FONT, STYLE, SIZE, OR COLOR.

FOR COMIC BOOKS; MAGAZINES FEATURING PRINTED STORIES IN ILLUSTRATED FORM AND COMIC BOOK STORIES AND ARTWORK; PRINTED PERIODICALS IN THE FIELD OF COMIC BOOK STORIES AND ARTWORK (U.S. CLS. 2, 5, 22, 23, 29, 37, 38 AND 50).

GIANCARLO CASTRO, EXAMINING ATTORNEY

SN 77-600,146. MARVEL CHARACTERS, INC., BEVERLY HILLS, CA. FILED 10-24-2008.

SCARLET WITCH

THE MARK CONSISTS OF STANDARD CHARACTERS WITHOUT CLAIM TO ANY PARTICULAR FONT, STYLE, SIZE, OR COLOR.

FOR COMIC BOOKS; MAGAZINES FEATURING PRINTED STORIES IN ILLUSTRATED FORM AND COMIC BOOK STORIES AND ARTWORK; PRINTED PERIODICALS IN THE FIELD OF COMIC BOOK STORIES AND ARTWORK (U.S. CLS. 2, 5, 22, 23, 29, 37, 38 AND 50).

GIANCARLO CASTRO, EXAMINING ATTORNEY

SN 77-600,141. MARVEL CHARACTERS, INC., BEVERLY HILLS, CA. FILED 10-24-2008.

RAVAGE

THE MARK CONSISTS OF STANDARD CHARACTERS WITHOUT CLAIM TO ANY PARTICULAR FONT, STYLE, SIZE, OR COLOR.

FOR COMIC BOOKS; MAGAZINES FEATURING PRINTED STORIES IN ILLUSTRATED FORM AND COMIC BOOK STORIES AND ARTWORK; PRINTED PERIODICALS IN THE FIELD OF COMIC BOOK STORIES AND ARTWORK (U.S. CLS. 2, 5, 22, 23, 29, 37, 38 AND 50).

GIANCARLO CASTRO, EXAMINING ATTORNEY

SN 77-606,414. IBASIS, INC., BURLINGTON, MA. FILED 11-3-2008.

Yummy

THE MARK CONSISTS OF STANDARD CHARACTERS WITHOUT CLAIM TO ANY PARTICULAR FONT, STYLE, SIZE, OR COLOR.

FOR PRE-PAID TELEPHONE CALLING CARDS, NOT MAGNETICALLY ENCODED; TELEPHONE CALLING CARDS, NOT MAGNETICALLY ENCODED (U.S. CLS. 2, 5, 22, 23, 29, 37, 38 AND 50).

FIRST USE 11-25-2008; IN COMMERCE 11-25-2008.
INGRID C. EULIN, EXAMINING ATTORNEY

CLASS 16—(Continued).

SN 77-606,423. IBASIS, INC., BURLINGTON, MA. FILED 11-3-2008.

Show de Bola

THE MARK CONSISTS OF STANDARD CHARACTERS WITHOUT CLAIM TO ANY PARTICULAR FONT, STYLE, SIZE, OR COLOR.

FOR PRE-PAID TELEPHONE CALLING CARDS, NOT MAGNETICALLY ENCODED; TELEPHONE CALLING CARDS, NOT MAGNETICALLY ENCODED (U.S. CLS. 2, 5, 22, 23, 29, 37, 38 AND 50).

INGRID C. EULIN, EXAMINING ATTORNEY

SN 78-694,164. PRINCETON ART & BRUSH COMPANY, INC., PRINCETON, NJ. FILED 8-17-2005.

SUMMIT

THE MARK CONSISTS OF STANDARD CHARACTERS WITHOUT CLAIM TO ANY PARTICULAR FONT, STYLE, SIZE, OR COLOR.

FOR ARTISTS' BRUSHES (U.S. CLS. 2, 5, 22, 23, 29, 37, 38 AND 50).

KRISTINA MORRIS, EXAMINING ATTORNEY

SN 79-050,025. MONTBLANC-SIMPLO GMBH, FED REP GERMANY, FILED 1-14-2008.

ETOILE DE MONTBLANC

PRIORITY DATE OF 10-2-2007 IS CLAIMED.

OWNER OF INTERNATIONAL REGISTRATION 0953620 DATED 1-14-2008, EXPIRES 1-14-2018.

OWNER OF U.S. REG. NOS. 776,208, 2,620,401 AND OTHERS.

THE FOREIGN WORDING IN THE MARK TRANSLATES INTO ENGLISH AS STAR OF WHITE MOUNTAIN.

FOR WRITING UTENSILS, NAMELY, FOUNTAIN PENS, BALLPOINT PENS, PENCILS, FELT-TIPPED PENS, ROLLER BALL PENS, AND TEXT MARKERS; POUCHES FOR WRITING UTENSILS; GIFT CASES FOR WRITING UTENSILS; INKS AND CARTRIDGES, NAMELY, WRITING INKS, PEN INK REFILLS, AND PEN INK CARTRIDGES; STATIONERY, DIARIES, PAPERWEIGHTS, DESK SETS; HOLDERS FOR WRITING AND OFFICE UTENSILS, NAMELY, PEN HOLDERS, PENCIL HOLDERS, AND HOLDERS FOR DESK ACCESSORIES; AND STRUCTURAL PARTS FOR ALL AFORESAID GOODS INCLUDED IN THIS CLASS (U.S. CLS. 2, 5, 22, 23, 29, 37, 38 AND 50).

KATHERINE E. HALMEN, EXAMINING ATTORNEY

CLASS 16—(Continued).

SN 79-058,764. BUILD N WRAP LIMITED, UNITED KINGDOM, FILED 7-4-2008.

Build n Wrap

THE MARK CONSISTS OF STANDARD CHARACTERS WITHOUT CLAIM TO ANY PARTICULAR FONT, STYLE, SIZE, OR COLOR.

OWNER OF INTERNATIONAL REGISTRATION 0977006 DATED 7-4-2008, EXPIRES 7-4-2018.

NO CLAIM IS MADE TO THE EXCLUSIVE RIGHT TO USE "WRAP", APART FROM THE MARK AS SHOWN.

FOR PLASTIC MODULAR FRAMES FOR PACKAGING GIFTS (U.S. CLS. 2, 5, 22, 23, 29, 37, 38 AND 50).

FRED CARL, EXAMINING ATTORNEY

CLASS 17—RUBBER GOODS

SN 77-419,284. BIXLER'S MARINE INC, RINGWOOD, NJ. FILED 3-11-2008.



NO CLAIM IS MADE TO THE EXCLUSIVE RIGHT TO USE "MARINE INC", APART FROM THE MARK AS SHOWN.

THE MARK CONSISTS OF A STYLIZED PROPELLER ABOVE THE STYLIZED TEXT "BIXLER'S MARINE INC".

FOR SEALANTS FOR REPAIRING HOLES IN INFLATABLE BOATS AND SOFT CHOCKS SOLD AS A UNIT AND AFFIXED TO THE BOAT FOR RECREATIONAL BOATING AND MARINE USE (U.S. CLS. 1, 5, 12, 13, 35 AND 50).

REBECCA POVARCHUK, EXAMINING ATTORNEY

SN 77-445,787. CARPENTER CO., RICHMOND, VA. FILED 4-11-2008.

STYROGREEN

THE MARK CONSISTS OF STANDARD CHARACTERS WITHOUT CLAIM TO ANY PARTICULAR FONT, STYLE, SIZE, OR COLOR.

FOR EXPANDED POLYSTYRENE FOAM FOR USE IN THE BUILDING AND CONSTRUCTION INDUSTRIES DENOTING HIGH CONTENT NON-BIODEGRADABLE RECYCLED CONTENT USED AS ENERGY EFFICIENT INSULATION (U.S. CLS. 1, 5, 12, 13, 35 AND 50).

ALLISON SCHRODY, EXAMINING ATTORNEY

CLASS 17—(Continued).

SN 77-524,583. RECYCLINE, INC., WALTHAM, MA. FILED 7-17-2008.

PRESERVE

THE MARK CONSISTS OF STANDARD CHARACTERS WITHOUT CLAIM TO ANY PARTICULAR FONT, STYLE, SIZE, OR COLOR.

OWNER OF U.S. REG. NOS. 2,112,370, 2,957,316 AND 3,129,562.

FOR RECYCLED PLASTIC IN GRANULAR, FLAKE, OR PELLETIZED FORM FOR USE AS A RAW MATERIAL IN THE MANUFACTURE OF PLASTIC ITEMS (U.S. CLS. 1, 5, 12, 13, 35 AND 50).

FIRST USE 11-18-2005; IN COMMERCE 11-18-2005.
CHRISTINA SOBRAL, EXAMINING ATTORNEY

CLASS 17—(Continued).

SN 77-558,920. CHEMPLEX INDUSTRIES, INC., PALM CITY, FL. FILED 8-29-2008.

ETNOM

THE MARK CONSISTS OF STANDARD CHARACTERS WITHOUT CLAIM TO ANY PARTICULAR FONT, STYLE, SIZE, OR COLOR.

FOR THIN PLASTIC FILM FOR COVERING THE TOP OF SAMPLE CUPS FOR USE DURING SPECTROCHEMICAL ANALYSIS (U.S. CLS. 1, 5, 12, 13, 35 AND 50).

FIRST USE 1-1-2006; IN COMMERCE 1-1-2006.
WENDY GOODMAN, EXAMINING ATTORNEY

SN 77-525,781. CARPENTER CO., RICHMOND, VA. FILED 7-18-2008.

EASYLOFT

THE MARK CONSISTS OF STANDARD CHARACTERS WITHOUT CLAIM TO ANY PARTICULAR FONT, STYLE, SIZE, OR COLOR.

FOR POLYESTER FIBER BUILDING INSULATION (U.S. CLS. 1, 5, 12, 13, 35 AND 50).

ANDREA BUTLER, EXAMINING ATTORNEY

SN 77-564,723. S&B TECHNICAL PRODUCTS, INC., FORT WORTH, TX. FILED 9-8-2008.



SN 77-555,624. SCARECROW RACING PRODUCTS, INC., WEBBERVILLE, MI. FILED 8-26-2008.

BEARBOND

THE MARK CONSISTS OF STANDARD CHARACTERS WITHOUT CLAIM TO ANY PARTICULAR FONT, STYLE, SIZE, OR COLOR.

FOR ADHESIVE STRIPS FOR AUTOMOTIVE STRUCTURAL REPAIR (U.S. CLS. 1, 5, 12, 13, 35 AND 50).

FIRST USE 12-31-1999; IN COMMERCE 12-31-2000.
ANDREW LEASER, EXAMINING ATTORNEY

OWNER OF U.S. REG. NO. 3,436,699.
NO CLAIM IS MADE TO THE EXCLUSIVE RIGHT TO USE "RESTRAINT SYSTEM", APART FROM THE MARK AS SHOWN.

THE MARK CONSISTS OF THE WORDS "BULLDOG RESTRAINT SYSTEM" IN A CIRCLE. THE CIRCLE CONTAINS A DRAWING OF A BULLDOG WEARING A HARD-HAT, SHOES, PANTS AND A SPIKED COLLAR. THE BULLDOG IS HOLDING A PIPE.

FOR AN INTERNAL SEALING GASKET AND COMPANION RESTRAINT MECHANISM FOR COUPLING SECTIONS OF PIPE AND ESTABLISHING A CONTINUOUS FLOW LINE OF PIPE USED IN THE WATERWORKS INDUSTRY (U.S. CLS. 1, 5, 12, 13, 35 AND 50).

WILLIAM P. SHANAHAN, EXAMINING ATTORNEY

CLASS 17—(Continued).

SN 77-565,669. EATON AEROQUIP INC., CLEVELAND, OH.
FILED 9-9-2008.

PERFECTION

THE MARK CONSISTS OF STANDARD CHARACTERS WITHOUT CLAIM TO ANY PARTICULAR FONT, STYLE, SIZE, OR COLOR.

OWNER OF U.S. REG. NO. 160,399.
FOR MULTI-PURPOSE HOSE MADE OF THERMOPLASTIC AND RUBBER FOR CONVEYING FLUIDS FOR INDUSTRIAL AND AGRICULTURAL USES; MULTI-PURPOSE REINFORCED HOSE MADE OF THERMOPLASTIC AND RUBBER FOR CONVEYING FLUIDS FOR INDUSTRIAL AND AGRICULTURAL USES (U.S. CLS. 1, 5, 12, 13, 35 AND 50).

FIRST USE 10-31-1990; IN COMMERCE 10-31-1990.
REBECCA SMITH, EXAMINING ATTORNEY

SN 77-565,806. GTGLOBE INDUSTRIES LLC, GLENDALE, AZ. FILED 9-9-2008.

ThermoFlex

THE MARK CONSISTS OF STANDARD CHARACTERS WITHOUT CLAIM TO ANY PARTICULAR FONT, STYLE, SIZE, OR COLOR.

FOR FLEXIBLE PLASTIC PIPES FOR PLUMBING PURPOSES (U.S. CLS. 1, 5, 12, 13, 35 AND 50).
SANDRA MANIOS, EXAMINING ATTORNEY

SN 77-566,243. GLOBAL FOOTWEAR SOURCING AND TECHNICAL SERVICES INC., ZIONVILLE, NC. FILED 9-10-2008.

ECOFRIEND

THE MARK CONSISTS OF STANDARD CHARACTERS WITHOUT CLAIM TO ANY PARTICULAR FONT, STYLE, SIZE, OR COLOR.

FOR FOAM FOR USE IN THE MANUFACTURE OF FOOTWEAR (U.S. CLS. 1, 5, 12, 13, 35 AND 50).
APRIL ROACH, EXAMINING ATTORNEY

CLASS 17—(Continued).

SN 77-570,864. SEREFLEX GROUP, LLC, BALTIMORE, MD.
FILED 9-16-2008.

SEREPAK

THE MARK CONSISTS OF STANDARD CHARACTERS WITHOUT CLAIM TO ANY PARTICULAR FONT, STYLE, SIZE, OR COLOR.

FOR SYNTHETIC PLASTIC PADDING INSERTS FILLED WITH SEMI-PROCESSED FLUID OR GEL FOR SHOCK ABSORPTION AND DISTRIBUTION OF PRESSURE, FOR USE IN A WIDE VARIETY OF PRODUCTS (U.S. CLS. 1, 5, 12, 13, 35 AND 50).

JEAN IM, EXAMINING ATTORNEY

SN 77-597,700. CERTAINTTEED CORPORATION, VALLEY FORGE, PA. FILED 10-22-2008.

CERTAPRO

THE MARK CONSISTS OF STANDARD CHARACTERS WITHOUT CLAIM TO ANY PARTICULAR FONT, STYLE, SIZE, OR COLOR.

OWNER OF U.S. REG. NOS. 1,131,326, 2,319,181 AND 2,814,049.

FOR FIBERGLASS INSULATION FOR USE IN BUILDING AND CONSTRUCTION (U.S. CLS. 1, 5, 12, 13, 35 AND 50).

FIRST USE 6-0-1999; IN COMMERCE 3-0-2000.
VERNA BETH RIRIE, EXAMINING ATTORNEY

SN 78-841,515. KUREHA CORPOTATION, TOKYO, JAPAN,
FILED 3-20-2006.

TERRACY

THE MARK CONSISTS OF STANDARD CHARACTERS WITHOUT CLAIM TO ANY PARTICULAR FONT, STYLE, SIZE, OR COLOR.

OWNER OF JAPAN REG. NO. 4986590, DATED 9-8-2006, EXPIRES 9-8-2016.

FOR MOULD RELEASE FILMS, NAMELY PLASTIC FILMS USED FOR FACILITATING EASY REMOVAL OF PRODUCTS FROM MOULDS (U.S. CLS. 1, 5, 12, 13, 35 AND 50).

REBECCA POVARCHUK, EXAMINING ATTORNEY

CLASS 17—(Continued).

SN 79-050,118. KLÖCKNER PENTAPLAST GMBH & CO. KG, 56412 HEILIGENROTH, FED REP GERMANY, FILED 12-20-2007.

PENTAPRINT

THE MARK CONSISTS OF STANDARD CHARACTERS WITHOUT CLAIM TO ANY PARTICULAR FONT, STYLE, SIZE, OR COLOR.

OWNER OF INTERNATIONAL REGISTRATION 0953854 DATED 12-20-2007, EXPIRES 12-20-2017.

OWNER OF U.S. REG. NOS. 2,985,012, 3,060,525 AND OTHERS.

FOR FLEXIBLE AND RIGID PLASTIC FILMS FOR COMMERCIAL AND INDUSTRIAL USE; PLASTIC SHEETS IN EXTRUDED FORM FOR USE IN MANUFACTURING (U.S. CLS. 1, 5, 12, 13, 35 AND 50).

MAUREEN DALL, EXAMINING ATTORNEY

CLASS 18—LEATHER GOODS

SN 77-407,125. FIELD & STREAM LICENSES COMPANY, WESTPORT, CT. FILED 2-27-2008.



FIELD & STREAM
FIELD TESTED 1871 GUIDE APPROVED

OWNER OF U.S. REG. NOS. 1,375,802, 2,500,503 AND OTHERS.

NO CLAIM IS MADE TO THE EXCLUSIVE RIGHT TO USE "FIELD TESTED," "1871," AND "GUIDE APPROVED", APART FROM THE MARK AS SHOWN.

THE MARK CONSISTS OF THE DESIGN OF AN EAGLE ABOVE THE WORDING "FIELD & STREAM FIELD TESTED 1871 GUIDE APPROVED." A BROKEN HORIZONTAL LINE APPEARS BELOW THE WORDING "FIELD & STREAM" AND ABOVE THE WORDING "FIELD TESTED GUIDE APPROVED". THE NUMBER 1871 APPEARS IN THE MIDDLE OF THE BREAK IN THE LINE.

FOR HUNTING BACKPACKS, HUNTING BAGS, HIKING BACKPACKS, HIKING RUCKSACKS (U.S. CLS. 1, 2, 3, 22 AND 41).

DAVID ELTON, EXAMINING ATTORNEY

SN 79-055,071. NAR S.P.A, ITALY, FILED 6-24-2008.



PRIORITY DATE OF 4-11-2008 IS CLAIMED.

OWNER OF INTERNATIONAL REGISTRATION 0967701 DATED 6-24-2008, EXPIRES 6-24-2018.

THE COLOR(S) GRAY, GREEN AND BLACK IS/ARE CLAIMED AS A FEATURE OF THE MARK.

THE MARK CONSISTS OF A VERTICAL RECTANGLE, OF WHICH THE UPPER TWO-THIRDS ARE GRAY AND THE LOWER ONE-THIRD IS GREEN. ABOVE THE WORD "NAR" IN STYLIZED CAPITAL LETTERS, WHICH ARE SHOWN IN BLACK EXCEPT FOR THE LOWER LEFT BOTTOM OF THE LETTER N, WHICH IS SHOWN AS A SMALL RECTANGLE SIMILAR TO THE GREEN RECTANGLE ABOVE BUT MUCH SMALLER, IN THE SAME GREEN COLOR.

FOR ADHESIVE PACKAGING TAPES FOR INDUSTRIAL OR COMMERCIAL USE; ADHESIVE TAPES FOR INDUSTRIAL OR COMMERCIAL PACKAGING USE; ADHESIVE TAPES USED IN BUILDING CONSTRUCTION (U.S. CLS. 1, 5, 12, 13, 35 AND 50).

ESTHER BELENKER, EXAMINING ATTORNEY

SN 77-407,299. TARA MCCANN BEAVERS, DBA WEBE BAGS, PARK CITY, UT. FILED 2-27-2008.

H'Oat Couture

THE MARK CONSISTS OF STANDARD CHARACTERS WITHOUT CLAIM TO ANY PARTICULAR FONT, STYLE, SIZE, OR COLOR.

NO CLAIM IS MADE TO THE EXCLUSIVE RIGHT TO USE "COUTURE", APART FROM THE MARK AS SHOWN.

FOR TOTE BAGS AND PURSES MADE FROM RECYCLED FOOD AND GRAIN AND COFFEE BAGS (U.S. CLS. 1, 2, 3, 22 AND 41).

DAVID YONTEF, EXAMINING ATTORNEY

CLASS 18—(Continued).

SN 77-419,930. SEARS BRANDS, LLC, HOFFMAN ESTATES, IL. FILED 3-12-2008.

PIPER & BLUE

THE MARK CONSISTS OF STANDARD CHARACTERS WITHOUT CLAIM TO ANY PARTICULAR FONT, STYLE, SIZE, OR COLOR.

FOR HANDBAGS AND SMALL LEATHER GOODS, NAMELY, WALLETS, COIN PURSES, AND LEATHER KEY CHAINS (U.S. CLS. 1, 2, 3, 22 AND 41).

HANNO RITTNER, EXAMINING ATTORNEY

SN 77-422,820. DISNEY ENTERPRISES, INC., BURBANK, CA. FILED 3-14-2008.

ZETA BETA ZETA

THE MARK CONSISTS OF STANDARD CHARACTERS WITHOUT CLAIM TO ANY PARTICULAR FONT, STYLE, SIZE, OR COLOR.

FOR ARTICLES MADE FROM LEATHER AND IMITATIONS OF LEATHER, NAMELY, CALLING CARD CASES, CHANGE PURSES, COIN PURSES, FANNY PACKS, LUGGAGE, LUGGAGE TAGS, KNAPSACKS, KEY CASES, LEATHER KEY CHAINS, SATCHELS, WAIST PACKS, WALLETS; BAGS, NAMELY, ALL PURPOSE SPORT BAGS, ATHLETIC BAGS, BABY BACKPACKS, BACKPACKS, BEACH BAGS, BOOK BAGS, DUFFEL BAGS, GYM BAGS, OVERNIGHT BAGS; SHOPPING BAGS OF CANVAS, MESH, OR TEXTILE; TOTE BAGS; PURSES; HANDBAGS; WALLETS; UMBRELLAS; DIAPER BAGS (U.S. CLS. 1, 2, 3, 22 AND 41).

CAROLYN GRAY, EXAMINING ATTORNEY

SN 77-453,640. LB BRANDS, LLC, PORT CLYDE, ME. FILED 4-21-2008.

LINDA BEAN'S PERFECT MAINE

THE MARK CONSISTS OF STANDARD CHARACTERS WITHOUT CLAIM TO ANY PARTICULAR FONT, STYLE, SIZE, OR COLOR.

NO CLAIM IS MADE TO THE EXCLUSIVE RIGHT TO USE "MAINE", APART FROM THE MARK AS SHOWN.

THE NAME(S), PORTRAIT(S), AND/OR SIGNATURE(S) SHOWN IN THE MARK IDENTIFIES LINDA L. BEAN, WHOSE CONSENT(S) TO REGISTER IS SUBMITTED.

FOR TOTE BAGS, BEACH BAGS, CARRY-ALL BAGS (U.S. CLS. 1, 2, 3, 22 AND 41).

TIMOTHY FINNEGAN, EXAMINING ATTORNEY

CLASS 18—(Continued).

SN 77-539,060. SONYGOOD INDUSTRIES CO., LTD., MIAO LI HSIEN, TAIWAN, FILED 8-5-2008.

 The logo for "eBag" features the word "eBag" in a bold, sans-serif font. The letter "e" is stylized with a white circle inside it, and the "B" is also bold and sans-serif.

OWNER OF TAIWAN REG. NO. 01196513, DATED 2-16-2006, EXPIRES 2-15-2016.

THE MARK CONSISTS OF THE TERM "EEBAG" IN STYLIZED FONT WITH A RECTANGLE AROUND THE SECOND LETTER "E" IN THE MARK.

FOR WALLETS, PURSES, HANDBAGS, TRAVELING BAGS, BUM-BAGS, BACK PACKS, CANVAS SHOPPING BAGS, TEXTILE SHOPPING BAGS, LEATHER AND IMITATION LEATHER BAGS, REUSABLE SHOPPING BAGS, BABY BACKPACKS, UMBRELLAS, DOG COLLARS, MOUNTAINEERING STICKS (U.S. CLS. 1, 2, 3, 22 AND 41).

BRENDAN MCCAULEY, EXAMINING ATTORNEY

SN 77-540,714. COONEY, MAUREEN, GARDEN CITY, NY, AND HEANEY, ANN, GARDEN CITY, NY. FILED 8-6-2008.



THE MARK CONSISTS OF HIGHLY STYLIZED CURVED LINES WITHIN A CIRCLE.

FOR BEACH BAGS; CARRY-ALL BAGS; CHANGE PURSES; CLUTCHES; COIN PURSES; COSMETIC BAGS SOLD EMPTY; DIAPER BAGS; DUFFEL BAGS; GYM BAGS; HANDBAGS; PURSES; TOTE BAGS (U.S. CLS. 1, 2, 3, 22 AND 41).

LINDA E. BLOHM, EXAMINING ATTORNEY

CLASS 18—(Continued).

SN 77-560,166. SOUDANT, MICHAEL, LAFAYETTE, CO. FILED 9-2-2008.

COMPLETE LEASH

THE MARK CONSISTS OF STANDARD CHARACTERS WITHOUT CLAIM TO ANY PARTICULAR FONT, STYLE, SIZE, OR COLOR.

NO CLAIM IS MADE TO THE EXCLUSIVE RIGHT TO USE "LEASH", APART FROM THE MARK AS SHOWN.

FOR COMBINATION OF ANIMAL LEASH AND ANIMAL COLLAR SUITABLE FOR USE WITH DOGS, CATS AND OTHER SMALL ANIMALS WHICH ENABLES THE PET TO CARRY ITS OWN LEASH WHICH IS A PART OF THE COLLAR (U.S. CLS. 1, 2, 3, 22 AND 41).
CHRISTINE BLOMQUIST, EXAMINING ATTORNEY

CLASS 18—(Continued).

SN 77-564,612. LEISURE MERCHANDISING CORP., EDISON, NJ. FILED 9-8-2008.

LONDON TOWN

THE MARK CONSISTS OF STANDARD CHARACTERS WITHOUT CLAIM TO ANY PARTICULAR FONT, STYLE, SIZE, OR COLOR.

FOR CARRY-ON BAGS; GARMENT BAGS FOR TRAVEL; LUGGAGE; PULLMANS; SUITCASES; TOTE BAGS (U.S. CLS. 1, 2, 3, 22 AND 41).

KATHERINE E. HALMEN, EXAMINING ATTORNEY

SN 77-562,000. L.J. COUTURE, LLC, BETHEL, CT. FILED 9-4-2008.

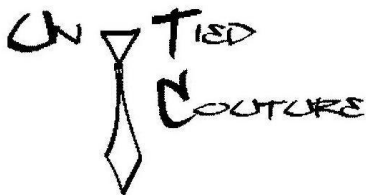

NO CLAIM IS MADE TO THE EXCLUSIVE RIGHT TO USE "COUTURE", APART FROM THE MARK AS SHOWN.

THE MARK CONSISTS OF A DESIGN OF A NECKTIE BETWEEN THE LETTERS "UN" AND "TIED" AND ABOVE THE WORD "COUTURE".

FOR HANDBAGS, SHOULDER BAGS, TOTE BAGS AND PURSES (U.S. CLS. 1, 2, 3, 22 AND 41).
SHANNON TWOHIG, EXAMINING ATTORNEY

SN 77-565,038. RIYO PETS, LLC, PLANO, TX. FILED 9-8-2008.

Riyo

THE MARK CONSISTS OF STANDARD CHARACTERS WITHOUT CLAIM TO ANY PARTICULAR FONT, STYLE, SIZE, OR COLOR.

FOR COLLARS FOR PETS; GARMENTS FOR PETS (U.S. CLS. 1, 2, 3, 22 AND 41).

FIRST USE 2-17-2008; IN COMMERCE 2-17-2008.

KATHERINE E. HALMEN, EXAMINING ATTORNEY

SN 77-564,567. LEISURE MERCHANDISING CORP., EDISON, NJ. FILED 9-8-2008.

OLD LONDON

THE MARK CONSISTS OF STANDARD CHARACTERS WITHOUT CLAIM TO ANY PARTICULAR FONT, STYLE, SIZE, OR COLOR.

FOR CARRY-ON BAGS; GARMENT BAGS FOR TRAVEL; LUGGAGE; PULLMANS; SUITCASES; TOTE BAGS; WHEELED BAGS (U.S. CLS. 1, 2, 3, 22 AND 41).

KATHERINE E. HALMEN, EXAMINING ATTORNEY

SN 77-565,149. DAVID C. ADLER & COMPANY, INC., UPPER SADDLE RIVER, NJ. FILED 9-8-2008.

Groove Leather

THE MARK CONSISTS OF STANDARD CHARACTERS WITHOUT CLAIM TO ANY PARTICULAR FONT, STYLE, SIZE, OR COLOR.

NO CLAIM IS MADE TO THE EXCLUSIVE RIGHT TO USE "LEATHER", APART FROM THE MARK AS SHOWN.

FOR UPHOLSTERY LEATHER (U.S. CLS. 1, 2, 3, 22 AND 41).

IRA J. GOODSID, EXAMINING ATTORNEY

CLASS 18—(Continued).

SN 77-565,697. CHROME HEARTS LLC, HOLLYWOOD, CA.
FILED 9-9-2008.

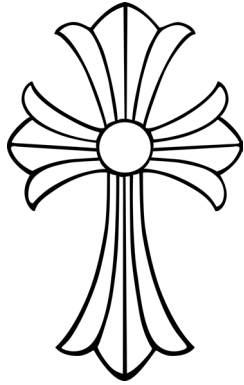

OWNER OF U.S. REG. NOS. 3,267,866, 3,385,416 AND
3,388,911.

THE MARK CONSISTS OF A CROSS DESIGN .
FOR BAGS, NAMELY, HANDBAGS, SHOULDER
BAGS, CLUTCHES, TOTE BAGS, WALLETS, BACK
PACKS AND LUGGAGE (U.S. CLS. 1, 2, 3, 22 AND 41).
FIRST USE 1-2-1989; IN COMMERCE 1-2-1989.
JENNIFER MARTIN, EXAMINING ATTORNEY

SN 77-565,790. GG BAGGS, LLC, MINNEAPOLIS, MN.
FILED 9-9-2008.



THE MARK CONSISTS OF DESIGN AND STYLIZED
TERM "GGBAGG" AND STYLIZED LETTERS "GG".
FOR CARRYING CASES; COSMETIC CARRYING
CASES SOLD EMPTY; HANDBAGS, PURSES AND WAL-
LETS; LUGGAGE; LUGGAGE TAGS (U.S. CLS. 1, 2, 3, 22
AND 41).
RONALD AIKENS, EXAMINING ATTORNEY

CLASS 18—(Continued).

SN 77-566,792. JUICY COUTURE, INC., PACOIMA, CA.
FILED 9-10-2008.

DAYDREAMER

THE MARK CONSISTS OF STANDARD CHARACTERS
WITHOUT CLAIM TO ANY PARTICULAR FONT, STYLE,
SIZE, OR COLOR.

FOR HANDBAGS (U.S. CLS. 1, 2, 3, 22 AND 41).
FIRST USE 3-16-2005; IN COMMERCE 3-16-2005.
NAPOLEON SHARMA, EXAMINING ATTORNEY

SN 77-567,257. DEL ROSARIO-GOMES, MARISSA A., DBA
MARISSA DESIGNS, SAN JOSE, CA. FILED 9-10-2008.

MARISSA DEL ROSARIO

THE MARK CONSISTS OF STANDARD CHARACTERS
WITHOUT CLAIM TO ANY PARTICULAR FONT, STYLE,
SIZE, OR COLOR.

THE NAME "MARISSA DEL ROSARIO" IDENTIFIES A
LIVING INDIVIDUAL WHOSE CONSENT IS OF RECORD.
FOR HANDBAGS, PURSES AND WALLETS;
LEATHER HANDBAGS (U.S. CLS. 1, 2, 3, 22 AND 41).
FIRST USE 6-10-2008; IN COMMERCE 6-10-2008.
KELLEY WELLS, EXAMINING ATTORNEY

SN 77-567,834. MATTHEW SHENKER, MASHPEE, MA.
FILED 9-11-2008.

NIPKIT

THE MARK CONSISTS OF STANDARD CHARACTERS
WITHOUT CLAIM TO ANY PARTICULAR FONT, STYLE,
SIZE, OR COLOR.

FOR CARRYING CASES (U.S. CLS. 1, 2, 3, 22 AND 41).
FIRST USE 9-11-2008; IN COMMERCE 9-11-2008.
JESSICA A. POWERS, EXAMINING ATTORNEY

CLASS 18—(Continued).

SN 77-570,455. GREEN GIRL, INC., MANHATTAN BEACH, CA. FILED 9-15-2008.

Shop Differently

THE MARK CONSISTS OF STANDARD CHARACTERS WITHOUT CLAIM TO ANY PARTICULAR FONT, STYLE, SIZE, OR COLOR.

FOR MULTI-PURPOSE CLOTH TOTE BAGS (U.S. CLS. 1, 2, 3, 22 AND 41).

FIRST USE 9-7-2008; IN COMMERCE 9-7-2008.
AMY ALFIERI, EXAMINING ATTORNEY



SN 77-597,946. WOLVERINE WORLD WIDE, INC., ROCKFORD, MI. FILED 10-22-2008.

WOLVERINE 1000 MILE

THE MARK CONSISTS OF STANDARD CHARACTERS WITHOUT CLAIM TO ANY PARTICULAR FONT, STYLE, SIZE, OR COLOR.

FOR BAGS, NAMELY, ALL PURPOSE CARRYING, SPORT AND ATHLETIC BAGS, DUFFEL BAGS, CARRY-ON BAGS, CARRY-ALL BAGS, AND HIKING BAGS; BACKPACKS; WAIST PACKS (U.S. CLS. 1, 2, 3, 22 AND 41).

ROBIN CHOSID, EXAMINING ATTORNEY



CLASS 19—NON-METALLIC BUILDING MATERIALS

SN 77-258,294. COLD SPRING GRANITE COMPANY, COLD SPRING, MN. FILED 8-17-2007.

MESABI BLACK

THE MARK CONSISTS OF STANDARD CHARACTERS WITHOUT CLAIM TO ANY PARTICULAR FONT, STYLE, SIZE, OR COLOR.

NO CLAIM IS MADE TO THE EXCLUSIVE RIGHT TO USE "BLACK", APART FROM THE MARK AS SHOWN.

FOR GRANITE, CUT STONE, DIMENSIONAL STONE, SLABS OF GRANITE, AND MONUMENTAL STONE (U.S. CLS. 1, 12, 33 AND 50).

FIRST USE 1-0-1995; IN COMMERCE 1-0-1995.
MARLENE BELL, EXAMINING ATTORNEY

CLASS 19—(Continued).

SN 77-337,872. NORLEANS TECHNOLOGIES, INC., OTTAWA, CANADA, FILED 11-27-2007.

LOCKGRID

THE MARK CONSISTS OF STANDARD CHARACTERS WITHOUT CLAIM TO ANY PARTICULAR FONT, STYLE, SIZE, OR COLOR.

PRIORITY CLAIMED UNDER SEC. 44(D) ON CANADA APPLICATION NO. 1358239, FILED 8-1-2007, REG. NO. TMA730157, DATED 12-4-2008, EXPIRES 12-4-2023.

FOR EXTERIOR SURFACE AND SUBSURFACE PRODUCT, NAMELY, PLASTIC SECTIONAL FLOORING USED FOR EROSION CONTROL, SOIL STABILIZER, LANDSCAPING, VEHICLE MAINTENANCE, CAMP FLOORING AND WORK AREAS AND FOR DRIVEWAYS, WALKWAYS, TRAILS, ROADWAYS, MINES AND PARKING LOTS (U.S. CLS. 1, 12, 33 AND 50).

FIRST USE 1-11-2006; IN COMMERCE 1-11-2006.
PAM WILLIS, EXAMINING ATTORNEY



SN 77-395,259. AFFILIATED RESOURCES, INC., PORTLAND, OR. FILED 2-12-2008.

DYNA-BILT

THE MARK CONSISTS OF STANDARD CHARACTERS WITHOUT CLAIM TO ANY PARTICULAR FONT, STYLE, SIZE, OR COLOR.

OWNER OF U.S. REG. NOS. 2,732,062, 3,015,599 AND 3,196,766.

FOR BUILDING MATERIALS, NAMELY, ORIENTED STRAND BOARD; PLYWOOD; PLYWOOD PANELS; PLYWOOD PANELS FOR USE IN LAMINATING AS A COMPONENT PANEL; PLYWOOD PANELS FOR USE AS COMPONENT PANEL PARTS; FLOOR BOARDS; FLOOR PANELS NOT OF METAL; AND PLYWOOD BOARD (U.S. CLS. 1, 12, 33 AND 50).

FIRST USE 10-0-2006; IN COMMERCE 10-0-2006.
TINA L. SNAPP, EXAMINING ATTORNEY



SN 77-397,827. CERTAINTEED CEILINGS CORPORATION, VALLEY FORGE, PA. FILED 2-15-2008.

SECLUDE

THE MARK CONSISTS OF STANDARD CHARACTERS WITHOUT CLAIM TO ANY PARTICULAR FONT, STYLE, SIZE, OR COLOR.

FOR NON-METAL BUILDING MATERIALS, NAMELY, CEILING PANELS (U.S. CLS. 1, 12, 33 AND 50).

MICHAEL LITZAU, EXAMINING ATTORNEY

CLASS 19—(Continued).

SN 77-401,828. GREENWOOD, INC., DANVILLE, IL. FILED 2-20-2008.

REFLECTION

THE MARK CONSISTS OF STANDARD CHARACTERS WITHOUT CLAIM TO ANY PARTICULAR FONT, STYLE, SIZE, OR COLOR.

FOR BURIAL VAULTS NOT OF METAL HAVING OPTIONAL EXTERIOR METAL FINISHING AND HARDWARE (U.S. CLS. 1, 12, 33 AND 50).

LINDA E. BLOHM, EXAMINING ATTORNEY

SN 77-403,211. AFFILIATED RESOURCES, INC., PORTLAND, OR. FILED 2-21-2008.

DYNA SHIELD

THE MARK CONSISTS OF STANDARD CHARACTERS WITHOUT CLAIM TO ANY PARTICULAR FONT, STYLE, SIZE, OR COLOR.

OWNER OF U.S. REG. NOS. 2,732,062, 3,015,599 AND 3,196,766.

FOR PLYWOOD PANELS; PLYWOOD BOARD; NON-METAL BUILDING MATERIALS, NAMELY, ORIENTED STRAND BOARD PANELS (U.S. CLS. 1, 12, 33 AND 50).

TINA L. SNAPP, EXAMINING ATTORNEY

SN 77-403,220. AFFILIATED RESOURCES, INC., PORTLAND, OR. FILED 2-21-2008.

DYNA SLIDE

THE MARK CONSISTS OF STANDARD CHARACTERS WITHOUT CLAIM TO ANY PARTICULAR FONT, STYLE, SIZE, OR COLOR.

OWNER OF U.S. REG. NOS. 2,732,062, 3,015,599 AND 3,196,766.

NO CLAIM IS MADE TO THE EXCLUSIVE RIGHT TO USE "SLIDE", APART FROM THE MARK AS SHOWN.

FOR NON-METAL BUILDING MATERIALS, NAMELY, WOOD AND POLYETHYLENE PANELS (U.S. CLS. 1, 12, 33 AND 50).

TINA L. SNAPP, EXAMINING ATTORNEY

CLASS 19—(Continued).

SN 77-412,957. SNAP-ON INCORPORATED, KENOSHA, WI. FILED 3-4-2008.

SNAP-ON

THE MARK CONSISTS OF STANDARD CHARACTERS WITHOUT CLAIM TO ANY PARTICULAR FONT, STYLE, SIZE, OR COLOR.

OWNER OF U.S. REG. NOS. 1,610,337, 1,961,695 AND 1,983,599.

SEC. 2(F).

FOR NON-METAL FLOOR TILES FOR GARAGES (U.S. CLS. 1, 12, 33 AND 50).

JOHN E. MICHOS, EXAMINING ATTORNEY

SN 77-525,126. CERÁMICA NTRA. SRA. DE LA OLIVA, S.A., TOLEDO, SPAIN, FILED 7-17-2008.

OWNER OF SPAIN REG. NO. 2040066, DATED 1-20-1997, EXPIRES 7-16-2016.

NO CLAIM IS MADE TO THE EXCLUSIVE RIGHT TO USE "CERAMICA", APART FROM THE MARK AS SHOWN.

THE COLOR(S) GREEN AND BLACK IS/ARE CLAIMED AS A FEATURE OF THE MARK.

THE MARK CONSISTS OF "CERAMICA LA OLIVA" IN A STYLIZED FONT, WITH THREE DIAGONAL LINES OF EQUAL LENGTH STRIKING THROUGH THE UPPER LEFT CORNER OF THE LETTER "O". THE WORD "CERAMICA" IS LOCATED ABOVE THE WORD "LA" AND IS IN THE COLOR BLACK. THE WORDS "LA OLIVA" ARE IN THE COLOR GREEN.

THE FOREIGN WORDING IN THE MARK TRANSLATES INTO ENGLISH AS CERAMICS OR POTTERY AND THE OLIVE.

FOR NON-METALLIC BUILDING MATERIALS, NAMELY, BRICKS, TILES, THERMO-CLAY BLOCKS AND PAVERS; NON-METALLIC RIGID PIPES FOR BUILDING; ASPHALT, PITCH AND BITUMEN; NON-METALLIC TRANSPORTABLE BUILDINGS (U.S. CLS. 1, 12, 33 AND 50).

MATTHEW MCDOWELL, EXAMINING ATTORNEY

CLASS 19—(Continued).

SN 77-531,744. DRYVIT SYSTEMS, INC., WEST WARWICK, RI. FILED 7-25-2008.

OUTSULATION

THE MARK CONSISTS OF STANDARD CHARACTERS WITHOUT CLAIM TO ANY PARTICULAR FONT, STYLE, SIZE, OR COLOR.

OWNER OF U.S. REG. NO. 2,649,360.

FOR CLADDING NOT OF METAL APPLIED TO EXTERIOR SURFACES OF BUILDINGS COMPRISING AS COMPONENTS THEREOF EXPANDED POLYSTYRENE INSULATION BOARD, REINFORCED BASE COAT AND A POLYMER-BASED EXTERIOR FINISH (U.S. CLS. 1, 12, 33 AND 50).

FIRST USE 1-29-1979; IN COMMERCE 1-29-1979.
MELISSA VALLILLO, EXAMINING ATTORNEY

SN 77-539,159. TREX COMPANY, INC., WINCHESTER, VA. FILED 8-5-2008.

TREX PROFILES

THE MARK CONSISTS OF STANDARD CHARACTERS WITHOUT CLAIM TO ANY PARTICULAR FONT, STYLE, SIZE, OR COLOR.

OWNER OF U.S. REG. NOS. 1,881,449, 2,470,104 AND OTHERS.

NO CLAIM IS MADE TO THE EXCLUSIVE RIGHT TO USE "PROFILES", APART FROM THE MARK AS SHOWN.

FOR COMPOSITE BUILDING MATERIALS COMPRISING WOOD FIBER AND POLYMER, NAMELY, DECKING AND RAILING PRODUCTS (U.S. CLS. 1, 12, 33 AND 50).

AMY C. KEAN, EXAMINING ATTORNEY

SN 77-552,597. MACHADO, EDDIE, DBA EDDIE MACHADO, SHIRLEY, NY. FILED 8-21-2008.

Gutter Kidz

THE MARK CONSISTS OF STANDARD CHARACTERS WITHOUT CLAIM TO ANY PARTICULAR FONT, STYLE, SIZE, OR COLOR.

NO CLAIM IS MADE TO THE EXCLUSIVE RIGHT TO USE "GUTTER", APART FROM THE MARK AS SHOWN.

FOR NON-METAL GUTTERS (U.S. CLS. 1, 12, 33 AND 50).

WENDY GOODMAN, EXAMINING ATTORNEY

CLASS 19—(Continued).

SN 77-559,348. COBBLETECH, LLC, ATLANTA, GA. FILED 8-29-2008.

COBBLETECH

THE MARK CONSISTS OF STANDARD CHARACTERS WITHOUT CLAIM TO ANY PARTICULAR FONT, STYLE, SIZE, OR COLOR.

FOR PAVERS; PAVING STONES (U.S. CLS. 1, 12, 33 AND 50).

NANCY CLARKE, EXAMINING ATTORNEY

SN 77-561,013. FOLDING GUARD COMPANY, BEDFORD PARK, IL. FILED 9-3-2008.

HARDGUARD

THE MARK CONSISTS OF STANDARD CHARACTERS WITHOUT CLAIM TO ANY PARTICULAR FONT, STYLE, SIZE, OR COLOR.

FOR NON-METAL PEDESTRIAN BARRIERS (U.S. CLS. 1, 12, 33 AND 50).

KELLY BOULTON, EXAMINING ATTORNEY

SN 77-563,630. INTEX RECREATION CORPORATION, LONG BEACH, CA. FILED 9-5-2008.

SEQUOIA SPIRIT

THE MARK CONSISTS OF STANDARD CHARACTERS WITHOUT CLAIM TO ANY PARTICULAR FONT, STYLE, SIZE, OR COLOR.

FOR ABOVE GROUND SWIMMING POOLS PRIMARILY MADE OF VINYL SIDES AND A VINYL LINING WITH A METAL FRAME (U.S. CLS. 1, 12, 33 AND 50).

FIRST USE 11-4-2006; IN COMMERCE 11-4-2006.
GISELLE AGOSTO, EXAMINING ATTORNEY

SN 77-564,186. SYRON INDUSTRIES, INC., SYRACUSE, NY. FILED 9-8-2008.

EcoVue

THE MARK CONSISTS OF STANDARD CHARACTERS WITHOUT CLAIM TO ANY PARTICULAR FONT, STYLE, SIZE, OR COLOR.

FOR NON-METAL WINDOWS (U.S. CLS. 1, 12, 33 AND 50).

JACQUELINE A. LAVINE, EXAMINING ATTORNEY

CLASS 19—(Continued).

SN 77-564,221. RITE-HITE HOLDING CORPORATION, MILWAUKEE, WI. FILED 9-8-2008.

SpanGuard

THE MARK CONSISTS OF STANDARD CHARACTERS WITHOUT CLAIM TO ANY PARTICULAR FONT, STYLE, SIZE, OR COLOR.

FOR NON-METAL FENCING IN THE NATURE OF AN INDUSTRIAL SAFETY BARRIER (U.S. CLS. 1, 12, 33 AND 50).

FIRST USE 7-1-2008; IN COMMERCE 7-1-2008.
MARK SHINER, EXAMINING ATTORNEY

CLASS 19—(Continued).

SN 77-565,643. WELLINGTON INVESTMENT CORPORATION, VANCOUVER, CANADA, FILED 9-9-2008.

ECO-WISE

THE MARK CONSISTS OF STANDARD CHARACTERS WITHOUT CLAIM TO ANY PARTICULAR FONT, STYLE, SIZE, OR COLOR.

FOR WOOD MOLDINGS; WOOD BOARDS (U.S. CLS. 1, 12, 33 AND 50).

DAVID MURRAY, EXAMINING ATTORNEY

SN 77-565,037. MICHELLE KAUFMANN DESIGNS, OAKLAND, CA. FILED 9-8-2008.

BREEZEHOUSE

THE MARK CONSISTS OF STANDARD CHARACTERS WITHOUT CLAIM TO ANY PARTICULAR FONT, STYLE, SIZE, OR COLOR.

FOR MODULAR HOMES (U.S. CLS. 1, 12, 33 AND 50).
FIRST USE 1-0-2005; IN COMMERCE 3-0-2005.

TOBY BULLOFF, EXAMINING ATTORNEY

SN 77-566,405. VITRO VIDRIO Y CRISTAL, S.A. DE C.V., GARCÍA, NUEVO LEÓN, MEXICO, FILED 9-10-2008.

ECOPURE

THE MARK CONSISTS OF STANDARD CHARACTERS WITHOUT CLAIM TO ANY PARTICULAR FONT, STYLE, SIZE, OR COLOR.

FOR GLASS FOR BUILDING AND CONSTRUCTION (U.S. CLS. 1, 12, 33 AND 50).

CHARLES L. JENKINS, EXAMINING ATTORNEY

SN 77-565,568. CONNELLY, MARC, QUAKER HILL, CT. FILED 9-9-2008.

CRAZYCRETE

THE MARK CONSISTS OF STANDARD CHARACTERS WITHOUT CLAIM TO ANY PARTICULAR FONT, STYLE, SIZE, OR COLOR.

FOR CONCRETE (U.S. CLS. 1, 12, 33 AND 50).
CORY BOONE, EXAMINING ATTORNEY

SN 77-567,885. ODL, INCORPORATED, ZEELAND, MI. FILED 9-11-2008.

FIBERMATE

THE MARK CONSISTS OF STANDARD CHARACTERS WITHOUT CLAIM TO ANY PARTICULAR FONT, STYLE, SIZE, OR COLOR.

FOR NON-METAL WINDOW FRAMES, NAMELY, DOORGLASS FRAMES (U.S. CLS. 1, 12, 33 AND 50).

LEIGH CAROLINE CASE, EXAMINING ATTORNEY

CLASS 19—(Continued).

SN 77-574,834. LUMETA, INC., IRVINE, CA. FILED 9-19-2008.

Lumeta^o

THE MARK CONSISTS OF STYLIZED LETTERS, L, U, M, E, T, A AND AN ELEVATED CIRCLE AFTER THE LETTER A.
FOR NON-METAL ROOFING TILES HAVING INTEGRATED SOLAR PANELS (U.S. CLS. 1, 12, 33 AND 50).
ALEXANDER L. POWERS, EXAMINING ATTORNEY

CLASS 19—(Continued).

SN 77-603,061. MICHELLE KAUFMANN DESIGNS, OAKLAND, CA. FILED 10-29-2008.

MKHEARTH

THE MARK CONSISTS OF STANDARD CHARACTERS WITHOUT CLAIM TO ANY PARTICULAR FONT, STYLE, SIZE, OR COLOR.
FOR MODULAR HOMES (U.S. CLS. 1, 12, 33 AND 50).
TOBY BULLOFF, EXAMINING ATTORNEY

SN 77-589,979. SWIMC, INC., WILMINGTON, DE. FILED 10-10-2008.

GENERAL POLYMERS

THE MARK CONSISTS OF STANDARD CHARACTERS WITHOUT CLAIM TO ANY PARTICULAR FONT, STYLE, SIZE, OR COLOR.
OWNER OF U.S. REG. NO. 2,060,315.
NO CLAIM IS MADE TO THE EXCLUSIVE RIGHT TO USE "POLYMERS", APART FROM THE MARK AS SHOWN.
FOR SYNTHETIC FLOORING MATERIALS OR WALL-CLADDINGS (U.S. CLS. 1, 12, 33 AND 50).
FIRST USE 1-2-1967; IN COMMERCE 1-2-1967.
MICHAEL LITZAU, EXAMINING ATTORNEY

SN 79-061,115. TERREAL, FRANCE, FILED 9-8-2008.

BLIZZARD

PRIORITY DATE OF 3-27-2008 IS CLAIMED.
OWNER OF INTERNATIONAL REGISTRATION 0982686 DATED 9-8-2008. EXPIRES 9-8-2018.
FOR CLADDING PANELS FOR FACADES MADE OF TERRA-COTTA (U.S. CLS. 1, 12, 33 AND 50).
GINA FINK, EXAMINING ATTORNEY

SN 77-603,026. MICHELLE KAUFMANN DESIGNS, OAKLAND, CA. FILED 10-29-2008.

MKLOFT

THE MARK CONSISTS OF STANDARD CHARACTERS WITHOUT CLAIM TO ANY PARTICULAR FONT, STYLE, SIZE, OR COLOR.
FOR MODULAR HOMES (U.S. CLS. 1, 12, 33 AND 50).
TOBY BULLOFF, EXAMINING ATTORNEY

CLASS 20—FURNITURE AND ARTICLES NOT OTHERWISE CLASSIFIED

SN 76-685,435. TIMELY INVENTIONS LLC, LOS ANGELES, CA. FILED 12-31-2007.

BUTTERFLY PALLET SHROUD

THE MARK CONSISTS OF STANDARD CHARACTERS WITHOUT CLAIM TO ANY PARTICULAR FONT, STYLE, SIZE, OR COLOR.
NO CLAIM IS MADE TO THE EXCLUSIVE RIGHT TO USE "PALLET SHROUD", APART FROM THE MARK AS SHOWN.
FOR CARDBOARD FLOOR DISPLAY UNITS FOR MERCHANDISING PRODUCTS (U.S. CLS. 2, 13, 22, 25, 32 AND 50).
FIRST USE 11-28-2007; IN COMMERCE 11-28-2007.
DAVID TAYLOR, EXAMINING ATTORNEY

CLASS 20—(Continued).

SN 77-112,052. LE BRETON, CRAIG, BRISBANE QUEENSLAND, AUSTRALIA, FILED 2-21-2007.



PRIORITY CLAIMED UNDER SEC. 44(D) ON AUSTRALIA APPLICATION NO. 1130894, FILED 8-22-2006, REG. NO. 1130894, DATED 8-22-2006, EXPIRES 8-22-2016.

NO CLAIM IS MADE TO THE EXCLUSIVE RIGHT TO USE "DIAMOND COATED HOLE SAWS", APART FROM THE MARK AS SHOWN.

THE COLOR(S) RED, WHITE, YELLOW, DARK RED IS/ARE CLAIMED AS A FEATURE OF THE MARK.

THE MARK CONSISTS OF STYLIZED WORDS "EZI-CUT" IN WHITE, AND STYLIZED WORDS "DIAMOND COATED HOLE SAWS" IN YELLOW IN A RED BACKGROUND IMAGE WITH SUN RAYS IN DARKER RED.

FOR DISPLAY BOARDS (U.S. CLS. 2, 13, 22, 25, 32 AND 50).

DOMINIC J. FERRAIUOLO, EXAMINING ATTORNEY

SN 77-192,704. THOMASVILLE FURNITURE INDUSTRIES, INC., THOMASVILLE, NC. FILED 5-30-2007.

SOLILOQUE

THE MARK CONSISTS OF STANDARD CHARACTERS WITHOUT CLAIM TO ANY PARTICULAR FONT, STYLE, SIZE, OR COLOR.

THE ENGLISH TRANSLATION OF "SOLILOQUE" IS "SOLILOQUY"

FOR FURNITURE (U.S. CLS. 2, 13, 22, 25, 32 AND 50).
TRACY FLETCHER, EXAMINING ATTORNEY

SN 77-259,400. BUCKHORN INC., MILFORD, OH. FILED 8-20-2007.

OWNER OF U.S. REG. NO. 1,330,520.

THE MARK CONSISTS OF A PYRAMID CONSISTING OF STACKED SHADED BOXES AND THE WORD "BUCKHORN"

FOR INDUSTRIAL BASKETS MADE PRIMARILY OF PLASTIC; PLASTIC BOXES FOR TRANSPORTING AND STORING GOODS; PLASTIC TRAYS FOR TRANSPORTING AND STORING GOODS; BINS, LIDS AND PALLETS ALL MADE PRIMARILY OF NONMETAL (U.S. CLS. 2, 13, 22, 25, 32 AND 50).

JACQUELINE A. LAVINE, EXAMINING ATTORNEY

CLASS 20—(Continued).

SN 77-259,425. BUCKHORN INC., MILFORD, OH. FILED 8-20-2007.



THE MARK CONSISTS OF A PYRAMID CONSISTING OF STACKED SHADED BOXES.

FOR INDUSTRIAL BASKETS MADE PRIMARILY OF PLASTIC; PLASTIC BOXES FOR TRANSPORTING AND STORING GOODS; PLASTIC TRAYS FOR TRANSPORTING AND STORING GOODS; BINS, LIDS AND PALLETS ALL MADE PRIMARILY OF NONMETAL (U.S. CLS. 2, 13, 22, 25, 32 AND 50).

JACQUELINE A. LAVINE, EXAMINING ATTORNEY

SN 77-332,372. HAND INTERNATIONAL, LLC, CATONSVILLE, MD. FILED 11-17-2007.

hand

THE MARK CONSISTS OF STANDARD CHARACTERS WITHOUT CLAIM TO ANY PARTICULAR FONT, STYLE, SIZE, OR COLOR.

FOR RING PILLOWS AND PLASTIC CAKE DECORATIONS (U.S. CLS. 2, 13, 22, 25, 32 AND 50).

MELVIN AXILBUND, EXAMINING ATTORNEY

SN 77-401,179. GREENWOOD, INC., DANVILLE, IL. FILED 2-20-2008.

TRILOGY

THE MARK CONSISTS OF STANDARD CHARACTERS WITHOUT CLAIM TO ANY PARTICULAR FONT, STYLE, SIZE, OR COLOR.

FOR BURIAL URNS NOT OF METAL (U.S. CLS. 2, 13, 22, 25, 32 AND 50).

LINDA E. BLOHM, EXAMINING ATTORNEY

CLASS 20—(Continued).

SN 77-407,167. FIELD & STREAM LICENSES COMPANY, WESTPORT, CT. FILED 2-27-2008.



OWNER OF U.S. REG. NOS. 2,044,018, 2,834,222 AND OTHERS.

NO CLAIM IS MADE TO THE EXCLUSIVE RIGHT TO USE "FIELD TESTED," "1871," AND "GUIDE APPROVED", APART FROM THE MARK AS SHOWN.

THE MARK CONSISTS OF THE DESIGN OF AN EAGLE ABOVE THE WORDING "FIELD & STREAM FIELD TESTED 1871 GUIDE APPROVED." A BROKEN HORIZONTAL LINE APPEARS BELOW THE WORDING "FIELD & STREAM" AND ABOVE THE WORDING "FIELD TESTED GUIDE APPROVED". THE NUMBER 1871 APPEARS IN THE MIDDLE OF THE BREAK IN THE LINE.

FOR FURNITURE FOR CAMPING, FOLDING TABLE AND CHAIRS, AIR MATTRESSES FOR USE WHEN CAMPING, INFLATABLE MATTRESSES AND PILLOWS FOR USE WHEN CAMPING, METAL CAMPING FURNITURE, SLEEPING BAGS (U.S. CLS. 2, 13, 22, 25, 32 AND 50).

DAVID ELTON, EXAMINING ATTORNEY

CLASS 20—(Continued).

SN 77-477,792. KEMM, LESLIE, BERWYN, PA. AND BABY MATTERS LLC, BERWYN, PA. FILED 5-19-2008.

NAP NANNY

THE MARK CONSISTS OF STANDARD CHARACTERS WITHOUT CLAIM TO ANY PARTICULAR FONT, STYLE, SIZE, OR COLOR.

FOR CHILD AND INFANT SLEEP SYSTEMS CONSISTING PRIMARILY OF A CONTOURED FOAM MATTRESS ALONG WITH A CONTOURED FOAM MATTRESS COVER AND INTEGRATED CHILD SAFETY HARNESS (U.S. CLS. 2, 13, 22, 25, 32 AND 50).

FIRST USE 9-7-2008; IN COMMERCE 9-7-2008.
ADA HAN, EXAMINING ATTORNEY

SN 77-493,738. GRUNST, ERICA LYNN, DBA BEDNAR, ERICA LYNN, TEMPLE, GA. FILED 6-8-2008.

My Nappie

THE MARK CONSISTS OF STANDARD CHARACTERS WITHOUT CLAIM TO ANY PARTICULAR FONT, STYLE, SIZE, OR COLOR.

FOR HEAD SUPPORTING PILLOWS (U.S. CLS. 2, 13, 22, 25, 32 AND 50).

FIRST USE 5-16-2008; IN COMMERCE 6-5-2008.
JILL PRATER, EXAMINING ATTORNEY

SN 77-426,396. INDUSTRIAS TOBIA, S.A., LOGRONO (LA RIOJA), SPAIN, FILED 3-19-2008.



THE COLOR(S) BLUE IS/ARE CLAIMED AS A FEATURE OF THE MARK.

THE MARK CONSISTS OF THE WORD "SPALDIN" IN STYLIZED BLUE LETTERS.

FOR MATTRESSES; ADJUSTABLE BEDS; PILLOWS (U.S. CLS. 2, 13, 22, 25, 32 AND 50).

FIRST USE 4-10-2007; IN COMMERCE 4-10-2007.
HANNO RITTNER, EXAMINING ATTORNEY

SN 77-498,329. 9155-0020 QUÉBEC INC., GRANBY, CANADA, FILED 6-13-2008.



OWNER OF U.S. REG. NO. 2,726,204.
THE COLOR(S) BLUE IS/ARE CLAIMED AS A FEATURE OF THE MARK.

THE MARK CONSISTS OF THE TERMS "DISPILL" IN BLUE AND THE DESIGN OF A PILL CONTAINING DIFFERENT SHADES OF BLUE.

FOR KIT CONSISTING PRIMARILY OF A CONTAINER DISPENSER SOLD EMPTY WHICH SORTS OUT PILLS, TABLETS AND CAPSULES (U.S. CLS. 2, 13, 22, 25, 32 AND 50).

FIRST USE 6-30-2003; IN COMMERCE 6-30-2003.
CHRIS WELLS, EXAMINING ATTORNEY

CLASS 20—(Continued).

SN 77-520,231. LOUISVILLE LADDER INC., LOUISVILLE, KY. FILED 7-11-2008.



OWNER OF U.S. REG. NOS. 1,613,889, 2,707,072 AND OTHERS.

THE COLOR(S) YELLOW AND BLACK IS/ARE CLAIMED AS A FEATURE OF THE MARK.

THE MARK CONSISTS OF A YELLOW RECTANGULAR DESIGN WITH BLACK LINED BORDER AND A BLACK SQUARE IN THE CENTER CONTAINING THE TERMS "PRO" AND "TOP" IN LARGE YELLOW FONT WITH AN ELONGATED OVAL DESIGN IN THE COLOR YELLOW IN THE MIDDLE CONTAINING A SIDEWAYS THREE CHEVRON DESIGN AND THE TERM "LOUISVILLE" IN BLACK WITH TWO SMALL BLACK HEXAGONAL SHAPES ON EACH SIDE IN BLACK.

SEC. 2(F) AS TO "LOUISVILLE".

FOR NON-METAL LADDER ACCESSORIES, NAMELY, PLASTIC WORK SURFACES FEATURING TOOL AND ACCESSORY ORGANIZERS, FOR USE ON AND ATTACHMENT TO LADDERS (U.S. CLS. 2, 13, 22, 25, 32 AND 50).

CHRISTINA SOBRAL, EXAMINING ATTORNEY

SN 77-550,670. JOERNS HEALTHCARE INC., STEVENS POINT, WI. FILED 8-19-2008.

ULTRALOCK

THE MARK CONSISTS OF STANDARD CHARACTERS WITHOUT CLAIM TO ANY PARTICULAR FONT, STYLE, SIZE, OR COLOR.

FOR HOSPITAL, POST ACUTE, SKILLED NURSING, HOME AND MEDICAL FURNITURE, NAMELY, A LOCK FEATURE FOR RESTRAINING MOVEMENT OF A BED SOLD AS AN INTEGRAL COMPONENT OF THE BED (U.S. CLS. 2, 13, 22, 25, 32 AND 50).

FONG HSU, EXAMINING ATTORNEY

CLASS 20—(Continued).

SN 77-551,101. SUDIA, MICHAEL T, DANVILLE, CA. FILED 8-20-2008.

Pizza Pallet

THE MARK CONSISTS OF STANDARD CHARACTERS WITHOUT CLAIM TO ANY PARTICULAR FONT, STYLE, SIZE, OR COLOR.

NO CLAIM IS MADE TO THE EXCLUSIVE RIGHT TO USE "PIZZA", APART FROM THE MARK AS SHOWN.

FOR PACKAGING MATERIALS, NAMELY, RIGID PLASTIC TRAYS (U.S. CLS. 2, 13, 22, 25, 32 AND 50).

KAELIE KUNG, EXAMINING ATTORNEY

SN 77-557,914. ERGOBIZ, LLC, SALISBURY, NC. FILED 8-28-2008.

MOBO

THE MARK CONSISTS OF STANDARD CHARACTERS WITHOUT CLAIM TO ANY PARTICULAR FONT, STYLE, SIZE, OR COLOR.

FOR COMPUTER FURNITURE (U.S. CLS. 2, 13, 22, 25, 32 AND 50).

LANA PHAM, EXAMINING ATTORNEY

SN 77-559,035. TRENDWAY CORPORATION, HOLLAND, MI. FILED 8-29-2008.

SITE

THE MARK CONSISTS OF STANDARD CHARACTERS WITHOUT CLAIM TO ANY PARTICULAR FONT, STYLE, SIZE, OR COLOR.

FOR OFFICE FURNITURE, NAMELY, TABLES (U.S. CLS. 2, 13, 22, 25, 32 AND 50).

SEAN CROWLEY, EXAMINING ATTORNEY

CLASS 20—(Continued).

SN 77-563,216. GLENN, GABRIELLE, FLORENCE, SC.
FILED 9-5-2008.

GO-STAND

THE MARK CONSISTS OF STANDARD CHARACTERS WITHOUT CLAIM TO ANY PARTICULAR FONT, STYLE, SIZE, OR COLOR.

FOR PLASTIC, COLLAPSIBLE, INVERTIBLE PLANT STAND (U.S. CLS. 2, 13, 22, 25, 32 AND 50).
FRANK LATTUCA, EXAMINING ATTORNEY

SN 77-563,450. DOREL JUVENILE GROUP, INC., FOXBORO, MA. FILED 9-5-2008.

SERVE N STORE

THE MARK CONSISTS OF STANDARD CHARACTERS WITHOUT CLAIM TO ANY PARTICULAR FONT, STYLE, SIZE, OR COLOR.

FOR HIGH CHAIRS (U.S. CLS. 2, 13, 22, 25, 32 AND 50).
INGA ERVIN, EXAMINING ATTORNEY

SN 77-563,522. ELECTRONIC IMAGING MATERIALS, INC., KEENE, NH. FILED 9-5-2008.

CODE-N-SEAL

THE MARK CONSISTS OF STANDARD CHARACTERS WITHOUT CLAIM TO ANY PARTICULAR FONT, STYLE, SIZE, OR COLOR.

FOR PLASTIC LABELS (U.S. CLS. 2, 13, 22, 25, 32 AND 50).
THEODORE MCBRIDE, EXAMINING ATTORNEY

CLASS 20—(Continued).

SN 77-563,824. MUNOZ, VERONICA, NORWALK, CA.
FILED 9-5-2008.



THE COLOR(S) BLUE, AND BLACK IS/ARE CLAIMED AS A FEATURE OF THE MARK.

THE MARK CONSISTS OF A STYLIZED LETTER "V" IN USED IN COMBINATION WITH THE TERMS "ERY" AND "ERO" TO FORM THE WORDING "VERYVERO" IN BLACK ENCLOSED IN A TRIANGULAR BORDER WITH BLUE BACKGROUND.

FOR POLYMER CLAY FIGURINES (U.S. CLS. 2, 13, 22, 25, 32 AND 50).

FIRST USE 6-3-2000; IN COMMERCE 9-3-2003.
SALLY SHIH, EXAMINING ATTORNEY

SN 77-564,588. DOUGLAS, SUSAN, SCOTTSDALE, AZ.
FILED 9-8-2008.

Treasure Your Teeth

THE MARK CONSISTS OF STANDARD CHARACTERS WITHOUT CLAIM TO ANY PARTICULAR FONT, STYLE, SIZE, OR COLOR.

FOR PILLOWS (U.S. CLS. 2, 13, 22, 25, 32 AND 50).
FIRST USE 1-0-2008; IN COMMERCE 4-0-2008.
JANICE L. MCMORROW, EXAMINING ATTORNEY

SN 77-564,987. WEBER, RALPH, J., VICTOR, NY. FILED 9-8-2008.

invisiglide

THE MARK CONSISTS OF STANDARD CHARACTERS WITHOUT CLAIM TO ANY PARTICULAR FONT, STYLE, SIZE, OR COLOR.

FOR CABINET DOORS FOR FURNITURE CABINETS; CABINETS; MEDICINE CABINETS; MIRRORED CABINETS (U.S. CLS. 2, 13, 22, 25, 32 AND 50).

BARBARA RUTLAND, EXAMINING ATTORNEY

CLASS 20—(Continued).

SN 77-565,659. LA-Z-BOY INCORPORATED, MONROE, MI. FILED 9-9-2008.

ROSECROFT

THE MARK CONSISTS OF STANDARD CHARACTERS WITHOUT CLAIM TO ANY PARTICULAR FONT, STYLE, SIZE, OR COLOR.

FOR FURNITURE (U.S. CLS. 2, 13, 22, 25, 32 AND 50). ALLISON HALL, EXAMINING ATTORNEY

SN 77-565,836. FLY BY NIGHT, INC., NORTHAMPTON, MA. FILED 9-9-2008.

GREEN SPRINGS

NO CLAIM IS MADE TO THE EXCLUSIVE RIGHT TO USE "GREEN SPRINGS", APART FROM THE MARK AS SHOWN.

THE MARK CONSISTS OF THE WORDS "GREEN SPRINGS" WITH THE FIRST "S" OF "SPRINGS" LARGER AND STYLIZED TO RESEMBLE A SPRING.

FOR SLEEP PRODUCTS, NAMELY, MATTRESSES, SPRING MATTRESSES, PILLOWS AND MATTRESS FOUNDATIONS MADE WITH NATURAL MATERIALS (U.S. CLS. 2, 13, 22, 25, 32 AND 50).

FIRST USE 4-16-2008; IN COMMERCE 4-16-2008. ROBIN CHOSID, EXAMINING ATTORNEY

SN 77-565,965. CAMBRIA COVE LLC, TOPKEA, KS. FILED 9-9-2008.

CAMBRIA COVE

THE MARK CONSISTS OF STANDARD CHARACTERS WITHOUT CLAIM TO ANY PARTICULAR FONT, STYLE, SIZE, OR COLOR.

FOR PICTURE AND PHOTOGRAPH FRAMES (U.S. CLS. 2, 13, 22, 25, 32 AND 50).

ANGELA M. MICHELI, EXAMINING ATTORNEY

CLASS 20—(Continued).

SN 77-566,627. INTERNATIONAL TRADE ASSOCIATES, INC., DBA ITA, INC., PALM COAST, FL. FILED 9-10-2008.

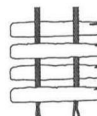

NATURE WORKS

THE MARK CONSISTS OF FOUR HORIZONTAL SLATS AND TWO CORDS WOVEN THROUGH THE SLATS ALL POSITIONED ABOVE THE WORDS "NATURE WORKS".

FOR NON-FABRIC WINDOW TREATMENTS, NAMELY, WOVEN WOOD BLINDS AND SHADES AND THEIR COMPONENT PARTS (U.S. CLS. 2, 13, 22, 25, 32 AND 50).

TRACY FLETCHER, EXAMINING ATTORNEY

SN 77-566,755. LOUISVILLE BEDDING COMPANY, LOUISVILLE, KY. FILED 9-10-2008.

MUSEUM

THE MARK CONSISTS OF STANDARD CHARACTERS WITHOUT CLAIM TO ANY PARTICULAR FONT, STYLE, SIZE, OR COLOR.

FOR PILLOWS, FOAM PILLOWS (U.S. CLS. 2, 13, 22, 25, 32 AND 50).

LURIE KAUFMAN, EXAMINING ATTORNEY

SN 77-567,219. OBRIEN, ALEXEI, LOS ANGELES, CA. FILED 9-10-2008.

FLESH TO STONE

THE MARK CONSISTS OF STANDARD CHARACTERS WITHOUT CLAIM TO ANY PARTICULAR FONT, STYLE, SIZE, OR COLOR.

FOR PLASTIC SCULPTURES (U.S. CLS. 2, 13, 22, 25, 32 AND 50).

ELISSA GARBER KON, EXAMINING ATTORNEY

CLASS 20—(Continued).

SN 77-567,320. ANN THOMPSON, GULF BREEZE, FL. FILED 9-11-2008.

CLASS 20—(Continued).

SN 77-588,513. LOUISVILLE BEDDING COMPANY, LOUISVILLE, KY. FILED 10-8-2008.

BOA

THE NIGHT IS YOUR CANVAS

THE MARK CONSISTS OF STANDARD CHARACTERS WITHOUT CLAIM TO ANY PARTICULAR FONT, STYLE, SIZE, OR COLOR.

FOR BEDS, MATTRESSES, PILLOWS AND BOLSTERS (U.S. CLS. 2, 13, 22, 25, 32 AND 50).

GEOFFREY FOSDICK, EXAMINING ATTORNEY

THE MARK CONSISTS OF STANDARD CHARACTERS WITHOUT CLAIM TO ANY PARTICULAR FONT, STYLE, SIZE, OR COLOR.

FOR PILLOWS, FOAM PILLOWS (U.S. CLS. 2, 13, 22, 25, 32 AND 50).

LAURIE KAUFMAN, EXAMINING ATTORNEY

SN 77-568,036. BELL'O INTERNATIONAL CORP., MORGANVILLE, NJ. FILED 9-11-2008.

SN 77-590,512. LOUISVILLE BEDDING COMPANY, LOUISVILLE, KY. FILED 10-10-2008.

TRIPLE PLAY

YOUR MUSE AWAITS

THE MARK CONSISTS OF STANDARD CHARACTERS WITHOUT CLAIM TO ANY PARTICULAR FONT, STYLE, SIZE, OR COLOR.

FOR FURNITURE, NAMELY, FURNITURE FOR AUDIO AND VIDEO EQUIPMENT AND FOR HOME THEATER SYSTEMS; HOME OFFICE FURNITURE (U.S. CLS. 2, 13, 22, 25, 32 AND 50).

KEVON CHISOLM, EXAMINING ATTORNEY

THE MARK CONSISTS OF STANDARD CHARACTERS WITHOUT CLAIM TO ANY PARTICULAR FONT, STYLE, SIZE, OR COLOR.

FOR PILLOWS, FOAM PILLOWS (U.S. CLS. 2, 13, 22, 25, 32 AND 50).

LAURIE KAUFMAN, EXAMINING ATTORNEY

SN 77-576,554. ELECTRONIC IMAGING MATERIALS, INC., KEENE, NH. FILED 9-23-2008.

SN 77-590,524. LOUISVILLE BEDDING COMPANY, LOUISVILLE, KY. FILED 10-10-2008.

EIMINC

TONIGHT AND EVERY NIGHT, YOUR MUSE AWAITS

THE MARK CONSISTS OF STANDARD CHARACTERS WITHOUT CLAIM TO ANY PARTICULAR FONT, STYLE, SIZE, OR COLOR.

FOR PLASTIC LABELS (U.S. CLS. 2, 13, 22, 25, 32 AND 50).

THEODORE MCBRIDE, EXAMINING ATTORNEY

THE MARK CONSISTS OF STANDARD CHARACTERS WITHOUT CLAIM TO ANY PARTICULAR FONT, STYLE, SIZE, OR COLOR.

FOR PILLOWS, FOAM PILLOWS (U.S. CLS. 2, 13, 22, 25, 32 AND 50).

LAURIE KAUFMAN, EXAMINING ATTORNEY

CLASS 21—HOUSEWARES AND GLASS

SN 77-179,692. PETIT JEAN ENTERPRISES INC., HOCKLEY, TX. FILED 5-13-2007.

TORTILLAWAVE

THE MARK CONSISTS OF STANDARD CHARACTERS WITHOUT CLAIM TO ANY PARTICULAR FONT, STYLE, SIZE, OR COLOR.

FOR COOKWARE IN THE NATURE OF PLASTIC FOOD CONTAINERS AND SEPARATORS THEREFOR FOR USE IN A MICROWAVE (U.S. CLS. 2, 13, 23, 29, 30, 33, 40 AND 50).

FIRST USE 5-4-2007; IN COMMERCE 5-4-2007.
RON FAIRBANKS, EXAMINING ATTORNEY

SN 77-234,422. MEASUREMENT LTD., GRAND CAYMAN, CAYMAN ISLANDS, FILED 7-20-2007.

SEASON TICKET

THE MARK CONSISTS OF STANDARD CHARACTERS WITHOUT CLAIM TO ANY PARTICULAR FONT, STYLE, SIZE, OR COLOR.

FOR A KIT IN THE NATURE OF A PORTABLE PICNIC OR GRILLING SET COMPOSED PRIMARILY OF A PORTABLE COOLER BAG WITH STORAGE COMPARTMENTS AND ALSO CONTAINING GRILLING IMPLEMENTS, IN THE NATURE OF SPATULAS, GRILL BRUSHES, TONGS, FORKS, TURNERS AND BASTING BRUSHES, A FOLDING TABLE, PLASTIC FOOD STORAGE CONTAINERS, PLASTIC SERVING TRAY, AND CLOTH TOWELS (U.S. CLS. 2, 13, 23, 29, 30, 33, 40 AND 50).

STEPHEN AQUILA, EXAMINING ATTORNEY

SN 77-388,274. HAMLIN, GREG, NORTHRIDGE, CA. FILED 2-4-2008.

CODYAK COOL

THE MARK CONSISTS OF STANDARD CHARACTERS WITHOUT CLAIM TO ANY PARTICULAR FONT, STYLE, SIZE, OR COLOR.

FOR PORTABLE BEVERAGE COOLERS, PORTABLE BEVERAGE DISPENSERS, PORTABLE ICE CHESTS FOR FOOD AND BEVERAGES, ALL-PURPOSE PORTABLE HOUSEHOLD CONTAINERS (U.S. CLS. 2, 13, 23, 29, 30, 33, 40 AND 50).

PATRICIA EVANKO, EXAMINING ATTORNEY

CLASS 21—(Continued).

SN 77-393,699. TODD, JASON, FISHERS, IN. FILED 2-11-2008.

EZ EMPTY

THE MARK CONSISTS OF STANDARD CHARACTERS WITHOUT CLAIM TO ANY PARTICULAR FONT, STYLE, SIZE, OR COLOR.

FOR TRASH CANS (U.S. CLS. 2, 13, 23, 29, 30, 33, 40 AND 50).

KAREN K. BUSH, EXAMINING ATTORNEY

SN 77-406,407. GRAHAM LOWE, BEXLEY, OH. FILED 2-26-2008.

COOLECTIBLE

THE MARK CONSISTS OF STANDARD CHARACTERS WITHOUT CLAIM TO ANY PARTICULAR FONT, STYLE, SIZE, OR COLOR.

FOR INSULATING SLEEVE HOLDERS HAVING THE APPEARANCE OF TIRES AND USED FOR HOLDING BEVERAGE CANS AND BOTTLES (U.S. CLS. 2, 13, 23, 29, 30, 33, 40 AND 50).

PAM WILLIS, EXAMINING ATTORNEY

SN 77-410,471. PATRICIA HERZOG-MESROBIAN, MEQUON, WI. FILED S.R. 2-29-2008; AM. P.R. 12-10-2008.

Pot Sox

THE MARK CONSISTS OF STANDARD CHARACTERS WITHOUT CLAIM TO ANY PARTICULAR FONT, STYLE, SIZE, OR COLOR.

NO CLAIM IS MADE TO THE EXCLUSIVE RIGHT TO USE "POT", APART FROM THE MARK AS SHOWN.

FOR DECORATIVE FITTED COVERS FOR FLOWER POTS, NOT MADE OF PAPER (U.S. CLS. 2, 13, 23, 29, 30, 33, 40 AND 50).

FIRST USE 2-6-1995; IN COMMERCE 2-6-1995.

JASON LOTT, EXAMINING ATTORNEY

CLASS 21—(Continued).

SN 77-411,382. IGLOO PRODUCTS CORP., KATY, TX. FILED 3-3-2008.

ULTRATHERM

THE MARK CONSISTS OF STANDARD CHARACTERS WITHOUT CLAIM TO ANY PARTICULAR FONT, STYLE, SIZE, OR COLOR.

FOR FOAM INSULATION SOLD AS A COMPONENT PART OF PORTABLE ICE CHESTS (U.S. CLS. 2, 13, 23, 29, 30, 33, 40 AND 50).

FIRST USE 9-11-1986; IN COMMERCE 9-11-1986. APRIL HESIK, EXAMINING ATTORNEY

SN 77-411,471. CHEMJET TRADING PTY. LTD., MORAYFIELD, AUSTRALIA, FILED 3-3-2008.

CHEMJET

THE MARK CONSISTS OF STANDARD CHARACTERS WITHOUT CLAIM TO ANY PARTICULAR FONT, STYLE, SIZE, OR COLOR.

OWNER OF AUSTRALIA REG. NO. A464195, DATED 4-29-1987. RENEWED AS REG. NO. A464195, DATED 4-29-2008, EXPIRES 4-29-2018.

FOR SYRINGES FOR AGRICULTURAL PURPOSES, NAMELY, FLOWER SYRINGES, GARDEN SYRINGES, GREENHOUSE SYRINGES AND PLANT SYRINGES (U.S. CLS. 2, 13, 23, 29, 30, 33, 40 AND 50).

HANNO RITTNER, EXAMINING ATTORNEY

SN 77-424,387. NORWOOD OPERATING COMPANY, LLC, INDIANAPOLIS, IN. FILED 3-17-2008.

COASTER WEIGHT

THE MARK CONSISTS OF STANDARD CHARACTERS WITHOUT CLAIM TO ANY PARTICULAR FONT, STYLE, SIZE, OR COLOR.

NO CLAIM IS MADE TO THE EXCLUSIVE RIGHT TO USE "COASTER", APART FROM THE MARK AS SHOWN. FOR COASTERS NOT OF PAPER AND NOT BEING TABLE LINEN (U.S. CLS. 2, 13, 23, 29, 30, 33, 40 AND 50).

FIRST USE 1-1-2002; IN COMMERCE 1-1-2002. MARK SPARACINO, EXAMINING ATTORNEY

CLASS 21—(Continued).

SN 77-434,032. KING RANCH IP, LLC, WILMINGTON, DE. FILED 3-28-2008.

KING RANCH

THE MARK CONSISTS OF STANDARD CHARACTERS WITHOUT CLAIM TO ANY PARTICULAR FONT, STYLE, SIZE, OR COLOR.

OWNER OF U.S. REG. NOS. 2,370,689, 2,678,141 AND 2,681,196.

FOR DECANTERS; CUTTING BOARDS; DRINKING FLASKS; WINE BOTTLE CRADLES; VASES; WASTE-BASKETS; BACK SCRATCHERS; PORTABLE BEVERAGE DISPENSERS; DISHES; BUTTER DISHES; SERVING DISHES; TRAVEL MUGS, NAMELY, THERMAL INSULATED CONTAINERS FOR BEVERAGES; DECANTERS; BATH ACCESSORIES, NAMELY, TOWEL RINGS AND RAILS, CERAMIC TISSUE BOX COVERS, TOILET PAPER HOLDERS, SOAP DISHES, CUP HOLDERS, AND DISPENSERS FOR LIQUID SOAP, NAMELY, SOAP PUMPS (U.S. CLS. 2, 13, 23, 29, 30, 33, 40 AND 50).

FIRST USE 5-21-2002; IN COMMERCE 5-21-2002. THOMAS MANOR, EXAMINING ATTORNEY

SN 77-434,033. KING RANCH IP, LLC, WILMINGTON, DE. FILED 3-28-2008.



OWNER OF U.S. REG. NOS. 3,049,538, 3,271,225 AND 3,361,673.

FOR DECANTERS; CUTTING BOARDS; DRINKING FLASKS; WINE BOTTLE CRADLES; VASES; WASTE-BASKETS; BACK SCRATCHERS; PORTABLE BEVERAGE DISPENSERS; DISHES; BUTTER DISHES; SERVING DISHES; TRAVEL MUGS, NAMELY, THERMAL INSULATED CONTAINERS FOR BEVERAGES; DECANTERS; BATH ACCESSORIES, NAMELY, TOWEL RINGS AND RAILS, CERAMIC TISSUE BOX COVERS, TOILET PAPER HOLDERS, SOAP DISHES, CUP HOLDERS, AND DISPENSERS FOR LIQUID SOAP, NAMELY, SOAP PUMPS (U.S. CLS. 2, 13, 23, 29, 30, 33, 40 AND 50).

FIRST USE 5-21-2002; IN COMMERCE 5-21-2002. THOMAS MANOR, EXAMINING ATTORNEY

CLASS 21—(Continued).

SN 77-452,892. LB BRANDS, LLC, PORT CLYDE, ME. FILED 4-20-2008.

IN A CLASS BY ITSELF

THE MARK CONSISTS OF STANDARD CHARACTERS WITHOUT CLAIM TO ANY PARTICULAR FONT, STYLE, SIZE, OR COLOR.

FOR MUGS; DISHES; TRIVETS; HOUSEHOLD UTENSILS, NAMELY, LOBSTER SERVING FORKS (U.S. CLS. 2, 13, 23, 29, 30, 33, 40 AND 50).

TINA BROWN, EXAMINING ATTORNEY

SN 77-453,649. LB BRANDS, LLC, PORT CLYDE, ME. FILED 4-21-2008.

LINDA BEAN'S PERFECT MAINE

THE MARK CONSISTS OF STANDARD CHARACTERS WITHOUT CLAIM TO ANY PARTICULAR FONT, STYLE, SIZE, OR COLOR.

NO CLAIM IS MADE TO THE EXCLUSIVE RIGHT TO USE "MAINE", APART FROM THE MARK AS SHOWN.

THE NAME(S), PORTRAIT(S), AND/OR SIGNATURE(S) SHOWN IN THE MARK IDENTIFIES LINDA L. BEAN, WHOSE CONSENT(S) TO REGISTER IS SUBMITTED.

FOR MUGS, DISHES, TRIVETS, HOUSEHOLD UTENSILS, NAMELY, LOBSTER EATING CRACKERS AND FORKS (U.S. CLS. 2, 13, 23, 29, 30, 33, 40 AND 50).

TIMOTHY FINNEGAN, EXAMINING ATTORNEY

CLASS 21—(Continued).

SN 77-468,365. FITZ AND FLOYD, INC., LEWISVILLE, TX. FILED 5-7-2008.

DEL VINO

THE MARK CONSISTS OF STANDARD CHARACTERS WITHOUT CLAIM TO ANY PARTICULAR FONT, STYLE, SIZE, OR COLOR.

THE ENGLISH TRANSLATION OF "DEL VINO" IS FROM THE WINE.

FOR DINNERWARE NOT OF PRECIOUS METAL, NAMELY, CHARGER PLATES, DINNER PLATES, SALAD PLATES, CANAPE PLATES, PARTY PLATES, CEREAL AND SOUP BOWLS, PASTA BOWLS, CUPS, SAUCERS, MUGS, COVERED VEGETABLE POTS, SERVING PLATTERS, SERVING BOWLS, SERVING LADLES, PITCHERS, SERVING DISHES FOR CONDIMENTS, PICKLES, AND OLIVES, CRUET SETS WITH DIPPING DISHES, TUREENS, SUGAR BOWLS, CREAM PITCHERS, SALT AND PEPPER SHAKERS, CUP AND SAUCER SETS, EGG DISHES, CHEESE TRAYS, BREAD TRAYS, SERVING TRAYS, CANDLE HOLDERS, VASES, HURRICANE CANDLE HOLDERS, PASTA JARS, CERAMIC SPOON RESTS; AND CERAMIC FIGURINES (U.S. CLS. 2, 13, 23, 29, 30, 33, 40 AND 50).

FIRST USE 6-1-2006; IN COMMERCE 6-1-2006.

JEFF DEFORD, EXAMINING ATTORNEY

SN 77-497,097. APCO GRAPHICS, INC., ATLANTA, GA. FILED 6-12-2008.

HEALTHPOINT

THE MARK CONSISTS OF STANDARD CHARACTERS WITHOUT CLAIM TO ANY PARTICULAR FONT, STYLE, SIZE, OR COLOR.

FOR DISPENSERS FOR INFECTION CONTROL PRODUCTS IN THE NATURE OF DISINFECTING SOLUTION, TOWELS, MEDICAL GLOVES, HAND SANITIZING FOAM, HAND SANITIZING GEL, HAND SANITIZING WIPES, MEDICAL FACE MASKS AND FACIAL TISSUES (U.S. CLS. 2, 13, 23, 29, 30, 33, 40 AND 50).

FIRST USE 5-21-2008; IN COMMERCE 6-3-2008.

KALIE KUNG, EXAMINING ATTORNEY

CLASS 21—(Continued).

SN 77-517,125. THE CUYAHOGA RIVER COMMUNITY PLANNING ORGANIZATION, CLEVELAND, OH. FILED 7-8-2008.

CHUB

THE MARK CONSISTS OF STANDARD CHARACTERS WITHOUT CLAIM TO ANY PARTICULAR FONT, STYLE, SIZE, OR COLOR.

FOR AQUATIC HABITAT SYSTEMS COMPRISED OF MOLDED, RUBBER BASKETS ADAPTED TO CONTAIN GROWING PLANTS AND AQUATIC PLANTS AND THE EQUIPMENT FOR AFFIXING THE BASKETS TO WATERWAY EMBANKMENTS (U.S. CLS. 2, 13, 23, 29, 30, 33, 40 AND 50).

FIRST USE 6-30-2008; IN COMMERCE 6-30-2008.
KATINA MISTER, EXAMINING ATTORNEY

CLASS 21—(Continued).

SN 77-540,475. HAUTE HOME, LLC, SAN FRANCISCO, CA. FILED 8-6-2008.

HAUTE HOME

THE MARK CONSISTS OF STANDARD CHARACTERS WITHOUT CLAIM TO ANY PARTICULAR FONT, STYLE, SIZE, OR COLOR.

NO CLAIM IS MADE TO THE EXCLUSIVE RIGHT TO USE "HOME", APART FROM THE MARK AS SHOWN.

FOR BASKETS OF WICKER; CERAMIC SCULPTURES, VASES, VESSELS, BOWLS, PLATES AND POTS; COFFEE POTS NOT OF PRECIOUS METAL; DECORATIVE PLATES; DINNERWARE, NAMELY, PLATES, CUPS AND SAUCERS; DISHES AND PLATES; NAPKIN HOLDERS; NAPKIN RINGS; ORNAMENTS OF EMBROIDERED TEXTILES; PLANTERS FOR FLOWERS AND PLANTS; SOAP DISHES; TEA POTS NOT OF PRECIOUS METAL; TRASH CANS; TRASH CONTAINERS FOR HOUSEHOLD USE; TRAYS FOR DOMESTIC PURPOSES; VASES; WASTE BASKETS (U.S. CLS. 2, 13, 23, 29, 30, 33, 40 AND 50).

FIRST USE 5-1-2000; IN COMMERCE 5-1-2000.
JOHN DALIER, EXAMINING ATTORNEY

SN 77-532,290. TAI YEUNG PORCELAIN INDUSTRIES LTD., INC., DBA BISQUE HAUS, CHARLOTTE, NC. FILED 7-27-2008.



THE COLOR(S) BLACK AND ORANGE IS/ARE CLAIMED AS A FEATURE OF THE MARK.

THE MARK CONSISTS OF THE BLACK, STYLIZED WORDING "BISQUEHAUS", WITH THE LETTER "H" REPRESENTED BY AN ORANGE STYLIZED HOUSE DESIGN.

FOR CERAMIC FIGURINES; CERAMIC SCULPTURES, VASES, VESSELS, BOWLS, PLATES AND POTS; HOLIDAY ORNAMENTS OF CERAMIC (U.S. CLS. 2, 13, 23, 29, 30, 33, 40 AND 50).

FIRST USE 11-7-2006; IN COMMERCE 11-7-2006.
JULIE VEPPUMTHARA, EXAMINING ATTORNEY

SN 77-559,357. KENKUT INC, PETALUMA, CA. FILED 8-29-2008.

KENKUT

THE MARK CONSISTS OF STANDARD CHARACTERS WITHOUT CLAIM TO ANY PARTICULAR FONT, STYLE, SIZE, OR COLOR.

FOR DISPENSERS FOR PLASTIC FILM, PLASTIC WRAP, AND ALUMINUM FOIL (U.S. CLS. 2, 13, 23, 29, 30, 33, 40 AND 50).

FIRST USE 3-8-1991; IN COMMERCE 3-8-1991.
CAROL SPILS, EXAMINING ATTORNEY

CLASS 21—(Continued).

SN 77-560,883. MILLS, JESSE R., DBA LIL' DINER LLC, SALT LAKE CITY, UT. FILED 9-2-2008.



THE MARK CONSISTS OF TWO CIRCLES THAT RESEMBLE A PLATE AND IN THE CENTER OF THE PLATE IS THE WORDS "LIL" DINER THE "I" OF "LIL" IS A SPOON AND THE "I" OF DINER IS A FORK.

FOR SECURING APPARATUS, COMPRISED OF A PLASTIC CLAMP AND SUCTION CUP, DESIGNED TO HOLD A DISH ONTO A TABLE OR OTHER STRUCTURE (U.S. CLS. 2, 13, 23, 29, 30, 33, 40 AND 50).

KATHLEEN LORENZO, EXAMINING ATTORNEY

SN 77-563,520. MICHELE MANN, CINCINNATI, OH. FILED 9-5-2008.

DRIFORM

THE MARK CONSISTS OF STANDARD CHARACTERS WITHOUT CLAIM TO ANY PARTICULAR FONT, STYLE, SIZE, OR COLOR.

FOR CLOTHES HANGERS IN THE NATURE OF FRAMES FOR DRYING AND MAINTAINING THE SHAPE OF BRASSIERE CUPS (U.S. CLS. 2, 13, 23, 29, 30, 33, 40 AND 50).

JOHN DALIER, EXAMINING ATTORNEY

SN 77-563,526. RIVARD CONTRACTING, INC., DBA CENTRAL WOOD PRODUCTS, EAST BETHEL, MN. FILED 9-5-2008.

ERGRONOMIX

THE MARK CONSISTS OF STANDARD CHARACTERS WITHOUT CLAIM TO ANY PARTICULAR FONT, STYLE, SIZE, OR COLOR.

FOR PLANTERS FOR FLOWERS AND PLANTS (U.S. CLS. 2, 13, 23, 29, 30, 33, 40 AND 50).

KATHERINE E. HALMEN, EXAMINING ATTORNEY

CLASS 21—(Continued).

SN 77-563,574. THERMOS L.L.C., ROLLING MEADOWS, IL. FILED 9-5-2008.

Intāk

THE MARK CONSISTS OF STANDARD CHARACTERS WITHOUT CLAIM TO ANY PARTICULAR FONT, STYLE, SIZE, OR COLOR.

FOR THERMALLY INSULATED AND NON-INSULATED BEVERAGE CONTAINERS (U.S. CLS. 2, 13, 23, 29, 30, 33, 40 AND 50).

FIRST USE 8-25-2008; IN COMMERCE 8-25-2008.

JOHN WILKE, EXAMINING ATTORNEY

SN 77-563,601. LFL INVESTMENTS, LLC, WINDERMERE, FL. FILED 9-5-2008.

HAIRPRO

THE MARK CONSISTS OF STANDARD CHARACTERS WITHOUT CLAIM TO ANY PARTICULAR FONT, STYLE, SIZE, OR COLOR.

FOR HAIR BRUSHES (U.S. CLS. 2, 13, 23, 29, 30, 33, 40 AND 50).

FIRST USE 6-23-2004; IN COMMERCE 6-23-2004.

GISELLE AGOSTO, EXAMINING ATTORNEY

SN 77-564,209. NAMBE LLC, SANTA FE, NM. FILED 9-8-2008.

HERITAGE BY NAMBE

THE MARK CONSISTS OF STANDARD CHARACTERS WITHOUT CLAIM TO ANY PARTICULAR FONT, STYLE, SIZE, OR COLOR.

OWNER OF U.S. REG. NOS. 1,704,524 AND 1,975,856.

THE WORD "NAMBE" HAS NO MEANING IN A FOREIGN LANGUAGE.

FOR BOWLS; CANDLE HOLDERS; COCKTAIL PICKS; COCKTAIL SHAKERS; COCKTAIL STIRRERS; CUPS AND MUGS; DISHES AND PLATES; FLOWER VASES AND BOWLS; HOLDER FOR CUTTING BOARD; ICE BUCKETS; PILLAR CANDLE PLATES; SERVING DISHES; SERVING FORKS; SERVING LADLES; SERVING PLATTERS; SERVING SPOONS; SERVING TONGS; SERVING TRAYS (U.S. CLS. 2, 13, 23, 29, 30, 33, 40 AND 50).

KATHY DE JONGE, EXAMINING ATTORNEY

CLASS 21—(Continued).

SN 77-564,471. JACOBS, MARYANN, BRONX, NY. AND JACOBS, WILLIAM, BRONX, NY. FILED 9-8-2008.

Don't look down on anyone,
unless you are helping them
up

THE MARK CONSISTS OF STANDARD CHARACTERS WITHOUT CLAIM TO ANY PARTICULAR FONT, STYLE, SIZE, OR COLOR.
FOR MUGS (U.S. CLS. 2, 13, 23, 29, 30, 33, 40 AND 50).
HEATHER THOMPSON, EXAMINING ATTORNEY

SN 77-564,548. SMD TRADING CO., LTD, IRVINE, CA. FILED 9-8-2008.

CPLA

THE MARK CONSISTS OF STANDARD CHARACTERS WITHOUT CLAIM TO ANY PARTICULAR FONT, STYLE, SIZE, OR COLOR.
FOR BIODEGRADABLE, MICROWAVEABLE DINERWARE, NAMELY, MEAL TRAYS, LUNCH BOX TRAYS, BOWLS, MUGS, PLATES, COMPARTMENT PLATES AND LIDS (U.S. CLS. 2, 13, 23, 29, 30, 33, 40 AND 50).
FIRST USE 5-30-2008; IN COMMERCE 5-30-2008.
KIMBERLY PERRY, EXAMINING ATTORNEY

SN 77-565,394. SHAW, GARRETT, FAIR OAKS, CA. FILED 9-9-2008.



THE MARK CONSISTS OF THE STYLIZED WORD "AGROWPOTS". THE STYLIZED WORD IS UNDERLINED. TO THE LEFT OF THE STYLIZED WORD IS A HALF CIRCLE WITH AN IMAGE OF A PLANT SPROUTING. THE ROOTS ARE BELOW THE THIN LINE.
FOR RECYCLED PLASTIC PLANTERS AND HOLDERS FOR PLANTS AND TREES (U.S. CLS. 2, 13, 23, 29, 30, 33, 40 AND 50).
ZHALEH DELANEY, EXAMINING ATTORNEY

CLASS 21—(Continued).

SN 77-565,600. GOOD IDEA, LLC, CINCINNATI, OH. FILED 9-9-2008.

KEEP IT TIDY - K.I.T.

THE MARK CONSISTS OF STANDARD CHARACTERS WITHOUT CLAIM TO ANY PARTICULAR FONT, STYLE, SIZE, OR COLOR.
FOR DISPOSABLE PLASTIC GLOVES FOR USE WITH FOOD PREPARATION AND HOUSEHOLD AND KITCHEN UTENSILS, NAMELY, TRASH CANS AND SCRUBBING SPONGES (U.S. CLS. 2, 13, 23, 29, 30, 33, 40 AND 50).
DANNEAN HETZEL, EXAMINING ATTORNEY

SN 77-565,884. FERGUSON ENTERPRISES, INC., NEWPORT NEWS, VA. FILED 9-9-2008.

CORDOBA

THE MARK CONSISTS OF STANDARD CHARACTERS WITHOUT CLAIM TO ANY PARTICULAR FONT, STYLE, SIZE, OR COLOR.
OWNER OF U.S. REG. NO. 3,535,254.
FOR BATHROOM ACCESSORIES, NAMELY, TOWEL BARS, TOWEL RINGS, TOILET TISSUE HOLDERS, CUP HOLDERS, TOOTHBRUSH HOLDERS, SOAP DISHES AND SOAP DISPENSERS (U.S. CLS. 2, 13, 23, 29, 30, 33, 40 AND 50).
KELLY BOULTON, EXAMINING ATTORNEY

SN 77-565,901. FERGUSON ENTERPRISES, INC., NEWPORT NEWS, VA. FILED 9-9-2008.

EDENTON

THE MARK CONSISTS OF STANDARD CHARACTERS WITHOUT CLAIM TO ANY PARTICULAR FONT, STYLE, SIZE, OR COLOR.
FOR BATHROOM ACCESSORIES, NAMELY, TOWEL BARS, TOWEL RINGS, TOILET TISSUE HOLDERS, CUP HOLDERS, TOOTHBRUSH HOLDERS, SOAP DISHES AND SOAP DISPENSERS (U.S. CLS. 2, 13, 23, 29, 30, 33, 40 AND 50).
KELLY BOULTON, EXAMINING ATTORNEY

CLASS 21—(Continued).

SN 77-565,914. FERGUSON ENTERPRISES, INC., NEWPORT NEWS, VA. FILED 9-9-2008.

KEY WEST

THE MARK CONSISTS OF STANDARD CHARACTERS WITHOUT CLAIM TO ANY PARTICULAR FONT, STYLE, SIZE, OR COLOR.

FOR BATHROOM ACCESSORIES, NAMELY, TOWEL BARS, TOWEL RINGS, TOILET TISSUE HOLDERS, CUP HOLDERS, TOOTHBRUSH HOLDERS, SOAP DISHES AND SOAP DISPENSERS (U.S. CLS. 2, 13, 23, 29, 30, 33, 40 AND 50).

KELLY BOULTON, EXAMINING ATTORNEY

SN 77-567,076. PRESENCE OF NATURE THE ORIGINAL ECOBOWL COMPANY, LLC, BIDDEFORD, ME. FILED 9-10-2008.

ecoBowl

THE MARK CONSISTS OF STANDARD CHARACTERS WITHOUT CLAIM TO ANY PARTICULAR FONT, STYLE, SIZE, OR COLOR.

FOR HAND-CRAFTED DECORATIVE AND GIFT BOWLS MADE FROM BEESWAX (U.S. CLS. 2, 13, 23, 29, 30, 33, 40 AND 50).

GILBERT SWIFT, EXAMINING ATTORNEY

SN 77-570,034. HEB GROCERY COMPANY, L.P., SAN ANTONIO, TX. FILED 9-15-2008.

OUTDOORSOLUTIONS

THE MARK CONSISTS OF STANDARD CHARACTERS WITHOUT CLAIM TO ANY PARTICULAR FONT, STYLE, SIZE, OR COLOR.

OWNER OF U.S. REG. NOS. 3,344,939 AND 3,524,671. FOR HOSE NOZZLES; LAWN SPRINKLERS; PLANT AND FLOWER POTS; GARDENING GLOVES; WORK GLOVES (U.S. CLS. 2, 13, 23, 29, 30, 33, 40 AND 50).

BARNEY CHARLON, EXAMINING ATTORNEY

CLASS 21—(Continued).

SN 77-571,371. PROCREATE INC., ANACORTES, WA. FILED 9-16-2008.

BREWISTA

THE MARK CONSISTS OF STANDARD CHARACTERS WITHOUT CLAIM TO ANY PARTICULAR FONT, STYLE, SIZE, OR COLOR.

FOR NON-ELECTRIC BREWING DEVICES FOR COFFEE, TEA AND/OR ESPRESSO (U.S. CLS. 2, 13, 23, 29, 30, 33, 40 AND 50).

JACQUELINE A. LAVINE, EXAMINING ATTORNEY

SN 77-582,503. PURICLE, INC., RANCHO CUCAMONGA, CA. FILED 9-30-2008.

NEVER SCRUB

THE MARK CONSISTS OF STANDARD CHARACTERS WITHOUT CLAIM TO ANY PARTICULAR FONT, STYLE, SIZE, OR COLOR.

OWNER OF U.S. REG. NO. 2,765,908.

SEC. 2(F).

FOR TOILET BOWL CLEANING APPARATUS ADAPTED FOR MOUNTING WITHIN THE TANK OF THE TOILET AND OPERATIVE TO PERIODICALLY DISPENSE CLEANER INTO THE TOILET BOWL OF THE TOILET (U.S. CLS. 2, 13, 23, 29, 30, 33, 40 AND 50).

FIRST USE 12-0-1999; IN COMMERCE 6-0-2000.

RAUL CORDOVA, EXAMINING ATTORNEY

SN 77-621,920. PRESENCE OF NATURE THE ORIGINAL ECOBOWL COMPANY, LLC, BIDDEFORD, ME. FILED 11-25-2008.

enviroBowl

THE MARK CONSISTS OF STANDARD CHARACTERS WITHOUT CLAIM TO ANY PARTICULAR FONT, STYLE, SIZE, OR COLOR.

FOR HAND-CRAFTED DECORATIVE AND GIFT BOWLS MADE FROM BEESWAX (U.S. CLS. 2, 13, 23, 29, 30, 33, 40 AND 50).

GILBERT SWIFT, EXAMINING ATTORNEY

CLASS 21—(Continued).

SN 77-626,350. JOHNSON & JOHNSON, NEW BRUNSWICK, NJ. FILED 12-4-2008.

LISTERINE

THE MARK CONSISTS OF STANDARD CHARACTERS WITHOUT CLAIM TO ANY PARTICULAR FONT, STYLE, SIZE, OR COLOR.

OWNER OF U.S. REG. NOS. 41,413, 85,150 AND OTHERS. FOR TOOTHBRUSHES, DENTAL FLOSS AND DENTAL FLOSSERS (U.S. CLS. 2, 13, 23, 29, 30, 33, 40 AND 50).

FLORENTINA BLANDU, EXAMINING ATTORNEY

SN 78-779,325. PARAMOUNT INTERNATIONAL EXPORT, LTD., LOS ANGELES, CA. FILED 12-22-2005.

SIGNATURE SLEEVE

THE MARK CONSISTS OF STANDARD CHARACTERS WITHOUT CLAIM TO ANY PARTICULAR FONT, STYLE, SIZE, OR COLOR.

NO CLAIM IS MADE TO THE EXCLUSIVE RIGHT TO USE "SLEEVE", APART FROM THE MARK AS SHOWN.

FOR DECORATIVE HOLDERS, NAMELY, METAL COASTERS, FOR BEVERAGE CANS, BOTTLES, AND CUPS (U.S. CLS. 2, 13, 23, 29, 30, 33, 40 AND 50).

RUSS HERMAN, EXAMINING ATTORNEY

CLASS 21—(Continued).

SN 79-041,920. PASABAHÇE; SANAYI VE TICARET ANONİM ŞİRKETİ, TR-34330 İSTANBUL, TURKEY, FILED 3-7-2007.



PRIORITY DATE OF 1-26-2007 IS CLAIMED.

OWNER OF INTERNATIONAL REGISTRATION 0932836 DATED 3-7-2007. EXPIRES 3-7-2017.

FOR HOUSEHOLD OR KITCHEN UTENSILS, NAMELY, GRATERS, SIEVES, SPATULAS, STRAINERS, WHISKS, ROLLING PINS, SERVING FORKS; NON-ELECTRIC KITCHEN MIXERS, NAMELY, MIXING SPOONS; NON-ELECTRIC COCKTAIL SHAKERS; HAND-OPERATED COFFEE AND SPICE GRINDERS; HAND-OPERATED FRUIT AND VEGETABLE PRESSES; HAND-OPERATED GRINDERS FOR GARLIC AND TEA; GRATERS FOR HOUSEHOLD PURPOSES; CLEANING APPARATUS, NAMELY, CLEANING CLOTHES, CLEANING PADS, CLEANING RAGS, STEEL WOOL, PRE-MOISTENED TOWELETTES; HOUSEHOLD AND KITCHEN UTENSILS AND EARTHENWARE, NAMELY, EARTHENWARE BUSTS, EARTHENWARE DOOR-KNOBS, EARTHENWARE MUGS; HOUSEHOLD AND KITCHEN UTENSILS AND EARTHENWARE NOT OF PRECIOUS METAL MADE OF GLASS, PLASTIC, PORCELAIN, CERAMIC AND CRYSTAL, NAMELY, TRAYS FOR DOMESTIC PURPOSES, PLATES, AND GLASSES, POTS, PANS, MUGS, BOWLS, DISHES, PLATES, CROCKERY IN THE NATURE OF POTS AND DISHES, WATER GLASSES, WINEGLASSES, GLASSES FOR BEVERAGES, CUPS, SPOTS IN THE NATURE OF COASTERS NOT OF PAPER AND NOT BEING TABLE LINEN, TEAPOTS, JUGS, VASES, COFFEE POTS, STRAINERS, NAMELY, WINE STRAINERS, TEA STRAINERS AND COOKING STRAINERS, SCOOPS, BASTING SPOONS, SPATULAS, CUPS, BOWLS, EGGCUPS, CAKE MOULDS AND DECANTERS; BUCKETS; TRASH CANS; POTS; PLATES; PAPER PLATES; GLASS TRAYS FOR DOMESTIC PURPOSES; COFFEE POTS; STRAINERS, NAMELY, WINE STRAINERS, TEA STRAINERS AND COOKING STRAINERS; SCOOPS; BASTING SPOONS FOR KITCHEN USE; BASINS; CUPS; EGG CUPS; CAKE MOLDS; DECANTERS; CONTAINERS FOR KITCHEN USE; VASES; SOAP HOLDERS; SOAP DISPENSERS; PAPER TOWEL DISPENSER; TOILET PAPER HOLDERS; ICE BUCKETS; HEAT-INSULATED CONTAINERS FOR HOUSEHOLD USE; FLASKS; FITTED PICNIC BASKETS SOLD WITH DISHES; CUPS OF PRECIOUS OR NON-PRECIOUS METALS; BREAD BINS; BREAD BASKETS; BREAD-BOARDS; COOKING UTENSILS, NAMELY, GRILLS, GRILL COVERS, WIRE BASKETS; NON-ELECTRIC COOKING POTS; NON-ELECTRIC COOKING UTENSILS NAMELY, GRILLS AND GRILL SUPPORTS; COOKING SKEWERS OF METAL, DRYING RACKS FOR WASHING, ORNAMENTS MADE OF PORCELAIN, TERRA-COTTA OR GLASS; FIGURINES MADE OF PORCELAIN, TERRA-COTTA OR GLASS; STATUES OF PORCELAIN, TERRA-COTTA OR GLASS; WORKS OF ART OF PORCELAIN, TERRA-COTTA OR GLASS; BOTTLES, NAMELY, BOTTLES, SOLD EMPTY, SAKE SERVING BOTTLES; GLASS STORAGE JARS; GLASS DEMIJOHNS SOLD EMPTY; TOILET CASES, NAMELY, TOILET BRUSH HOLDERS; PERFUME BURNERS; PERFUME SPRAYERS; PERFUME VAPORIZERS SOLD EMPTY;

CLASS 21—(Continued).

CONTAINERS FOR TOILET UTENSILS, NAMELY, TOILET BRUSH HOLDERS, TOILET TISSUE HOLDERS, TOILET SPONGE HOLDERS; CORKSCREWS; UNWORKED GLASS FOR SIGNAL LIGHTS OR HEADLIGHTS FOR VEHICLES, VEHICLE WINDOWS; SEMI-WORKED GLASS FOR SIGNAL LIGHTS OR HEADLIGHTS FOR VEHICLES, VEHICLE WINDOWS; MOSAICS FOR GLASS, NOT FOR BUILDINGS; POWDERED GLASS FOR DECORATION; GLASS WOOL NOT FOR INSULATION; FIBERGLASS OTHER THAN FOR INSULATION OR TEXTILE USE (U.S. CLS. 2, 13, 23, 29, 30, 33, 40 AND 50).

REBECCA POVARCHUK, EXAMINING ATTORNEY

SN 79-061,677. SHENZHEN SHINING SUN INDUSTRIAL CO., LTD., CHINA, FILED 8-30-2008.

DYRAMICS

OWNER OF INTERNATIONAL REGISTRATION 0983964 DATED 8-30-2008, EXPIRES 8-30-2018.

FOR BUTTER DISHES; BUTTER-DISH AND CHEESE-DISH COVERS; GLASS BOWLS; GLASS BOXES; PORCELAIN KNOBS; CHINA ORNAMENTS; STATUES OF CHINA, CRYSTAL, EARTHENWARE, GLASS, PORCELAIN; WORKS OF ART OF CHINA, CRYSTAL, EARTHENWARE, GLASS, PORCELAIN, TERRA COTTA; BUSTS OF CRYSTAL, CHINA, EARTHENWARE, GLASS, PORCELAIN; FIGURINES OF CHINA, CRYSTAL, EARTHENWARE, GLASS, PORCELAIN, TERRACOTTA (U.S. CLS. 2, 13, 23, 29, 30, 33, 40 AND 50).

JOHN DWYER, EXAMINING ATTORNEY

CLASS 22—(Continued).

SN 77-410,926. FIELD & STREAM LICENSES COMPANY, WESTPORT, CT. FILED 3-3-2008.



FIELD & STREAM
FIELD TESTED 1871 GUIDE APPROVED

OWNER OF U.S. REG. NOS. 2,442,869, 2,834,222 AND OTHERS.

NO CLAIM IS MADE TO THE EXCLUSIVE RIGHT TO USE "FIELD TESTED," "1871," AND "GUIDE APPROVED", APART FROM THE MARK AS SHOWN.

THE MARK CONSISTS OF THE DESIGN OF AN EAGLE ABOVE THE WORDING "FIELD & STREAM FIELD TESTED 1871 GUIDE APPROVED". A BROKEN HORIZONTAL LINE APPEARS BELOW THE WORDING "FIELD & STREAM" AND ABOVE THE WORDING "FIELD TESTED GUIDE APPROVED". THE NUMBER "1871" APPEARS IN THE MIDDLE OF THE BREAK IN THE LINE.

FOR TENTS FOR CAMPING, CANVAS CANOPIES (U.S. CLS. 1, 2, 7, 19, 22, 42 AND 50).

DAVID ELTON, EXAMINING ATTORNEY

CLASS 22—CORDAGE AND FIBERS

SN 76-687,459. ASHBURN-HILL CORP., ANGLETON, TX. FILED 3-7-2008.

TECGEN

THE MARK CONSISTS OF STANDARD CHARACTERS WITHOUT CLAIM TO ANY PARTICULAR FONT, STYLE, SIZE, OR COLOR.

FOR CARBONACEOUS FIBERS FOR USE IN IGNITION RESISTANT FABRICS AND CLOTHING (U.S. CLS. 1, 2, 7, 19, 22, 42 AND 50).

FIRST USE 2-1-1999; IN COMMERCE 2-1-1999.

MIDGE BUTLER, EXAMINING ATTORNEY

SN 77-554,492. MOFFETT, ERIC, EAST WINDSOR, CT. FILED 8-25-2008.



RailSak
 THINK INSIDE THE BOXCAR

THE MARK CONSISTS OF AN IMAGE OF A BULK SACK WITH THE WORDS "RAILSAK THINK INSIDE THE BOXCAR" APPEARING BELOW IT.

FOR SACKS AND BAGS FOR THE TRANSPORTATION AND STORAGE OF MATERIALS IN BULK (U.S. CLS. 1, 2, 7, 19, 22, 42 AND 50).

FRANK LATTUCA, EXAMINING ATTORNEY

CLASS 22—(Continued).

SN 77-558,851. NIKOLETE ORLANDOU, SANTA MONICA, CA. FILED 8-29-2008.

i'mecofriendly

THE MARK CONSISTS OF STANDARD CHARACTERS WITHOUT CLAIM TO ANY PARTICULAR FONT, STYLE, SIZE, OR COLOR.
 FOR MULTI-PURPOSE BAGS OF CLOTH OR HEMP (U.S. CLS. 1, 2, 7, 19, 22, 42 AND 50).
 FIRST USE 10-21-2007; IN COMMERCE 10-21-2007.
 AMY ALFIERI, EXAMINING ATTORNEY

SN 77-558,867. NIKOLETE ORLANDOU, SANTA MONICA, CA. FILED 8-29-2008.



THE MARK CONSISTS OF A STYLIZED BIRD AND FLOWER INSIDE A SHADED CIRCLE AND THE WORDING "I'MECOFRIENDLY" WITH A DROP OF WATER FORMING THE INSIDE OF THE LETTER "O".
 FOR MULTI-PURPOSE BAGS OF CLOTH OR HEMP (U.S. CLS. 1, 2, 7, 19, 22, 42 AND 50).
 FIRST USE 10-21-2007; IN COMMERCE 10-21-2007.
 AMY ALFIERI, EXAMINING ATTORNEY

SN 77-559,430. ROPE BUDDY LTD., FORMERLY 705237 ALBERTA LTD., GRANDE PRAIRIE ALBERTA, CANADA, FILED 8-29-2008.

ROPE BUDDY

THE MARK CONSISTS OF STANDARD CHARACTERS WITHOUT CLAIM TO ANY PARTICULAR FONT, STYLE, SIZE, OR COLOR.
 OWNER OF CANADA REG. NO. TMA711864, DATED 4-14-2008, EXPIRES 4-14-2023.
 NO CLAIM IS MADE TO THE EXCLUSIVE RIGHT TO USE "ROPE", APART FROM THE MARK AS SHOWN.
 FOR COILED ROPE HOLDERS, NOT OF METAL (U.S. CLS. 1, 2, 7, 19, 22, 42 AND 50).
 HAI-LY LAM, EXAMINING ATTORNEY

CLASS 22—(Continued).

SN 77-564,961. JETNET CORPORATION, SEWICKLEY, PA. FILED 9-8-2008.

JETNET

THE MARK CONSISTS OF STANDARD CHARACTERS WITHOUT CLAIM TO ANY PARTICULAR FONT, STYLE, SIZE, OR COLOR.
 OWNER OF U.S. REG. NOS. 2,052,755 AND 2,055,180.
 FOR ELASTIC NETTING FOR MEAT PRODUCTS (U.S. CLS. 1, 2, 7, 19, 22, 42 AND 50).
 FIRST USE 6-16-1965; IN COMMERCE 6-16-1965.
 JEFFREY LOOK, EXAMINING ATTORNEY

SN 77-565,797. AMERICAN ROPE MFG., INC., BURLINGTON, OK. FILED 9-9-2008.

TugRope

THE MARK CONSISTS OF STANDARD CHARACTERS WITHOUT CLAIM TO ANY PARTICULAR FONT, STYLE, SIZE, OR COLOR.
 FOR CAR TOWING ROPES; ROPES; ROPES AND SYNTHETIC ROPES; TOW ROPES FOR AUTOMOBILES (U.S. CLS. 1, 2, 7, 19, 22, 42 AND 50).
 JAMES STEIN, EXAMINING ATTORNEY

CLASS 23—YARNS AND THREADS

SN 77-564,470. KING COLE LTD., SILSDEN, WESTYORKSHIRE, ENGLAND, FILED 9-8-2008.

KING COLE

THE MARK CONSISTS OF STANDARD CHARACTERS WITHOUT CLAIM TO ANY PARTICULAR FONT, STYLE, SIZE, OR COLOR.
 FOR YARN (U.S. CL. 43).
 FIRST USE 0-0-1983; IN COMMERCE 0-0-1983.
 JASON LOTT, EXAMINING ATTORNEY

CLASS 23—(Continued).

SN 77-564,488. KING COLE LTD., SILSDEN, WESTYORKSHIRE, ENGLAND, FILED 9-8-2008.

KING COLE COMFORT

THE MARK CONSISTS OF STANDARD CHARACTERS WITHOUT CLAIM TO ANY PARTICULAR FONT, STYLE, SIZE, OR COLOR.

FOR YARN (U.S. CL. 43).
FIRST USE 2-0-2008; IN COMMERCE 2-0-2008.
MELISSA VALLILLO, EXAMINING ATTORNEY

CLASS 24—(Continued).

SN 77-452,891. LB BRANDS, LLC, PORT CLYDE, ME. FILED 4-20-2008.

IN A CLASS BY ITSELF

THE MARK CONSISTS OF STANDARD CHARACTERS WITHOUT CLAIM TO ANY PARTICULAR FONT, STYLE, SIZE, OR COLOR.

FOR BED BLANKETS AND THROWS, TABLE MATS NOT OF PAPER, OVEN MITTS (U.S. CLS. 42 AND 50).
TINA BROWN, EXAMINING ATTORNEY

SN 77-579,033. AMERICAN & EFIRD ENTERPRISES, INC., MT. HOLLY, NC. FILED 9-25-2008.

ESSENSE

THE MARK CONSISTS OF STANDARD CHARACTERS WITHOUT CLAIM TO ANY PARTICULAR FONT, STYLE, SIZE, OR COLOR.

FOR YARNS AND THREADS (U.S. CL. 43).
FIRST USE 1-2-2002; IN COMMERCE 1-2-2002.
ERIN FALK, EXAMINING ATTORNEY

SN 77-469,079. SANFORD BURROWS, LOS ANGELES, CA. FILED 5-8-2008.

sanford burrows

THE NAME(S), PORTRAIT(S), AND/OR SIGNATURE(S) SHOWN IN THE MARK DOES NOT IDENTIFY A PARTICULAR LIVING INDIVIDUAL.

THE MARK CONSISTS OF THE TEXT "SANFORD BURROWS" WRITTEN IN ARTISTIC, PAINTERLY, HANDWRITTEN-LIKE LETTERS, SIMILAR TO A SIGNATURE.

FOR TEXTILES, NAMELY, BED LINEN, DUVET COVERS, COMFORTER COVERS, BEDSPREADS, QUILTS, COMFORTERS, PILLOW SHAMS, PILLOW CASES, BED SHEETS, BED BLANKETS, THROW BLANKETS, CLOTH NAPKINS, CLOTH PLACE MATS (U.S. CLS. 42 AND 50).

FIRST USE 6-27-2007; IN COMMERCE 2-29-2008.
TIMOTHY FINNEGAN, EXAMINING ATTORNEY

CLASS 24—FABRICS

SN 77-412,604. MANIFATTURA LANE GAETANO MARZOTTO & FIGLI S.P.A., MILANO, ITALY, FILED 3-4-2008.

MARZOTTO

THE MARK CONSISTS OF STANDARD CHARACTERS WITHOUT CLAIM TO ANY PARTICULAR FONT, STYLE, SIZE, OR COLOR.

OWNER OF ERPN CMNTY TM OFC REG. NO. 3484193, DATED 5-3-2005, EXPIRES 10-30-2013.
OWNER OF U.S. REG. NOS. 1,575,066 AND 2,793,641.
SEC. 2(F).

FOR TEXTILE FABRICS FOR THE MANUFACTURE OF CLOTHING, BED COVERS, COVERLETS, QUILTS, BLANKETS AND RUGS (U.S. CLS. 42 AND 50).
FIRST USE 0-0-1984; IN COMMERCE 0-0-1984.
PAUL F. GAST, EXAMINING ATTORNEY

SN 77-486,735. POSHTOTS, INC., DENVER, CO. FILED 5-29-2008.

POSHTOTS

THE MARK CONSISTS OF STANDARD CHARACTERS WITHOUT CLAIM TO ANY PARTICULAR FONT, STYLE, SIZE, OR COLOR.

OWNER OF U.S. REG. NO. 3,092,160.
FOR A FULL LINE OF CHILDREN'S LINENS; A FULL LINE OF DRAPERY; AND BEDDING PRODUCTS, NAMELY, CRIB BUMPERS, COVERLETS, DUVETS, AND DUVET COVERS (U.S. CLS. 42 AND 50).
DOMINICK J. SALEMI, EXAMINING ATTORNEY

CLASS 24—(Continued).

SN 77-540,210. HAUTE HOME, LLC, SAN FRANCISCO, CA. FILED 8-6-2008.

HAUTE HOME

THE MARK CONSISTS OF STANDARD CHARACTERS WITHOUT CLAIM TO ANY PARTICULAR FONT, STYLE, SIZE, OR COLOR.

NO CLAIM IS MADE TO THE EXCLUSIVE RIGHT TO USE "HOME", APART FROM THE MARK AS SHOWN.

FOR BED AND TABLE LINEN; BED COVERS; BED SHEETS; BED SKIRTS; BED SPREADS; CURTAINS; DUVET COVERS; DUVETS; PILLOW SHAMS; SHOWER CURTAINS; TABLE LINEN, NAMELY, NAPKINS, TABLECLOTHS AND PLACE MATS; THROWS; TOWELS (U.S. CLS. 42 AND 50).

FIRST USE 5-1-2000; IN COMMERCE 5-10-2000.
JOHN DALIER, EXAMINING ATTORNEY

CLASS 24—(Continued).

SN 77-562,547. SLANKETLOUNGIN LLC, DENVER, CO. FILED 9-4-2008.

SNUZZLE

THE MARK CONSISTS OF STANDARD CHARACTERS WITHOUT CLAIM TO ANY PARTICULAR FONT, STYLE, SIZE, OR COLOR.

FOR BLANKET THROWS, NOT FOR INFANTS AND TODDLERS (U.S. CLS. 42 AND 50).

HEATHER BIDDULPH, EXAMINING ATTORNEY

SN 77-563,641. OSHINS, ANNE LISE, B, ENGLEWOOD, CO. FILED 9-5-2008.



NO CLAIM IS MADE TO THE EXCLUSIVE RIGHT TO USE "VINTAGE", APART FROM THE MARK AS SHOWN.

THE MARK CONSISTS OF THE WORDING "OSHIE VINTAGE" ABOVE A PAIR OF WINGS AND A GUITAR.

FOR RECEIVING BLANKETS (U.S. CLS. 42 AND 50).
FIRST USE 8-1-2008; IN COMMERCE 8-1-2008.

SHANNON TWOHIG, EXAMINING ATTORNEY

SN 77-557,313. A-1 TEXTILES & HOSPITALITY PRODUCTS, INC., PACOIMA, CA. FILED 8-27-2008.

GOLDEN GEM

THE MARK CONSISTS OF STANDARD CHARACTERS WITHOUT CLAIM TO ANY PARTICULAR FONT, STYLE, SIZE, OR COLOR.

OWNER OF U.S. REG. NOS. 3,432,161, 3,432,162 AND OTHERS.

FOR SHOWER CURTAINS (U.S. CLS. 42 AND 50).
TARA PATE, EXAMINING ATTORNEY

SN 77-565,086. HOME SOURCE INTERNATIONAL/TERRISOL CORP DIVISION OF HOME SOURCE INTERNATIONAL, NEW YORK, NY. FILED 9-8-2008.

TERRY FOR TWO

THE MARK CONSISTS OF STANDARD CHARACTERS WITHOUT CLAIM TO ANY PARTICULAR FONT, STYLE, SIZE, OR COLOR.

FOR BATH TOWELS AND BEACH BLANKETS (U.S. CLS. 42 AND 50).

FIRST USE 1-1-1985; IN COMMERCE 1-1-1985.
JANICE L. MCMORROW, EXAMINING ATTORNEY

SN 77-560,227. MARK BITTNER, TWO RIVERS, WI. FILED 9-2-2008.

SPORTCREATION

THE MARK CONSISTS OF STANDARD CHARACTERS WITHOUT CLAIM TO ANY PARTICULAR FONT, STYLE, SIZE, OR COLOR.

FOR UNFITTED COVERS FOR BOATS (U.S. CLS. 42 AND 50).

EDWARD NELSON, EXAMINING ATTORNEY

CLASS 24—(Continued).

SN 77-566,760. LOUISVILLE BEDDING COMPANY, LOUISVILLE, KY. FILED 9-10-2008.

MUSEUM

THE MARK CONSISTS OF STANDARD CHARACTERS WITHOUT CLAIM TO ANY PARTICULAR FONT, STYLE, SIZE, OR COLOR.

FOR MATTRESS PADS, FOAM MATTRESS PADS, BED SHEETS, COMFORTERS (U.S. CLS. 42 AND 50).
LAURIE KAUFMAN, EXAMINING ATTORNEY

SN 77-568,546. THE MANUAL WOODWORKERS & WEAVERS, INC., HENDERSONVILLE, NC. FILED 9-12-2008.

WOVEN MOMENTS

THE MARK CONSISTS OF STANDARD CHARACTERS WITHOUT CLAIM TO ANY PARTICULAR FONT, STYLE, SIZE, OR COLOR.

NO CLAIM IS MADE TO THE EXCLUSIVE RIGHT TO USE "WOVEN", APART FROM THE MARK AS SHOWN.
FOR CUSTOM IMPRINTED BLANKET THROWS AND TAPESTRIES (U.S. CLS. 42 AND 50).
FIRST USE 11-1-2005; IN COMMERCE 11-1-2005.
MICHAEL KEATING, EXAMINING ATTORNEY

SN 77-588,533. LOUISVILLE BEDDING COMPANY, LOUISVILLE, KY. FILED 10-8-2008.

THE NIGHT IS YOUR CANVAS

THE MARK CONSISTS OF STANDARD CHARACTERS WITHOUT CLAIM TO ANY PARTICULAR FONT, STYLE, SIZE, OR COLOR.

FOR MATTRESS PADS, SHEETS, COMFORTERS, FOAM MATTRESS PADS (U.S. CLS. 42 AND 50).
LAURIE KAUFMAN, EXAMINING ATTORNEY

CLASS 24—(Continued).

SN 77-588,551. HEB GROCERY COMPANY, L.P., SAN ANTONIO, TX. FILED 10-8-2008.



ChefStyle

OWNER OF U.S. REG. NOS. 2,887,689, 3,276,593 AND OTHERS.

FOR KITCHEN TOWELS, POT HOLDERS, OVEN MITTS; CHEESE CLOTH (U.S. CLS. 42 AND 50).
FIRST USE 9-0-2004; IN COMMERCE 9-0-2004.
BARNEY CHARLON, EXAMINING ATTORNEY

SN 77-590,518. LOUISVILLE BEDDING COMPANY, LOUISVILLE, KY. FILED 10-10-2008.

YOUR MUSE AWAITS

THE MARK CONSISTS OF STANDARD CHARACTERS WITHOUT CLAIM TO ANY PARTICULAR FONT, STYLE, SIZE, OR COLOR.

FOR MATTRESS PADS, SHEETS, COMFORTERS, FOAM MATTRESS PADS (U.S. CLS. 42 AND 50).
LAURIE KAUFMAN, EXAMINING ATTORNEY

SN 77-590,529. LOUISVILLE BEDDING COMPANY, LOUISVILLE, KY. FILED 10-10-2008.

TONIGHT AND EVERY NIGHT, YOUR MUSE AWAITS

THE MARK CONSISTS OF STANDARD CHARACTERS WITHOUT CLAIM TO ANY PARTICULAR FONT, STYLE, SIZE, OR COLOR.

FOR MATTRESS PADS, SHEETS, COMFORTERS, FOAM MATTRESS PADS (U.S. CLS. 42 AND 50).
LAURIE KAUFMAN, EXAMINING ATTORNEY

CLASS 24—(Continued).

SN 78-613,279. CONSOLTEX INC., SAINT-LAURENT (QUEBEC) H4S 1Z6, CANADA, FILED 4-20-2005.

S² TECHNOLOGIES

OWNER OF CANADA REG. NO. TMA703934, DATED 1-2-2008, EXPIRES 1-2-2023.

NO CLAIM IS MADE TO THE EXCLUSIVE RIGHT TO USE "TECHNOLOGIES", APART FROM THE MARK AS SHOWN.

THE WORDING "S2" THE MARK HAS NO MEANING IN A FOREIGN LANGUAGE.

FOR TEXTILE FABRICS FOR USE IN THE MANUFACTURE OF CLOTHING, APPAREL AND APPAREL ACCESSORIES (U.S. CLS. 42 AND 50).

CHRIS WELLS, EXAMINING ATTORNEY

CLASS 25—CLOTHING

SN 76-669,761. SHAFIK, AASEF, ANNANDALE, VA. FILED 11-30-2006.

GLOBAL PEACE LOVER

THE MARK CONSISTS OF STANDARD CHARACTERS WITHOUT CLAIM TO ANY PARTICULAR FONT, STYLE, SIZE, OR COLOR.

FOR SHIRTS, HATS, JACKETS, PANTS, SHOES AND ATHLETIC WEAR, NAMELY, SWEATSHIRTS AND ATHLETIC UNIFORMS (U.S. CLS. 22 AND 39).

FIRST USE 4-1-2007; IN COMMERCE 4-1-2007.

EVLYN BRADLEY, EXAMINING ATTORNEY

SN 79-057,068. BABY PIU' S.R.L., ITALY, FILED 2-21-2008.



PRIORITY DATE OF 2-12-2008 IS CLAIMED. OWNER OF INTERNATIONAL REGISTRATION 0972755 DATED 2-21-2008, EXPIRES 2-21-2018.

THE WORDING "BABYPIU'" IN THE MARK HAS NO MEANING IN A FOREIGN LANGUAGE.

FOR BED SHEETS, BED BLANKETS, SHOCK-ABSORBING QUILTS FOR BEDS, QUILTS, CRIB LINERS, NAMELY, CRIB BUMPERS, CRIB BUMPER PADS, MATTRESS COVERS AND MATTRESS PADS, AND BEDDING SETS COMPRISED OF BED SHEETS, FITTED BED SHEET COVERS, BED FLAT SHEETS AND PILLOW CASES FOR BEDS AND CRADLES, BIBS MADE OF FABRIC, BATHROOM TOWELS MADE OF FABRIC, TOWELS MADE OF TEXTILE MATERIALS, COATINGS FOR FURNITURE MADE OF TEXTILE MATERIALS, NAMELY, LAMINATED TEXTILES TO BE AFFIXED TO THE SURFACE OF FURNITURE, WALL COVERINGS MADE OF TEXTILE MATERIALS, NAMELY, WALL HANGINGS OF TEXTILE (U.S. CLS. 42 AND 50).

CARYN GLASSER, EXAMINING ATTORNEY

SN 76-689,468. LAKESTAR KOLLABORATION SHOES INC., MONTEREY PARK, CA. FILED 5-9-2008.



THE MARK CONSISTS OF A DESIGN OF A CIRCLE TO THE LEFT OF A TRIANGULAR DESIGN ALL WITHIN A CIRCULAR CARRIER.

FOR PANTS, SHIRTS, JACKETS, SHOES, SOCKS, BOOTS, UNIFORMS, SLIPPERS, BRIEFS, CAP, SNEAKERS, SWEATER, COATS, DRESS, JEANS, A-SHIRTS, BLOUSE, GLOVES, BASKETBALL SNEAKERS, BASEBALL CAPS, BASEBALL SHOES, SOCCER BOOTS, SOCCER SHOES, FOOTBALL SHOES, FOOTBALL BOOTS, TENNIS SHOES, POLO SHIRTS, SWEAT SUITS, TIGHTS, HOODS, FLEECE PULLOVERS, FLEECE SHORTS, FLEECE VESTS, BLAZER, SKIRTS, DRESS SHIRTS, CAPRIS, TOPS, SHORTS, SUITS, TANK TOPS, FLIP FLOPS, UNDERWEAR, BOXER BRIEFS, BOXER SHORTS, KNIT SHIRTS, BELTS, SCARVES, BANDANAS, DO RAGS (U.S. CLS. 22 AND 39).

FIRST USE 6-8-2004; IN COMMERCE 6-8-2004.

JASON TURNER, EXAMINING ATTORNEY

CLASS 25—(Continued).

SN 76-692,002. AGUEL, VICENTE, LOS ANGELES, CA. AND CASTILLO, FRANKLIN, LOS ANGELES, CA. FILED 8-12-2008.



THE COLOR(S) RED, BLACK, GRAY AND WHITE IS/ ARE CLAIMED AS A FEATURE OF THE MARK.

THE MARK CONSISTS OF A MALTESE CROSS OUTLINED IN BLACK WITH A RED BACKGROUND. RUNNING VERTICALLY THROUGH THE CENTER OF THE CROSS ARE FOUR CURVED BLACK TRIANGLES. THE WORDING "EXPLICIT SIN" APPEARS HORIZONTALLY ACROSS THE CENTER OF THE CROSS, WITH THE LETTERS "EXPL", "ICIT" AND "SIN" IN SHADES OF GRAY TO WHITE, RESPECTIVELY.

FOR CLOTHING, NAMELY, PANTS, SHIRTS, JACKETS AND SHOES (U.S. CLS. 22 AND 39).
AMY KERTGATE, EXAMINING ATTORNEY

SN 76-692,655. ANGELS BASEBALL LP, ANAHEIM, CA. FILED 9-9-2008.

THE BIG A

THE MARK CONSISTS OF STANDARD CHARACTERS WITHOUT CLAIM TO ANY PARTICULAR FONT, STYLE, SIZE, OR COLOR.

OWNER OF U.S. REG. NOS. 1,576,459, 3,238,175 AND OTHERS.

FOR CLOTHING, NAMELY, CAPS, HATS, VISORS, KNITTED HEADWEAR, HEADBANDS, BANDANNAS, SHIRTS, T-SHIRTS, TANK TOPS, BLOUSES, SWEATERS, TURTLENECKS, PULLOVERS, VESTS, SHORTS, PANTS, SLACKS, DRESSES, SKIRTS, BASEBALL UNIFORMS, JERSEYS, WARM-UP SUITS, JOGGING SUITS, SWEATSHIRTS, SWEATPANTS, UNDERWEAR, BOXER SHORTS, ROBES, SLEEPWEAR, PAJAMAS, NIGHTSHIRTS, NIGHTGOWNS, SWIMWEAR, CLOTHING WRAPS, JACKETS, PONCHOS, CLOTH BIBS, INFANT WEAR, INFANT DIAPER COVERS, CLOTH DIAPER SETS WITH UNDERSHIRT AND DIAPER COVER, JUMPERS, ROMPERS, COVERALLS, CREEPERS, BABY BOOTIES, TIES, BELTS, MITTENS, GLOVES, WRISTBANDS, EARMUFFS, SCARVES, FOOTWEAR, SOCKS, HOSIERY, SLIPPERS, AND HALLOWEEN AND MASQUERADE COSTUMES (U.S. CLS. 22 AND 39).
CHARISMA HAMPTON, EXAMINING ATTORNEY

CLASS 25—(Continued).

SN 76-692,718. COOGI PARTNERS, LLC, LAKE SUCCESS, NY. FILED 9-9-2008.

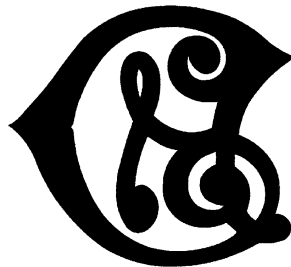

THE MARK CONSISTS OF THE LETTER "C" IN A STYLIZED DESIGN WHICH POINTS AT THE TOP FRONT AND IN THE MIDDLE OF THE REAR OF THE "C" AND WITH A DESIGN SIMILAR TO A TREBLE CLEF IN THE CENTER.

FOR CLOTHING, NAMELY, PANTS AND SHIRTS (U.S. CLS. 22 AND 39).

FIRST USE 8-13-2007; IN COMMERCE 8-13-2007.
SHANNON TWOHIG, EXAMINING ATTORNEY

SN 77-010,497. BLOWFISH LLC, MARLBORO, NJ. FILED 9-29-2006.

GUPPY LOVE

THE MARK CONSISTS OF STANDARD CHARACTERS WITHOUT CLAIM TO ANY PARTICULAR FONT, STYLE, SIZE, OR COLOR.

FOR FOOTWEAR (U.S. CLS. 22 AND 39).
DARRYL SPRUILL, EXAMINING ATTORNEY

SN 77-030,690. SCHAUB, ELISA R., SUNRISE BEACH, MO. FILED 10-27-2006.

Lake Kid

THE MARK CONSISTS OF STANDARD CHARACTERS WITHOUT CLAIM TO ANY PARTICULAR FONT, STYLE, SIZE, OR COLOR.

NO CLAIM IS MADE TO THE EXCLUSIVE RIGHT TO USE "KID", APART FROM THE MARK AS SHOWN.

FOR SHIRTS, SHORTS, SWEATSHIRTS, JACKETS, CAPS, VISORS, FLIP FLOPS, COVER-UPS, SWIMSUIT (U.S. CLS. 22 AND 39).

FIRST USE 6-8-2004; IN COMMERCE 5-31-2006.
STEVEN JACKSON, EXAMINING ATTORNEY

CLASS 25—(Continued).

SN 77-160,459. A.L.S. ENTERPRISES, INC., MUSKEGON, MI. FILED 4-19-2007.

BBD

THE MARK CONSISTS OF STANDARD CHARACTERS WITHOUT CLAIM TO ANY PARTICULAR FONT, STYLE, SIZE, OR COLOR.

FOR HATS; SHIRTS; COATS; JACKETS; PANTS; BIB OVERALLS; CAPS (U.S. CLS. 22 AND 39).
MATTHEW MCDOWELL, EXAMINING ATTORNEY

SN 77-163,553. CRAIG, ELIZABETH M, HOLLYWOOD, FL. FILED 4-23-2007.

JAIGANIC

THE MARK CONSISTS OF STYLIZED FONT THAT SPELLS THE NAME OF THE COMPANY "JAIGANIC". CAN BE IN BLACK TYPE WITH WHITE BACKGROUND OR WHITE TYPE ON BLACK BACKGROUND. WILL BE USED IN A VARIETY OF COLORS.

FOR YOGA PANTS; YOGA SHIRTS; CAPRI PANTS; JOGGING PANTS; PANTS; SWEAT PANTS; OPEN-NECKED SHIRTS; SHIRTS; SHORT-SLEEVED OR LONG-SLEEVED T-SHIRTS; SPORTS SHIRTS; SWEAT SHIRTS; T-SHIRTS (U.S. CLS. 22 AND 39).
FIRST USE 4-12-2007; IN COMMERCE 4-12-2007.
LINDA M. KING, EXAMINING ATTORNEY

SN 77-169,555. LOGANLIFE, LLC, AURORA, CO. FILED 5-1-2007.

BABYCANDY

THE MARK CONSISTS OF STANDARD CHARACTERS WITHOUT CLAIM TO ANY PARTICULAR FONT, STYLE, SIZE, OR COLOR.

FOR (BASED ON INTENT TO USE) APPAREL AND APPAREL GIFT SETS FOR INFANTS, NAMELY, T-SHIRTS AND ROMPERS, AND APPAREL FOR CHILDREN, NAMELY, T-SHIRTS; (BASED ON INTENT TO USE) APPAREL AND APPAREL GIFT SETS FOR INFANTS AND CHILDREN, NAMELY, PANTS, HATS, AND CLOTH BABY BIBS (U.S. CLS. 22 AND 39).
FIRST USE 6-22-2006; IN COMMERCE 6-22-2006.
STEPHEN AQUILA, EXAMINING ATTORNEY

CLASS 25—(Continued).

SN 77-201,060. ITOCHU CORPORATION, CHUO-KU, OSAKA, JAPAN, AND TSURUYA SHOE STORE CO., LTD., NAGOYA-CITY, AICHI, JAPAN, FILED 6-8-2007.

MAD FOOT!

THE MARK CONSISTS OF STANDARD CHARACTERS WITHOUT CLAIM TO ANY PARTICULAR FONT, STYLE, SIZE, OR COLOR.

OWNER OF JAPAN REG. NO. 5123664, DATED 3-28-2008, EXPIRES 3-28-2018.

NO CLAIM IS MADE TO THE EXCLUSIVE RIGHT TO USE "FOOT" FOR "SOCKS" AND "FOOTWEAR", APART FROM THE MARK AS SHOWN.

FOR CLOTHING, NAMELY, T-SHIRTS, JEANS, JACKETS, SOCKS, GLOVES, SWEATSHIRTS, TANK TOPS, PARKAS, CAPS, MUFFLERS, FOOTWEAR (U.S. CLS. 22 AND 39).

TINA BROWN, EXAMINING ATTORNEY

SN 77-212,715. WILKS, TIMOTHY L., BROOKLYN, NY. FILED 6-22-2007.

I'm Not A Deadbeat!

THE MARK CONSISTS OF STANDARD CHARACTERS WITHOUT CLAIM TO ANY PARTICULAR FONT, STYLE, SIZE, OR COLOR.

FOR T-SHIRTS, HATS, JACKETS (U.S. CLS. 22 AND 39).

FIRST USE 6-21-2007; IN COMMERCE 6-21-2007.
MICHAEL TANNER, EXAMINING ATTORNEY

SN 77-235,284. HURLEY INTERNATIONAL LLC, COSTA MESA, CA. FILED 7-20-2007.

SALVATION

THE MARK CONSISTS OF STANDARD CHARACTERS WITHOUT CLAIM TO ANY PARTICULAR FONT, STYLE, SIZE, OR COLOR.

OWNER OF U.S. REG. NO. 2,363,365.

FOR CLOTHING, NAMELY, T-SHIRTS, TOPS, JACKETS, SHORTS, SWEATPANTS, SWEATSHIRTS, SWIMWEAR, BEACHWEAR, WET SUITS, BELTS, JEANS, PANTS, BOTTOMS, SKIRTS, DRESSES, SWEATERS, SLEEPWEAR, UNDERGARMENTS, SKIWEAR AND SOCKS; HEADWEAR AND FOOTWEAR (U.S. CLS. 22 AND 39).

RAMONA ORTIGA, EXAMINING ATTORNEY

CLASS 25—(Continued).

SN 77-238,320. CONCORD MOON LP, LOS ANGELES, CA.
FILED 7-25-2007.



OWNER OF U.S. REG. NOS. 2,734,082, 2,734,084 AND 2,885,613.

THE MARK CONSISTS OF A YIN AND YANG SYMBOL WITH AN ELONGATED ARROW ON THE LEFT POINTING UP AND AN ELONGATED ARROW ON THE RIGHT POINTING DOWN. OUTSIDE OF THE ARROWS ON BOTH SIDES ARE CHINESE CHARACTERS.

THE FOREIGN WORDING IN THE MARK TRANSLATES INTO ENGLISH AS "USING NO WAY AS WAY, HAVING NO LIMITATION AS LIMITATION".

THE NON-LATIN CHARACTERS IN THE MARK TRANSLITERATE TO "YI WU FA WEI YOU FA, YI WU XIAN WEI YOU XIAN".

FOR CLOTHING, NAMELY, T-SHIRTS, SHIRTS AND TANK TOPS (U.S. CLS. 22 AND 39).

FIRST USE 8-31-1997; IN COMMERCE 8-31-1997.

FLORENTINA BLANDU, EXAMINING ATTORNEY

CLASS 25—(Continued).

SN 77-275,617. BALLET INTERNATIONAL LTD, LEEDS,
UNITED KINGDOM, FILED 9-10-2007.



PRIORITY CLAIMED UNDER SEC. 44(D) ON ERP
CMNTY TM OFC APPLICATION NO. 006250419, FILED 9-7-2007.

OWNER OF ERP CMNTY TM OFC REG. NO. 006250419,
DATED 8-19-2008, EXPIRES 9-7-2017.

FOR SPORTSWEAR, NAMELY, SWEATSHIRTS, SWEATERS, SWEATPANTS, TRACK SUITS, PANTS, VESTS, SHORTS, SHIRTS, T-SHIRTS, POLO SHIRTS, DRESSES, SKIRTS AND PULLOVERS; NIGHTWEAR, NAMELY, PAJAMAS, NIGHT SHIRTS, NIGHTGOWNS, NIGHTDRESSES, HOUSECOATS, ROBES, NIGHTIES, NEGLIGES, BABY DOLL PAJAMAS, PEIGNOIRS AND JAPANESE SLEEPING ROBES (NEMAKI); LOUNGEWEAR, NAMELY, LOUNGING PANTS, SHIRTS AND TOPS, LOUNGE JACKETS; BRIDAL WEAR, NAMELY, BRIDAL GOWNS, PEIGNOIRS, BRIDESMAIDS' DRESSES, FLOWER GIRL DRESSES, VEILS, BRIDAL GARTERS, BRIDAL HEAD DRESSES AND GLOVES; LINGERIE, SWIMWEAR AND HOSIERY (U.S. CLS. 22 AND 39).

RONALD MCMORROW, EXAMINING ATTORNEY

SN 77-255,725. ELIYAHU COHEN, LOS ANGELES, CA.
FILED 8-15-2007.

GLOBAL WARMING

THE MARK CONSISTS OF STANDARD CHARACTERS WITHOUT CLAIM TO ANY PARTICULAR FONT, STYLE, SIZE, OR COLOR.

FOR CLOTHING, NAMELY, MEN'S, WOMEN'S, MIS-SY'S, JUNIORS', CHILDREN'S AND INFANTS' JEANS, PANTS, TROUSERS, CAPRIS, LEGGINGS, SHORTS, SKORTS, OVERALLS, SKIRTS, DRESSES, TOPS, T-SHIRTS, TANK TOPS, SWEATSHIRTS, SWEAT PANTS, BLOUSES, SHIRTS, JACKETS, COATS, SWEATERS, VESTS, CARDIGANS, SCARVES, SOCKS, UNDERWEAR, LINGERIE, LOUNGEWEAR, THERMAL WEAR, NAMELY, SOCKS AND UNDERWEAR, BANDANAS, WRISTBANDS, NECKTIES, FOOTWEAR, HATS, CAPS, HEADWEAR, BOOTS, SANDALS AND BELTS (U.S. CLS. 22 AND 39).

MICHAEL WIENER, EXAMINING ATTORNEY

SN 77-289,588. MARTY SIMPSON, COLUMBIA, SC. FILED 9-26-2007.

DAMBEAU

THE MARK CONSISTS OF STANDARD CHARACTERS WITHOUT CLAIM TO ANY PARTICULAR FONT, STYLE, SIZE, OR COLOR.

FOR CLOTHING, NAMELY, SHIRTS, SWEATSHIRTS, JACKETS, PANTS, SHORTS, BOXER SHORTS, HATS, VISORS, SOCKS, THERMAL UNDERWEAR, NECK AND WRIST BANDS, CHILDREN'S CLOTH EATING BIBS (U.S. CLS. 22 AND 39).

GIANCARLO CASTRO, EXAMINING ATTORNEY

CLASS 25—(Continued).

SN 77-328,868. OFFICIAL BUGLE BOY, LLC, COLUMBUS, OH. FILED 11-14-2007.

B.B.J.

THE MARK CONSISTS OF STANDARD CHARACTERS WITHOUT CLAIM TO ANY PARTICULAR FONT, STYLE, SIZE, OR COLOR.

OWNER OF U.S. REG. NO. 1,515,490.

FOR CLOTHING, NAMELY, TOPS, BOTTOMS, OVERALLS, PANTS, SHORTS, JEANS, SKIRTS, SKORTS, DRESSES, SWEATERS, SHIRTS, VESTS, ROBES, SWEATPANTS, SWEATSHIRTS, COATS, JACKETS, UNDERWEAR, SWIMWEAR, HEADWEAR, NECKWEAR, SLEEPWEAR, FOOTWEAR, RAINWEAR, HOSIERY, SCARVES, AND BELTS (U.S. CLS. 22 AND 39).

RUSS HERMAN, EXAMINING ATTORNEY

SN 77-345,139. DOUGLAS A. MARCHISELLO TRUST, KANSAS CITY, MO. FILED 12-5-2007.

BUNGALOW JOE

THE MARK CONSISTS OF STANDARD CHARACTERS WITHOUT CLAIM TO ANY PARTICULAR FONT, STYLE, SIZE, OR COLOR.

THE NAME(S), PORTRAIT(S), AND/OR SIGNATURE(S) SHOWN IN THE MARK DOES NOT IDENTIFY A PARTICULAR LIVING INDIVIDUAL.

FOR BUTTON-FRONT ALOHA SHIRTS; CAMP SHIRTS; GOLF SHIRTS; KNIT SHIRTS; LONG-SLEEVED SHIRTS; OPEN-NECKED SHIRTS; POLO SHIRTS; SHIRTS; SHORT-SLEEVED OR LONG-SLEEVED T-SHIRTS; SHORT-SLEEVED SHIRTS; SPORT SHIRTS; SPORTS SHIRTS; SWEAT SHIRTS; T-SHIRTS; WIND SHIRTS; YOGA SHIRTS; BEACH FOOTWEAR; FLIP FLOPS; FOOTWEAR; FOOTWEAR FOR MEN AND WOMEN; THONGS; FOOTWEAR FOR MEN; FOOTWEAR FOR WOMEN; CARGO PANTS; DENIMS; LEATHER PANTS; PANTS; STRETCH PANTS; SWEAT PANTS; JACKETS; MEN AND WOMEN JACKETS, COATS, TROUSERS, VESTS; HATS; CAPS; CAPS WITH VISORS; GOLF CAPS; SWIMWEAR (U.S. CLS. 22 AND 39).

BONNIE LUKEN, EXAMINING ATTORNEY

CLASS 25—(Continued).

SN 77-365,160. KLUTSE,CHRISTOPHER L, HOLLIS, NY. FILED 1-7-2008.



THE MARK CONSISTS OF A DESIGN OF INTERLOCKING LETTERS "C" AND "L", WITH THE BASE OF THE LETTER "L" FORMING THE BOTTOM CURVED PORTION OF THE LETTER "C", AND WITH THE LETTERS APPEARING ATOP A SHIELD DESIGN WHICH IS TOPPED BY A DESIGN RESEMBLING A FIVE-PRONGED CROWN TIPPED BY DIAMOND SHAPES; THE SHIELD DESIGN APPEARS ATOP A BACKGROUND CARRIER THAT IS ROUNDED AT THE TOP AND POINTED AT THE BASE, ECHOING THE SHIELD DESIGN; THE CARRIER FEATURES A CHECKERBOARD PATTERN IN THE TOP HALF OF THE CARRIER.

FOR APPAREL, NAMELY, SHIRTS, PANTS, JACKETS, FOOTWEAR, HATS AND CAPS, ATHLETIC UNIFORMS, LEATHER BELTS, BOXER SHORTS, SCARVES (U.S. CLS. 22 AND 39).

FIRST USE 2-21-2007; IN COMMERCE 4-29-2007.

KAELIE KUNG, EXAMINING ATTORNEY

SN 77-385,304. J. MATTHEW BURKHART, CHAUTAUQUA, NY. FILED 1-31-2008.

BAARF

THE MARK CONSISTS OF STANDARD CHARACTERS WITHOUT CLAIM TO ANY PARTICULAR FONT, STYLE, SIZE, OR COLOR.

FOR CLOTHING, NAMELY, T-SHIRTS (U.S. CLS. 22 AND 39).

LAURA HAMMEL, EXAMINING ATTORNEY

CLASS 25—(Continued).

SN 77-387,993. TOM JAMES COMPANY, FRANKLIN, TN.
FILED 2-4-2008.

INDIVIDUALIZED CLOTHING

THE MARK CONSISTS OF STANDARD CHARACTERS WITHOUT CLAIM TO ANY PARTICULAR FONT, STYLE, SIZE, OR COLOR.

NO CLAIM IS MADE TO THE EXCLUSIVE RIGHT TO USE "CLOTHING", APART FROM THE MARK AS SHOWN. SEC. 2(F).

FOR MEN'S AND WOMEN'S TAILORED CLOTHING, NAMELY, SUITS, SPORT COATS, AND PANTS (U.S. CLS. 22 AND 39).

FIRST USE 6-0-2004; IN COMMERCE 6-0-2004.
LINDA M. KING, EXAMINING ATTORNEY

SN 77-390,816. HBI BRANDED APPAREL LIMITED, INC.,
WINSTON-SALEM, NC. FILED 2-7-2008.

BE WEDGIE FREE

THE MARK CONSISTS OF STANDARD CHARACTERS WITHOUT CLAIM TO ANY PARTICULAR FONT, STYLE, SIZE, OR COLOR.

FOR UNDERWEAR (U.S. CLS. 22 AND 39).
CYNTHIA SLOAN, EXAMINING ATTORNEY

SN 77-393,042. BLAU, JONATHAN SCOTT, OAK BLUFFS,
MA. FILED 2-9-2008.

Flip Burger

THE MARK CONSISTS OF STANDARD CHARACTERS WITHOUT CLAIM TO ANY PARTICULAR FONT, STYLE, SIZE, OR COLOR.

FOR T-SHIRTS (U.S. CLS. 22 AND 39).
RONALD MCMORROW, EXAMINING ATTORNEY

CLASS 25—(Continued).

SN 77-399,080. ARNOLD, HENRY S. HUNTINGTON BEACH,
CA. AND BENSON, ANDY, LONG BEACH, CA. AND
HASLACKER, ADAM, LAKEWOOD, CA. AND GOWDY,
ERIC, LONG BEACH, CA. FILED 2-17-2008.

Bring The Pain

THE MARK CONSISTS OF STANDARD CHARACTERS WITHOUT CLAIM TO ANY PARTICULAR FONT, STYLE, SIZE, OR COLOR.

FOR HATS; SHORT-SLEEVED OR LONG-SLEEVED T-SHIRTS; PANTS; STRETCH PANTS; SWEAT PANTS; SHORTS; SWEATERS (U.S. CLS. 22 AND 39).

JENNIFER HETU, EXAMINING ATTORNEY

SN 77-400,839. BIAGIONI, BIANCA, HOLLYWOOD, CA.
AND REIMER, ABY T., HOLLYWOOD, CA. FILED 2-19-
2008.

Eternal Couture

THE MARK CONSISTS OF STANDARD CHARACTERS WITHOUT CLAIM TO ANY PARTICULAR FONT, STYLE, SIZE, OR COLOR.

NO CLAIM IS MADE TO THE EXCLUSIVE RIGHT TO USE "COUTURE", APART FROM THE MARK AS SHOWN.

FOR WOMEN'S, MEN'S AND CHILDREN'S CLOTHING, NAMELY, T-SHIRTS, DRESSES, TOPS, NECKWEAR, HEADWEAR, WRAPS, SHIRTS, SHORTS, JEANS, PANTS, UNDERGARMENTS, FOOTWEAR, SUITS, TRACK SUITS, BELTS, SHAWLS, CAPS, JACKETS, SWEATERS, SKIRTS, SOCKS, TROUSERS, SCARVES AND COATS; ORGANIC CLOTHING, NAMELY, T-SHIRTS, DRESSES, TOPS, NECKWEAR, HEADWEAR, WRAPS, SHIRTS, SHORTS, JEANS, PANTS, UNDERGARMENTS, FOOTWEAR, SUITS, TRACK SUITS, BELTS, SHAWLS, CAPS, JACKETS, SWEATERS, SKIRTS, SOCKS, TROUSERS, SCARVES AND COATS (U.S. CLS. 22 AND 39).

CAROLINE WOOD, EXAMINING ATTORNEY

CLASS 25—(Continued).

SN 77-402,621. DEUTSHE TELEKOM, BONN, FED REP GERMANY, FILED 2-21-2008.

CONGSTAR

THE MARK CONSISTS OF STANDARD CHARACTERS WITHOUT CLAIM TO ANY PARTICULAR FONT, STYLE, SIZE, OR COLOR.

PRIORITY CLAIMED UNDER SEC. 44(D) ON FED REP GERMANY APPLICATION NO. 30754736.1/3, FILED 8-21-2007, REG. NO. 30754736, DATED 5-6-2008, EXPIRES 8-31-2017.

FOR CLOTHING, NAMELY, SHIRTS, DRESSES, PANTS, JACKETS, COATS, T-SHIRTS, SHORTS; BELTS; HEADWEAR, NAMELY, CAPS AND HATS; FOOTWEAR (U.S. CLS. 22 AND 39).

ADA HAN, EXAMINING ATTORNEY

CLASS 25—(Continued).

SN 77-407,514. JOSE LUIS RODRIGUEZ MORENO, KATY, TX. AND LUIS ALEJANDRO RODRIGUEZ MORENO, KATY, TX. FILED 2-27-2008.

RODMOR

THE MARK CONSISTS OF STANDARD CHARACTERS WITHOUT CLAIM TO ANY PARTICULAR FONT, STYLE, SIZE, OR COLOR.

FOR WORK SHOES AND WORK BOOTS (U.S. CLS. 22 AND 39).

DARRYL SPRUILL, EXAMINING ATTORNEY

SN 77-404,633. ALLISON, JON P., TOWSON, MD. FILED 2-24-2008.

FREEDOM EQUALITY CHANGE

THE MARK CONSISTS OF STANDARD CHARACTERS WITHOUT CLAIM TO ANY PARTICULAR FONT, STYLE, SIZE, OR COLOR.

FOR CLOTHING, NAMELY, SHIRTS, T-SHIRTS, SHIRTS AND JACKETS WITH HOODS, SHORTS, HATS, SNEAKERS, FOOTWEAR, BATHING SUITS, CAPS, SWEATSHIRTS, MEN'S AND WOMEN'S JACKETS (U.S. CLS. 22 AND 39).

FIRST USE 5-5-2007; IN COMMERCE 5-5-2007.
JAY FLOWERS, EXAMINING ATTORNEY

SN 77-407,577. JOSE LUIS RODRIGUEZ MORENO, KATY, TX. AND LUIS ALEJANDRO RODRIGUEZ MORENO, KATY, TX. FILED 2-27-2008.

FORTAL

THE MARK CONSISTS OF STANDARD CHARACTERS WITHOUT CLAIM TO ANY PARTICULAR FONT, STYLE, SIZE, OR COLOR.

FOR WORK SHOES AND WORK BOOTS (U.S. CLS. 22 AND 39).

DARRYL SPRUILL, EXAMINING ATTORNEY

SN 77-405,809. MARIN-AMEZQUITA, JOSE DE JESUS, LEON, MEXICO, FILED 2-26-2008.



THE NAME(S), PORTRAIT(S), AND/OR SIGNATURE(S) SHOWN IN THE MARK DOES NOT IDENTIFY A PARTICULAR LIVING INDIVIDUAL.

THE MARK CONSISTS OF THE LETTERS "JA" INSIDE A HORSHOE LIKE FIGURE AND BELOW IT THE WORDS "JACK'S ANDRÉ".

FOR FOOTWEAR; SHOES (U.S. CLS. 22 AND 39).
FIRST USE 4-20-2001; IN COMMERCE 4-23-2001.
JOHN DALIER, EXAMINING ATTORNEY

SN 77-410,927. EDWARD SCHWARTZ, NASHVILLE, TN. FILED 3-3-2008.

Hit Me With Your Best Shot

THE MARK CONSISTS OF STANDARD CHARACTERS WITHOUT CLAIM TO ANY PARTICULAR FONT, STYLE, SIZE, OR COLOR.

FOR JERSEYS; SPORTS JERSEYS (U.S. CLS. 22 AND 39).

KATHERINE CHANG, EXAMINING ATTORNEY

CLASS 25—(Continued).

SN 77-411,742. HATFIELD, CASEY R. PORTLAND, OR. AND HATFIELD, KERBY C. PORTLAND, OR. AND WESTHUSING, SARAH, PORTLAND, OR. AND RYAN, SHAY A. PORTLAND, OR. FILED 3-3-2008.

Flaat

THE MARK CONSISTS OF STANDARD CHARACTERS WITHOUT CLAIM TO ANY PARTICULAR FONT, STYLE, SIZE, OR COLOR.

FOR BRAS (U.S. CLS. 22 AND 39).
MELVIN AXILBUND, EXAMINING ATTORNEY

SN 77-413,388. FILLING THE SEATS LLC, NEW YORK, NY. FILED 3-5-2008.

OAK MONSTER

THE MARK CONSISTS OF STANDARD CHARACTERS WITHOUT CLAIM TO ANY PARTICULAR FONT, STYLE, SIZE, OR COLOR.

FOR APPAREL, NAMELY, HATS, SHIRTS, WRISTBANDS AND HEADBANDS (U.S. CLS. 22 AND 39).
ELI HELLMAN, EXAMINING ATTORNEY

SN 77-414,134. KRZEMIEN, KELLY C., MIDLOTHIAN, VA. FILED S.R. 3-5-2008; AM. P.R. 12-23-2008.

ANGELS AT WORK

THE MARK CONSISTS OF STANDARD CHARACTERS WITHOUT CLAIM TO ANY PARTICULAR FONT, STYLE, SIZE, OR COLOR.

OWNER OF U.S. REG. NO. 3,321,130.
FOR COATS; JACKETS (U.S. CLS. 22 AND 39).
FIRST USE 4-1-2006; IN COMMERCE 6-1-2007.
JOHN DALIER, EXAMINING ATTORNEY

CLASS 25—(Continued).

SN 77-415,700. JORDAN OUTDOOR ENTERPRISES, LTD., COLUMBUS, GA. FILED 3-7-2008.

REALTREE OUTDOORS

THE MARK CONSISTS OF STANDARD CHARACTERS WITHOUT CLAIM TO ANY PARTICULAR FONT, STYLE, SIZE, OR COLOR.

OWNER OF U.S. REG. NOS. 1,929,861 AND 1,957,418.
NO CLAIM IS MADE TO THE EXCLUSIVE RIGHT TO USE "OUTDOORS", APART FROM THE MARK AS SHOWN.
FOR CLOTHING, NAMELY, SHIRTS, PANTS, HATS, JACKETS AND SHORTS (U.S. CLS. 22 AND 39).
CARYN GLASSER, EXAMINING ATTORNEY

SN 77-422,810. DISNEY ENTERPRISES, INC., BURBANK, CA. FILED 3-14-2008.

ZETA BETA ZETA

THE MARK CONSISTS OF STANDARD CHARACTERS WITHOUT CLAIM TO ANY PARTICULAR FONT, STYLE, SIZE, OR COLOR.

FOR BEACHWEAR; BELTS; BOTTOMS; CHAPS; CLOTH BIBS; COATS; COVER-UPS; DRESSES; EAR MUFFS; FOOTWEAR; GLOVES; HALLOWEEN COSTUMES; HEADWEAR; HOSIERY; INFANTWEAR; JACKETS; LEOTARDS; LINGERIE; LOUNGEWEAR; MITTENS; OVERALLS; PANTS; PONCHOS; RAINWEAR; SCARVES; SHIRTS; SHORTS; SLEEPWEAR; SOCKS; SWEATERS; SWEATSHIRTS; SWIMWEAR; TIES; TOPS; UNDERWEAR; WRIST BANDS (U.S. CLS. 22 AND 39).
CAROLYN GRAY, EXAMINING ATTORNEY

CLASS 25—(Continued).

SN 77-425,710. ARNOLD L. BEIZER, BOCA RATON, FL. FILED 3-19-2008.



THE MARK CONSISTS OF A CAPITAL "Y" WITH A "?" IN THE CENTER.

SEC. 2(F).
FOR CLOTHING, NAMELY, CAPS, COATS, DRESSES, HATS, JACKETS, JERSEYS, PANTS, SHIRTS, SHORTS, SKIRTS, SLEEPWEAR, SOCKS, SUITS AND VESTS (U.S. CLS. 22 AND 39).

FIRST USE 6-18-1994; IN COMMERCE 6-18-1994.
TEJBIR SINGH, EXAMINING ATTORNEY

CLASS 25—(Continued).

SN 77-446,365. FLORENCE, JAMES, DAYTON, OH. FILED 4-11-2008.



THE COLOR(S) RED, GRAY, AND BLACK IS/ARE CLAIMED AS A FEATURE OF THE MARK.

THE MARK CONSISTS OF THE COLORS GREY, BLACK, AND RED, WITH THE COLOR RED APPEARING AS THE NUMBER TWO IN THE MIDDLE OF THE MARK, THE WORD "UP" AT THE TOP OF THE MARK, AND AS THE BACKGROUND FOR THE MARK MAKING THE SHAPE OF A "P". THE COLOR GREY APPEARS IN THE MARK AS THE WORDS, "U", "GOT", "STAY", "DOWN", AND "COME", AS WELL AS IN THE BACKGROUND OF THE MARK AS A WHOLE, AND THE UPWARDS POINTING ARROW OF THE MARK. THE COLOR BLACK APPEARS IN THE MARK AS THE OUTLINE OF THE MARK AND THE WORDS OF THE MARK, AS WELL AS THE NUMBER TWO FOUND IN BETWEEN THE WORDS, "GOT" AND "STAY".

FOR T-SHIRTS (U.S. CLS. 22 AND 39).
CIMMERIAN COLEMAN, EXAMINING ATTORNEY

SN 77-441,719. H-CORPORATION, LUDLOW, MA. FILED 4-7-2008.

ACTIVE PRAYERS

THE MARK CONSISTS OF STANDARD CHARACTERS WITHOUT CLAIM TO ANY PARTICULAR FONT, STYLE, SIZE, OR COLOR.

FOR DANCE COSTUMES (U.S. CLS. 22 AND 39).
FIRST USE 4-1-2008; IN COMMERCE 4-1-2008.
BRIAN NEVILLE, EXAMINING ATTORNEY

SN 77-453,655. LB BRANDS, LLC, PORT CLYDE, ME. FILED 4-21-2008.

LINDA BEAN'S PERFECT MAINE

THE MARK CONSISTS OF STANDARD CHARACTERS WITHOUT CLAIM TO ANY PARTICULAR FONT, STYLE, SIZE, OR COLOR.

NO CLAIM IS MADE TO THE EXCLUSIVE RIGHT TO USE "MAINE", APART FROM THE MARK AS SHOWN.

THE NAME(S), PORTRAIT(S), AND/OR SIGNATURE(S) SHOWN IN THE MARK IDENTIFIES LINDA L. BEAN, WHOSE CONSENT(S) TO REGISTER IS SUBMITTED.

FOR CLOTHING, NAMELY, TOPS, BOTTOMS, HEADWEAR AND FOOTWEAR (U.S. CLS. 22 AND 39).
TIMOTHY FINNEGAN, EXAMINING ATTORNEY

CLASS 25—(Continued).

SN 77-464,599. LITTLE PHARO LLC, EAST BRUNSWICK, NJ. FILED 5-2-2008.



FOR CLOTHING FOR INFANTS AND CHILDREN, NAMELY, BABY BUNTING, BABY GOWNS FOR SLEEPING, FOOTED LEGGINGS, ONE-PIECE FOOTED BODYSUITS, ONE-PIECE BODYSUITS WITHOUT FEET, HATS, LEGGINGS, PANTS, LONG SLEEVE BODYSUITS, SHORT SLEEVE BODYSUITS, SLEEVELESS BODYSUITS, SHORT SLEEVE SHIRTS, LONG SLEEVE SHIRTS, ONE PIECE BABY ROMPERS (U.S. CLS. 22 AND 39).

FIRST USE 8-0-2008; IN COMMERCE 8-0-2008.
WILLIAM VERHOSEK, EXAMINING ATTORNEY

CLASS 25—(Continued).

SN 77-475,431. DE WOLF, ARTHUR, DEERFIELD, IL. FILED 5-15-2008.

Birdorable

THE MARK CONSISTS OF STANDARD CHARACTERS WITHOUT CLAIM TO ANY PARTICULAR FONT, STYLE, SIZE, OR COLOR.

FOR SHORT-SLEEVED OR LONG-SLEEVED T-SHIRTS; T-SHIRTS; HOODED SWEAT SHIRTS; SWEAT SHIRTS; HATS; TANK TOPS; BOXER SHORTS; APRONS; CLOTH BIBS (U.S. CLS. 22 AND 39).

FIRST USE 12-1-2006; IN COMMERCE 12-1-2006.
PAUL E. FAHRENKOPF, EXAMINING ATTORNEY

SN 77-481,651. VENOM, LLC, SAN FRANCISCO, CA. FILED 5-22-2008.

DEADLOCKE

THE MARK CONSISTS OF STANDARD CHARACTERS WITHOUT CLAIM TO ANY PARTICULAR FONT, STYLE, SIZE, OR COLOR.

FOR MEN'S, WOMEN'S AND CHILDREN'S CLOTHING AND HEADGEAR, NAMELY, SWEATBANDS; APRONS; ATHLETIC SHOES; BATHROBES; BATH THONGS; BASEBALL CAPS; BATHING SUITS; BELTS; BANDANNAS; BEACH COVER-UP DRESSES; BEACH SANDALS; BLAZERS; BOOTS; BOXER SHORTS; CAPS; CHILDREN'S FOOTWEAR; CLOTH DIAPERS; COATS; COLLARLESS SHIRTS; COSTUMES FOR USE IN ROLE PLAYING GAMES; COVERALLS; DRESSES; EAR MUFFS; EAR BANDS; EVENING TOPS; FITNESS TOPS; FOOTWEAR, NAMELY, ATHLETIC FOOTWEAR, BEACH FOOTWEAR, CLEATS FOR ATTACHMENT TO SPORTS SHOES, FLIP FLOPS, FOOTWEAR FOR TRACK AND FIELD ATHLETICS, GOLF CLEATS, GYMNASIATIC SHOES, RIDING BOOTS, SKI BOOTS, AND SNOWBOARD BOOTS; GOLF SHIRTS; GLOVES; HALLOWEEN COSTUMES; HATS; HEAD WEAR; HEADBANDS; HOSIERY; INFANT AND TODDLER SLEEPWEAR; JACKETS; JEANS; JERSEYS; JOGGING SUITS; JUMPSUITS; KNIT DRESSES WITH PANTS SETS; LEOTARDS; LEGWARMERS; LONG UNDERWEAR; MASQUERADE COSTUMES AND MASKS SOLD IN CONNECTION THEREWITH; LOUNGEWEAR; MITTENS; NECKTIES; NIGHTSHIRTS; OVERALLS; PAJAMAS; PANTS; PARKAS; PLAYSUITS; PULLOVERS; RAINWEAR, NAMELY, WATERPROOF PANTS AND WATERPROOF JACKETS; RAIN PONCHOS; RAIN JACKETS; ROMPERS; SCARVES; SHIRTS; SHOES; SHORTS, SHORTS AND TOP SETS; SKIRTS; SKIRT AND PANTY SETS; SKI AND CLOTH BIBS; SKI MASKS; SKI SUITS; SLACKS; SPORTS UNIFORMS; SLEEPWEAR; SLIPPERS; SOCK SUSPENDERS; SOCKS; GYM SUITS; SUSPENDERS; SWEATERS; SWEATPANTS; SWEATSHIRTS; SWIM WEAR; TANK TOPS; TIES; TIGHTS; T-SHIRTS; TURTLENECK SHIRTS; UNDERWEAR; VISORS; WARM-UP SUITS; WIND-RESISTANT JACKETS; WRISTBANDS; WORKOUT AND SPORTS APPAREL, NAMELY, SPORTS BRAS, JACKETS, JERSEYS, SHIRTS, SHORTS, YOGA PANTS AND YOGA SHIRTS (U.S. CLS. 22 AND 39).

ELISSA GARBER KON, EXAMINING ATTORNEY

SN 77-471,960. SHERIDAN, DANIEL CHARLES, WARETOWN, NJ. FILED 5-12-2008.



NO CLAIM IS MADE TO THE EXCLUSIVE RIGHT TO USE "COLLECTION", APART FROM THE MARK AS SHOWN.

THE NAME(S), PORTRAIT(S), AND/OR SIGNATURE(S) SHOWN IN THE MARK DOES NOT IDENTIFY A PARTICULAR LIVING INDIVIDUAL.

THE MARK CONSISTS OF THE LETTERS "JHC" IN STYLIZED FORMAT, BENEATH WHICH APPEAR THE WORDS "JEREMI HUNTER" AND "COLLECTION" ON SEPARATE LINES AND IN STYLIZED FORMAT.

FOR SPORT SHIRTS (U.S. CLS. 22 AND 39).
FIRST USE 5-23-2007; IN COMMERCE 5-23-2007.
JASON LOTT, EXAMINING ATTORNEY

CLASS 25—(Continued).

SN 77-489,919. CHEFWEAR, INC., CHICAGO, IL. FILED 6-3-2008.

CONVERTIBLE CHEFBAND

THE MARK CONSISTS OF STANDARD CHARACTERS WITHOUT CLAIM TO ANY PARTICULAR FONT, STYLE, SIZE, OR COLOR.

NO CLAIM IS MADE TO THE EXCLUSIVE RIGHT TO USE "CONVERTIBLE", APART FROM THE MARK AS SHOWN.

FOR HEAD SCARVES (U.S. CLS. 22 AND 39).
FIRST USE 10-0-2007; IN COMMERCE 10-0-2007.
JASON TURNER, EXAMINING ATTORNEY

SN 77-499,688. YUPOONG, INC., SEOUL, REPUBLIC OF KOREA, FILED 6-16-2008.

FLEXFIT THE ONE AND ONLY ORIGINAL

THE MARK CONSISTS OF STANDARD CHARACTERS WITHOUT CLAIM TO ANY PARTICULAR FONT, STYLE, SIZE, OR COLOR.

OWNER OF U.S. REG. NOS. 1,930,765, 2,904,572 AND OTHERS.

FOR HEADWEAR, NAMELY, HATS, CAPS, VISORS, BEANIES, BERETS, KNITTED CAPS AND SWEATBANDS AS PART OF HEADWEAR; CLOTHING AND CLOTHING ACCESSORIES, NAMELY, STANDALONE SWEATBANDS (U.S. CLS. 22 AND 39).

FIRST USE 1-0-2002; IN COMMERCE 1-0-2002.
TINA L. SNAPP, EXAMINING ATTORNEY

SN 77-504,069. IN CASES, INC., WOODINVILLE, WA. FILED 6-20-2008.

Cap-Sac

THE MARK CONSISTS OF STANDARD CHARACTERS WITHOUT CLAIM TO ANY PARTICULAR FONT, STYLE, SIZE, OR COLOR.

FOR HEADGEAR, NAMELY, HAT THAT FOLDS (U.S. CLS. 22 AND 39).
LAURA HAMMEL, EXAMINING ATTORNEY

CLASS 25—(Continued).

SN 77-505,587. LIEDTKA, ANNE C., UPPER MONTCLAIR, NJ. FILED 6-23-2008.



THE MARK CONSISTS OF A LETTER "A" THAT IS A UNIQUE DESIGN THAT EXTENDS OUTSIDE OF A FRAME. THE BALANCE OF THE LOGO IS DESIGNED TO BLEND WITH THE "A".

FOR HEAD SCARVES; SCARVES; SHOULDER SCARVES; SILK SCARVES (U.S. CLS. 22 AND 39).
REGINA DRUMMOND, EXAMINING ATTORNEY

SN 77-507,017. ALONZO, JAMES C, LENEXA, KS. FILED 6-24-2008.

PeaceGirl

THE MARK CONSISTS OF STANDARD CHARACTERS WITHOUT CLAIM TO ANY PARTICULAR FONT, STYLE, SIZE, OR COLOR.

FOR ATHLETIC APPAREL, NAMELY, SHIRTS, PANTS, JACKETS, FOOTWEAR, HATS AND CAPS, ATHLETIC UNIFORMS; BABY TOPS; BASEBALL CAPS; BEACH COVER-UPS; BEACHWEAR; BELTS; BELTS OF TEXTILE; BIKINIS; BLOUSES; BOXER BRIEFS; BOXER SHORTS; BRAS; BRIEFS; CAMISOLES; CANVAS SHOES; CAPRI PANTS; CAPRIS; CAPS WITH VISORS; CARGO PANTS; CHEMISES; CHILDREN'S AND INFANTS' CLOTH BIBS; CHILDREN'S HEADWEAR; COATS FOR MEN AND WOMEN; COATS MADE OF COTTON; COATS OF DENIM; CREWNECK SWEATERS; CREWNECKS; CROP TOPS; DENIM JACKETS; DENIMS; DOWN JACKETS; DRESSES; ESPADRILLES; FABRIC BELTS; FLEECE PULLOVERS; FLEECE VESTS; FLIP FLOPS; FOOTWEAR FOR MEN AND WOMEN; GLOVES; GOLF CAPS; GOLF SHIRTS; GOLF TROUSERS; HALTER TOPS; HATS; HEAD SCARVES; HEAD SWEATBANDS; HEADBANDS; HOODED PULLOVERS; HOODED SWEAT SHIRTS; INFANT AND TODDLER ONE PIECE CLOTHING; INFANTS' SHOES AND BOOTS; JACKETS; JEANS; JOGGING OUTFITS; JOGGING SUITS; KERCHIEFS; LADIES' UNDERWEAR; LINGERIE; LONG UNDERWEAR; MEN'S AND WOMEN'S JACKETS, COATS, TROUSERS, VESTS; MINISKIRTS; MITTENS; MOISTURE-WICKING SPORTS BRAS; MOISTURE-WICKING SPORTS PANTS; MOISTURE-

CLASS 25—(Continued).

WICKING SPORTS SHIRTS; NECKERCHIEFS; NEGLIGEEES; NIGHT SHIRTS; NIGHTGOWNS; NIGHTIES; ONE PIECE GARMENT FOR INFANTS AND TODDLERS; OPEN-NECKED SHIRTS; OUTDOOR GLOVES; PAJAMA BOTTOMS; PAJAMAS; PANTIES; PANTIES, SHORTS AND BRIEFS; PEDAL PUSHERS; PERSPIRATION ABSORBENT UNDERWEAR CLOTHING; POLO SHIRTS; PULLOVERS; ROBES; SANDAL-CLOGS; SANDALS; SARONGS; SCARVES; SHIRTS; SHOES; SHORT-SLEEVED OR LONG-SLEEVED T-SHIRTS; SHORT-SLEEVED SHIRTS; SHORTS; SKI JACKETS; SKI PANTS; SKIRTS; SKIRTS AND DRESSES; SLEEP SHIRTS; SNEAKERS; SNOWBOARD PANTS; SOCKS; SPORTS BRA; SPORTS BRAS; SPORTS JERSEYS; SPORTS PANTS; SPORTS SHIRTS; SWEAT BANDS; SWEAT JACKETS; SWEAT PANTS; SWEAT SHIRTS; SWEAT SUITS; SWEATBANDS; SWIM WEAR FOR GENTLEMEN AND LADIES; SWIMMING TRUNKS; T-SHIRTS; TANK TOPS; TANK-TOPS; TAP PANTS; TEDDIES; TEE SHIRTS; TURTLENECK SWEATERS; TURTLENECKS; UNDERWEAR, NAMELY, BOY SHORTS (U.S. CLS. 22 AND 39).
ARETHA SOMERVILLE, EXAMINING ATTORNEY

SN 77-510,444. ARMORED STRIPES, DANVILLE, CA. FILED 6-27-2008.

Armored Stripes

THE MARK CONSISTS OF STANDARD CHARACTERS WITHOUT CLAIM TO ANY PARTICULAR FONT, STYLE, SIZE, OR COLOR.

NO CLAIM IS MADE TO THE EXCLUSIVE RIGHT TO USE "STRIPES", APART FROM THE MARK AS SHOWN. FOR BELTS; HATS; JACKETS; PANTS; SHIRTS; SHOES; SHORTS; SWEAT SHIRTS (U.S. CLS. 22 AND 39).
FIRST USE 2-21-2008; IN COMMERCE 2-28-2008.
TRACY CROSS, EXAMINING ATTORNEY

SN 77-528,076. PARIS ACCESSORIES, INC., NEW YORK, NY. FILED 7-22-2008.



THE MARK CONSISTS OF "DREAM E-Z" WHICH IS WRITTEN IN STYLIZED FONT AND IS LOCATED IN THE MIDDLE. THERE ARE TWO LAMBS AND A CLOUD DISPLAYED WITHIN THE CIRCLE.

FOR CLOTHING, NAMELY, SOCKS, FOOTWEAR AND HOISERY (U.S. CLS. 22 AND 39).
FIRST USE 3-10-2008; IN COMMERCE 3-10-2008.
KAREN BRACEY, EXAMINING ATTORNEY

CLASS 25—(Continued).

SN 77-533,225. DENISE MILLER, DBA MOTORBABE, CHANDLER, AZ. FILED 7-29-2008.



THE COLOR(S) PINK, WHITE, BLACK, AND GRAY IS/ARE CLAIMED AS A FEATURE OF THE MARK.

THE MARK CONSISTS OF PINK LIPS WITH WHITE HIGHLIGHTS. IN THE CENTER OF THE LIPS IS A BLACK HEART SHAPE. ONE EITHER SIDE OF THE LIPS ARE WINGS IN WHITE AND BLACK. ABOVE THE DESIGN IS THE WORD "MOTORBABE" IN A STYLIZED FONT IN PINK, OUTLINED IN WHITE AND SHADOWED IN GRAY FOR WEARABLE GARMENTS AND CLOTHING, NAMELY, SHIRTS (U.S. CLS. 22 AND 39).

FIRST USE 9-27-2007; IN COMMERCE 5-28-2008.
ERNEST SHOSHO, EXAMINING ATTORNEY

SN 77-538,331. MONROE, LAURA, BINGHAMTON, NY. FILED 8-4-2008.



THE MARK CONSISTS OF THE WORDING "SHAMROCK STRENGTH AND CONDITIONING". THERE ARE TWO SHAMROCK DESIGNS DIVIDING THE WORD "SHAMROCK" FROM THE PHRASE "STRENGTH AND CONDITIONING"; THERE IS A LIKENESS OF A TALL LEPRECHAUN-STRONGMAN PUSHING A LARGE TIRE.

FOR CLOTHING, NAMELY, SWEATPANTS, T-SHIRTS, MESH SHORTS, COMPRESSION CREW SHIRTS, COOLING PERFORMANCE CREW SHIRTS, SOCKS, WRESTLING SINGLET, HATS, VISORS, HEADBANDS (U.S. CLS. 22 AND 39).

FIRST USE 5-3-2007; IN COMMERCE 8-6-2007.
LINDA E. BLOHM, EXAMINING ATTORNEY

CLASS 25—(Continued).

SN 77-540,260. HAUTE HOME, LLC, SAN FRANCISCO, CA.
FILED 8-6-2008.

HAUTE HOME

THE MARK CONSISTS OF STANDARD CHARACTERS WITHOUT CLAIM TO ANY PARTICULAR FONT, STYLE, SIZE, OR COLOR.

NO CLAIM IS MADE TO THE EXCLUSIVE RIGHT TO USE "HOME", APART FROM THE MARK AS SHOWN.

FOR LOUNGEWEAR; NIGHT GOWNS; NIGHTWEAR; PAJAMAS (U.S. CLS. 22 AND 39).

FIRST USE 5-1-2000; IN COMMERCE 5-1-2000.

JOHN DALIER, EXAMINING ATTORNEY

CLASS 25—(Continued).

SN 77-544,504. ABRAMS, ARLENE, NEW YORK, NY. AND LEVY, EFRATH E., NEW YORK, NY. FILED 8-12-2008.

TRIXIE & JANE

THE MARK CONSISTS OF STANDARD CHARACTERS WITHOUT CLAIM TO ANY PARTICULAR FONT, STYLE, SIZE, OR COLOR.

THE NAME(S), PORTRAIT(S), AND/OR SIGNATURE(S) SHOWN IN THE MARK DOES NOT IDENTIFY A PARTICULAR LIVING INDIVIDUAL.

FOR CLOTHING, NAMELY, ARM COVERS IN THE NATURE OF SLEEVES, AND CAMISOLES (U.S. CLS. 22 AND 39).

ALYSSA STEEL, EXAMINING ATTORNEY

SN 77-541,825. TORO BOOTS LLC, HOUSTON, TX. FILED 8-7-2008.



NO CLAIM IS MADE TO THE EXCLUSIVE RIGHT TO USE "BOTAS", APART FROM THE MARK AS SHOWN.

THE MARK CONSISTS OF A BIRD NEXT TO THE SPANISH PHRASE "BOTAS ESPOLON DE ORO".

THE ENGLISH TRANSLATION OF THE WORD "BOTAS ESPOLON DE ORO" IN THE MARK IS "BOOTS GOLDEN FETLOCK".

FOR BOOTS (U.S. CLS. 22 AND 39).

FIRST USE 9-14-2001; IN COMMERCE 9-14-2001.

BRIAN NEVILLE, EXAMINING ATTORNEY

SN 77-546,124. WARNACO U.S., INC., MILFORD, CT. FILED 8-13-2008.

SHAPESTITCH

SN 77-543,279. NEXXEN APPAREL, INC., LOS ANGELES, CA. FILED 8-10-2008.

PINK CLOVER

THE MARK CONSISTS OF STANDARD CHARACTERS WITHOUT CLAIM TO ANY PARTICULAR FONT, STYLE, SIZE, OR COLOR.

NO CLAIM IS MADE TO THE EXCLUSIVE RIGHT TO USE "PINK", APART FROM THE MARK AS SHOWN.

FOR KNIT SHIRTS; PANTS; SKIRTS AND DRESSES; TOPS (U.S. CLS. 22 AND 39).

INGA ERVIN, EXAMINING ATTORNEY

THE MARK CONSISTS OF STANDARD CHARACTERS WITHOUT CLAIM TO ANY PARTICULAR FONT, STYLE, SIZE, OR COLOR.

FOR LATTICE-TYPE ELASTIC INSERTS SOLD AS A PART OF BRASSIERES (U.S. CLS. 22 AND 39).

KEVON CHISOLM, EXAMINING ATTORNEY

CLASS 25—(Continued).

SN 77-546,247. ZABLOUDIL, KATHERINE CAROLINE, DBA C.Z. FALCONER, BEVERLY HILLS, CA. FILED 8-13-2008.

CLASS 25—(Continued).

SN 77-547,041. CLARIN-HARRISON LLC, VENTURA, CA. FILED 8-14-2008.

C.Z. FALCONER



THE MARK CONSISTS OF THE STYLIZED WORDS "THE DREJ".

FOR MEN'S, WOMEN'S, AND CHILDREN'S CLOTHING, NAMELY, BATHING SUITS, BIKINIS, HOODED SWEAT SHIRTS, JEANS, SHIRTS, SHORTS, TANKINIS, AND T-SHIRTS, COACHES' CAPS, WOOL HATS, PAINTERS' CAPS, BEACH HATS, BASEBALL CAPS, VISORS, BATHING AND SWIM CAPS, NOVELTY HEADWEAR WITH ATTACHED WIGS, RUGBY SHIRTS, GOLF SHIRTS, SPORTS SHIRTS, POLO SHIRTS, SHOOTING SHIRTS, WOVEN AND KNIT SHIRTS, BLOUSES, TURTLENECKS, HALTERS, TANK TOPS, FLEECE TOPS, SWEATERS, SLEEPWEAR, LOUNGE WEAR, NAMELY, NIGHT SHIRTS, PAJAMAS, NIGHT GOWNS, BATHROBES; PANTIES, SLACKS, SLIPS, CAMISOLES, LINGERIE, DRESSING GOWNS, LEATHER JACKETS, JACKETS, WIND RESISTANT JACKETS, FLEECE JACKETS, PARKAS, SNOW SUITS, WARM-UP SUITS, WARM-UP PANTS, WARM-UP TOPS, SWEAT SUITS, SWEATSHIRTS, SWEATPANTS, JOGGING SUITS, PONCHOS, CAPES, SHAWLS, WRAPAROUNDS, COATS, RAINCOATS, BODYSUITS, SHORTS, PANTS, JEANS, DRESSES, SKIRTS, VESTS, JUMPERS, OVERALLS, INFANT WEAR, BIBS NOT MADE OF PAPER, SOCKS, HOSIERY, LEGGINGS, TIGHTS, LEOTARDS, STOCKINGS, UNDERWEAR, BOXER SHORTS, SWIMWEAR, BEACHWEAR, SANDALS, BEACH SANDALS, SWIM TRUNKS, BATHING TRUNKS, BOARD SHORTS, WET SUITS, BEACH COVER-UPS, BATHING SUIT COVER-UPS, HEADBANDS, BANDANNAS, BELTS, NECKTIES, WRISTBANDS, ARM BANDS, GLOVES, MITTENS, EAR MUFFS, SCARVES, APRONS, CLOTH BIBS, AND SLEEP MASKS (U.S. CLS. 22 AND 39).

ODESSA BIBBINS, EXAMINING ATTORNEY

THE MARK CONSISTS OF STANDARD CHARACTERS WITHOUT CLAIM TO ANY PARTICULAR FONT, STYLE, SIZE, OR COLOR.

THE NAME "C.Z. FALCONER" DOES NOT IDENTIFY A LIVING INDIVIDUAL.

FOR BABY TOPS; CAPRI PANTS; CARGO PANTS; CREW NECK SWEATERS; DENIMS; DRESS SHIRTS; HALTER TOPS; HOODED SWEAT SHIRTS; JOGGING PANTS; JUMPSUITS; KNIT SHIRTS; LONG-SLEEVED SHIRTS; LOUNGE PANTS; MOCK TURTLE-NECK SWEATERS; PANTS; PIQUE SHIRTS; POLO SHIRTS; RUGBY SHIRTS; RUGBY TOPS; SHIRTS; SHORT-SLEEVED OR LONG-SLEEVED T-SHIRTS; SHORT-SLEEVED SHIRTS; SKIRTS; SLEEP SHIRTS; SPORT SHIRTS; SPORTS PANTS; SPORTS SHIRTS; SPORTS SHIRTS WITH SHORT SLEEVES; STRETCH PANTS; SWEAT PANTS; SWEAT SHIRTS; SWEATERS; SWIMSUITS; T-SHIRTS; TANK TOPS; TEE SHIRTS; TOPS; TRAVEL CLOTHING CONTAINED IN A PACKAGE COMPRISING REVERSIBLE JACKETS, PANTS, SKIRTS, TOPS AND A BELT OR SCARF; TURTLENECK SWEATERS; V-NECK SWEATERS; WEARABLE GARMENTS AND CLOTHING, NAMELY, SHIRTS; YOGA PANTS; YOGA SHIRTS (U.S. CLS. 22 AND 39).

KEVON CHISOLM, EXAMINING ATTORNEY

SN 77-550,048. LEE, BRYAN L., DBA CHANDRAN HOLDING MEDIA, INC., LAS VEGAS, NV. FILED 8-19-2008.

Maybe...

THE MARK CONSISTS OF STANDARD CHARACTERS WITHOUT CLAIM TO ANY PARTICULAR FONT, STYLE, SIZE, OR COLOR.

FOR LINGERIE (U.S. CLS. 22 AND 39).

KIMBERLY PERRY, EXAMINING ATTORNEY

CLASS 25—(Continued).

SN 77-551,051. OLSON, MIKE, SHELBURNE, VT. FILED 8-19-2008.



THE MARK CONSISTS OF A STYLIZED DESIGN OUTLINE OF THE STATE OF VERMONT WITH THE WORDS "KEEP VERMONT WEIRD" REPRESENTED IN STYLIZED FONT APPEARING ACROSS THE DESIGN.

FOR HATS; TEE SHIRTS (U.S. CLS. 22 AND 39).
WARREN L. OLANDRIA, EXAMINING ATTORNEY

CLASS 25—(Continued).

SN 77-552,286. OLD PIRATES, LLC, GOLDSBORO, NC. FILED 8-21-2008.



NO CLAIM IS MADE TO THE EXCLUSIVE RIGHT TO USE "TRADING COMPANY", APART FROM THE MARK AS SHOWN.

THE MARK CONSISTS OF A DRAWING OF A PIRATE'S HEAD LISTED ABOVE THE LITERAL ELEMENTS "OLD PIRATES" LISTED ABOVE THE LITERAL ELEMENTS "TRADING COMPANY".

FOR CLOTHING, NAMELY, SHIRTS AND UNDERGARMENTS (U.S. CLS. 22 AND 39).
KELLEY WELLS, EXAMINING ATTORNEY

SN 77-552,133. SHENZHEN ORIENTAL FASHION CO., LTD, SHENZHEN CITY, CHINA, FILED 8-21-2008.



THE MARK CONSISTS OF THE WORD "OMNIALUO" WITH FOUR CHINESE CHARACTERS AND A DESIGN IN THE NATURE OF STYLIZED BIRD WINGS.

THE TERM "OMNIALUO" HAS NO MEANING IN A FOREIGN LANGUAGE.

THE NON-LATIN CHARACTERS IN THE MARK TRANSLITERATE INTO "OU"; "BO"; "LAN"; "NU" AND IN ENGLISH THIS MEANS EUROPE; CYPRESS; ORCHID; SERVANT. THE FOUR CHARACTERS TOGETHER HAVE NO MEANING IN A FOREIGN LANGUAGE.

FOR SHIRTS; SUITS; TROUSERS; SKIRTS; DRESSES; EVENING DRESSES; FUR COATS AND JACKETS; HEADGEAR, NAMELY, HATS, CAPS; OVERCOATS; SHAPEWEAR, NAMELY, GIRDLES; SCARVES; SPORTS JERSEYS; DUST COATS; DOWN JACKETS; SWEATERS; MASQUERADE COSTUMES (U.S. CLS. 22 AND 39).
AMY ALFIERI, EXAMINING ATTORNEY

SN 77-554,358. KAISER, KENNETH M., DBA BABO SHIRTS, CHICAGO, IL. FILED 8-24-2008.

BaboShirts

THE MARK CONSISTS OF THE WORDS "BABO" AND "SHIRTS" WRITTEN TOGETHER WITH NO SPACE AS "BABOSHIRTS". THE FONT USED FOR THIS MARK IS COOPER BLACK. THE "B" IN "BABO" AND "S" IN "SHIRTS" ARE TO BE CAPITALIZED.

FOR SHORT-SLEEVED OR LONG-SLEEVED T-SHIRTS (U.S. CLS. 22 AND 39).
FIRST USE 12-1-2007; IN COMMERCE 12-1-2007.
EDWARD NELSON, EXAMINING ATTORNEY

CLASS 25—(Continued).

SN 77-556,025. OZMUN, FRANK, BROOKLYN, NY. FILED 8-26-2008.

BLACKLETTER

THE MARK CONSISTS OF STANDARD CHARACTERS WITHOUT CLAIM TO ANY PARTICULAR FONT, STYLE, SIZE, OR COLOR.

FOR CLOTHING, NAMELY, T-SHIRTS AND LONG SLEEVE SHIRTS (U.S. CLS. 22 AND 39).

LYDIA BELZER, EXAMINING ATTORNEY

SN 77-556,300. B.B. BLISS, HINGHAM, MA. FILED 8-26-2008.

B.B. BLISS

THE MARK CONSISTS OF STANDARD CHARACTERS WITHOUT CLAIM TO ANY PARTICULAR FONT, STYLE, SIZE, OR COLOR.

THE NAME "B.B. BLISS" DOES NOT IDENTIFY A LIVING INDIVIDUAL.

FOR INFANT'S HEADWEAR; INFANT AND TODDLER ONE PIECE CLOTHING (U.S. CLS. 22 AND 39).

JENNY PARK, EXAMINING ATTORNEY

SN 77-557,665. TELLAR, STEVE, WEST HARTFORD, CT. FILED 8-28-2008.



THE STIPLING IS FOR SHADING PURPOSES ONLY. THE MARK CONSISTS OF AN IMAGE OF EARTH. ABOVE THE EARTH IS THE STYLIZED WORD "EARTH SPACE". BELOW THE EARTH IS THE STYLIZED WORDS "YOU ARE HERE". AFTER THE WORD "HERE", THERE IS AN IMAGE OF A ARROW POINTING TOWARDS THE EARTH.

FOR ORGANIC CLOTHING, NAMELY, T-SHIRTS, HATS, SWEAT SHIRTS, SHORTS (U.S. CLS. 22 AND 39).

KYLE PEETE, EXAMINING ATTORNEY

CLASS 25—(Continued).

SN 77-557,675. TARRANT, GEOFFREY, LAS VEGAS, NV. FILED 8-28-2008.

HARDWEAR
clothing industries

NO CLAIM IS MADE TO THE EXCLUSIVE RIGHT TO USE "CLOTHING INDUSTRIES", APART FROM THE MARK AS SHOWN.

THE MARK CONSISTS OF THE STYLIZED WORDS "HARDWEAR CLOTHING INDUSTRIES".

FOR CLOTHING, NAMELY, SHORT AND LONG SLEEVE T-SHIRTS, TANK TOPS, JERSEYS, PULL OVER SWEAT SHIRTS AND ZIP UP SWEAT SHIRTS, SOCKS, HATS, BEANIES, WRIST BANDS, BOARD SHORTS, BANDANAS, WIND RESISTANT JACKETS, JACKETS, COLLARED SHIRTS AND SWEATPANTS (U.S. CLS. 22 AND 39).

JENNIFER VASQUEZ, EXAMINING ATTORNEY

SN 77-558,761. JOSHUA HELMAN, M.D., LAKE MARY, FL. FILED 8-29-2008.

I'm a free-market kind of
guy

THE MARK CONSISTS OF STANDARD CHARACTERS WITHOUT CLAIM TO ANY PARTICULAR FONT, STYLE, SIZE, OR COLOR.

FOR CLOTHING, FOR MEN AND CHILDREN, NAMELY, PAJAMAS, NIGHTSHIRTS, ROBES, JOGGING SUITS, SWEAT SUITS, WARM UP SUITS, BEACHWEAR, T-SHIRTS, SWEATSHIRTS, JERSEYS, TANK TOPS, SHIRTS, SHORTS, BOXER SHORTS, TROUSERS, PANTS, JUMPERS, OVERALLS, ROMPERS, SHORT SETS COMPRISED OF SHORTS AND TOPS, SWEATERS, CARDIGANS, JACKETS, COATS, ANORAKS, PONCHOS, RAINCOATS, VESTS, HEADWEAR, HATS AND CAPS, VISORS, TIES, BELTS AND SUSPENDERS, SOCKS, GLOVES, MITTENS, APRONS, SWIMSUITS, CLOTH BABY BIBS, FOOTWEAR, ATHLETIC SHOES, ATHLETIC UNIFORMS, SLIPPERS, AND MASQUERADE COSTUMES (U.S. CLS. 22 AND 39).

JULIE GUTTADAURO, EXAMINING ATTORNEY

CLASS 25—(Continued).

SN 77-558,772. JOSHUA HELMAN, M.D., LAKE MARY, FL. FILED 8-29-2008.

I'm a free-market kind of girl

THE MARK CONSISTS OF STANDARD CHARACTERS WITHOUT CLAIM TO ANY PARTICULAR FONT, STYLE, SIZE, OR COLOR.

FOR CLOTHING, FOR WOMEN AND CHILDREN, NAMELY, PAJAMAS, NIGHTSHIRTS, ROBES, JOGGING SUITS, SWEAT SUITS, WARM UP SUITS, BEACHWEAR, T-SHIRTS, SWEATSHIRTS, JERSEYS, TANK TOPS, SHIRTS, BLOUSES, SHORTS, BOXER SHORTS, TROUSERS, PANTS, JUMPERS, OVERALLS, ROMPERS, DRESSES, SKIRTS, SHORT SETS COMPRISED OF SHORTS AND TOPS, SWEATERS, CARDIGANS, JACKETS, COATS, ANORAKS, PONCHOS, RAINCOATS, SCARVES, BANDANNAS, UNDERWEAR, VESTS, HEADWEAR, HATS AND CAPS, VISORS, TIES, BELTS AND SUSPENDERS, SOCKS, TIGHTS, LEGGINGS, GLOVES, MITTENS, APRONS, SWIMSUITS, CLOTH BABY BIBS, FOOTWEAR, ATHLETIC SHOES, ATHLETIC UNIFORMS, SLIPPERS, AND MASQUERADE COSTUMES (U.S. CLS. 22 AND 39).

JULIE GUTTADAURO, EXAMINING ATTORNEY

SN 77-558,839. OH, HYUH KEUN, SEOUL, REPUBLIC OF KOREA, FILED 8-29-2008.

Butterflower

THE MARK CONSISTS OF STANDARD CHARACTERS WITHOUT CLAIM TO ANY PARTICULAR FONT, STYLE, SIZE, OR COLOR.

FOR BELTS; DRESSES; HATS; JACKETS; LINGERIE; PANTS; SCARVES; SHIRTS; SHOES; SOCKS; SWIMSUITS (U.S. CLS. 22 AND 39).

FIRST USE 6-30-2008; IN COMMERCE 6-30-2008.

HEATHER BIDDULPH, EXAMINING ATTORNEY

SN 77-558,842. PABLO, TIM, CHULA VISTA, CA. FILED 8-29-2008.

Diamonds and Gypsies

THE MARK CONSISTS OF STANDARD CHARACTERS WITHOUT CLAIM TO ANY PARTICULAR FONT, STYLE, SIZE, OR COLOR.

FOR CLOTHING, NAMELY, SHIRTS, SWEAT SUITS, SWEATERS, FLEECE SWEAT SHIRTS, JACKETS, COATS, PANTS, HATS, BEANIES AND BELTS (U.S. CLS. 22 AND 39).

HEATHER BIDDULPH, EXAMINING ATTORNEY

CLASS 25—(Continued).

SN 77-558,960. MARIO BATALI, NEW YORK, NY. FILED 8-29-2008.



OWNER OF U.S. REG. NOS. 2,788,274 AND 2,894,188. THE MARK CONSISTS OF MARIO BATALI SIGNATURE. FOR SHOES (U.S. CLS. 22 AND 39). FIRST USE 9-24-2007; IN COMMERCE 9-24-2007. SKYE YOUNG, EXAMINING ATTORNEY

SN 77-559,160. THUNDER BEACH PRODUCTIONS, INC., PANAMA CITY BEACH, FL. FILED 8-29-2008.

THUNDER BEACH

THE MARK CONSISTS OF STANDARD CHARACTERS WITHOUT CLAIM TO ANY PARTICULAR FONT, STYLE, SIZE, OR COLOR.

OWNER OF U.S. REG. NO. 2,884,361. FOR T-SHIRTS, SHIRTS, TOPS, HATS AND CAPS (U.S. CLS. 22 AND 39).

FIRST USE 0-0-2001; IN COMMERCE 0-0-2001.

RENEE MCCRAY, EXAMINING ATTORNEY

SN 77-560,160. RIVERSIDE MANUFACTURING COMPANY, MOULTRIE, GA. FILED 9-2-2008.



Your Source For Quality Uniforms

OWNER OF U.S. REG. NOS. 1,142,634, 2,737,525 AND OTHERS.

THE MARK CONSISTS OF AN IMAGE OF A GLOBE WITH THE WORD "RIVERSIDE" APPEARING IN THE GLOBE AND THE WORDS "YOUR SOURCE FOR QUALITY UNIFORMS" APPEARING UNDER THE GLOBE.

FOR UNIFORMS; WEARING APPAREL, NAMELY, SHIRTS, PANTS, JACKETS, JUMPSUITS, CAPS, BLOUSES AND BLAZERS (U.S. CLS. 22 AND 39).

FIRST USE 0-0-2002; IN COMMERCE 0-0-2002.

BARBARA BROWN, EXAMINING ATTORNEY

CLASS 25—(Continued).

SN 77-560,171. MOWDER, KAREN, SYKESVILLE, MD.
FILED 9-2-2008.



THE MARK CONSISTS OF A TRIBAL LIKE SYMBOL OF A WOMAN RIDING A MOTORCYCLE ABOVE THE WORDING "HARD CLASS".
FOR CLOTHING, NAMELY, SHIRTS, HATS, LEATHER RIDING JACKETS, CHAPS, PAJAMAS, SWEAT SHIRTS (U.S. CLS. 22 AND 39).
HELENE LIWINSKI, EXAMINING ATTORNEY

SN 77-560,197. BORGES ENTERPRISES, INC., ORLANDO, FL. FILED 9-2-2008.

**Bona Fide Fight and Sports
Wear**

THE MARK CONSISTS OF STANDARD CHARACTERS WITHOUT CLAIM TO ANY PARTICULAR FONT, STYLE, SIZE, OR COLOR.
NO CLAIM IS MADE TO THE EXCLUSIVE RIGHT TO USE "FIGHT AND SPORTS WEAR", APART FROM THE MARK AS SHOWN.
FOR CAPS; JACKETS; MARTIAL ARTS UNIFORMS; SHIRTS; SHORTS (U.S. CLS. 22 AND 39).
MARK PILARO, EXAMINING ATTORNEY

SN 77-560,211. ASHER, DONAVAN, NORTHRIDGE, CA. FILED 9-2-2008.

FOREVER EVOLVING

THE MARK CONSISTS OF STANDARD CHARACTERS WITHOUT CLAIM TO ANY PARTICULAR FONT, STYLE, SIZE, OR COLOR.
FOR BELTS; CAPS; DRESSES; JACKETS; JEANS; POLO SHIRTS; SHORTS; SKIRTS; SWEAT PANTS; SWEAT SHIRTS; T-SHIRTS; UNDERGARMENTS (U.S. CLS. 22 AND 39).
FIRST USE 3-1-2008; IN COMMERCE 4-2-2008.
FONG HSU, EXAMINING ATTORNEY

CLASS 25—(Continued).

SN 77-560,222. PASSARO, JOHN, SHERMAN OAKS, CA. FILED 9-2-2008.



THE STIPPLING IS FOR SHADING PURPOSES ONLY. THE MARK CONSISTS OF THE STYLIZED TEXT "GREEN" INSIDE A CIRCLE AND A LINE DIAGONALLY ACROSS THE CIRCLE. ON THE BOTTOM THE STYLIZED TEXT "NOGREENAUTOLAWS.COM" APPEARS.
FOR HATS; TEE SHIRTS (U.S. CLS. 22 AND 39).
KATHERINE CHANG, EXAMINING ATTORNEY

SN 77-560,229. LIVING ON THE EDGE INC, WEATHERFORD, TX. FILED 9-2-2008.

UNRESTRICTED SOUL

THE MARK CONSISTS OF STANDARD CHARACTERS WITHOUT CLAIM TO ANY PARTICULAR FONT, STYLE, SIZE, OR COLOR.
FOR BANDANAS; BELTS; CAPS; FOOTWEAR; HATS; JACKETS; PANTS; SHORTS; T-SHIRTS (U.S. CLS. 22 AND 39).
SUZANNE BLANE, EXAMINING ATTORNEY

SN 77-560,418. POCKX, LLC, ST. LOUIS, MO. FILED 9-2-2008.

**WEAR 'EM SHARE 'EM TRADE
'EM CHANGE 'EM**

THE MARK CONSISTS OF STANDARD CHARACTERS WITHOUT CLAIM TO ANY PARTICULAR FONT, STYLE, SIZE, OR COLOR.
FOR CLOTHING, NAMELY, JEANS (U.S. CLS. 22 AND 39).
ANNE MADDEN, EXAMINING ATTORNEY

CLASS 25—(Continued).

SN 77-561,001. GREG BORDES, BALTIMORE, MD. FILED 9-3-2008.

Realadelphia

THE MARK CONSISTS OF STANDARD CHARACTERS WITHOUT CLAIM TO ANY PARTICULAR FONT, STYLE, SIZE, OR COLOR.

FOR ATHLETIC APPAREL, NAMELY, SHIRTS, PANTS, JACKETS, FOOTWEAR, HATS AND CAPS, ATHLETIC UNIFORMS (U.S. CLS. 22 AND 39).

FIRST USE 5-7-2004; IN COMMERCE 8-11-2004.
HOWARD FRIEDMAN, EXAMINING ATTORNEY

SN 77-561,148. AMERICAN TOP TEAM, LLC, FORT LAUDERDALE, FL. FILED 9-3-2008.



OWNER OF U.S. REG. NO. 2,673,439.
NO CLAIM IS MADE TO THE EXCLUSIVE RIGHT TO USE "AMERICAN", APART FROM THE MARK AS SHOWN.
THE COLOR(S) BLACK, WHITE, RED AND BLUE IS/ARE CLAIMED AS A FEATURE OF THE MARK.

THE MARK CONSISTS OF A CIRCLE INSIDE OF ANOTHER CIRCLE. THE OUTER CIRCLE IS OUTLINED IN WHITE WITH A BLACK BACKGROUND. THE WORD "AMERICAN" IN WHITE CURVES AROUND THE TOP OF THE OUTER CIRCLE AND THE WORDS "TOP TEAM" IN WHITE CURVE AROUND THE BOTTOM OF THE OUTER CIRCLE. THERE IS A WHITE DOT IN THE MIDDLE OF THE LEFT OUTER CIRCLE AS WELL AS THE MIDDLE RIGHT OF THE OUTER CIRCLE SEPARATING THE WORD "AMERICAN" FROM "TOP TEAM". THE INNER CIRCLE CONSISTS OF ALTERNATING RED AND WHITE LINES THAT COMPRISE THE TOP LEFT QUARTER AND THE BOTTOM HALF OF THE INNER CIRCLE. THE TOP LEFT QUARTER OF THE INNER CIRCLE IS BLUE WITH WHITE STARS. THE INNER CIRCLE APPEARS AMERICAN FLAG LIKE AND ON TOP OF THE FLAG LIKE IMAGE IN THE CENTER OF THE INNER CIRCLE THERE IS A BLACK IMAGE OF A MAN HOLDING HIS ARMS UP.

FOR SHIRTS; SHORT-SLEEVED OR LONG-SLEEVED T-SHIRTS; SHORTS; T-SHIRTS (U.S. CLS. 22 AND 39).
FIRST USE 3-18-2002; IN COMMERCE 3-18-2002.
MICHAEL WEBSTER, EXAMINING ATTORNEY

CLASS 25—(Continued).

SN 77-561,263. SIEGAL, LAURA B., MANHASSET, NY. AND SIEGAL, MATTHEW W., MANHASSET, NY. FILED 9-3-2008.

NICE BÄT

THE MARK CONSISTS OF STANDARD CHARACTERS WITHOUT CLAIM TO ANY PARTICULAR FONT, STYLE, SIZE, OR COLOR.

THE ENGLISH TRANSLATION OF THE WORD BÄT IN THE MARK IS "DAUGHTER".

FOR CLOTHING FOR MEN, WOMEN AND CHILDREN, NAMELY, T-SHIRTS, SHIRTS, TANK TOPS, SWEATSHIRTS, SWEATPANTS, SHORTS, BOXER SHORTS, PAJAMA BOTTOMS; HEADGEAR, NAMELY, HATS, CAPS (U.S. CLS. 22 AND 39).

KIM MONINGHOFF, EXAMINING ATTORNEY

SN 77-561,660. CARSOPH S.A. DE C.V., 52998, HUIXQUILUCAN, MEXICO, FILED 9-3-2008.



THE MARK CONSISTS OF THE STYLIZED WORDING "BEAUTYLICIOUS BY BODYSIGNER".

FOR UNDERGARMENTS; UNDERCLOTHES; GIRDLES; SHAPEWEAR, NAMELY, JEANS WITH ABDOMINAL CONTROL; SHAPEWEAR, NAMELY, SKIRTS WITH ABDOMINAL CONTROL; SHAPEWEAR, NAMELY, PANTS WITH ABDOMINAL CONTROL AND GLUTEUS PUSH UP; SWIMSUITS; PAJAMAS; UNDERWEAR; BODY SHAPING SHIRTS; DRESSES; JERSEYS (U.S. CLS. 22 AND 39).

RONALD MCMORROW, EXAMINING ATTORNEY

CLASS 25—(Continued).

SN 77-562,150. ERINDAY LOYD, DBA LILYDAYS, AUSTIN, TX. FILED 9-4-2008.



THE COLOR(S) RASPBERRY PURPLE, YELLOW, PINK, BLACK, SILVER, WHITE AND BROWN IS/ARE CLAIMED AS A FEATURE OF THE MARK.

THE MARK CONSISTS OF RASPBERRY PURPLE OUTSPREAD WINGS, A BLACK CROWN, BLACK SWIRLS, GRADUATED YELLOW-TO-PINK COLOR STYLIZED SPLATTER FONT FOR THE WORDING "CHERUB", STYLIZED SCRIPT BLACK FONT FOR THE WORDING "WILD", WHITE BLOCK FONT FOR THE WORDING "DANGEROUSLY SO" WHICH APPEARS INSIDE A BLACK BOX, AND A SILVER SWORD WITH A BROWN HANDLE.

FOR INFANT AND TODDLER ONE PIECE CLOTHING; SHORT-SLEEVED OR LONG-SLEEVED T-SHIRTS (U.S. CLS. 22 AND 39).

YAT SYE, LEE, EXAMINING ATTORNEY

SN 77-562,258. ROBAR INC., NEW YORK, NY. FILED 9-4-2008.

Mini-Muffin

THE MARK CONSISTS OF STANDARD CHARACTERS WITHOUT CLAIM TO ANY PARTICULAR FONT, STYLE, SIZE, OR COLOR.

FOR CHILDREN'S CLOTHING, NAMELY, SLEEPWEAR, PAJAMAS, ROBES AND NIGHTGOWNS, PANTS, COVERALLS, JUMPSUITS, INFANTWEAR, OVERALLS, CLOTH BIBS, SHORTS, CREEPERS, ROMPERS AND SUNSUITS, OUTERWEAR, NAMELY, JACKETS, SNOWSUITS AND SWEATSUITS, TOPS, SWEATERS, DRESSES, SKIRTS, JUMPERS, BELTS, SOCKS, BOOTIES, HOSIERY, NECK TIES, SUSPENDERS, HEADWEAR, GLOVES AND FOOTWEAR (U.S. CLS. 22 AND 39).

APRIL ROACH, EXAMINING ATTORNEY

CLASS 25—(Continued).

SN 77-562,465. KIPNES, STUART, CHICAGO, IL. FILED 9-4-2008.

There's Always This Year

THE MARK CONSISTS OF STANDARD CHARACTERS WITHOUT CLAIM TO ANY PARTICULAR FONT, STYLE, SIZE, OR COLOR.

FOR CLOTHING, NAMELY, T-SHIRTS, JERSEYS, HATS, CAPS, SHIRTS AND SWEATSHIRTS (U.S. CLS. 22 AND 39).

DAVID YONTEF, EXAMINING ATTORNEY

SN 77-562,472. 2BB UNLIMITED, INC., DBA MIMO, LOS ANGELES, CA. FILED 9-4-2008.



THE MARK CONSISTS OF NUMBER "2" FOLLOWED BY LETTERS "BB" OR "bb".

FOR A-SHIRTS; AFTER SKI BOOTS; ANKLE BOOTS; ANKLE SOCKS; ANKLETS; ANTI-PERSPIRANT SOCKS; ATHLETIC APPAREL, NAMELY, SHIRTS, PANTS, JACKETS, FOOTWEAR, HATS AND CAPS, ATHLETIC UNIFORMS; ATHLETIC FOOTWEAR; BABY TOPS; BALLOON PANTS; BASELAYER TOPS; BATHING SUITS; BATHING SUITS FOR MEN; BEACH FOOTWEAR; BED JACKETS; BELTS; BELTS MADE OF LEATHER; BELTS OF TEXTILE; BERMUDA SHORTS; BIB OVERALLS; BIBS NOT OF CLOTH OR PAPER; BICYCLE GLOVES; BICYCLING GLOVES; BOARD SHORTS; BODY SUITS; BOLO TIES; BOMBER JACKETS; BOOTS; BOW TIES; BOXER SHORTS; BRIDESMAID DRESSES; BRIEFS; BUSTLE HOLDER BANDS FOR OBI (OBIAGE); BUTT-FRONT ALOHA SHIRTS; CAMP SHIRTS; CAPRI PANTS; CAPRIS; CAPS; CARDIGANS; CARGO PANTS; CHEF'S HATS; CHILDREN'S AND INFANTS' CLOTH BIBS; CHILDREN'S CLOTH EATING BIBS; CLIMBING BOOTS; CLOTH BIBS; CLOTH BIBS FOR ADULT DINERS; CLOTH BIBS FOR USE BY SENIOR CITIZENS OR PHYSICALLY- OR MENTALLY-CHALLENGED PERSONS; CLOTH DIAPERS; CLOTHING FOR WEAR IN JUDO PRACTICES; CLOTHING FOR WEAR IN WRESTLING GAMES; CLOTHING, NAMELY, ARM WARMERS; CLOTHING, NAMELY, FOLK COSTUMES; CLOTHING, NAMELY, HAND-WARMERS; CLOTHING, NAMELY, KHAKIS; CLOTHING, NAMELY, KNEE WARMERS; CLOTHING, NAMELY, NECK TUBES; CLOTHING, NAMELY, THOBES; CLOTHING, NAMELY, WRAP-AROUNDS; COATS OF DENIM; CORSETS; COSTUMES FOR USE IN CHILDREN'S DRESS UP PLAY; CREW NECK SWEATERS; CROP TOPS; CROSS-COUNTRY GLOVES; CYCLISTS' JERSEYS; DENIM JACKETS; DENIMS; DISPOSABLE UNDERWEAR; DOWN JACKETS; DRESS SHIELDS; DRESS SHIRTS; DRESS SUITS; DRESSES; DRESSES MADE FROM SKINS; DRESSING GOWNS; DRY SUITS; DUSTERS; EAR WARMERS; EVENING DRESSES; EYESHADES; FABRIC BELTS; FISHERMEN'S JACKETS; FISHING VESTS; FITTED SHOE OR BOOT COVERING TO PROTECT THE SHOES OR BOOT FROM WATER OR OTHER DAMAGE;

CLASS 25—(Continued).

FLEECE SHORTS; FLEECE VESTS; FLIGHT SUITS; FLIP FLOPS; FOOTBALL BOOTS AND STUDS THEREFOR; FOOTWEAR; FOOTWEAR FOR MEN; FOOTWEAR FOR MEN AND WOMEN; FOOTWEAR FOR TRACK AND FIELD ATHLETICS; FOOTWEAR FOR WOMEN; FOOTWEAR MADE OF WOOD; FOOTWEAR NOT FOR SPORTS; FOOTWEAR, NAMELY, PUMPS; FOOTWEAR, NAMELY, RUBBERS; FOOTWEAR, NAMELY, WORK BOOTS; FOULARDS; FUR COATS AND JACKETS; FUR HATS; FUR JACKETS; GARTER BELTS; GLOVES; GLOVES FOR PERSONAL HAND CONDITIONING USE; GLOVES INCLUDING THOSE MADE OF SKIN, HIDE OR FUR; GOLF SHIRTS; GYM SHORTS; GYM SUITS; HALTER TOPS; HAT BANDS; HATS; HEAVY JACKETS; HIKING BOOTS; HOODED SWEAT SHIRTS; HOODS; HORSE-RIDING BOOTS; HUNTING BOOT BAGS; HUNTING VESTS; INFANT AND TODDLER ONE PIECE CLOTHING; INFANT CLOTH DIAPERS; INFANTS' SHOES AND BOOTS; INSOLES; JACKET LINERS; JACKETS; JACKETS AND SOCKS; JAPANESE FOOTWEAR OF RICE STRAW (WARAJI); JAPANESE SPLIT-TOED WORK FOOTWEAR (JIKATABI); JAPANESE STYLE SOCKS (TABI COVERS); JAPANESE STYLE SOCKS (TABI); JEANS; JERSEYS; JOGGING PANTS; JOGGING SUITS; JUDO SUITS; JUMPERS; KARATE SUITS; KNIT SHIRTS; KNITTED UNDERWEAR; LACE BOOTS; LADIES' BOOTS; LADIES' SUITS; LADIES' UNDERWEAR; LEATHER BELTS; LEATHER JACKETS; LEATHER PANTS; LEG SHAPERS; LEG WARMERS; LEG-WARMERS; LEGGINGS; LIGHT-REFLECTING JACKETS; LINGERIE; LINGERIE ACCESSORIES, NAMELY, REMOVABLE SILICONE BREAST ENHANCER PADS USED IN A BRA; LONG JACKETS; LONG SLEEVED VESTS; LONG UNDERWEAR; LONG-SLEEVED SHIRTS; LOUNGE PANTS; MANTLES; MATERNITY LINGERIE; MATERNITY SLEEPWEAR; MEN'S AND WOMEN'S JACKETS, COATS, TROUSERS, VESTS; MEN'S SOCKS; MEN'S SUITS; MEN'S SUITS, WOMEN'S SUITS; MOCK TURTLE-NECK SWEATERS; MOISTURE-WICKING SPORTS PANTS; MOISTURE-WICKING SPORTS SHIRTS; MONEY BELTS; MOTOR-CYCLE GLOVES; MOTORCYCLIST BOOTS; MOUNTAINEERING BOOTS; MUFFLERS; MUSCLE TOPS; NECK BANDS; NIGHT SHIRTS; NON-DISPOSABLE CLOTH TRAINING PANTS; NURSE DRESSES; NURSE OVERALLS; NURSE PANTS; ONE-PIECE PLAY SUITS; OPEN-NECKED SHIRTS; OUTDOOR GLOVES; OVERALLS; PADDED JACKETS; PADDING JACKETS; PANTIES, SHORTS AND BRIEFS; PANTS; PAPER HATS FOR USE AS CLOTHING ITEMS; PAPER SHOES USED WHEN GOING THROUGH METAL DETECTORS TO KEEP FEET AND SOCKS CLEAN; PARTS OF CLOTHING, NAMELY, GUSSETS FOR TIGHTS, GUSSETS FOR STOCKINGS, GUSSETS FOR BATHING SUITS, GUSSETS FOR UNDERWEAR, GUSSETS FOR LEOTARDS AND GUSSETS FOR FOOTLETS; PERSPIRATION ABSORBENT UNDERWEAR CLOTHING; PETTI-PANTS; PIQUE SHIRTS; PLAY SUITS; PLEATED SKIRTS FOR FORMAL KIMONOS (HAKAMA); POLO SHIRTS; PROTECTIVE METAL MEMBERS FOR SHOES AND BOOTS; PUMPS; QUILTED VESTS; RAIN BOOTS; RAIN JACKETS; RAIN SUITS; RAINPROOF JACKETS; REVERSIBLE JACKETS; RIDING BOOTS; RIDING GLOVES; RUGBY SHIRTS; RUGBY SHORTS; RUGBY TOPS; SASH BANDS FOR KIMONO (OBI); SCIENTIFIC AND TECHNOLOGICAL APPAREL, NAMELY, SHIRTS, PANTS, JACKETS, FOOTWEAR, HATS AND CAPS, UNIFORMS; SEDGE HATS (SUGE-GASA); SHELL JACKETS; SHIRTS; SHIRT FRONTS; SHIRT YOKES; SHIRTS; SHIRTS FOR SUITS; SHORT OVERCOAT FOR KIMONO (HAORI); SHORT PETTICOATS; SHORT SETS; SHORT TROUSERS; SHORT-SLEEVED OR LONG-SLEEVED T-SHIRTS; SHORT-SLEEVED SHIRTS; SHORTS; SHOULDER WRAPS; SKI BOOT BAGS; SKI BOOTS; SKI GLOVES; SKI JACKETS; SKI PANTS; SKI SUITS; SKI SUITS FOR COMPETITION; SKIRT SUITS; SKIRTS; SKIRTS AND DRESSES; SLEEP SHIRTS; SLEEPWEAR; SLEEVED OR SLEEVELESS JACKETS; SLEEVELESS JERSEYS; SLIDING SHORTS; SMALL HATS; SMOKING JACKETS; SNOW BOARDING SUITS; SNOW BOOTS; SNOW PANTS; SNOW SUITS; SNOWBOARD BOOTS; SNOWBOARD GLOVES; SNOWBOARD PANTS; SOCCER BOOTS; SOCK SUSPENDERS; SOCKS; SOCKS AND STOCKINGS; SOLES FOR FOOTWEAR; SPORT SHIRTS; SPORTS JACKETS; SPORTS JERSEYS; SPORTS JERSEYS AND BREECHES FOR SPORTS; SPORTS PANTS; SPORTS SHIRTS; SPORTS SHIRTS WITH SHORT

CLASS 25—(Continued).

SLEEVES; STRETCH PANTS; STUFF JACKETS; SUEDE JACKETS; SUIT COATS; SUITS; SUITS OF LEATHER; SUSPENDER BELTS FOR MEN; SUSPENDER BELTS FOR WOMEN; SWADDLING CLOTHES; SWEAT BANDS; SWEAT JACKETS; SWEAT PANTS; SWEAT SHIRTS; SWEAT SHORTS; SWEAT SUITS; SWEATERS; T-SHIRTS; TANK TOPS; TANK-TOPS; TAP PANTS; TEE SHIRTS; THERMAL SOCKS; THERMAL UNDERWEAR; THONGS; THONGS; TIES; TIPS FOR FOOTWEAR; TOBoggan HATS, PANTS AND CAPS; TONGUE OR PULLSTRAP FOR SHOES AND BOOTS; TOP COATS; TOPS; TRACK JACKETS; TRACK PANTS; TRACK SUITS; TRAINING SUITS; TRAVEL CLOTHING CONTAINED IN A PACKAGE COMPRISING REVERSIBLE JACKETS, PANTS, SKIRTS, TOPS AND A BELT OR SCARF; TRIATHLON CLOTHING, NAMELY, TRIATHLON TIGHTS, TRIATHLON SHORTS, TRIATHLON SINGLET, TRIATHLON SHIRTS, TRIATHLON SUITS; TUBE TOPS; TURTLENECK SWEATERS; TUXEDO BELTS; UNDERARM CLOTHING SHIELDS; UNDERWEAR; UNDERWEAR, NAMELY, BOY SHORTS; UNION SUITS; V-NECK SWEATERS; VEST EXTENDERS; VESTED SUITS; VESTS; WAIST BELTS; WALKING SHORTS; WARM UP SUITS; WATER SOCKS; WATER-PROOF JACKETS AND PANTS; WEARABLE GARMENTS AND CLOTHING, NAMELY, SHIRTS; WEDDING DRESSES; WET SUIT GLOVES; WET SUITS; WET SUITS FOR WATER-SKIING AND SUB-AQUA; WIND PANTS; WIND RESISTANT JACKETS; WIND SHIRTS; WIND VESTS; WIND-JACKETS; WINTER BOOTS; WOMEN'S CEREMONIAL DRESSES; WOMEN'S UNDERWEAR; WOOLLEN SOCKS; WOOLLY HATS; WORK SHOES AND BOOTS; WORKING OVERALLS; WOVEN OR KNITTED UNDERWEAR; WRAP BELTS FOR KIMONOS (DATEMAKI); WRAPS; WRIST BANDS; YOGA PANTS; YOGA SHIRTS; ZOOT SUITS (U.S. CLS. 22 AND 39).

PRISCILLA MILTON, EXAMINING ATTORNEY

SN 77-562,517. GOTHAM LICENSING GROUP, LLC, NEW YORK, NY. FILED 9-4-2008.

LOVE, Charlotte

THE MARK CONSISTS OF STANDARD CHARACTERS WITHOUT CLAIM TO ANY PARTICULAR FONT, STYLE, SIZE, OR COLOR.

FOR DRESS SHIRTS; DRESS SUITS; DRESSES; JEANS; PANTS; SKIRTS; TOPS (U.S. CLS. 22 AND 39).

WILLIAM VERHOSEK, EXAMINING ATTORNEY

CLASS 25—(Continued).

SN 77-562,643. EMORY CLOTHIER LLC, WASHINGTON, DC. FILED 9-4-2008.

ATOPYUS

THE MARK CONSISTS OF STANDARD CHARACTERS WITHOUT CLAIM TO ANY PARTICULAR FONT, STYLE, SIZE, OR COLOR.

THE TERM "ATOPYUS" IS A COINED TERM WITH NO MEANING IN ENGLISH.

FOR ATHLETIC APPAREL, NAMELY, SHIRTS, PANTS, JACKETS, FOOTWEAR, HATS AND CAPS, ATHLETIC UNIFORMS (U.S. CLS. 22 AND 39).

FIRST USE 8-1-2008; IN COMMERCE 8-1-2008.
LINDA M. KING, EXAMINING ATTORNEY

SN 77-562,712. EMORY CLOTHIER LLC, WASHINGTON, DC. FILED 9-4-2008.

E. MORY COLLECTION

THE MARK CONSISTS OF STANDARD CHARACTERS WITHOUT CLAIM TO ANY PARTICULAR FONT, STYLE, SIZE, OR COLOR.

NO CLAIM IS MADE TO THE EXCLUSIVE RIGHT TO USE "COLLECTION", APART FROM THE MARK AS SHOWN.

THE NAME "E. MORY" DOES NOT IDENTIFY A LIVING INDIVIDUAL.

FOR ATHLETIC APPAREL, NAMELY, SHIRTS, PANTS, JACKETS, FOOTWEAR, HATS AND CAPS, ATHLETIC UNIFORMS (U.S. CLS. 22 AND 39).

FIRST USE 8-1-2008; IN COMMERCE 8-1-2008.
LINDA M. KING, EXAMINING ATTORNEY

SN 77-562,741. NATALIE SANDERS, LINCOLN, CA. FILED 9-4-2008.

PEEK AWAY

THE MARK CONSISTS OF STANDARD CHARACTERS WITHOUT CLAIM TO ANY PARTICULAR FONT, STYLE, SIZE, OR COLOR.

FOR NURSING APPAREL, NAMELY, NURSING AND BREASTFEEDING COVERS (U.S. CLS. 22 AND 39).

STEPHEN AQUILA, EXAMINING ATTORNEY

CLASS 25—(Continued).

SN 77-562,978. THE SPOILED CHILD LIMITED, LOS ANGELES, CA. FILED 9-5-2008.



NO CLAIM IS MADE TO THE EXCLUSIVE RIGHT TO USE "LIMITED", APART FROM THE MARK AS SHOWN.

THE COLOR(S) RED, BLACK IS/ARE CLAIMED AS A FEATURE OF THE MARK.

THE MARK CONSISTS OF THE STYLIZED WORDS "THE SPOILED CHILD LIMITED" PRESENTED ON FOUR LINES WITH THE LETTER "S" IN "SPOILED" APPEARING AS A RED "S" SIGN, AND THE LETTER "C" IN "CHILD" APPEARING AS A RED "c" SIGN WITH THE REMAINING LETTERS IN BLACK. A VERTICAL LINE IS FORMED FROM THE LETTER "H" IN "THE" THROUGH THE LETTER "L" IN "SPOILED," THROUGH THE LETTER "L" IN "CHILD," AND THROUGH THE LETTER "T" IN "LIMITED".

FOR T-SHIRTS (U.S. CLS. 22 AND 39).
LINDA POWELL, EXAMINING ATTORNEY

SN 77-563,135. WESTMOOR MFG. CO., FORT WORTH, TX. FILED 9-5-2008.

PANHANDLE

THE MARK CONSISTS OF STANDARD CHARACTERS WITHOUT CLAIM TO ANY PARTICULAR FONT, STYLE, SIZE, OR COLOR.

OWNER OF U.S. REG. NOS. 1,500,621 AND 1,504,935.
FOR SHIRTS (U.S. CLS. 22 AND 39).

FIRST USE 10-1-2007; IN COMMERCE 10-1-2007.
DOUGLAS LEE, EXAMINING ATTORNEY

SN 77-563,195. THE SARAH BROOKS CORPORATION, DBA SARAH BROOKS INK, ATLANTA, GA. FILED 9-5-2008.

Hide-ees

THE MARK CONSISTS OF STANDARD CHARACTERS WITHOUT CLAIM TO ANY PARTICULAR FONT, STYLE, SIZE, OR COLOR.

FOR CLOTHING, NAMELY, CHILDREN'S UNDERGARMENTS (U.S. CLS. 22 AND 39).

LINDSEY RUBIN, EXAMINING ATTORNEY

CLASS 25—(Continued).

SN 77-563,364. WILLIAMS, PATRICK, RIVERIA BEACH, FL. FILED 9-5-2008.



THE MARK CONSISTS OF THE LETTER "O" ABOVE THE MINUS SIGN WHICH REPRESENTS THE WORD NEGATIVE.
FOR CLOTHING, NAMELY, T-SHIRTS, CAPS, HATS, PANTS, SKIRTS AND SHORTS (U.S. CLS. 22 AND 39).
CARYN GLASSER, EXAMINING ATTORNEY

SN 77-563,446. KALINOWSKI, ANDRE G, SUMMERLAND, CA. FILED 9-5-2008.

REHAB SUCKS

THE MARK CONSISTS OF STANDARD CHARACTERS WITHOUT CLAIM TO ANY PARTICULAR FONT, STYLE, SIZE, OR COLOR.
FOR BEANIES; HEADWEAR; JACKETS; PANTS; POLO SHIRTS; SHORT-SLEEVED OR LONG-SLEEVED T-SHIRTS; SWEAT PANTS; SWEAT SHIRTS; SWEATERS; T-SHIRTS (U.S. CLS. 22 AND 39).
JACLYN KIDWELL, EXAMINING ATTORNEY

CLASS 25—(Continued).

SN 77-563,448. ABERCROMBIE & FITCH TRADING CO., NEW ALBANY, OH. FILED 9-5-2008.

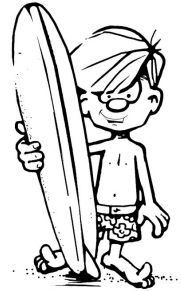

THE MARK CONSISTS OF A PERSON HOLDING A SURFBOARD.
FOR BELTS; BIKINIS; BOTTOMS; BOXER SHORTS; CAMISOLES; CAPS; COATS; FLEECE PULLOVERS; FLEECE SHORTS; FLIP FLOPS; FOOTWEAR; HALTER TOPS; HATS; HOODED SWEAT SHIRTS; JACKETS; JEANS; KNIT SHIRTS; LEGGINGS; LOUNGE PANTS; LOUNGEWEAR; MINISKIRTS; PAJAMA BOTTOMS; PANTS; POLO SHIRTS; SHIRTS; SHOES; SHORT-SLEEVED OR LONG-SLEEVED T-SHIRTS; SHORT-SLEEVED SHIRTS; SHORTS; SKIRTS; STRETCH PANTS; SWEAT PANTS; SWEAT SHIRTS; SWEAT SHORTS; SWEATERS; SWIM WEAR; SWIMMING TRUNKS; SWIMWEAR; T-SHIRTS; TANK TOPS; UNDERSHIRTS; UNDERWEAR; YOGA PANTS; YOGA SHIRTS (U.S. CLS. 22 AND 39).
LIEF MARTIN, EXAMINING ATTORNEY

SN 77-564,074. BRAND EARTH, MEDFORD, OR. FILED 9-7-2008.

BRAND EARTH

THE MARK CONSISTS OF STANDARD CHARACTERS WITHOUT CLAIM TO ANY PARTICULAR FONT, STYLE, SIZE, OR COLOR.
NO CLAIM IS MADE TO THE EXCLUSIVE RIGHT TO USE "BRAND", APART FROM THE MARK AS SHOWN.
FOR T-SHIRTS (U.S. CLS. 22 AND 39).
KARANENDRA S. CHHINA, EXAMINING ATTORNEY

CLASS 25—(Continued).

SN 77-564,143. TOLERATE SOCIAL DEVIANCE, BALTIMORE, MD. FILED 9-7-2008.



THE MARK CONSISTS OF FACE WITH BROKEN SHACKLE AND CHAINS ABOVE HEAD, TOLERATE SOCIAL DEVIANCE WRITTEN IN FOREHEAD OF FACE WITH WEBSITE, WWW.TSDNOW.BELOW FACE.

FOR TEE SHIRTS (U.S. CLS. 22 AND 39).
FIRST USE 5-3-2008; IN COMMERCE 6-21-2008.
SHAILA SETTLES, EXAMINING ATTORNEY

SN 77-564,192. THE TRUSTEES OF WESTMINSTER SCHOOL, INCORPORATED, SIMSBURY, CT. FILED 9-8-2008.

GRIT AND GRACE

THE MARK CONSISTS OF STANDARD CHARACTERS WITHOUT CLAIM TO ANY PARTICULAR FONT, STYLE, SIZE, OR COLOR.

FOR CLOTHING, NAMELY, SWEATSHIRTS, T-SHIRTS, HATS (U.S. CLS. 22 AND 39).
JACQUELINE A. LAVINE, EXAMINING ATTORNEY

CLASS 25—(Continued).

SN 77-564,245. ELEVEN9 CLOTHING COMPANY LLC, DBA ELEVEN9, ANTIOCH, TN. FILED 9-8-2008.

somewear

THE MARK CONSISTS OF STANDARD CHARACTERS WITHOUT CLAIM TO ANY PARTICULAR FONT, STYLE, SIZE, OR COLOR.

FOR ANKLETS; ATHLETIC APPAREL, NAMELY, SHIRTS, PANTS, JACKETS, FOOTWEAR, HATS AND CAPS, ATHLETIC UNIFORMS; BALLOON PANTS; BERMUDA SHORTS; BOARD SHORTS; BOXER SHORTS; CAPRI PANTS; CARGO PANTS; CHEF'S HATS; DENIMS; DRESS SHIRTS; FLEECE SHORTS; FUR HATS; GOLF SHIRTS; GYM SHORTS; HAT BANDS; HATS; HOODED SWEAT SHIRTS; INFANT AND TODDLER ONE PIECE CLOTHING; INFANT DIAPER COVERS; INFANT SLEEPERS; INFANT WEAR; JACKETS AND SOCKS; JOGGING PANTS; KNIT SHIRTS; KNITTED UNDERWEAR; LADIES' UNDERWEAR; LEATHER PANTS; LONG UNDERWEAR; LONG-SLEEVED SHIRTS; LOUNGE PANTS; MEN'S SOCKS; MOISTURE-WICKING SPORTS PANTS; MOISTURE-WICKING SPORTS SHIRTS; NIGHT SHIRTS; OPEN-NECKED SHIRTS; PANTIES, SHORTS AND BRIEFS; PANTS; PARTS OF CLOTHING, NAMELY, GUSSETS FOR TIGHTS, GUSSETS FOR STOCKINGS, GUSSETS FOR BATHING SUITS, GUSSETS FOR UNDERWEAR, GUSSETS FOR LEOTARDS AND GUSSETS FOR FOOTLETS; PIQUE SHIRTS; POLO SHIRTS; RUGBY SHIRTS; RUGBY SHORTS; SHIRTS; SHORT OVERCOAT FOR KIMONO (HAORI); SHORT PETTICOATS; SHORT SETS; SHORT TROUSERS; SHORT-SLEEVED OR LONG-SLEEVED T-SHIRTS; SHORT-SLEEVED SHIRTS; SHORTS; SKIRTS; SKIRTS AND DRESSES; SNOW PANTS; SNOWBOARD PANTS; SOCKS; SOCKS AND STOCKINGS; SPORT SHIRTS; SPORTS PANTS; SPORTS SHIRTS; SPORTS SHIRTS WITH SHORT SLEEVES; STRETCH PANTS; SWEAT PANTS; SWEAT SHIRTS; SWEAT SHORTS; T-SHIRTS; TEE SHIRTS; THERMAL UNDERWEAR; THONGS; TRACK PANTS; UNDERWEAR; UNDERWEAR, NAMELY, BOY SHORTS; WALKING SHORTS; WOMEN'S UNDERWEAR; WOVEN OR KNITTED UNDERWEAR (U.S. CLS. 22 AND 39).

RICHARD A. STRASER, EXAMINING ATTORNEY

SN 77-564,301. BRUCE P. WASHBURN, FORSYTH, IL. FILED 9-8-2008.

GOT RING

THE MARK CONSISTS OF STANDARD CHARACTERS WITHOUT CLAIM TO ANY PARTICULAR FONT, STYLE, SIZE, OR COLOR.

FOR CLOTHING, NAMELY, T-SHIRTS, SWEATSHIRTS, AND CAPS (U.S. CLS. 22 AND 39).
WARREN L. OLANDRIA, EXAMINING ATTORNEY

CLASS 25—(Continued).

SN 77-564,346. NEUVILLE INDUSTRIES, INC., HICKORY, NC. FILED 9-8-2008.

PEDIQUETTE

THE MARK CONSISTS OF STANDARD CHARACTERS WITHOUT CLAIM TO ANY PARTICULAR FONT, STYLE, SIZE, OR COLOR.

OWNER OF U.S. REG. NOS. 934,511, 2,312,529 AND OTHERS.

FOR FOOTWEAR; HOSIERY; INSOLES; SHOE INSERTS FOR PRIMARILY NON-ORTHOPEDIC PURPOSES; SOCKS (U.S. CLS. 22 AND 39).

MARTHA FROMM, EXAMINING ATTORNEY



SN 77-564,352. NEUVILLE INDUSTRIES, INC., HICKORY, NC. FILED 9-8-2008.

COMFORT FOR WORKING FEET

THE MARK CONSISTS OF STANDARD CHARACTERS WITHOUT CLAIM TO ANY PARTICULAR FONT, STYLE, SIZE, OR COLOR.

FOR FOOTWEAR; HOSIERY; INSOLES; SHOE INSERTS FOR PRIMARILY NON-ORTHOPEDIC PURPOSES; SOCKS (U.S. CLS. 22 AND 39).

MARTHA FROMM, EXAMINING ATTORNEY



SN 77-564,433. NAM C. QUACH, SAN FRANCISCO, CA. AND CHARLENE CHEN, SAN FRANCISCO, CA. FILED 9-8-2008.

CINCHETTE

THE MARK CONSISTS OF STANDARD CHARACTERS WITHOUT CLAIM TO ANY PARTICULAR FONT, STYLE, SIZE, OR COLOR.

FOR CLOTHING, NAMELY, PANTS, DRESSES, BODY SHAPERS, CORSETS AND PANTYHOSE (U.S. CLS. 22 AND 39).

AISHA SALEM, EXAMINING ATTORNEY

CLASS 25—(Continued).

SN 77-564,440. NAM C. QUACH, SAN FRANCISCO, CA. AND CHARLENE CHEN, SAN FRANCISCO, CA. FILED 9-8-2008.

ANEW

THE MARK CONSISTS OF STANDARD CHARACTERS WITHOUT CLAIM TO ANY PARTICULAR FONT, STYLE, SIZE, OR COLOR.

FOR CLOTHING, NAMELY, PANTS, DRESSES, BODY SHAPERS, CORSETS AND PANTYHOSE (U.S. CLS. 22 AND 39).

JASON LOTT, EXAMINING ATTORNEY



SN 77-564,461. NAM C. QUACH, SAN FRANCISCO, CA. AND CHARLENE CHEN, SAN FRANCISCO, CA. FILED 9-8-2008.



FOR CLOTHING, NAMELY, PANTS, DRESSES, BODY SHAPERS, CORSETS AND PANTYHOSE (U.S. CLS. 22 AND 39).

AISHA SALEM, EXAMINING ATTORNEY



SN 77-564,529. ITEMS BY VON WEIL, NEW YORK, NY. FILED 9-8-2008.

VON WEIL

THE MARK CONSISTS OF STANDARD CHARACTERS WITHOUT CLAIM TO ANY PARTICULAR FONT, STYLE, SIZE, OR COLOR.

THE NAME "VON WEIL" DOES NOT IDENTIFY A LIVING INDIVIDUAL.

FOR COLLARS, REMOVABLE COLLARS, SHRUGS, STOLES, SHAWLS, HEAD SCARVES, JABOTS COLLARS AND BOWS TIES, HATS, BRIDAL WEAR, BELTS, GLOVES, DRESSES, BLOUSES, PANTS, GOWNS, VESTS, SKIRTS, PONCHOS, JEWED TIES (U.S. CLS. 22 AND 39).

FIRST USE 6-0-1984; IN COMMERCE 6-0-1984.

JOHN WILKE, EXAMINING ATTORNEY

CLASS 25—(Continued).

SN 77-564,591. WOLFPACK HUSTLE, INC., LOS ANGELES, CA. FILED 9-8-2008.



THE STIPPLING IS FOR SHADING PURPOSES ONLY. THE MARK CONSISTS OF THE STYLIZED TEXT "WOLFPACK HUSTLE." WITH A SKYLINE ON THE UPPER LEFT SIDE AND A CYCLIST RIDING A BICYCLE NEXT TO A DIAGONAL LINE ON THE LOWER LEFT SIDE. FOR CAPS; GLOVES; HATS; JERSEYS; PANTS; SHOES; SHORTS; T-SHIRTS (U.S. CLS. 22 AND 39). FIRST USE 11-6-2006; IN COMMERCE 5-7-2007. TINA KUAN, EXAMINING ATTORNEY

SN 77-564,603. FORGED THREADWORKS, INC., SAN DIEGO, CA. FILED 9-8-2008.

FORGED THREADWORKS

THE MARK CONSISTS OF STANDARD CHARACTERS WITHOUT CLAIM TO ANY PARTICULAR FONT, STYLE, SIZE, OR COLOR. FOR APPAREL, NAMELY, BANDANAS; CAPS; DENIMS; FOOTWEAR; HATS; JACKETS; PANTS; SHIRTS; SHORTS; SWEAT PANTS; SWEAT SHIRTS; T-SHIRTS; AND TANK TOPS (U.S. CLS. 22 AND 39). ERIN FALK, EXAMINING ATTORNEY

SN 77-564,641. CLUB Z, INC., NEW YORK, NY. FILED 9-8-2008.

Spiaggia Dolce

THE MARK CONSISTS OF STANDARD CHARACTERS WITHOUT CLAIM TO ANY PARTICULAR FONT, STYLE, SIZE, OR COLOR. NO CLAIM IS MADE TO THE EXCLUSIVE RIGHT TO USE "SPIAGGIA", APART FROM THE MARK AS SHOWN. THE FOREIGN WORDING IN THE MARK TRANSLATES INTO ENGLISH AS SWEET BEACH. FOR GIRLS AND WOMENS COVER UPS (U.S. CLS. 22 AND 39). FIRST USE 9-2-2008; IN COMMERCE 9-2-2008. BRENDAN MCCAULEY, EXAMINING ATTORNEY

CLASS 25—(Continued).

SN 77-564,663. AT WORK SALES CORPORATION, IRONDALE, AL. FILED 9-8-2008.



OWNER OF U.S. REG. NO. 2,161,809. NO CLAIM IS MADE TO THE EXCLUSIVE RIGHT TO USE "BRAND", APART FROM THE MARK AS SHOWN. THE MARK CONSISTS OF SHADOW BLOCK LETTERING OF FIRST TWO WORDS IN THE MARK IN A SEMICIRCLE POSITION ABOVE THE LAST WORD OF THE MARK. FOR CLOTHING, NAMELY, PANTS, SKIRTS, BLOUSES, DRESSES, SHIRTS, TUXEDO SHIRTS, T-SHIRTS, CAPS, TIES, ARM BANDS, VESTS, APRONS AND JACKETS (U.S. CLS. 22 AND 39). FIRST USE 9-20-2007; IN COMMERCE 9-20-2007. NICHOLAS ALTREE, EXAMINING ATTORNEY

SN 77-564,695. CARLI, DONNA, CORVALLIS, OR. FILED 9-8-2008.

Only the best go Yard

THE MARK CONSISTS OF STANDARD CHARACTERS WITHOUT CLAIM TO ANY PARTICULAR FONT, STYLE, SIZE, OR COLOR. FOR ATHLETIC APPAREL, NAMELY, SHIRTS, PANTS, JACKETS, FOOTWEAR, HATS AND CAPS, ATHLETIC UNIFORMS; BASEBALL CAPS (U.S. CLS. 22 AND 39). FIRST USE 12-1-2007; IN COMMERCE 2-11-2008. KEVIN DINALLO, EXAMINING ATTORNEY

SN 77-564,797. LANDAU UNIFORMS, INCORPORATED, OLIVE BRANCH, MS. FILED 9-8-2008.



THE MARK CONSISTS OF THE STYLIZED WORDS "LIVE SWEET" WITH THE LETTER "S" OF THE WORD "SWEET" BEING FORMED AS PART OF A STYLIZED BUTTERFLY. FOR WOMEN'S CLOTHING FOR HEALTH CARE PROFESSIONALS, NAMELY, PANTS, TOPS, WARM-UP JACKETS, NON-SURGICAL SCRUBS, AND T-SHIRTS (U.S. CLS. 22 AND 39). FIRST USE 8-1-2008; IN COMMERCE 8-1-2008. TRACY FLETCHER, EXAMINING ATTORNEY

CLASS 25—(Continued).

SN 77-564,805. LANDAU UNIFORMS, INCORPORATED, OLIVE BRANCH, MS. FILED 9-8-2008.

LIVE SWEET

THE MARK CONSISTS OF STANDARD CHARACTERS WITHOUT CLAIM TO ANY PARTICULAR FONT, STYLE, SIZE, OR COLOR.

FOR WOMEN'S CLOTHING FOR HEALTH CARE PROFESSIONALS, NAMELY, PANTS, TOPS, WARM-UP JACKETS, NON-SURGICAL SCRUBS, AND T-SHIRTS (U.S. CLS. 22 AND 39).

FIRST USE 8-1-2008; IN COMMERCE 8-1-2008.
TRACY FLETCHER, EXAMINING ATTORNEY

CLASS 25—(Continued).

SN 77-565,206. IDEAL LIVING, INC., ARCADIA, CA. FILED 9-8-2008.

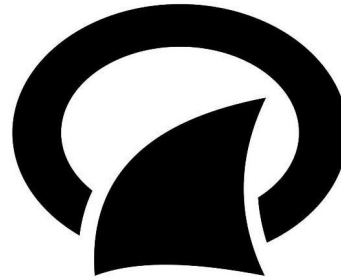

THE MARK CONSISTS OF PLAIN SINGLE LINE OVAL OVER A CURVED TRIANGLE.

FOR WEARING APPAREL, NAMELY, PANTS, JEANS, SHORTS, JACKETS, COATS, T-SHIRTS, SPORTSHIRTS, KNIT SHIRTS, SWEATSHIRTS, DRESSES, SKIRTS, BLOUSES, GLOVES, HATS, CAPS, SOCKS, UNDERWEAR AND FOOTWEAR (U.S. CLS. 22 AND 39).
KAREN K. BUSH, EXAMINING ATTORNEY

SN 77-565,088. TOPJIAN, TERENIG, SHERMAN OAKS, CA. FILED 9-8-2008.



THE STIPPLING IS FOR SHADING PURPOSES ONLY. THE MARK CONSISTS OF THE STYLIZED TEXT "ATHERIA" WITH A DOUBLE-HEADED EAGLE ON THE TOP RIGHT CORNER.

FOR BELTS; HATS; JACKETS; PANTS; SCARVES; SHIRTS; SWEATERS (U.S. CLS. 22 AND 39).
INGRID C. EULIN, EXAMINING ATTORNEY

SN 77-565,230. HAGINS, JEDD A., CHANDLER, AZ. FILED 9-9-2008.

Charlie Don't Ride

SN 77-565,153. ARREOLA, GRACIE, PRUNEDALE, CA. FILED 9-8-2008.

KOCHINO

THE MARK CONSISTS OF STANDARD CHARACTERS WITHOUT CLAIM TO ANY PARTICULAR FONT, STYLE, SIZE, OR COLOR.

FOR HATS; SWEAT SHIRTS; T-SHIRTS (U.S. CLS. 22 AND 39).
IRA J. GOODSaid, EXAMINING ATTORNEY

THE MARK CONSISTS OF STANDARD CHARACTERS WITHOUT CLAIM TO ANY PARTICULAR FONT, STYLE, SIZE, OR COLOR.

THE NAME "CHARLIE" IN THE MARK DOES NOT IDENTIFY A LIVING INDIVIDUAL.

FOR HATS; HEADGEAR, NAMELY, HEADBANDS, SWEATBANDS, SKULL CAPS, BEANIES; HOODED SWEAT SHIRTS; JOGGING PANTS; LEATHER PANTS; LONG-SLEEVED SHIRTS; LOUNGE PANTS; OPEN-NECKED SHIRTS; PANTS; PIQUE SHIRTS; POLO SHIRTS; RUGBY SHIRTS; SHIRTS; SHORT-SLEEVED OR LONG-SLEEVED T-SHIRTS; SHORT-SLEEVED SHIRTS; SPORT SHIRTS; SPORTS PANTS; SWEAT PANTS; SWEAT SHIRTS; T-SHIRTS; TEE SHIRTS; TRACK PANTS; WATERPROOF JACKETS AND PANTS; WEARABLE GARMENTS AND CLOTHING, NAMELY, SHIRTS; WIND PANTS; WIND SHIRTS (U.S. CLS. 22 AND 39).

FIRST USE 11-16-2007; IN COMMERCE 11-16-2007.
ANDREW RHIM, EXAMINING ATTORNEY

CLASS 25—(Continued).

SN 77-565,253. HEWETT, TODD S., GOLETA, CA. AND MILDEN, SCOTT C., DALLAS, TX. FILED 9-9-2008.

WPA

THE MARK CONSISTS OF STANDARD CHARACTERS WITHOUT CLAIM TO ANY PARTICULAR FONT, STYLE, SIZE, OR COLOR.

FOR FOOTWEAR; HEADWEAR, NAMELY, HATS, CAPS, VISORS, SKULL CAPS; CLOTHING, NAMELY, BEACHWEAR, BELTS, SUSPENDERS, GLOVES, SWEATBANDS, WRISTBANDS, HEAD SCARVES, HEAD SWEATBANDS, BOXER SHORTS, BRIEFS, UNDERWEAR, SPORTS BRAS, SOCKS, SHIRTS, JERSEYS, T-SHIRTS, TANK TOPS, SWEATSHIRTS, HOODED SWEATSHIRTS, SWEATERS, VESTS, JACKETS, COATS, FLEECE PULLOVERS, WARMUP SUITS, WIND JACKETS, FOUL WEATHER GEAR, RAINWEAR, SHORTS, SWEATPANTS, PANTS, TROUSERS, JEANS, OVERALLS, SKIRTS, UNIFORMS (U.S. CLS. 22 AND 39).

VIVIAN MICZNIK FIRST, EXAMINING ATTORNEY

SN 77-565,255. MOORE, DANIELE, BENSALEM, PA. FILED 9-9-2008.

Dear Earth

THE MARK CONSISTS OF "DEAR EARTH" NAME IN GOTHIC FONT.

FOR WEARABLE GARMENTS AND CLOTHING, NAMELY, SHIRTS (U.S. CLS. 22 AND 39).

VIVIAN MICZNIK FIRST, EXAMINING ATTORNEY

SN 77-565,280. THE SARAH BROOKS CORPORATION, DBA SARAH BROOKS INK, ATLANTA, GA. FILED 9-9-2008.

Hide-ees Better than Bloomers!

THE MARK CONSISTS OF STANDARD CHARACTERS WITHOUT CLAIM TO ANY PARTICULAR FONT, STYLE, SIZE, OR COLOR.

FOR CLOTHING, NAMELY, CHILDREN'S UNDERGARMENTS (U.S. CLS. 22 AND 39).

LINDSEY RUBIN, EXAMINING ATTORNEY

CLASS 25—(Continued).

SN 77-565,324. IDEAL LIVING, INC., ARCADIA, CA. FILED 9-9-2008.

Gohi

THE MARK CONSISTS OF STANDARD CHARACTERS WITHOUT CLAIM TO ANY PARTICULAR FONT, STYLE, SIZE, OR COLOR.

FOR WEARING APPAREL, NAMELY, PANTS, JEANS, SHORTS, JACKETS, COATS, T-SHIRTS, SPORTSHIRTS, KNIT SHIRTS, SWEATSHIRTS, DRESSES, SKIRTS, BLOUSES, GLOVES, HATS, CAPS, SOCKS, UNDERWEAR AND FOOTWEAR (U.S. CLS. 22 AND 39).

KAREN K. BUSH, EXAMINING ATTORNEY

SN 77-565,352. IDEAL LIVING, INC., ARCADIA, CA. FILED 9-9-2008.

RoyalGohi

THE MARK CONSISTS OF STANDARD CHARACTERS WITHOUT CLAIM TO ANY PARTICULAR FONT, STYLE, SIZE, OR COLOR.

FOR WEARING APPAREL, NAMELY, PANTS, JEANS, SHORTS, JACKETS, COATS, TSHIRTS, SPORT SHIRTS, KNIT SHIRTS, SWEATSHIRTS, DRESSES, SKIRTS, BLOUSES, GLOVES, HATS, CAPS, SOCKS, UNDERWEAR AND FOOTWEAR (U.S. CLS. 22 AND 39).

KAREN K. BUSH, EXAMINING ATTORNEY

SN 77-565,370. IDEAL LIVING, INC., ARCADIA, CA. FILED 9-9-2008.

Grohi

THE MARK CONSISTS OF STANDARD CHARACTERS WITHOUT CLAIM TO ANY PARTICULAR FONT, STYLE, SIZE, OR COLOR.

FOR WEARING APPAREL, NAMELY, PANTS, JEANS, SHORTS, JACKETS, COATS, TSHIRTS, SPORTSHIRTS, KNIT SHIRTS, SWEATSHIRTS, DRESSES, SKIRTS, BLOUSES, GLOVES, HATS, CAPS, SOCKS, UNDERWEAR AND FOOTWEAR (U.S. CLS. 22 AND 39).

KAREN K. BUSH, EXAMINING ATTORNEY

CLASS 25—(Continued).

SN 77-565,401. IDEAL LIVING, INC., ARCADIA, CA. FILED 9-9-2008.

RoyalGrohi

THE MARK CONSISTS OF STANDARD CHARACTERS WITHOUT CLAIM TO ANY PARTICULAR FONT, STYLE, SIZE, OR COLOR.

FOR WEARING APPAREL, NAMELY, PANTS, JEANS, SHORTS, JACKETS, COATS, TSHIRTS, SPORTSHIRTS, KNIT SHIRTS, SWEATSHIRTS, DRESSES, SKIRTS, BLOUSES, GLOVES, HATS, CAPS, SOCKS, UNDERWEAR AND FOOTWEAR (U.S. CLS. 22 AND 39).

KAREN K. BUSH, EXAMINING ATTORNEY

CLASS 25—(Continued).

SN 77-565,661. DBD DESIGNS, LLC, SHERMAN OAKS, CA. FILED 9-9-2008.

flippie slippies

THE MARK CONSISTS OF STANDARD CHARACTERS WITHOUT CLAIM TO ANY PARTICULAR FONT, STYLE, SIZE, OR COLOR.

FOR SANDALS (U.S. CLS. 22 AND 39).
FIRST USE 1-24-2007; IN COMMERCE 5-10-2007.
LAKEISHA LEWIS, EXAMINING ATTORNEY

SN 77-565,549. CHUBB, THERESA, KNOXVILLE, TN. FILED 9-9-2008.

EVERY SHOT IS A VIRGIN

THE MARK CONSISTS OF STANDARD CHARACTERS WITHOUT CLAIM TO ANY PARTICULAR FONT, STYLE, SIZE, OR COLOR.

FOR CAPS; GLOVES; HATS; JACKETS; PANTS; SHIRTS (U.S. CLS. 22 AND 39).

ZACHARY BELLO, EXAMINING ATTORNEY

SN 77-565,694. MURRAY, MONICA, K, MISSION VIEJO, CA. FILED 9-9-2008.

WOM

OWNER OF U.S. REG. NO. 3,317,892.
THE MARK CONSISTS OF THE STYLIZED WORD "WOM".

FOR DENIMS; JACKETS; LOUNGE PANTS; SHORT-SLEEVED OR LONG-SLEEVED T-SHIRTS; SWEAT SHIRTS; TANK TOPS (U.S. CLS. 22 AND 39).
EVELYN BRADLEY, EXAMINING ATTORNEY

SN 77-565,606. GARY S. HOBBS, SIOUX CITY, IA. FILED 9-9-2008.

GEES TEES

THE MARK CONSISTS OF STANDARD CHARACTERS WITHOUT CLAIM TO ANY PARTICULAR FONT, STYLE, SIZE, OR COLOR.

NO CLAIM IS MADE TO THE EXCLUSIVE RIGHT TO USE "TEES", APART FROM THE MARK AS SHOWN.

FOR CLOTHING, NAMELY, T-SHIRTS, SWEAT SHIRTS AND CAPS (U.S. CLS. 22 AND 39).

EMILY CHUO, EXAMINING ATTORNEY

SN 77-565,796. NODBOD, LLC, ST. LOUIS, MO. FILED 9-9-2008.

BEFORE & AFTER

THE MARK CONSISTS OF STANDARD CHARACTERS WITHOUT CLAIM TO ANY PARTICULAR FONT, STYLE, SIZE, OR COLOR.

FOR CLOTHING, NAMELY, T-SHIRTS (U.S. CLS. 22 AND 39).

ANN E. SAPPENFIELD, EXAMINING ATTORNEY

CLASS 25—(Continued).

SN 77-565,808. SUSAN LEDYARD, DBA CASS AND CREW INC., LLC, WILMINGTON, DE. FILED 9-9-2008.

for the girl who goes from
9 to jive

THE MARK CONSISTS OF STANDARD CHARACTERS WITHOUT CLAIM TO ANY PARTICULAR FONT, STYLE, SIZE, OR COLOR.

FOR SHAPEWEAR, NAMELY, TOPS, BOTTOMS AND DRESS; TANK-TOPS; TOPS; TUBE TOPS (U.S. CLS. 22 AND 39).

FIRST USE 5-1-2008; IN COMMERCE 5-1-2008.
SANDRA MANIOS, EXAMINING ATTORNEY

SN 77-565,873. AMERICAN BREAST CARE, INC., MARIETTA, GA. FILED 9-9-2008.



THE MARK CONSISTS OF A DESIGN OF A ROSE WITH THE LETTERS "ABC" UNDERNEATH IT.

FOR CLOTHING, NAMELY, BRAS AND SWIMWEAR (U.S. CLS. 22 AND 39).

FIRST USE 4-1-2003; IN COMMERCE 4-1-2003.
ARETHA SOMERVILLE, EXAMINING ATTORNEY

SN 77-565,967. JENNIFER RITZ, INC., FANWOOD, NJ. FILED 9-9-2008.

JENNIFER
RITZ

THE NAME "JENNIFER RITZ" IDENTIFIES A LIVING INDIVIDUAL WHOSE CONSENT IS OF RECORD.

THE MARK CONSISTS OF A STYLIZED NAME "JENNIFER RITZ".

FOR BELTS; LADIES' BOOTS; LADIES' SUITS; LADIES' UNDERWEAR; LEATHER BELTS; SWIM WEAR FOR GENTLEMEN AND LADIES; TOPS; WEARABLE GARMENTS AND CLOTHING, NAMELY, SHIRTS (U.S. CLS. 22 AND 39).

FIRST USE 8-9-2008; IN COMMERCE 9-5-2008.
ANGELA M. MICHELI, EXAMINING ATTORNEY

CLASS 25—(Continued).

SN 77-566,033. UNITED STATES ANTI-DOPING AGENCY, AKA USADA, COLORADO SPRINGS, CO. FILED 9-9-2008.

My Victory.
I compete clean.

OWNER OF U.S. REG. NOS. 3,220,102 AND 3,239,326.
THE MARK CONSISTS OF THE WORDS "MY VICTORY, I COMPETE CLEAN," IN STYLIZED LETTERS WITH THE "V" IN "VICTORY" EMPHASIZED IN A LARGER FONT AND A HORIZONTAL SLASH BENEATH THE STYLIZED MARK.

FOR (BASED ON USE IN COMMERCE) WRISTBANDS (BASED ON INTENT TO USE) CAPS; SHIRTS; T-SHIRTS; VISORS (U.S. CLS. 22 AND 39).

FIRST USE 7-31-2008; IN COMMERCE 7-31-2008.
JILL C. ALT, EXAMINING ATTORNEY

SN 77-566,047. L. SCOTT APPAREL, INC., LOS ANGELES, CA. FILED 9-9-2008.



OWNER OF U.S. REG. NOS. 2,949,689, 3,167,306 AND OTHERS.

THE MARK CONSISTS OF SIX GEOMETRIC SHAPES SOME OF WHICH ARE PARTLY SUPERIMPOSED ON OTHERS, TOGETHER WITH A STYLIZED NUMBER "6" AND STYLIZED LETTERING OF THE WORD "DEGREES".

FOR BLOUSES; DRESSES; HATS; HEADBANDS; JACKETS; PANTS; SHIRTS; SHORTS; SKIRTS; SKORTS; SOCKS; SPORT SHIRTS; SWEAT PANTS; SWEATERS; T-SHIRTS; VESTS (U.S. CLS. 22 AND 39).

JAMES GRIFFIN, EXAMINING ATTORNEY

CLASS 25—(Continued).

SN 77-566,111. SILVER ROSE DESIGN GROUP, LLC, WOODLAND HILLS, CA. FILED 9-9-2008.

SILVER ROSE

THE MARK CONSISTS OF STANDARD CHARACTERS WITHOUT CLAIM TO ANY PARTICULAR FONT, STYLE, SIZE, OR COLOR.

FOR HOODED SWEAT SHIRTS; JEANS; PANTS; SHIRTS; SHORTS; SKIRTS; SWEAT SHIRTS; T-SHIRTS; TOPS (U.S. CLS. 22 AND 39).

ELISSA GARBER KON, EXAMINING ATTORNEY

SN 77-566,121. MILLER, JOHN, BELMONT, VT. AND MILLER, LINDA, BELMONT, VT. FILED 9-9-2008.

Fup Duck

THE MARK CONSISTS OF STANDARD CHARACTERS WITHOUT CLAIM TO ANY PARTICULAR FONT, STYLE, SIZE, OR COLOR.

FOR JACKETS; SHIRTS; SWEAT SHIRTS (U.S. CLS. 22 AND 39).

MELISSA VALLILLO, EXAMINING ATTORNEY

SN 77-566,136. REYES, DAN, CARPINTERIA, CA. FILED 9-9-2008.



THE MARK CONSISTS OF A BEAR ON A LONGBOARD SURF BOARD.

FOR HATS; SHORTS; T-SHIRTS (U.S. CLS. 22 AND 39).
ANDREW RHIM, EXAMINING ATTORNEY

CLASS 25—(Continued).

SN 77-566,211. KRIS H. KIMURA, LA HABRA, CA. FILED 9-10-2008.

RYOKU

THE MARK CONSISTS OF STANDARD CHARACTERS WITHOUT CLAIM TO ANY PARTICULAR FONT, STYLE, SIZE, OR COLOR.

THE ENGLISH TRANSLATION OF THE WORD "RYOKU" IN THE MARK IS STRENGTH OR POWER.

FOR ATHLETIC PERFORMANCE APPAREL DESIGNED FOR TRAINING AND COMPETITION, NAMELY, TOPS, T-SHIRTS, POLOS, JERSEYS, SWEATS, FLEECE PULLOVERS, FLEECE VESTS, JACKETS, SHORTS, PANTS, WARM-UPS, UNDERWEAR, SOCKS, HEADWEAR, AND SWEATBANDS (U.S. CLS. 22 AND 39).

ANGELA M. MICHELI, EXAMINING ATTORNEY

SN 77-566,214. CLASSIC DESIGNS INC., MONTGOMERY, TX. FILED 9-10-2008.



THE MARK CONSISTS OF THE STYLIZED TERM "NEST".

FOR SCARVES; SHIRTS; TEE SHIRTS; TOPS; TUNICS (U.S. CLS. 22 AND 39).

FIRST USE 0-0-2005; IN COMMERCE 0-0-2005.
ANGELA M. MICHELI, EXAMINING ATTORNEY

SN 77-566,303. JOSEPHSON, NANCY, J., WILMINGTON, DE. FILED 9-10-2008.

Big Girl Music

THE MARK CONSISTS OF STANDARD CHARACTERS WITHOUT CLAIM TO ANY PARTICULAR FONT, STYLE, SIZE, OR COLOR.

FOR ATHLETIC APPAREL, NAMELY, SHIRTS, PANTS, JACKETS, FOOTWEAR, HATS AND CAPS, ATHLETIC UNIFORMS; HATS; HOODED SWEAT SHIRTS; LONG-SLEEVED SHIRTS; NIGHT SHIRTS; SHORT-SLEEVED OR LONG-SLEEVED T-SHIRTS; T-SHIRTS (U.S. CLS. 22 AND 39).

PAUL E. FAHRENKOPF, EXAMINING ATTORNEY

CLASS 25—(Continued).

SN 77-566,326. WOLVERINE WORLD WIDE, INC., ROCK-FORD, MI. FILED 9-10-2008.

DARKWELT

THE MARK CONSISTS OF STANDARD CHARACTERS WITHOUT CLAIM TO ANY PARTICULAR FONT, STYLE, SIZE, OR COLOR.

FOR FOOTWEAR (U.S. CLS. 22 AND 39).
ROBIN CHOSID, EXAMINING ATTORNEY

SN 77-566,391. CATHERINE MOSLEY, CAMDEN, DE. FILED 9-10-2008.

LIPSTICK ON A VOTER

THE MARK CONSISTS OF STANDARD CHARACTERS WITHOUT CLAIM TO ANY PARTICULAR FONT, STYLE, SIZE, OR COLOR.

FOR T-SHIRTS (U.S. CLS. 22 AND 39).
ZACHARY BELLO, EXAMINING ATTORNEY

SN 77-566,481. PALLER, DAVID, DBA GO FASTER, RIVERSIDE, RI. FILED 9-10-2008.

Go Faster

THE MARK CONSISTS OF STANDARD CHARACTERS WITHOUT CLAIM TO ANY PARTICULAR FONT, STYLE, SIZE, OR COLOR.

FOR TRIATHLON CLOTHING, NAMELY, TRIATHLON TIGHTS, TRIATHLON SHORTS, TRIATHLON SINGLET, TRIATHLON SHIRTS, TRIATHLON SUITS, WEARABLE GARMENTS AND CLOTHING, NAMELY, SHIRTS (U.S. CLS. 22 AND 39).

LAURIE MAYES, EXAMINING ATTORNEY

CLASS 25—(Continued).

SN 77-566,541. SUMMITT, CHRISTOPHER, LEWIS CENTER, OH. FILED 9-10-2008.

GOH

THE MARK CONSISTS OF STANDARD CHARACTERS WITHOUT CLAIM TO ANY PARTICULAR FONT, STYLE, SIZE, OR COLOR.

FOR HATS; JACKETS; PANTS; SWEAT SHIRTS; T-SHIRTS (U.S. CLS. 22 AND 39).

BARBARA BROWN, EXAMINING ATTORNEY

SN 77-567,263. INSPIRED FROM ABOVE FASHIONS, WEBSTER, NY. FILED 9-10-2008.

Inspired From Above

THE MARK CONSISTS OF STANDARD CHARACTERS WITHOUT CLAIM TO ANY PARTICULAR FONT, STYLE, SIZE, OR COLOR.

FOR A-SHIRTS; ADHESIVE BRAS; AFTER SKI BOOTS; ALBS; ANGLERS' SHOES; ANKLE BOOTS; ANKLE GARTERS; ANKLE SOCKS; ANKLETS; ANORAKS; ANTI-PERSPIRANT SOCKS; APRES-SKI SHOES; APRONS; ASCOTS; ATHLETIC APPAREL, NAMELY, SHIRTS, PANTS, JACKETS, FOOTWEAR, HATS AND CAPS, ATHLETIC UNIFORMS; ATHLETIC FOOTWEAR; ATHLETIC SHOES; ATHLETIC UNIFORMS; BABUSHKAS; BABY BIBS NOT OF PAPER; BABY BODYSUITS; BABY BOTTOMS; BABY BUNTING; BABY DOLL PYJAMAS; BABY TOPS; BALACLAVAS; BALLET SHOES; BALLET SLIPPERS; BALLOON PANTS; BALLROOM DANCING SHOES; BANDANAS; BANDEAUX; BASEBALL CAPS; BASEBALL SHOES; BASELAYER BOTTOMS; BASELAYER TOPS; BASKETBALL SNEAKERS; BATH SLIPPERS; BATHING CAPS; BATHING COSTUMES; BATHING COSTUMES FOR WOMEN; BATHING SUITS; BATHING SUITS FOR MEN; BATHING TRUNKS; BATHROBES; BEACH COVER-UPS; BEACH COVERUPS; BEACH FOOTWEAR; BEACH SHOES; BEACHWEAR; BEANIES; BED JACKETS; BELTS; BELTS MADE OF LEATHER; BELTS OF TEXTILE; BERETS; BERMUDA SHORTS; BIB OVERALLS; BIBS NOT OF CLOTH OR PAPER; BICYCLE GLOVES; BICYCLING GLOVES; BIKINIS; BLAZERS; BLOOMERS; BLOUSES; BLOUSONS; BOARD SHORTS; BOAS; BODICES; BODY LINEN; BODY SHAPERS; BODY STOCKINGS; BODY SUITS; BOLEROS; BOLO TIES; BOMBER JACKETS; BONNETS; BOOTIES; BOOTS; BOTTOMS; BOW TIES; BOWLING SHOES; BOXER BRIEFS; BOXER SHORTS; BOXING SHOES; BRALETTES; BRAS; BRASSIERES; BREECHES; BRIDESMAID DRESSES; BRIEFS; BRIEFS; BUSTIERS; BUSTLE HOLDER BANDS FOR OBI, NAMELY, OBIAGE; BUSTLES FOR OBI-KNOTS, NAMELY, OBIAGE-SHIN; BUTTON-FRONT ALOHA SHIRTS; CAFTANS; CAMISETTES; CAMISOLES; CAMP SHIRTS; CANVAS SHOES; CAP VISORS; CAPELETS; CAPES; CAPRI PANTS; CAPRIS; CAPS; CAPS WITH VISORS; CARDIGANS; CARGO PANTS; CASSOCKS; CHAPS; CHASUBLES; CHEF'S HATS; CHEMISES; CHEMISETTES; CHILDREN'S AND INFANTS' CLOTH BIBS; CHILDREN'S CLOTH EATING BIBS; CHILDREN'S HEADWEAR; CHOIR ROBES; CLAM DIGGERS; CLEATS FOR ATTACHMENT TO SPORTS SHOES; CLIMBING BOOTS; CLOGS; CLOTH BIBS; CLOTH BIBS FOR ADULT DINERS; CLOTH BIBS FOR USE BY SENIOR CITIZENS OR PHYSICALLY- OR MENTALLY-CHAL-

CLASS 25—(Continued).

LENGED PERSONS; CLOTH DIAPERS; CLOTHING FOR WEAR IN JUDO PRACTICES; CLOTHING FOR WEAR IN WRESTLING GAMES; CLOTHING, NAMELY, ARM WARMERS; CLOTHING, NAMELY, FOLK COSTUMES; CLOTHING, NAMELY, HAND-WARMERS; CLOTHING, NAMELY, KHAKIS; CLOTHING, NAMELY, KNEE WARMERS; CLOTHING, NAMELY, NECK TUBES; CLOTHING, NAMELY, THOBES; CLOTHING, NAMELY, WRAP-AROUNDS; COATS; COATS FOR MEN AND WOMEN; COATS MADE OF COTTON; COATS OF DENIM; COBBLERS' APRONS; COLLAR PROTECTORS; COLLARS; COMBINATIONS; COMPETITORS' NUMBERS OF TEXTILE; CORSELETS; CORSETS; COSTUMES FOR USE IN CHILDREN'S DRESS UP PLAY; COSTUMES FOR USE IN ROLE-PLAYING GAMES; COVERALLS; COVERUPS; CRAVATES; CRAVATS; CREEPERS; CREW NECK SWEATERS; CREW NECKS; CROP TOPS; CROSS-COUNTRY GLOVES; CROSS-COUNTRY MITTENS; CUFFS; CULOTTES; CUMMERBUNDS; CYCLING SHOES; CYCLISTS' JERSEYS; DANCE COSTUMES; DANCE SHOES; DECK-SHOES; DENIM JACKETS; DENIMS; DETACHABLE NECKPIECES FOR KIMONOS, NAMELY, HANERI; DICKIES; DISPOSABLE SLIPPERS; DISPOSABLE UNDERWEAR; DO RAGS; DOWN JACKETS; DRAWERS; DRESS SHIELDS; DRESS SHIRTS; DRESS SUITS; DRESSES; DRESSES MADE FROM SKINS; DRESSING GOWNS; DRIVERS; DRY SUITS; DUNGAREES; DUST COATS; DUSTERS; EAR MUFFS; EAR WARMERS; EARBANDS; EMBOSSED SOLES AND HEELS OF RUBBER OR OF PLASTIC MATERIALS; ESPADRILLES; EVENING DRESSES; EVENING GOWNS; EYESHADES; FABRIC BELTS; FABRIC SOLD AS AN INTEGRAL COMPONENT OF FINISHED CLOTHING ITEMS, NAMELY, PATCHES; FIGURE SKATING CLOTHING, NAMELY, PANTS, BLOUSES, DRESSES, SKIRTS, TIGHTS, LONG SLEEVE SHIRTS, SHORT SLEEVE,; FINISHED TEXTILE LININGS FOR GARMENTS; FISHERMEN'S JACKETS; FISHING VESTS; FISHING WADERS; FITTED SHOE OR BOOT COVERING TO PROTECT THE SHOES OR BOOT FROM WATER OR OTHER DAMAGE; FITTED SWIMMING COSTUMES WITH BRA CUPS; FLEECE PULLOVERS; FLEECE SHORTS; FLEECE VESTS; FLIGHT SUITS; FLIP FLOPS; FOAM PEDICURE SLIPPERS; FOOTBALL BOOTS AND STUDBS THEREFOR; FOOTBALL SHOES; FOOTIES; FOOTWEAR; FOOTWEAR; FOOTWEAR FOR MEN; FOOTWEAR FOR MEN AND WOMEN; FOOTWEAR FOR TRACK AND FIELD ATHLETICS; FOOTWEAR FOR WOMEN; FOOTWEAR MADE OF WOOD; FOOTWEAR NOT FOR SPORTS; FOOTWEAR, NAMELY, PUMPS; FOOTWEAR, NAMELY, RUBBERS; FOOTWEAR, NAMELY, WORK BOOTS; FOUL WEATHER GEAR; FOULARDS; FOUNDATION GARMENTS; FROCKS; FULL-LENGTH KIMONOS, NAMELY, NAGAGI; FUR CLOAKS; FUR COATS; FUR COATS AND JACKETS; FUR HATS; FUR JACKETS; FUR MUFFS; FUR STOKES; G-STRINGS; GABERDINES; GAITERS; GALOSHES; GARTER BELTS; GARTERS; GAUCHOS; GIRDLES; GLOVES; GLOVES FOR PERSONAL HAND CONDITIONING USE; GLOVES INCLUDING THOSE MADE OF SKIN, HIDE OR FUR; GOLF CAPS; GOLF CLEATS; GOLF SHIRTS; GOLF SHOES; GOLF SPIKES; GOLF TROUSERS; GOWNS; GREATCOATS; GYM SHORTS; GYM SUITS; GYMNASIUM SHOES; HALLOWEEN COSTUMES; HALLOWEEN COSTUMES AND MASKS SOLD IN CONNECTION THEREWITH; HALTER TOPS; HANDBALL SHOES; HAT BANDS; HATS; HEAD SCARVES; HEAD SWEATBANDS; HEAD WEAR; HEADBANDS; HEADBANDS AGAINST SWEATING; HEADGEAR, NAMELY, HATS, CAPS, VISORS, COWBOY HATS, STOCKING CAPS, SKI CAPS, SKULL CAPS, BASEBALL CAPS, BRIMLESS CAPS, BEANIE HATS, BERET, YAMAKA; HEADWEAR; HEAVY COATS; HEAVY JACKETS; HEEL INSERTS; HEEL PIECES FOR SHOES; HEELS; HIGH RAIN CLOGS, NAMELY, ASHIDA; HIKING BOOTS; HIP-GUARDS ESPECIALLY MADE FOR FISHING; HOCKEY SHOES; HOODED PULLOVERS; HOODED SWEAT SHIRTS; HOODS; HOODS; HORSE-RIDING BOOTS; HOSIERY; HOUSECOATS; HUNTING BOOT BAGS; HUNTING VESTS; INFANT AND TODDLER ONE PIECE CLOTHING; INFANT CLOTH DIAPERS; INFANT DIAPER COVERS; INFANT SLEEPERS; INFANT WEAR; INFANTS' SHOES AND BOOTS; INFANTS' TROUSERS; INFANTWEAR; INNER SOLES; INSOLES; INSOLES; JACKET LINERS; JACKETS; JACKETS AND SOCKS; JAPANESE FOOTWEAR OF RICE STRAW, NAMELY, WARAJI; JAPANESE SLEEP-

CLASS 25—(Continued).

ING ROBES, NAMELY, NEMAKI; JAPANESE SPLIT-TOED WORK FOOTWEAR, NAMELY, JIKATABI; JAPANESE STYLE CLOGS AND SANDALS; JAPANESE STYLE SANDALS, NAMELY, ZORI; JAPANESE STYLE SANDALS OF FELT; JAPANESE STYLE SANDALS OF LEATHER; JAPANESE STYLE SOCKS, NAMELY, TABI COVERS; JAPANESE STYLE SOCKS, NAMELY, TABI; JAPANESE STYLE WOODEN CLOGS, NAMELY, GETA; JAPANESE TOE-STRAP SANDALS, NAMELY, ASAURAZORI; JEANS; JERKINS; JERSEYS; JODHPURS; JOGGING OUTFITS; JOGGING PANTS; JOGGING SUITS; JUDO SUITS; JUMPERS; JUMPSUITS; KAFTANS; KARATE SUITS; KENDO OUTFITS; KERCHIEFS; KILTS; KIMONOS; KNEE HIGHS; KNEE-HIGH STOCKINGS; KNICKERS; KNIT SHIRTS; KNITTED CAPS; KNITTED UNDERWEAR; LAB COATS; LACE BOOTS; LADIES' BOOTS; LADIES' SUITS; LADIES' UNDERWEAR; LAYETTES; LEATHER BELTS; LEATHER COATS; LEATHER HEADWEAR; LEATHER JACKETS; LEATHER PANTS; LEATHER SHOES; LEATHER SLIPPERS; LEG SHAPERS; LEG WARMERS; LEG-WARMERS; LEGGINGS; LEOTARDS; LEOTARDS AND TIGHTS FOR WOMEN, MEN AND CHILDREN OF NYLON, COTTON OR OTHER TEXTILE FIBERS; LIGHT-REFLECTING COATS; LIGHT-REFLECTING JACKETS; LINGERIE; LINGERIE ACCESSORIES, NAMELY, REMOVABLE SILICONE BREAST ENHANCER PADS USED IN A BRA; LIVERIES; LONG JACKETS; LONG SLEEVED VESTS; LONG UNDERWEAR; LONG-SLEEVED SHIRTS; LOUNGE PANTS; LOUNGEWEAR; LOW WOODEN CLOGS, NAMELY, HIYORI-GETA; LOW WOODEN CLOGS, NAMELY, KOMA-GETA; MAILLOTS; MANTILLAS; MANTLES; MANTLES; MARTIAL ARTS UNIFORMS; MASQUERADE COSTUMES; MASQUERADE COSTUMES AND MASKS SOLD IN CONNECTION THEREWITH; MATERNITY LINGERIE; MATERNITY SLEEPWEAR; MEN'S AND WOMEN'S JACKETS, COATS, TROUSERS, VESTS; MEN'S SOCKS; MEN'S SUITS; MEN'S SUITS, WOMEN'S SUITS; METAL FITTINGS FOR JAPANESE STYLE WOODEN CLOGS; MINISKIRTS; MITTENS; MOCCASINS; MOCK TURTLE-NECK SWEATERS; MOCK-NECKS; MOISTURE-WICKING SPORTS BRAS; MOISTURE-WICKING SPORTS PANTS; MOISTURE-WICKING SPORTS SHIRTS; MONEY BELTS; MORNING COATS; MOTORCYCLE GLOVES; MOTORCYCLIST BOOTS; MOUNTAINEERING BOOTS; MUFFLERS; MUFFLERS; MUFFS; MUKLUKS; MULES; MUSCLE TOPS; MUU MUUS; NECK BANDS; NECK GAITERS; NECKERCHIEFS; NECKERCHIEVES; NECKTIES; NECKWEAR; NEGLIGEE; NIGHT GOWNS; NIGHT SHIRTS; NIGHTCAPS; NIGHTDRESSES; NIGHTGOWNS; NIGHTIES; NIGHTWEAR; NON-DISPOSABLE CLOTH TRAINING PANTS; NOVELTY HEADWEAR WITH ATTACHED WIG; NURSE DRESSES; NURSE OVERALLS; NURSE PANTS; NURSE'S APPAREL, NAMELY, SCRUBS, PANTS, SHIRTS; NURSING APPAREL, NAMELY, SCRUBS, PANTS, SHIRTS; ONE PIECE GARMENT FOR INFANTS AND TODDLERS; ONE-PIECE PLAY SUITS; OPEN-NECKED SHIRTS; OUTDOOR GLOVES; OUTDOOR MITTENS; OVER COATS; OVERTROUSERS; OVERALLS; OVERCOATS; OVERSHOES; PADDED JACKETS; PADDING JACKETS; PAJAMA BOTTOMS; PAJAMAS; PANTALOONS; PANTIES; PANTIES, SHORTS AND BRIEFS; PANTS; PANTSUITS; PANTYHOSE; PAPER APRONS; PAPER HATS FOR USE AS CLOTHING ITEMS; PAPER SHOES USED WHEN GOING THROUGH METAL DETECTORS TO KEEP FEET AND SOCKS CLEAN; PARAMENTS; PAREOS; PAREU; PAREUS; PARKAS; PARTS OF CLOTHING, NAMELY, GUSSETS FOR TIGHTS, GUSSETS FOR STOCKINGS, GUSSETS FOR BATHING SUITS, GUSSETS FOR UNDERWEAR, GUSSETS FOR LEOTARDS AND GUSSETS FOR FOOTLETS; PEDAL PUSHERS; PEDICURE SANDALS; PEDICURE SLIPPERS; PEIGNOIRS; PELERINES; PELISSES; PERSPIRATION ABSORBENT UNDERWEAR CLOTHING; PETTI-PANTS; PETTICOATS; PINAFORES; PIQUE SHIRTS; PLASTIC APRONS; PLASTIC BABY BIBS; PLAY SUITS; PLEATED SKIRTS FOR FORMAL KIMONOS, NAMELY, HAKAMA; PLUS FOURS; POCKET KERCHIEFS; POCKET SQUARES; POLO SHIRTS; PONCHOS; PROTECTIVE METAL MEMBERS FOR SHOES AND BOOTS; PULLOVERS; PUMPS; PUTTEES AND GAITERS; PYJAMAS; QUILTED VESTS; RAIN BOOTS; RAIN COATS; RAIN JACKETS; RAIN SLICKERS; RAIN SUITS; RAIN TROUSERS; RAINCOATS; RAINPROOF JACKETS; RAINWEAR; RASH GUARDS; REMOVABLE COLLARS;

CLASS 25—(Continued).

REVERSIBLE JACKETS; RIDING BOOTS; RIDING COATS; RIDING GLOVES; ROBES; ROMPERS; RUANAS; RUBBER SHOES; RUBBER SOLES FOR JIKATABI; RUBBERS; RUGBY SHIRTS; RUGBY SHOES; RUGBY SHORTS; RUGBY TOPS; RUNNING SHOES; SABOTS; SANDAL-CLOGS; SANDALS; SARIS; SARONGS; SASH BANDS FOR KIMONO, NAMELY, OBI; SASHES; SCARVES; SCHOOL UNIFORMS; SCIENTIFIC AND TECHNOLOGICAL APPAREL, NAMELY, SHIRTS, PANTS, JACKETS, FOOTWEAR, HATS AND CAPS, UNIFORMS; SCRUBS NOT FOR MEDICAL PURPOSES; SEDGE HATS, NAMELY, SUGE-GASA; SERAPES; SHAMPOO CAPES; SHAPEWEAR, NAMELY, TIGHTS, PANTS, TANK TOPS, SLEEVELESS SHIRTS, SKIRTS, SHORTS, DRESSES; SHAWLS; SHAWLS; SHAWLS AND HEADSCARVES; SHAWLS AND STOLEES; SHELL JACKETS; SHIFTS; SHIRT FRONTS; SHIRT YOKES; SHIRTS; SHIRTS FOR SUITS; SHOE DOWELS; SHOE INSERTS FOR PRIMARILY NON-ORTHOPEDIC PURPOSES; SHOE PEGS; SHOE SOLES; SHOE STRAPS; SHOES; SHOES SOLES FOR REPAIR; SHORT OVERCOAT FOR KIMONO, NAMELY, HAORI; SHORT PETTICOATS; SHORT SETS; SHORT TROUSERS; SHORT-SLEEVED OR LONG-SLEEVED T-SHIRTS; SHORT-SLEEVED SHIRTS; SHORTALLS; SHORTS; SHOULDER SCARVES; SHOULDER WRAPS; SHOWER CAPS; SHRUGS; SILK SCARVES; SINGLETS; SKATING OUTFITS; SKI AND SNOWBOARD SHOES AND PARTS THEREOF; SKI BIBS; SKI BOOT BAGS; SKI BOOTS; SKI GLOVES; SKI JACKETS; SKI MASKS; SKI PANTS; SKI SUITS; SKI SUITS FOR COMPETITION; SKI TROUSERS; SKI WEAR; SKIING SHOES; SKIRT SUITS; SKIRTS; SKIRTS AND DRESSES; SKIWEAR; SKORTS; SKULL CAPS; SKULLIES; SLACKS; SLEEP MASKS; SLEEP SHIRTS; SLEEPING GARMENTS; SLEEPWEAR; SLEEVED OR SLEEVELESS JACKETS; SLEEVELESS JERSEYS; SLIDING SHORTS; SLIPPER SOLES; SLIPPERS; SLIPS; SMALL HATS; SMOCKS; SMOKING JACKETS; SNEAKERS; SNOW BOARDING SUITS; SNOW BOOTS; SNOW PANTS; SNOW SUITS; SNOWBOARD BOOTS; SNOWBOARD GLOVES; SNOWBOARD MITTENS; SNOWBOARD PANTS; SOCCER BOOTS; SOCCER SHOES; SOCK SUSPENDERS; SOCKS; SOCKS AND STOCKINGS; SOLES; SOLES FOR JAPANESE STYLE SANDALS; SPORT COATS; SPORT SHIRTS; SPORTS BRA; SPORTS BRAS; SPORTS JACKETS; SPORTS JERSEYS; SPORTS JERSEYS AND BREECHES FOR SPORTS; SPORTS OVERUNIFORMS; SPORTS PANTS; SPORTS SHIRTS; SPORTS SHIRTS WITH SHORT SLEEVES; STOCKINGS; STOCKINGS; STOLEES; STRAPLESS BRAS; STRAPS FOR BRAS; STRETCH PANTS; STRING FASTENERS FOR HAORI, NAMELY, HAORI-HIMO; STUFF JACKETS; SUEDE JACKETS; SUIT COATS; SUITS; SUITS OF LEATHER; SUN SLEEVES; SUN VISORS; SUNSUITS; SURF WEAR; SUSPENDER BELTS FOR MEN; SUSPENDER BELTS FOR WOMEN; SUSPENDERS; SUSPENDERS; SWADDLING CLOTHES; SWEAT BANDS; SWEAT JACKETS; SWEAT PANTS; SWEAT SHIRTS; SWEAT SHORTS; SWEAT SUITS; SWEATBANDS; SWEATERS; SWEATSOCKS; SWIM CAPS; SWIM TRUNKS; SWIM WEAR; SWIM WEAR FOR GENTLEMEN AND LADIES; SWIMMING CAPS; SWIMMING CAPS; SWIMMING COSTUMES; SWIMMING TRUNKS; SWIMSUITS; SWIMWEAR; T-SHIRTS; TAILLEURS; TAMS; TANK TOPS; TANK-TOPS; TANKINIS; TAP PANTS; TAP SHOES; TEDDIES; TEE SHIRTS; TENNIS SHOES; TENNIS WEAR; TEXTILE DIAPERS; TEXTILE NAPPIES; THERMAL SOCKS; THERMAL UNDERWEAR; THONGS; THONGS; TIES; TIGHTENING-UP STRINGS FOR KIMONOS, NAMELY, DATEJIME; TIGHTS; TIPS FOR FOOTWEAR; TOBOGGAN HATS, PANTS AND CAPS; TOE BOXES; TOE CAPS; TOE STRAPS FOR JAPANESE STYLE SANDALS; ZORI; TOE STRAPS FOR JAPANESE STYLE WOODEN CLOGS; TONGAS; TONGUE OR PULLSTRAP FOR SHOES AND BOOTS; TOP COATS; TOPCOATS; TOPS; TOQUES; TRACK AND FIELD SHOES; TRACK JACKETS; TRACK PANTS; TRACK SUITS; TRACKSUITS; TRAINING SHOES; TRAINING SUITS; TRAVEL CLOTHING CONTAINED IN A PACKAGE COMPRISING REVERSIBLE JACKETS, PANTS, SKIRTS, TOPS AND A BELT OR SCARF; TRENCH COATS; TRIATHLON CLOTHING, NAMELY, TRIATHLON TIGHTS, TRIATHLON SHORTS, TRIATHLON SINGLETS, TRIATHLON SHIRTS, TRIATHLON SUITS; TROUSERS; TROUSERS FOR SWEATING; TROUSERS OF LEATHER; TRUNKS; TUBE TOPS; TUNICS; TUNES; TURBANS; TURTLENECK SWEATERS; TURTLE-

CLASS 25—(Continued).

NECKS; TUXEDO BELTS; TUXEDOS; TWIN SETS; UNDER GARMENTS; UNDERARM CLOTHING SHIELDS; UNDERCLOTHES; UNDERGARMENT ACCESSORIES, NAMELY, REMOVABLE SILICONE BUTTOCK ENHANCER PADS; UNDERGARMENTS; UNDERPANTS; UNDERSHIRTS; UNDERSHIRTS FOR KIMONOS, NAMELY, JUBAN; UNDERSHIRTS FOR KIMONOS, NAMELY, KOSHIMAKI; UNDERSKIRTS; UNDERWEAR; UNDERWEAR, NAMELY, BOY SHORTS; UNIFORMS; UNION SUITS; UNITARDS; UPPERS FOR JAPANESE STYLE SANDALS; UPPERS OF WOVEN RATTAN FOR JAPANESE STYLE SANDALS; V-NECK SWEATERS; VEILS; VEST EXTENDERS; VESTED SUITS; VESTS; VISORS; VOLLEYBALL SHOES; WAIST BELTS; WAIST CINCHERS; WAIST STRINGS FOR KIMONOS, NAMELY, KOSHIHIMO; WAISTBANDS; WAISTCOATS; WALKING SHORTS; WARM UP OUTFITS; WARM UP SUITS; WATER SOCKS; WATERPROOF JACKETS AND PANTS; WEARABLE GARMENTS AND CLOTHING, NAMELY, SHIRTS; WEDDING DRESSES; WEDDING GOWNS; WET SUIT GLOVES; WET SUITS; WET SUITS FOR WATER-SKIING AND SUB-AQUA; WETSUITS; WIND COATS; WIND PANTS; WIND RESISTANT JACKETS; WIND SHIRTS; WIND VESTS; WIND-JACKETS; WINDCHEATERS; WINDJAMMERS; WINDSHIRTS; WINTER BOOTS; WOMEN'S CEREMONIAL DRESSES; WOMEN'S SHOES; WOMEN'S UNDERWEAR; WOODEN MAIN BODIES OF JAPANESE STYLE WOODEN CLOGS; WOODEN SUPPORTS OF JAPANESE STYLE WOODEN CLOGS; WOOLLEN SOCKS; WOOLLY HATS; WORK SHOES AND BOOTS; WORKING OVERALLS; WOVEN OR KNITTED UNDERWEAR; WRAP BELTS FOR KIMONOS, NAMELY, DATEMAKI; WRAPS; WRIST BANDS; WRISTBANDS; WRISTBANDS CONTAINING A COOLING SUBSTANCE TO COOL THE WEARER; YASHMAGHS; YOGA PANTS; YOGA SHIRTS; ZOOT SUITS; ZORI (U.S. CLS. 22 AND 39).

JIM RINGLE, EXAMINING ATTORNEY

SN 77-567,287. FLOYD E. HARMON, ANAHEIM HILLS, CA.
FILED 9-11-2008.

AssassinsWear

THE MARK CONSISTS OF STANDARD CHARACTERS WITHOUT CLAIM TO ANY PARTICULAR FONT, STYLE, SIZE, OR COLOR.

FOR A-SHIRTS; ATHLETIC APPAREL, NAMELY, SHIRTS, PANTS, JACKETS, FOOTWEAR, HATS AND CAPS, ATHLETIC UNIFORMS; ATHLETIC SHOES; BEACH SHOES; BUTTON-FRONT ALOHA SHIRTS; CAMP SHIRTS; CANVAS SHOES; CAPRI PANTS; CARGO PANTS; CYCLING SHOES; DECK-SHOES; DENIMS; DRESS SHIRTS; FOOTBALL SHOES; GOLF SHIRTS; GOLF SHOES; GYMNASTIC SHOES; HANDBALL SHOES; HAT BANDS; HATS; HEADGEAR, NAMELY, HATS, SWEATBANDS; HOCKEY SHOES; HOODED SWEAT SHIRTS; INFANTS' SHOES AND BOOTS; JOGGING PANTS; KNIT SHIRTS; LEATHER PANTS; LEATHER SHOES; LONG-SLEEVED SHIRTS; LOUNGE PANTS; MOISTURE-WICKING SPORTS PANTS; MOISTURE-WICKING SPORTS SHIRTS; NIGHT SHIRTS; NON-DISPOSABLE CLOTH TRAINING PANTS; OPEN-NECKED SHIRTS; PANTS; PAPER HATS FOR USE AS CLOTHING ITEMS; PETTI-PANTS; PIQUE SHIRTS; POLO SHIRTS; RUGBY SHIRTS; RUGBY SHOES; RUNNING SHOES; SCIENTIFIC AND TECHNOLOGICAL APPAREL, NAMELY, SHIRTS, PANTS, JACKETS, FOOTWEAR, HATS AND CAPS, UNIFORMS; SHIRT FRONTS;

CLASS 25—(Continued).

SHIRT YOKES; SHIRTS; SHORT-SLEEVED OR LONG-SLEEVED T-SHIRTS; SHORT-SLEEVED SHIRTS; SKI AND SNOWBOARD SHOES AND PARTS THEREOF; SKI PANTS; SKIING SHOES; SLEEP SHIRTS; SMALL HATS; SNOW PANTS; SNOWBOARD PANTS; SOCCER SHOES; SPORT SHIRTS; SPORTS PANTS; SPORTS SHIRTS; SPORTS SHIRTS WITH SHORT SLEEVES; STRETCH PANTS; SWEAT PANTS; SWEAT SHIRTS; T-SHIRTS; TAP PANTS; TEE SHIRTS; TENNIS SHOES; TOBOGGAN HATS, PANTS AND CAPS; TRACK AND FIELD SHOES; TRACK PANTS; TRAINING SHOES; TRAVEL CLOTHING CONTAINED IN A PACKAGE COMPRISING REVERSIBLE JACKETS, PANTS, SKIRTS, TOPS AND A BELT OR SCARF; TRIATHLON CLOTHING, NAMELY, TRIATHLON TIGHTS, TRIATHLON SHORTS, TRIATHLON SINGLET, TRIATHLON SHIRTS, TRIATHLON SUITS; VOLLEYBALL SHOES; WATERPROOF JACKETS AND PANTS; WIND PANTS; WIND SHIRTS; WOMEN'S SHOES; WOOLLY HATS; WORK SHOES AND BOOTS; YOGA PANTS; YOGA SHIRTS (U.S. CLS. 22 AND 39).

HOWARD B. LEVINE, EXAMINING ATTORNEY

SN 77-567,299. DAWSON, ERIC J., PORTLAND, ME. FILED 9-11-2008.

EARTHJOCK

THE MARK CONSISTS OF STANDARD CHARACTERS WITHOUT CLAIM TO ANY PARTICULAR FONT, STYLE, SIZE, OR COLOR.

FOR ATHLETIC APPAREL, NAMELY, SHIRTS, PANTS, JACKETS, FOOTWEAR, HATS AND CAPS, ATHLETIC UNIFORMS; ATHLETIC UNIFORMS; BOTTOMS; CAPS; FOOTWEAR; HATS; HEADWEAR; JACKETS; PANTS; SHIRTS; TOPS; UNIFORMS (U.S. CLS. 22 AND 39).

SANJEEV VOHRA, EXAMINING ATTORNEY

CLASS 25—(Continued).

SN 77-567,319. VELEZ-GONZALEZ, FEDERICO, MEDELIN, COLOMBIA, FILED 9-11-2008.



NO CLAIM IS MADE TO THE EXCLUSIVE RIGHT TO USE "WEAR", APART FROM THE MARK AS SHOWN.

THE COLOR(S) YELLOW AND BLACK IS/ARE CLAIMED AS A FEATURE OF THE MARK.

THE MARK CONSISTS OF AN ABSTRACT ROUND DESIGN WITH A LEG OR PROTUBERANCE EXTENDING OUT FROM THE UPPER RIGHT SIDE, BELOW OF WHICH APPEAR THE WORDS "SAFETY SMART WEAR" IN STYLIZED LETTERS. THE COLOR YELLOW APPEARS IN THE ROUND ABSTRACT FIGURE. THE COLOR BLACK APPEARS IN THE ROUND ABSTRACT FIGURE AND IN THE WORDS "SAFETY SMART WEAR".

FOR ATHLETIC APPAREL, NAMELY, SHIRTS, PANTS, JACKETS, FOOTWEAR, HATS AND CAPS; ATHLETIC UNIFORMS; TRIATHLON CLOTHING, NAMELY, TRIATHLON TIGHTS, TRIATHLON SHORTS, TRIATHLON SINGLET, TRIATHLON SHIRTS, TRIATHLON SUITS; FOOTBALL CLOTHING, NAMELY, PANTS, SHIRTS, SHORTS, JACKETS AND SOCKS; FOOTBALL SHOES; CYCLING CLOTHING, NAMELY, PANTS, SHIRTS, SHORTS, JACKETS AND SOCKS; CYCLING SHOES; SKATING OUTFITS; SKATING CLOTHING, NAMELY, PANTS, SHIRTS, SHORTS, JACKETS AND SOCKS (U.S. CLS. 22 AND 39).

FIRST USE 11-5-2005; IN COMMERCE 2-18-2006.
GEOFFREY FOSDICK, EXAMINING ATTORNEY

SN 77-567,330. CHEN, LI, VANCOUVER, CANADA, AND HUANG, LUOYI, VANCOUVER, CANADA, FILED 9-11-2008.

novous

THE MARK CONSISTS OF STANDARD CHARACTERS WITHOUT CLAIM TO ANY PARTICULAR FONT, STYLE, SIZE, OR COLOR.

FOR CLOTHING, NAMELY, ARM WARMERS, KNEE WARMERS, LEG WARMERS, APPAREL, NAMELY, MEN'S, WOMEN'S AND CHILDREN'S CLOTHING, NAMELY, SHIRTS, PANTS, JACKETS, DRESS, SHORTS, SKIRTS, UNDERWEAR, BRA TOPS, TANK TOPS, SWIM WEAR, SWEATERS, OUTERWEAR, SKI JACKETS, SNOW PANTS, CYCLING CHAMOIS SHORTS, AND JERSEYS (U.S. CLS. 22 AND 39).

GEOFFREY FOSDICK, EXAMINING ATTORNEY

CLASS 25—(Continued).

SN 77-567,429. KNOWLES, BEYONCE, BEVERLY HILLS, CA. FILED 9-11-2008.

SASHA FIERCE

THE MARK CONSISTS OF STANDARD CHARACTERS WITHOUT CLAIM TO ANY PARTICULAR FONT, STYLE, SIZE, OR COLOR.

THE NAME "SASHA FIERCE" DOES NOT IDENTIFY A LIVING INDIVIDUAL.

FOR CLOTHING, NAMELY, HATS, SHIRTS, SWEATSHIRTS, JACKETS, TANK TOPS, PANTS (U.S. CLS. 22 AND 39).

SHANNON TWOHIG, EXAMINING ATTORNEY

SN 77-567,534. NODBOD, LLC, ST. LOUIS, MO. FILED 9-11-2008.

BEFORE & AGAIN

THE MARK CONSISTS OF STANDARD CHARACTERS WITHOUT CLAIM TO ANY PARTICULAR FONT, STYLE, SIZE, OR COLOR.

FOR CLOTHING, NAMELY, T-SHIRTS (U.S. CLS. 22 AND 39).

ANN E. SAPPENFIELD, EXAMINING ATTORNEY

SN 77-567,543. JAZD-CAP, LLC, WESTLAKE, OH. FILED 9-11-2008.

The Right Light

THE MARK CONSISTS OF STANDARD CHARACTERS WITHOUT CLAIM TO ANY PARTICULAR FONT, STYLE, SIZE, OR COLOR.

NO CLAIM IS MADE TO THE EXCLUSIVE RIGHT TO USE "LIGHT", APART FROM THE MARK AS SHOWN.

FOR CAPS AND VISORS WITH LED LIGHT ATTACHED TO BRIM (U.S. CLS. 22 AND 39).

MIDGE BUTLER, EXAMINING ATTORNEY

CLASS 25—(Continued).

SN 77-567,602. MACHADO, PATRICIA, CARDIFF BY THE SEA, CA. FILED 9-11-2008.

MACYROSE

THE MARK CONSISTS OF STANDARD CHARACTERS WITHOUT CLAIM TO ANY PARTICULAR FONT, STYLE, SIZE, OR COLOR.

FOR CLOTHING, NAMELY, SWIMSUITS, BIKINIS, BEACH COVER UPS, T-SHIRTS, SWEATSUITS, TOPS, BLOUSES, SHORTS, SKIRTS, PANTS, UNDERWEAR, SLEEPWEAR; FOOTWEAR AND HEADWEAR (U.S. CLS. 22 AND 39).

NANCY CLARKE, EXAMINING ATTORNEY

SN 77-567,611. ROBERT ABANG LIMITED, PARMA, OH. FILED 9-11-2008.

GORILLA SQUAD

THE MARK CONSISTS OF STANDARD CHARACTERS WITHOUT CLAIM TO ANY PARTICULAR FONT, STYLE, SIZE, OR COLOR.

FOR FOOTWEAR AND APPAREL, NAMELY, T-SHIRTS, GLOVES, FINGER SLEEVES, SHIRTS, SWEAT SHIRTS, SWEATERS, BRA TOPS, JACKETS, JERSEYS, HATS, VISORS, WRIST BANDS, HEAD BANDS, SOCKS, SWEAT PANTS, TIGHTS, SHORTS, SKIRTS, DRESSES, WARM-UP SUITS, VESTS, PANTS, ATHLETIC UNIFORMS, GLOVES, UNITARDS, LEOTARDS, THERMAL UNDERWEAR, INFANT ONE PIECE CLOTHING, COVERALLS, ARM SLEEVES (U.S. CLS. 22 AND 39).

CAROLYN GRAY, EXAMINING ATTORNEY

CLASS 25—(Continued).

SN 77-567,630. CHROME HEARTS LLC, HOLLYWOOD, CA. FILED 9-11-2008.

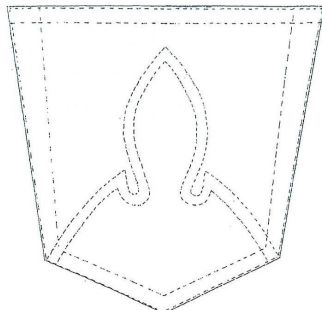

OWNER OF U.S. REG. NO. 2,644,724.
 THE MARK CONSISTS OF A STYLIZED DESIGN APPLIED TO THE BACK AND FRONT POCKET PORTION OF GOODS AS SHOWN BY THE BROKEN LINES WHICH REPRESENT THE STITCHING. THE SOLID LINE REPRESENTS THE SHAPE OF THE POCKET BUT SERVES ONLY TO SHOW THE POSITION OF THE MARK ON THE GOODS AND IS NOT CLAIMED AS A PART OF THE MARK.
 SEC. 2(F).
 FOR MEN'S AND WOMEN'S CLOTHING, NAMELY, PANTS, JEANS AND CHAPS (U.S. CLS. 22 AND 39).
 FIRST USE 11-1-1999; IN COMMERCE 11-1-1999.
 JENNIFER MARTIN, EXAMINING ATTORNEY

SN 77-567,635. PASSARO, JOHN, SHERMAN OAKS, CA. FILED 9-11-2008.

Protect Your Diesel Rights

THE MARK CONSISTS OF STANDARD CHARACTERS WITHOUT CLAIM TO ANY PARTICULAR FONT, STYLE, SIZE, OR COLOR.
 FOR T-SHIRTS (U.S. CLS. 22 AND 39).
 KATHERINE CHANG, EXAMINING ATTORNEY

SN 77-567,726. CALLAWAY GOLF COMPANY, CARLSBAD, CA. FILED 9-11-2008.

Bio-Kinetic

THE MARK CONSISTS OF STANDARD CHARACTERS WITHOUT CLAIM TO ANY PARTICULAR FONT, STYLE, SIZE, OR COLOR.
 THE MARK "BIO-KINETIC" HAS NO MEANING IN A FOREIGN LANGUAGE.
 FOR FOOTWEAR; GOLF SHOES (U.S. CLS. 22 AND 39).
 RUDY R. SINGLETON, EXAMINING ATTORNEY

CLASS 25—(Continued).

SN 77-567,947. MALIBU DREAM GIRL, BELL, CA. FILED 9-11-2008.

TROPICAL HONEY

THE MARK CONSISTS OF STANDARD CHARACTERS WITHOUT CLAIM TO ANY PARTICULAR FONT, STYLE, SIZE, OR COLOR.
 FOR WOMEN'S SWIMWEAR AND COVER-UPS (U.S. CLS. 22 AND 39).
 KELLEY WELLS, EXAMINING ATTORNEY

SN 77-568,063. AHN, DURE, FORT LEE, NJ. FILED 9-11-2008.

**discreetly vulgar,
internationally obscene**

THE MARK CONSISTS OF STANDARD CHARACTERS WITHOUT CLAIM TO ANY PARTICULAR FONT, STYLE, SIZE, OR COLOR.
 FOR T-SHIRTS (U.S. CLS. 22 AND 39).
 ANDREA SAUNDERS, EXAMINING ATTORNEY

SN 77-568,301. ROWE, KELLY, SANTA BARBARA, CA. FILED 9-11-2008.

Rockin 'bod

THE MARK CONSISTS OF STANDARD CHARACTERS WITHOUT CLAIM TO ANY PARTICULAR FONT, STYLE, SIZE, OR COLOR.
 FOR DRESSES; SWIMWEAR (U.S. CLS. 22 AND 39).
 FIRST USE 6-4-2008; IN COMMERCE 6-4-2008.
 JUDITH HELFMAN, EXAMINING ATTORNEY

SN 77-569,618. JOY OF ROMANCE, INC., SAN FRANCISCO, CA. FILED 9-15-2008.

FLUFFOLOGY

THE MARK CONSISTS OF STANDARD CHARACTERS WITHOUT CLAIM TO ANY PARTICULAR FONT, STYLE, SIZE, OR COLOR.
 FOR T-SHIRTS (U.S. CLS. 22 AND 39).
 FIRST USE 8-31-2006; IN COMMERCE 8-31-2006.
 MIDGE BUTLER, EXAMINING ATTORNEY

CLASS 25—(Continued).

SN 77-570,429. OMNIPEACE, LLC, SHERMAN OAKS, CA.
FILED 9-15-2008.



THE MARK CONSISTS OF FINGERS REPRESENTING A
PEACE SIGN OVER THE COUNTRY OF AFRICA.
FOR CLOTHING, NAMELY, SHIRTS, T-SHIRTS,
JACKETS, SWEATSHIRTS, CAPS, HATS (U.S. CLS. 22
AND 39).

FIRST USE 3-1-2008; IN COMMERCE 3-1-2008.
MARY CRAWFORD, EXAMINING ATTORNEY

SN 77-570,434. OMNIPEACE, LLC, SHERMAN OAKS, CA.
FILED 9-15-2008.

OmniPeace

THE MARK CONSISTS OF STANDARD CHARACTERS
WITHOUT CLAIM TO ANY PARTICULAR FONT, STYLE,
SIZE, OR COLOR.

FOR CLOTHING, NAMELY, SHIRTS, T-SHIRTS,
JACKETS, SWEATSHIRTS, CAPS, HATS (U.S. CLS. 22
AND 39).

FIRST USE 3-1-2008; IN COMMERCE 3-1-2008.
MARY CRAWFORD, EXAMINING ATTORNEY

SN 77-571,271. CIVETTA, FRANCESCO ANDREA, NEW
YORK, NY. FILED 9-16-2008.

I.GOLD

THE MARK CONSISTS OF STANDARD CHARACTERS
WITHOUT CLAIM TO ANY PARTICULAR FONT, STYLE,
SIZE, OR COLOR.

FOR DRESS SHIRTS; HOODED SWEAT SHIRTS;
SHIRTS; SHIRTS FOR SUITS; SWEAT SHIRTS; T-SHIRTS
(U.S. CLS. 22 AND 39).

LINDA MICKLEBURGH, EXAMINING ATTORNEY

CLASS 25—(Continued).

SN 77-571,474. NAM C. QUACH, SAN FRANCISCO, CA. AND
CHARLENE CHEN, SAN FRANCISCO, CA. FILED 9-16-
2008.

WOMEN IN TRANSITION

THE MARK CONSISTS OF STANDARD CHARACTERS
WITHOUT CLAIM TO ANY PARTICULAR FONT, STYLE,
SIZE, OR COLOR.

FOR CLOTHING, NAMELY, PANTS, DRESSES, BODY
SHAPERS, CORSETS AND PANTYHOSE (U.S. CLS. 22
AND 39).

MELISSA VALLILLO, EXAMINING ATTORNEY

SN 77-572,054. REVISE CLOTHING, INC., TETERBORO, NJ.
FILED 9-17-2008.

VANILLA STAR GOLD

THE MARK CONSISTS OF STANDARD CHARACTERS
WITHOUT CLAIM TO ANY PARTICULAR FONT, STYLE,
SIZE, OR COLOR.

OWNER OF U.S. REG. NO. 2,762,901.

FOR BEACHWEAR; BELTS; BLOUSES; COATS; HEAD
WEAR; JACKETS; JEANS; NIGHTWEAR; PANTS;
SHIRTS; SHORTS; SKIRTS; T-SHIRTS (U.S. CLS. 22
AND 39).

ANNE E. GUSTASON, EXAMINING ATTORNEY

SN 77-575,090. JOHNSON, CRAIG S., SAN FRANCISCO, CA.
FILED 9-21-2008.

ZONTAL

THE MARK CONSISTS OF STANDARD CHARACTERS
WITHOUT CLAIM TO ANY PARTICULAR FONT, STYLE,
SIZE, OR COLOR.

FOR CLOTHING AND APPAREL, NAMELY, TEE-
SHIRTS, HATS, SWEATSHIRTS, JACKETS, SHORTS,
SWEATPANTS, UNDERWEAR, TANK TOPS, COLLAR
SHIRTS, RAINCOATS AND RAIN PANTS (U.S. CLS. 22
AND 39).

WENDY GOODMAN, EXAMINING ATTORNEY

CLASS 25—(Continued).

SN 77-576,110. STARKEY, RICHARD, AKA RINGO STARR, SANTA MONICA, CA. FILED 9-22-2008.

RINGO

THE MARK CONSISTS OF STANDARD CHARACTERS WITHOUT CLAIM TO ANY PARTICULAR FONT, STYLE, SIZE, OR COLOR.

OWNER OF U.S. REG. NOS. 3,213,560 AND 3,334,665. FOR CLOTHING, NAMELY, T-SHIRTS, SHIRTS, HOODED SWEATSHIRTS, SWEATSHIRTS; HEADGEAR, NAMELY, HATS, CAPS AND BEANIES, ALL DEPICTING THE NAME AND IMAGE OF APPLICANT, FOR SALE PRIMARILY TO FANS OF APPLICANT (U.S. CLS. 22 AND 39).

FIRST USE 6-19-2008; IN COMMERCE 6-19-2008. ARETHA SOMERVILLE, EXAMINING ATTORNEY

SN 77-576,874. SUND0G PRODUCTIONS, LLC, FAIRFAX, VA. FILED 9-23-2008.

Sunpup

THE MARK CONSISTS OF STANDARD CHARACTERS WITHOUT CLAIM TO ANY PARTICULAR FONT, STYLE, SIZE, OR COLOR.

OWNER OF U.S. REG. NO. 1,863,757. FOR T-SHIRTS (U.S. CLS. 22 AND 39). FIRST USE 3-20-1991; IN COMMERCE 3-20-1991. GEORGE LORENZO, EXAMINING ATTORNEY

SN 77-579,678. NAM C. QUACH, SAN FRANCISCO, CA. AND CHARLENE CHEN, SAN FRANCISCO, CA. FILED 9-26-2008.

SILHOUETTE BY ANEW

THE MARK CONSISTS OF STANDARD CHARACTERS WITHOUT CLAIM TO ANY PARTICULAR FONT, STYLE, SIZE, OR COLOR.

FOR CLOTHING, NAMELY, PANTS, DRESSES, BODY SHAPERS, CORSETS AND PANTYHOSE (U.S. CLS. 22 AND 39).

AISHA SALEM, EXAMINING ATTORNEY

CLASS 25—(Continued).

SN 77-589,538. TOESOX, INC., CARLSBAD, CA. FILED 10-9-2008.

A Foot Revolution

THE MARK CONSISTS OF STANDARD CHARACTERS WITHOUT CLAIM TO ANY PARTICULAR FONT, STYLE, SIZE, OR COLOR.

NO CLAIM IS MADE TO THE EXCLUSIVE RIGHT TO USE "FOOT", APART FROM THE MARK AS SHOWN. FOR SOCKS (U.S. CLS. 22 AND 39).

MICHAEL LITZAU, EXAMINING ATTORNEY

SN 77-592,403. CHROME HEARTS LLC, HOLLYWOOD, CA. FILED 10-14-2008.

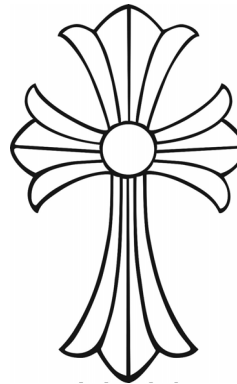

OWNER OF U.S. REG. NOS. 3,267,866 AND 3,385,415. THE MARK CONSISTS OF A CROSS DESIGN. FOR CLOTHING, NAMELY, TEE SHIRTS, SHIRTS, TANK TOPS, SWEATERS, SWEAT SHIRTS, SWEAT PANTS, JEANS, PANTS, JACKETS, COATS AND HATS (U.S. CLS. 22 AND 39).

FIRST USE 1-2-1989; IN COMMERCE 1-2-1989. JENNIFER MARTIN, EXAMINING ATTORNEY

SN 77-592,422. WOLVERINE WORLD WIDE, INC., ROCKFORD, MI. FILED 10-14-2008.

COMFORTFUSION

THE MARK CONSISTS OF STANDARD CHARACTERS WITHOUT CLAIM TO ANY PARTICULAR FONT, STYLE, SIZE, OR COLOR.

FOR FOOTWEAR (U.S. CLS. 22 AND 39). FIRST USE 1-25-2008; IN COMMERCE 1-25-2008. ROBIN CHOSID, EXAMINING ATTORNEY

CLASS 25—(Continued).

SN 77-592,695. SHELTONI, INC., SANTA MONICA, CA. FILED 10-14-2008.

Sheltini

THE MARK CONSISTS OF STANDARD CHARACTERS WITHOUT CLAIM TO ANY PARTICULAR FONT, STYLE, SIZE, OR COLOR.

FOR CLOTHING, NAMELY, LINGERIE, NEGLIGEEES, SLIPS, PANTIES, PANTS, SHORTS, SKIRTS, BLOUSES, UNDERWEAR, BODY SUITS, BRA TOPS, BRAS, BUS-TIERS, CAMISOLES, DRESSES, HALTER TOPS, JEANS, JOGGING SUITS, KNIT SHIRTS, KNIT TOPS, LEG WARMERS, LEGGINGS, LEOTARDS, NIGHT SHIRTS, PAJAMAS, PANTYHOSE, SHIRTS, SLACKS, STOCK-INGS, SUITS, SWEAT PANTS, SWEAT SHIRTS, SWEAT SHORTS, SWEAT SUITS, SWEATERS, SWIMSUITS, T-SHIRTS, TANK TOPS, TIGHTS (U.S. CLS. 22 AND 39).

FIRST USE 7-23-2008; IN COMMERCE 7-23-2008.
MARIAM MAHMOUDI, EXAMINING ATTORNEY

SN 77-595,592. SICURA DESIGNS, INC., BROOKLYN, NY. FILED 10-18-2008.

FIT 2 GO

THE MARK CONSISTS OF STANDARD CHARACTERS WITHOUT CLAIM TO ANY PARTICULAR FONT, STYLE, SIZE, OR COLOR.

FOR PANTS (U.S. CLS. 22 AND 39).
EMILY CARLSEN, EXAMINING ATTORNEY

SN 77-597,856. NAM C. QUACH, SAN FRANCISCO, CA. AND CHARLENE CHEN, SAN FRANCISCO, CA. FILED 10-22-2008.



FOR CLOTHING, NAMELY, PANTS, DRESSES, BODY SHAPERS, CORSETS AND PANTYHOSE (U.S. CLS. 22 AND 39).

AISHA SALEM, EXAMINING ATTORNEY

CLASS 25—(Continued).

SN 77-608,127. WOLVERINE WORLD WIDE, INC., ROCK-FORD, MI. FILED 11-5-2008.

WOLVERINE ICS

THE MARK CONSISTS OF STANDARD CHARACTERS WITHOUT CLAIM TO ANY PARTICULAR FONT, STYLE, SIZE, OR COLOR.

FOR FOOTWEAR (U.S. CLS. 22 AND 39).
ROBIN CHOSID, EXAMINING ATTORNEY

SN 77-623,691. WOLVERINE WORLD WIDE, INC., ROCK-FORD, MI. FILED 12-1-2008.

WOLVERINE DX

THE MARK CONSISTS OF STANDARD CHARACTERS WITHOUT CLAIM TO ANY PARTICULAR FONT, STYLE, SIZE, OR COLOR.

FOR FOOTWEAR (U.S. CLS. 22 AND 39).
ROBIN CHOSID, EXAMINING ATTORNEY

SN 77-976,367. BROWN, STACY SMITH, NEW ORLEANS, LA. FILED 12-4-2007.

LEMONADE BRIGADE

THE MARK CONSISTS OF STANDARD CHARACTERS WITHOUT CLAIM TO ANY PARTICULAR FONT, STYLE, SIZE, OR COLOR.

FOR MEN'S, WOMEN'S, CHILDREN'S AND INFANT'S CLOTHING, NAMELY, T-SHIRTS, SWEATSHIRTS, POLO SHIRTS, SWEATERS, SPORTS SHIRTS, KNIT TOPS, LONG AND SHORT SLEEVED SHIRTS, GOLF SHIRTS, HALTER TOPS, BLOUSES, NECKTIES, SLEEP-WEAR, NIGHTSHIRTS, ROBES, LOUNGEWEAR, BOX-ER SHORTS, JACKETS, COATS, RAINWEAR, PONCHOS, FOOTWEAR, HEADWEAR, HEADBANDS, VISORS, HATS, CAPS, BANDANAS, ATHLETIC UNI-FORMS, APRONS, SWEATBANDS, GYM SHORTS, ATH-LETIC SHORTS, WARM UP SUITS, SHORTS, PANTS, TROUSERS, JEANS, SOCKS, GLOVES, SCARVES, CLOTH BIBS AND DIAPER COVERS (U.S. CLS. 22 AND 39).

KIMBERLY FRYE, EXAMINING ATTORNEY

CLASS 25—(Continued).

SN 78-595,381. PONY, INC., SAN DIEGO, CA. FILED 3-25-2005.

**RISE UP NOW WITH
PONY**

THE MARK CONSISTS OF STANDARD CHARACTERS WITHOUT CLAIM TO ANY PARTICULAR FONT, STYLE, SIZE, OR COLOR.

OWNER OF U.S. REG. NOS. 2,666,379, 2,668,890 AND OTHERS.

FOR CLOTHING FOR MEN, WOMEN AND CHILDREN, NAMELY, SHIRTS, T-SHIRTS, JERSEYS, SPORT SHIRTS, HOODED PULLOVERS, TANK TOPS, SWEATSHIRTS, SWEATPANTS, TRACK SUITS, TROUSERS, PANTS, SHORTS, RAINWEAR, SWEATERS, JACKETS, COATS, RAINCOATS, JUMPERS, SNOW SUITS, TIES, ROBES, HATS, CAPS, VISORS, WRISTBANDS, HEADBANDS, BELTS, SCARVES, SLEEPWEAR, PAJAMAS, UNDERWEAR, SWIMWEAR, LOUNGEWEAR, GLOVES AND FOOTWEAR (U.S. CLS. 22 AND 39).

MONIQUE MILLER, EXAMINING ATTORNEY

SN 78-812,361. EDELMAN SHOE, INC., NEW YORK, NY. FILED 2-10-2006.

SE BOUTIQUE

THE MARK CONSISTS OF STANDARD CHARACTERS WITHOUT CLAIM TO ANY PARTICULAR FONT, STYLE, SIZE, OR COLOR.

NO CLAIM IS MADE TO THE EXCLUSIVE RIGHT TO USE "BOUTIQUE", APART FROM THE MARK AS SHOWN. FOR FOOTWEAR, NAMELY, BOOTS, SHOES, SLIPPERS AND SANDALS (U.S. CLS. 22 AND 39).

FIRST USE 6-30-2005; IN COMMERCE 6-30-2005.
GEORGE LORENZO, EXAMINING ATTORNEY

SN 78-936,853. FOCUS U.S.A. INC., NEW YORK, NY. FILED 7-25-2006.

10 OUT OF TEN

THE MARK CONSISTS OF STANDARD CHARACTERS WITHOUT CLAIM TO ANY PARTICULAR FONT, STYLE, SIZE, OR COLOR.

FOR JEANS (U.S. CLS. 22 AND 39).
FIRST USE 10-24-2005; IN COMMERCE 10-24-2005.
JULIE GUTTADAURO, EXAMINING ATTORNEY

CLASS 25—(Continued).

SN 79-052,235. M CORSET CO., LTD., REPUBLIC OF KOREA, FILED 2-13-2008.

KISSREPUBLIC

THE MARK CONSISTS OF STANDARD CHARACTERS WITHOUT CLAIM TO ANY PARTICULAR FONT, STYLE, SIZE, OR COLOR.

OWNER OF INTERNATIONAL REGISTRATION 0959680 DATED 2-13-2008, EXPIRES 2-13-2018.

FOR OVERCOATS; MANTLES; SHORT TROUSERS; SUITS; SKINS; SLACKS; OVERALLS; JACKETS; JUMPERS; JEANS; CAPES; TUNICS; PARKAS; BRASSIERES; UNDERWEAR; UNDERSHIRTS; NIGHTWEAR; T-SHIRTS; BLOUSES; UNDERPANTS; TRAINING SUITS; SKIRT SUITS; INFANT AND TODDLER ONE PIECE CLOTHING; CORSETS BEING CLOTHING; SWIMSUITS; STOCKINGS; SOCKS; POCKET SQUARES; HATS; GOLF SHOES; BOOTS; BEACH SHOES; SANDALS; BATH SLIPPERS; ATHLETIC SHOES; CAPS BEING CLOTHING; BELTS MADE OF LEATHER BEING CLOTHING; GLOVES BEING CLOTHING; PAJAMAS; KNIT SHIRTS; POLO SHIRTS; SWEATERS; SCARVES; TIGHTS (U.S. CLS. 22 AND 39).

LYDIA BELZER, EXAMINING ATTORNEY

SN 79-052,236. M CORSET CO., LTD., REPUBLIC OF KOREA, FILED 2-13-2008.

LEFEE

OWNER OF INTERNATIONAL REGISTRATION 0959681 DATED 2-13-2008, EXPIRES 2-13-2018.

FOR OVERCOATS; MANTLES; SHORT TROUSERS; SUITS; SKINS; SLACKS; OVERALLS; JACKETS; JUMPERS; JEANS; CAPES; TUNICS; PARKAS; BRASSIERES; UNDERWEAR; UNDERSHIRTS; NIGHTWEAR; T-SHIRTS; BLOUSES; UNDERPANTS; TRAINING SUITS; SKIRT SUITS; INFANT AND TODDLER ONE PIECE CLOTHING; CORSETS BEING CLOTHING; SWIMSUITS; STOCKINGS; SOCKS; POCKET SQUARES; HATS; GOLF SHOES; BOOTS; BEACH SHOES; SANDALS; BATH SLIPPERS; ATHLETIC SHOES; CAPS BEING CLOTHING; BELTS MADE OF LEATHER BEING CLOTHING; GLOVES BEING CLOTHING; PAJAMAS; KNIT SHIRTS; POLO SHIRTS; SWEATERS; SCARVES; TIGHTS (U.S. CLS. 22 AND 39).

LYDIA BELZER, EXAMINING ATTORNEY

CLASS 25—(Continued).

SN 79-053,073. BIONORICA AG, FED REP GERMANY,
FILED 3-19-2008.

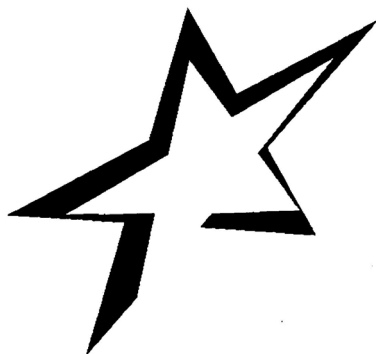

PRIORITY DATE OF 10-17-2007 IS CLAIMED.
OWNER OF INTERNATIONAL REGISTRATION 0962179
DATED 3-19-2008, EXPIRES 3-19-2018.
OWNER OF U.S. REG. NOS. 3,409,300 AND 3,449,637.
FOR CLOTHING, NAMELY, T-SHIRTS, PANTS,
DRESSES, JACKETS, TROUSERS, JUMPERS, SOCKS;
FOOTWEAR; HEADGEAR, NAMELY HATS, CAPS,
HEAD SCARFS (U.S. CLS. 22 AND 39).
ANDREA HACK, EXAMINING ATTORNEY

CLASS 25—(Continued).

SN 79-053,204. DIMENSIONI S.R.L., MILANO, ITALY,
FILED 3-6-2008.

GANESH

PRIORITY DATE OF 2-13-2008 IS CLAIMED.
OWNER OF INTERNATIONAL REGISTRATION 0962532
DATED 3-6-2008, EXPIRES 3-6-2018.
OWNER OF U.S. REG. NO. 3,362,694.
THE MARK CONSISTS OF THE WORD "GANESH".
FOR CLOTHING FOR MEN, WOMEN AND CHILDREN,
NAMELY, SHIRTS, T-SHIRTS, SKIRTS, TROUSERS,
JEANS, JACKETS, SPORTS-TYPE JACKETS, COATS,
RAINCOATS, UNDERWEAR, JUMPERS, ANORAKS,
TRACKSUITS, SPORTS TROUSERS AND T-SHIRTS,
BELTS, BRACES, TIES, SCARVES, GLOVES, SASHES
FOR WEAR, FOOTWEAR AND HEADWEAR (U.S. CLS. 22
AND 39).
MONIQUE MILLER, EXAMINING ATTORNEY

SN 79-053,203. DIMENSIONI S.R.L., MILANO, ITALY,
FILED 3-6-2008.



PRIORITY DATE OF 2-13-2008 IS CLAIMED.
OWNER OF INTERNATIONAL REGISTRATION 0962531
DATED 3-6-2008, EXPIRES 3-6-2018.
THE MARK CONSISTS OF A STYLIZATION OF THE
HINDU DEITY IN THE FORM OF AN ELEPHANT'S HEAD.
FOR CLOTHING FOR MEN, WOMEN AND CHILDREN,
NAMELY, SHIRTS, T-SHIRTS, SKIRTS, TROUSERS,
JEANS, JACKETS, SPORTS-TYPE JACKETS, COATS,
RAINCOATS, UNDERWEAR, PULLOVERS, ANORAKS,
TRACKSUITS, SPORTS TROUSERS AND T-SHIRTS,
BELTS, BRACES, TIES, SCARVES, GLOVES, SASHES
FOR WEAR, FOOTWEAR AND HEADWEAR (U.S. CLS. 22
AND 39).
MONIQUE MILLER, EXAMINING ATTORNEY

SN 79-053,881. SUNVIM GROUP CO., LTD, CHINA, FILED 4-
20-2008.

Sunvim

OWNER OF INTERNATIONAL REGISTRATION 0964442
DATED 4-20-2008, EXPIRES 4-20-2018.
OWNER OF U.S. REG. NOS. 2,854,620 AND 3,074,273.
THE ENGLISH TRANSLATION OF THE FOREIGN
WORD(S) IN THE MARK IS: THE ENGLISH WORD
"SUNVIM" HAS NO SIGNIFICANCE IN THE RELEVANT
TRADE OR INDUSTRY, AND HAS NO GEOGRAPHICAL
SIGNIFICANCE, AND HAS NO MEANING IN A FOREIGN
LANGUAGE, AND HAS NO SIGNIFICANCE AS APPLIED
TO THE GOODS.
FOR CLOTHING, NAMELY, SUITS, SINGLET, TEE-
SHIRTS, CAMISOLES, DRAWERS, BODY LINEN, DRESS-
ING GOWNS, TIGHTS, COMBINATIONS, ANTI-SWEAT
UNDERWEAR, SWEAT-ABSORBENT UNDERCLOTHING,
ANTI-SWEAT UNDERCLOTHING, CORSELETS,
CORSETS, JERSEYS, SPORTS JERSEYS, PYJAMAS,
BATH ROBES, PANTS, TEDDIES, APRONS; KNITWEAR,
NAMELY, SWEATERS; BEACH CLOTHES, NAMELY,
BEACH COVER-UPS, BIKINIS (U.S. CLS. 22 AND 39).
SONYA STEPHENS, EXAMINING ATTORNEY

CLASS 25—(Continued).

SN 79-054,109. FUJIAN HONGXINGERKE; SPORTS GOODS CO., LTD., QUANZHOU CITY, CHINA, FILED 4-28-2008.



OWNER OF INTERNATIONAL REGISTRATION 0965003 DATED 4-28-2008, EXPIRES 4-28-2018.

THE WORD APPEARING IN THE MARK HAS NO SIGNIFICANCE IN THE RELEVANT TRADE OR INDUSTRY NOR AS APPLIED TO THE GOODS LISTED IN THE APPLICATION, NOR ANY GEOGRAPHICAL SIGNIFICANCE.

THE FOREIGN WORDING IN THE MARK TRANSLATES INTO ENGLISH AS GRAND STAR.

THE TRANSLITERATION OF THE NON-LATIN CHARACTERS IN THE MARK IS: "HONG XING".

FOR COATS; TROUSERS; SHIRTS; SKIRTS; SPORTS JERSEYS; WATERPROOF CLOTHING, NAMELY, JACKETS AND PANTS; LAYETTES (CLOTHING); SWIMSUITS; BATHING CAPS; MASQUERADE COSTUMES; SARIS; CLOTHING FOR JUDO (U.S. CLS. 22 AND 39).

RICHARD WHITE, EXAMINING ATTORNEY

CLASS 25—(Continued).

SN 79-057,370. MENG FANTAO, CHINA, FILED 5-6-2008.



OWNER OF INTERNATIONAL REGISTRATION 0973360 DATED 5-6-2008, EXPIRES 5-6-2018.

THE MARK CONSISTS OF THE STYLIZED WORDING "KARVINMAX" WITH A STYLIZED "K" DESIGN APPEARING ON THE LETTER "M".

FOR CLOTHING, NAMELY, DOWN COATS, ACRYLIC COATS, DUST COATS, SHIRTS, DRESSES, JACKETS, PANTS; SHOES; HATS; NECKTIES; WAISTBANDS; SUITS; STUFF JACKETS; KNITWEAR, NAMELY, KNITTED T-SHIRTS, KNITTED DRESSES, KNITTED PANTS, KNITTED SWEATERS; CLOTHING OF LEATHER, NAMELY, LEATHER JACKETS, LEATHER COATS (U.S. CLS. 22 AND 39).

REBECCA POVARCHUK, EXAMINING ATTORNEY

CLASS 26—FANCY GOODS

SN 79-054,608. CARLA BUTI S.R.L., ITALY, FILED 4-29-2008.

CARLA BUTI

THE MARK CONSISTS OF STANDARD CHARACTERS WITHOUT CLAIM TO ANY PARTICULAR FONT, STYLE, SIZE, OR COLOR.

OWNER OF INTERNATIONAL REGISTRATION 0966368 DATED 4-29-2008, EXPIRES 4-29-2018.

THE NAME "CARLA BUTI" IDENTIFIES A LIVING INDIVIDUAL WHOSE CONSENT IS OF RECORD.

FOR ARTICLES OF CLOTHING, NAMELY, TEXTILE AND FUR JACKETS, PARKAS, AND COATS; FUR COATS; SHEARLING JACKETS; FUR AND LEATHER JACKETS, PARKAS, AND COATS; CLOTHING MADE FROM FUR, LEATHER, SHEARLING AND TEXTILE, NAMELY, SHIRTS AND PANTS; FOOTWEAR; AND HEADGEAR, NAMELY, HATS AND SCARVES (U.S. CLS. 22 AND 39).

VERNA BETH RIRIE, EXAMINING ATTORNEY

SN 77-403,128. ELISA LYSIAK, RIVERSIDE, CA. FILED 2-21-2008.

bottle Cap Clippy

THE MARK CONSISTS OF STANDARD CHARACTERS WITHOUT CLAIM TO ANY PARTICULAR FONT, STYLE, SIZE, OR COLOR.

NO CLAIM IS MADE TO THE EXCLUSIVE RIGHT TO USE "BOTTLE CAP", APART FROM THE MARK AS SHOWN.

FOR HAIR CLIPS (U.S. CLS. 37, 39, 40, 42 AND 50). FIRST USE 2-19-2008; IN COMMERCE 2-19-2008.

KELLY CHOE, EXAMINING ATTORNEY

CLASS 26—(Continued).

SN 77-426,771. KINKI AMIBARI MFG. CO., IKOMA-SHI, JAPAN, FILED 3-19-2008.



THE COLOR(S) DARK GREEN, WHITE IS/ARE CLAIMED AS A FEATURE OF THE MARK.

THE MARK CONSISTS OF THE LETTERS AND SYMBOLS "K", "A", AND "A" IN AN OVAL. THE OVAL AND THE LETTERS AND SYMBOL ARE DARK GREEN. THE INSIDE OF THE OVAL SURROUNDING THE LETTERS AND SYMBOL IS WHITE.

FOR KNITTING NEEDLES; CIRCULAR KNITTING NEEDLES; CROCHET HOOKS; DARNING NEEDLES; QUILTING NEEDLES; KNITTING ACCESSORIES, NAMELY, RUBBER POINT PROTECTORS, STITCH MARKERS, SPLIT MARKERS, BOBBINS, YARN LEADERS, STITCH HOLDERS FOR KNITTING, KNITTING COUNTERS, NEEDLE THREADERS; NOTION SETS CONSISTING OF DARNING NEEDLES, RUBBER POINT PROTECTORS FOR KNITTING NEEDLES, CABLE STITCH NEEDLES, STITCH MARKERS, SPLIT MARKERS, STITCH HOLDERS; KNITTING NEEDLE CASES; SETS OF EXCHANGEABLE CIRCULAR NEEDLES; KNITTING PINS; BLUNT NEEDLES; BUTTONS (U.S. CLS. 37, 39, 40, 42 AND 50).

FIRST USE 1-15-2006; IN COMMERCE 1-15-2006.
RICHARD A. STRASER, EXAMINING ATTORNEY

SN 77-565,363. KNOTTY INC., NEW YORK, NY. FILED 9-9-2008.

Knotty Soc

THE MARK CONSISTS OF STANDARD CHARACTERS WITHOUT CLAIM TO ANY PARTICULAR FONT, STYLE, SIZE, OR COLOR.

FOR HAIR ACCESSORIES, NAMELY, HAIR WRAPS (U.S. CLS. 37, 39, 40, 42 AND 50).

FIRST USE 6-1-2008; IN COMMERCE 6-1-2008.
JULIE WATSON, EXAMINING ATTORNEY

CLASS 27—FLOOR COVERINGS

SN 77-498,299. GREATMATS.COM, MILLTOWN, WI. FILED 6-13-2008.

GREATMATS.COM

THE MARK CONSISTS OF STANDARD CHARACTERS WITHOUT CLAIM TO ANY PARTICULAR FONT, STYLE, SIZE, OR COLOR.

SEC. 2(F).

FOR CARPETS; RUGS; FLOOR MATS AND MATTING FOR COVERING EXISTING FLOORS INCLUDING FOAM, RUBBER, PVC, POLYPROPYLENE AND VINYL (U.S. CLS. 19, 20, 37, 42 AND 50).

FIRST USE 6-1-1999; IN COMMERCE 6-1-1999.

DEBRA LEE, EXAMINING ATTORNEY

SN 77-555,856. US FABRICS, INC., DBA US FABRICS, INC., CINCINNATI, OH. FILED 8-26-2008.

Cow Carpet

THE MARK CONSISTS OF STANDARD CHARACTERS WITHOUT CLAIM TO ANY PARTICULAR FONT, STYLE, SIZE, OR COLOR.

FOR HORSE STALL FLOOR MATS (U.S. CLS. 19, 20, 37, 42 AND 50).

FIRST USE 1-1-2000; IN COMMERCE 1-1-2000.

REBECCA EISINGER, EXAMINING ATTORNEY

SN 77-562,435. STATICWORX, INC., WATERTOWN, MA. FILED 9-4-2008.

AMERIWORX

THE MARK CONSISTS OF STANDARD CHARACTERS WITHOUT CLAIM TO ANY PARTICULAR FONT, STYLE, SIZE, OR COLOR.

FOR FLOOR COVERINGS; VINYL FLOOR COVERINGS (U.S. CLS. 19, 20, 37, 42 AND 50).

ROBIN MITTLER, EXAMINING ATTORNEY

CLASS 28—TOYS AND SPORTING GOODS

SN 76-673,580. PROFESSIONAL GOLF BALL SERVICES, LTD., SUGAR LAND, TX. FILED 3-5-2007.



OWNER OF U.S. REG. NOS. 3,214,504 AND 3,229,024. THE MARK CONSISTS OF THE STYLIZED TEXT "HUNTER". WITHIN THE TEXT, THERE IS A CURVED ARROW POINTING LEFT APPEARING ABOVE THE LETTERS "UN" AND A CURVED ARROW POINTING RIGHT APPEARING BELOW SUCH LETTERS.

FOR GOLF BALLS (U.S. CLS. 22, 23, 38 AND 50). FIRST USE 1-22-2007; IN COMMERCE 1-22-2007. ESTHER BELENKER, EXAMINING ATTORNEY

SN 76-690,621. INGRAM, CHARLIE, SANTA FE, TN. FILED 6-16-2008.

BACK STABBER LURES

THE MARK CONSISTS OF STANDARD CHARACTERS WITHOUT CLAIM TO ANY PARTICULAR FONT, STYLE, SIZE, OR COLOR.

NO CLAIM IS MADE TO THE EXCLUSIVE RIGHT TO USE "LURES", APART FROM THE MARK AS SHOWN.

FOR FISHING LURES (U.S. CLS. 22, 23, 38 AND 50). GILBERT SWIFT, EXAMINING ATTORNEY

SN 76-692,628. PRP PRODUCT DESIGN, INC., TURLOCK, CA. FILED 9-4-2008.

SPORTS BALLS 2 U

THE MARK CONSISTS OF STANDARD CHARACTERS WITHOUT CLAIM TO ANY PARTICULAR FONT, STYLE, SIZE, OR COLOR.

NO CLAIM IS MADE TO THE EXCLUSIVE RIGHT TO USE "SPORTS BALLS", APART FROM THE MARK AS SHOWN.

FOR SPORTS BALLS IMPRINTED WITH GREETINGS (U.S. CLS. 22, 23, 38 AND 50).

KRISTIN DAHLING, EXAMINING ATTORNEY

SN 76-692,724. PRP PRODUCT DESIGN, INC., TURLOCK, CA. FILED 9-10-2008.

TXT DIS PIX

THE MARK CONSISTS OF STANDARD CHARACTERS WITHOUT CLAIM TO ANY PARTICULAR FONT, STYLE, SIZE, OR COLOR.

FOR ELECTRONIC GAME SOFTWARE FOR CELLULAR TELEPHONES (U.S. CLS. 22, 23, 38 AND 50).

KRISTIN DAHLING, EXAMINING ATTORNEY

CLASS 28—(Continued).

SN 77-019,972. GROUPE PROCYCLE INC., BEAUCE, QUEBEC, CANADA, FILED 10-12-2006.

THE POWER OF TRAINING

THE MARK CONSISTS OF STANDARD CHARACTERS WITHOUT CLAIM TO ANY PARTICULAR FONT, STYLE, SIZE, OR COLOR.

PRIORITY CLAIMED UNDER SEC. 44(D) ON CANADA APPLICATION NO. 1318490, FILED 9-29-2006, REG. NO. TMA727770, DATED 11-5-2008, EXPIRES 11-5-2023.

NO CLAIM IS MADE TO THE EXCLUSIVE RIGHT TO USE "TRAINING", APART FROM THE MARK AS SHOWN.

FOR EXERCISE AND FITNESS EQUIPMENT, NAMELY, STATIONARY EXERCISE BICYCLES, TREADMILLS, STAIR CLIMBERS, ELLIPTICAL MACHINES, ROWING MACHINES; EQUIPMENT USED FOR CARDIOVASCULAR TRAINING, STRENGTH AND WEIGHT TRAINING, NAMELY, EQUIPMENT THAT EXERCISES, DEVELOPS AND TRAINS THE MUSCLES OF THE HUMAN BODY, NAMELY, FREE WEIGHTS, EXERCISE BENCHES, DUMBBELLS, AND STRENGTH AND WEIGHT TRAINING MACHINES THAT EXERCISE THE MUSCLES BY DELIVERING RESISTANCE BY MEANS OF PRESSURE OR TRACTION, NAMELY, LONG BAR, SHORT BARS, TRICEPS BAR, WEIGHT PLATES, KNEE BENDING MACHINE, PULL-UP STATION (U.S. CLS. 22, 23, 38 AND 50).

STEPHEN AQUILA, EXAMINING ATTORNEY

SN 77-136,397. JAKKS PACIFIC, INC., MALIBU, CA. FILED 3-21-2007.

MEGA-NOODLE

THE MARK CONSISTS OF STANDARD CHARACTERS WITHOUT CLAIM TO ANY PARTICULAR FONT, STYLE, SIZE, OR COLOR.

OWNER OF U.S. REG. NOS. 2,107,382, 3,091,061 AND OTHERS.

FOR FLOATS FOR RECREATIONAL USE, NAMELY, FLEXIBLE FOAM CONSTRUCTION TOYS, TOY FOAM FIGURES, FOAM BATH TOYS, SOFT SCULPTURE FOAM TOYS, FOAM FLOATS FOR RECREATIONAL USE; INFLATABLE FLOAT MATTRESSES OR PADS FOR RECREATIONAL USE; SWIM FLOATS FOR RECREATIONAL USE; WATER SQUIRTING TOYS (U.S. CLS. 22, 23, 38 AND 50).

C. DIONNE CLYBURN, EXAMINING ATTORNEY

CLASS 28—(Continued).

SN 77-136,408. JAKKS PACIFIC, INC., MALIBU, CA. FILED 3-21-2007.

OODLE

THE MARK CONSISTS OF STANDARD CHARACTERS WITHOUT CLAIM TO ANY PARTICULAR FONT, STYLE, SIZE, OR COLOR.

OWNER OF U.S. REG. NOS. 2,107,382, 3,091,061 AND OTHERS.

FOR WATER SQUIRTING TOYS; FLOATS FOR RECREATIONAL USE, NAMELY, FLEXIBLE FOAM CONSTRUCTION TOYS, TOY FOAM FIGURES, FOAM BATH TOYS, SOFT SCULPTURE FOAM TOYS, FOAM FLOATS FOR RECREATIONAL USE; INFLATABLE FLOAT MATTRESSES OR PADS FOR RECREATIONAL USE; SWIM FLOATS FOR RECREATIONAL USE (U.S. CLS. 22, 23, 38 AND 50).

C. DIONNE CLYBURN, EXAMINING ATTORNEY

CLASS 28—(Continued).

SN 77-305,604. ANGLER'S SELECT LLC, VERNON, NJ. FILED 10-16-2007.

Eco Pro Tungsten

SN 77-265,783. TECHNO SOURCE, KOWLOON, HONG KONG, FILED 8-28-2007.

GUESS WHAT I AM!

THE MARK CONSISTS OF STANDARD CHARACTERS WITHOUT CLAIM TO ANY PARTICULAR FONT, STYLE, SIZE, OR COLOR.

FOR BOARD GAMES; EQUIPMENT SOLD AS A UNIT FOR PLAYING BOARD GAMES (U.S. CLS. 22, 23, 38 AND 50).

ESTHER A. BORSUK, EXAMINING ATTORNEY

SN 77-291,577. MATTEL, INC., EL SEGUNDO, CA. FILED 9-28-2007.

THOR-AXINE STREET CAR

THE MARK CONSISTS OF STANDARD CHARACTERS WITHOUT CLAIM TO ANY PARTICULAR FONT, STYLE, SIZE, OR COLOR.

NO CLAIM IS MADE TO THE EXCLUSIVE RIGHT TO USE "STREET CAR", APART FROM THE MARK AS SHOWN.

FOR TOYS, GAMES AND PLAYTHINGS, NAMELY, TOY VEHICLES AND ACCESSORIES THEREFOR (U.S. CLS. 22, 23, 38 AND 50).

LINDA MICKLEBURGH, EXAMINING ATTORNEY

THE MARK CONSISTS OF STANDARD CHARACTERS WITHOUT CLAIM TO ANY PARTICULAR FONT, STYLE, SIZE, OR COLOR.

NO CLAIM IS MADE TO THE EXCLUSIVE RIGHT TO USE "PRO" AND "TUNGSTEN", APART FROM THE MARK AS SHOWN.

FOR ARTIFICIAL FISHING BAIT; ARTIFICIAL FISHING LURES; ARTIFICIAL FISHING WORMS; FISH ATTRACTANTS; FISH HOOK REMOVERS; FISHING AID WHICH SINKS TO THE BOTTOM OF ANY BODY OF WATER IN WHICH IT IS PLACED AND STANDS VERTICALLY FROM THE BOTTOM WITH FISH LINE ATTACHED A FEW INCHES FROM THE HOOK INTENDED TO CATCH THE FISH; FISHING EQUIPMENT, NAMELY, CLAMPS FOR SECURING FISHING EQUIPMENT ON BODY; FISHING EQUIPMENT, NAMELY, WINGING MATERIAL FOR FISHING JIGS AND STREAMERS; FISHING FLOATS; FISHING FLY BOXES; FISHING HOOKS; FISHING LEADERS; FISHING LINES; FISHING LURE BOXES; FISHING LURE PARTS; FISHING LURES; FISHING LURES, NAMELY, PLASTIC WORMS; FISHING PLUGS; FISHING REELS; FISHING ROD BLANKS; FISHING RODS; FISHING SINKERS; FISHING SPINNERS; FISHING TACKLE; FISHING TACKLE BOXES; FISHING TACKLE CONTAINERS; FISHING TACKLE, NAMELY, BOBBERS; FISHING WEIGHTS; FLIES FOR USE IN FISHING; LURES FOR FISHING; SCENT LURES FOR HUNTING OR FISHING; SPEARS FOR USE IN FISHING (U.S. CLS. 22, 23, 38 AND 50).

FIRST USE 9-1-2007; IN COMMERCE 10-1-2007.

JEFF DEFORD, EXAMINING ATTORNEY

CLASS 28—(Continued).

SN 77-328,830. ABRAMS GENTILE ENTERTAINMENT, INC., NEW YORK, NY. FILED 11-14-2007.

Shining Stars

THE MARK CONSISTS OF STANDARD CHARACTERS WITHOUT CLAIM TO ANY PARTICULAR FONT, STYLE, SIZE, OR COLOR.

OWNER OF U.S. REG. NO. 2,560,404.
 FOR RUBBER BALLS; ACTION FIGURES AND ACCESSORIES THEREFOR; ACTION SKILL GAMES; BEAN BAG DOLLS; PLUSH TOYS; BALLOONS; GOLF BALLS; TENNIS BALLS; BATH TOYS; CHRISTMAS TREE ORNAMENTS; BOARD GAMES; TOY BUILDING BLOCKS; EQUIPMENT SOLD AS A UNIT FOR PLAYING CARD GAMES; CHILDREN'S PLAY COSMETICS; CRIB TOYS; ELECTRIC ACTION TOYS; MANIPULATIVE GAMES; GOLF GLOVES; GOLF BALL MARKERS; JIGSAW PUZZLES; KITES; TOY MOBILES; MUSIC BOX TOYS; PARTY FAVORS IN THE NATURE OF SMALL TOYS; INFLATABLE POOL TOYS; CHILDREN'S MULTIPLE ACTIVITY TOYS; WIND-UP TOYS; TARGET GAMES; DISC-TYPE TOSS TOYS; TOY BOWS AND ARROWS; TOY VEHICLES; TOY CARS; TOY TRUCKS; TOY BUCKET AND SHOVEL SETS; ROLLER SKATES; TOY MODEL HOBBYCRAFT KITS; TOY ROCKETTS; TOY GUNS; TOY HOLSTERS; MUSICAL TOYS; BADMINTON SETS; BUBBLE MAKING WANDS AND SOLUTION SETS; TOY FIGURINES; TOY BANKS; PUPPETS; YO-YOS; SKATEBOARDS; TOY SCOOTERS; COSTUME FACE MASKS; HAND-HELD UNIT FOR PLAYING ELECTRONIC GAMES (U.S. CLS. 22, 23, 38 AND 50).
 EVELYN BRADLEY, EXAMINING ATTORNEY

SN 77-358,934. GOCUCKOO, INC., GLENVILLE, NY. FILED 12-23-2007.



THE MARK CONSISTS OF CIRCULAR GEOMETRIC DESIGNS COMPRISING A CIRCLE IN WHICH THERE IS A FACE WITH GEOMETRIC SHAPES FOR FEATURES. ABOVE THE CIRCLE IS THE WORDING "GOCUCKOO" IN STYLIZED LETTERING WITH EYES FORMING THE LAST TWO LETTERS, "OO".
 FOR DOG TOYS (U.S. CLS. 22, 23, 38 AND 50).
 FIRST USE 6-0-2006; IN COMMERCE 12-1-2007.
 SUZANNE BLANE, EXAMINING ATTORNEY

CLASS 28—(Continued).

SN 77-397,340. MATTEL, INC., EL SEGUNDO, CA. FILED 2-14-2008.

ULTIMATE BOAT PARTY

THE MARK CONSISTS OF STANDARD CHARACTERS WITHOUT CLAIM TO ANY PARTICULAR FONT, STYLE, SIZE, OR COLOR.

NO CLAIM IS MADE TO THE EXCLUSIVE RIGHT TO USE "BOAT", APART FROM THE MARK AS SHOWN.
 FOR TOYS, GAMES AND PLAYTHINGS, NAMELY, A DOLL PLAYSET CONSISTING OF DOLLS, DOLL CLOTHING AND DOLL ACCESSORIES (U.S. CLS. 22, 23, 38 AND 50).
 CHERYL CLAYTON, EXAMINING ATTORNEY

SN 77-408,242. CARLESIMO, MICHAEL O., JACKSON, NJ. FILED 2-28-2008.

PUSH UP MASTER

THE MARK CONSISTS OF STANDARD CHARACTERS WITHOUT CLAIM TO ANY PARTICULAR FONT, STYLE, SIZE, OR COLOR.

NO CLAIM IS MADE TO THE EXCLUSIVE RIGHT TO USE "PUSH UP", APART FROM THE MARK AS SHOWN.
 FOR EXERCISE EQUIPMENT, NAMELY, BLOCKS, MATS AND CHEST PULLS (U.S. CLS. 22, 23, 38 AND 50).
 ANNE MADDEN, EXAMINING ATTORNEY

SN 77-409,614. WHITE LOTUS MEDIA LIMITED, KOW-LOON, HONG KONG, FILED 2-29-2008.

FROBOTS

THE MARK CONSISTS OF STANDARD CHARACTERS WITHOUT CLAIM TO ANY PARTICULAR FONT, STYLE, SIZE, OR COLOR.

FOR TOYS, NAMELY, DOLLS (U.S. CLS. 22, 23, 38 AND 50).
 LINDA MICKLEBURGH, EXAMINING ATTORNEY

CLASS 28—(Continued).

SN 77-410,568. FANTREPRENEUR, LLC, FALLS CHURCH, VA. FILED 3-1-2008.

HOME TEAM HANDZ

THE MARK CONSISTS OF STANDARD CHARACTERS WITHOUT CLAIM TO ANY PARTICULAR FONT, STYLE, SIZE, OR COLOR.

FOR TOY NOVELTY NOISEMAKERS (U.S. CLS. 22, 23, 38 AND 50).

MARTHA FROMM, EXAMINING ATTORNEY

SN 77-412,352. STORCH, AUDREY L, WAYNE, NJ. FILED 3-4-2008.

HUGGEE MISS YOU

THE MARK CONSISTS OF STANDARD CHARACTERS WITHOUT CLAIM TO ANY PARTICULAR FONT, STYLE, SIZE, OR COLOR.

FOR DOLLS; DOLLS AND ACCESSORIES THEREFOR; DOLLS FOR PLAYING; PLUSH TOYS; STUFFED AND PLUSH TOYS; STUFFED DOLLS AND ANIMALS (U.S. CLS. 22, 23, 38 AND 50).

FIRST USE 12-23-1998; IN COMMERCE 9-21-1999.
ANDREA SAUNDERS, EXAMINING ATTORNEY

SN 77-414,224. JAKKS PACIFIC, INC., MALIBU, CA. FILED 3-5-2008.

SPA FANTASY

THE MARK CONSISTS OF STANDARD CHARACTERS WITHOUT CLAIM TO ANY PARTICULAR FONT, STYLE, SIZE, OR COLOR.

FOR TOYS, GAMES AND PLAYTHINGS, NAMELY, CHILDREN'S PLAY COSMETICS, TOY COSMETIC MAKING KITS, TOY TOILETRY SETS (U.S. CLS. 22, 23, 38 AND 50).

BRIAN PINO, EXAMINING ATTORNEY

CLASS 28—(Continued).

SN 77-432,382. THE SAUL ZAENTZ COMPANY, BERKELEY, CA. FILED 3-26-2008.

CONQUER THE WORLD BENEATH

THE MARK CONSISTS OF STANDARD CHARACTERS WITHOUT CLAIM TO ANY PARTICULAR FONT, STYLE, SIZE, OR COLOR.

FOR TOYS, GAMES AND PLAYTHINGS; ACTION FIGURES; ACTION SKILL GAMES; ACCESSORIES FOR TOY STRUCTURES THAT ARE IN THE NATURE OF BUILDINGS, FORTS, HOUSES, CASTLES AND CAVES; ACTION-TYPE TARGET GAMES; AMUSEMENT PARK RIDES; ARCADE GAMES; ARCADE-TYPE ELECTRONIC VIDEO GAMES; BACKGAMMON GAME SETS; BALLOONS; BALLS FOR GAMES; BATH TOYS; BATTERY-POWERED LCD GAME MACHINES FEATURING ANIMATION AND SOUND EFFECTS; BEACH BALLS; BILLIARD GAME PLAYING EQUIPMENT; BOARD GAMES; BOARD GAMES IN THE NATURE OF MAZE GAMES; BOARD GAMES IN THE NATURE OF MAZE GAMES FOR CHILDREN; BOBBLE HEAD DOLLS; CARD GAMES; CHESS BOARDS; CHESS GAME SETS; CHESS PIECES SOLD SEPARATELY; CHESS PIECES SOLD AS A SET; CHRISTMAS TREE DECORATIONS; CHRISTMAS TREE ORNAMENTS EXCEPT CONFECTONERY AND ILLUMINATION ARTICLES; COIN OPERATED PINBALL MACHINES; COIN-OPERATED STAND ALONE VIDEO GAME MACHINES; COIN-OPERATED VIDEO GAMES; COLLECTIBLE MARBLES; COLLECTIBLE TOY FIGURES; CONSTRUCTION TOYS; COSTUME MASKS; DARTS; DART GAMES; DICE GAMES; DOLL CLOTHING; DOLLS; ELECTRONIC ACTION TOYS; ELECTRONIC DART GAMES; ELECTRONIC EDUCATIONAL GAME MACHINES FOR CHILDREN; EQUIPMENT SOLD AS A UNIT FOR PLAYING ACTION TYPE TARGET GAMES; EQUIPMENT SOLD AS A UNIT FOR PLAYING BOARD GAMES; EQUIPMENT SOLD AS A UNIT FOR PLAYING CARD GAMES; EQUIPMENT SOLD AS A UNIT FOR PLAYING HAND HELD ELECTRONIC GAMES; FANTASY CHARACTER TOYS; FLYING DISCS; HAND HELD ELECTRONIC ACTION TOY; HAND HELD ELECTRONIC LEARNING TOY; HAND HELD UNIT FOR PLAYING ELECTRONIC GAMES; HAND HELD UNIT FOR PLAYING VIDEO GAMES; HOBBY CRAFT SETS FOR DECORATING HAIR; HOBBY CRAFT SETS FOR MAKING BEADS; HOBBY CRAFT SETS FOR MAKING CRYSTALS; HOBBY CRAFT SETS FOR MAKING DECORATIVE OBJECTS WITH MAGNETS; HOBBY CRAFT SETS FOR MAKING MODEL BUILDINGS; HOBBY CRAFT SETS FOR MAKING MODEL FIGURES; HOBBY CRAFT SETS FOR MAKING SAND ART; HOBBY CRAFT SETS FOR MAKING TOY JEWELRY; HOBBY CRAFT SETS FOR MOLDING CHOCOLATE; HOBBY CRAFT SETS CONSISTING OF PLAY COSMETICS; INFLATABLE TOYS; HURDLES; INFLATABLE TOYS IN THE NATURE OF MAZE GAMES; IN-LINE SKATES; JAVELINS; JIGSAW PUZZLES; KALEIDOSCOPIES; KITES; LCD GAME MACHINES; MARBLES; MECHANICAL ACTION TOYS; MEMORY GAMES; MODELS, NAMELY, SCALE MODEL AIRPLANES; NON-COIN OPERATED AMUSEMENT GAME MACHINES; NON-COIN OPERATED PINBALL MACHINES; NON-MOTORIZED TOY SCOOTERS; PAPER FACE MASKS; PAPER PARTY HATS; PARLOR GAMES; PINBALL GAMES; PINBALL TYPE GAMES; PINBALL MACHINES; PLAY KITS CONSISTING PRIMARILY OF PLAY COSMETICS; PLAY SETS FOR ACTION FIGURES; PLAY SETS COMPRISED OF ACTION FIGURES AND CASES FOR ACTION FIGURES SOLD AS A UNIT; PLAY SETS FOR MASQUERADE GAMES; PLAYING CARDS; PLUSH DOLLS WITH SOUND; PLUSH DOLLS WITHOUT SOUND; PLUSH TOYS; POSITIONABLE TOY FIGURES; PUPPETS; RAG DOLLS WITH SOUND; RAG DOLLS WITHOUT SOUND; REMOTE CONTROLLED ACTION FIGURES; TOYS, NAMELY, RING TOSS GAMES FEATURING TOY CIRCULAR RINGS THAT ARE FLIPPED AND COLLECTED; ROLE-PLAYING GAMES; ROLE-

CLASS 28—(Continued).

PLAYING TOYS, NAMELY, COSTUMES, COSTUME MASKS, SWORDS, BEARDS, WIGS AND COSMETICS SOLD AS A UNIT; ROLLER SKATES; RUBBER BALLS; SAND TOYS; SKATEBOARDS; SOCCER BALLS; SOFT SCULPTURE TOYS; SPORTS BALLS; SPORTING EQUIPMENT IN THE NATURE OF ARROWS, BOWS, BOW CASES AND QUIVERS; STAND ALONE VIDEO GAME MACHINES; SURF BOARDS; SWIM FLOATS FOR RECREATIONAL USE; SWIMMING AIDS IN THE NATURE OF POOL RINGS; SWIM TOYS IN THE NATURE OF POOL RINGS; TALKING TOYS; TARGET GAMES; THREE-DIMENSIONAL PUZZLES EXCEPT CROSS-WORD PUZZLES; TRADING CARD GAMES; TOY ACTION FIGURE ACCESSORIES; TOY ACTION FIGURES; TOY ARMOR; TOY AXES; TOY BANKS; TOY BOWS; TOY ARROWS; TOY BOBBING HEAD FIGURES; TOY BOXES; TOY BUILDING BLOCKS AND CONNECTING LINKS FOR TOY BUILDING BLOCKS; TOY CANDY DISPENSERS; TOY CANDY HOLDERS; TOY CASTLES; TOY COIN BANKS; TOY COSMETIC KITS CONSISTING PRIMARILY OF SOME COMBINATION OF BLUSH, EYE SHADOW, LIPSTICK, NAIL POLISH AND ROUGE; TOY PLAY COSMETIC KITS CONSISTING PRIMARILY OF CHILDREN'S PLAY COSMETICS; TOY COSMETIC KITS CONSISTING PRIMARILY OF TOY COSMETICS AND TOY MIRRORS; TOY DAGGERS; TOY ENGINE POWERED MODEL VEHICLES; TOY FENCES; TOY FIGURES; TOY FORTS; TOY MINIATURE HELMETS; TOY KNIVES; TOY LADDERS; TOY MACES IN THE NATURE OF TOY CLUBS; TOY MACES IN THE NATURE OF TOY CEREMONIAL MACES; TOY MODELING COMPOUND; TOY MODELING DOUGH; TOY PEDAL CARS; TOY RADIO CONTROLLED VEHICLES; TOY SCOOTERS; TOY SNOW GLOBES; TOY STRUCTURES IN THE NATURE OF TOY BUILDINGS, TOY FORTS, TOY HOUSES, TOY CASTLES AND TOY CAVES; TOY SWORDS; TOY THROWING DISCS; TOY TREES FOR CHILDREN'S PLAYSETS; TOY VEHICLES; TOY VEHICLE ACCESSORIES; TOY WATCHES; TOY WEAPONS; TOYS IN THE NATURE OF BINGO GAMES PLAYING EQUIPMENT; TOYS IN THE NATURE OF CRAPS GAME PLAYING EQUIPMENT; TRANSFORMING ROBOTIC TOYS; TWO-DIMENSIONAL PUZZLES EXCEPT CROSS-WORD PUZZLES; TOY WHISTLES; WIND-UP TOYS; YOS (U.S. CLS. 22, 23, 38 AND 50).

BILL DAWE, EXAMINING ATTORNEY

SN 77-442,187. MATTEL, INC., EL SEGUNDO, CA. FILED 4-7-2008.

MUMMY'S GOLD

THE MARK CONSISTS OF STANDARD CHARACTERS WITHOUT CLAIM TO ANY PARTICULAR FONT, STYLE, SIZE, OR COLOR.

FOR TOYS, GAMES AND PLAYTHINGS, NAMELY, TOY VEHICLE PLAYSETS AND ACCESSORIES THEREFOR (U.S. CLS. 22, 23, 38 AND 50).

ANTHONY RINKER, EXAMINING ATTORNEY

CLASS 28—(Continued).

SN 77-442,814. MATTEL, INC., EL SEGUNDO, CA. FILED 4-8-2008.

TWILLERBEES

THE MARK CONSISTS OF STANDARD CHARACTERS WITHOUT CLAIM TO ANY PARTICULAR FONT, STYLE, SIZE, OR COLOR.

FOR TOYS, GAMES AND PLAYTHINGS, NAMELY, DOLLS, DOLL CLOTHING AND DOLL ACCESSORIES, TOY FIGURES AND ACCESSORIES THEREFOR (U.S. CLS. 22, 23, 38 AND 50).

FIRST USE 11-13-2008; IN COMMERCE 11-13-2008.
SUE LAWRENCE, EXAMINING ATTORNEY

SN 77-442,816. MATTEL, INC., EL SEGUNDO, CA. FILED 4-8-2008.

PEEKABOO PLACE

THE MARK CONSISTS OF STANDARD CHARACTERS WITHOUT CLAIM TO ANY PARTICULAR FONT, STYLE, SIZE, OR COLOR.

FOR TOYS, GAMES AND PLAYTHINGS, NAMELY, DOLL PLAYSETS AND ACCESSORIES THEREFOR (U.S. CLS. 22, 23, 38 AND 50).

SUE LAWRENCE, EXAMINING ATTORNEY

SN 77-442,829. MATTEL, INC., EL SEGUNDO, CA. FILED 4-8-2008.

ALLAN

THE MARK CONSISTS OF STANDARD CHARACTERS WITHOUT CLAIM TO ANY PARTICULAR FONT, STYLE, SIZE, OR COLOR.

OWNER OF U.S. REG. NO. 2,849,271.

FOR TOYS, GAMES AND PLAYTHINGS, NAMELY, DOLLS, DOLL CLOTHING AND DOLL ACCESSORIES, TOY FIGURES AND ACCESSORIES THEREFOR (U.S. CLS. 22, 23, 38 AND 50).

SUE LAWRENCE, EXAMINING ATTORNEY

CLASS 28—(Continued).

SN 77-442,830. MATTEL, INC., EL SEGUNDO, CA. FILED 4-8-2008.

SO MANY SURPRISES

THE MARK CONSISTS OF STANDARD CHARACTERS WITHOUT CLAIM TO ANY PARTICULAR FONT, STYLE, SIZE, OR COLOR.

FOR TOYS, GAMES AND PLAYTHINGS, NAMELY, DOLLS, DOLL CLOTHING AND DOLL ACCESSORIES, TOY FIGURES AND ACCESSORIES THEREFOR (U.S. CLS. 22, 23, 38 AND 50).

SUE LAWRENCE, EXAMINING ATTORNEY

SN 77-451,380. MATTEL, INC., EL SEGUNDO, CA. FILED 4-17-2008.

URBAN AGENT

THE MARK CONSISTS OF STANDARD CHARACTERS WITHOUT CLAIM TO ANY PARTICULAR FONT, STYLE, SIZE, OR COLOR.

OWNER OF U.S. REG. NO. 2,660,831.

FOR TOYS, GAMES AND PLAYTHINGS, NAMELY, TOY VEHICLES AND ACCESSORIES THEREFOR (U.S. CLS. 22, 23, 38 AND 50).

SUE LAWRENCE, EXAMINING ATTORNEY

SN 77-451,382. MATTEL, INC., EL SEGUNDO, CA. FILED 4-17-2008.

KING GRAYSKULL

THE MARK CONSISTS OF STANDARD CHARACTERS WITHOUT CLAIM TO ANY PARTICULAR FONT, STYLE, SIZE, OR COLOR.

OWNER OF U.S. REG. NOS. 1,212,575, 2,854,996 AND 2,916,555.

FOR TOYS, GAMES AND PLAYTHINGS, NAMELY, TOY ACTION FIGURES AND ACCESSORIES THEREFOR (U.S. CLS. 22, 23, 38 AND 50).

SUE LAWRENCE, EXAMINING ATTORNEY

CLASS 28—(Continued).

SN 77-467,324. MVP GAMING, INC., LAS VEGAS, NV. FILED 5-6-2008.



NO CLAIM IS MADE TO THE EXCLUSIVE RIGHT TO USE "GRAND SLAM POKER!", APART FROM THE MARK AS SHOWN.

THE STIPPLING IS FOR SHADING PURPOSES ONLY.

THE MARK CONSISTS OF THE STYLIZED WORDS "GRAND SLAM POKER!". TO THE LEFT OF THE TEXT IS AN IMAGE OF A BASEBALL AND BASEBALL DIAMOND.

FOR CASINO TABLE GAME (U.S. CLS. 22, 23, 38 AND 50).

FIRST USE 6-22-2005; IN COMMERCE 6-22-2005.

ANNE MADDEN, EXAMINING ATTORNEY

SN 77-481,748. VENOM, LLC, SAN FRANCISCO, CA. FILED 5-22-2008.

DEADLOCKE

THE MARK CONSISTS OF STANDARD CHARACTERS WITHOUT CLAIM TO ANY PARTICULAR FONT, STYLE, SIZE, OR COLOR.

FOR TOYS, GAMES AND PLAYTHINGS, NAMELY, ACTION FIGURES; AMUSEMENT PARK RIDES; CASES FOR TOY FIGURES; ACTION SKILL GAMES, NAMELY, DICE GAMES, MEMORY GAMES, AND PIN-BALL TYPE GAMES; ACTION-TYPE TARGET GAMES, NAMELY, DART GAMES, ELECTRONIC DART GAMES, AND RING TOSS GAMES; ARCADE GAMES; BACKGAMMON GAME SETS; BALLOONS; BALLS, NAMELY, BALLS FOR GAMES, BEACH BALLS, RUBBER BALLS AND SPORTS BALLS; BATH TOYS; BOARD GAMES; CARD GAMES; CHESS BOARDS; CHESS GAME SETS; CHESS PIECES PACKAGED SEPARATELY AND AS A SET; MAZE GAMES; CHRISTMAS TREE ORNAMENTS; COIN OPERATED PINBALL MACHINES; COIN-OPERATED STAND ALONE VIDEO GAME MACHINES; COLLECTIBLE MARBLES; COLLECTIBLE TOY FIGURES; CONSTRUCTION TOYS; COSTUME MASKS; DARTS; DOLL CLOTHING; DOLLS; ELECTRONIC ACTION TOYS; ELECTRONIC EDUCATIONAL GAME MACHINES FOR CHILDREN; EQUIPMENT PACKAGED AS A UNIT FOR PLAYING ACTION TYPE TARGET GAMES; EQUIPMENT PACKAGED AS A UNIT FOR PLAYING BOARD GAMES; EQUIPMENT PACKAGED AS A UNIT FOR PLAYING CARD GAMES; HAND HELD ELECTRONIC LEARNING TOYS; FANTASY CHARACTER TOYS; FLYING DISCS; TRADING CARD GAMES; ARCADE-TYPE ELECTRONIC VIDEO GAMES; HAND HELD UNIT FOR PLAYING ELECTRONIC GAMES; HAND HELD ELECTRONIC ACTION TOYS; HOBBY CRAFT SETS FOR DECORATING HAIR; HOBBY CRAFT SETS FOR MAKING BEADS; HOBBY CRAFT SETS FOR MAKING CRYSTALS; HOBBY CRAFT SETS FOR MAKING DECORATIVE OBJECTS WITH MAGNETS; HOBBY CRAFT SETS FOR MAKING MODEL BUILDINGS; HOBBY CRAFT SETS FOR MAKING MODEL FIGURES; HOBBY CRAFT SETS FOR MAKING SAND ART; HOBBY CRAFT SETS FOR MAKING SOAP; HOBBY CRAFT SETS FOR MAKING TOY JEWELRY; HOBBY CRAFT SETS FOR MOLDING CHOCOLATE; HOBBY

CLASS 28—(Continued).

CRAFT SETS CONSISTING OF PLAY COSMETICS; INFLATABLE TOYS IN THE NATURE OF MAZE GAMES AND BOARD GAMES IN THE NATURE OF MAZE GAMES; IN-LINE SKATES; JIGSAW PUZZLES; KITES; LCD GAME MACHINES; MARBLES; MECHANICAL ACTION TOYS; NON-COIN OPERATED AMUSEMENT GAME MACHINES; NON-MOTORIZED TOY SCOOTERS; PAPER FACE MASKS; PARLOR GAMES; PINBALL GAMES; PINBALL MACHINES; PLAY KITS CONSISTING OF PLAY COSMETICS; PLAY SETS, NAMELY, PLAY SETS FOR ACTION FIGURES, PLAY SETS COMPOSED OF ACTION FIGURES AND CASES FOR ACTION FIGURES SOLD AS A UNIT, AND PLAY SETS FOR MASQUERADE GAMES; PLAYING CARDS; PLUSH DOLLS WITH SOUND; PLUSH DOLLS WITHOUT SOUND; PLUSH TOYS; SWIM TOYS IN THE NATURE OF POOL RINGS; POSITIONABLE TOY FIGURES; PUPPETS; RAG DOLLS WITH SOUND; RAG DOLLS WITHOUT SOUND; REMOTE CONTROLLED ACTION FIGURES; ROLE-PLAYING GAMES; ROLE-PLAYING TOYS, NAMELY, COSTUMES, COSTUME MASKS, SWORDS, BEARDS, WIGS AND COSMETICS; ROLLER SKATES; SAND TOYS; SKATEBOARDS; SOCCER BALLS; SOFT SCULPTURE TOYS; BILLIARD GAME PLAYING EQUIPMENT; STAND ALONE VIDEO GAME MACHINES; SURF BOARDS; SWIM FLOATS FOR RECREATIONAL USE; TALKING TOYS; THREE-DIMENSIONAL PUZZLES; TOY ACTION FIGURE AND ACCESSORIES THEREFOR; TOY ACTION FIGURES; TOY ARMOR; TOY AXES; TOY BANKS; TOY BOWS; TOY ARROWS; TOY BOBBING HEAD FIGURES; TOY BOXES; TOY BUILDING BLOCKS AND CONNECTING LINKS FOR TOY BUILDING BLOCKS; TOY CANDY DISPENSERS; TOY CANDY HOLDERS; TOY CASTLES; TOY COIN BANKS; TOY COSMETIC KITS CONSISTING PRIMARILY OF SOME COMBINATION OF LIPSTICK, ROUGE, EYE SHADOW, BLUSH, AND NAIL POLISH; TOY COSMETIC KITS COMPRISING CHILDREN'S PLAY COSMETICS; TOY COSMETIC KITS COMPRISING TOY COSMETICS AND TOY MIRRORS; TOY DAGGERS; TOY ENGINE POWERED MODEL VEHICLES; TOY FENCES; TOY FIGURES; TOY FORTS; TOY GUNS; TOY MINIATURE HELMETS; TOY KNIVES; TOY LADDERS; TOY PEDAL CARS; TOY RADIO CONTROLLED VEHICLES; TOY SCOOTERS; TOY SNOW GLOBES; TOY STRUCTURES IN THE NATURE OF TOY BUILDINGS; TOY FORTS, TOY HOUSES, TOY CASTLES, AND TOY CAVES; TOY ACCESSORIES FOR TOY STRUCTURES IN THE NATURE OF TOY FURNITURE, TOY WEAPONS, TOY FOOD AND TOY FIGURES; TOY SWORDS; TOY THROWING DISCS; TOY TREES; TOY VEHICLES; TOY VEHICLE ACCESSORIES; TOY WATCHES; TOY WEAPONS; BINGO GAME PLAYING EQUIPMENT; TRANSFORMING ROBOTIC TOYS; TWO-DIMENSIONAL PUZZLES EXCEPT CROSSWORD PUZZLES; TOY WHISTLES; WIND-UP TOYS; YO YOS; MODELS, NAMELY, SCALE MODEL AIRPLANES; TOYS, NAMELY, BATTERY-POWERED COMPUTER GAMES WITH LCD SCREEN THAT FEATURES ANIMATION AND SOUND EFFECTS; PAPER PARTY HATS (U.S. CLS. 22, 23, 38 AND 50).

ELISSA GARBER KON, EXAMINING ATTORNEY

CLASS 28—(Continued).

SN 77-483,990. DUNLOP SLAZENGER GROUP LIMITED, BUCKINGHAMSHIRE, UNITED KINGDOM, FILED 5-27-2008.

HYBRIDGE

THE MARK CONSISTS OF STANDARD CHARACTERS WITHOUT CLAIM TO ANY PARTICULAR FONT, STYLE, SIZE, OR COLOR.

OWNER OF UNITED KINGDOM REG. NO. 2473395, DATED 5-30-2008, EXPIRES 11-27-2017.

FOR SPORTING ARTICLES AND APPARATUS, NAMELY, TENNIS RACKETS, TENNIS BALLS, SQUASH RACKETS, SQUASH BALLS, SPORTS BAGS IN THIS CLASS, NAMELY, BAGS SPECIFICALLY ADAPTED FOR SPORTS EQUIPMENT, TENNIS THERMO BAGS IN THE NATURE OF THERMAL TENNIS BAGS ADAPTED FOR USE WITH TENNIS SPORTING EQUIPMENT (U.S. CLS. 22, 23, 38 AND 50).

MAUREEN DALL, EXAMINING ATTORNEY

SN 77-489,439. LAX WRAPS, LLC, MITCHELLVILLE, MD. FILED 6-3-2008.



NO CLAIM IS MADE TO THE EXCLUSIVE RIGHT TO USE "LAX WRAPS", APART FROM THE MARK AS SHOWN.

THE MARK CONSISTS OF AN IMAGE OF A LACROSSE PLAYER BORDERED ABOVE BY THE TEXT, "LAX", AND BELOW BY THE TEXT, "WRAPS".

FOR ATHLETIC EQUIPMENT, NAMELY, WRAPS FOR THE SHAFT OF A LACROSSE STICK (U.S. CLS. 22, 23, 38 AND 50).

CAROL SPILS, EXAMINING ATTORNEY

CLASS 28—(Continued).

SN 77-492,660. SNAPTAIL LURES, L.L.C., TULSA, OK. FILED 6-6-2008.



NO CLAIM IS MADE TO THE EXCLUSIVE RIGHT TO USE "SNAP TAIL", APART FROM THE MARK AS SHOWN.

THE COLOR(S) RED, YELLOW, ORANGE, LIME GREEN, GREEN, DARK GREEN, CREAM, BLACK AND WHITE IS/ARE CLAIMED AS A FEATURE OF THE MARK.

THE MARK CONSISTS OF THE WORDS "SNAP" AND "TAIL" DEPICTED IN RED, STYLIZED FONT WITH A STYLIZED FISHING LURE IN BETWEEN THE WORDS "SNAP" AND "TAIL". THE FISHING LURE IS OUTLINED IN DARK GREEN WITH A LIME GREEN BODY AND HEAD AND CREAM SHADING AND A GREEN TAIL THAT HAS A YELLOW END. THE FISHING LURE'S FACE HAS EYES OUTLINED IN ORANGE AND FILLED IN WITH WHITE AND A MOUTH OUTLINED IN BLACK AND FILLED IN WITH WHITE.

FOR ARTIFICIAL FISHING LURES; FISHING LURES; LURES FOR FISHING; LURES FOR HUNTING OR FISHING (U.S. CLS. 22, 23, 38 AND 50).

FIRST USE 8-1-1995; IN COMMERCE 8-1-1995.
STEVEN JACKSON, EXAMINING ATTORNEY

SN 77-495,676. TITLE SPORTS, LLC, LENEXA, KS. FILED 6-10-2008.

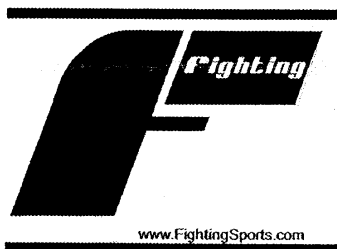

NO CLAIM IS MADE TO THE EXCLUSIVE RIGHT TO USE "FIGHTING" AND "WWW.FIGHTINGSPO RTS.COM", APART FROM THE MARK AS SHOWN.

THE MARK CONSISTS OF THE LETTER "F" CONTAINING THE WORD "FIGHTING" WITH THE WEBSITE ADDRESS ALL CONTAINED WITHIN SOLID BARS ABOVE AND BELOW.

FOR BOXING EQUIPMENT, NAMELY, BOXING GLOVES, TRAINING GLOVES; PUNCHING BAGS, BOXING BODY PROTECTORS, PUNCH MITTS; MIXED MARTIAL ARTS EQUIPMENT, NAMELY, TRAINING GLOVES, COMPETITION GLOVES, PUNCH MITTS, BODY PROTECTORS, AND STRIKING BAGS (U.S. CLS. 22, 23, 38 AND 50).

AMOS T. MATTHEWS, JR., EXAMINING ATTORNEY

CLASS 28—(Continued).

SN 77-521,780. TRIVIAL DEVELOPMENT CORPORATION, DBA TDC GAMES, INC., ITASCA, IL. FILED 7-14-2008.

MAKE YOUR OWN TEDDY BEAR

THE MARK CONSISTS OF STANDARD CHARACTERS WITHOUT CLAIM TO ANY PARTICULAR FONT, STYLE, SIZE, OR COLOR.

NO CLAIM IS MADE TO THE EXCLUSIVE RIGHT TO USE "TEDDY BEAR", APART FROM THE MARK AS SHOWN.

FOR INFANT DEVELOPMENT TOYS; INFLATABLE TOYS SHOWING DECORATIVE PICTURES; PLUSH TOYS; POSITIONABLE TOY FIGURES; SOFT SCULPTURE PLUSH TOYS; STUFFED AND PLUSH TOYS; STUFFED TOY ANIMALS; STUFFED TOY BEARS; STUFFED TOYS; TALKING TOYS; TOY ACTION FIGURES; TOY ANIMALS; TOY ANIMALS AND ACCESSORIES THEREFOR; TOY CONSTRUCTION SETS (U.S. CLS. 22, 23, 38 AND 50).

INGA ERVIN, EXAMINING ATTORNEY

SN 77-521,820. CHANDRIMA, LLC, SCOTTSDALE, AZ. FILED 7-14-2008.

CHANDRIMA

THE MARK CONSISTS OF STANDARD CHARACTERS WITHOUT CLAIM TO ANY PARTICULAR FONT, STYLE, SIZE, OR COLOR.

FOR YOGA MATS (U.S. CLS. 22, 23, 38 AND 50).
KATHERINE CHANG, EXAMINING ATTORNEY

SN 77-528,232. KUREHA CORPORATION, TOKYO, JAPAN, FILED 7-22-2008.



NO CLAIM IS MADE TO THE EXCLUSIVE RIGHT TO USE "ICE", APART FROM THE MARK AS SHOWN.

THE MARK CONSISTS OF THE STYLIZED WORDS "ABRAZX ICE", WITH THE WORD "ABRAZX" OVER THE WORD "ICE" AND A SWIRL DEVICE UNDER THE LETTER "X" IN THE WORD "ABRAZX".

FOR FISHING TACKLES; FISHING LINES (U.S. CLS. 22, 23, 38 AND 50).

TASNEEM HUSSAIN, EXAMINING ATTORNEY

CLASS 28—(Continued).

SN 77-530,698. RADIO FLYER, INC., CHICAGO, IL. FILED 7-24-2008.

STEER & STROLL COUPE

THE MARK CONSISTS OF STANDARD CHARACTERS WITHOUT CLAIM TO ANY PARTICULAR FONT, STYLE, SIZE, OR COLOR.

OWNER OF U.S. REG. NO. 2,738,494.
NO CLAIM IS MADE TO THE EXCLUSIVE RIGHT TO USE "COUPE", APART FROM THE MARK AS SHOWN.
FOR RIDE-ON TOYS (U.S. CLS. 22, 23, 38 AND 50).
JORDAN BAKER, EXAMINING ATTORNEY

SN 77-532,346. ROTH, JEFFREY, BOISE, ID. FILED 7-28-2008.

HOLLYWOOD CASTING CALL

THE MARK CONSISTS OF STANDARD CHARACTERS WITHOUT CLAIM TO ANY PARTICULAR FONT, STYLE, SIZE, OR COLOR.

FOR GAME EQUIPMENT SOLD AS A UNIT FOR PLAYING A MOVIE TITLE AND QUOTE GAME, NAMELY, PLAYING CARDS, MOVIE TITLE REFERENCE SHEETS, AND SCORECARDS (U.S. CLS. 22, 23, 38 AND 50).
MARGARET POWER, EXAMINING ATTORNEY

SN 77-534,593. BOLLINGER, RODNEY L., HARDIN, MT. FILED 7-30-2008.

Rod's Custom Rods

THE MARK CONSISTS OF STANDARD CHARACTERS WITHOUT CLAIM TO ANY PARTICULAR FONT, STYLE, SIZE, OR COLOR.

NO CLAIM IS MADE TO THE EXCLUSIVE RIGHT TO USE "CUSTOM RODS", APART FROM THE MARK AS SHOWN.
FOR FISHING RODS (U.S. CLS. 22, 23, 38 AND 50).
FIRST USE 5-1-2007; IN COMMERCE 5-1-2007.
LESLIE RICHARDS, EXAMINING ATTORNEY

CLASS 28—(Continued).

SN 77-541,081. HARPER, DANIEL F., SIGNAL MOUNTAIN, TN. FILED 8-7-2008.



THE COLOR(S) BLACK, RED, YELLOW, GREEN, BLUE AND WHITE IS/ARE CLAIMED AS A FEATURE OF THE MARK.

THE MARK CONSISTS OF THE TERM, "FREEKY FRIENDZ THE PERFECTLY IMPERFECT TOY", A BLACK OUTLINED RAINBOW WITH RED, YELLOW, GREEN AND BLUE STRIPES, TWO WHITE CLOUDS OUTLINED WITH BLACK AND HIGHLIGHTED WITH BLUE AT EACH END OF THE RAINBOW, TWO "F'S" MERGED TO CREATE A DOUBLE "F" IMAGE IN THE MIDDLE OF THE RAINBOW; A CHARMING FONT IS USED FOR "FREEKY FRIENDZ", ANAL NARROW BOLD FONT FOR THE, "IMPERFECT, TOY", AND QUIGGLY WIGGLY FONT FOR "PERFECTLY". THE WORDS "FREEKY FNIENDZ" APPEARS IN GREEN. THE TERMS "THE" AND "IMPERFECT TOY" APPEAR IN BLUE. THE WORD "PERFECTLY" APPEARS IN RED.

FOR STUFFED TOYS (U.S. CLS. 22, 23, 38 AND 50).
FIRST USE 3-24-2008; IN COMMERCE 9-12-2008.
CHRIS WELLS, EXAMINING ATTORNEY

SN 77-548,501. SHIRE PARTNERS INC., OAKLAND, CA. FILED 8-15-2008.



NO CLAIM IS MADE TO THE EXCLUSIVE RIGHT TO USE "PETS", APART FROM THE MARK AS SHOWN.
THE COLOR(S) RED AND WHITE IS/ARE CLAIMED AS A FEATURE OF THE MARK.

THE MARK CONSISTS OF THE WORDING "PAW PETS" IN RED, WITH WHITE AND RED OUTLINES, AND A DESIGN. THE DESIGN CONSISTS OF A RED RECTANGLE, WITH WHITE AND RED OUTLINES, AND A STYLIZED WHITE PAW PRINT IN THE CENTER OF THE RECTANGLE.

FOR PET TOYS (U.S. CLS. 22, 23, 38 AND 50).
CORY BOONE, EXAMINING ATTORNEY

CLASS 28—(Continued).

SN 77-552,333. THE GRIPBOARD COMPANY, LLC, SAN JUAN CAPISTRANO, CA. FILED 8-21-2008.

GRIPBOARD

THE MARK CONSISTS OF STANDARD CHARACTERS WITHOUT CLAIM TO ANY PARTICULAR FONT, STYLE, SIZE, OR COLOR.

FOR AQUATIC SPORTING GOODS, NAMELY, BODY BOARDS AND WAKE RIDING BOARDS (U.S. CLS. 22, 23, 38 AND 50).

FIRST USE 3-14-2008; IN COMMERCE 3-14-2008.
FRED CARL, EXAMINING ATTORNEY

SN 77-556,753. SOFT AIR USA, GRAPEVINE, TX. FILED 8-27-2008.

Second Chance BBs

THE MARK CONSISTS OF STANDARD CHARACTERS WITHOUT CLAIM TO ANY PARTICULAR FONT, STYLE, SIZE, OR COLOR.

NO CLAIM IS MADE TO THE EXCLUSIVE RIGHT TO USE "BBS", APART FROM THE MARK AS SHOWN.

FOR TOYS, NAMELY, PLASTIC BBS MADE OF RECYCLED MATERIALS (U.S. CLS. 22, 23, 38 AND 50).
RONALD MCMORROW, EXAMINING ATTORNEY

CLASS 28—(Continued).

SN 77-559,137. DOG TBH CORPORATION, LOS ANGELES, CA. FILED 8-29-2008.

RETRIBUTION

THE MARK CONSISTS OF STANDARD CHARACTERS WITHOUT CLAIM TO ANY PARTICULAR FONT, STYLE, SIZE, OR COLOR.

FOR TARGET GAMES, BOARD GAMES, CARD GAMES, AND PLAYING CARDS; KITES; TOY ACTION FIGURES, TOY FIGURES, NAMELY, MINIATURE ARTICULATED FIGURES, PINBALL MACHINES, BOBBING HEAD DOLLS, SNOWBOARDS, SURFBOARDS AND SNOW SLEDS USED FOR RECREATION; DISC TOSS TOYS; TOY BOWS AND ARROWS; FOOTBALLS AND BASEBALLS; DOLLS, DOLL PLAY SETS, PLUSH TOYS; TOY VEHICLES, TOY CARS, TOY TRUCKS, TOY BUCKET AND SHOVEL SETS, ROLLER SKATES, TOY MODEL HOBBYCRAFT KITS, TOY ROCKETS, TOY GUNS, TOY HOLSTERS, MUSICAL TOYS, JIGSAW PUZZLES, BADMINTON SETS, BUBBLE MAKING WANDS AND SOLUTION SETS, TOY BANKS, PUPPETS, TOY BALLOONS, SKATEBOARDS, TOY SCOOTERS, STAND ALONE VIDEO OUTPUT GAME MACHINES; LCD GAME MACHINES; HAND HELD UNIT FOR PLAYING ELECTRONIC GAMES; TOYS, NAMELY, BATTERY-POWERED COMPUTER GAMES WITH LCD SCREENS WHICH FEATURE ANIMATION AND SOUND EFFECTS; AND ELECTRONIC GAME APPARATUS HAVING ITS OWN DISPLAY, OTHER THAN FOR USE WITH TELEVISION RECEIVERS ONLY (U.S. CLS. 22, 23, 38 AND 50).

JERI J. FICKES, EXAMINING ATTORNEY

SN 77-559,506. RICH, ROBERT L., SANTA ANA, CA. FILED 8-29-2008.

Collector's Choice

THE MARK CONSISTS OF STANDARD CHARACTERS WITHOUT CLAIM TO ANY PARTICULAR FONT, STYLE, SIZE, OR COLOR.

NO CLAIM IS MADE TO THE EXCLUSIVE RIGHT TO USE "COLLECTOR'S", APART FROM THE MARK AS SHOWN.

FOR GAMES COMPRISING PUZZLES, CROSSWORD PUZZLES AND DOMINOES (U.S. CLS. 22, 23, 38 AND 50).

JAMES MACFARLANE, EXAMINING ATTORNEY

CLASS 28—(Continued).

SN 77-561,186. SICK STICKZ, L.L.C., LITTLETON, CO. FILED 9-3-2008.



THE MARK CONSISTS OF THE WORDS "SICKSTICKZ" WITH THE DESIGN OF A HAND-PRINT. FOR SKI POLES (U.S. CLS. 22, 23, 38 AND 50). FIRST USE 12-16-2007; IN COMMERCE 12-16-2007. DAVON HATCHETT, EXAMINING ATTORNEY

CLASS 28—(Continued).

SN 77-564,730. U.R., LLC, SAN LEANDRO, CA. FILED 9-8-2008.

Wallows

THE MARK CONSISTS OF STANDARD CHARACTERS WITHOUT CLAIM TO ANY PARTICULAR FONT, STYLE, SIZE, OR COLOR. FOR SKATEBOARDS; SURFBOARDS (U.S. CLS. 22, 23, 38 AND 50). ANDREA HACK, EXAMINING ATTORNEY

SN 77-563,919. GOMEZ, JOSE MIGUEL PEREZ, CARACAS, VENEZUELA, FILED 9-6-2008.

ULTIMATE PREDATOR

THE MARK CONSISTS OF STANDARD CHARACTERS WITHOUT CLAIM TO ANY PARTICULAR FONT, STYLE, SIZE, OR COLOR. FOR MANUALLY-OPERATED EXERCISE EQUIPMENT (U.S. CLS. 22, 23, 38 AND 50). JOHN DALIER, EXAMINING ATTORNEY

SN 77-564,738. U.R., LLC, SAN LEANDRO, CA. FILED 9-8-2008.

Keep Pushing

THE MARK CONSISTS OF STANDARD CHARACTERS WITHOUT CLAIM TO ANY PARTICULAR FONT, STYLE, SIZE, OR COLOR. FOR SKATEBOARDS; SURFBOARDS (U.S. CLS. 22, 23, 38 AND 50). ANDREA HACK, EXAMINING ATTORNEY

SN 77-564,197. FLORIDA HOME BUILDERS ASSOCIATION, TALLAHASSEE, FL. FILED 9-8-2008.

Buildopoly

THE MARK CONSISTS OF STANDARD CHARACTERS WITHOUT CLAIM TO ANY PARTICULAR FONT, STYLE, SIZE, OR COLOR. FOR EQUIPMENT SOLD AS A UNIT FOR PLAYING BOARD GAMES (U.S. CLS. 22, 23, 38 AND 50). JACQUELINE A. LAVINE, EXAMINING ATTORNEY

SN 77-565,115. EXILE SKIMBOARDS, LLC, SAN CLEMENTE, CA. FILED 9-8-2008.

EXILE

THE MARK CONSISTS OF STANDARD CHARACTERS WITHOUT CLAIM TO ANY PARTICULAR FONT, STYLE, SIZE, OR COLOR. FOR SKIM BOARDS (U.S. CLS. 22, 23, 38 AND 50). FIRST USE 7-31-2002; IN COMMERCE 12-31-2002. JANICE L. MCMORROW, EXAMINING ATTORNEY

CLASS 28—(Continued).

SN 77-565,176. MITCHELL, NATE, PLAYA DEL REY, CA.
FILED 9-8-2008.

SQUIBS

THE MARK CONSISTS OF STANDARD CHARACTERS WITHOUT CLAIM TO ANY PARTICULAR FONT, STYLE, SIZE, OR COLOR.

FOR ACTION FIGURES; FANTASY CHARACTER TOYS; MODELED PLASTIC TOY FIGURINES; MOLDED TOY FIGURES (U.S. CLS. 22, 23, 38 AND 50).
ZACHARY BELLO, EXAMINING ATTORNEY

SN 77-565,725. GLOVEMATE SPORTS, INC., TAMPA, FL.
FILED 9-9-2008.

STOP THE STING

THE MARK CONSISTS OF STANDARD CHARACTERS WITHOUT CLAIM TO ANY PARTICULAR FONT, STYLE, SIZE, OR COLOR.

FOR ATHLETIC PROTECTIVE PADS FOR BASEBALL AND SOFTBALL PLAYERS, WORN UNDER THE GLOVE AND OVER A PORTION OF THE PALM (U.S. CLS. 22, 23, 38 AND 50).

FIRST USE 2-10-2000; IN COMMERCE 2-10-2000.
ZACHARY BELLO, EXAMINING ATTORNEY

SN 77-565,908. IBET SYSTEMS, LTD., NEW YORK, NY.
FILED 9-9-2008.

DIVA SHUN

THE MARK CONSISTS OF STANDARD CHARACTERS WITHOUT CLAIM TO ANY PARTICULAR FONT, STYLE, SIZE, OR COLOR.

FOR EDUCATIONAL TOYS WHICH TEACH MATHEMATICS; BOARD GAMES; PUPPETS; BINGO GAME PLAYING EQUIPMENT (U.S. CLS. 22, 23, 38 AND 50).

JENNY PARK, EXAMINING ATTORNEY

CLASS 28—(Continued).

SN 77-566,026. BERGER, FREDERICK, SLIDELL, LA. FILED 9-9-2008.

TURBO

THE MARK CONSISTS OF STANDARD CHARACTERS WITHOUT CLAIM TO ANY PARTICULAR FONT, STYLE, SIZE, OR COLOR.

FOR PLAYING CARDS (U.S. CLS. 22, 23, 38 AND 50).
SALLY SHIH, EXAMINING ATTORNEY

SN 77-566,044. BERGER, FEDERICK, SLIDELL, LA. FILED 9-9-2008.



THE COLOR(S) RED, WHITE, AND BLUE IS/ARE CLAIMED AS A FEATURE OF THE MARK.

THE COLORS BLUE AND WHITE APPEAR IN THE DESIGN OF A SPADE AND IN THE CHECKERED FLAG IN THE CENTER OF THE SPADE. THE COLOR RED APPEARS IN THE WORD "TURBO".

FOR PLAYING CARDS (U.S. CLS. 22, 23, 38 AND 50).
EVELYN BRADLEY, EXAMINING ATTORNEY

SN 77-566,626. SCURLOCK, FRANK M., KENNER, LA.
FILED 9-10-2008.

SPACE WALK

THE MARK CONSISTS OF STANDARD CHARACTERS WITHOUT CLAIM TO ANY PARTICULAR FONT, STYLE, SIZE, OR COLOR.

FOR LARGE AIR INFLATED BOUNCING AND JUMPING AMUSEMENT DEVICES (U.S. CLS. 22, 23, 38 AND 50).

FIRST USE 5-1-1966; IN COMMERCE 5-1-1966.
CHRISIE B. KING, EXAMINING ATTORNEY

CLASS 28—(Continued).

SN 77-566,959. BAUM, INC., HARVEY CEDARS, NJ. FILED 9-10-2008.

KBITZ

THE MARK CONSISTS OF STANDARD CHARACTERS WITHOUT CLAIM TO ANY PARTICULAR FONT, STYLE, SIZE, OR COLOR.

FOR STACKING BLOCK GAME (U.S. CLS. 22, 23, 38 AND 50).
CARRIE GENOVESE, EXAMINING ATTORNEY

SN 77-567,168. YANAGITA, ROGER, LOS ANGELES, CA. FILED 9-10-2008.

PLAY 5

THE MARK CONSISTS OF STANDARD CHARACTERS WITHOUT CLAIM TO ANY PARTICULAR FONT, STYLE, SIZE, OR COLOR.

FOR BOARD GAMES (U.S. CLS. 22, 23, 38 AND 50).
MICHAEL KEATING, EXAMINING ATTORNEY

SN 77-567,273. VALLEJO, CARL J., RONKONKOMA, NY. FILED 9-10-2008.



THE MARK CONSISTS OF THE WORD "SMINKY" WITH AN OUTER LINE AROUND THE PERIPHERY OF THE WORD; A HEAD OF TEDDY BEAR IS THE DOT OF THE LETTER "I" IN THE WORD; AN ARCuate SHAPE APPROXIMATING A SEMI-CIRCLE EXTENDS BETWEEN THE "S" AND THE "K" OF THE WORD "SMINKY" AND AROUND THE HEAD OF THE BEAR; A DIAPER EXTENDS BELOW THE WORD AND THE ENDS OF THE DIAPER ARE DRAPED AROUND THE "S" AND THE "Y" OF "SMINKY"; AND A DIAPER PIN IS USED TO CONNECT THE DRAPED PORTIONS AROUND THE "S" AND "Y".

FOR TOY AND NOVELTY FACE MASKS (U.S. CLS. 22, 23, 38 AND 50).
TASNEEM HUSSAIN, EXAMINING ATTORNEY

CLASS 28—(Continued).

SN 77-567,358. ALTARATIONS, LLC, BLOWING ROCK, NC. FILED 9-11-2008.

GRAB HER HAND. OPEN YOUR HEART.

THE MARK CONSISTS OF STANDARD CHARACTERS WITHOUT CLAIM TO ANY PARTICULAR FONT, STYLE, SIZE, OR COLOR.

FOR DOLLS (U.S. CLS. 22, 23, 38 AND 50).
SANJEEV VOHRA, EXAMINING ATTORNEY

SN 77-567,432. ORTLOFF, BRANDON, SANTA ANA, CA. FILED 9-11-2008.

Black Surf

THE MARK CONSISTS OF STANDARD CHARACTERS WITHOUT CLAIM TO ANY PARTICULAR FONT, STYLE, SIZE, OR COLOR.

FOR SURFBOARDS (U.S. CLS. 22, 23, 38 AND 50).
JOHN WILKE, EXAMINING ATTORNEY

SN 77-567,603. BAKER, VAL DOUGLAS, HIGHLAND, UT. FILED 9-11-2008.

IT TAKES BALLS TO GOLF

THE MARK CONSISTS OF STANDARD CHARACTERS WITHOUT CLAIM TO ANY PARTICULAR FONT, STYLE, SIZE, OR COLOR.

FOR GOLF ACCESSORY POUCHES (U.S. CLS. 22, 23, 38 AND 50).
LINDA E. BLOHM, EXAMINING ATTORNEY

SN 77-568,073. DW SPORTS GROUP LLC, DBA DIXON GOLF, MESA, AZ. FILED 9-11-2008.

EARTH

THE MARK CONSISTS OF THE WORD "EARTH" IN CAPS.

FOR GOLF BALLS (U.S. CLS. 22, 23, 38 AND 50).
FIRST USE 8-1-2007; IN COMMERCE 1-1-2008.
ANDREA SAUNDERS, EXAMINING ATTORNEY

CLASS 28—(Continued).

SN 77-568,183. INTROTECH GROUP, INC., SAN DIEGO, CA. FILED 9-11-2008.

ECOTRONIC

THE MARK CONSISTS OF STANDARD CHARACTERS WITHOUT CLAIM TO ANY PARTICULAR FONT, STYLE, SIZE, OR COLOR.

FOR ELECTRIC EDUCATIONAL TOY USED TO DEMONSTRATE ALTERNATIVE ENERGY SOURCES (U.S. CLS. 22, 23, 38 AND 50).

RENEE MCCRAY, EXAMINING ATTORNEY

CLASS 28—(Continued).

SN 77-572,317. DART INDUSTRIES INC., ORLANDO, FL. FILED 9-17-2008.

MINI SERVE-IT

THE MARK CONSISTS OF STANDARD CHARACTERS WITHOUT CLAIM TO ANY PARTICULAR FONT, STYLE, SIZE, OR COLOR.

NO CLAIM IS MADE TO THE EXCLUSIVE RIGHT TO USE "MINI", APART FROM THE MARK AS SHOWN.

FOR TOYS FOR CHILDREN, NAMELY, TOY DISHES (U.S. CLS. 22, 23, 38 AND 50).

FIRST USE 9-1-2007; IN COMMERCE 9-1-2007.

MARK PILARO, EXAMINING ATTORNEY

SN 77-568,241. NEW POKER, L.L.C., LAS VEGAS, NV. FILED 9-11-2008.

FANTAZEE

THE MARK CONSISTS OF STANDARD CHARACTERS WITHOUT CLAIM TO ANY PARTICULAR FONT, STYLE, SIZE, OR COLOR.

FOR DICE GAMES (U.S. CLS. 22, 23, 38 AND 50).

ARETHA SOMERVILLE, EXAMINING ATTORNEY

SN 77-574,643. GOLF GALAXY GOLFWORKS, INC., NEWARK, OH. FILED 9-19-2008.



THE MARK CONSISTS OF THE WORDING "TRICEPT" IN BETWEEN A DESIGN OF THREE TRIANGLES.

FOR GOLF CLUB HEADS, GOLF CLUB SHAFTS, GOLF CLUB HEAD COVERS, CUSTOMIZED GOLF CLUBS, GOLF CLUBS (U.S. CLS. 22, 23, 38 AND 50).

TRACY WHITTAKER-BROWN, EXAMINING ATTORNEY

SN 77-571,494. THE KYJEN COMPANY, INC., HUNTINGTON BEACH, CA. FILED 9-16-2008.

BUILD-A-BUDDY

THE MARK CONSISTS OF STANDARD CHARACTERS WITHOUT CLAIM TO ANY PARTICULAR FONT, STYLE, SIZE, OR COLOR.

FOR PET TOYS (U.S. CLS. 22, 23, 38 AND 50).

FIRST USE 6-1-2006; IN COMMERCE 4-23-2007.

JESSICA A. POWERS, EXAMINING ATTORNEY

SN 77-574,657. GOLF GALAXY GOLFWORKS, INC., NEWARK, OH. FILED 9-19-2008.

TRICEPT

THE MARK CONSISTS OF STANDARD CHARACTERS WITHOUT CLAIM TO ANY PARTICULAR FONT, STYLE, SIZE, OR COLOR.

FOR GOLF CLUB HEADS, GOLF CLUB SHAFTS, GOLF CLUB HEAD COVERS, CUSTOMIZED GOLF CLUBS, GOLF CLUBS (U.S. CLS. 22, 23, 38 AND 50).

TRACY WHITTAKER-BROWN, EXAMINING ATTORNEY

CLASS 28—(Continued).

SN 77-576,024. DISCOVERY BAY GAMES LLC, PORT TOWNSEND, WA. FILED 9-22-2008.

GARAGE BAND - THE GAME

THE MARK CONSISTS OF STANDARD CHARACTERS WITHOUT CLAIM TO ANY PARTICULAR FONT, STYLE, SIZE, OR COLOR.

NO CLAIM IS MADE TO THE EXCLUSIVE RIGHT TO USE "GAME", APART FROM THE MARK AS SHOWN. FOR BOARD GAMES (U.S. CLS. 22, 23, 38 AND 50). MICHAEL WEBSTER, EXAMINING ATTORNEY

SN 77-586,211. WICKFORD EQUITIES, LLC, MINDEN, NV. FILED 10-6-2008.

Elfive

THE MARK CONSISTS OF STANDARD CHARACTERS WITHOUT CLAIM TO ANY PARTICULAR FONT, STYLE, SIZE, OR COLOR.

FOR ACTION FIGURES; ACTION FIGURES AND ACCESSORIES THEREFOR; ACTION SKILL GAMES; ACTION TARGET GAMES; ACTION-TYPE TARGET GAMES; AMUSEMENT GAME MACHINES; BABY MULTIPLE ACTIVITY TOYS; BATH TOYS; BATHTUB TOYS; BATTERY OPERATED ACTION TOYS; BEAN BAG DOLLS; BENDABLE TOYS; BOARD GAMES; BOBBLE HEAD DOLLS; BOBBLEHEAD DOLLS; CASES FOR ACTION FIGURES; CASES FOR TOY STRUCTURES; CASES FOR TOY VEHICLES; CAT TOYS; CHILDREN'S MULTIPLE ACTIVITY TABLES; CHILDREN'S MULTIPLE ACTIVITY TOYS; CHILDREN'S MULTIPLE ACTIVITY TOYS SOLD AS A UNIT WITH PRINTED BOOKS; CHILDREN'S WIRE CONSTRUCTION AND ART ACTIVITY TOYS; CHRISTMAS DOLLS; COLLECTABLE TOY FIGURES; CRIB TOYS; DISC TOSS TOYS; DOG TOYS; DOLL ACCESSORIES; DOLL CASES; DOLL CLOTHING; DOLL COSTUMES; DOLL FURNITURE; DOLL HOUSE FURNISHINGS; DOLL HOUSES; DOLLS; DOLLS AND ACCESSORIES THEREFOR; DOLLS AND DOLLS' CLOTHING; DOLLS AND PLAYSETS THEREFOR; DOLLS FOR CHRISTMAS; DOLLS FOR PLAYING; DOLLS' CLOTHES; DOLLS' HOUSES; DOLLS' ROOMS; DRAWING TOYS; EDUCATIONAL CARD GAMES; EDUCATIONAL TOY FOR THE PURPOSE OF THE DEMONSTRATION OF ALTERNATIVE ENERGY SOURCES; EDUCATIONAL TOYS FOR TEACHING MATH PRINCIPLES TO CHILDREN, NAMELY, MANIPULATIVE BLOCKS FOR DISPLAYING PATTERNS AND GROUPINGS; ELECTRIC ACTION TOYS; ELECTRIC EDUCATIONAL TOY USED TO DEMONSTRATE ALTERNATIVE ENERGY SOURCES; ELECTRONIC ACTION TOYS; ELECTRONIC EDUCATIONAL GAME MACHINES FOR CHILDREN; ELECTRONIC LEARNING TOYS; ELECTRONIC TOY BUILDING BLOCKS THAT LIGHT UP AS A NIGHT LIGHT; ELECTRONIC TOY VEHICLES; FANTASY CHARACTER TOYS; FLYING DISCS; FLYING SAUCERS; FLYING TOYS USING ELECTROSTATIC LEVITATION; FURNITURE FOR DOLL'S HOUSES; FURNITURE FOR DOLLS' HOUSES; HAND-POWERED NON-MECHANICAL FLYING TOY; INFANT ACTION CRIB TOYS; INFANT DEVELOPMENT TOYS; INFANT SWINGS; INFANT TOYS; INFANT'S RATTLES; INFLATABLE BATH TOYS; INFLATABLE RIDE-ON TOYS; INFLATABLE THIN RUBBER TOYS; INFLATABLE TOYS; INFLATABLE TOYS SHOWING

CLASS 28—(Continued).

DECORATIVE PICTURES; LEVER ACTION TOYS; MECHANICAL ACTION TOYS; MECHANICAL TOYS; MOBILES FOR CHILDREN; MODELED PLASTIC TOY FIGURINES; MOLDED TOY FIGURES; MUSIC BOX TOYS; MUSICAL TOYS; NON-ELECTRONIC TOY VEHICLES; NON-RIDING TRANSPORTATION TOYS; PAPER DOLLS; PARLOR GAMES; PARTY FAVORS IN THE NATURE OF CRACKERS AND NOISEMAKERS; PARTY FAVORS IN THE NATURE OF SMALL TOYS; PARTY GAMES; PET TOYS; PET TOYS CONTAINING CATNIP; PLASTIC CHARACTER TOYS; PLAY FIGURES; PLAY HOUSES; PLAY MATS CONTAINING INFANT TOYS; PLAY MATS FOR USE WITH TOY VEHICLES; PLAYING CARD SHUFFLING MACHINES; PLAYING CARDS; PLAYING CARDS AND CARD GAMES; PLUSH DOLLS; PLUSH DOLLS CREATED FROM CHILDREN'S DRAWINGS; PLUSH TOYS; POP UP TOYS; PORCELAIN DOLLS; POSITIONABLE PRINTED TOY FIGURES FOR USE IN GAMES; POSITIONABLE PRINTED TOY FIGURES FOR USE IN PUZZLES; POSITIONABLE THREE DIMENSIONAL TOYS FOR USE IN GAMES; POSITIONABLE TOY FIGURES; POSITIONABLE TWO DIMENSIONAL TOYS FOR USE IN GAMES; POSITIONABLE WOODEN AND PLASTIC FIGURES FOR USE IN WOODEN AND PLASTIC PUZZLES; PRINTED POSITIONABLE TOYS FOR USE IN CHILDREN'S BOARD GAMES; PRINTING TOYS; PULL TOYS; PUSH TOYS; RAG DOLLS; REMOTE CONTROL TOYS, NAMELY, CARS, VEHICLES AND SLEIGHS; RIDE-ON TOYS; RUBBER ACTION BALLS; RUBBER CHARACTER TOYS; SAND TOYS; SHOES FOR DOLLS; SKETCHING TOYS; SOFT SCULPTURE DOLLS; SOFT SCULPTURE PLUSH TOYS; SOFT SCULPTURE TOYS; SQUEEZABLE SQUEAKING TOYS; SQUEEZE TOYS; STACKING TOYS; STUFFED AND PLUSH TOYS; STUFFED DOLLS AND ANIMALS; STUFFED PUPPETS; STUFFED TOY ANIMALS; STUFFED TOY BEARS; STUFFED TOYS; TALKING ELECTRONIC PRESS-DOWN TOY; TALKING TOYS; TOSSING DISC TOYS; TOY ACTION FIGURES; TOY ACTION FIGURES AND ACCESSORIES THEREFOR; TOY ANIMALS; TOY ANIMALS AND ACCESSORIES THEREFOR; TOY BUTTERFLY NETS; TOY CARS; TOY CLOCKS AND WATCHES; TOY FIGURES; TOY FURNITURE; TOY MOBILES; TOY MODEL HOBBYCRAFT KITS; TOY MODEL KIT CARS; TOY MODEL VEHICLES AND RELATED ACCESSORIES SOLD AS UNITS; TOY MUSIC BOXES; TOY VEHICLE TRACK SETS AND ROADWAYS AND ACCESSORIES THEREFOR; TOY WHISTLES; TOY, NAMELY, BATTERY-POWERED COMPUTER GAME WITH LCD SCREEN WHICH FEATURES ANIMATION AND SOUND EFFECTS; TOYS, NAMELY, A DISK TO TOSS IN PLAYING A GAME WHEREIN OTHER DISKS ARE FLIPPED AND COLLECTED; TWO AND THREE DIMENSIONAL POSITIONABLE FIGURES SOLD AS AN INTEGRAL COMPONENT OF TOYS; TWO AND THREE DIMENSIONAL POSITIONABLE TOY FIGURES SOLD AS A UNIT WITH EDUCATIONAL BOOKS; TWO AND THREE DIMENSIONAL POSITIONABLE TOY FIGURES SOLD AS A UNIT WITH MEMORY TRAINING EQUIPMENT (U.S. CLS. 22, 23, 38 AND 50).

LOURDES AYALA, EXAMINING ATTORNEY

CLASS 28—(Continued).

SN 77-586,431. WICKFORD EQUITIES, LLC, MINDEN, NV.
FILED 10-6-2008.

Elfong

THE MARK CONSISTS OF STANDARD CHARACTERS WITHOUT CLAIM TO ANY PARTICULAR FONT, STYLE, SIZE, OR COLOR.

FOR ACTION FIGURES; ACTION FIGURES AND ACCESSORIES THEREFOR; ACTION SKILL GAMES; ACTION TARGET GAMES; ACTION-TYPE TARGET GAMES; BABY MULTIPLE ACTIVITY TOYS; BATH TOYS; BATHTUB TOYS; BATTERY OPERATED ACTION TOYS; BENDABLE TOYS; BOARD GAMES; CASES FOR ACTION FIGURES; CASES FOR PLAY ACCESSORIES; CASES FOR TOY STRUCTURES; CASES FOR TOY VEHICLES; CAT TOYS; CHILDREN'S ACTIVITY TABLES CONTAINING MANIPULATIVE TOYS WHICH CONVERT TO EASELS; CHILDREN'S MULTIPLE ACTIVITY TABLES; CHILDREN'S MULTIPLE ACTIVITY TOYS; CHILDREN'S MULTIPLE ACTIVITY TOYS SOLD AS A UNIT WITH PRINTED BOOKS; CHILDREN'S WIRE CONSTRUCTION AND ART ACTIVITY TOYS; CHRISTMAS DOLLS; COLLECTABLE TOY FIGURES; CRIB TOYS; DISC TOSS TOYS; DOG TOYS; DOLL ACCESSORIES; DOLL CASES; DOLL CLOTHING; DOLL COSTUMES; DOLL FURNITURE; DOLL HOUSE FURNISHINGS; DOLL HOUSES; DOLLS; DOLLS AND ACCESSORIES THEREFOR; DOLLS FOR CHRISTMAS; DOLLS FOR PLAYING; DOLLS' CLOTHES; DOLLS' HOUSES; DOLLS' ROOMS; DRAWING TOYS; EDUCATIONAL CARD GAMES; EDUCATIONAL TOY FOR THE PURPOSE OF THE DEMONSTRATION OF ALTERNATIVE ENERGY SOURCES; EDUCATIONAL TOYS FOR TEACHING MATH PRINCIPLES TO CHILDREN, NAMELY, MANIPULATIVE BLOCKS FOR DISPLAYING PATTERNS AND GROUPINGS; ELECTRIC ACTION TOYS; ELECTRIC EDUCATIONAL TOY USED TO DEMONSTRATE ALTERNATIVE ENERGY SOURCES; ELECTRONIC ACTION TOYS; ELECTRONIC EDUCATIONAL GAME MACHINES FOR CHILDREN; ELECTRONIC TOY VEHICLES; ELECTRONICALLY OPERATED TOY MOTOR VEHICLES; FANTASY CHARACTER TOYS; FLYING DISCS; FLYING SAUCERS; FLYING TOYS USING ELECTROSTATIC LEVITATION; FURNITURE FOR DOLL'S HOUSES; FURNITURE FOR DOLLS' HOUSES; HAND-POWERED NON-MECHANICAL FLYING TOY; INFANT ACTION CRIB TOYS; INFANT DEVELOPMENT TOYS; INFANT SWINGS; INFANT TOYS; INFANT'S RATTLES; INFLATABLE BATH TOYS; INFLATABLE RIDE-ON TOYS; INFLATABLE THIN RUBBER TOYS; INFLATABLE TOYS; INFLATABLE TOYS SHOWING DECORATIVE PICTURES; LEVER ACTION TOYS; MECHANICAL ACTION TOYS; MECHANICAL TOYS; MOBILES FOR CHILDREN; MOLDDED PLASTIC TOY FIGURINES; MOLDED TOY FIGURES; MUSIC BOX TOYS; MUSICAL TOYS; NON-ELECTRONIC TOY VEHICLES; NON-RIDING TRANSPORTATION TOYS; PAPER DOLLS; PARLOR GAMES; PARTY FAVORS IN THE NATURE OF SMALL TOYS; PARTY GAMES; PET TOYS; PET TOYS CONTAINING CATNIP; PLASTIC CHARACTER TOYS; PLAY FIGURES; PLAY HOUSES; PLAY MATS CONTAINING INFANT TOYS; PLAY MATS FOR USE WITH TOY VEHICLES; PLAYING CARD SHUFFLING MACHINES; PLAYING CARDS; PLUSH DOLLS; PLUSH DOLLS CREATED FROM CHILDREN'S DRAWINGS; PLUSH TOYS; POP UP TOYS; PORCELAIN DOLLS; POSITIONABLE PRINTED TOY FIGURES FOR USE IN GAMES; POSITIONABLE PRINTED TOY FIGURES FOR USE IN PUZZLES; POSITIONABLE THREE DIMENSIONAL TOYS FOR USE IN GAMES; POSITIONABLE TOY FIGURES; POSITIONABLE TWO DIMENSIONAL TOYS FOR USE IN GAMES; PRINTED POSITIONABLE TOYS FOR USE IN CHILDREN'S BOARD GAMES; PRINTING TOYS; PULL TOYS; PUSH TOYS; RADIO CONTROLLED TOY VEHICLES; RAG DOLLS; REMOTE CONTROL TOYS, NAMELY, CARS, VEHICLES AND SLEIGHS; RIDE-ON TOYS; RUBBER CHARACTER TOYS; SAND

CLASS 28—(Continued).

TOYS; SHOES FOR DOLLS; SKETCHING TOYS; SOFT SCULPTURE DOLLS; SOFT SCULPTURE PLUSH TOYS; SOFT SCULPTURE TOYS; SQUEEZABLE SQUEAKING TOYS; SQUEEZE TOYS; STACKING TOYS; STUFFED AND PLUSH TOYS; STUFFED DOLLS AND ANIMALS; STUFFED PUPPETS; STUFFED TOY ANIMALS; STUFFED TOY BEARS; STUFFED TOYS; TALKING ELECTRONIC PRESS-DOWN TOY; TALKING TOYS; TOY ACTION FIGURES; TOY ACTION FIGURES AND ACCESSORIES THEREFOR; TOY ANIMALS; TOY ANIMALS AND ACCESSORIES THEREFOR; TOY BUTTERFLY NETS; TOY CARS; TOY CLOCKS AND WATCHES; TOY FIGURES; TOY FURNITURE; TOY MOBILES; TOY MODEL HOBBYCRAFT KITS; TOY MODEL KIT CARS; TOY MODEL TRAIN SETS; TOY MODEL VEHICLES AND RELATED ACCESSORIES SOLD AS UNITS; TOY MUSIC BOXES; TOY VEHICLES; TOY WHISTLES; TOY, NAMELY, BATTERY-POWERED COMPUTER GAME WITH LCD SCREEN WHICH FEATURES ANIMATION AND SOUND EFFECTS; TOYS, NAMELY, A DISK TO TOSS IN PLAYING A GAME WHEREIN OTHER DISKS ARE FLIPPED AND COLLECTED; TWO AND THREE DIMENSIONAL POSITIONABLE FIGURES SOLD AS AN INTEGRAL COMPONENT OF TOYS; TWO AND THREE DIMENSIONAL POSITIONABLE TOY FIGURES SOLD AS A UNIT WITH EDUCATIONAL BOOKS; TWO AND THREE DIMENSIONAL POSITIONABLE TOY FIGURES SOLD AS A UNIT WITH MEMORY TRAINING EQUIPMENT (U.S. CLS. 22, 23, 38 AND 50).

LOURDES AYALA, EXAMINING ATTORNEY

SN 77-586,974. MCPHERSON, MATHEW A., NORWALK, WI.
FILED 10-7-2008.

DAMPLIFIER

THE MARK CONSISTS OF STANDARD CHARACTERS WITHOUT CLAIM TO ANY PARTICULAR FONT, STYLE, SIZE, OR COLOR.

FOR ARCHERY EQUIPMENT, NAMELY, A BOW STRING SUPPRESSOR (U.S. CLS. 22, 23, 38 AND 50).
LAURIE KAUFMAN, EXAMINING ATTORNEY

SN 77-593,470. WICKFORD EQUITIES, LLC, MINDEN, NV.
FILED 10-15-2008.

Elfred

THE MARK CONSISTS OF STANDARD CHARACTERS WITHOUT CLAIM TO ANY PARTICULAR FONT, STYLE, SIZE, OR COLOR.

FOR ACTION FIGURES; ACTION FIGURES AND ACCESSORIES THEREFOR; ACTION SKILL GAMES; ACTION TARGET GAMES; ACTION-TYPE TARGET GAMES; AMUSEMENT GAME MACHINES; BABY MULTIPLE ACTIVITY TOYS; BATH TOYS; BATHTUB TOYS; BATTERY OPERATED ACTION TOYS; BENDABLE TOYS; BOARD GAMES; CARD GAMES; CASES FOR ACTION FIGURES; CASES FOR TOY STRUCTURES; CASES FOR TOY VEHICLES; CAT TOYS; CHILDREN'S MULTIPLE ACTIVITY TABLES; CHILDREN'S MULTIPLE ACTIVITY TOYS; CHILDREN'S MULTIPLE ACTIVITY TOYS SOLD AS A UNIT WITH PRINTED BOOKS; CHILDREN'S WIRE CONSTRUCTION AND ART ACTIV-

CLASS 28—(Continued).

ITY TOYS; CHRISTMAS DOLLS; COLLECTABLE TOY FIGURES; CRIB TOYS; DISC TOSS TOYS; DOG TOYS; DOLL ACCESSORIES; DOLL CASES; DOLL CLOTHING; DOLL COSTUMES; DOLL FURNITURE; DOLL HOUSE FURNISHINGS; DOLL HOUSES; DOLLS; DOLLS AND ACCESSORIES THEREFOR; DOLLS AND DOLLS' CLOTHING; DOLLS AND PLAYSETS THEREFOR; DOLLS FOR CHRISTMAS; DOLLS FOR PLAYING; DOLLS' CLOTHES; DOLLS' HOUSES; DOLLS' ROOMS; DRAWING TOYS; EDUCATIONAL CARD GAMES; EDUCATIONAL TOY FOR THE PURPOSE OF THE DEMONSTRATION OF ALTERNATIVE ENERGY SOURCES; EDUCATIONAL TOYS FOR TEACHING MATH PRINCIPLES TO CHILDREN, NAMELY, MANIPULATIVE BLOCKS FOR DISPLAYING PATTERNS AND GROUPINGS; ELECTRIC ACTION TOYS; ELECTRONIC ACTION TOYS; ELECTRONIC LEARNING TOYS; ELECTRONIC TOY BUILDING BLOCKS THAT LIGHT UP AS A NIGHT LIGHT; ELECTRONIC TOY VEHICLES; FANTASY CHARACTER TOYS; FLYING DISCS; FLYING SAUCERS; FLYING TOYS USING ELECTROSTATIC LEVITATION; FURNITURE FOR DOLL'S HOUSES; FURNITURE FOR DOLLS' HOUSES; HAND-POWERED NON-MECHANICAL FLYING TOY; INFANT ACTION CRIB TOYS; INFANT DEVELOPMENT TOYS; INFANT TOYS; INFLATABLE BATH TOYS; INFLATABLE RIDE-ON TOYS; INFLATABLE THIN RUBBER TOYS; INFLATABLE TOYS; INFLATABLE TOYS SHOWING DECORATIVE PICTURES; LEVER ACTION TOYS; MECHANICAL ACTION TOYS; MECHANICAL TOYS; MOBILES FOR CHILDREN; MOLDED TOY FIGURES; MUSIC BOX TOYS; MUSICAL TOYS; NON-ELECTRONIC TOY VEHICLES; NON-RIDING TRANSPORTATION TOYS; PAPER DOLLS; PARLOUR GAMES; PARTY FAVORS IN THE NATURE OF SMALL TOYS; PARTY GAMES; PET TOYS; PET TOYS CONTAINING CATNIP; PLASTIC CHARACTER TOYS; PLAY FIGURES; PLAY MATS CONTAINING INFANT TOYS; PLAY MATS FOR USE WITH TOY VEHICLES; PLAYING CARD SHUFFLING DEVICE; PLAYING CARD SHUFFLING MACHINES; PLAYING CARDS; PLAYING CARDS AND CARD GAMES; PLUSH DOLLS; PLUSH DOLLS CREATED FROM CHILDREN'S DRAWINGS; PLUSH TOYS; POP UP TOYS; PORCELAIN DOLLS; POSITIONABLE PRINTED TOY FIGURES FOR USE IN GAMES; POSITIONABLE PRINTED TOY FIGURES FOR USE IN PUZZLES; POSITIONABLE THREE DIMENSIONAL TOYS FOR USE IN GAMES; POSITIONABLE TOY FIGURES; POSITIONABLE TWO DIMENSIONAL TOYS FOR USE IN GAMES; POSITIONABLE WOODEN AND PLASTIC FIGURES FOR USE IN WOODEN AND PLASTIC PUZZLES; PRINTED POSITIONABLE TOYS FOR USE IN CHILDREN'S BOARD GAMES; PRINTING TOYS; PULL TOYS; PUSH TOYS; RADIO CONTROLLED TOY VEHICLES; RAG DOLLS; REMOTE CONTROL TOYS, NAMELY, CARS, VEHICLES AND SLEIGHS; RIDE-ON TOYS; RUBBER CHARACTER TOYS; SAND TOYS; SHOES FOR DOLLS; SKETCHING TOYS; SOFT SCULPTURE DOLLS; SOFT SCULPTURE TOYS; SQUEEZABLE SQUEAKING TOYS; SQUEEZE TOYS; STACKING TOYS; STUFFED AND PLUSH TOYS; STUFFED DOLLS AND ANIMALS; STUFFED PUPPETS; STUFFED TOY ANIMALS; STUFFED TOY BEARS; STUFFED TOYS; TALKING ELECTRONIC PRESS-DOWN TOY; TALKING TOYS; TOY ACTION FIGURES; TOY ACTION FIGURES AND ACCESSORIES THEREFOR; TOY ANIMALS; TOY BUTTERFLY NETS; TOY CLOCKS AND WATCHES; TOY FIGURES; TOY FURNITURE; TOY MOBILES; TOY MODEL HOBBYCRAFT KITS; TOY MODEL KIT CARS; TOY MODEL TRAIN SETS; TOY MODEL VEHICLES AND RELATED ACCESSORIES SOLD AS UNITS; TOY MUSIC BOXES; TOY PUTTY; TOY VEHICLES; TOY WATCHES; TOY WHISTLES; TOY, NAMELY, BATTERY-POWERED COMPUTER GAME WITH LCD SCREEN WHICH FEATURES ANIMATION AND SOUND EFFECTS; TOYS, NAMELY, A DISK TO TOSS IN PLAYING A GAME WHEREIN OTHER DISKS ARE FLIPPED AND COLLECTED; TOYS, NAMELY, CHILDREN'S DRESS-UP ACCESSORIES;

CLASS 28—(Continued).

TWO AND THREE DIMENSIONAL POSITIONABLE FIGURES SOLD AS AN INTEGRAL COMPONENT OF TOYS; TWO AND THREE DIMENSIONAL POSITIONABLE GAME FIGURES THAT MAY BE AFFIXED TO CLOTHING; TWO AND THREE DIMENSIONAL POSITIONABLE TOY FIGURES SOLD AS A UNIT WITH EDUCATIONAL BOOKS; TWO AND THREE DIMENSIONAL POSITIONABLE TOY FIGURES SOLD AS A UNIT WITH MEMORY TRAINING EQUIPMENT.; TWO AND THREE DIMENSIONAL POSITIONABLE TOY FIGURES SOLD AS A UNIT WITH OTHER TOYS (U.S. CLS. 22, 23, 38 AND 50).

LOURDES AYALA, EXAMINING ATTORNEY

SN 77-593,514. WICKFORD EQUITIES, LLC, MINDEN, NV.
FILED 10-15-2008.

Elfonzo

THE MARK CONSISTS OF STANDARD CHARACTERS WITHOUT CLAIM TO ANY PARTICULAR FONT, STYLE, SIZE, OR COLOR.

FOR ACTION FIGURES; ACTION FIGURES AND ACCESSORIES THEREFOR; ACTION SKILL GAMES; ACTION TARGET GAMES; ACTION-TYPE TARGET GAMES; AMUSEMENT GAME MACHINES; BABY MULTIPLE ACTIVITY TOYS; BATH TOYS; BATHTUB TOYS; BATTERY OPERATED ACTION TOYS; BEAN BAG DOLLS; BENDABLE TOYS; BOARD GAMES; BOBBLE HEAD DOLLS; CASES FOR ACTION FIGURES; CASES FOR TOY STRUCTURES; CASES FOR TOY VEHICLES; CAT TOYS; CHILDREN'S MULTIPLE ACTIVITY TOYS; CHILDREN'S MULTIPLE ACTIVITY TOYS SOLD AS A UNIT WITH PRINTED BOOKS; CHILDREN'S WIRE CONSTRUCTION AND ART ACTIVITY TOYS; CHRISTMAS DOLLS; COLLECTABLE TOY FIGURES; CRIB TOYS; DISC TOSS TOYS; DOG TOYS; DOLL ACCESSORIES; DOLL CASES; DOLL CLOTHING; DOLL COSTUMES; DOLL FURNITURE; DOLL HOUSE FURNISHINGS; DOLL HOUSES; DOLLS; DOLLS AND ACCESSORIES THEREFOR; DOLLS AND PLAYSETS THEREFOR; DOLLS FOR CHRISTMAS; DOLLS FOR PLAYING; DOLLS' CLOTHES; DOLLS' HOUSES; DOLLS' ROOMS; DRAWING TOYS; EDUCATIONAL CARD GAMES; EDUCATIONAL TOY FOR THE PURPOSE OF THE DEMONSTRATION OF ALTERNATIVE ENERGY SOURCES; EDUCATIONAL TOYS FOR TEACHING MATH PRINCIPLES TO CHILDREN, NAMELY, MANIPULATIVE BLOCKS FOR DISPLAYING PATTERNS AND GROUPINGS; ELECTRIC EDUCATIONAL TOY USED TO DEMONSTRATE ALTERNATIVE ENERGY SOURCES; ELECTRONIC ACTION TOYS; ELECTRONIC LEARNING TOYS; ELECTRONIC TOY BUILDING BLOCKS THAT LIGHT UP AS A NIGHT LIGHT; ELECTRONIC TOY VEHICLES; FANTASY CHARACTER TOYS; FLYING DISCS; FLYING SAUCERS; FLYING TOYS USING ELECTROSTATIC LEVITATION; FURNITURE FOR DOLL'S HOUSES; FURNITURE FOR DOLLS' HOUSES; HAND-POWERED NON-MECHANICAL FLYING TOY; INFANT ACTION CRIB TOYS; INFANT DEVELOPMENT TOYS; INFANT SWINGS; INFANT TOYS; INFANT'S RATTLES; INFLATABLE BATH TOYS; INFLATABLE RIDE-ON TOYS; INFLATABLE THIN RUBBER TOYS; INFLATABLE TOYS; INFLATABLE TOYS SHOWING DECORATIVE PICTURES; LEVER ACTION TOYS; MECHANICAL ACTION TOYS; MECHANICAL TOYS; MODELED PLASTIC TOY FIGURES; MOLDED TOY FIGURES; MUSIC BOX TOYS; MUSICAL TOYS; NON-ELECTRONIC TOY VEHICLES; NON-RIDING TRANSPORTATION TOYS; PAPER DOLLS; PARLOR GAMES; PARLOUR GAMES; PARTY FAVORS IN THE NATURE OF SMALL TOYS; PARTY GAMES; PET TOYS; PET TOYS CONTAINING CATNIP; PLASTIC CHARACTER TOYS; PLAY FIGURES; PLAY HOUSES; PLAY MATS CONTAINING INFANT TOYS;

CLASS 28—(Continued).

PLAY MATS FOR USE WITH TOY VEHICLES; PLAYING CARD SHUFFLING DEVICE; PLAYING CARD SHUFFLING MACHINES; PLAYING CARDS; PLAYING CARDS AND CARD GAMES; PLUSH DOLLS; PLUSH DOLLS CREATED FROM CHILDREN'S DRAWINGS; PLUSH TOYS; POP UP TOYS; PORCELAIN DOLLS; POSITIONABLE PRINTED TOY FIGURES FOR USE IN GAMES; POSITIONABLE PRINTED TOY FIGURES FOR USE IN PUZZLES; POSITIONABLE THREE DIMENSIONAL TOYS FOR USE IN GAMES; POSITIONABLE TOY FIGURES; POSITIONABLE TWO DIMENSIONAL TOYS FOR USE IN GAMES; POSITIONABLE WOODEN AND PLASTIC FIGURES FOR USE IN WOODEN AND PLASTIC PUZZLES; PRINTED POSITIONABLE TOYS FOR USE IN CHILDREN'S BOARD GAMES; PRINTING TOYS; PULL TOYS; PUSH TOYS; RADIO CONTROLLED TOY VEHICLES; RAG DOLLS; REMOTE CONTROL TOYS, NAMELY, CARS, VEHICLES AND SLEIGHS; RIDE-ON TOYS; RUBBER CHARACTER TOYS; SAND TOYS; SKETCHING TOYS; SOFT SCULPTURE DOLLS; SOFT SCULPTURE PLUSH TOYS; SOFT SCULPTURE TOYS; SQUEEZABLE SQUEAKING TOYS; SQUEEZE TOYS; STACKING TOYS; STUFFED AND PLUSH TOYS; STUFFED DOLLS AND ANIMALS; STUFFED PUPPETS; STUFFED TOY ANIMALS; STUFFED TOY BEARS; STUFFED TOYS; TALKING ELECTRONIC PRESS-DOWN TOY; TOY ACTION FIGURES; TOY ACTION FIGURES AND ACCESSORIES THEREFOR; TOY ANIMALS; TOY ANIMALS AND ACCESSORIES THEREFOR; TOY BUTTERFLY NETS; TOY CARS; TOY CLOCKS AND WATCHES; TOY FIGURES; TOY FURNITURE; TOY MOBILES; TOY MODEL HOBBYCRAFT KITS; TOY MODEL KIT CARS; TOY MODEL TRAIN SETS; TOY MODEL VEHICLES AND RELATED ACCESSORIES SOLD AS UNITS; TOY MUSIC BOXES; TOY PUTTY; TOY VEHICLES; TOY VEHICLES AND ACCESSORIES THEREFOR; TOY WATCHES; TOY WHISTLES; TOY, NAMELY, BATTERY-POWERED COMPUTER GAME WITH LCD SCREEN WHICH FEATURES ANIMATION AND SOUND EFFECTS; TOYS, NAMELY, A DISK TO TOSS IN PLAYING A GAME WHEREIN OTHER DISKS ARE FLIPPED AND COLLECTED; TOYS, NAMELY, CHILDREN'S DRESS-UP ACCESSORIES; TWO AND THREE DIMENSIONAL POSITIONABLE FIGURES SOLD AS AN INTEGRAL COMPONENT OF TOYS; TWO AND THREE DIMENSIONAL POSITIONABLE GAME FIGURES THAT MAY BE AFFIXED TO CLOTHING; TWO AND THREE DIMENSIONAL POSITIONABLE TOY FIGURES SOLD AS A UNIT WITH EDUCATIONAL BOOKS; TWO AND THREE DIMENSIONAL POSITIONABLE TOY FIGURES SOLD AS A UNIT WITH MEMORY TRAINING EQUIPMENT.; TWO AND THREE DIMENSIONAL POSITIONABLE TOY FIGURES SOLD AS A UNIT WITH OTHER TOYS (U.S. CLS. 22, 23, 38 AND 50).

LOURDES AYALA, EXAMINING ATTORNEY

CLASS 28—(Continued).

SN 77-593,537. WICKFORD EQUITIES, LLC, MINDEN, NV.
FILED 10-15-2008.

Elfus

THE MARK CONSISTS OF STANDARD CHARACTERS WITHOUT CLAIM TO ANY PARTICULAR FONT, STYLE, SIZE, OR COLOR.

FOR ACTION FIGURES; ACTION FIGURES AND ACCESSORIES THEREFOR; ACTION SKILL GAMES; ACTION TARGET GAMES; ACTION-TYPE TARGET GAMES; AMUSEMENT GAME MACHINES; BABY MULTIPLE ACTIVITY TOYS; BATH TOYS; BATHTUB TOYS; BATTERY OPERATED ACTION TOYS; BENDABLE TOYS; BOARD GAMES; CARD GAMES; CASES FOR ACTION FIGURES; CASES FOR TOY STRUCTURES; CASES FOR TOY VEHICLES; CAT TOYS; CHILDREN'S MULTIPLE ACTIVITY TABLES; CHILDREN'S MULTIPLE ACTIVITY TOYS; CHILDREN'S MULTIPLE ACTIVITY TOYS SOLD AS A UNIT WITH PRINTED BOOKS; CHILDREN'S WIRE CONSTRUCTION AND ART ACTIVITY TOYS; CHRISTMAS DOLLS; COLLECTABLE TOY FIGURES; CRIB TOYS; DISC TOSS TOYS; DOG TOYS; DOLL ACCESSORIES; DOLL CASES; DOLL CLOTHING; DOLL COSTUMES; DOLL FURNITURE; DOLL HOUSES; DOLLS; DOLLS AND ACCESSORIES THEREFOR; DOLLS AND DOLLS' CLOTHING; DOLLS AND PLAYSETS THEREFOR; DOLLS FOR CHRISTMAS; DOLLS FOR PLAYING; DOLLS' CLOTHES; DOLLS' FEEDING BOTTLES; DOLLS' HOUSES; DOLLS' ROOMS; DRAWING TOYS; EDUCATIONAL CARD GAMES; EDUCATIONAL TOY FOR THE PURPOSE OF THE DEMONSTRATION OF ALTERNATIVE ENERGY SOURCES; EDUCATIONAL TOYS FOR TEACHING MATH PRINCIPLES TO CHILDREN, NAMELY, MANIPULATIVE BLOCKS FOR DISPLAYING PATTERNS AND GROUPINGS; ELECTRIC ACTION TOYS; ELECTRIC EDUCATIONAL TOY USED TO DEMONSTRATE ALTERNATIVE ENERGY SOURCES; ELECTRONIC ACTION TOYS; ELECTRONIC EDUCATIONAL GAME MACHINES FOR CHILDREN; ELECTRONIC LEARNING TOYS; ELECTRONIC TOY BUILDING BLOCKS THAT LIGHT UP AS A NIGHT LIGHT; ELECTRONIC TOY VEHICLES; ELECTRONICALLY OPERATED TOY MOTOR VEHICLES; FANTASY CHARACTER TOYS; FLYING DISCS; FLYING SAUCERS; FLYING TOYS USING ELECTROSTATIC LEVITATION; FURNITURE FOR DOLL'S HOUSES; FURNITURE FOR DOLLS' HOUSES; HAND-POWERED NON-MECHANICAL FLYING TOY; INFANT ACTION CRIB TOYS; INFANT DEVELOPMENT TOYS; INFANT SWINGS; INFANT TOYS; INFLATABLE BATH TOYS; INFLATABLE RIDE-ON TOYS; INFLATABLE THIN RUBBER TOYS; INFLATABLE TOYS; INFLATABLE TOYS SHOWING DECORATIVE PICTURES; LEVER ACTION TOYS; MECHANICAL ACTION TOYS; MECHANICAL TOYS; MOBILES FOR CHILDREN; MODELED PLASTIC TOY FIGURINES; MOLDED TOY FIGURES; MUSIC BOX TOYS; MUSICAL TOYS; NON-ELECTRONIC TOY VEHICLES; NON-RIDING TRANSPORTATION TOYS; PAPER DOLLS; PARLOR GAMES; PARLOUR GAMES; PARTY FAVORS IN THE NATURE OF SMALL TOYS; PARTY GAMES; PET TOYS; PET TOYS CONTAINING CATNIP; PLASTIC CHARACTER TOYS; PLAY FIGURES; PLAY HOUSES; PLAY MATS CONTAINING INFANT TOYS; PLAY MATS FOR USE WITH TOY VEHICLES; PLAYING CARD SHUFFLING DEVICE; PLAYING CARD SHUFFLING MACHINES; PLAYING CARDS; PLAYING CARDS AND CARD GAMES; PLUSH DOLLS; PLUSH DOLLS CREATED FROM CHILDREN'S DRAWINGS; PLUSH TOYS; POP UP TOYS; PORCELAIN DOLLS; POSITIONABLE PRINTED TOY FIGURES FOR USE IN GAMES; POSITIONABLE PRINTED TOY FIGURES FOR USE IN PUZZLES; POSITIONABLE THREE DIMENSIONAL TOYS FOR USE IN GAMES; POSITIONABLE TOY FIGURES; POSITIONABLE TWO DIMENSIONAL TOYS FOR USE IN GAMES; POSITIONABLE WOODEN AND PLASTIC FIGURES FOR USE IN WOODEN AND PLASTIC PUZZLES; PRINTED POSITIONABLE TOYS FOR

CLASS 28—(Continued).

USE IN CHILDREN'S BOARD GAMES; PRINTING TOYS; PULL TOYS; PUSH TOYS; RADIO CONTROLLED TOY VEHICLES; RAG DOLLS; REMOTE CONTROL TOYS, NAMELY, CARS, VEHICLES AND SLEIGHS; RIDE-ON TOYS; RUBBER CHARACTER TOYS; SAND TOYS; SHOES FOR DOLLS; SKETCHING TOYS; SOFT SCULPTURE DOLLS; SOFT SCULPTURE PLUSH TOYS; SOFT SCULPTURE TOYS; SQUEEZABLE SQUEAKING TOYS; SQUEEZE TOYS; STACKING TOYS; STUFFED AND PLUSH TOYS; STUFFED DOLLS AND ANIMALS; STUFFED PUPPETS; STUFFED TOY ANIMALS; STUFFED TOY BEARS; STUFFED TOYS; TALKING ELECTRONIC PRESS-DOWN TOY; TALKING TOYS; TOY ACTION FIGURES; TOY ACTION FIGURES AND ACCESSORIES THEREFOR; TOY ANIMALS; TOY ANIMALS AND ACCESSORIES THEREFOR; TOY BUTTERFLY NETS; TOY CLOCKS AND WATCHES; TOY FIGURES; TOY FURNITURE; TOY MOBILES; TOY MODEL HOBBYCRAFT KITS; TOY MODEL KIT CARS; TOY MODEL TRAIN SETS; TOY MODEL VEHICLES AND RELATED ACCESSORIES SOLD AS UNITS; TOY MUSIC BOXES; TOY PUTTY; TOY VEHICLES; TOY WATCHES; TOY WHISTLES; TOY, NAMELY, BATTERY-POWERED COMPUTER GAME WITH LCD SCREEN WHICH FEATURES ANIMATION AND SOUND EFFECTS; TOYS, NAMELY, A DISK TO TOSS IN PLAYING A GAME WHEREIN OTHER DISKS ARE FLIPPED AND COLLECTED; TOYS, NAMELY, CHILDREN'S DRESS-UP ACCESSORIES; TWO AND THREE DIMENSIONAL POSITIONABLE FIGURES SOLD AS AN INTEGRAL COMPONENT OF TOYS; TWO AND THREE DIMENSIONAL POSITIONABLE GAME FIGURES THAT MAY BE AFFIXED TO CLOTHING; TWO AND THREE DIMENSIONAL POSITIONABLE TOY FIGURES SOLD AS A UNIT WITH EDUCATIONAL BOOKS; TWO AND THREE DIMENSIONAL POSITIONABLE TOY FIGURES SOLD AS A UNIT WITH MEMORY TRAINING EQUIPMENT.; TWO AND THREE DIMENSIONAL POSITIONABLE TOY FIGURES SOLD AS A UNIT WITH OTHER TOYS (U.S. CLS. 22, 23, 38 AND 50).

LOURDES AYALA, EXAMINING ATTORNEY

SN 77-593,571. WICKFORD EQUITIES, LLC, MINDEN, NV.
FILED 10-15-2008.

Elfox

THE MARK CONSISTS OF STANDARD CHARACTERS WITHOUT CLAIM TO ANY PARTICULAR FONT, STYLE, SIZE, OR COLOR.

FOR ACTION FIGURES; ACTION FIGURES AND ACCESSORIES THEREFOR; ACTION SKILL GAMES; ACTION TARGET GAMES; ACTION-TYPE TARGET GAMES; BABY MULTIPLE ACTIVITY TOYS; BATH TOYS; BATHTUB TOYS; BATTERY OPERATED ACTION TOYS; BENDABLE TOYS; BOARD GAMES; CASES FOR ACTION FIGURES; CASES FOR TOY STRUCTURES; CASES FOR TOY VEHICLES; CAT TOYS; CHILDREN'S MULTIPLE ACTIVITY TABLES; CHILDREN'S MULTIPLE ACTIVITY TOYS; CHILDREN'S MULTIPLE ACTIVITY TOYS SOLD AS A UNIT WITH PRINTED BOOKS; CHILDREN'S WIRE CONSTRUCTION AND ART ACTIVITY TOYS; COLLECTABLE TOY FIGURES; CRIB TOYS; DISC TOSS TOYS; DOG TOYS; DRAWING TOYS; EDUCATIONAL CARD GAMES; EDUCATIONAL TOY FOR THE PURPOSE OF THE DEMONSTRATION OF ALTERNATIVE ENERGY SOURCES; EDUCATIONAL TOYS FOR TEACHING MATH PRINCIPLES TO CHILDREN, NAMELY, MANIPULATIVE BLOCKS FOR DISPLAYING PATTERNS AND GROUPINGS; ELECTRIC ACTION TOYS; ELECTRIC EDUCATIONAL TOY USED TO DEMONSTRATE ALTERNATIVE ENERGY SOURCES; ELECTRONIC ACTION TOYS; ELECTRONIC EDUCATIONAL GAME MACHINES FOR CHILDREN; ELECTRONIC LEARNING TOYS; ELECTRONIC TOY

CLASS 28—(Continued).

BUILDING BLOCKS THAT LIGHT UP AS A NIGHT LIGHT; ELECTRONIC TOY VEHICLES; ELECTRONICALLY OPERATED TOY MOTOR VEHICLES; FANTASY CHARACTER TOYS; FLYING SAUCERS; FLYING TOYS USING ELECTROSTATIC LEVITATION; HAND-POWERED NON-MECHANICAL FLYING TOY; INFANT ACTION CRIB TOYS; INFANT DEVELOPMENT TOYS; INFANT SWINGS; INFANT TOYS; INFANT'S RATTLES; INFLATABLE BATH TOYS; INFLATABLE RIDE-ON TOYS; INFLATABLE THIN RUBBER TOYS; INFLATABLE TOYS; INFLATABLE TOYS SHOWING DECORATIVE PICTURES; LEVER ACTION TOYS; MECHANICAL ACTION TOYS; MECHANICAL TOYS; MOBILES FOR CHILDREN; MODELED PLASTIC TOY FIGURINES; MOLDED TOY FIGURES; MUSIC BOX TOYS; MUSICAL TOYS; NON-ELECTRONIC TOY VEHICLES; NON-RIDING TRANSPORTATION TOYS; PARLOR GAMES; PARLOUR GAMES; PARTY FAVORS IN THE NATURE OF SMALL TOYS; PARTY GAMES; PET TOYS; PET TOYS CONTAINING CATNIP; PLASTIC CHARACTER TOYS; PLAY FIGURES; PLAY HOUSES; PLAY MATS CONTAINING INFANT TOYS; PLAY MATS FOR USE WITH TOY VEHICLES; PLAYING CARD CASES; PLAYING CARD SHUFFLING DEVICE; PLAYING CARD SHUFFLING MACHINES; PLAYING CARDS; PLAYING CARDS AND CARD GAMES; PLUSH DOLLS CREATED FROM CHILDREN'S DRAWINGS; PLUSH TOYS; POP UP TOYS; POSITIONABLE PRINTED TOY FIGURES FOR USE IN GAMES; POSITIONABLE PRINTED TOY FIGURES FOR USE IN PUZZLES; POSITIONABLE THREE DIMENSIONAL TOYS FOR USE IN GAMES; POSITIONABLE TOY FIGURES; POSITIONABLE TWO DIMENSIONAL TOYS FOR USE IN GAMES; POSITIONABLE WOODEN AND PLASTIC FIGURES FOR USE IN WOODEN AND PLASTIC PUZZLES; PRINTED POSITIONABLE TOYS FOR USE IN CHILDREN'S BOARD GAMES; PRINTING TOYS; PULL TOYS; PUSH TOYS; RADIO CONTROLLED TOY VEHICLES; REMOTE CONTROL TOYS, NAMELY, CARS, VEHICLES AND SLEIGHS; RIDE-ON TOYS; RUBBER CHARACTER TOYS; SAND TOYS; SKETCHING TOYS; SOFT SCULPTURE PLUSH TOYS; SOFT SCULPTURE TOYS; SQUEEZABLE SQUEAKING TOYS; SQUEEZE TOYS; STACKING TOYS; STUFFED AND PLUSH TOYS; STUFFED DOLLS AND ANIMALS; STUFFED PUPPETS; STUFFED TOY ANIMALS; STUFFED TOY BEARS; STUFFED TOYS; TALKING ELECTRONIC PRESS-DOWN TOY; TALKING TOYS; TOSSING DISC TOYS; TOY ACTION FIGURES; TOY ACTION FIGURES AND ACCESSORIES THEREFOR; TOY ANIMALS; TOY ANIMALS AND ACCESSORIES THEREFOR; TOY BUTTERFLY NETS; TOY CLOCKS AND WATCHES; TOY FIGURES; TOY FURNITURE; TOY MOBILES; TOY MODEL HOBBYCRAFT KITS; TOY MODEL KIT CARS; TOY MODEL TRAIN SETS; TOY MODEL VEHICLES AND RELATED ACCESSORIES SOLD AS UNITS; TOY MUSIC BOXES; TOY PUTTY; TOY VEHICLES; TOY WATCHES; TOY WHISTLES; TOY, NAMELY, BATTERY-POWERED COMPUTER GAME WITH LCD SCREEN WHICH FEATURES ANIMATION AND SOUND EFFECTS; TOYS, NAMELY, A DISK TO TOSS IN PLAYING A GAME WHEREIN OTHER DISKS ARE FLIPPED AND COLLECTED; TOYS, NAMELY, CHILDREN'S DRESS-UP ACCESSORIES; TWO AND THREE DIMENSIONAL POSITIONABLE FIGURES SOLD AS AN INTEGRAL COMPONENT OF TOYS; TWO AND THREE DIMENSIONAL POSITIONABLE GAME FIGURES THAT MAY BE AFFIXED TO CLOTHING; TWO AND THREE DIMENSIONAL POSITIONABLE TOY FIGURES SOLD AS A UNIT WITH EDUCATIONAL BOOKS; TWO AND THREE DIMENSIONAL POSITIONABLE TOY FIGURES SOLD AS A UNIT WITH MEMORY TRAINING EQUIPMENT.; TWO AND THREE DIMENSIONAL POSITIONABLE TOY FIGURES SOLD AS A UNIT WITH OTHER TOYS (U.S. CLS. 22, 23, 38 AND 50).

LOURDES AYALA, EXAMINING ATTORNEY

CLASS 28—(Continued).

SN 78-566,586. O'NEAL, ROBERT J., MISSION, CANADA,
FILED 2-14-2005.

SYNCHROHEARTS

THE MARK CONSISTS OF STANDARD CHARACTERS
WITHOUT CLAIM TO ANY PARTICULAR FONT, STYLE,
SIZE, OR COLOR.

PRIORITY CLAIMED UNDER SEC. 44(D) ON CANADA
APPLICATION NO. 1232455, FILED 10-1-2004, REG. NO.
TMA711563, DATED 4-10-2008, EXPIRES 4-10-2023.
FOR BOARD GAMES (U.S. CLS. 22, 23, 38 AND 50).
HEATHER THOMPSON, EXAMINING ATTORNEY

SN 78-627,247. GAME CABINETS INC., REDMOND, WA.
FILED 5-10-2005.

CrystalCade

FOR STAND ALONE VIDEO ARCADE GAME MA-
CHINES FEATURING TRANSPARENT GAME CABI-
NETS; ARCADE GAME SYSTEMS, NAMELY,
TRANSPARENT STAND ALONE VIDEO ARCADE
GAMES MACHINES; STAND ALONE VIDEO GAMES
MACHINES, NAMELY, STAND UP STYLE VIDEO
GAME MACHINES AND COCKTAIL TABLE STYLE
VIDEO GAME MACHINES (U.S. CLS. 22, 23, 38 AND 50).
FIRST USE 8-5-2004; IN COMMERCE 5-1-2005.
JOHN KELLY, EXAMINING ATTORNEY

CLASS 28—(Continued).

SN 78-911,868. DISNEY ENTERPRISES, INC., BURBANK,
CA. FILED 6-20-2006.

PETER PAN

THE MARK CONSISTS OF STANDARD CHARACTERS
WITHOUT CLAIM TO ANY PARTICULAR FONT, STYLE,
SIZE, OR COLOR.

THE NAME SHOWN IN THE MARK DOES NOT IDENTI-
FY A PARTICULAR LIVING INDIVIDUAL.

FOR ACTION SKILL GAMES; BOARD GAMES; CARD
GAMES; BADMINTON SETS; BALLOONS; BASKET-
BALLS; BATH TOYS; BASEBALLS; BEACH BALLS;
BEAN BAGS; BEAN BAG DOLLS; TOY BUILDING
BLOCKS; BOWLING BALLS; BUBBLE MAKING WANDS
AND SOLUTION SETS; CHESS SETS; CHILDREN'S
PLAY COSMETICS; CHRISTMAS STOCKINGS; CHRIST-
MAS TREE DECORATIONS; CRIB MOBILES; CRIB
TOYS; DISC TOSS TOYS; ELECTRIC ACTION TOYS;
EQUIPMENT SOLD AS A UNIT FOR PLAYING CARD
GAMES; FISHING TACKLE; GOLF BALLS; GOLF
GLOVES; GOLF BALL MARKERS; HAND HELD UNIT
FOR PLAYING ELECTRONIC GAMES; HOCKEY
PUCKS; INFLATABLE TOYS; JIGSAW PUZZLES; JUMP
ROPES; KITES; MAGIC TRICKS; MARBLES; MANIPU-
LATIVE GAMES; MECHANICAL TOYS; MUSIC BOX
TOYS; MUSICAL TOYS; PARLOR GAMES; PARTY
FAVORS IN THE NATURE OF SMALL TOYS; PARTY
GAMES; PLAYING CARDS; ROLLER SKATES; RUBBER
BALLS; SKATEBOARDS; SOCCER BALLS; SPINNING
TOPS; SQUEEZE TOYS; TABLE TENNIS TABLES; TAR-
GET GAMES; TENNIS BALLS; TOY BUCKET AND
SHOVEL SETS; TOY MOBILES; TOY VEHICLES; TOY
SCOOTERS; TOY CARS; TOY MODEL HOBBYCRAFT
KITS; TOY FIGURES; TOY BANKS; TOY TRUCKS; TOY
WATCHES; WIND-UP TOYS; YO-YOS (U.S. CLS. 22, 23,
38 AND 50).

DEZMONA MIZELLE, EXAMINING ATTORNEY

SN 79-053,313. GOLFJUNKIE INTERNATIONAL B.V.,
NETHERLANDS, FILED 11-16-2007.

GOLF JUNKIE

THE MARK CONSISTS OF STANDARD CHARACTERS
WITHOUT CLAIM TO ANY PARTICULAR FONT, STYLE,
SIZE, OR COLOR.

OWNER OF INTERNATIONAL REGISTRATION 0885289
DATED 3-14-2006, EXPIRES 3-14-2016.

OWNER OF U.S. REG. NO. 3,240,105.

NO CLAIM IS MADE TO THE EXCLUSIVE RIGHT TO
USE "GOLF", APART FROM THE MARK AS SHOWN.

FOR SPORTS ARTICLES FOR GOLF, NAMELY, GOLF
CLUBS, GOLF CLUB HEADS AND GRIPS, GOLF CLUB
COVERS, GOLF BALLS, GOLF TEES, GOLF BAGS WITH
OR WITHOUT WHEELS, CADDIE BAGS WITH OR
WITHOUT WHEELS, AND GOLF GLOVES (U.S. CLS.
22, 23, 38 AND 50).

KIMBERLY FRYE, EXAMINING ATTORNEY

CLASS 28—(Continued).

SN 79-055,586. DONGYANG TIMES; FISHING TACKLE CO., LTD., ZHEJIANG, CHINA, FILED 6-24-2008.

TIMES

OWNER OF INTERNATIONAL REGISTRATION 0969121 DATED 6-24-2008, EXPIRES 6-24-2018.
FOR RODS FOR FISHING; LINES FOR FISHING; FISHING TACKLE; REELS FOR FISHING; FISH HOOKS; FLOATS FOR FISHING; LURES FOR HUNTING OR FISHING; LANDING NETS FOR ANGLERS; BALLS FOR GAMES (U.S. CLS. 22, 23, 38 AND 50).
KELLY MCCOY, EXAMINING ATTORNEY

CLASS 29—(Continued).

SN 77-000,959. SUNRISE POULTRY PROCESSORS LTD., SURREY, CANADA, FILED 9-15-2006.

**SUNRISE FARMS SELECT
SERVINGS**

THE MARK CONSISTS OF STANDARD CHARACTERS WITHOUT CLAIM TO ANY PARTICULAR FONT, STYLE, SIZE, OR COLOR.

PRIORITY CLAIMED UNDER SEC. 44(D) ON CANADA APPLICATION NO. 1294122, FILED 3-17-2006, REG. NO. TMA693,473, DATED 8-3-2007, EXPIRES 8-3-2022.

NO CLAIM IS MADE TO THE EXCLUSIVE RIGHT TO USE "FARMS SELECT SERVINGS", APART FROM THE MARK AS SHOWN.

FOR FRESH, FROZEN AND COOKED POULTRY PRODUCTS, NAMELY, WHOLE CHICKENS, CHICKEN PARTS, BONELESS CHICKEN, CHICKEN BURGERS, WHOLE TURKEYS, TURKEY PARTS, BONELESS TURKEY AND TURKEY BURGERS; FRESH, FROZEN AND COOKED BEEF PRODUCTS, NAMELY, WHOLE BEEF CARCASSES, BEEF PARTS, BONELESS BEEF, BEEF BURGERS, BEEF STEAKS AND MEATBALLS; FRESH, FROZEN AND COOKED PORK PRODUCTS, NAMELY, WHOLE PORK CARCASSES, PORK PARTS, BONELESS PORK AND PORK BURGERS; PREPARED MEALS CONSISTING PRIMARILY OF MEAT, FISH, POULTRY, PASTA OR VEGETABLES; SALADS, NAMELY, POTATO SALADS (U.S. CL. 46).

TIMOTHY FINNEGAN, EXAMINING ATTORNEY

CLASS 29—MEATS AND PROCESSED FOODS

SN 76-678,121. MOUNTAIN STATES/ROSEN, LLC, BRONX, NY. FILED 6-12-2007.

SMART CUISINE

THE MARK CONSISTS OF STANDARD CHARACTERS WITHOUT CLAIM TO ANY PARTICULAR FONT, STYLE, SIZE, OR COLOR.

NO CLAIM IS MADE TO THE EXCLUSIVE RIGHT TO USE "CUISINE", APART FROM THE MARK AS SHOWN.

FOR MEAT (U.S. CL. 46).
SUZANNE BLANE, EXAMINING ATTORNEY

SN 77-283,954. AGRO-FARMA, INC., JOHNSTOWN, NY. FILED 9-19-2007.

SN 76-692,623. LEE KUM KEE COMPANY LIMITED, NEW TERRITORIES, HONG KONG, FILED 9-8-2008.

KUM CHUN

THE MARK CONSISTS OF STANDARD CHARACTERS WITHOUT CLAIM TO ANY PARTICULAR FONT, STYLE, SIZE, OR COLOR.

OWNER OF U.S. REG. NO. 2,171,765.
"KUM" IN THE MARK TRANSLATES INTO ENGLISH AS TAPESTRY, AND "CHUN" IN THE MARK TRANSLATES INTO ENGLISH AS RARE OR PRECIOUS.

FOR CHICKEN BOUILLON POWDER (U.S. CL. 46).
FIRST USE 12-0-2001; IN COMMERCE 11-0-2002.
BERYL GARDNER, EXAMINING ATTORNEY

OZSUT

THE MARK CONSISTS OF STANDARD CHARACTERS WITHOUT CLAIM TO ANY PARTICULAR FONT, STYLE, SIZE, OR COLOR.

THE ENGLISH TRANSLATION OF "ÖZ" IS "CORE" AND THE ENGLISH TRANSLATION OF "SÜT" IS "MILK".

FOR DAIRY PRODUCTS, NAMELY, CHEESE, YOGURT, AND MILK; OLIVE OIL (U.S. CL. 46).
ANGELA GAW, EXAMINING ATTORNEY

CLASS 29—(Continued).

SN 77-363,007. SCHLOSSBRAUEREI KALTENBERG IRMINGARD PRINZESSIN VON BAYERN KG, KALTENBERG, FED REP GERMANY, FILED 1-2-2008.



THE MARK CONSISTS OF A SHIELD WITH A CROWN ON TOP AND HERALDIC LIONS ON EACH SIDE, THE TEXT "KÖNIG LUDWIG" BENEATH THE SHIELD.

THE FOREIGN WORDING IN THE MARK TRANSLATES INTO ENGLISH AS KING.

FOR MEAT, FISH, POULTRY AND GAME; JAMS; EDIBLE OILS (U.S. CL. 46).

JAY FLOWERS, EXAMINING ATTORNEY

SN 77-391,361. DE TAPAS FINE FOODS, S.L., HONDARRIBIA (GIPUZKOA), SPAIN, FILED 2-7-2008.

DETAPAS

THE MARK CONSISTS OF STANDARD CHARACTERS WITHOUT CLAIM TO ANY PARTICULAR FONT, STYLE, SIZE, OR COLOR.

FOR OMELETS; EDIBLE OILS; PROCESSED VEGETABLES; PROCESSED MEAT; PROCESSED FRUITS; PROCESSED EGGS; SOUPS; SEAFOOD; CHEESE; FRUIT PRESERVES; JELLIES; JELLIES AND JAMS; DRIED FRUITS; SHELLFISH FOR HUMAN CONSUMPTION; SHELLFISH, NOT LIVE; VEGETABLE-BASED SPREADS (U.S. CL. 46).

COURTNEY MCCORMICK, EXAMINING ATTORNEY

SN 77-391,429. DE TAPAS FINE FOODS, S.L., HONDARRIBIA (GIPUZKOA), SPAIN, FILED 2-7-2008.



THE MARK CONSISTS OF THE LETTERS "D E T A P A S" IN A JUMBLED OR SCRAMBLED FASHION.

FOR OMELETS; EDIBLE OILS; PROCESSED VEGETABLES; PROCESSED MEAT; PROCESSED FRUITS; PROCESSED EGGS; SOUPS; SEAFOOD; CHEESE; FRUIT PRESERVES; JELLIES; JELLIES AND JAMS; DRIED FRUITS; SHELLFISH FOR HUMAN CONSUMPTION; SHELLFISH, NOT LIVE; VEGETABLE-BASED SPREADS (U.S. CL. 46).

COURTNEY MCCORMICK, EXAMINING ATTORNEY

CLASS 29—(Continued).

SN 77-403,562. AGRIPROCESSORS, INC., POSTVILLE, IA, FILED 2-22-2008.

HEALTHY FOR YOU

THE MARK CONSISTS OF STANDARD CHARACTERS WITHOUT CLAIM TO ANY PARTICULAR FONT, STYLE, SIZE, OR COLOR.

FOR POULTRY, NAMELY, CHICKEN BREAST AND PROCESSED CHICKEN PARTS (U.S. CL. 46).

FIRST USE 8-6-2007; IN COMMERCE 8-6-2007.

PAULA MAHONEY, EXAMINING ATTORNEY

SN 77-407,670. SPITZ INTERNATIONAL INC., BOW ISLAND, ALBERTA, CANADA, FILED 2-27-2008.



PRIORITY CLAIMED UNDER SEC. 44(D) ON CANADA APPLICATION NO. 1366158, FILED 10-9-2007, REG. NO. TMA727,917, DATED 11-6-2008, EXPIRES 11-6-2023.

THE MARK CONSISTS OF THE TERM "SPITZ" INSIDE THE FANCIFUL REPRESENTATION OF A SUNFLOWER, WITH SEVEN ARCS OF A RAINBOW EMANATING OUT THE SUNFLOWER DESIGN.

FOR PROCESSED EDIBLE SUNFLOWER KERNELS (U.S. CL. 46).

RUSS HERMAN, EXAMINING ATTORNEY

CLASS 29—(Continued).

SN 77-461,505. AVEC ERIC, LLC, NEW YORK, NY. FILED 4-30-2008.

AVEC ERIC

THE MARK CONSISTS OF STANDARD CHARACTERS WITHOUT CLAIM TO ANY PARTICULAR FONT, STYLE, SIZE, OR COLOR.

THE ENGLISH TRANSLATION OF "AVEC" IS "WITH".
 FOR PREPACKAGED MEAL KITS CONSISTING PRIMARILY OF ONE OR MORE OF THE FOLLOWING, MEAT, SEAFOOD, POULTRY OR VEGETABLES; FROZEN APPETIZERS CONSISTING PRIMARILY OF ONE OR MORE OF THE FOLLOWING, MEAT, SEAFOOD, POULTRY OR VEGETABLES; CONDIMENTS, NAMELY, FLAVORED EDIBLE OILS; BEEF STOCK; CHICKEN STOCK; FISH STOCK; VEGETABLE STOCK; JAMS, JELLIES AND MARMALADES; TAPENADES; FROZEN APPETIZERS CONSISTING PRIMARILY OF CHICKEN, MEAT OR SEAFOOD (U.S. CL. 46).

LESLIE RICHARDS, EXAMINING ATTORNEY

SN 77-462,583. LUBERSKI, INC., SAN MARCOS, CA. FILED 4-30-2008.

PERFECTLY FRESH

THE MARK CONSISTS OF STANDARD CHARACTERS WITHOUT CLAIM TO ANY PARTICULAR FONT, STYLE, SIZE, OR COLOR.

OWNER OF U.S. REG. NO. 3,053,013.
 NO CLAIM IS MADE TO THE EXCLUSIVE RIGHT TO USE "FRESH", APART FROM THE MARK AS SHOWN.
 FOR EGGS, EGG SUBSTITUTES; AND RELATED EGG PRODUCTS, NAMELY, LIQUID, FROZEN AND POWDERED PASTEURIZED EGGS, LIQUID, FROZEN AND POWDERED PASTEURIZED EGG WHITES, LIQUID, FROZEN AND POWDERED PASTEURIZED EGG YOLKS, AND CHOLESTEROL-FREE EGG WHITES (U.S. CL. 46).

JOHN DALIER, EXAMINING ATTORNEY

CLASS 29—(Continued).

SN 77-523,071. LOPER, CHUCK, RICHFIELD, OH. FILED 7-15-2008.



OWNER OF U.S. REG. NO. 3,421,558.
 THE MARK CONSISTS OF THE IMAGE SHOWS A MULTIMASTED VESSEL TRAVELING ON A BODY OF WATER CREATING RIPPLES WITHIN CONCENTRIC OVALS. THE BOAT PROTRUDES OUT OF THE OVALS. WITHIN THE OVALS ARE THE WORDS, "MARINER'S CHOICE".

FOR FISH; FISH FILLETS; SHELLFISH FOR HUMAN CONSUMPTION; SHELLFISH, NOT LIVE (U.S. CL. 46).
 FIRST USE 12-12-2006; IN COMMERCE 12-12-2006.
 MARK SPARACINO, EXAMINING ATTORNEY

SN 77-544,542. LM FOODS, L.L.C., CARTERET, NJ. FILED 8-12-2008.

Lobster Choice

THE MARK CONSISTS OF STANDARD CHARACTERS WITHOUT CLAIM TO ANY PARTICULAR FONT, STYLE, SIZE, OR COLOR.

NO CLAIM IS MADE TO THE EXCLUSIVE RIGHT TO USE "LOBSTER", APART FROM THE MARK AS SHOWN.
 FOR IMITATION LOBSTER MEAT MADE WITH FISH PROTEINS, REAL LOBSTER MEAT, AND ARTIFICIAL COLORS AND FLAVORS (U.S. CL. 46).

TINA BROWN, EXAMINING ATTORNEY

CLASS 29—(Continued).

SN 77-546,935. SF INVESTMENTS, INC., WILMINGTON, DE.
FILED 8-14-2008.



OWNER OF U.S. REG. NOS. 1,649,600, 3,049,300 AND OTHERS.

NO CLAIM IS MADE TO THE EXCLUSIVE RIGHT TO USE "DOG", APART FROM THE MARK AS SHOWN.

THE MARK CONSISTS OF A RECTANGULAR BOX WITH THE WORD "FARMLAND" AND A DEPICTION OF A CLOUD ABOVE THE WORD. BELOW THE BOX IS A BANNER CONTAINING THE WORDS "GOOD FOOD FROM THE HEARTLAND". BELOW THE BANNER APPEARS THE TERM "TWISTER DOG" IN OUTLINED LETTERING.

FOR HOT DOGS (U.S. CL. 46).
FIRST USE 1-31-2007; IN COMMERCE 1-31-2007.
JIM RINGLE, EXAMINING ATTORNEY

CLASS 29—(Continued).

SN 77-557,010. MICHAEL DEANGELIS, DBA NEW YORK SAUSAGE COMPANY, BROOKLYN, NY. FILED 8-27-2008.



NO CLAIM IS MADE TO THE EXCLUSIVE RIGHT TO USE "NEW YORK SAUSAGE COMPANY", APART FROM THE MARK AS SHOWN.

THE COLOR(S) RED, WHITE, GREEN AND BLACK IS/ARE CLAIMED AS A FEATURE OF THE MARK.

THE MARK CONSISTS OF A CITY SKYLINE IN THE COLOR BLACK, THE WORDING "NEW YORK" IN THE COLOR RED OUTLINED IN THE COLOR WHITE, THE WORDING "SAUSAGE" IN THE COLOR WHITE OUTLINED IN THE COLORS BLACK AND RED, AND THE WORDING "COMPANY" IN THE COLOR GREEN OUTLINED IN THE COLORS BLACK AND WHITE.

FOR SAUSAGES (U.S. CL. 46).
BARBARA RUTLAND, EXAMINING ATTORNEY

SN 77-558,820. MEVGAL S.A. DAIRY PRODUCT INDUSTRY, TA MEVGAL S.A., THESSALONIKI, GREECE, FILED 8-29-2008.

SN 77-554,608. ARMANDO RIENZI, WRIGHTSTOWN, PA.
FILED S.R. 8-25-2008; AM. P.R. 12-15-2008.

**PHILLYMIGNON**

THE MARK CONSISTS OF STANDARD CHARACTERS WITHOUT CLAIM TO ANY PARTICULAR FONT, STYLE, SIZE, OR COLOR.

FOR SANDWICH SLICES COMPRISING BEEF, FOR USE IN MAKING PHILLY CHEESESTEAKS (U.S. CL. 46).
FIRST USE 7-31-2008; IN COMMERCE 7-31-2008.
JESSICA A. POWERS, EXAMINING ATTORNEY

NO CLAIM IS MADE TO THE EXCLUSIVE RIGHT TO USE "GREEK YOGURT", APART FROM THE MARK AS SHOWN.

THE COLOR(S) BLUE AND FUCHSIA (CMYK COLOR MODEL VALUES FOR FUCHSIA ARE C=0, M=100, Y=65 AND K=15) IS/ARE CLAIMED AS A FEATURE OF THE MARK.

THE MARK CONSISTS OF THE WORDS "NUTRIYO GREEK YOGURT". THE LETTER "Y" OF "NUTRIYO" SUGGESTS A FANCIFUL CHARACTER. THE WORDS "NUTRI" AND "GREEK YOGURT" ARE IN BLUE AND THE WORD "YO" IS IN FUCHSIA.

"NUTRIYO" HAS NO MEANING IN A FOREIGN LANGUAGE.
FOR YOGURT (U.S. CL. 46).
AMY ALFIERI, EXAMINING ATTORNEY

CLASS 29—(Continued).

SN 77-560,192. KHANNA INC, HAYWARD, CA. FILED 9-2-2008.

Soul Curry

THE MARK CONSISTS OF STANDARD CHARACTERS WITHOUT CLAIM TO ANY PARTICULAR FONT, STYLE, SIZE, OR COLOR.

NO CLAIM IS MADE TO THE EXCLUSIVE RIGHT TO USE "CURRY", APART FROM THE MARK AS SHOWN.

FOR PRE-PACKAGED MEAL KITS CONSISTING PRIMARILY OF INDIAN FOOD, NAMELY, BEEF, PORK, LAMB, SEAFOOD OR POULTRY SERVED WITH PASTA, RICE AND VEGETABLES, WITH SERVING TRAY, SOLD AS A UNIT (U.S. CL. 46).

LINDSEY RUBIN, EXAMINING ATTORNEY

CLASS 29—(Continued).

SN 77-561,846. TORRVALL ENTERPRISES, HIGHLAND LAKES, NJ. FILED 9-3-2008.

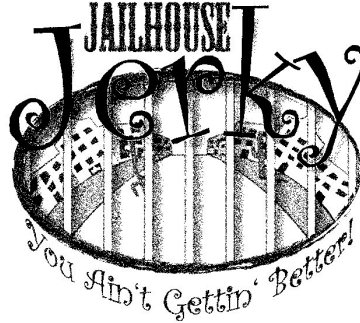

NO CLAIM IS MADE TO THE EXCLUSIVE RIGHT TO USE "JERKY", APART FROM THE MARK AS SHOWN.

THE STIPPLING IS FOR SHADING PURPOSES ONLY. THE MARK CONSISTS OF THE STACKED WORDING "JAILHOUSE JERKY" WITH THE WORD "JERKY" APPEARING PARTIALLY SUPERIMPOSED ON AN OVAL CONTAINING A STREET WITH BUILDINGS ON EITHER SIDE BEHIND A SERIES OF VERTICAL BARS. THE WORDING "YOU AIN'T GETTIN' BETTER!" APPEARS BENEATH THE OVAL.

FOR BEEF JERKY (U.S. CL. 46).
JAMES LOVELACE, EXAMINING ATTORNEY

SN 77-563,318. OS ASSET, INC., TAMPA, FL. FILED 9-5-2008.

RIBS AND ALICE SPRINGS CHICKEN COMBO

SN 77-560,317. J DELUCA FISH COMPANY, INC., SAN PEDRO, CA. FILED 9-2-2008.

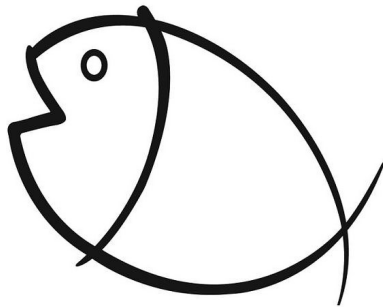

THE MARK CONSISTS OF STANDARD CHARACTERS WITHOUT CLAIM TO ANY PARTICULAR FONT, STYLE, SIZE, OR COLOR.

OWNER OF U.S. REG. NO. 1,720,493. NO CLAIM IS MADE TO THE EXCLUSIVE RIGHT TO USE "RIBS" AND "CHICKEN COMBO", APART FROM THE MARK AS SHOWN.

FOR PREPARED ENTREES CONSISTING PRIMARILY OF MEAT, FISH, POULTRY OR VEGETABLES (U.S. CL. 46).

FIRST USE 5-21-2008; IN COMMERCE 5-21-2008.
MARK SPARACINO, EXAMINING ATTORNEY

SN 77-564,718. SCHREIBER FOODS, INC., GREEN BAY, WI. FILED 9-8-2008.

CHEEZEETA

THE MARK CONSISTS OF A STYLIZED FISH. FOR SEAFOOD, FROZEN FISH, FRESH FISH, AND PROCESSED FRESH FISH (U.S. CL. 46).

AARON BRODSKY, EXAMINING ATTORNEY

THE MARK CONSISTS OF STANDARD CHARACTERS WITHOUT CLAIM TO ANY PARTICULAR FONT, STYLE, SIZE, OR COLOR.

FOR CHEESE, NAMELY, PROCESSED (U.S. CL. 46).
AISHA SALEM, EXAMINING ATTORNEY

CLASS 29—(Continued).

SN 77-564,785. ROMA MEAT SPECIALTIES & DELIVERIES, INC., HIALEAH, FL. FILED 9-8-2008.

JAMON VICKY LATINO

THE MARK CONSISTS OF STANDARD CHARACTERS WITHOUT CLAIM TO ANY PARTICULAR FONT, STYLE, SIZE, OR COLOR.

NO CLAIM IS MADE TO THE EXCLUSIVE RIGHT TO USE "JAMON", APART FROM THE MARK AS SHOWN.

THE NAME "VICKY" OR "VICKY LATINO" DOES NOT IDENTIFY A LIVING INDIVIDUAL.

THE FOREIGN WORDING IN THE MARK TRANSLATES INTO ENGLISH AS VICKY LATIN HAM.

FOR HAM (U.S. CL. 46).

FIRST USE 1-31-2008; IN COMMERCE 1-31-2008.

MARCIE MILONE, EXAMINING ATTORNEY

SN 77-565,815. CSC BRANDS LP, CAMDEN, NJ. FILED 9-9-2008.

GOOD FOOD. FROM GOOD PLACES. MADE BY GOOD PEOPLE.

THE MARK CONSISTS OF STANDARD CHARACTERS WITHOUT CLAIM TO ANY PARTICULAR FONT, STYLE, SIZE, OR COLOR.

FOR SOUPS (U.S. CL. 46).

TRACY FLETCHER, EXAMINING ATTORNEY

SN 77-565,890. MCCAIN FOODS USA, INC., LISLE, IL. FILED 9-9-2008.



OWNER OF U.S. REG. NO. 2,621,285.
THE MARK CONSISTS OF A STYLIZED REPRESENTATION OF TWO PEPPERS.

FOR APPETIZERS CONSISTING PRIMARILY OF VEGETABLES AND CHEESE (U.S. CL. 46).

JAMES A. RAUEN, EXAMINING ATTORNEY

CLASS 29—(Continued).

SN 77-565,936. IBE BUSINESS ENTERPRISE AG, ZUG, SWITZERLAND, FILED 9-9-2008.



OWNER OF U.S. REG. NOS. 2,829,118, 3,420,786 AND OTHERS.

THE MARK CONSISTS OF A STYLIZED DESIGN OF A HEART WITH A STYLIZED FLOWER DESIGN AND THE TERM "LALA" IN STYLIZED FONT LOCATED TO THE MIDDLE AND RIGHT SIDE OF THE HEART DESIGN AND POSITIONED DIRECTLY ABOVE THE TERM "SIEMPRE A TU LADO" IN STYLIZED FONT.

THE FOREIGN WORDING IN THE MARK TRANSLATES INTO ENGLISH AS ALWAYS AT YOUR SIDE.

FOR DAIRY PRODUCTS EXCLUDING ICE CREAM, ICE MILK AND FROZEN YOGURT (U.S. CL. 46).

JERI J. FICKES, EXAMINING ATTORNEY

SN 77-567,861. BEST CHICAGO MEAT COMPANY, LLC, CHICAGO, IL. FILED 9-11-2008.

JEMM

THE MARK CONSISTS OF STANDARD CHARACTERS WITHOUT CLAIM TO ANY PARTICULAR FONT, STYLE, SIZE, OR COLOR.

FOR MEAT (U.S. CL. 46).

FIRST USE 0-0-1959; IN COMMERCE 0-0-1959.

LINDA MICKLEBURGH, EXAMINING ATTORNEY

SN 77-567,874. BEST CHICAGO MEAT COMPANY, LLC, CHICAGO, IL. FILED 9-11-2008.



THE MARK CONSISTS OF A STYLIZED DIAMOND WITH THE WORD "JEMM".

FOR MEAT (U.S. CL. 46).

FIRST USE 0-0-2006; IN COMMERCE 0-0-2006.

LINDA MICKLEBURGH, EXAMINING ATTORNEY

CLASS 29—(Continued).

SN 77-576,055. IBE BUSINESS ENTERPRISE AG, ZUG, SWITZERLAND, FILED 9-22-2008.

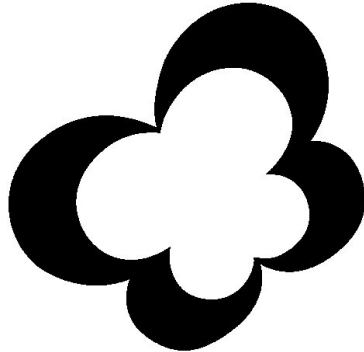

OWNER OF U.S. REG. NOS. 2,829,118, 3,319,712 AND 3,420,786.

THE MARK CONSISTS OF A STYLIZED FLOWER DESIGN.

FOR DAIRY PRODUCTS EXCLUDING ICE CREAM, ICE MILK AND FROZEN YOGURT (U.S. CL. 46).

JERI J. FICKES, EXAMINING ATTORNEY

SN 77-576,923. MCCAIN FOODS USA, INC., LISLE, IL. FILED 9-23-2008.

GET A BITE OF THIS!

THE MARK CONSISTS OF STANDARD CHARACTERS WITHOUT CLAIM TO ANY PARTICULAR FONT, STYLE, SIZE, OR COLOR.

FOR BREADED VEGETABLE AND CHEESE PIECES (U.S. CL. 46).

JAMES A. RAUEN, EXAMINING ATTORNEY

SN 77-577,603. MCCAIN FOODS USA, INC., LISLE, IL. FILED 9-24-2008.

JUST POP IT!

THE MARK CONSISTS OF STANDARD CHARACTERS WITHOUT CLAIM TO ANY PARTICULAR FONT, STYLE, SIZE, OR COLOR.

FOR BREADED VEGETABLE AND CHEESE PIECES (U.S. CL. 46).

JAMES A. RAUEN, EXAMINING ATTORNEY

CLASS 29—(Continued).

SN 77-578,822. THE DANNON COMPANY, INC., WHITE PLAINS, NY. FILED 9-25-2008.

DANIMALS

THE MARK CONSISTS OF STANDARD CHARACTERS WITHOUT CLAIM TO ANY PARTICULAR FONT, STYLE, SIZE, OR COLOR.

OWNER OF U.S. REG. NOS. 2,523,196, 2,898,247 AND 2,924,328.

FOR DAIRY PRODUCTS EXCLUDING ICE CREAM, ICE MILK AND FROZEN YOGURT (U.S. CL. 46).

WENDY GOODMAN, EXAMINING ATTORNEY

SN 77-581,162. SUPERVALU INC., EDEN PRAIRIE, MN. FILED 9-29-2008.

STOCKMAN & DAKOTA

THE MARK CONSISTS OF STANDARD CHARACTERS WITHOUT CLAIM TO ANY PARTICULAR FONT, STYLE, SIZE, OR COLOR.

FOR MEAT (U.S. CL. 46).

JILL PRATER, EXAMINING ATTORNEY

SN 77-585,986. CSC BRANDS LP, CAMDEN, NJ. FILED 10-6-2008.

HAPPYFULL

THE MARK CONSISTS OF STANDARD CHARACTERS WITHOUT CLAIM TO ANY PARTICULAR FONT, STYLE, SIZE, OR COLOR.

FOR SOUPS (U.S. CL. 46).

TRACY FLETCHER, EXAMINING ATTORNEY

CLASS 29—(Continued).

SN 77-596,288. CSC BRANDS LP, CAMDEN, NJ. FILED 10-20-2008.

BE HAPPYFULL

THE MARK CONSISTS OF STANDARD CHARACTERS WITHOUT CLAIM TO ANY PARTICULAR FONT, STYLE, SIZE, OR COLOR.

FOR SOUPS (U.S. CL. 46).
TRACY FLETCHER, EXAMINING ATTORNEY

SN 77-609,952. CSC BRANDS LP, CAMDEN, NJ. FILED 11-7-2008.

COULD'VE HAD A V8

THE MARK CONSISTS OF STANDARD CHARACTERS WITHOUT CLAIM TO ANY PARTICULAR FONT, STYLE, SIZE, OR COLOR.

OWNER OF U.S. REG. NO. 3,409,970.
FOR SOUPS (U.S. CL. 46).
TRACY FLETCHER, EXAMINING ATTORNEY

SN 78-942,654. MALTIN, ANDREW, STUDIO CITY, CA. FILED 8-1-2006.

SOUS CHEF

THE MARK CONSISTS OF STANDARD CHARACTERS WITHOUT CLAIM TO ANY PARTICULAR FONT, STYLE, SIZE, OR COLOR.

THE ENGLISH TRANSLATION OF THE WORD "SOUS CHEF" IN THE MARK IS "ASSISTANT" OR "SECOND COOK".

FOR FOODS, NAMELY, PREPARED INGREDIENTS CONSISTING PRIMARILY OF MEATS, FISH, POULTRY AND GAME, ASSEMBLED FOR COOKING AND/OR SERVING MEALS; MEAT EXTRACTS; FRUIT PRESERVES, DRIED AND COOKED FRUITS AND VEGETABLES; JELLIES, JAMS, EGGS; MILK; EDIBLE OILS AND FATS (U.S. CL. 46).

ROBIN CHOSID, EXAMINING ATTORNEY

CLASS 29—(Continued).

SN 79-053,437. LIDL STIFTUNG & CO. KG, FED REP GERMANY, FILED 4-16-2008.

FISCHERSTOLZ

THE MARK CONSISTS OF STANDARD CHARACTERS WITHOUT CLAIM TO ANY PARTICULAR FONT, STYLE, SIZE, OR COLOR.

PRIORITY DATE OF 1-23-2008 IS CLAIMED.
OWNER OF INTERNATIONAL REGISTRATION 0963229 DATED 4-16-2008, EXPIRES 4-16-2018.

OWNER OF U.S. REG. NO. 3,029,381.
THE FOREIGN WORDING IN THE MARK TRANSLATES INTO ENGLISH AS FISHERMAN'S PRIDE.

FOR FISH AND FISH PRODUCTS, NAMELY, DEEP-FROZEN FISH, PROCESSED FISH; FISH PRESERVES, PREPARED MEALS, MAINLY CONSISTING OF FISH, FISH SALADS (U.S. CL. 46).

EVLYN BRADLEY, EXAMINING ATTORNEY

SN 79-054,343. LES FROMAGERS DU MONT ROYAL, FRANCE, FILED 4-9-2008.

LE NAPOLEON COMMINGEOIS

THE MARK CONSISTS OF STANDARD CHARACTERS WITHOUT CLAIM TO ANY PARTICULAR FONT, STYLE, SIZE, OR COLOR.

OWNER OF INTERNATIONAL REGISTRATION 0965618 DATED 4-9-2008, EXPIRES 4-9-2018.

NO CLAIM IS MADE TO THE EXCLUSIVE RIGHT TO USE "COMMINGEOIS", APART FROM THE MARK AS SHOWN.

THE ENGLISH TRANSLATION OF "LE NAPOLEON COMMINGEOIS" IS "THE NAPOLEON FROM THE COMMINGES".

FOR EGGS; MILK; DAIRY PRODUCTS EXCLUDING ICE CREAM, ICE MILK AND FROZEN YOGURT; BUTTER; CHEESES; MILK BEVERAGES WITH MILK PREDOMINATING, NAMELY, MILK BEVERAGES CONTAINING FRUITS, SOYA MILK AND RICE MILK FOR USE AS A MILK SUBSTITUTE (U.S. CL. 46).

DAVID YONTEF, EXAMINING ATTORNEY

SN 79-054,641. H-W-K; BESITZGESELLSCHAFT MBH & CO. KG, FED REP GERMANY, FILED 4-25-2008.

Consul

THE MARK CONSISTS OF STANDARD CHARACTERS WITHOUT CLAIM TO ANY PARTICULAR FONT, STYLE, SIZE, OR COLOR.

PRIORITY DATE OF 10-29-2007 IS CLAIMED.
OWNER OF INTERNATIONAL REGISTRATION 0966504 DATED 4-25-2008, EXPIRES 4-25-2018.

FOR CHEESE (U.S. CL. 46).
TINA BROWN, EXAMINING ATTORNEY

CLASS 30—STAPLE FOODS

SN 77-246,436. DOUGHNUT PLANT INC., NEW YORK, NY. FILED 8-3-2007.



OWNER OF U.S. REG. NO. 2,975,284.
 NO CLAIM IS MADE TO THE EXCLUSIVE RIGHT TO USE "DOUGHNUT" AND "NEW YORK CITY", APART FROM THE MARK AS SHOWN.
 THE MARK CONSISTS OF AN OUTLINE OF AN OUTER AND LARGER CIRCLE AROUND A SMALLER, CENTERED SOLID CIRCLE. FROM THE MIDDLE OF THE RIGHT SIDE OF THE LARGER CIRCLE, A HORIZONTAL LINE EMERGES AND IS DRAWN ACROSS TO THE RIGHT. ABOVE THE LINE ARE THE WORDS "DOUGHNUT PLANT" IN STYLIZED LETTERS. BENEATH THE LINE ARE THE WORDS "NEW YORK CITY" IN STYLIZED LETTERS.

FOR DOUGHNUTS; BAKERY PRODUCTS; SWEET DOUGH FOODSTUFFS; SAVORY DOUGH FOODSTUFFS; COOKIES WITH FRUIT, VEGETABLE, DAIRY, NUT, SEED, LEGUME, GRAIN, COCOA, SUGAR, OR SALT; CAKES; ROLLS; BREADS; BAGELS; PIES; MUFFINS; PLAIN, SAVORY, SWEET, GLAZED, COATED, FILLED, FRIED, DEEP FRIED, BAKED, COOKED, STEAMED, BOILED AND/OR RAW GOODS, NAMELY, CAKES, PIES, PASTRIES, PATTIES, COOKIES, DOUGHNUTS, BAKERY PRODUCTS, SWEET DOUGH-BASED FOODSTUFFS, AND SAVORY DOUGH-BASED FOODSTUFFS; FILLINGS AND TOPPING OF OR BASED ON GRAIN, COCOA AND CHOCOLATE FOR CAKES, PIES, PASTRIES, PATTIES, COOKIES, DOUGHNUTS, BAKERY PRODUCTS, CRUSTS, SWEET DOUGHS AND SAVORY DOUGHS, SWEET DOUGH-BASED FOODSTUFFS, AND SAVORY DOUGH-BASED FOODSTUFFS; FLOUR; FLAVORING EXTRACTS; CONFECTIONERY CHIPS FOR BAKING; HONEY; YEAST; BAKING POWDER; COFFEE; TEA; COCOA (U.S. CL. 46).
 FIRST USE 12-1-2000; IN COMMERCE 12-1-2000.
 SETH A. RAPPAPORT, EXAMINING ATTORNEY

SN 77-390,290. CHESTER A. ASHER, INC., SOUDERTON, PA. FILED 2-6-2008.

ASHER'S CHOCOLATES

THE MARK CONSISTS OF STANDARD CHARACTERS WITHOUT CLAIM TO ANY PARTICULAR FONT, STYLE, SIZE, OR COLOR.
 OWNER OF U.S. REG. NOS. 2,385,193, 2,752,184 AND OTHERS.
 NO CLAIM IS MADE TO THE EXCLUSIVE RIGHT TO USE "CHOCOLATES", APART FROM THE MARK AS SHOWN.
 FOR CHOCOLATE CANDIES; CANDY BARS; SUGARLESS CANDIES (U.S. CL. 46).
 FIRST USE 0-0-1975; IN COMMERCE 0-0-1975.
 TARA PATE, EXAMINING ATTORNEY

CLASS 30—(Continued).

SN 77-402,048. AJMERA, JAY K, DBA AJMERA INNOVATIONS, ANAHEIM, CA. FILED 2-20-2008.

xpress chai, XPRESS CHAI

THE MARK CONSISTS OF STANDARD CHARACTERS WITHOUT CLAIM TO ANY PARTICULAR FONT, STYLE, SIZE, OR COLOR.
 NO CLAIM IS MADE TO THE EXCLUSIVE RIGHT TO USE "CHAI", APART FROM THE MARK AS SHOWN.
 FOR INSTANT TEA (U.S. CL. 46).
 LINDA ORNDORFF, EXAMINING ATTORNEY

SN 77-402,542. STRAUSS HEALTH LTD., PETACH TIKVA, ISRAEL, FILED 2-21-2008.



OWNER OF U.S. REG. NO. 2,628,298.
 THE MARK CONSISTS OF THE WORD "MILKY" IN STYLIZED LETTERING.
 FOR DESSERT PUDDINGS (U.S. CL. 46).
 FIRST USE 0-0-2003; IN COMMERCE 0-0-2003.
 LINDA M. KING, EXAMINING ATTORNEY

SN 77-410,052. LAMOTTA, RICHARD, MOUNT KISCO, NY. FILED 2-29-2008.

A MIRACLE IN YOUR MOUTH

THE MARK CONSISTS OF STANDARD CHARACTERS WITHOUT CLAIM TO ANY PARTICULAR FONT, STYLE, SIZE, OR COLOR.
 FOR EMPANADAS (U.S. CL. 46).
 DAVID MURRAY, EXAMINING ATTORNEY

CLASS 30—(Continued).

SN 77-413,318. EMERALD POINT LLC, DBA EMERALD CITY TEA, CINCINNATI, OH. FILED 3-5-2008.

Green Tea...it's not just
for cups anymore!

THE MARK CONSISTS OF STANDARD CHARACTERS WITHOUT CLAIM TO ANY PARTICULAR FONT, STYLE, SIZE, OR COLOR.

FOR GREEN TEA; JAPANESE GREEN TEA; TEA; BEVERAGES MADE OF TEA; COFFEE AND TEA; HERB TEA; HERBAL TEA; ICED TEA; INSTANT TEA; TEA FOR INFUSIONS (U.S. CL. 46).

FIRST USE 11-26-2007; IN COMMERCE 11-26-2007.
ARETHA SOMERVILLE, EXAMINING ATTORNEY

CLASS 30—(Continued).

SN 77-451,768. WHOLE EARTH SWEETENER COMPANY LLC, CHICAGO, IL. FILED 4-18-2008.



SN 77-418,079. SAVORY SPICE SHOP, INC., DENVER, CO. FILED 3-10-2008.



NO CLAIM IS MADE TO THE EXCLUSIVE RIGHT TO USE "SPICE SHOP", APART FROM THE MARK AS SHOWN. THE COLOR(S) BURGUNDY IS/ARE CLAIMED AS A FEATURE OF THE MARK.

THE MARK CONSISTS OF THE WORD "SAVORY" IN THE FENICE LIGHT FONT ABOVE THE SMALLER WORDS "SPICE SHOP" IN ARIAL FONT. ALL WORDS ARE IN THE BURGUNDY COLOR.

FOR SPICES; PROCESSED HERBS NOT WITHIN THE GENUS SATUREJA; AND SPICE BLENDS (U.S. CL. 46).
FIRST USE 9-15-2002; IN COMMERCE 9-15-2004.
WANDA KAY PRICE, EXAMINING ATTORNEY

THE COLOR(S) LIGHT GREEN, DARK GREEN AND BROWN IS/ARE CLAIMED AS A FEATURE OF THE MARK.

THE MARK CONSISTS OF ROUNDED LIGHT AND DARK GREEN LEAF DESIGN TO THE LEFT OF THE WORDS "PUREVIA" IN BROWN WITH A LIGHT GREEN LEAF DOTTING THE "I" IN "PUREVIA".

FOR SUGAR SUBSTITUTE, BEING A NATURAL TABLETOP SWEETENER; TABLETOP SWEETENER, BEING A NATURAL SWEETENER (U.S. CL. 46).
CAROLYN CATALDO, EXAMINING ATTORNEY

SN 77-422,619. MERZ APOTHECARY, INC., CHICAGO, IL. FILED 3-14-2008.

SMALLFLOWER

THE MARK CONSISTS OF STANDARD CHARACTERS WITHOUT CLAIM TO ANY PARTICULAR FONT, STYLE, SIZE, OR COLOR.

OWNER OF U.S. REG. NOS. 2,370,678 AND 2,370,682.
FOR TEAS (U.S. CL. 46).
FIRST USE 4-0-2005; IN COMMERCE 4-0-2005.
LESLIE RICHARDS, EXAMINING ATTORNEY

SN 77-453,696. WHOLE EARTH SWEETENER COMPANY LLC, CHICAGO, IL. FILED 4-21-2008.

PUREVIA

THE MARK CONSISTS OF STANDARD CHARACTERS WITHOUT CLAIM TO ANY PARTICULAR FONT, STYLE, SIZE, OR COLOR.

FOR SUGAR SUBSTITUTE, BEING A NATURAL TABLETOP SWEETENER; TABLETOP SWEETENER, BEING A NATURAL SWEETENER (U.S. CL. 46).
CAROLYN CATALDO, EXAMINING ATTORNEY

CLASS 30—(Continued).

SN 77-453,716. WHOLE EARTH SWEETENER COMPANY LLC, CHICAGO, IL. FILED 4-21-2008.



THE COLOR(S) LIGHT GREEN, DARK GREEN AND BROWN IS/ARE CLAIMED AS A FEATURE OF THE MARK.

THE MARK CONSISTS OF THE WORDS "PURE VIA" IN BROWN LETTERING INSIDE A ROUND LIGHT GREEN AND DARK GREEN LEAF DESIGN.

FOR SUGAR SUBSTITUTE, BEING A NATURAL TABLETOP SWEETENER; TABLETOP SWEETENER, BEING A NATURAL SWEETENER (U.S. CL. 46).
CAROLYN CATALDO, EXAMINING ATTORNEY

CLASS 30—(Continued).

SN 77-469,848. COLOMBINA S.A., ZARZAL, VALLE, COLOMBIA, FILED 5-8-2008.



FOR CANDY MINTS AND SUGAR FREE CHEWING GUMS (U.S. CL. 46).

REBECCA EISINGER, EXAMINING ATTORNEY

SN 77-461,502. AVEC ERIC, LLC, NEW YORK, NY. FILED 4-30-2008.

AVEC ERIC

THE MARK CONSISTS OF STANDARD CHARACTERS WITHOUT CLAIM TO ANY PARTICULAR FONT, STYLE, SIZE, OR COLOR.

THE ENGLISH TRANSLATION OF "AVEC" IS "WITH".
FOR DESSERT SOUFFLES; FROZEN DESSERTS CONSISTING OF TARTS, PUDDINGS, PIES AND CAKES; TARTS; BAGUETTES; READY-MADE SAUCES; FLAVORED VINEGAR; SALAD DRESSINGS; MUSTARD; CHUTNEY; GLAZE; SPICES; CRACKERS; FROZEN APETIZERS CONSISTING PRIMARILY OF PASTA OR RICE; AND PREPACKAGED MEAL KITS CONSISTING PRIMARILY OF ONE OR MORE OF THE FOLLOWING, PASTA OR RICE (U.S. CL. 46).

LESLIE RICHARDS, EXAMINING ATTORNEY

SN 77-470,496. ABERCROMBIE & FITCH TRADING CO., NEW ALBANY, OH. FILED 5-9-2008.

HOLLISTER

THE MARK CONSISTS OF STANDARD CHARACTERS WITHOUT CLAIM TO ANY PARTICULAR FONT, STYLE, SIZE, OR COLOR.

OWNER OF U.S. REG. NOS. 2,774,426, 3,358,499 AND OTHERS.

FOR CANDY MINTS (U.S. CL. 46).

FIRST USE 9-30-2007; IN COMMERCE 9-30-2007.

ANNE E. GUSTASON, EXAMINING ATTORNEY

SN 77-466,806. INNOVATIVE DELIGHTS LLC, EAST MEADOW, NY. FILED 5-6-2008.

INNOVATIVE DELIGHTS FOR THE GOURMET AT HEART

THE MARK CONSISTS OF STANDARD CHARACTERS WITHOUT CLAIM TO ANY PARTICULAR FONT, STYLE, SIZE, OR COLOR.

FOR SAUCES; DRY SPICE RUB FOR MEATS, FISH, AND POULTRY (U.S. CL. 46).

KELLY MCCOY, EXAMINING ATTORNEY

SN 77-486,261. LESAFFRE ET COMPAGNIE, PARIS, FRANCE, FILED 5-29-2008.

GUSTAL

THE MARK CONSISTS OF STANDARD CHARACTERS WITHOUT CLAIM TO ANY PARTICULAR FONT, STYLE, SIZE, OR COLOR.

OWNER OF ERPNCMNTY TM OFC REG. NO. 005821004, DATED 3-7-2008, EXPIRES 4-10-2017.

FOR PREPARATIONS FOR MAKING BAKERY PRODUCTS, NAMELY, YEASTS AND FLAVORINGS IN THE NATURE OF SOURDOUGHS; BREAD IMPROVERS AND INGREDIENTS FOR MAKING BREAD, NAMELY, FLAVORINGS IN THE NATURE OF SALT REDUCERS (U.S. CL. 46).

JOHN GARTNER, EXAMINING ATTORNEY

CLASS 30—(Continued).

SN 77-505,169. MOMMA REINER'S FUDGE, LLC, PACIFIC PALISADES, CA. FILED 6-23-2008.



NO CLAIM IS MADE TO THE EXCLUSIVE RIGHT TO USE "FUDGE", APART FROM THE MARK AS SHOWN.

THE NAME(S), PORTRAIT(S), AND/OR SIGNATURE(S) SHOWN IN THE MARK IDENTIFIES MOMMA REINER, WHOSE CONSENT(S) TO REGISTER IS SUBMITTED.

THE MARK CONSISTS OF A CIRCLE WITH THE STYLIZED WORDS "MOMMA REINER'S FUDGE HOMEMADE IN A LITTLE KITCHEN ON A LITTLE STREET IN A LITTLE VILLAGE BY THE SEA WWW.MOMMAREINER.COM" INSIDE. AROUND THE OUTSIDE OUTLINE OF THE CIRCLE ARE DOTS THAT WRAP AROUND THE WHOLE CIRCLE.

FOR FUDGE, NAMELY, FUDGE, FUDGE DIPPED MARSHMALLOWS, AND FUDGE BASED READY TO EAT CANDIES AND SNACKS (U.S. CL. 46).

FIRST USE 1-21-2005; IN COMMERCE 1-21-2005.
SUZANNE BLANE, EXAMINING ATTORNEY

SN 77-506,559. R VENTURES, DBA FASTA & SALAD CO., STATE COLLEGE, PA. FILED S.R. 6-24-2008; AM. P.R. 12-10-2008.



NO CLAIM IS MADE TO THE EXCLUSIVE RIGHT TO USE "CO.", APART FROM THE MARK AS SHOWN.

THE COLOR(S) BLACK, ORANGE IS/ARE CLAIMED AS A FEATURE OF THE MARK.

THE MARK CONSISTS OF "FASTA & SALAD CO." IN BLACK LETTERING WITH THIN SPIRALING ORANGE YELLOW SPAGHETTI LIKE STRAINS CIRCLING "FASTA & SALAD CO."

FOR FRESH PASTA (U.S. CL. 46).
FIRST USE 5-4-2008; IN COMMERCE 5-4-2008.
JILL PRATER, EXAMINING ATTORNEY

CLASS 30—(Continued).

SN 77-509,076. THOMAS, CARROLL F., ABBEVILLE, LA. FILED 6-26-2008.

CAJUN POWER

NO CLAIM IS MADE TO THE EXCLUSIVE RIGHT TO USE "CAJUN", APART FROM THE MARK AS SHOWN.

THE MARK CONSISTS OF THE WORDS "CAJUN POWER" IN BANCO FONT.

FOR BAKING SPICES; BARBECUE SAUCE; BARBECUE SAUCE; CHICKEN WING SAUCE; CHILI SAUCE; CHUTNEYS; CINNAMON POWDER; CLOVE POWDER; CONDIMENT, NAMELY, PEPPER SAUCE; CRAB BOIL; DIPPING SAUCES; DRIED CHILI PEPPERS; DRY SPICE RUB FOR MEATS AND FISH; EDIBLE SPICES; FLAVOURINGS AND SEASONINGS; FOOD SEASONINGS; FRUIT SAUCES EXCLUDING CRANBERRY SAUCE AND APPLESAUCE; HOT PEPPER POWDER; HOT SAUCE; MAYONNAISE; MUSTARD; PASTA SAUCE; PEPPER; PEPPER POWDER; PEPPER SPICE; PICANTE SAUCE; PIZZA SAUCE; PROCESSED GARLIC FOR USE AS SEASONING; SALAD SAUCES; SAUCE MIXES; SAUCES; SAUCES FOR BARBECUED MEAT; SLOPPY JOE SAUCE; SOY SAUCE; SPAGHETTI SAUCE; SPICE BLENDS; SPICE RUBS; STEAK SAUCE; STEAK SEASONING; TACO SEASONING; TARTAR SAUCE; WORCESTERSHIRE SAUCE (U.S. CL. 46).

FIRST USE 3-1-1978; IN COMMERCE 3-1-1978.
KELLY MCCOY, EXAMINING ATTORNEY

SN 77-514,543. OSCAR ENTERPRISES, INC., STOCKTON, NJ. FILED 7-3-2008.

MURRAY'S MELTS

THE MARK CONSISTS OF STANDARD CHARACTERS WITHOUT CLAIM TO ANY PARTICULAR FONT, STYLE, SIZE, OR COLOR.

NO CLAIM IS MADE TO THE EXCLUSIVE RIGHT TO USE "MELTS", APART FROM THE MARK AS SHOWN.

FOR SANDWICHES, NAMELY, GOURMET AND TOASTED SANDWICHES WITH FRESH MEATS AND CHEESES (U.S. CL. 46).

TARA PATE, EXAMINING ATTORNEY

CLASS 30—(Continued).

SN 77-515,713. COMFORTING CONFECTIONS AND SAVORIES, NORTH WALES, PA. FILED 7-7-2008.



THE COLOR(S) BLUE AND GREY IS/ARE CLAIMED AS A FEATURE OF THE MARK.

THE MARK CONSISTS OF THE COLORS BLUE AND GREY, WITH THE COLOR BLUE APPEARING IN THE WORDING "B MORE TASTEFUL" AND THE COLOR GREY APPEARING IN THE SPOON.

FOR CAKES, PIES, PUDDINGS, AND SWEETS BASED ON TRADITIONAL FAMILY RECIPES, NAMELY, BAKERY DESSERTS AND SAVORIES IN THE NATURE OF MEAT AND VEGETABLE TURNOVERS (U.S. CL. 46).

FIRST USE 3-1-2006; IN COMMERCE 3-1-2006.
TRACY FLETCHER, EXAMINING ATTORNEY

SN 77-552,480. LEWIS, LYNETTE, FULLERTON, CA. FILED 8-21-2008.

Cake Divine

THE MARK CONSISTS OF STANDARD CHARACTERS WITHOUT CLAIM TO ANY PARTICULAR FONT, STYLE, SIZE, OR COLOR.

NO CLAIM IS MADE TO THE EXCLUSIVE RIGHT TO USE "CAKE", APART FROM THE MARK AS SHOWN.

FOR CAKES; CUP CAKES (U.S. CL. 46).
ESTHER A. BORSUK, EXAMINING ATTORNEY

SN 77-555,558. OS ASSET, INC., TAMPA, FL. FILED 8-26-2008.

Bloomin' Burger

THE MARK CONSISTS OF STANDARD CHARACTERS WITHOUT CLAIM TO ANY PARTICULAR FONT, STYLE, SIZE, OR COLOR.

OWNER OF U.S. REG. NOS. 1,532,205 AND 2,552,055.
NO CLAIM IS MADE TO THE EXCLUSIVE RIGHT TO USE "BURGER", APART FROM THE MARK AS SHOWN.

FOR HAMBURGER SANDWICHES (U.S. CL. 46).
FIRST USE 2-28-2008; IN COMMERCE 2-28-2008.
MARK SPARACINO, EXAMINING ATTORNEY

CLASS 30—(Continued).

SN 77-557,460. TOM LIALIOS, NORWALK, CT. FILED 8-27-2008.

COFFEE TO DIE FOR

THE MARK CONSISTS OF STANDARD CHARACTERS WITHOUT CLAIM TO ANY PARTICULAR FONT, STYLE, SIZE, OR COLOR.

NO CLAIM IS MADE TO THE EXCLUSIVE RIGHT TO USE "COFFEE", APART FROM THE MARK AS SHOWN.
FOR COFFEE (U.S. CL. 46).

MIDGE BUTLER, EXAMINING ATTORNEY

SN 77-559,776. AMC BURGERS, INC., SOUTHFIELD, MI. FILED 9-1-2008.

Dave's Sloppy BBQ

THE MARK CONSISTS OF STANDARD CHARACTERS WITHOUT CLAIM TO ANY PARTICULAR FONT, STYLE, SIZE, OR COLOR.

NO CLAIM IS MADE TO THE EXCLUSIVE RIGHT TO USE "BBQ", APART FROM THE MARK AS SHOWN.

FOR HAMBURGER SANDWICHES (U.S. CL. 46).
FIRST USE 1-11-2008; IN COMMERCE 1-11-2008.
FLORENTINA BLANDU, EXAMINING ATTORNEY

SN 77-559,781. AMC BURGERS, INC., SOUTHFIELD, MI. FILED 9-1-2008.

Train Wreck Burger

THE MARK CONSISTS OF STANDARD CHARACTERS WITHOUT CLAIM TO ANY PARTICULAR FONT, STYLE, SIZE, OR COLOR.

NO CLAIM IS MADE TO THE EXCLUSIVE RIGHT TO USE "BURGER", APART FROM THE MARK AS SHOWN.

FOR HAMBURGER SANDWICHES (U.S. CL. 46).
FIRST USE 1-11-2008; IN COMMERCE 1-11-2008.
FLORENTINA BLANDU, EXAMINING ATTORNEY

CLASS 30—(Continued).

SN 77-559,783. AMC BURGERS, INC., SOUTHFIELD, MI.
FILED 9-1-2008.

The Blues Burger

THE MARK CONSISTS OF STANDARD CHARACTERS WITHOUT CLAIM TO ANY PARTICULAR FONT, STYLE, SIZE, OR COLOR.

NO CLAIM IS MADE TO THE EXCLUSIVE RIGHT TO USE "BURGER", APART FROM THE MARK AS SHOWN. FOR HAMBURGER SANDWICHES (U.S. CL. 46). FIRST USE 1-11-2008; IN COMMERCE 1-11-2008. FLORENTINA BLANDU, EXAMINING ATTORNEY

SN 77-559,787. AMC BURGERS, INC., SOUTHFIELD, MI.
FILED 9-1-2008.

Railhouse Burger Sauce

THE MARK CONSISTS OF STANDARD CHARACTERS WITHOUT CLAIM TO ANY PARTICULAR FONT, STYLE, SIZE, OR COLOR.

NO CLAIM IS MADE TO THE EXCLUSIVE RIGHT TO USE "BURGER SAUCE", APART FROM THE MARK AS SHOWN.

FOR SAUCES (U.S. CL. 46).
FIRST USE 1-11-2008; IN COMMERCE 1-11-2008.
FLORENTINA BLANDU, EXAMINING ATTORNEY

SN 77-559,878. HERSHEY CHOCOLATE & CONFECTION-
ERY CORPORATION, WHEAT RIDGE, CO. FILED 9-2-
2008.

REGEN

THE MARK CONSISTS OF STANDARD CHARACTERS WITHOUT CLAIM TO ANY PARTICULAR FONT, STYLE, SIZE, OR COLOR.

THE FOREIGN WORDING IN THE MARK TRANSLATES INTO ENGLISH AS RAIN.

FOR COCOA-BASED READY-TO-EAT FOOD BARS (U.S. CL. 46).

ROBERT C. CLARK JR., EXAMINING ATTORNEY

CLASS 30—(Continued).

SN 77-560,983. R.M. PALMER COMPANY, READING, PA.
FILED 9-3-2008.

SHISH-KA-BUGS

THE MARK CONSISTS OF STANDARD CHARACTERS WITHOUT CLAIM TO ANY PARTICULAR FONT, STYLE, SIZE, OR COLOR.

FOR CANDY AND CHOCOLATES (U.S. CL. 46).
EMILY CHUO, EXAMINING ATTORNEY

SN 77-561,017. KELLOGG NORTH AMERICA COMPANY,
BATTLE CREEK, MI. FILED 9-3-2008.

RAISIN BRAN EXTRA!

THE MARK CONSISTS OF STANDARD CHARACTERS WITHOUT CLAIM TO ANY PARTICULAR FONT, STYLE, SIZE, OR COLOR.

OWNER OF U.S. REG. NOS. 2,331,098 AND 2,899,490.

NO CLAIM IS MADE TO THE EXCLUSIVE RIGHT TO USE "RAISIN BRAN", APART FROM THE MARK AS SHOWN.

FOR PROCESSED CEREAL-BASED FOOD TO BE USED AS A BREAKFAST FOOD, SNACK FOOD OR INGREDIENT FOR MAKING OTHER FOODS (U.S. CL. 46).

LYDIA BELZER, EXAMINING ATTORNEY

SN 77-561,133. PICANTE FOODS, LLC, BALTIMORE, MD.
FILED 9-3-2008.



NO CLAIM IS MADE TO THE EXCLUSIVE RIGHT TO USE "PICANTE FOODS" AND "HISPANIC INGREDIENTS", APART FROM THE MARK AS SHOWN.

THE MARK CONSISTS OF THE PHRASE "PICANTE FOODS" IN A LARGE FONT, WHICH IS STACKED OVER THE PHRASE "HISPANIC INGREDIENTS" WHICH IS OFFSET TO THE RIGHT AND IN A SMALLER FONT, TO THE LEFT OF THE TWO PHRASES IS A DESIGN ELEMENT THAT RESEMBLES THREE STYLIZED LEAVES DRAWN JOINED TOGETHER AT THEIR EDGES INTO A CIRCULAR SHAPE.

THE ENGLISH TRANSLATION OF THE WORD "PICANTE" IN THE MARK IS SPICY.

FOR DRIED CHILI PEPPERS; GARDEN HERBS, PRESERVED; HERB TEA; SPICES (U.S. CL. 46).

FIRST USE 9-1-2008; IN COMMERCE 9-1-2008.

KATHLEEN M. VANSTON, EXAMINING ATTORNEY

CLASS 30—(Continued).

SN 77-561,297. STRATEGIC BUSINESS GROUP LIMITED, CORP., MEDLEY, FL. FILED 9-3-2008.

WHITE MOUNTAIN

THE MARK CONSISTS OF STANDARD CHARACTERS WITHOUT CLAIM TO ANY PARTICULAR FONT, STYLE, SIZE, OR COLOR.

FOR REFINED SUGAR, WHITE SUGAR, POWDERED SUGAR, STANDARD SUGAR (U.S. CL. 46).
FIRST USE 4-21-2008; IN COMMERCE 4-21-2008.
ALYSSA STEEL, EXAMINING ATTORNEY

SN 77-561,980. CHOVI, S.L., BENIFAYO, SPAIN, FILED 9-4-2008.

CHOVI

THE MARK CONSISTS OF STANDARD CHARACTERS WITHOUT CLAIM TO ANY PARTICULAR FONT, STYLE, SIZE, OR COLOR.

FOR SAUCES, MAYONNAISE, KETCHUP AND MUSTARD (U.S. CL. 46).
COLLEEN DOMBROW, EXAMINING ATTORNEY

SN 77-562,579. BR IP HOLDER LLC, CANTON, MA. FILED 9-4-2008.



THE MARK CONSISTS OF THE WORDS "SCRAMBLED SCOOPS" IN OUTLINED OVERLAPPING LETTERS IN WHICH THE WORDS APPEAR ON A DIAGONAL WITH THE WORD "SCRAMBLED" ABOVE THE WORD "SCOOPS".
FOR CANDY (U.S. CL. 46).
JUDITH HELFMAN, EXAMINING ATTORNEY

CLASS 30—(Continued).

SN 77-562,875. LA BREA BAKERY, INC., VAN NUYS, CA. FILED 9-4-2008.



NO CLAIM IS MADE TO THE EXCLUSIVE RIGHT TO USE "BAKE AT HOME", APART FROM THE MARK AS SHOWN.

THE MARK CONSISTS OF THE WORDING "BAKE AT HOME" WITH THE WORD AT ENCASED IN A GRAPHIC RESEMBLING A SEAL.

FOR FROZEN BREADS (U.S. CL. 46).
DAVID MURRAY, EXAMINING ATTORNEY

SN 77-563,201. CHATEAU E.I.E.I.O., WINTER PARK, FL. FILED 9-5-2008.

Barkolate!!

THE MARK CONSISTS OF STANDARD CHARACTERS WITHOUT CLAIM TO ANY PARTICULAR FONT, STYLE, SIZE, OR COLOR.

FOR CANDY (U.S. CL. 46).
JASON LOTT, EXAMINING ATTORNEY

SN 77-564,053. CONGELADOS DEL SUR S.A., ROSARIO, ARGENTINA, FILED 9-7-2008.



THE MARK CONSISTS OF THE WORDS "MONDO FRIZZATTA" IN STYLIZED LETTERS INSIDE A COAT OF ARMS LIKE BANNER.

THE FOREIGN WORDING "MONDO" IN THE MARK TRANSLATES INTO ENGLISH AS WORLD. THE MARK "FRIZZATTA" HAS NO MEANING IN A FOREIGN LANGUAGE.

FOR BAKERY DESSERTS; BAKERY GOODS; BREAD AND PASTRY; BUNS; CAKES; CROISSANTS; ICED CAKES; MEAT TURNOVERS; PANINI; PASTA; PIES; PIZZA; ROLLS; SANDWICHES; TARTS (U.S. CL. 46).
EDWARD NELSON, EXAMINING ATTORNEY

CLASS 30—(Continued).

SN 77-564,336. ARTISAN CONFECTIONS COMPANY, HERSHEY, PA. FILED 9-8-2008.

DAGOBA

THE MARK CONSISTS OF STANDARD CHARACTERS WITHOUT CLAIM TO ANY PARTICULAR FONT, STYLE, SIZE, OR COLOR.

OWNER OF U.S. REG. NOS. 3,302,319, 3,461,083 AND OTHERS.

THE FOREIGN WORDING IN THE MARK TRANSLATES INTO ENGLISH AS "TEMPLE OF THE GODS."

FOR CHOCOLATE COVERED ROASTED COFFEE BEANS (U.S. CL. 46).

FIRST USE 12-31-2004; IN COMMERCE 12-31-2004.

JAMES STEIN, EXAMINING ATTORNEY

CLASS 30—(Continued).

SN 77-565,385. THE SUNSOFT CORPORATION, MIAMI, FL. FILED 9-9-2008.



THE MARK CONSISTS OF CIRCLE WITH A CHERUB-FACED GIRL WEARING A POKE-A-DOTTED HEAD SCARF OVER THE TERMS "TOMASA HEALTHY PASSION" INSIDE.

FOR FROZEN EMPANADAS FOR RETAIL AND FOOD SERVICES (U.S. CL. 46).

JAMES STEIN, EXAMINING ATTORNEY

SN 77-565,226. CURRYLOVE INC., LOS ANGELES, CA. FILED 9-9-2008.



NO CLAIM IS MADE TO THE EXCLUSIVE RIGHT TO USE "CURRY", APART FROM THE MARK AS SHOWN.

THE MARK CONSISTS OF THE STYLIZED TERMS "CURRY LOVE".

FOR ORGANIC CURRY SAUCES; SAUCES (U.S. CL. 46).

BARBARA BROWN, EXAMINING ATTORNEY

SN 77-565,511. CHOCOLATE CHIP HEAVEN, LLC, LANDRUM, SC. FILED 9-9-2008.



NO CLAIM IS MADE TO THE EXCLUSIVE RIGHT TO USE "CHOCOLATE CHIP", APART FROM THE MARK AS SHOWN.

THE COLOR(S) BLUE, LIGHT BROWN, DARK BROWN, WHITE AND YELLOW IS/ARE CLAIMED AS A FEATURE OF THE MARK.

THE MARK CONSISTS OF AN OVAL SHAPE HAVING A CENTRALLY LOCATED IMAGE OF A CHOCOLATE CHIP COOKIE WITH WHITE WINGS AND A YELLOW HALO THEREABOVE, FURTHER INCLUDING TWO WHITE CLOUDS THEREABOVE AND TWO WHITE CLOUDS THEREBELOW, AND ALSO INCLUDING THE WORDS "CHOCOLATE CHIP HEAVEN" ALONG A TOP PORTION OF THE MARK AND THE WORDS "PSALMS 34:8 OH, TASTE AND SEE THAT THE LORD IS GOOD" ALONG A BOTTOM PORTION OF THE MARK.

FOR BAKERY DESSERTS; CAKES; COOKIES (U.S. CL. 46).

DAVID TAYLOR, EXAMINING ATTORNEY

CLASS 30—(Continued).

SN 77-565,946. FLAVA PUFF, INC., PEMBROKE PINES, FL. FILED 9-9-2008.

FLAVA PUFF

THE MARK CONSISTS OF STANDARD CHARACTERS WITHOUT CLAIM TO ANY PARTICULAR FONT, STYLE, SIZE, OR COLOR.

OWNER OF U.S. REG. NOS. 3,008,138 AND 3,008,140. NO CLAIM IS MADE TO THE EXCLUSIVE RIGHT TO USE "PUFF", APART FROM THE MARK AS SHOWN. FOR CHEESE FLAVORED SNACKS, NAMELY, CHEESE CURLS; CHEESE FLAVORED SNACKS, NAMELY, PUFFED CHEESE BALLS; CORN-BASED SNACK FOODS; GRAIN-BASED SNACK FOODS; WHEAT-BASED SNACK FOODS (U.S. CL. 46). FIRST USE 3-1-2007; IN COMMERCE 3-1-2007. JASON LOTT, EXAMINING ATTORNEY

CLASS 30—(Continued).

SN 77-566,972. WING IT, INC., FALMOUTH, MA. FILED 9-10-2008.

WING IT

THE MARK CONSISTS OF STANDARD CHARACTERS WITHOUT CLAIM TO ANY PARTICULAR FONT, STYLE, SIZE, OR COLOR.

OWNER OF U.S. REG. NO. 1,524,746. FOR SAUCES (U.S. CL. 46). FIRST USE 12-0-1985; IN COMMERCE 12-0-1985. JENNY PARK, EXAMINING ATTORNEY

SN 77-565,959. LARRY HARMON PICTURES CORPORATION, HOLLYWOOD, CA. FILED 9-9-2008.



OWNER OF U.S. REG. NOS. 2,483,766, 2,547,531 AND 2,923,374. THE MARK CONSISTS OF THE HEAD OF A CLOWN. FOR CONFECTIONERY, NAMELY, CANDY, CHOCOLATE, FRUIT JELLIES, CANDIES, BUBBLE GUM, GUMBALLS, LOLLIPOPS, CAKES, PIES, COOKIES, AND CAKE DECORATIONS, ICE CREAM CONES; FROZEN CONFECTIONS; BREAKFAST CEREALS; CHEWING GUM (U.S. CL. 46). ANGELA M. MICHELI, EXAMINING ATTORNEY

SN 77-567,012. NGUYEN, BRUCE, SAN DIEGO, CA. FILED 9-10-2008.



THE MARK CONSISTS OF A YOGURT SWIRL WITH WINGS AND A HALO DESIGN. BELOW THERE IS THE STYLIZED TEXT "YOGURTHEAVEN". FOR FROZEN YOGURT; FROZEN YOGURT MIXES (U.S. CL. 46). GISELLE AGOSTO, EXAMINING ATTORNEY

SN 77-566,657. NE-MO'S BAKERY, INC., ESCONDIDO, CA. FILED 9-10-2008.

WHAT YOUR BODY NEEDS

THE MARK CONSISTS OF STANDARD CHARACTERS WITHOUT CLAIM TO ANY PARTICULAR FONT, STYLE, SIZE, OR COLOR. FOR BAKED GOODS, NAMELY, CAKES, BREADS, AND MUFFINS (U.S. CL. 46). HEATHER THOMPSON, EXAMINING ATTORNEY

SN 77-567,046. ALTERRA COFFEE ROASTERS, INC., MILWAUKEE, WI. FILED 9-10-2008.

ALTERRA

THE MARK CONSISTS OF STANDARD CHARACTERS WITHOUT CLAIM TO ANY PARTICULAR FONT, STYLE, SIZE, OR COLOR. OWNER OF U.S. REG. NO. 2,638,848. FOR BAKERY PRODUCTS; BAKERY DESSERTS (U.S. CL. 46). DANNEAN HETZEL, EXAMINING ATTORNEY

CLASS 30—(Continued).

SN 77-567,395. SUCESORES PEDRO CORTES, INC., SAN JUAN, PUERTO RICO, FILED 9-11-2008.



THE MARK CONSISTS OF A GIRL IN DRESS WITH AN ERASER IN HAND MAKING A MOTION AS THOUGH SHE IS WRITING ON A WALL, WITH A BASKET ON THE FLOOR NEXT TO HER.

FOR CHOCOLATE BARS; CHOCOLATE POWDER (U.S. CL. 46).

FIRST USE 12-15-1970; IN COMMERCE 12-15-1970.
JAMES STEIN, EXAMINING ATTORNEY

SN 77-567,417. SUCESORES PEDRO CORTES, INC., SAN JUAN, PUERTO RICO, FILED 9-11-2008.



THE MARK CONSISTS OF A GIRL WITH A ROUND GEOMETRICAL HEAD AND SHAPE WITH ERASER IN ONE HAND AND CHALK IN THE OTHER, IT APPEARS AS THOUGH SHE IS WRITING ON A WALL, WITH A BASKET AND AN UMBRELLA NEXT TO HER.

FOR CHOCOLATE BARS; CHOCOLATE POWDER (U.S. CL. 46).

JAMES STEIN, EXAMINING ATTORNEY

CLASS 30—(Continued).

SN 77-567,449. SUCESORES PEDRO CORTES, INC., SAN JUAN, PUERTO RICO, FILED 9-11-2008.



THE MARK CONSISTS OF A GIRL IN A DRESS WITH ERASER IN HAND MAKING A MOTION AS THOUGH SHE IS WRITING ON A WALL, WITH A BASKET AND UMBRELLA ON THE FLOOR NEXT TO HER.

FOR CHOCOLATE POWDER (U.S. CL. 46).
FIRST USE 3-14-2005; IN COMMERCE 3-14-2005.
JAMES STEIN, EXAMINING ATTORNEY

SN 77-567,595. COUNTRY CREATIONS OF THE ROCKIES, LLC, GREELEY, CO. FILED 9-11-2008.

Zimmbacker

THE MARK CONSISTS OF STANDARD CHARACTERS WITHOUT CLAIM TO ANY PARTICULAR FONT, STYLE, SIZE, OR COLOR.

FOR BAKERY GOODS (U.S. CL. 46).
KATHERINE E. HALMEN, EXAMINING ATTORNEY

SN 77-570,595. ARTISAN CONFECTIONS COMPANY, HER-SHEY, PA. FILED 9-16-2008.

SCHARFFEN BERGER

THE MARK CONSISTS OF STANDARD CHARACTERS WITHOUT CLAIM TO ANY PARTICULAR FONT, STYLE, SIZE, OR COLOR.

OWNER OF U.S. REG. NOS. 2,215,175, 3,479,426 AND OTHERS.

THE NAME(S), PORTRAIT(S), AND/OR SIGNATURE(S) SHOWN IN THE MARK DOES NOT IDENTIFY A PARTICULAR LIVING INDIVIDUAL.

FOR CHOCOLATE COVERED ROASTED COFFEE BEANS (U.S. CL. 46).

FIRST USE 2-28-2004; IN COMMERCE 2-28-2004.
JAMES STEIN, EXAMINING ATTORNEY

CLASS 30—(Continued).

SN 77-571,128. BR IP HOLDER LLC, CANTON, MA. FILED 9-16-2008.



THE MARK CONSISTS OF THE LETTERS "BR" IN WHICH THE INNER PORTIONS OF EACH LETTER FORM THE NUMBER "31", SITUATED ABOVE THE WORDS "BRIGHT CHOICES", ALL WITHIN A RECTANGLE AROUND THE SIDES OF WHICH EXTEND THE FIVE POINTS OF A STAR.

FOR ICE CREAM, FROZEN YOGURT, FROZEN CUSTARD, SHERBETS, SORBETS, AND ICES (U.S. CL. 46).
JUDITH HELFMAN, EXAMINING ATTORNEY

SN 77-587,049. ARTISAN CONFECTIONS COMPANY, HERSHEY, PA. FILED 10-7-2008.

SCHARFFEN BERGER

THE MARK CONSISTS OF STANDARD CHARACTERS WITHOUT CLAIM TO ANY PARTICULAR FONT, STYLE, SIZE, OR COLOR.

OWNER OF U.S. REG. NOS. 2,215,175, 3,479,426 AND OTHERS.

FOR CHOCOLATE COVERED COCOA NIBS (U.S. CL. 46).

FIRST USE 2-28-2004; IN COMMERCE 2-28-2004.
JAMES STEIN, EXAMINING ATTORNEY

SN 77-588,310. KAHALA FRANCHISE CORP., SCOTTSDALE, AZ. FILED 10-8-2008.

THE PIE WHO LOVED ME

THE MARK CONSISTS OF STANDARD CHARACTERS WITHOUT CLAIM TO ANY PARTICULAR FONT, STYLE, SIZE, OR COLOR.

FOR ICE CREAM; FROZEN CONFECTIONS CONSISTING PRIMARILY OF ICE CREAM CUSTOM-BLENDED WITH MIX-INS SUCH AS CANDY, FRUITS, AND/OR NUTS (U.S. CL. 46).

FIRST USE 5-31-2007; IN COMMERCE 5-31-2007.
MICHELE SWAIN, EXAMINING ATTORNEY

CLASS 30—(Continued).

SN 77-588,344. KAHALA FRANCHISE CORP., SCOTTSDALE, AZ. FILED 10-8-2008.

THAT'S HOW I ROLL

THE MARK CONSISTS OF STANDARD CHARACTERS WITHOUT CLAIM TO ANY PARTICULAR FONT, STYLE, SIZE, OR COLOR.

FOR ICE CREAM; FROZEN CONFECTIONS CONSISTING PRIMARILY OF ICE CREAM CUSTOM-BLENDED WITH MIX-INS SUCH AS CANDY, FRUITS, AND/OR NUTS (U.S. CL. 46).

FIRST USE 5-31-2007; IN COMMERCE 5-31-2007.
MICHELE SWAIN, EXAMINING ATTORNEY

SN 77-588,366. KAHALA FRANCHISE CORP., SCOTTSDALE, AZ. FILED 10-8-2008.

ALL LOVIN' NO OVEN

THE MARK CONSISTS OF STANDARD CHARACTERS WITHOUT CLAIM TO ANY PARTICULAR FONT, STYLE, SIZE, OR COLOR.

FOR ICE CREAM; FROZEN CONFECTIONS CONSISTING PRIMARILY OF ICE CREAM CUSTOM-BLENDED WITH MIX-INS SUCH AS CANDY, FRUITS, AND/OR NUTS (U.S. CL. 46).

FIRST USE 5-31-2007; IN COMMERCE 5-31-2007.
MICHELE SWAIN, EXAMINING ATTORNEY

SN 77-590,346. KELLOGG NORTH AMERICA COMPANY, BATTLE CREEK, MI. FILED 10-10-2008.

MADE FOR FUN

THE MARK CONSISTS OF STANDARD CHARACTERS WITHOUT CLAIM TO ANY PARTICULAR FONT, STYLE, SIZE, OR COLOR.

FOR TOASTER PASTRIES (U.S. CL. 46).
LYDIA BELZER, EXAMINING ATTORNEY

CLASS 30—(Continued).

SN 77-596,774. MARS, INCORPORATED, MCLEAN, VA.
FILED 10-21-2008.

**NAUGHTY, BUT NOT THAT
NAUGHTY**

THE MARK CONSISTS OF STANDARD CHARACTERS
WITHOUT CLAIM TO ANY PARTICULAR FONT, STYLE,
SIZE, OR COLOR.

FOR CONFECTIONERY, NAMELY, CANDY (U.S. CL.
46).
VERNA BETH RIRIE, EXAMINING ATTORNEY

SN 78-624,730. SAFINTER, S.A., BARCELONA, SPAIN,
FILED 5-6-2005.



PRIORITY CLAIMED UNDER SEC. 44(D) ON SPAIN
APPLICATION NO. 2648172, FILED 4-25-2005, REG. NO.
2.648.172, DATED 4-25-2005, EXPIRES 4-25-2015.

OWNER OF U.S. REG. NO. 2,822,274.
THE MARK CONSISTS OF A FLOWER DESIGN ABOVE
THE STYLIZED TERM "EL JARDIN".

THE FOREIGN WORDING IN THE MARK TRANSLATES
INTO ENGLISH AS THE GARDEN.

FOR SAFFRON FOR USE AS A SPICE (U.S. CL. 46).
STEPHEN AQUILA, EXAMINING ATTORNEY

SN 78-852,390. SAPPORO HOLDINGS LIMITED, CHRISTCH-
URCH, NEW ZEALAND, FILED 4-3-2006.

BUMPER BAR

THE MARK CONSISTS OF STANDARD CHARACTERS
WITHOUT CLAIM TO ANY PARTICULAR FONT, STYLE,
SIZE, OR COLOR.

PRIORITY CLAIMED UNDER SEC. 44(D) ON NEW
ZEALAND APPLICATION NO. 745221, FILED 3-27-2006.

NO CLAIM IS MADE TO THE EXCLUSIVE RIGHT TO
USE "BAR", APART FROM THE MARK AS SHOWN.

FOR BAR-SHAPED SNACK FOODS AND CONFEC-
TIONERY, NAMELY, READY TO EAT, CEREAL DER-
IVED FOOD BARS AND GRAIN-BASED FOOD BARS
ALSO CONTAINING CHOCOLATE, DRIED FRUITS
AND NUTS (U.S. CL. 46).

JEFF DEFORD, EXAMINING ATTORNEY

CLASS 30—(Continued).

SN 79-048,493. MOMONOYA HONPO CO., LTD., JAPAN,
FILED 8-2-2007.



PRIORITY DATE OF 2-28-2007 IS CLAIMED.
OWNER OF INTERNATIONAL REGISTRATION 0949521
DATED 8-2-2007, EXPIRES 8-2-2017.

NO CLAIM IS MADE TO THE EXCLUSIVE RIGHT TO
USE THE NON-LATIN JAPANESE CHARACTERS THAT
TRANSLITERATE TO "KAMAKURA", APART FROM THE
MARK AS SHOWN.

THE NON-LATIN CHARACTERS IN THE MARK TRANS-
LITERATE TO "KAMAKURA MINAMOTO KITCHOAN"
AND "KAMAKURA" IDENTIFIES A GEOGRAPHIC LOCA-
TION IN JAPAN AND "MINAMOTO KITCHOAN" DOES
NOT HAVE ANY MEANING IN ENGLISH.

FOR SUGARED BEANS (AMA-NATTO); PELLET-
SHAPED RICE CRACKERS (ARARE); RICE DUM-
PLINGS DRESSED WITH SWEET BEAN JAM (AN-
KORO); SOFT PIN-ROLLED CAKES OF POUNDED
RICE (GYUHI); RICE CRACKERS (SENBEI); SWEET
DUMPLINGS (DANGO); SWEAT BEAN JAM COATED
WITH SUGARED-BEAN BASED SOFT SHELL (NERI-
KIRI); JAPANESE STYLE STEAMED CAKES (MUSHI-
GASHI); SWEET POUNDED RICE CAKES (MOCHI-
GASHI); BEAN-JAM FILLED WAFERS (MONAKA);
YOHKAN, NAMELY, CANDY BARS IN THE NATURE
OF BARS OF SWEET JELLIED BEAN PASTE; DRIED
SUGAR CAKES OF RICE FLOUR (RAKUGAN);
STEAMED BUNS STUFFED WITH BEAN-JAM (MAN-
JU); CONFECTIONARIES MADE FROM AGAR JELLY,
NAMELY, KINGYOKUKAN CANDIES IN THE SHAPE
OF BARS, CUBES AND SPHERES; ICE CREAM; SHER-
BETS; CASTILIA SPONGE CAKES; SPONGE CAKES;
CAKES; COOKIES; PIES; BISCUITS; CONFECTIONARY,
NAMELY, FRUIT JELLIES; CHOCOLATE; BEAN JAM
BUNS; BUNS; AND POUNDED RICE CAKES (MOCHI)
(U.S. CL. 46).

Laura Hammel, Examining Attorney

SN 79-052,535. FERRERO S.P.A., ALBA (CN), ITALY, FILED
1-31-2008.

KINDER BUENO

THE MARK CONSISTS OF STANDARD CHARACTERS
WITHOUT CLAIM TO ANY PARTICULAR FONT, STYLE,
SIZE, OR COLOR.

PRIORITY DATE OF 8-1-2007 IS CLAIMED.

OWNER OF INTERNATIONAL REGISTRATION 0960609
DATED 1-31-2008, EXPIRES 1-31-2018.

OWNER OF U.S. REG. NOS. 1,114,978, 1,480,969 AND
OTHERS.

THE ENGLISH TRANSLATION OF "KINDER" AND
"BUENO" IN THE MARK IS "CHILDREN" AND "GOOD".
FOR CANDY (U.S. CL. 46).

James MacFarlane, Examining Attorney

CLASS 30—(Continued).

SN 79-053,346. TENÇO - TORREFACÇÃO E EMPACOTAMENTO DE CAFÉS, LDA., P-4470 MAIA, PORTUGAL, FILED 4-23-2008.

TENÇO

THE MARK CONSISTS OF STANDARD CHARACTERS WITHOUT CLAIM TO ANY PARTICULAR FONT, STYLE, SIZE, OR COLOR.

OWNER OF INTERNATIONAL REGISTRATION 0962955 DATED 4-23-2008, EXPIRES 4-23-2018.

THE MARK HAS NO MEANING IN A FOREIGN LANGUAGE.

FOR COFFEE, ARTIFICIAL COFFEE, TEA AND BEVERAGES MADE WITH COFFEE (U.S. CL. 46).

EVELYN BRADLEY, EXAMINING ATTORNEY

CLASS 31—(Continued).

SN 77-384,026. HILL'S PET NUTRITION, INC., TOPEKA, KS. FILED 1-30-2008.

IT'S NOT A MIRACLE. IT'S
THE POWER OF NUTRITION

THE MARK CONSISTS OF STANDARD CHARACTERS WITHOUT CLAIM TO ANY PARTICULAR FONT, STYLE, SIZE, OR COLOR.

FOR PET FOOD (U.S. CLS. 1 AND 46).

KIMBERLY FRYE, EXAMINING ATTORNEY

CLASS 31—NATURAL AGRICULTURAL PRODUCTS

SN 77-221,675. JOHN BODGER & SONS COMPANY, SOUTH EL MONTE, CA. FILED 7-3-2007.

TINY TUNIA

THE MARK CONSISTS OF STANDARD CHARACTERS WITHOUT CLAIM TO ANY PARTICULAR FONT, STYLE, SIZE, OR COLOR.

FOR LIVE PLANTS, NAMELY, PETUNIAS (U.S. CLS. 1 AND 46).

FIRST USE 4-1-2000; IN COMMERCE 4-1-2000.

MARIAM MAHMOUDI, EXAMINING ATTORNEY

SN 77-384,080. HILL'S PET NUTRITION, INC., TOPEKA, KS. FILED 1-30-2008.

THE POWER OF NUTRITION

THE MARK CONSISTS OF STANDARD CHARACTERS WITHOUT CLAIM TO ANY PARTICULAR FONT, STYLE, SIZE, OR COLOR.

FOR PET FOOD (U.S. CLS. 1 AND 46).

KIMBERLY FRYE, EXAMINING ATTORNEY

SN 77-273,564. MASTRONARDI PRODUCE LTD., SANTA BARBARA, CA. FILED 9-6-2007.

ANCIENT SWEETS

THE MARK CONSISTS OF STANDARD CHARACTERS WITHOUT CLAIM TO ANY PARTICULAR FONT, STYLE, SIZE, OR COLOR.

PRIORITY CLAIMED UNDER SEC. 44(D) ON CANADA APPLICATION NO. 1342435, FILED 4-5-2007, REG. NO. TMA716440, DATED 6-12-2008, EXPIRES 6-12-2023.

NO CLAIM IS MADE TO THE EXCLUSIVE RIGHT TO USE "SWEETS", APART FROM THE MARK AS SHOWN.

FOR FRESH PEPPERS; RAW PEPPERS; UNPROCESSED PEPPERS (U.S. CLS. 1 AND 46).

FIRST USE 4-30-2007; IN COMMERCE 4-30-2007.

MAUREEN DALL, EXAMINING ATTORNEY

SN 77-389,778. HEUGER, JOSEF, 49219 GLANDORF, FED REP GERMANY, FILED 2-6-2008.

PERCUSSION

THE MARK CONSISTS OF STANDARD CHARACTERS WITHOUT CLAIM TO ANY PARTICULAR FONT, STYLE, SIZE, OR COLOR.

PRIORITY CLAIMED UNDER SEC. 44(D) ON FED REP GERMANY APPLICATION NO. 30751447.1/3, FILED 8-6-2007, REG. NO. 30751447, DATED 1-11-2008, EXPIRES 8-6-2017.

FOR LIVE ORNAMENTAL PLANTS, LIVE CUTTINGS FROM YOUNG PLANTS, SEEDS AND LIVE PARTS OF ORNAMENTAL PLANTS USED FOR PROPAGATION PURPOSES (U.S. CLS. 1 AND 46).

SKYE YOUNG, EXAMINING ATTORNEY

CLASS 31—(Continued).

SN 77-401,075. COMPANION CARE LLC, FRANKLIN, TN.
FILED 2-20-2008.

NAN'S HOMEMADE STEW'S

THE MARK CONSISTS OF STANDARD CHARACTERS WITHOUT CLAIM TO ANY PARTICULAR FONT, STYLE, SIZE, OR COLOR.

NO CLAIM IS MADE TO THE EXCLUSIVE RIGHT TO USE "HOMEMADE STEWS", APART FROM THE MARK AS SHOWN.

THE NAME "HAN'S" IDENTIFIES A LIVING INDIVIDUAL WHOSE CONSENT IS OF RECORD.

FOR PET FOOD (U.S. CLS. 1 AND 46).
STEVEN PEREZ, EXAMINING ATTORNEY

CLASS 31—(Continued).

SN 77-453,600. LB BRANDS, LLC, PORT CLYDE, ME. FILED
4-21-2008.

LINDA BEAN'S

THE MARK CONSISTS OF STANDARD CHARACTERS WITHOUT CLAIM TO ANY PARTICULAR FONT, STYLE, SIZE, OR COLOR.

THE NAME(S), PORTRAIT(S), AND/OR SIGNATURE(S) SHOWN IN THE MARK IDENTIFIES LINDA L. BEAN, WHOSE CONSENT(S) TO REGISTER IS SUBMITTED.

FOR LIVE LOBSTER (U.S. CLS. 1 AND 46).
TIMOTHY FINNEGAN, EXAMINING ATTORNEY

SN 77-412,275. ACUCAREIRA ZILLO LORENZETTI S.A.,
SAO PAULO, BRAZIL, FILED 3-4-2008.



THE COLOR(S) PEACH AND BLACK IS/ARE CLAIMED AS A FEATURE OF THE MARK.

THE MARK CONSISTS OF THE TERM "POLYSORB. POLY" APPEARS IN THE COLOR PEACH. "SORB" APPEARS IN BLACK. A STYLIZED LETTER "O" IN THE COLOR PEACH APPEARS BEFORE THE TERM "POLYSORB".

FOR FOODS FOR ANIMALS (U.S. CLS. 1 AND 46).
G. MAYERSCHOFF, EXAMINING ATTORNEY

SN 77-453,629. LB BRANDS, LLC, PORT CLYDE, ME. FILED
4-21-2008.

LINDA BEAN'S PERFECT MAINE

THE MARK CONSISTS OF STANDARD CHARACTERS WITHOUT CLAIM TO ANY PARTICULAR FONT, STYLE, SIZE, OR COLOR.

NO CLAIM IS MADE TO THE EXCLUSIVE RIGHT TO USE "MAINE", APART FROM THE MARK AS SHOWN.

THE NAME(S), PORTRAIT(S), AND/OR SIGNATURE(S) SHOWN IN THE MARK IDENTIFIES LINDA L. BEAN, WHOSE CONSENT(S) TO REGISTER IS SUBMITTED.

FOR LIVE LOBSTER (U.S. CLS. 1 AND 46).
FIRST USE 10-31-2008; IN COMMERCE 10-31-2008.
TIMOTHY FINNEGAN, EXAMINING ATTORNEY

SN 77-414,076. INTERVET INC., MILLSBORO, DE. FILED 3-
5-2008.



OWNER OF U.S. REG. NOS. 1,520,254, 3,011,718 AND OTHERS.

NO CLAIM IS MADE TO THE EXCLUSIVE RIGHT TO USE "ANIMAL HEALTH", APART FROM THE MARK AS SHOWN.

THE COLOR(S) BLACK AND RED IS/ARE CLAIMED AS A FEATURE OF THE MARK.

THE MARK CONSISTS OF A STYLIZED "SP" IN RED TO THE LEFT OF THE BLACK WORDING "INTERVET SCHERING-PLOUGH ANIMAL HEALTH".

FOR NON-MEDICATED ADDITIVES FOR ANIMAL FEED (U.S. CLS. 1 AND 46).
REBECCA GILBERT, EXAMINING ATTORNEY

SN 77-485,920. DEUTSCHE SAATGUTGESELLSCHAFT
M.B.H. BERLIN, 12557 BERLIN, FED REP GERMANY,
FILED 5-29-2008.

SNOWBALL

THE MARK CONSISTS OF STANDARD CHARACTERS WITHOUT CLAIM TO ANY PARTICULAR FONT, STYLE, SIZE, OR COLOR.

FOR LIVING PLANTS AND NATURAL FLOWERS, EXCLUDING CAMPANULA, CAULIFLOWER, TOMATO, TURNIP AND BEAN PLANTS (U.S. CLS. 1 AND 46).

MARIA-VICTORIA SUAREZ, EXAMINING ATTORNEY

CLASS 31—(Continued).

SN 77-548,209. ACE TOMATO CO., INC., MANTECA, CA. FILED 8-15-2008.

GEORGE'S GEMS

THE MARK CONSISTS OF STANDARD CHARACTERS WITHOUT CLAIM TO ANY PARTICULAR FONT, STYLE, SIZE, OR COLOR.

THE NAME(S), PORTRAIT(S), AND/OR SIGNATURE(S) SHOWN IN THE MARK DOES NOT IDENTIFY A PARTICULAR LIVING INDIVIDUAL.

FOR FRESH FRUIT AND VEGETABLES (U.S. CLS. 1 AND 46).

BILL DAWE, EXAMINING ATTORNEY

CLASS 31—(Continued).

SN 77-556,179. NORTH AMERICAN GREEN, INC., EVANSVILLE, IN. FILED 8-26-2008.

STEEP SLOPE MATRIX

THE MARK CONSISTS OF STANDARD CHARACTERS WITHOUT CLAIM TO ANY PARTICULAR FONT, STYLE, SIZE, OR COLOR.

NO CLAIM IS MADE TO THE EXCLUSIVE RIGHT TO USE "STEEP SLOPE", APART FROM THE MARK AS SHOWN.

FOR SPRAY-ON MULCH FOR EROSION CONTROL (U.S. CLS. 1 AND 46).

EDWARD NELSON, EXAMINING ATTORNEY

SN 77-555,813. NORTH AMERICAN GREEN, INC., EVANSVILLE, IN. FILED 8-26-2008.

HYDRACM

THE MARK CONSISTS OF STANDARD CHARACTERS WITHOUT CLAIM TO ANY PARTICULAR FONT, STYLE, SIZE, OR COLOR.

FOR SPRAY-ON MULCH FOR EROSION CONTROL (U.S. CLS. 1 AND 46).

EDWARD NELSON, EXAMINING ATTORNEY

SN 77-556,185. NORTH AMERICAN GREEN, INC., EVANSVILLE, IN. FILED 8-26-2008.

VMACX RAPID REINFORCEMENT SYSTEM

THE MARK CONSISTS OF STANDARD CHARACTERS WITHOUT CLAIM TO ANY PARTICULAR FONT, STYLE, SIZE, OR COLOR.

OWNER OF U.S. REG. NO. 2,786,966.

NO CLAIM IS MADE TO THE EXCLUSIVE RIGHT TO USE "RAPID REINFORCEMENT SYSTEM", APART FROM THE MARK AS SHOWN.

FOR SPRAY-ON MULCH FOR EROSION CONTROL (U.S. CLS. 1 AND 46).

EDWARD NELSON, EXAMINING ATTORNEY

SN 77-556,165. NORTH AMERICAN GREEN, INC., EVANSVILLE, IN. FILED 8-26-2008.

EXTREME SLOPE MATRIX

THE MARK CONSISTS OF STANDARD CHARACTERS WITHOUT CLAIM TO ANY PARTICULAR FONT, STYLE, SIZE, OR COLOR.

NO CLAIM IS MADE TO THE EXCLUSIVE RIGHT TO USE "EXTREME SLOPE", APART FROM THE MARK AS SHOWN.

FOR SPRAY-ON MULCH FOR EROSION CONTROL (U.S. CLS. 1 AND 46).

EDWARD NELSON, EXAMINING ATTORNEY

SN 77-557,539. VIVEROS, BRENDA J., DBA JEST2DOGS, SHERMAN OAKS, CA. FILED 8-28-2008.

DelishOats

THE COLOR(S) BLACK, WHITE AND RED IS/ARE CLAIMED AS A FEATURE OF THE MARK.

THE MARK CONSISTS OF THE WORD "DELISHOATS" IN A HARRINGTON FONT IN BLACK LETTERING. THE "D" AND "O" ARE CAPITALIZED. A BLACK PAW DOTS THE "I". A RED HEART, OUTLINED IN BLACK, SITS INSIDE THE "O". A SMALL CREST OF WHITE APPEARS INSIDE THE RED HEART. ALL OTHER WHITE IS BACKGROUND AND NOT PART OF THE DESIGN.

FOR PET TREATS (U.S. CLS. 1 AND 46).

SIMON TENG, EXAMINING ATTORNEY

CLASS 31—(Continued).

SN 77-562,906. ANDERSON FEED COMPANY, DBA NUZU, CHANA, IL. FILED 9-4-2008.

NuZu

THE MARK CONSISTS OF STANDARD CHARACTERS WITHOUT CLAIM TO ANY PARTICULAR FONT, STYLE, SIZE, OR COLOR.

FOR ANIMAL FEED (U.S. CLS. 1 AND 46).
FIRST USE 7-29-2008; IN COMMERCE 9-2-2008.
SAIMA MAKHDOOM, EXAMINING ATTORNEY

SN 77-563,142. BARTELS BREEDING B.V., AALSMEER, NETHERLANDS, FILED 9-5-2008.

HALLOWEEN

THE MARK CONSISTS OF STANDARD CHARACTERS WITHOUT CLAIM TO ANY PARTICULAR FONT, STYLE, SIZE, OR COLOR.

FOR LIVE PLANTS; LIVING PLANTS (U.S. CLS. 1 AND 46).
JEFF DEFORD, EXAMINING ATTORNEY

SN 77-563,551. NATURALLY RECYCLED PROTEINS LLC, JOHNSTON, IA. FILED 9-5-2008.

NRP Eg'nFlavor

THE MARK CONSISTS OF STANDARD CHARACTERS WITHOUT CLAIM TO ANY PARTICULAR FONT, STYLE, SIZE, OR COLOR.

FOR ANIMAL FOODSTUFFS; NUTRITIONAL ADDITIVES FOR ANIMAL FOODSTUFFS, NOT FOR MEDICAL PURPOSES (U.S. CLS. 1 AND 46).
FIRST USE 8-4-2008; IN COMMERCE 8-4-2008.
TOBY BULLOFF, EXAMINING ATTORNEY

CLASS 31—(Continued).

SN 77-564,014. LAKESIDE PRODUCE, INC., LEAMINGTON, CANADA, FILED 9-6-2008.



NO CLAIM IS MADE TO THE EXCLUSIVE RIGHT TO USE "PRODUCE" OR "GREEN", APART FROM THE MARK AS SHOWN.

THE MARK CONSISTS OF A GLOBE AND STYLIZED LEAVES INTEGRATED WITH TEXT, "LAKESIDE PRODUCE GREEN FOCUS A BETTER PLAN FOR A BETTER PLANET".

FOR FRESH VEGETABLES, NAMELY, TOMATOES, PEPPERS AND CUCUMBERS (U.S. CLS. 1 AND 46).
ANGELA M. MICHELI, EXAMINING ATTORNEY

SN 77-564,015. LAKESIDE PRODUCE, INC., LEAMINGTON, CANADA, FILED 9-6-2008.

LAKESIDE PRODUCE GREEN FOCUS A BETTER PLAN FOR A BETTER PLANET

THE MARK CONSISTS OF STANDARD CHARACTERS WITHOUT CLAIM TO ANY PARTICULAR FONT, STYLE, SIZE, OR COLOR.

NO CLAIM IS MADE TO THE EXCLUSIVE RIGHT TO USE "PRODUCE GREEN", APART FROM THE MARK AS SHOWN.

FOR FRESH VEGETABLES, NAMELY, TOMATOES, PEPPERS AND CUCUMBERS (U.S. CLS. 1 AND 46).
ANGELA M. MICHELI, EXAMINING ATTORNEY

SN 77-565,774. NDSU RESEARCH FOUNDATION, FARGO, ND. FILED 9-9-2008.

Northern Tribute

THE MARK CONSISTS OF STANDARD CHARACTERS WITHOUT CLAIM TO ANY PARTICULAR FONT, STYLE, SIZE, OR COLOR.

FOR LIVE PLANTS, NAMELY, RIVER BIRCH, SPECIFICALLY BETULA NIGRA "DICKINSON" (U.S. CLS. 1 AND 46).

FIRST USE 7-24-2007; IN COMMERCE 7-24-2007.
SHAILA SETTLES, EXAMINING ATTORNEY

CLASS 31—(Continued).

SN 77-565,788. NDSU RESEARCH FOUNDATION, FARGO, ND. FILED 9-9-2008.

Prairie Spirit

THE MARK CONSISTS OF STANDARD CHARACTERS WITHOUT CLAIM TO ANY PARTICULAR FONT, STYLE, SIZE, OR COLOR.
 FOR LIVE PLANTS, NAMELY, JUNIPER, SPECIFICALLY JUNIPERUS X 'BISON' (U.S. CLS. 1 AND 46).
 FIRST USE 4-4-2006; IN COMMERCE 4-4-2006.
 SHAILA SETTLES, EXAMINING ATTORNEY

CLASS 31—(Continued).

SN 77-565,824. NDSU RESEARCH FOUNDATION, FARGO, ND. FILED 9-9-2008.

Northern Flare

THE MARK CONSISTS OF STANDARD CHARACTERS WITHOUT CLAIM TO ANY PARTICULAR FONT, STYLE, SIZE, OR COLOR.
 FOR LIVE PLANTS, NAMELY, SUGAR MAPLE, SPECIFICALLY ACER SACCHARUM 'SISSETON' (U.S. CLS. 1 AND 46).
 FIRST USE 2-19-2008; IN COMMERCE 2-19-2008.
 SHAILA SETTLES, EXAMINING ATTORNEY

SN 77-565,803. NDSU RESEARCH FOUNDATION, FARGO, ND. FILED 9-9-2008.

Spring Welcome

THE MARK CONSISTS OF STANDARD CHARACTERS WITHOUT CLAIM TO ANY PARTICULAR FONT, STYLE, SIZE, OR COLOR.
 FOR LIVE PLANTS, NAMELY, MAGNOLIA, SPECIFICALLY MAGNOLIA X LOEBNERI 'RUTH' (U.S. CLS. 1 AND 46).
 FIRST USE 5-12-2006; IN COMMERCE 5-12-2006.
 SHAILA SETTLES, EXAMINING ATTORNEY

SN 77-565,832. NDSU RESEARCH FOUNDATION, FARGO, ND. FILED 9-9-2008.

Prairie Stature

THE MARK CONSISTS OF STANDARD CHARACTERS WITHOUT CLAIM TO ANY PARTICULAR FONT, STYLE, SIZE, OR COLOR.
 FOR LIVE PLANTS, NAMELY, HYBRID OAK, SPECIFICALLY QUERCUS X BIMUNDORUM 'MIDWEST' (U.S. CLS. 1 AND 46).
 FIRST USE 4-20-2007; IN COMMERCE 4-20-2007.
 SHAILA SETTLES, EXAMINING ATTORNEY

SN 77-565,812. NDSU RESEARCH FOUNDATION, FARGO, ND. FILED 9-9-2008.

Royal Splendor

THE MARK CONSISTS OF STANDARD CHARACTERS WITHOUT CLAIM TO ANY PARTICULAR FONT, STYLE, SIZE, OR COLOR.
 FOR LIVE PLANTS, NAMELY, NORWAY SPRUCE, SPECIFICALLY PICEA ABIES 'NOEL' (U.S. CLS. 1 AND 46).
 FIRST USE 4-4-2006; IN COMMERCE 4-4-2006.
 SHAILA SETTLES, EXAMINING ATTORNEY

SN 77-566,859. KELLY FOODS CORPORATION, MEDINA, OH. FILED 9-10-2008.

NEVER USED IT, NEVER WILL

THE MARK CONSISTS OF STANDARD CHARACTERS WITHOUT CLAIM TO ANY PARTICULAR FONT, STYLE, SIZE, OR COLOR.
 FOR DOG FOOD, CAT FOOD, DOG TREATS, CAT TREATS, AND DOG BISCUITS (U.S. CLS. 1 AND 46).
 FIRST USE 7-31-2007; IN COMMERCE 9-30-2007.
 KRISTIN DAHLING, EXAMINING ATTORNEY

CLASS 31—(Continued).

SN 77-566,966. CARGILL, INCORPORATED, WAYZATA, MN. FILED 9-10-2008.



THE MARK CONSISTS OF THE WORDS "MEGA-BITE" IN A STYLIZED OVAL.
FOR ANIMAL FEED (U.S. CLS. 1 AND 46).
JUDITH HELFMAN, EXAMINING ATTORNEY

SN 77-567,251. KYJEN COMPANY, INC., THE, HUNTINGTON BEACH, CA. FILED 9-10-2008.

SPACE

THE MARK CONSISTS OF STANDARD CHARACTERS WITHOUT CLAIM TO ANY PARTICULAR FONT, STYLE, SIZE, OR COLOR.
FOR CAT LITTER (U.S. CLS. 1 AND 46).
FIRST USE 7-1-1998; IN COMMERCE 12-2-1998.
JESSICA A. POWERS, EXAMINING ATTORNEY

SN 77-581,806. CARGILL, INCORPORATED, WAYZATA, MN. FILED 9-30-2008.

BLING

THE MARK CONSISTS OF STANDARD CHARACTERS WITHOUT CLAIM TO ANY PARTICULAR FONT, STYLE, SIZE, OR COLOR.
FOR ANIMAL FEED (U.S. CLS. 1 AND 46).
JUDITH HELFMAN, EXAMINING ATTORNEY

CLASS 31—(Continued).

SN 77-590,481. MARS, INCORPORATED, MCLEAN, VA. FILED 10-10-2008.



THE MARK CONSISTS OF A PYRAMID WITH BUBBLES. FOR PET FOOD (U.S. CLS. 1 AND 46).
VERNA BETH RIRIE, EXAMINING ATTORNEY

CLASS 32—LIGHT BEVERAGES

SN 76-694,143. SPOETZL BREWERY, INC., SAN ANTONIO, TX. FILED 11-10-2008.

SHINER

THE MARK CONSISTS OF STANDARD CHARACTERS WITHOUT CLAIM TO ANY PARTICULAR FONT, STYLE, SIZE, OR COLOR.
FOR BEER (U.S. CLS. 45, 46 AND 48).
FIRST USE 12-31-1909; IN COMMERCE 12-31-1909.
GEOFFREY FOSDICK, EXAMINING ATTORNEY

SN 77-270,622. PATAGONIA MINERAL S.A., SANTIAGO, CHILE, FILED 9-4-2007.

AONNI

THE MARK CONSISTS OF STANDARD CHARACTERS WITHOUT CLAIM TO ANY PARTICULAR FONT, STYLE, SIZE, OR COLOR.
PRIORITY CLAIMED UNDER SEC. 44(D) ON CHILE APPLICATION NO. 787.117. FILED 8-31-2007, REG. NO. 818.888, DATED 6-6-2008, EXPIRES 6-6-2018.
FOR BOTTLED DRINKING WATER; MINERAL AND AERATED WATERS; TABLE WATERS; FLAVORED WATERS; STILL WATER; STILL WATERS; SPRING WATERS (U.S. CLS. 45, 46 AND 48).
GEOFFREY FOSDICK, EXAMINING ATTORNEY

CLASS 32—(Continued).

SN 77-312,916. STOKELY-VAN CAMP, INC., CHICAGO, IL. FILED 10-25-2007.



OWNER OF U.S. REG. NOS. 848,245, 1,852,801 AND OTHERS.

NO CLAIM IS MADE TO THE EXCLUSIVE RIGHT TO USE "THIRST QUENCHER", APART FROM THE MARK AS SHOWN.

THE STIPPLING IS FOR SHADING PURPOSES ONLY. THE MARK CONSISTS OF THE WORD "TIGER", WITH A REPRESENTATION OF A LIGHTNING BOLT DESIGN REPLACING THE I IN "TIGER", AND THE WORDS "GATORADE THIRST QUENCHER".

FOR NON-CARBONATED FRUIT FLAVORED SPORTS DRINKS (U.S. CLS. 45, 46 AND 48).

KAREN SEVERSON, EXAMINING ATTORNEY

CLASS 32—(Continued).

SN 77-389,674. ANHEUSER-BUSCH, INCORPORATED, ST. LOUIS, MO. FILED 2-6-2008.

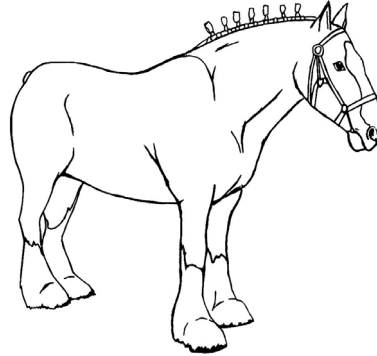

OWNER OF U.S. REG. NOS. 918,645, 3,238,974 AND OTHERS.

THE MARK CONSISTS OF A LIVE CLYDESDALE HORSE.

SEC. 2(F).

FOR BEER (U.S. CLS. 45, 46 AND 48).

FIRST USE 12-31-1980; IN COMMERCE 12-31-1980.

SHANNON TWOHIG, EXAMINING ATTORNEY

SN 77-374,345. SOUTH BEACH BEVERAGE COMPANY, INC., NORWALK, CT. FILED 1-17-2008.

THRILLICIOUS

THE MARK CONSISTS OF STANDARD CHARACTERS WITHOUT CLAIM TO ANY PARTICULAR FONT, STYLE, SIZE, OR COLOR.

FOR NON-ALCOHOLIC BEVERAGES, NAMELY, DRINKING WATER AND WATER ENHANCED WITH VITAMINS, MINERAL OR ANTIOXIDANTS (U.S. CLS. 45, 46 AND 48).

CYNTHIA TRIPI, EXAMINING ATTORNEY

SN 77-402,774. EVERETT A. HULL, BASKING RIDGE, NJ. FILED 2-21-2008.



THE MARK CONSISTS OF A CONFIGURATION OF A BEVERAGE CONTAINER HAVING ROUNDED EDGES AND CORNERS AND AN OVERALL FRONT TO BACK THICKNESS EXCEEDING ITS OVERALL WIDTH, AND HAVING A FRONT FACE AND BACK FACE THAT ARE

CLASS 32—(Continued).

SLIGHTLY CONVEX AND SYMMETRICAL ABOUT A PLANE BETWEEN THEM, THE RIGHT AND LEFT FACES BEING CONVEX, THE TOP OF THE CONTAINER BEING DIVIDED BETWEEN AN ANNULAR PLATEAU FOR RECEIVING A DISPENSING NOZZLE AND A ROUNDED HUMP WITH A ROUND FINGER HOLE PENETRATING FROM FRONT TO BACK. THE DRAWING INCLUDES BROKEN LINES WHICH ARE NOT PART OF THE MARK. THE BROKEN LINES ARE INCLUDED TO INDICATE THE POSITION OF A SPOUT RELATIVE TO THE MARK.

FOR BEVERAGES, NAMELY, DRINKING WATER, SPRING WATER, MINERAL WATER, GLACIAL WATER, STILL WATER, CARBONATED WATER, SODA WATER, SPARKLING WATER, FLAVOR INFUSED WATER, SPARKLING NATURAL MINERAL WATER, SUGAR FREE FLAVORED WATER, DRINKING WATER CONTAINING HERBAL AND DIETARY SUPPLEMENTS, FRUIT DRINKS, FRUIT JUICE, SPORTS DRINKS, FRUIT FLAVORED DRINKS, NON-ALCOHOLIC PUNCH, ISOTONIC DRINKS, SOFT DRINKS, SYRUPS AND CONCENTRATES FOR MAKING THE SAME, BOTTLED WATER, AND BEVERAGES IN FLASKS, NAMELY, DRINKING WATER, SPRING WATER, MINERAL WATER, GLACIAL WATER, STILL WATER, CARBONATED WATER, SODA WATER, SPARKLING WATER, FLAVOR INFUSED WATER, SPARKLING NATURAL MINERAL WATER, SUGAR FREE FLAVORED WATER, DRINKING WATER CONTAINING HERBAL AND DIETARY SUPPLEMENTS, FRUIT DRINKS, FRUIT JUICE, SPORTS DRINKS, FRUIT FLAVORED DRINKS, NON-ALCOHOLIC PUNCH, ISOTONIC DRINKS, AND SOFT DRINKS (U.S. CLS. 45, 46 AND 48).

JAY FLOWERS, EXAMINING ATTORNEY

SN 77-410,950. CERVECERIA MODELO, S.A. DE C.V., MEXICO, D.F., MEXICO, FILED 3-3-2008.

CORONA LIGHT

THE MARK CONSISTS OF STANDARD CHARACTERS WITHOUT CLAIM TO ANY PARTICULAR FONT, STYLE, SIZE, OR COLOR.

OWNER OF MEXICO REG. NO. 931936, DATED 4-27-2006, EXPIRES 3-27-2016.

OWNER OF U.S. REG. NOS. 662,347, 1,727,969 AND OTHERS.

NO CLAIM IS MADE TO THE EXCLUSIVE RIGHT TO USE "LIGHT", APART FROM THE MARK AS SHOWN.

THE FOREIGN WORDING IN THE MARK TRANSLATES INTO ENGLISH AS CROWN.

FOR BEER (U.S. CLS. 45, 46 AND 48).

CHRISTINA SOBRAL, EXAMINING ATTORNEY

CLASS 32—(Continued).

SN 77-428,619. BARD'S TALE BEER COMPANY, LLC, EDINA, MN. FILED 3-21-2008.



OWNER OF U.S. REG. NO. 3,211,334.

NO CLAIM IS MADE TO THE EXCLUSIVE RIGHT TO USE "BEER CO.", APART FROM THE MARK AS SHOWN.

THE MARK CONSISTS OF A REVERSED AND FORWARD FACING LETTER "B" BACK-TO-BACK ON A SHIELD WITH THE WORDS "BARD'S BEER CO."

FOR BEER (U.S. CLS. 45, 46 AND 48).

FIRST USE 11-30-2008; IN COMMERCE 11-30-2008.

NICHOLAS ALTREE, EXAMINING ATTORNEY

SN 77-499,272. LAKHI CHANDIRAMANI, DBA TASTE OF NATURE, INC, PARAMUS, NJ. FILED 6-14-2008.

**" BALI " Natural
Pure Water !**

THE MARK CONSISTS OF STANDARD CHARACTERS WITHOUT CLAIM TO ANY PARTICULAR FONT, STYLE, SIZE, OR COLOR.

NO CLAIM IS MADE TO THE EXCLUSIVE RIGHT TO USE "NATURAL PURE WATER", APART FROM THE MARK AS SHOWN.

FOR BOTTLED ARTESIAN WATER (U.S. CLS. 45, 46 AND 48).

KOURTNEE HODGES, EXAMINING ATTORNEY

CLASS 32—(Continued).

SN 77-534,375. HEALTHY BEVERAGE, LLC, WASHINGTON CROSSING, PA. FILED 7-30-2008.

TEAZIES

THE MARK CONSISTS OF STANDARD CHARACTERS WITHOUT CLAIM TO ANY PARTICULAR FONT, STYLE, SIZE, OR COLOR.

FOR NON-ALCOHOLIC BEVERAGES FLAVORED WITH TEA; SOFT DRINKS FLAVORED WITH TEA; NON-ALCOHOLIC SOFT DRINK BEVERAGES; CAFFEINATED SOFT DRINKS; DECAFFEINATED SOFT DRINKS; CARBONATED SOFT DRINK BEVERAGES; JUICE DRINKS; FRUIT JUICE BEVERAGES; HEALTH DRINKS, NAMELY, ENERGY DRINKS; SPORTS DRINKS; ISOTONIC DRINKS; STIMULANT DRINKS, NAMELY, ENERGY DRINKS; ENERGY DRINKS; SODA WATERS; ENERGY DRINK FLAVORED WITH GREEN TEA; LOW-CALORIE SOFT DRINKS; LOW-CALORIE JUICE DRINKS FLAVORED WITH TEA; LOW SUGAR, REDUCED SUGAR AND SUGAR FREE SOFT DRINKS (U.S. CLS. 45, 46 AND 48).

CHRISTINE COOPER, EXAMINING ATTORNEY

SN 77-545,868. PRIMO TO GO, LLC, WINSTON-SALEM, NC. FILED 8-13-2008.

TASTE PERFECTION IN A PERFECT BOTTLE.

THE MARK CONSISTS OF STANDARD CHARACTERS WITHOUT CLAIM TO ANY PARTICULAR FONT, STYLE, SIZE, OR COLOR.

FOR DRINKING WATER (U.S. CLS. 45, 46 AND 48). FIRST USE 8-0-2008; IN COMMERCE 8-0-2008. DAWN FELDMAN, EXAMINING ATTORNEY

SN 77-546,161. PRIMO TO GO, LLC, WINSTON-SALEM, NC. FILED 8-13-2008.

PRIMO TO GO

THE MARK CONSISTS OF STANDARD CHARACTERS WITHOUT CLAIM TO ANY PARTICULAR FONT, STYLE, SIZE, OR COLOR.

FOR DRINKING WATER (U.S. CLS. 45, 46 AND 48). DAWN FELDMAN, EXAMINING ATTORNEY

CLASS 32—(Continued).

SN 77-550,465. PERFIL CORPORATIVO, S.A. DE C.V., COL. BELLA VISTA, MEXICO, FILED 8-19-2008.



OWNER OF U.S. REG. NOS. 1,348,420, 3,401,755 AND OTHERS.

THE MARK CONSISTS OF THE WORDING "TRADICIONALES" WRITTEN IN A NARROW BANNER ABOVE THE WORDING "MUNDET", WHICH IS PLACED ON TOP OF AN OVAL-SHAPED DESIGN, AND A DARK EXTENSION OF THE BANNER IS PLACED BELOW "MUNDET".

THE ENGLISH TRANSLATION OF "TRADICIONALES MUNDET" IS TRADITIONAL MUNDET.

FOR MINERAL AND AERATED WATERS AND OTHER NON-ALCOHOLIC BEVERAGES, NAMELY, SOFT DRINKS AND FRUIT JUICES; SYRUPS AND OTHER PREPARATIONS FOR MAKING NON-ALCOHOLIC BEVERAGES, NAMELY, FRUIT DRINKS AND CARBONATED SOFT DRINKS (U.S. CLS. 45, 46 AND 48). RICHARD A. STRASER, EXAMINING ATTORNEY

SN 77-550,501. PERFIL CORPORATIVO, S.A. DE C.V., COL. BELLA VISTA, MEXICO, FILED 8-19-2008.

TRADICIONALES MUNDET

THE MARK CONSISTS OF STANDARD CHARACTERS WITHOUT CLAIM TO ANY PARTICULAR FONT, STYLE, SIZE, OR COLOR.

OWNER OF U.S. REG. NOS. 1,348,420, 3,401,755 AND OTHERS.

THE ENGLISH TRANSLATION OF "TRADICIONALES MUNDET" IS TRADITIONAL "MUNDET". THE WORDING "MUNDET" HAS NO TRANSLATION.

FOR MINERAL AND AERATED WATERS AND OTHER NON-ALCOHOLIC BEVERAGES, NAMELY, SOFT DRINKS AND FRUIT JUICES; SYRUPS AND OTHER PREPARATIONS FOR MAKING NON-ALCOHOLIC BEVERAGES, NAMELY, FRUIT DRINKS AND CARBONATED SOFT DRINKS (U.S. CLS. 45, 46 AND 48). RICHARD A. STRASER, EXAMINING ATTORNEY

CLASS 32—(Continued).

SN 77-561,954. DEVINE, JOSEPH P, HOUSTON, TX. FILED 9-4-2008.

H2ecO Water

THE MARK CONSISTS OF STANDARD CHARACTERS WITHOUT CLAIM TO ANY PARTICULAR FONT, STYLE, SIZE, OR COLOR.

NO CLAIM IS MADE TO THE EXCLUSIVE RIGHT TO USE "WATER", APART FROM THE MARK AS SHOWN.

FOR BOTTLED WATER (U.S. CLS. 45, 46 AND 48).

FIRST USE 8-12-2008; IN COMMERCE 9-2-2008.

KAREN BRACEY, EXAMINING ATTORNEY

CLASS 32—(Continued).

SN 77-564,473. ACE CANNING CORPORATION SDN. BHD, SELANGOR DARUL EHSAN, MALAYSIA, FILED 9-8-2008.

POWER MAX

THE MARK CONSISTS OF STANDARD CHARACTERS WITHOUT CLAIM TO ANY PARTICULAR FONT, STYLE, SIZE, OR COLOR.

FOR SOY-BASED BEVERAGES NOT BEING MILK SUBSTITUTES; ENERGY DRINKS (U.S. CLS. 45, 46 AND 48).

FIRST USE 6-6-2003; IN COMMERCE 10-9-2005.

HEATHER THOMPSON, EXAMINING ATTORNEY

SN 77-562,656. BEECH-NUT NUTRITION CORPORATION, LATHAM, NY. FILED 9-4-2008.

SMOOTHIE SURPRISE

THE MARK CONSISTS OF STANDARD CHARACTERS WITHOUT CLAIM TO ANY PARTICULAR FONT, STYLE, SIZE, OR COLOR.

NO CLAIM IS MADE TO THE EXCLUSIVE RIGHT TO USE "SMOOTHIE", APART FROM THE MARK AS SHOWN.

FOR FRUIT AND FRUIT-FLAVORED DRINKS AND BEVERAGES; VEGETABLE AND VEGETABLE-FLAVORED DRINKS AND BEVERAGES; SMOOTHIES (U.S. CLS. 45, 46 AND 48).

STEVEN R. FOSTER, EXAMINING ATTORNEY

SN 77-564,638. WHITEWAVE FOODS COMPANY, BROOM-FIELD, CO. FILED 9-8-2008.

CRISP, REFRESHING ENERGY TO HELP GET YOU THROUGH THE DAY.

THE MARK CONSISTS OF STANDARD CHARACTERS WITHOUT CLAIM TO ANY PARTICULAR FONT, STYLE, SIZE, OR COLOR.

FOR NON-ALCOHOLIC BEVERAGES CONTAINING FRUIT JUICES (U.S. CLS. 45, 46 AND 48).

KEVIN DINALLO, EXAMINING ATTORNEY

SN 77-563,707. DUCLAW BREWERY, LLC, BEL AIR, MD. FILED 9-5-2008.

False Prophet

THE MARK CONSISTS OF STANDARD CHARACTERS WITHOUT CLAIM TO ANY PARTICULAR FONT, STYLE, SIZE, OR COLOR.

FOR BEER, ALE AND PORTER (U.S. CLS. 45, 46 AND 48).

KATHERINE E. HALMEN, EXAMINING ATTORNEY

SN 77-564,648. WHITEWAVE FOODS COMPANY, BROOM-FIELD, CO. FILED 9-8-2008.

TAKE BACK THE AFTERNOON

THE MARK CONSISTS OF STANDARD CHARACTERS WITHOUT CLAIM TO ANY PARTICULAR FONT, STYLE, SIZE, OR COLOR.

FOR NON-ALCOHOLIC BEVERAGES CONTAINING FRUIT JUICES (U.S. CLS. 45, 46 AND 48).

KEVIN DINALLO, EXAMINING ATTORNEY

CLASS 32—(Continued).

SN 77-564,852. SPOETZL BREWERY, INC., SAN ANTONIO, TX. FILED 9-8-2008.

COMMEMORATOR

THE MARK CONSISTS OF STANDARD CHARACTERS WITHOUT CLAIM TO ANY PARTICULAR FONT, STYLE, SIZE, OR COLOR.
FOR BEER (U.S. CLS. 45, 46 AND 48).
GEOFFREY FOSDICK, EXAMINING ATTORNEY

CLASS 32—(Continued).

SN 77-565,556. DICENZO, GUY P., MATTHEWS, NC. FILED 9-9-2008.



THE MARK CONSISTS OF THE TEXT "BUDWINE" WRITTEN IN A STYLIZED SCRIPT FONT, ON A STYLIZED BACKGROUND WITH ROUNDED EDGES.
FOR SOFT DRINKS (U.S. CLS. 45, 46 AND 48).
MARK SHINER, EXAMINING ATTORNEY

SN 77-564,980. BREWCRAFT USA, LLP, PORTLAND, OR. FILED 9-8-2008.

VINTNER'S HARVEST

THE MARK CONSISTS OF STANDARD CHARACTERS WITHOUT CLAIM TO ANY PARTICULAR FONT, STYLE, SIZE, OR COLOR.
FOR FRUIT JUICE BASES; WINE MAKING INGREDIENTS, NAMELY, FRUIT CONCENTRATES AND PUREES (U.S. CLS. 45, 46 AND 48).
FIRST USE 9-15-2005; IN COMMERCE 9-15-2005.
MICHAEL KEATING, EXAMINING ATTORNEY

SN 77-566,547. KIRBY, JAMES T., MURIETTA, CA. FILED 9-10-2008.

brawndo

THE MARK CONSISTS OF STANDARD CHARACTERS WITHOUT CLAIM TO ANY PARTICULAR FONT, STYLE, SIZE, OR COLOR.
FOR CARBONATED AND NON-CARBONATED SOFT DRINKS AND ENERGY DRINKS (U.S. CLS. 45, 46 AND 48).
FIRST USE 11-1-2007; IN COMMERCE 11-1-2007.
BARBARA A. GOLD, EXAMINING ATTORNEY

SN 77-565,016. WIN IT TOO, DBA GLOBAL BEER NETWORK, SANTA BARBARA, CA. FILED 9-8-2008.

Living Beer

THE MARK CONSISTS OF STANDARD CHARACTERS WITHOUT CLAIM TO ANY PARTICULAR FONT, STYLE, SIZE, OR COLOR.
NO CLAIM IS MADE TO THE EXCLUSIVE RIGHT TO USE "BEER", APART FROM THE MARK AS SHOWN.
FOR BEER (U.S. CLS. 45, 46 AND 48).
REBECCA SMITH, EXAMINING ATTORNEY

SN 77-566,564. KIRBY, JAMES T., MURIETTA, CA. FILED 9-10-2008.

the thirst mutilator

THE MARK CONSISTS OF STANDARD CHARACTERS WITHOUT CLAIM TO ANY PARTICULAR FONT, STYLE, SIZE, OR COLOR.
FOR CARBONATED AND NON-CARBONATED SOFT DRINKS AND ENERGY DRINKS (U.S. CLS. 45, 46 AND 48).
FIRST USE 11-1-2007; IN COMMERCE 11-1-2007.
BARBARA A. GOLD, EXAMINING ATTORNEY

CLASS 32—(Continued).

SN 77-567,480. BRAZENSTREET, BROOKLYN, NY. FILED 9-11-2008.

BRAZEN

THE MARK CONSISTS OF STANDARD CHARACTERS WITHOUT CLAIM TO ANY PARTICULAR FONT, STYLE, SIZE, OR COLOR.
FOR ENERGY DRINKS (U.S. CLS. 45, 46 AND 48).
JULIE WATSON, EXAMINING ATTORNEY



SN 77-568,034. DODSON, DOUGLAS, CARLSBAD, CA. FILED 9-11-2008.

TAMER

THE MARK CONSISTS OF STANDARD CHARACTERS WITHOUT CLAIM TO ANY PARTICULAR FONT, STYLE, SIZE, OR COLOR.
FOR SOFT DRINKS (U.S. CLS. 45, 46 AND 48).
SHAILA SETTLES, EXAMINING ATTORNEY



SN 77-570,320. HALF FULL HOLDINGS, INC., CULVER CITY, CA. FILED 9-15-2008.

HYDRATED ENERGY

THE MARK CONSISTS OF STANDARD CHARACTERS WITHOUT CLAIM TO ANY PARTICULAR FONT, STYLE, SIZE, OR COLOR.
NO CLAIM IS MADE TO THE EXCLUSIVE RIGHT TO USE "ENERGY", APART FROM THE MARK AS SHOWN.
FOR SPORTS DRINKS; POWDERS USED IN THE PREPARATION OF SPORTS DRINKS AND SPORTS BEVERAGES; BEER, ALES AND LAGER; BOTTLED WATER; ENERGY DRINKS; FLAVORED WATERS; FRUIT BEVERAGES; SMOOTHIES (BEVERAGES); SOFT DRINKS (U.S. CLS. 45, 46 AND 48).
KRISTIN DAHLING, EXAMINING ATTORNEY

CLASS 32—(Continued).

SN 77-570,886. HALF FULL HOLDINGS, INC., CULVER CITY, CA. FILED 9-16-2008.

WHAT ARE YOU GOING TO DRINK?

THE MARK CONSISTS OF STANDARD CHARACTERS WITHOUT CLAIM TO ANY PARTICULAR FONT, STYLE, SIZE, OR COLOR.
FOR SPORTS DRINKS; POWDERS USED IN THE PREPARATION OF SPORTS DRINKS AND SPORTS BEVERAGES; BEER, ALES AND LAGER; BOTTLED WATER; ENERGY DRINKS; FLAVORED WATERS; FRUIT BEVERAGES; SMOOTHIES (BEVERAGES); SOFT DRINKS (U.S. CLS. 45, 46 AND 48).
KRISTIN DAHLING, EXAMINING ATTORNEY



SN 77-585,148. STOKELY-VAN CAMP, INC., CHICAGO, IL. FILED 10-3-2008.



OWNER OF U.S. REG. NOS. 3,356,900, 3,463,871 AND OTHERS.
THE MARK CONSISTS OF A STYLIZED FORM OF THE LETTER "G", THE NUMBER "2" AND A LIGHTNING BOLT DESIGN.
FOR NON-ALCOHOLIC, NON-CARBONATED FRUIT FLAVORED BEVERAGES (U.S. CLS. 45, 46 AND 48).
CHARLES L. JENKINS, EXAMINING ATTORNEY

CLASS 32—(Continued).

SN 77-585,199. STOKELY-VAN CAMP, INC., CHICAGO, IL. FILED 10-3-2008.



OWNER OF U.S. REG. NOS. 848,245, 3,356,900 AND OTHERS.

THE MARK CONSISTS OF THE STYLIZED FORMAT OF THE LETTER "G" CONTAINING A LIGHTNING BOLT DESIGN, THE WORD "GATORADE", THE LETTER "G" CONTAINING A LIGHTNING BOLT DESIGN.

FOR NON-ALCOHOLIC, NON-CARBONATED FRUIT FLAVORED BEVERAGES (U.S. CLS. 45, 46 AND 48).

CHARLES L. JENKINS, EXAMINING ATTORNEY

CLASS 33—WINES AND SPIRITS

SN 76-691,474. MEX LATIN IMPORTS, LTD./VINICOLA DEL ALTIPLANO, S.A. DE C.V., AUSTIN, TX. FILED 7-22-2008.

LA PENCA

THE MARK CONSISTS OF STANDARD CHARACTERS WITHOUT CLAIM TO ANY PARTICULAR FONT, STYLE, SIZE, OR COLOR.

THE NAME "LA PENCA" IS SPANISH FOR CACTUS LEAF.

FOR LIQUOR, NAMELY, A MEZCAL (U.S. CLS. 47 AND 49).

FIRST USE 10-5-2007; IN COMMERCE 10-5-2007.

INGA ERVIN, EXAMINING ATTORNEY

SN 78-910,415. BIG SKY BREWING COMPANY, MISSOULA, MT. FILED 6-16-2006.

Ivan The Terrible Imperial Stout

SN 77-283,976. GARRIDO, JORGE LUIS, MIAMI, FL. FILED 9-19-2007.

THE MARK CONSISTS OF STANDARD CHARACTERS WITHOUT CLAIM TO ANY PARTICULAR FONT, STYLE, SIZE, OR COLOR.

NO CLAIM IS MADE TO THE EXCLUSIVE RIGHT TO USE "IMPERIAL STOUT", APART FROM THE MARK AS SHOWN.

FOR BEER (U.S. CLS. 45, 46 AND 48).

FIRST USE 4-1-2002; IN COMMERCE 4-1-2002.

ROBERT C. CLARK JR., EXAMINING ATTORNEY



SN 79-050,709. INFRA METAL ESTABLISHMENT, LIECHTENSTEIN, FILED 12-27-2007.

FIGHTER

THE COLOR(S) BLACK, RED, AND OLIVE GOLD IS/ARE CLAIMED AS A FEATURE OF THE MARK.

THE MARK CONSISTS OF TWO CONCENTRIC CIRCLES. THE OUTER CIRCLE IS OLIVE GOLD AND THE INNER CIRCLE IS RED. THE OUTER CIRCLE CONTAINS A THICK BLACK BORDER, AND THE INNER CIRCLE CONTAINS A THIN BLACK BORDER. TWO WOLVES FACING IN OPPOSITE DIRECTIONS SIT IN FRONT OF THE CONCENTRIC CIRCLES. THE WOLVES ARE BLACK WITH OLIVE GOLD HIGHLIGHTING ON THEIR FACES AND BODIE.

FOR WINE; RED WINE (U.S. CLS. 47 AND 49).

FIRST USE 7-30-2007; IN COMMERCE 7-30-2007.

SONYA STEPHENS, EXAMINING ATTORNEY

THE MARK CONSISTS OF STANDARD CHARACTERS WITHOUT CLAIM TO ANY PARTICULAR FONT, STYLE, SIZE, OR COLOR.

OWNER OF INTERNATIONAL REGISTRATION 0928517 DATED 5-24-2007, EXPIRES 5-24-2017.

FOR BEERS; MINERAL AND AERATED WATERS; FRUIT DRINKS AND FRUIT JUICES; SYRUPS FOR MAKING NON-ALCOHOLIC BEVERAGES, ENERGY DRINKS, SPORTS DRINKS (U.S. CLS. 45, 46 AND 48).

LEIGH LOWRY, EXAMINING ATTORNEY

CLASS 33—(Continued).

SN 77-336,371. DESTILERIA DON ROBERTO SA DE CV, TEQUILA, MEXICO, FILED 11-26-2007.

DON ROBERTO

THE MARK CONSISTS OF STANDARD CHARACTERS WITHOUT CLAIM TO ANY PARTICULAR FONT, STYLE, SIZE, OR COLOR.

THE NAME "DON ROBERTO" DOES NOT IDENTIFY A LIVING INDIVIDUAL.

THE ENGLISH TRANSLATION OF THE WORD "DON ROBERTO" IN THE MARK IS "MISTER ROBERT".

FOR TEQUILA (U.S. CLS. 47 AND 49).

CHRISTINA SOBRAL, EXAMINING ATTORNEY

SN 77-345,307. SAVIAH ROSE WINERY, LLC, WALLA WALLA, WA. FILED 12-6-2007.

BIG SKY CUVÉE

THE MARK CONSISTS OF STANDARD CHARACTERS WITHOUT CLAIM TO ANY PARTICULAR FONT, STYLE, SIZE, OR COLOR.

NO CLAIM IS MADE TO THE EXCLUSIVE RIGHT TO USE "CUVÉE", APART FROM THE MARK AS SHOWN.

FOR WINES (U.S. CLS. 47 AND 49).

FIRST USE 2-21-2004; IN COMMERCE 2-21-2004.

STEPHEN AQUILA, EXAMINING ATTORNEY

SN 77-403,057. BERTON GROUP LLC, THE, CORAL GABLES, FL. FILED 2-21-2008.

WHITE MAN'S POISON

THE MARK CONSISTS OF STANDARD CHARACTERS WITHOUT CLAIM TO ANY PARTICULAR FONT, STYLE, SIZE, OR COLOR.

FOR WHISKEY AND SPIRITS (U.S. CLS. 47 AND 49).

PAUL CROWLEY, EXAMINING ATTORNEY

CLASS 33—(Continued).

SN 77-406,877. W. & J. GRAHAM & COMPANHIA, S.A., VILA NOVA DE GAIA, PORTUGAL, FILED 2-26-2008.

QUINTA DOS MALVEDOS

THE MARK CONSISTS OF STANDARD CHARACTERS WITHOUT CLAIM TO ANY PARTICULAR FONT, STYLE, SIZE, OR COLOR.

NO CLAIM IS MADE TO THE EXCLUSIVE RIGHT TO USE "QUINTA", APART FROM THE MARK AS SHOWN.

THE FOREIGN WORDING IN THE MARK TRANSLATES INTO ENGLISH AS FARM OF MALVEDOS.

FOR ALCOHOLIC BEVERAGES, NAMELY, WINE AND PORT WINE (U.S. CLS. 47 AND 49).

FIRST USE 6-8-1971; IN COMMERCE 1-0-1980.

ANGELA GAW, EXAMINING ATTORNEY

SN 77-415,939. TITUS VINEYARDS, ST. HELENA, CA. FILED 3-7-2008.



THE COLOR(S) RED, ORANGE, YELLOW AND WHITE IS/ARE CLAIMED AS A FEATURE OF THE MARK.

THE MARK CONSISTS OF THE COLOR YELLOW APPEARS IN THE OUTLINE OF THE AMPHORA AND THREE DIAMONDS APPEARING IN DESIGN ELEMENT; THE COLOR RED APPEARS IN THE INTERIOR OF THE TWO OF THE THREE DIAMONDS, SPECIFICALLY IN THE DIAMONDS ON THE LEFT AND RIGHT OF THE AMPHORA; THE COLOR ORANGE APPEARS IN THE INTERIOR OF THE MIDDLE OF THE THREE DIAMONDS; THE COLOR WHITE APPEARS IN THE AMPHORA.

FOR WINES (U.S. CLS. 47 AND 49).

FIRST USE 12-18-1996; IN COMMERCE 12-18-1996.

BARNEY CHARLON, EXAMINING ATTORNEY

CLASS 33—(Continued).

SN 77-419,462. GRUPO OSBORNE, S.A., CADIZ, SPAIN,
FILED 3-12-2008.

OSBORNE CELENUS

THE MARK CONSISTS OF STANDARD CHARACTERS
WITHOUT CLAIM TO ANY PARTICULAR FONT, STYLE,
SIZE, OR COLOR.

FOR WINES (U.S. CLS. 47 AND 49).
ANTHONY RINKER, EXAMINING ATTORNEY

SN 77-420,563. GRUPO OSBORNE, S.A., CADIZ, SPAIN,
FILED 3-12-2008.

OSBORNE VINICUS

THE MARK CONSISTS OF STANDARD CHARACTERS
WITHOUT CLAIM TO ANY PARTICULAR FONT, STYLE,
SIZE, OR COLOR.

OWNER OF U.S. REG. NOS. 674,011, 1,068,670 AND
OTHERS.
FOR WINES (U.S. CLS. 47 AND 49).
ANTHONY RINKER, EXAMINING ATTORNEY

SN 77-421,154. SOLENE LLC, PASO ROBLES, CA. FILED 3-
13-2008.

CLOS SOLÈNE

THE MARK CONSISTS OF STANDARD CHARACTERS
WITHOUT CLAIM TO ANY PARTICULAR FONT, STYLE,
SIZE, OR COLOR.

NO CLAIM IS MADE TO THE EXCLUSIVE RIGHT TO
USE "CLOS", APART FROM THE MARK AS SHOWN.
THE ENGLISH TRANSLATION OF "CLOS" IN THE
MARK IS "VINEYARD".
FOR WINE (U.S. CLS. 47 AND 49).
COURTNEY MCCORMICK, EXAMINING ATTORNEY

CLASS 33—(Continued).

SN 77-446,525. DOMAINE DES ROMARINS, DOMAZAN
30390, FRANCE, FILED 4-11-2008.

DOMAINE DES ROMARINS

THE MARK CONSISTS OF STANDARD CHARACTERS
WITHOUT CLAIM TO ANY PARTICULAR FONT, STYLE,
SIZE, OR COLOR.

NO CLAIM IS MADE TO THE EXCLUSIVE RIGHT TO
USE "DOMAINE", APART FROM THE MARK AS SHOWN.
THE FOREIGN WORDING IN THE MARK TRANSLATES
INTO ENGLISH AS DOMAIN OF THE ROSEMARY OR
DOMAIN OF THE ROSEMARY PLANTS.

FOR WINES (U.S. CLS. 47 AND 49).
FIRST USE 0-0-1995; IN COMMERCE 0-0-1995.
LYDIA BELZER, EXAMINING ATTORNEY

SN 77-532,998. SHAOUL AMAR, SHERMAN OAKS, CA.
FILED 7-28-2008.



THE MARK CONSISTS OF THE NUMBER "18" IN A
CIRCLE SURROUNDED BY FOLIAGE WITH THE CAPI-
TALIZED WORD "CENTURY" CURVED BELOW.

FOR VODKA (U.S. CLS. 47 AND 49).
BARBARA RUTLAND, EXAMINING ATTORNEY

SN 77-536,156. DAUCOURT, JEAN-MARC, DALLAS, TX.
FILED 7-31-2008.

Pur-Rêv Liqueur

THE MARK CONSISTS OF STANDARD CHARACTERS
WITHOUT CLAIM TO ANY PARTICULAR FONT, STYLE,
SIZE, OR COLOR.

NO CLAIM IS MADE TO THE EXCLUSIVE RIGHT TO
USE "LIQUEUR", APART FROM THE MARK AS SHOWN.
FOR DISTILLED SPIRITS (U.S. CLS. 47 AND 49).
RENEE SERVANCE, EXAMINING ATTORNEY

CLASS 33—(Continued).

SN 77-546,185. NUZEST BEVERAGE, L.L.C., AUSTIN, TX.
FILED 8-13-2008.

VÖD

THE MARK CONSISTS OF STANDARD CHARACTERS WITHOUT CLAIM TO ANY PARTICULAR FONT, STYLE, SIZE, OR COLOR.

FOR ALCOHOLIC BEVERAGES, NAMELY, WINE BASED BEVERAGES (U.S. CLS. 47 AND 49).
DARRYL SPRUILL, EXAMINING ATTORNEY

SN 77-551,436. RDJ ARTISAN WINE COMPANY LLC, NAPA, CA. FILED 8-20-2008.

Sly Dog Cellars

THE MARK CONSISTS OF STANDARD CHARACTERS WITHOUT CLAIM TO ANY PARTICULAR FONT, STYLE, SIZE, OR COLOR.

NO CLAIM IS MADE TO THE EXCLUSIVE RIGHT TO USE "CELLARS", APART FROM THE MARK AS SHOWN.
FOR GRAPE WINE (U.S. CLS. 47 AND 49).
FIRST USE 6-1-2007; IN COMMERCE 6-1-2007.
WON TEAK OH, EXAMINING ATTORNEY

SN 77-551,791. WHISTLING DUCK VINEYARDS, AUSTIN, TX. FILED 8-20-2008.

WHISTLING DUCK VINEYARDS

THE MARK CONSISTS OF STANDARD CHARACTERS WITHOUT CLAIM TO ANY PARTICULAR FONT, STYLE, SIZE, OR COLOR.

NO CLAIM IS MADE TO THE EXCLUSIVE RIGHT TO USE "VINEYARDS", APART FROM THE MARK AS SHOWN.

FOR WINES (U.S. CLS. 47 AND 49).
WON TEAK OH, EXAMINING ATTORNEY

CLASS 33—(Continued).

SN 77-553,387. SAN LUIS SPIRITS, INC., DRIPPING SPRINGS, TX. FILED 8-22-2008.

Dripping Springs



Texas Vodka

NO CLAIM IS MADE TO THE EXCLUSIVE RIGHT TO USE "TEXAS VODKA", APART FROM THE MARK AS SHOWN.

THE MARK CONSISTS OF A DROP OF WATER FALLING INTO A POOL OF WATER, WITH THE STYLIZED WORDING "DRIPPING SPRINGS" ABOVE THE DESIGN, AND THE WORDING "TEXAS VODKA" BELOW IT.

FOR VODKA (U.S. CLS. 47 AND 49).
FIRST USE 5-31-2007; IN COMMERCE 5-31-2008.
MARTHA FROMM, EXAMINING ATTORNEY

SN 77-554,461. JOHNSON, CRAIG S., SAN FRANCISCO, CA. FILED 8-25-2008.

HORIZONTAL

THE MARK CONSISTS OF STANDARD CHARACTERS WITHOUT CLAIM TO ANY PARTICULAR FONT, STYLE, SIZE, OR COLOR.

OWNER OF U.S. REG. NOS. 3,413,065 AND 3,413,520.
FOR WINE (U.S. CLS. 47 AND 49).
WENDY GOODMAN, EXAMINING ATTORNEY

SN 77-554,740. WINERY EXCHANGE, INC., NOVATO, CA. FILED 8-25-2008.

STAR COUNTY

THE MARK CONSISTS OF STANDARD CHARACTERS WITHOUT CLAIM TO ANY PARTICULAR FONT, STYLE, SIZE, OR COLOR.

FOR WINES (U.S. CLS. 47 AND 49).
MARK PILARO, EXAMINING ATTORNEY

CLASS 33—(Continued).

SN 77-559,321. BROSSAU, WILLIAM, DBA BROSSAU WINES, LOS ALTOS, CA. FILED 8-29-2008.



THE COLOR(S) CELADON (GREEN/GOLD) AND GRAY IS/ARE CLAIMED AS A FEATURE OF THE MARK. THE MARK CONSISTS OF A PIECE OF GRAY SLATE WITH "BROSSEAU" IN CELADON (GREEN/GOLD) WRITING ON THE SLATE. FOR WINE (U.S. CLS. 47 AND 49). FIRST USE 2-24-2006; IN COMMERCE 8-14-2006. CAROL SPILS, EXAMINING ATTORNEY

CLASS 33—(Continued).

SN 77-562,458. AUSTIN, NICHOLS & CO. INCORPORATED, WHITE PLAINS, NY. FILED 9-4-2008.



THE COLOR(S) BLACK IS/ARE CLAIMED AS A FEATURE OF THE MARK. THE MARK CONSISTS OF A BLACK SILHOUETTE OF A TURKEY. FOR POTABLE DISTILLED SPIRITS (U.S. CLS. 47 AND 49). FIRST USE 8-0-2006; IN COMMERCE 8-0-2006. JANICE KIM, EXAMINING ATTORNEY

SN 77-562,450. NEL, CAREL CHRISTIAN, TA BOPLAAS WINE ESTATE, CALITZDORP, SOUTH AFRICA, FILED 9-4-2008.

SN 77-562,945. FREY VINEYARDS, LTD., REDWOOD VALLEY, CA. FILED 9-5-2008.

COOL BAY

Frey

THE MARK CONSISTS OF STANDARD CHARACTERS WITHOUT CLAIM TO ANY PARTICULAR FONT, STYLE, SIZE, OR COLOR. FOR RED, WHITE AND SPARKLING TABLE WINE (U.S. CLS. 47 AND 49). JANICE KIM, EXAMINING ATTORNEY

THE MARK CONSISTS OF STANDARD CHARACTERS WITHOUT CLAIM TO ANY PARTICULAR FONT, STYLE, SIZE, OR COLOR. THE NAME "FREY" IDENTIFIES A LIVING INDIVIDUAL WHOSE CONSENT IS OF RECORD. SEC. 2(F). FOR GRAPE WINE; PORT WINES; RED WINE; RED WINES; SWEET WINES; TABLE WINES; WHITE WINE; WINE; WINES; WINES AND FORTIFIED WINES (U.S. CLS. 47 AND 49). FIRST USE 7-6-1981; IN COMMERCE 8-0-1981. MAUREEN DALL, EXAMINING ATTORNEY

CLASS 33—(Continued).

SN 77-563,021. MJM WORLD IMPORTS, LLC, TROY, NY.
FILED 9-5-2008.

Riconosci

THE MARK CONSISTS OF STANDARD CHARACTERS WITHOUT CLAIM TO ANY PARTICULAR FONT, STYLE, SIZE, OR COLOR.

THE ENGLISH TRANSLATION OF THE WORD "RICONOSCI" IN THE MARK IS YOU RECOGNIZE.
FOR ALCOHOLIC BEVERAGES, NAMELY, WINE AND VODKA (U.S. CLS. 47 AND 49).
ANTHONY RINKER, EXAMINING ATTORNEY

SN 77-563,716. A & D'S ESTATE & WINERY, LLC, HEALDSBURG, CA. FILED 9-5-2008.

D & A'S ESTATE

THE MARK CONSISTS OF STANDARD CHARACTERS WITHOUT CLAIM TO ANY PARTICULAR FONT, STYLE, SIZE, OR COLOR.

NO CLAIM IS MADE TO THE EXCLUSIVE RIGHT TO USE "ESTATE", APART FROM THE MARK AS SHOWN.
FOR WINES (U.S. CLS. 47 AND 49).
STEVEN PEREZ, EXAMINING ATTORNEY

SN 77-563,889. KLEINER, ANDREW SOLOMON, LOS ANGELES, CA. FILED 9-5-2008.

Swinging Sack Cellars

THE MARK CONSISTS OF STANDARD CHARACTERS WITHOUT CLAIM TO ANY PARTICULAR FONT, STYLE, SIZE, OR COLOR.

NO CLAIM IS MADE TO THE EXCLUSIVE RIGHT TO USE "CELLARS", APART FROM THE MARK AS SHOWN.
FOR GRAPE WINE (U.S. CLS. 47 AND 49).
KATHLEEN M. VANSTON, EXAMINING ATTORNEY

CLASS 33—(Continued).

SN 77-564,058. WILLAKENZIE ESTATE, INC., YAMHILL, OR. FILED 9-7-2008.

DIRT MATTERS

THE MARK CONSISTS OF STANDARD CHARACTERS WITHOUT CLAIM TO ANY PARTICULAR FONT, STYLE, SIZE, OR COLOR.

FOR WINE (U.S. CLS. 47 AND 49).
GIANCARLO CASTRO, EXAMINING ATTORNEY

SN 77-564,059. WILLAKENZIE ESTATE, INC., YAMHILL, OR. FILED 9-7-2008.

CLONES MATTER

THE MARK CONSISTS OF STANDARD CHARACTERS WITHOUT CLAIM TO ANY PARTICULAR FONT, STYLE, SIZE, OR COLOR.

FOR WINE (U.S. CLS. 47 AND 49).
GIANCARLO CASTRO, EXAMINING ATTORNEY

SN 77-564,066. WILLAKENZIE ESTATE, INC., YAMHILL, OR. FILED 9-7-2008.

PEOPLE MATTER

THE MARK CONSISTS OF STANDARD CHARACTERS WITHOUT CLAIM TO ANY PARTICULAR FONT, STYLE, SIZE, OR COLOR.

FOR WINE (U.S. CLS. 47 AND 49).
GIANCARLO CASTRO, EXAMINING ATTORNEY

SN 77-564,070. LEATHERMAN, JIM, LONG BEACH, CA. FILED 9-7-2008.

STRUGGLER

THE COLOR(S) RED IS/ARE CLAIMED AS A FEATURE OF THE MARK.

THE MARK CONSISTS OF THE TERM "STRUGGLER" IN RED.
FOR VODKA (U.S. CLS. 47 AND 49).
GIANCARLO CASTRO, EXAMINING ATTORNEY

CLASS 33—(Continued).

SN 77-564,580. INNOVATIVE LIQUORS, LLC, HOLLYWOOD, FL. FILED 9-8-2008.

LICIOUS

THE MARK CONSISTS OF STANDARD CHARACTERS WITHOUT CLAIM TO ANY PARTICULAR FONT, STYLE, SIZE, OR COLOR.
FOR ALCOHOLIC BEVERAGES EXCLUDING WINE AND BEER; LIQUOR (U.S. CLS. 47 AND 49).
HELENE LIWINSKI, EXAMINING ATTORNEY

SN 77-564,618. INNOVATIVE LIQUORS, LLC, HOLLYWOOD, FL. FILED 9-8-2008.

BEAR HUG

THE MARK CONSISTS OF STANDARD CHARACTERS WITHOUT CLAIM TO ANY PARTICULAR FONT, STYLE, SIZE, OR COLOR.
FOR ALCOHOLIC BEVERAGES EXCEPT BEERS; DISTILLED SPIRITS; LIQUOR (U.S. CLS. 47 AND 49).
HELENE LIWINSKI, EXAMINING ATTORNEY

SN 77-564,625. INNOVATIVE LIQUORS, LLC, HOLLYWOOD, FL. FILED 9-8-2008.

BEAR FOOT

THE MARK CONSISTS OF STANDARD CHARACTERS WITHOUT CLAIM TO ANY PARTICULAR FONT, STYLE, SIZE, OR COLOR.
FOR ALCOHOLIC BEVERAGES EXCLUDING WINE AND BEER; DISTILLED SPIRITS; LIQUOR (U.S. CLS. 47 AND 49).
HELENE LIWINSKI, EXAMINING ATTORNEY

CLASS 33—(Continued).

SN 77-564,643. FALIC LIQUOR GROUP, LLC, HOLLYWOOD, FL. FILED 9-8-2008.

RON GALEON

THE MARK CONSISTS OF STANDARD CHARACTERS WITHOUT CLAIM TO ANY PARTICULAR FONT, STYLE, SIZE, OR COLOR.
NO CLAIM IS MADE TO THE EXCLUSIVE RIGHT TO USE "RON", APART FROM THE MARK AS SHOWN.
THE NAME "RON GALEON" DOES NOT IDENTIFY A LIVING INDIVIDUAL.
THE ENGLISH TRANSLATION OF RON GALEON IS "RUM GALLEON".
FOR LIQUOR; RUM (U.S. CLS. 47 AND 49).
BILL DAWE, EXAMINING ATTORNEY

SN 77-565,332. PATERNO IMPORTS, LTD., DBA TERLATO WINES INTERNATIONAL, LAKE BLUFF, IL. FILED 9-9-2008.

HIDEAWAY CREEK

THE MARK CONSISTS OF STANDARD CHARACTERS WITHOUT CLAIM TO ANY PARTICULAR FONT, STYLE, SIZE, OR COLOR.
FOR WINE (U.S. CLS. 47 AND 49).
SUNG IN, EXAMINING ATTORNEY

SN 77-565,439. BLANKIET ESTATE LLC, YOUNTVILLE, CA. FILED 9-9-2008.

Prince of Hearts

THE MARK CONSISTS OF STANDARD CHARACTERS WITHOUT CLAIM TO ANY PARTICULAR FONT, STYLE, SIZE, OR COLOR.
FOR WINE (U.S. CLS. 47 AND 49).
MARK PILARO, EXAMINING ATTORNEY

CLASS 33—(Continued).

SN 77-565,589. ABNEY, CHARLES, ATLANTA, GA. FILED 9-9-2008.

PHOTOGRAPH

THE MARK CONSISTS OF STANDARD CHARACTERS WITHOUT CLAIM TO ANY PARTICULAR FONT, STYLE, SIZE, OR COLOR.

FOR WINES (U.S. CLS. 47 AND 49).
NELSON SNYDER, EXAMINING ATTORNEY

CLASS 33—(Continued).

SN 77-565,969. RALEIGH ENTERPRISES, LLC, SANTA MONICA, CA. FILED 9-9-2008.

HANG TEN RED

THE MARK CONSISTS OF STANDARD CHARACTERS WITHOUT CLAIM TO ANY PARTICULAR FONT, STYLE, SIZE, OR COLOR.

NO CLAIM IS MADE TO THE EXCLUSIVE RIGHT TO USE "RED", APART FROM THE MARK AS SHOWN.
FOR WINE (U.S. CLS. 47 AND 49).
ANGELA M. MICHELI, EXAMINING ATTORNEY

SN 77-565,591. JACKSON FAMILY FARMS, LLC, SANTA ROSA, CA. FILED 9-9-2008.

VELD

THE MARK CONSISTS OF STANDARD CHARACTERS WITHOUT CLAIM TO ANY PARTICULAR FONT, STYLE, SIZE, OR COLOR.

FOR ALCOHOLIC BEVERAGES, NAMELY, VODKA (U.S. CLS. 47 AND 49).
NELSON SNYDER, EXAMINING ATTORNEY

SN 77-566,145. HIGH POINT GROUP, INC., SAN DIEGO, CA. FILED 9-9-2008.

A NEW DEGREE OF COOL

THE MARK CONSISTS OF STANDARD CHARACTERS WITHOUT CLAIM TO ANY PARTICULAR FONT, STYLE, SIZE, OR COLOR.

FOR POTABLE SPIRITS (U.S. CLS. 47 AND 49).
GEORGE LORENZO, EXAMINING ATTORNEY

SN 77-565,966. RALEIGH ENTERPRISES, LLC, SANTA MONICA, CA. FILED 9-9-2008.

SURFRIDER

THE MARK CONSISTS OF STANDARD CHARACTERS WITHOUT CLAIM TO ANY PARTICULAR FONT, STYLE, SIZE, OR COLOR.

FOR WINE (U.S. CLS. 47 AND 49).
FIRST USE 3-15-2007; IN COMMERCE 3-15-2007.
ANGELA M. MICHELI, EXAMINING ATTORNEY

SN 77-566,503. VINA VENTISQUERO LIMITADA, RANCA-GUA, CHILE, FILED 9-10-2008.

HERÚ

THE MARK CONSISTS OF STANDARD CHARACTERS WITHOUT CLAIM TO ANY PARTICULAR FONT, STYLE, SIZE, OR COLOR.

FOR WINES AND ALCOHOLIC BEVERAGES EXCEPT BEERS (U.S. CLS. 47 AND 49).
KAREN K. BUSH, EXAMINING ATTORNEY

CLASS 33—(Continued).

SN 77-567,058. METEOR VINEYARD, LLC, NAPA, CA. FILED 9-10-2008.

METEOR VINEYARD

THE MARK CONSISTS OF STANDARD CHARACTERS WITHOUT CLAIM TO ANY PARTICULAR FONT, STYLE, SIZE, OR COLOR.

NO CLAIM IS MADE TO THE EXCLUSIVE RIGHT TO USE "VINEYARD", APART FROM THE MARK AS SHOWN. FOR WINES (U.S. CLS. 47 AND 49).
MARC LEIPZIG, EXAMINING ATTORNEY

CLASS 33—(Continued).

SN 77-567,644. KING FAMILY VINEYARDS LLC, CROZET, VA. FILED 9-11-2008.



THE MARK CONSISTS OF THE NUMBER "7" WITH A PERSON RIDING A HORSE AT THE TOP RIGHT OF THE NUMBER.

FOR WINE (U.S. CLS. 47 AND 49).
FIRST USE 7-1-2008; IN COMMERCE 7-1-2008.
CAROLYN GRAY, EXAMINING ATTORNEY

SN 77-567,451. CLUB DE FUTBOL AMERICA, S.A. DE C.V., EX HACIENDA DE COAPA, MEXICO, FILED 9-11-2008.



CORKORDINATES

THE MARK CONSISTS OF STANDARD CHARACTERS WITHOUT CLAIM TO ANY PARTICULAR FONT, STYLE, SIZE, OR COLOR.

FOR WINES (U.S. CLS. 47 AND 49).
LINDA MICKLEBURGH, EXAMINING ATTORNEY

SN 77-601,256. E. & J. GALLO WINERY, MODESTO, CA. FILED 10-27-2008.

MADRIA SANGRIA

OWNER OF U.S. REG. NOS. 3,170,057, 3,418,222 AND OTHERS.

THE MARK CONSISTS OF THE LETTERS "C" AND "A" DRAWN AGAINST A SPHERICAL IMAGE RESEMBLING A SOCCER BALL BEARING THE SILHOUETTE OF THE WESTERN HEMISPHERE.

FOR TEQUILA (U.S. CLS. 47 AND 49).
SHANNON TWOHIG, EXAMINING ATTORNEY

THE MARK CONSISTS OF STANDARD CHARACTERS WITHOUT CLAIM TO ANY PARTICULAR FONT, STYLE, SIZE, OR COLOR.

NO CLAIM IS MADE TO THE EXCLUSIVE RIGHT TO USE "SANGRIA", APART FROM THE MARK AS SHOWN. FOR WINES (U.S. CLS. 47 AND 49).

LINDA MICKLEBURGH, EXAMINING ATTORNEY

CLASS 33—(Continued).

SN 77-601,934. E. & J. GALLO WINERY, MODESTO, CA.
FILED 10-28-2008.

APOTHIC RED

THE MARK CONSISTS OF STANDARD CHARACTERS WITHOUT CLAIM TO ANY PARTICULAR FONT, STYLE, SIZE, OR COLOR.

NO CLAIM IS MADE TO THE EXCLUSIVE RIGHT TO USE "RED", APART FROM THE MARK AS SHOWN. FOR WINES (U.S. CLS. 47 AND 49).
LINDA MICKLEBURGH, EXAMINING ATTORNEY

SN 78-835,348. CPA TRADING INC., WINNIPEG, CANADA,
FILED 3-13-2006.

DON DIEGO COSTA

THE MARK CONSISTS OF STANDARD CHARACTERS WITHOUT CLAIM TO ANY PARTICULAR FONT, STYLE, SIZE, OR COLOR.

THE NAME "DON DIEGO COSTA" DOES NOT IDENTIFY A LIVING INDIVIDUAL.

THE FOREIGN WORDING IN THE MARK TRANSLATES INTO ENGLISH AS "MR. DAVID COSTA".

FOR TEQUILA, LIQUOR, WINE; ALCOHOLIC DRINKS, EXCEPT BEER (U.S. CLS. 47 AND 49).

KATHERINE M. DUBRAY, EXAMINING ATTORNEY

CLASS 33—(Continued).

SN 79-050,315. JOSEPH PERRIER FILS & CIE, FRANCE,
FILED 1-25-2008.



PRIORITY DATE OF 8-8-2007 IS CLAIMED.
OWNER OF INTERNATIONAL REGISTRATION 0954412 DATED 1-25-2008, EXPIRES 1-25-2018.

OWNER OF U.S. REG. NO. 2,363,774.

THE NAME(S), PORTRAIT(S), AND/OR SIGNATURE(S) SHOWN IN THE MARK DOES NOT IDENTIFY A PARTICULAR LIVING INDIVIDUAL.

THE COLOR(S) YELLOW AND GREEN IS/ARE CLAIMED AS A FEATURE OF THE MARK.

THE MARK CONSISTS OF A YELLOW LABEL WITH THE WORDS "JOSEPH PERRIER" IN GREEN SUPERIMPOSED OVER THE LETTERS "JP" APPEARING IN A DARKER SHADE OF YELLOW AND A YELLOW NECK LABEL WITH THE WORDS "JOSEPH PERRIER" APPEARING ON EITHER SIDE OF A GREEN CIRCLE THAT BISECTS THE NECK LABEL. A GOLD DESIGN IS PLACED ON THE GREEN CIRCLE.

FOR CHAMPAGNE WINES (U.S. CLS. 47 AND 49).
WILLIAM P. SHANAHAN, EXAMINING ATTORNEY

SN 79-051,781. AZIENDA AGRICOLA CASCINA VALLEGRANDA; CA' DEL BAIO DI GRASSO GIULIO, ITALY,
FILED 2-7-2008.

**CA' DEL BAIO**

OWNER OF INTERNATIONAL REGISTRATION 0958417 DATED 2-7-2008, EXPIRES 2-7-2018.

THE MARK CONSISTS OF THE WORDING "CA' DEL BAIO" BELOW A DESIGN ELEMENT OF A HORSE.

THE ENGLISH TRANSLATION OF "CA' DEL" IS HOUSE OF.

FOR WINES (U.S. CLS. 47 AND 49).

WENDY JUN, EXAMINING ATTORNEY

CLASS 33—(Continued).

SN 79-052,737. CHIVAS BROTHERS; PERNOD RICARD LIMITED, UNITED KINGDOM, FILED 1-15-2008.

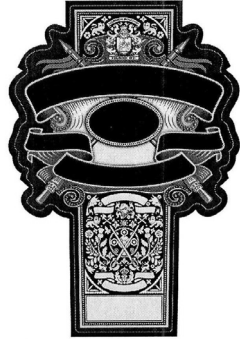

PRIORITY DATE OF 7-20-2007 IS CLAIMED.
OWNER OF INTERNATIONAL REGISTRATION 0961239
DATED 1-15-2008, EXPIRES 1-15-2018.
FOR WHISKY (U.S. CLS. 47 AND 49).
ANTHONY RINKER, EXAMINING ATTORNEY

SN 79-055,564. JIANGSU MENGDA COSMETIC; COMPANY LIMITED, CHINA, FILED 7-1-2008.



OWNER OF INTERNATIONAL REGISTRATION 0969038
DATED 7-1-2008, EXPIRES 7-1-2018.
THE ENGLISH TRANSLATION OF THE FOREIGN
WORD(S) IN THE MARK IS: "PLEASURE".
THE TRANSLITERATION OF THE NON-LATIN CHAR-
ACTERS IN THE MARK IS: "KUAI LE".
FOR CHINESE YELLOW WINE; EDIBLE ALCOHOL,
NAMELY, ALCOHOLIC EXTRACTS; ARRACK (ARAK);
ALCOHOLIC FRUIT EXTRACTS; APERITIFS; ALCO-
HOLIC BEVERAGES EXCEPT BEERS; HYDROMEL
(MEAD); SPIRITS (BEVERAGES); WINE; SAKE (U.S.
CLS. 47 AND 49).
JOHN WILKE, EXAMINING ATTORNEY

SN 79-059,314. THE LAST DROP DISTILLERS LIMITED,
UNITED KINGDOM, FILED 9-10-2008.

THE LAST DROP

THE MARK CONSISTS OF STANDARD CHARACTERS
WITHOUT CLAIM TO ANY PARTICULAR FONT, STYLE,
SIZE, OR COLOR.
OWNER OF INTERNATIONAL REGISTRATION 0978456
DATED 9-10-2008, EXPIRES 9-10-2018.
FOR WINES; SPIRITS; LIQUEURS; WHISKY AND
WHISKY-BASED LIQUEURS (U.S. CLS. 47 AND 49).
CARYN GLASSER, EXAMINING ATTORNEY

CLASS 34—SMOKERS' ARTICLES

SN 76-688,370. GENERAL JACK'S INCORPORATED, HUNT VALLEY, MD. FILED 4-4-2008.

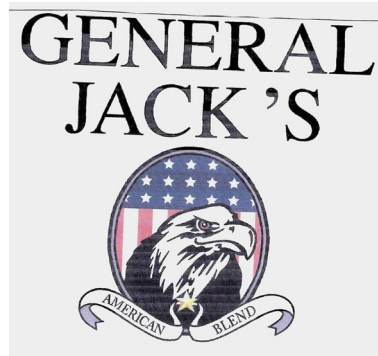

NO CLAIM IS MADE TO THE EXCLUSIVE RIGHT TO
USE "AMERICAN BLEND", APART FROM THE MARK AS
SHOWN.

THE NAME "GENERAL JACK'S" DOES NOT IDENTIFY
A LIVING INDIVIDUAL.

THE COLOR(S) RED, WHITE, BLUE, BLACK AND GOLD
IS/ARE CLAIMED AS A FEATURE OF THE MARK.

THE COLOR RED APPEAR IN THE FLAG'S STRIPES
AND IN THE EAGLE'S EYE. THE COLOR BLUE APPEARS
IN THE BACKGROUND OF THE TOP PORTION OF THE
FLAG. THE COLOR WHITE APPEARS IN THE ALTERNAT-
ING STRIPES OF THE FLAG, IN THE STAR DESIGN
LOCATED ON THE TOP PORTION OF THE BLUE AREA
OF SAID FLAG, IN THE BACKGROUND OF THE BANNER,
AND ON THE EAGLE'S HEAD. THE COLOR BLACK
APPEARS ON THE BODY OF THE EAGLE, IN THE
LETTERING, IN THE TRACING OF THE FOUR POINT
STARS, AND ON THE CREATION OF TWO OVAL CIRCLES
ENCLOSING THE EAGLE AND FLAG PORTION OF
PICTURE. THE COLOR GOLD APPEARS ON THE 5-POINT
STAR ATTACHING THE BANNER TO THE EAGLE'S
CHEST.

FOR CIGARETTES (U.S. CLS. 2, 8, 9 AND 17).
DORITT L. CARROLL, EXAMINING ATTORNEY

SN 77-020,461. JONATHAN DREW, INC., DBA DREW
ESTATE, MIAMI, FL. FILED 10-13-2006.

BROOKLYN BLUNT FACTORY

THE MARK CONSISTS OF STANDARD CHARACTERS
WITHOUT CLAIM TO ANY PARTICULAR FONT, STYLE,
SIZE, OR COLOR.

NO CLAIM IS MADE TO THE EXCLUSIVE RIGHT TO
USE "BLUNT", APART FROM THE MARK AS SHOWN.

FOR CIGARS, TOBACCO AND RELATED PRODUCTS,
NAMELY, CIGAR BOXES, CIGAR AND CIGARETTE
LIGHTERS, CIGAR AND CIGARETTE HOLDERS, ASH-
TRAYS, CIGAR BANDS, CIGAR CUTTERS, HUMIDORS,
AND CIGAR TUBES (U.S. CLS. 2, 8, 9 AND 17).
MATTHEW MCDOWELL, EXAMINING ATTORNEY

CLASS 34—(Continued).

SN 77-414,035. TAMPA SWEETHEARTS CIGAR COMPANY,
TAMPA, FL. FILED 3-5-2008.

TROLLEY

THE MARK CONSISTS OF STANDARD CHARACTERS
WITHOUT CLAIM TO ANY PARTICULAR FONT, STYLE,
SIZE, OR COLOR.
FOR CIGARS (U.S. CLS. 2, 8, 9 AND 17).
NICHOLAS ALTREE, EXAMINING ATTORNEY

SN 77-479,198. HOLT'S COMPANY, PHILADELPHIA, PA.
FILED 5-20-2008.

HOLT'S CONNOISSEUR SELECTION

THE MARK CONSISTS OF STANDARD CHARACTERS
WITHOUT CLAIM TO ANY PARTICULAR FONT, STYLE,
SIZE, OR COLOR.

OWNER OF U.S. REG. NOS. 2,252,358 AND 2,350,455.
NO CLAIM IS MADE TO THE EXCLUSIVE RIGHT TO
USE "CONNOISSEUR SELECTION", APART FROM THE
MARK AS SHOWN.
FOR CIGARS (U.S. CLS. 2, 8, 9 AND 17).
FIRST USE 6-5-1987; IN COMMERCE 6-5-1987.
ALICIA COLLINS, EXAMINING ATTORNEY

CLASS 34—(Continued).

SN 77-487,352. PHILIP MORRIS USA INC., RICHMOND, VA.
FILED 5-30-2008.



OWNER OF U.S. REG. NOS. 2,845,905 AND 2,848,647.
THE COLOR(S) MINT GREEN, SILVER, TAUPE, CREAM
AND BROWN IS/ARE CLAIMED AS A FEATURE OF THE
MARK.

THE MARK CONSISTS OF A RECTANGLE WITH A MINT
GREEN BORDER DIVIDED INTO TWO SMALLER REC-
TANGLES BY A THICK MINT GREEN HORIZONTAL
BAND WITH SILVER STRIPES ON THE TOP AND BOT-
TOM. THE MINT GREEN HORIZONTAL BAND IS LO-
CATED ONE THIRD OF THE WAY FROM THE TOP OF
THE BORDERED RECTANGLE. EACH OF THE SMALLER
RECTANGLES FEATURES A TAUPE MOTTLED PATTERN
ON A CREAM BACKGROUND. THE TOP RECTANGLE
CONTAINS A BROWN LEAF DESIGN IN THE CENTER.

FOR TOBACCO PRODUCTS, NAMELY, CIGARETTES
(U.S. CLS. 2, 8, 9 AND 17).
FIRST USE 7-0-2008; IN COMMERCE 7-0-2008.
KRISTIN CARLSON, EXAMINING ATTORNEY

SN 77-566,951. MCGHIE, TIMOTHY S., CEDAR CITY, UT.
FILED 9-10-2008.

It's A Boy

THE MARK CONSISTS OF STANDARD CHARACTERS
WITHOUT CLAIM TO ANY PARTICULAR FONT, STYLE,
SIZE, OR COLOR.

FOR CIGARETTE PAPER; CIGARETTE PAPERS; CI-
GARETTE ROLLING PAPERS (U.S. CLS. 2, 8, 9 AND 17).
RENEE SERVANCE, EXAMINING ATTORNEY

CLASS 34—(Continued).

SN 77-566,983. MCGHIE,TIMOTHY S., CEDAR CITY, UT. FILED 9-10-2008.

It's A Girl

THE MARK CONSISTS OF STANDARD CHARACTERS WITHOUT CLAIM TO ANY PARTICULAR FONT, STYLE, SIZE, OR COLOR.
FOR CIGARETTE PAPER; CIGARETTE PAPERS; CIGARETTE ROLLING PAPERS (U.S. CLS. 2, 8, 9 AND 17).
RENEE SERVANCE, EXAMINING ATTORNEY

CLASS 34—(Continued).

SN 79-053,328. DAVIDOFF & CIE SA, SWITZERLAND, FILED 4-21-2008.

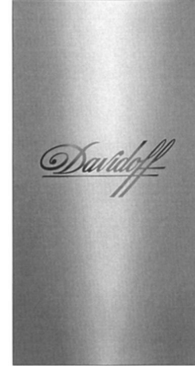

PRIORITY DATE OF 12-10-2007 IS CLAIMED.
OWNER OF INTERNATIONAL REGISTRATION 0962916 DATED 4-21-2008, EXPIRES 4-21-2018.
OWNER OF U.S. REG. NOS. 1,052,564, 3,270,683 AND OTHERS.
FOR CIGARETTES (U.S. CLS. 2, 8, 9 AND 17).
KATINA MISTER, EXAMINING ATTORNEY

SERVICE MARKS

SN 77-574,801. GALLAHER LIMITED, WEYBRIDGE, UNITED KINGDOM, FILED 9-19-2008.

LD

THE MARK CONSISTS OF STANDARD CHARACTERS WITHOUT CLAIM TO ANY PARTICULAR FONT, STYLE, SIZE, OR COLOR.
OWNER OF UNITED KINGDOM REG. NO. 2270223, DATED 5-16-2001, EXPIRES 5-16-2011.
FOR TOBACCO; SMOKING TOBACCO; PIPE TOBACCO; HAND ROLLING TOBACCO; CHEWING TOBACCO; CIGARETTES; CIGARETTES CONTAINING TOBACCO SUBSTITUTES NOT FOR MEDICAL PURPOSES; SNUFF; CIGARETTE PAPERS; CIGARETTE PAPER TUBES; CIGARETTE LIGHTERS NOT MADE OF PRECIOUS METAL; AND MATCHES (U.S. CLS. 2, 8, 9 AND 17).
CHERYL CLAYTON, EXAMINING ATTORNEY

CLASS 35—ADVERTISING AND BUSINESS

SN 76-652,069. CALLEEN CORDERO DESIGN, INC., NORTH HOLLYWOOD, CA. FILED 12-19-2005.

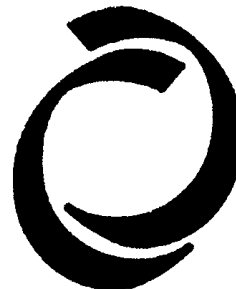

THE MARK CONSISTS OF STYLIZED "CC".
FOR RETAIL STORE, ON-LINE RETAIL STORE AND WHOLESALERS ORDERING SERVICES FEATURING FOOTWEAR, BELTS, HANDBAGS AND LEATHER GARMENTS (U.S. CLS. 100, 101 AND 102).
FIRST USE 8-1-1999; IN COMMERCE 8-1-1999.
JEFF DEFORD, EXAMINING ATTORNEY

CLASS 35—(Continued).

SN 76-664,399. CSMG INTERNATIONAL, LTD., CHICAGO, IL. FILED 8-10-2006.



FOR MARKETING CONSULTING SERVICES (U.S. CLS. 100, 101 AND 102).
FIRST USE 9-0-1998; IN COMMERCE 9-0-1998.
SHAILA SETTLES, EXAMINING ATTORNEY

CLASS 35—(Continued).

SN 76-692,612. BEVERAGE BEVOLUTIONS, INC., EL PASO, TX. FILED 9-8-2008.

SN 76-679,992. S. ABRAHAM & SONS, INC., WALKER, MI. FILED 7-27-2007.



NO CLAIM IS MADE TO THE EXCLUSIVE RIGHT TO USE "HOT OFF THE GRILL", APART FROM THE MARK AS SHOWN.

THE MARK CONSISTS OF A STYLIZED WAVING BANNER WHICH INCORPORATES THE WORDS "HOT OFF THE GRILL!" EXTENDING ALONG THE BANNER.

FOR DISTRIBUTORSHIP SERVICES FEATURING GRILLS, GRILL GUARDS, BUN CABINETS, CONDIMENT STATIONS, ADVERTISING KITS, SIGNAGE AND FOODS, ALL SOLD TO CONVENIENCE STORES, GROCERY STORES, AND DRUGSTORES (U.S. CLS. 100, 101 AND 102).

FIRST USE 0-0-2005; IN COMMERCE 0-0-2005.
KIMBERLY FRYE, EXAMINING ATTORNEY

VENRAY

SN 76-692,604. WIREMASTERS, INC., COLUMBIA, TN. FILED 9-5-2008.

QUALITY IS NOT EXPENSIVE, IT IS PRICELESS

THE MARK CONSISTS OF STANDARD CHARACTERS WITHOUT CLAIM TO ANY PARTICULAR FONT, STYLE, SIZE, OR COLOR.

FOR DISTRIBUTORSHIPS IN THE FIELD OF WIRES AND WIRE ACCESSORIES (U.S. CLS. 100, 101 AND 102).
FIRST USE 7-31-1988; IN COMMERCE 8-11-1988.
CAROL SPILS, EXAMINING ATTORNEY

FOR VENDING MACHINE SERVICES (U.S. CLS. 100, 101 AND 102).
FIRST USE 8-26-2008; IN COMMERCE 8-26-2008.
BERYL GARDNER, EXAMINING ATTORNEY

CLASS 35—(Continued).

SN 77-026,799. CAPOCCITTI, NICOLE MICHELLE BOWMAN-, HOPEWELL JUNCTION, NY. FILED 10-23-2006.



THE STIPPLING IS A FEATURE OF THE MARK. THE NAME(S), PORTRAIT(S), AND/OR SIGNATURE(S) SHOWN IN THE MARK IDENTIFIES CATARINA EL CAPOCCITTI, WHOSE CONSENT(S) TO REGISTER IS SUBMITTED.

THE COLOR(S) BLACK, WHITE, YELLOW, PINK, BLUE AND GREEN IS/ARE CLAIMED AS A FEATURE OF THE MARK.

THE MARK CONSISTS OF AN ARTISTIC RENDERING OF A GIRL WEARING A HAT, DRESS AND GLOVES. THE MARK IS PREDOMINANTLY SHOWN IN BLACK AND WHITE AND CONTAINS A SPOT OF YELLOW IN THE CENTER OF THE HAT AND PINK AROUND THE RIM OF THE HAT, A BLUE OUTLINE IN AND AROUND THE GIRL'S FACE, SHADES OF BLUE, GREEN, PINK AND YELLOW IN VARIOUS PLACES IN THE DRESS, BLACK AND WHITE GLOVES AND STIPPLING SHOWN IN THE GIRL'S HAT, HAIR, CLOTHING AND GLOVES.

FOR COMPUTERIZED ON-LINE RETAIL STORE SERVICES IN THE FIELD OF CHILDREN'S CLOTHING, TOYS, GIFTS; ON-LINE CONSIGNMENT SERVICES WHEREBY GOODS ARE RECEIVED ON CONSIGNMENT FOR AUCTION ON AN ONLINE AUCTION SITE; ON-LINE RETAIL STORE SERVICES FEATURING CHILDREN'S CLOTHING, TOYS, GIFTS; ON-LINE TRADING SERVICES IN WHICH SELLER POSTS PRODUCTS TO BE AUCTIONED AND BIDDING IS DONE VIA THE INTERNET; ONLINE AUCTION SERVICES; PROMOTING THE GOODS AND SERVICES OF OTHERS BY MEANS OF OPERATING AN ON-LINE SHOPPING MALL WITH LINKS TO THE RETAIL WEB SITES OF OTHERS; PROVIDING AND RENTAL OF ADVERTISING SPACE ON THE INTERNET; PROVIDING CONSUMER PRODUCT INFORMATION VIA THE INTERNET; PROVIDING INFORMATION ABOUT AND MAKING REFERRALS IN THE FIELD OF CONSUMER PRODUCTS AND SERVICES FOR RETAIL SERVICES CONCERNING PRODUCTS, SERVICES, EVENTS, ACTIVITIES, ATTRACTIONS AND FACILITIES IN PARTICULAR GEOGRAPHIC LOCATIONS; RETAIL APPAREL STORES; RETAIL CLOTHING BOUTIQUES; RETAIL CLOTHING STORES; RETAIL CONSIGNMENT STORES FEATURING CHILDREN'S CLOTHING, TOYS, GIFTS; RETAIL CONSIGNMENT STORES IN THE FIELD OF CHILDREN'S CLOTHING, TOYS, GIFTS; RETAIL DEPARTMENT STORES; RETAIL DISCOUNT STORE SERVICES IN THE FIELD OF CHILDREN'S CLOTHING, TOYS, GIFTS; RETAIL FURNITURE STORES; RETAIL GIFT SHOPS; RETAIL OUTLETS FEATURING CHILDREN'S CLOTHING, TOYS, GIFTS; RETAIL STORES FEATURING CHILDREN'S CLOTHING, TOYS, GIFTS; RETAIL VARIETY STORES; RETAIL CHILDREN'S CLOTHING, TOYS, GIFTS STORES (U.S. CLS. 100, 101 AND 102).

DAVID YONTEF, EXAMINING ATTORNEY

CLASS 35—(Continued).

SN 77-053,740. SCIENCE OF BUSINESS, CAMDEN, NJ. FILED 11-30-2006.

Science Of Business

THE MARK CONSISTS OF STANDARD CHARACTERS WITHOUT CLAIM TO ANY PARTICULAR FONT, STYLE, SIZE, OR COLOR.

NO CLAIM IS MADE TO THE EXCLUSIVE RIGHT TO USE "BUSINESS", APART FROM THE MARK AS SHOWN.

FOR BUSINESS ADVISORY SERVICES, CONSULTANCY AND INFORMATION (U.S. CLS. 100, 101 AND 102).

FIRST USE 10-22-2002; IN COMMERCE 12-1-2002.
SUNG IN, EXAMINING ATTORNEY

SN 77-075,530. GCS BUSINESS CAPITAL HOLDING COMPANY, LLC, LAKE FOREST, IL. FILED 1-3-2007.



NO CLAIM IS MADE TO THE EXCLUSIVE RIGHT TO USE "BUSINESS CAPITAL", APART FROM THE MARK AS SHOWN.

THE COLOR(S) GREEN, GOLD AND DARK GOLD IS/ARE CLAIMED AS A FEATURE OF THE MARK.

THE MARK CONSISTS OF THE CAPITAL LETTERS "G", "C" AND "S" FOLLOWED BY THE WORDS "BUSINESS CAPITAL" IN LOWER CASE. THE CAPITAL LETTERS "G", "C" AND "S" ARE ON A SQUARE GOLD BACKGROUND FOLLOWED BY A GREEN BAR. THE CAPITAL LETTERS "G" AND "S" ARE DARK GOLD. THE CAPITAL LETTER "C" IS GREEN. THE WORDS "BUSINESS CAPITAL" ARE GREEN.

FOR ASSISTANCE, ADVISORY SERVICES AND CONSULTANCY WITH BUSINESS PLANNING, SALES AND ACQUISITIONS (U.S. CLS. 100, 101 AND 102).

AMY HELLA, EXAMINING ATTORNEY

SN 77-121,946. PARDOT LLC, ATLANTA, GA. FILED 3-5-2007.

iCompare

THE MARK CONSISTS OF STANDARD CHARACTERS WITHOUT CLAIM TO ANY PARTICULAR FONT, STYLE, SIZE, OR COLOR.

FOR PROVIDING A SEARCHABLE ONLINE ADVERTISING GUIDE FEATURING THE GOODS AND SERVICES OF OTHER ON-LINE VENDORS ON THE INTERNET (U.S. CLS. 100, 101 AND 102).

FIRST USE 3-4-2007; IN COMMERCE 3-4-2007.

C. DIONNE CLYBURN, EXAMINING ATTORNEY

CLASS 35—(Continued).

SN 77-124,329. SENTRY LITIGATION CONSULTING, LLC, WASHINGTON, DC. FILED 3-7-2007.

Sentry Consulting Group

THE MARK CONSISTS OF STANDARD CHARACTERS WITHOUT CLAIM TO ANY PARTICULAR FONT, STYLE, SIZE, OR COLOR.

NO CLAIM IS MADE TO THE EXCLUSIVE RIGHT TO USE "CONSULTING GROUP", APART FROM THE MARK AS SHOWN.

FOR BUSINESS CONSULTATION SERVICES (U.S. CLS. 100, 101 AND 102).

FIRST USE 7-0-2005; IN COMMERCE 7-25-2005.
SANDRA MANIOS, EXAMINING ATTORNEY

SN 77-215,273. MEDIA SHOPS, INC., LAS VEGAS, NV. FILED 6-26-2007.

ADULT SUPERSTORES "WHERE COUPLES PREFER TO SHOP"

THE MARK CONSISTS OF STANDARD CHARACTERS WITHOUT CLAIM TO ANY PARTICULAR FONT, STYLE, SIZE, OR COLOR.

NO CLAIM IS MADE TO THE EXCLUSIVE RIGHT TO USE "ADULT SUPERSTORES", APART FROM THE MARK AS SHOWN.

FOR RETAIL STORE, SHOP AT HOME PARTY SERVICES, ONLINE ORDERING, MAIL ORDER AND CATALOG ORDERING SERVICES ALL FEATURING NOVELTY ITEMS, TOYS, MARITAL AIDS, SEXUAL AIDS, SEXUAL ENHANCEMENT PRODUCTS, GIFT ITEMS, ADULT THEMED MOVIES AND BOOKS, GREETING CARDS, LINGERIE, SWIMWEAR, CLOTHING, COSTUMES AND ACCESSORIES FOR MEN AND WOMEN; RETAIL STORE SERVICES IN THE FIELD OF LINGERIE, SWIMWEAR, LEATHERWEAR, MENS AND WOMENS UNDERWEAR, ADULT GAMES, GAG GIFTS, NOVELTIES, BATH ACCESSORIES, LUBES AND OILS, GREETING CARDS, TOYS, MARITAL AIDS, SEXUAL AIDS, SEXUAL ENHANCEMENT PRODUCTS, GIFT ITEMS, ADULT THEMED MOVIES AND BOOKS, CLOTHING, COSTUMES AND ACCESSORIES FOR MEN AND WOMEN (U.S. CLS. 100, 101 AND 102).

FIRST USE 6-30-1976; IN COMMERCE 6-30-1976.
WON TEAK OH, EXAMINING ATTORNEY

CLASS 35—(Continued).

SN 77-236,998. SUPERIOR PACKAGING COMPANY, DULUTH, MN. FILED 7-24-2007.



NO CLAIM IS MADE TO THE EXCLUSIVE RIGHT TO USE "SUPERIOR PACKAGING COMPANY", APART FROM THE MARK AS SHOWN.

THE MARK CONSISTS OF THREE LETTERS "SPC" WITH A SHADED OUTLINE OF EACH LETTER AND THE WORDS "SUPERIOR PACKAGING COMPANY" UNDERNEATH THE LETTERS.

FOR MERCHANDISE PACKAGING (U.S. CLS. 100, 101 AND 102).

FIRST USE 5-1-2007; IN COMMERCE 5-1-2007.
ANNE E. GUSTASON, EXAMINING ATTORNEY

SN 77-271,222. CALIFORNIA HEALTHCARE FOUNDATION, OAKLAND, CA. FILED 9-4-2007.



NO CLAIM IS MADE TO THE EXCLUSIVE RIGHT TO USE "ABOVE AVERAGE", APART FROM THE MARK AS SHOWN.

THE COLOR(S) GREEN IS/ARE CLAIMED AS A FEATURE OF THE MARK.

THE MARK CONSISTS OF THE WORDS "ABOVE AVERAGE" IN BLACK WITH HALF CIRCLES IN GREEN APPEARING ABOVE AND BELOW THE WORDS. THE CENTER OF THE MARK IS WHITE AND/OR SHADED IN GRAY. THE COLORS BLACK, WHITE AND GRAY CONSTITUTE BACKGROUND, SHADING AND TRANSPARENT AREAS AND ARE NOT USED AS COLORS IN THE MARK.

FOR MEDICAL EVALUATION SERVICES, NAMELY, PROVIDING QUALITATIVE AND QUANTITATIVE EVALUATIONS AND ANALYSIS REGARDING THE OPERATIONS, PERFORMANCE, AND RESULT OF SERVICES PROVIDED BY HOSPITALS, PHYSICIANS, NURSING HOMES, LONG-TERM CARE FACILITIES, AMBULATORY SURGERY CENTERS, IMAGING CENTERS, AND OUTPATIENT MEDICAL FACILITIES (U.S. CLS. 100, 101 AND 102).

CAROLYN GRAY, EXAMINING ATTORNEY

CLASS 35—(Continued).

SN 77-271,226. CALIFORNIA HEALTHCARE FOUNDATION, OAKLAND, CA. FILED 9-4-2007.



NO CLAIM IS MADE TO THE EXCLUSIVE RIGHT TO USE "AVERAGE", APART FROM THE MARK AS SHOWN.

THE COLOR(S) YELLOW IS/ARE CLAIMED AS A FEATURE OF THE MARK.

THE MARK CONSISTS OF THE WORD "AVERAGE" IN BLACK WITH HALF CIRCLES IN YELLOW APPEARING ABOVE AND BELOW THE WORD. THE CENTER OF THE MARK IS WHITE AND/OR SHADED IN GRAY. THE COLORS BLACK, WHITE AND GRAY CONSTITUTE BACKGROUND, SHADING AND TRANSPARENT AREAS AND ARE NOT USED AS COLORS IN THE MARK.

FOR MEDICAL EVALUATION SERVICES, NAMELY, PROVIDING QUALITATIVE AND QUANTITATIVE EVALUATIONS AND ANALYSIS REGARDING THE OPERATIONS, PERFORMANCE, AND RESULT OF SERVICES PROVIDED BY HOSPITALS, PHYSICIANS, NURSING HOMES, LONG-TERM CARE FACILITIES, AMBULATORY SURGERY CENTERS, IMAGING CENTERS, AND OUTPATIENT MEDICAL FACILITIES (U.S. CLS. 100, 101 AND 102).

CAROLYN GRAY, EXAMINING ATTORNEY

CLASS 35—(Continued).

SN 77-271,231. CALIFORNIA HEALTHCARE FOUNDATION, OAKLAND, CA. FILED 9-4-2007.



SN 77-271,229. CALIFORNIA HEALTHCARE FOUNDATION, OAKLAND, CA. FILED 9-4-2007.



NO CLAIM IS MADE TO THE EXCLUSIVE RIGHT TO USE "BELOW AVERAGE", APART FROM THE MARK AS SHOWN.

THE COLOR(S) ORANGE IS/ARE CLAIMED AS A FEATURE OF THE MARK.

THE MARK CONSISTS OF THE WORDS "BELOW AVERAGE" IN BLACK WITH HALF CIRCLES IN ORANGE APPEARING ABOVE AND BELOW THE WORDS. THE CENTER OF THE MARK IS WHITE AND/OR SHADED IN GRAY. THE COLORS BLACK, WHITE AND GRAY CONSTITUTE BACKGROUND, SHADING AND TRANSPARENT AREAS AND ARE NOT USED AS COLORS IN THE MARK.

FOR MEDICAL EVALUATION SERVICES, NAMELY, PROVIDING QUALITATIVE AND QUANTITATIVE EVALUATIONS AND ANALYSIS REGARDING THE OPERATIONS, PERFORMANCE, AND RESULT OF SERVICES PROVIDED BY HOSPITALS, PHYSICIANS, NURSING HOMES, LONG-TERM CARE FACILITIES, AMBULATORY SURGERY CENTERS, IMAGING CENTERS, AND OUTPATIENT MEDICAL FACILITIES (U.S. CLS. 100, 101 AND 102).

CAROLYN GRAY, EXAMINING ATTORNEY

NO CLAIM IS MADE TO THE EXCLUSIVE RIGHT TO USE "NOT RATED", APART FROM THE MARK AS SHOWN.

THE COLOR(S) BLACK, GRAY AND WHITE IS/ARE CLAIMED AS A FEATURE OF THE MARK.

THE MARK CONSISTS OF THE WORDS "NOT RATED" IN BLACK WITH HALF CIRCLES IN GRAY APPEARING ABOVE AND BELOW THE WORDS. THE CENTER OF THE MARK IS WHITE AND/OR SHADED IN GRAY. THE COLORS BLACK, WHITE AND GRAY CONSTITUTE BACKGROUND, SHADING AND TRANSPARENT AREAS AND ARE NOT USED AS COLORS IN THE MARK.

FOR MEDICAL EVALUATION SERVICES, NAMELY, PROVIDING QUALITATIVE AND QUANTITATIVE EVALUATIONS AND ANALYSIS REGARDING THE OPERATIONS, PERFORMANCE, AND RESULT OF SERVICES PROVIDED BY HOSPITALS, PHYSICIANS, NURSING HOMES, LONG-TERM CARE FACILITIES, AMBULATORY SURGERY CENTERS, IMAGING CENTERS, AND OUTPATIENT MEDICAL FACILITIES (U.S. CLS. 100, 101 AND 102).

CAROLYN GRAY, EXAMINING ATTORNEY

CLASS 35—(Continued).

SN 77-271,233. CALIFORNIA HEALTHCARE FOUNDATION, OAKLAND, CA. FILED 9-4-2007.



NO CLAIM IS MADE TO THE EXCLUSIVE RIGHT TO USE "POOR", APART FROM THE MARK AS SHOWN.

THE COLOR(S) RED IS/ARE CLAIMED AS A FEATURE OF THE MARK.

THE MARK CONSISTS OF THE WORD "POOR" IN BLACK WITH HALF CIRCLES IN RED APPEARING ABOVE AND BELOW THE WORDS. THE CENTER OF THE MARK IS WHITE AND/OR SHADED IN GRAY. THE COLORS BLACK, WHITE AND GRAY CONSTITUTE BACKGROUND, SHADING AND TRANSPARENT AREAS AND ARE NOT USED AS COLORS IN THE MARK.

FOR MEDICAL EVALUATION SERVICES, NAMELY, PROVIDING QUALITATIVE AND QUANTITATIVE EVALUATIONS AND ANALYSIS REGARDING THE OPERATIONS, PERFORMANCE, AND RESULT OF SERVICES PROVIDED BY HOSPITALS, PHYSICIANS, NURSING HOMES, LONG-TERM CARE FACILITIES, AMBULATORY SURGERY CENTERS, IMAGING CENTERS, AND OUTPATIENT MEDICAL FACILITIES (U.S. CLS. 100, 101 AND 102).

CAROLYN GRAY, EXAMINING ATTORNEY

CLASS 35—(Continued).

SN 77-271,235. CALIFORNIA HEALTHCARE FOUNDATION, OAKLAND, CA. FILED 9-4-2007.



NO CLAIM IS MADE TO THE EXCLUSIVE RIGHT TO USE "SUPERIOR", APART FROM THE MARK AS SHOWN. THE COLOR(S) GREEN IS/ARE CLAIMED AS A FEATURE OF THE MARK.

THE MARK CONSISTS OF THE WORDS "SUPERIOR" IN BLACK WITH HALF CIRCLES IN GREEN APPEARING ABOVE AND BELOW THE WORDS. THE CENTER OF THE MARK IS WHITE AND/OR SHADED IN GRAY. THE COLORS BLACK, WHITE AND GRAY CONSTITUTE BACKGROUND, SHADING AND TRANSPARENT AREAS AND ARE NOT USED AS COLORS IN THE MARK.

FOR MEDICAL EVALUATION SERVICES, NAMELY, PROVIDING QUALITATIVE AND QUANTITATIVE EVALUATIONS AND ANALYSIS REGARDING THE OPERATIONS, PERFORMANCE, AND RESULT OF SERVICES PROVIDED BY HOSPITALS, PHYSICIANS, NURSING HOMES, LONG-TERM CARE FACILITIES, AMBULATORY SURGERY CENTERS, IMAGING CENTERS, AND OUTPATIENT MEDICAL FACILITIES (U.S. CLS. 100, 101 AND 102).

CAROLYN GRAY, EXAMINING ATTORNEY

SN 77-289,437. JUICE STUDIOS, LLC, ATLANTA, GA. FILED 9-26-2007.

JUICE STUDIOS

THE MARK CONSISTS OF STANDARD CHARACTERS WITHOUT CLAIM TO ANY PARTICULAR FONT, STYLE, SIZE, OR COLOR.

NO CLAIM IS MADE TO THE EXCLUSIVE RIGHT TO USE "STUDIOS", APART FROM THE MARK AS SHOWN.

FOR ARRANGING AND CONDUCTING BUSINESS CONFERENCES; ARRANGING AND CONDUCTING MARKETING PROMOTIONAL EVENTS FOR OTHERS, NAMELY, BUSINESS MEETINGS, EVENTS AND CONFERENCES; PRODUCING PROMOTIONAL VIDEOTAPES, VIDEO DISCS, AND AUDIO VISUAL RECORDINGS; PROVIDING MARKETING AND PROMOTION OF SPECIAL EVENTS, SPECIFICALLY, BUSINESS MEETINGS, EVENTS AND CONFERENCES; POST-PRODUCTION EDITING SERVICES FOR VIDEO AND AUDIO COMMERCIALS; PRODUCING AUDIO OR VIDEO INFOMERCIALS; PRODUCTION OF TELEVISION COMMERCIALS; TRANSPORTATION MANAGEMENT SERVICES, NAMELY, PLANNING AND COORDINATING TRANSPORTATION OF PEOPLE FOR OTHERS (U.S. CLS. 100, 101 AND 102).

FIRST USE 10-0-2004; IN COMMERCE 10-0-2004.

JOHN SCHUYLER YARD, EXAMINING ATTORNEY

CLASS 35—(Continued).

SN 77-314,093. SLMZ ENTERPRISES, INC., ROCKAWAY PARK, NY. FILED 10-26-2007.

LITLEDUDESANDDIVAS

THE MARK CONSISTS OF STANDARD CHARACTERS WITHOUT CLAIM TO ANY PARTICULAR FONT, STYLE, SIZE, OR COLOR.

FOR ON-LINE RETAIL STORE SERVICES FEATURING INFANT AND YOUNG CHILDREN'S BLANKETS, BED LINENS, BED LINERS, BEDDING SETS, MATTRESS PADS, CHANGING PADS AND MATS, SPILL MATS, TOWELS, SOFT PUPPETS, GROWTH CHARTS, AND DISH AND UTENSIL SETS; AND FEATURING BAGS, NAMELY, DIAPER BAGS, MESSENGER BAGS, TOTE BAGS, SPORT BAGS, INSULATED BOTTLE BAGS, WRIST BAGS, WIPES CASES, SNACK PACKS, AND BACKPACKS; AND FEATURING CLOCKS, PENS, SCRIBBLE PADS, AND LUNCHBOXES (U.S. CLS. 100, 101 AND 102).

FIRST USE 5-18-2007; IN COMMERCE 5-18-2007.
LESLIE RICHARDS, EXAMINING ATTORNEY

SN 77-326,838. ENMARK VENTURES, LTD., KASLO, CANADA, FILED 11-12-2007.



THE COLOR(S) DARK BLUE, LIGHT BLUE AND YELLOW IS/ARE CLAIMED AS A FEATURE OF THE MARK.

THE MARK CONSISTS OF THE WORDING "WIN WITHOUT PITCHING" IN SANS-SERIF FONT. THE WORD "WIN" IS DARK BLUE. THE WORD "WITHOUT" IS LIGHT BLUE. THE WORD "PITCHING" IS YELLOW.

FOR MARKETING SERVICES, NAMELY, BUSINESS CONSULTING IN THE FIELD OF RETAIL SALES AND BUSINESS CONSULTING SERVICES IN THE NATURE OF PROVIDING ASSISTANCE IN DEVELOPMENT OF BUSINESS STRATEGIES AND CREATIVE IDEATION (U.S. CLS. 100, 101 AND 102).

FIRST USE 4-1-2002; IN COMMERCE 4-1-2002.
WENDY GOODMAN, EXAMINING ATTORNEY

CLASS 35—(Continued).

SN 77-336,501. IMDB.COM, INC., SEATTLE, WA. FILED 11-26-2007.

SOUNDUNWOUND

THE MARK CONSISTS OF STANDARD CHARACTERS WITHOUT CLAIM TO ANY PARTICULAR FONT, STYLE, SIZE, OR COLOR.

FOR PROVIDING AN ON-LINE COMMERCIAL INFORMATION DIRECTORY FEATURING GENERAL NEWS AND INFORMATION REGARDING ENTERTAINMENT, MUSIC, MUSIC COMMUNITY, SONGS, ARTISTS, ALBUMS, FILMS, LYRICS, GRAPHICS, ANIMATION AND MULTIMEDIA PRESENTATIONS, VIDEOS AND DVDS, AND OTHER AUDIOVISUAL OR MUSICAL WORKS, LIVE CONCERTS, AUDIO BROADCASTING OF SPOKEN WORDS, RADIO PROGRAMS AND PROGRAMS BROADCAST OVER THE INTERNET; DISSEMINATION OF ADVERTISING FOR OTHERS VIA AN ON-LINE ELECTRONIC COMMUNICATIONS NETWORK; PROVIDING A SEARCHABLE ON-LINE ADVERTISING GUIDE FEATURING THE GOODS AND SERVICES OF OTHERS; COMPUTERIZED DATABASE MANAGEMENT SERVICES; ON-LINE ORDERING SERVICES FEATURING MUSIC, SONGS, ALBUMS, LYRICS, GRAPHICS, ANIMATION AND MULTIMEDIA PRESENTATIONS, AND OTHER AUDIOVISUAL OR MUSICAL WORKS; ONLINE RETAIL STORE SERVICES IN THE FIELDS OF MUSICAL, AUDIOVISUAL AND LITERARY WORKS, DIGITAL RECORDINGS AND RELATED MERCHANDISE, ELECTRONIC AND COMMUNICATIONS DEVICES, AND PERIPHERAL DEVICES FOR ELECTRONIC AND COMMUNICATIONS DEVICES; ONLINE RETAIL STORE SERVICES FEATURING DOWNLOADABLE RING TONES (U.S. CLS. 100, 101 AND 102).

CAROL SPILS, EXAMINING ATTORNEY

SN 77-352,165. TRANSNATIONAL FOODS, INC., MIAMI, FL. FILED 12-14-2007.

TRANSNATIONAL FOODS

THE MARK CONSISTS OF STANDARD CHARACTERS WITHOUT CLAIM TO ANY PARTICULAR FONT, STYLE, SIZE, OR COLOR.

NO CLAIM IS MADE TO THE EXCLUSIVE RIGHT TO USE "FOODS", APART FROM THE MARK AS SHOWN.

SEC. 2(F),
FOR IMPORT AND EXPORT AGENCY (U.S. CLS. 100, 101 AND 102).

FIRST USE 10-17-2002; IN COMMERCE 10-17-2002.
SUZANNE BLANE, EXAMINING ATTORNEY

CLASS 35—(Continued).

SN 77-363,246. TALENT SOLUTIONS, INC., NEW YORK, NY, NY. FILED 1-3-2008.



OWNER OF U.S. REG. NOS. 2,880,002 AND 3,186,000.
NO CLAIM IS MADE TO THE EXCLUSIVE RIGHT TO USE "TALENT SOLUTIONS", APART FROM THE MARK AS SHOWN.

THE COLOR(S) RED AND GREY IS/ARE CLAIMED AS A FEATURE OF THE MARK.

THE MARK CONSISTS OF A RED PERFORMER JUGGLING RED BALLS, WITH THE WORD "TALENT SOLUTIONS" IN GREY, WITH THE LETTER "O" IN TALENT SOLUTIONS IN RED.

FOR BUSINESS CONSULTATION IN THE FIELD OF ADVERTISING, TELEVISION AND FILM, SPECIFICALLY IN THE AREAS OF PRODUCTION, MUSIC, AND TALENT; LABOR RELATIONS SERVICES, NAMELY PROVIDING ACCESS TO UNION TALENT (U.S. CLS. 100, 101 AND 102).

FIRST USE 12-31-2002; IN COMMERCE 12-31-2002.
KAPIL BHANOT, EXAMINING ATTORNEY

SN 77-365,902. TLC LIGHTING, INC., HICKORY, KY. FILED 1-7-2008.

TLC HOME

THE MARK CONSISTS OF STANDARD CHARACTERS WITHOUT CLAIM TO ANY PARTICULAR FONT, STYLE, SIZE, OR COLOR.

OWNER OF U.S. REG. NO. 2,795,172.

NO CLAIM IS MADE TO THE EXCLUSIVE RIGHT TO USE "HOME", APART FROM THE MARK AS SHOWN.

FOR WHOLESALE DISTRIBUTORSHIPS, MAIL ORDER CATALOGUE SERVICES, AND ELECTRONIC RETAIL STORE SERVICES FEATURING LAMPS, LAMP SHADES, LAMP ACCESSORIES, LIGHT BULBS, HOME ACCENT FURNITURE AND ACCESSORIES, RUGS, CHANDELIERS, LIGHTING FIXTURES, CEILING FANS, AND DECORATIVE FANS (U.S. CLS. 100, 101 AND 102).

MICHAEL ENGEL, EXAMINING ATTORNEY

CLASS 35—(Continued).

SN 77-370,376. SAGE TREE, LLC, NAPERVILLE, IL. FILED 1-13-2008.



NO CLAIM IS MADE TO THE EXCLUSIVE RIGHT TO USE "ONLINE AND RETAIL SALES", APART FROM THE MARK AS SHOWN.

THE COLOR(S) SAGE, BLACK AND WHITE IS/ARE CLAIMED AS A FEATURE OF THE MARK.

THE MARK CONSISTS OF A WHITE TREE ON A SAGE BACKGROUND ON THE LEFT HAND SIDE OF THE MARK. THE WORD "SAGE" IS IN BLACK AND THE WORD "TREE" IS IN THE COLOR SAGE. BOTH OF THE WORDS "SAGE" AND "TREE" ARE TO THE RIGHT OF THE BLOCK TREE PICTURE. THE WORDS "ONLINE AND RETAIL SALES" ARE ALL IN BLACK UNDER THE LARGER WORDS "SAGE TREE".

FOR BUSINESS MANAGEMENT CONSULTING IN THE FIELD OF RETAIL SALES OF CONSUMER GOODS (U.S. CLS. 100, 101 AND 102).

FIRST USE 4-1-2007; IN COMMERCE 4-1-2007.

EMILY CARLSEN, EXAMINING ATTORNEY

SN 77-374,246. ACERA LLC, LEESBURG, VA. FILED 1-17-2008.



OWNER OF U.S. REG. NO. 3,247,178.

NO CLAIM IS MADE TO THE EXCLUSIVE RIGHT TO USE "PLAN", APART FROM THE MARK AS SHOWN.

THE COLOR(S) RED, WHITE AND BLUE IS/ARE CLAIMED AS A FEATURE OF THE MARK.

THE MARK CONSISTS OF THE WORDS "ACERA PATRIOT PLAN" TO THE LEFT OF AN EAGLE WITH ITS HEAD POINTED TO THE RIGHT, WITH THE BODY OF THE EAGLE BEING BLUE AND THE WINGS SPREAD AND COMPRISED OF RED AND WHITE ALTERNATING STRIPES, AND THE A WHITE FIVE-POINTED STAR IN THE MIDDLE OF THE ICON OF THE EAGLE; THE EYE OF THE EAGLE CONSISTS OF A WHITE CUT-OUT IN THE SHAPE OF AN EYE; THE WORD "ACERA" IS IN CAPITAL LETTERS IN RED, TO THE LEFT OF THE WORD "PATRIOT" WHICH LETTERS ARE BLUE WITH ONLY THE "P" CAPITALIZED, AND THE DOT ABOVE THE LOWER CASE "I" IS REPLACED WITH A RED FIVE-POINTED STAR; THE WORD "PLAN" IS FEATURED IN SMALLER SIZED, RED CAPITAL LETTERS AND LOCATED UNDER THE LETTERS "IOT" IN THE WORD "PATRIOT"; THERE IS A THIN RED LINE UNDER THE WORD "ACERA" AND THE LETTERS "PATR" IN "PATRIOT", LOCATED IMMEDIATELY TO THE LEFT OF THE WORD "PLAN".

THE FOREIGN WORDING IN THE MARK TRANSLATES INTO ENGLISH AS PAVEMENT.

FOR ATTORNEY REFERRALS; LAWYER REFERRALS (U.S. CLS. 100, 101 AND 102).

FIRST USE 7-10-2007; IN COMMERCE 7-10-2007.

KAREN K. BUSH, EXAMINING ATTORNEY

CLASS 35—(Continued).

SN 77-376,628. DON BUMGARDNER, FORT WORTH, TX. FILED 1-21-2008.

CLASS 35—(Continued).

SN 77-384,714. WALDO'S HOLDINGS, LLC, BOULDER, CO. FILED 1-30-2008.

DONCO TRADING COMPANY

THE MARK CONSISTS OF STANDARD CHARACTERS WITHOUT CLAIM TO ANY PARTICULAR FONT, STYLE, SIZE, OR COLOR.

NO CLAIM IS MADE TO THE EXCLUSIVE RIGHT TO USE "TRADING COMPANY", APART FROM THE MARK AS SHOWN.

FOR RETAIL FURNITURE STORES (U.S. CLS. 100, 101 AND 102).

FIRST USE 6-15-2000; IN COMMERCE 6-15-2000.
KAREN K. BUSH, EXAMINING ATTORNEY



SN 77-384,426. WALDO'S HOLDINGS, LLC, BOULDER, CO. FILED 1-30-2008.

WALDO'S \$1 MART

THE MARK CONSISTS OF STANDARD CHARACTERS WITHOUT CLAIM TO ANY PARTICULAR FONT, STYLE, SIZE, OR COLOR.

OWNER OF U.S. REG. NOS. 2,540,911 AND 2,559,384.

NO CLAIM IS MADE TO THE EXCLUSIVE RIGHT TO USE "\$1 MART", APART FROM THE MARK AS SHOWN.

THE NAME "WALDO'S" DOES NOT IDENTIFY A LIVING INDIVIDUAL.

FOR RETAIL DISCOUNT STORE SERVICES FEATURING FOODS, NAMELY, GROCERIES, SNACKS, DELICATESSEN AND FROZEN FOODS, BEVERAGES, CLOTHING, OVER THE COUNTER DRUGS AND MEDICAL PRODUCTS, VITAMINS, HEALTH AND BEAUTY AIDS, PERFUMERY, COSMETICS, HAIR AND BODY LOTIONS, SOAPS, NOVELTY GOODS, GAMES, TOYS, HOUSEHOLD PRODUCTS, HOUSEWARES, HOUSEHOLD AND KITCHEN UTENSILS, GLASSWARE, COOKWARE, HOUSEHOLD CLEANING PRODUCTS, PAPER GOODS, NAMELY, TOWELS, TISSUES AND NAPKINS, SANITARY PREPARATIONS, DIAPERS, BOOKS, MAGAZINES, GREETING CARDS, SCHOOL SUPPLIES AND STATIONERY, PARTY GOODS, BABY PRODUCTS, SEASONAL AND HOLIDAY PRODUCTS, AUTOMOTIVE PRODUCTS AND ACCESSORIES AND HARDWARE (U.S. CLS. 100, 101 AND 102).

SUZANNE BLANE, EXAMINING ATTORNEY

OWNER OF U.S. REG. NOS. 2,540,911 AND 2,559,384.

NO CLAIM IS MADE TO THE EXCLUSIVE RIGHT TO USE "\$1 MART", APART FROM THE MARK AS SHOWN.

THE NAME "WALDO'S" DOES NOT IDENTIFY A LIVING INDIVIDUAL.

THE MARK CONSISTS OF "WALDO'S \$1 MART" WRITTEN SUCH THAT THE TYPOGRAPHICAL SYMBOL "\$" AND THE NUMBER "1" APPEARS AT AN ANGLE INSIDE A LARGE SHADED CIRCLE WITH THE TERMS "WALDO'S MART" SUPERIMPOSED OVER IT.

FOR RETAIL DISCOUNT STORE SERVICES FEATURING FOODS, NAMELY, GROCERIES, SNACKS, DELICATESSEN AND FROZEN FOODS, BEVERAGES, CLOTHING, OVER THE COUNTER DRUGS AND MEDICAL PRODUCTS, VITAMINS, HEALTH AND BEAUTY AIDS, PERFUMERY, COSMETICS, HAIR AND BODY LOTIONS, SOAPS, NOVELTY GOODS, GAMES, TOYS, HOUSEHOLD PRODUCTS, HOUSEWARES, HOUSEHOLD AND KITCHEN UTENSILS, GLASSWARE, COOKWARE, HOUSEHOLD CLEANING PRODUCTS, PAPER GOODS, NAMELY, TOWELS, TISSUES AND NAPKINS, SANITARY PREPARATIONS, DIAPERS, BOOKS, MAGAZINES, GREETING CARDS, SCHOOL SUPPLIES AND STATIONERY, PARTY GOODS, BABY PRODUCTS, SEASONAL AND HOLIDAY PRODUCTS, AUTOMOTIVE PRODUCTS AND ACCESSORIES AND HARDWARE (U.S. CLS. 100, 101 AND 102).

SUZANNE BLANE, EXAMINING ATTORNEY

CLASS 35—(Continued).

SN 77-384,731. WALDO'S HOLDINGS, LLC, BOULDER, CO.
FILED 1-30-2008.



OWNER OF U.S. REG. NOS. 2,540,911 AND 2,559,384.
NO CLAIM IS MADE TO THE EXCLUSIVE RIGHT TO
USE "\$1 MART", APART FROM THE MARK AS SHOWN.
THE NAME "WALDO'S" DOES NOT IDENTIFY A LIVING
INDIVIDUAL.

THE MARK CONSISTS OF "WALDO'S \$1 MART" WRIT-
TEN SUCH THAT "\$1" IS ENCLOSED IN A BLACKENED
CIRCLE BETWEEN "WALDO'S" AND "MART".

FOR RETAIL DISCOUNT STORE SERVICES FEATUR-
ING FOODS, NAMELY, GROCERIES, SNACKS, DELI-
CATESSEN AND FROZEN FOODS, BEVERAGES,
CLOTHING, OVER THE COUNTER DRUGS AND MEDICAL
PRODUCTS, VITAMINS, HEALTH AND BEAUTY
AIDS, PERFUMERY, COSMETICS, HAIR AND BODY
LOTIONS, SOAPS, NOVELTY GOODS, GAMES, TOYS,
HOUSEHOLD PRODUCTS, HOUSEWARES, HOUSE-
HOLD AND KITCHEN UTENSILS, GLASSWARE, COOK-
WARE, HOUSEHOLD CLEANING PRODUCTS, PAPER
GOODS, NAMELY, TOWELS, TISSUES AND NAPKINS,
SANITARY PREPARATIONS, DIAPERS, BOOKS, MA-
GAZINES, GREETING CARDS, SCHOOL SUPPLIES AND
STATIONERY, PARTY GOODS, BABY PRODUCTS,
SEASONAL AND HOLIDAY PRODUCTS, AUTOMOTIVE
PRODUCTS AND ACCESSORIES AND HARDWARE
(U.S. CLS. 100, 101 AND 102).
SUZANNE BLANE, EXAMINING ATTORNEY

SN 77-385,124. PALLADIUM GROUP, INC., LINCOLN, MA.
FILED 1-31-2008.

PALLADIUM EXECUTING STRATEGY

THE MARK CONSISTS OF STANDARD CHARACTERS
WITHOUT CLAIM TO ANY PARTICULAR FONT, STYLE,
SIZE, OR COLOR.

NO CLAIM IS MADE TO THE EXCLUSIVE RIGHT TO
USE "EXECUTING STRATEGY", APART FROM THE
MARK AS SHOWN.

FOR CONSULTING SERVICES IN THE FIELD OF
BUSINESS ORGANIZATION, STRATEGY AND MAN-
AGEMENT; VALUE-ADDED RESELLER SERVICES,
NAMELY, DISTRIBUTORSHIP SERVICES FEATURING
COMPUTER SOFTWARE IN THE FIELD OF BUSINESS
INTELLIGENCE (U.S. CLS. 100, 101 AND 102).

FIRST USE 5-0-2005; IN COMMERCE 5-0-2005.
LESLEY LAMOTHE, EXAMINING ATTORNEY

CLASS 35—(Continued).

SN 77-386,487. VIDEOEGG, INC., SAN FRANCISCO, CA.
FILED 2-1-2008.

ADFRAMES

THE MARK CONSISTS OF STANDARD CHARACTERS
WITHOUT CLAIM TO ANY PARTICULAR FONT, STYLE,
SIZE, OR COLOR.

FOR ADVERTISING SERVICES, NAMELY, THE DIS-
SEMINATION OF ADVERTISING FOR OTHERS
THROUGH DIGITAL AND ONLINE MEDIA AND THE
TRACKING FOR OTHERS OF VIEWERSHIP OF SUCH
ADVERTISING (U.S. CLS. 100, 101 AND 102).

NATALIE POLZER, EXAMINING ATTORNEY

SN 77-386,714. ROGER ANNALISA MARIE, DBA KENNEDY
ANNALISA , KENNEDY ANNALISA MARIE, LARK-
SPUR, CA. FILED 2-1-2008.

DotGreen

THE MARK CONSISTS OF STANDARD CHARACTERS
WITHOUT CLAIM TO ANY PARTICULAR FONT, STYLE,
SIZE, OR COLOR.

FOR ACCOUNTING SERVICES; ACCOUNTS RECEI-
VABLE SERVICES; ADMINISTERING PHARMACY RE-
IMBURSEMENT PROGRAMS AND SERVICES;
ADMINISTRATION AND MANAGEMENT OF RE-
SEARCH GRANTS; ADMINISTRATION OF A DIS-
COUNT PROGRAM FOR ENABLING PARTICIPANTS
TO OBTAIN DISCOUNTS ON GOODS AND SERVICES
THROUGH USE OF A DISCOUNT MEMBERSHIP CARD;
ADMINISTRATION OF A PROGRAM FOR ENABLING
PARTICIPANTS TO OBTAIN DISCOUNTS ON GOODS
AND RECEIVE IMPROVED SERVICES; ADMINISTRA-
TION OF BUSINESS PAYROLL FOR OTHERS; ADMIN-
ISTRATION OF COMMUNITY RECREATIONAL
SPORTS LEAGUES; ADMINISTRATION OF CULTURAL
AND EDUCATIONAL EXCHANGE PROGRAMS; AD-
MINISTRATION OF PATIENT REIMBURSEMENT PRO-
GRAMS; ADMINISTRATION, BILLING AND
RECONCILIATION OF ACCOUNTS ON BEHALF OF
OTHERS; ADMINISTRATIVE ACCOUNTING; ADMIN-
ISTRATIVE HOTEL MANAGEMENT; ADMINISTRA-
TIVE PROCESSING OF PURCHASE ORDERS;
ADMINISTRATIVE PROCESSING OF PURCHASE OR-
DERS WITHIN THE FRAMEWORK OF SERVICES PRO-
VIDED BY MAIL-ORDER COMPANIES; ADVERTISING
AGENCIES, NAMELY, PROMOTING THE GOODS AND
SERVICES OF OTHERS; ADVERTISING AGENCIES,
NAMELY, PROMOTING THE SERVICES OF TOP LEVEL
DOMAIN REGISTRY THROUGH THE DISTRIBUTION
OF PRINTED AND AUDIO PROMOTIONAL MATERI-
ALS AND BY RENDERING SALES PROMOTION AD-
VICE; ADVERTISING AND ADVERTISEMENT
SERVICES; ADVERTISING AND BUSINESS ADVICE
RELATING TO TELEMATICS' SERVICES; ADVERTIS-
ING AND BUSINESS SERVICES, NAMELY, SECURING
AIRTIME ON ALL FORMS OF MEDIA COMMUNICA-
TIONS STATIONS, SYSTEMS, NETWORKS, AND SER-
VICES FOR THE PURPOSE OF PROMOTING THE
GOODS AND SERVICES OF OTHERS; ADVERTISING
AND COMMERCIAL INFORMATION SERVICES, VIA
THE INTERNET; ADVERTISING AND PROMOTION
SERVICES AND RELATED CONSULTING; ADVERTIS-
ING AND PROMOTIONAL SERVICES; ADVERTISING
AND PUBLICITY SERVICES; ADVERTISING AND PUB-

CLASS 35—(Continued).

LICITY SERVICES, NAMELY, PROMOTING THE GOODS, SERVICES, BRAND IDENTITY AND COMMERCIAL INFORMATION AND NEWS OF THIRD PARTIES THROUGH PRINT, AUDIO, VIDEO, DIGITAL AND ON-LINE MEDIUM; ADVERTISING PARTICULARLY SERVICES FOR THE PROMOTION OF GOODS; ADVERTISING SERVICES; ADVERTISING SERVICES FOR PROMOTING THE BROKERAGE OF STOCKS AND OTHER SECURITIES; ADVERTISING SERVICES OF A RADIO AND TELEVISION ADVERTISING AGENCY; ADVERTISING SERVICES RELATING TO SANDWICHES; ADVERTISING SERVICES, FOR THIRD PARTIES, IN CONNECTION WITH THE COMMERCIALIZATION AND SALE OF PERFUMERY AND COSMETIC ARTICLES, PRODUCTS FOR HOUSEHOLD PURPOSES, OPTICAL PRODUCTS, CLOCKS AND TIMEPIECES, JEWELLERY, FURNISHING ARTICLES; ADVERTISING SERVICES, NAMELY, CREATING CORPORATE AND BRAND IDENTITY FOR OTHERS; ADVERTISING SERVICES, NAMELY, CREATING CORPORATE LOGOS FOR OTHERS; ADVERTISING SERVICES, NAMELY, PROMOTING AND MARKETING THE GOODS AND SERVICES OF OTHERS THROUGH ALL PUBLIC COMMUNICATION MEANS; ADVERTISING SERVICES, NAMELY, PROMOTING PROPERTIES FOR SALE BY OWNER VIA THE INTERNET; ADVERTISING SERVICES, NAMELY, PROMOTING THE FOOD AND WINE OF OTHERS; ADVERTISING SERVICES, NAMELY, PROMOTING THE GIFT CARDS OF OTHERS; ADVERTISING SERVICES, NAMELY, PROMOTING THE SANDWICHES OF OTHERS; ADVERTISING SERVICES, NAMELY, PROVIDING ADVERTISING SPACE IN A PERIODICAL; ADVERTISING SERVICES, NAMELY, PROVIDING INFORMATION AS TO THE AVAILABILITY OF DOMAIN NAMES FOR RENT OR PURCHASE; ADVERTISING SERVICES, PUBLIC RELATIONS AND MARKETING SERVICES, NAMELY, PROMOTING AND MARKETING THE GOODS AND SERVICES OF OTHERS THROUGH ALL PUBLIC COMMUNICATION MEANS; ADVERTISING VIA ELECTRONIC MEDIA AND SPECIFICALLY THE INTERNET; ADVERTISING, INCLUDING PROMOTION OF PRODUCTS AND SERVICES OF THIRD PARTIES THROUGH SPONSORING ARRANGEMENTS AND LICENSE AGREEMENTS RELATING TO INTERNATIONAL SPORTS' EVENTS; ADVERTISING, INCLUDING PROMOTION RELATING TO THE SALE OF ARTICLES AND SERVICES FOR THIRD PARTIES BY THE TRANSMISSION OF ADVERTISING MATERIAL AND THE DISSEMINATION OF ADVERTISING MESSAGES ON COMPUTER NETWORKS; ADVERTISING, MARKETING AND PROMOTION SERVICES; ADVERTISING, MARKETING AND PROMOTIONAL SERVICES FOR AUTOMOTIVE DEALERSHIPS; ADVERTISING, MARKETING AND PROMOTIONAL SERVICES FOR THE DONATION OF HUMAN BLOOD THAT EXACTLY MATCHES THE BLOOD TYPE OF INDIVIDUALS NEEDING TRANSFUSIONS; ADVERTISING, PROMOTION AND MARKETING SERVICES IN THE NATURE OF E-MAIL BLAST CAMPAIGNS FOR OTHERS; ADVICE AND INFORMATION ABOUT CUSTOMER SERVICES AND PRODUCT MANAGEMENT AND PRICES ON INTERNET SITES IN CONNECTION WITH PURCHASES MADE OVER THE INTERNET; ADVISORY AND CONSULTANCY SERVICES RELATING TO EXPORT, EXPORT SERVICES, EXPORT PROMOTION INFORMATION AND SERVICES; ADVISORY SERVICE FOR ORGANIZATIONAL ISSUES AND BUSINESS ADMINISTRATION, WITH AND WITHOUT THE HELP OF ELECTRONIC DATA BASES; ADVISORY SERVICES RELATING TO BUSINESS MANAGEMENT AND BUSINESS OPERATIONS; AGENCY REPRESENTATION FOR HOME RENTERS OBTAINING NEEDED INTERNET SERVICES; AIRCRAFT CREW SCHEDULING SERVICES; ALCOHOLIC BEVERAGE PROCUREMENT SERVICES FOR OTHERS; AN INTERACTIVE WEB SITE FOR USERS TO REVIEW AND RATE INTERNET CONTENT, PEOPLE, COMPANIES, PRODUCTS AND/OR SERVICES UTILIZING A SOFTWARE APPLICATION TO AWARD POINTS WHEREBY WEB SITE USERS ARE ELIGIBLE TO EXCHANGE POINTS EARNED FOR PROMOTIONAL ITEMS CONSISTING OF COUPONS, REBATES, DISCOUNTS OR SPECIAL OFFERINGS ON GOODS AND/OR SERVICE PROVIDED BY WEB SITE SPONSORS; APPOINTMENT SCHEDULING SERVICES; ARRANGING AND CONDUCTING AUCTIONS IN THE FIELD OF INTERNET DOMAIN

CLASS 35—(Continued).

NAMES; ARRANGING AND CONDUCTING INCENTIVE REWARD PROGRAMS TO PROMOTE THE SALE OF INTERNET DOMAIN NAMES; ARRANGING OF CONTRACTUAL SERVICES WITH THIRD PARTIES; ARRANGING SUBSCRIPTIONS TO TELECOMMUNICATION SERVICES; ASSISTANCE, ADVISORY SERVICES AND CONSULTANCY WITH REGARD TO BUSINESS PLANNING, BUSINESS ANALYSIS, BUSINESS MANAGEMENT, AND BUSINESS ORGANIZATION; ASSOCIATION SERVICES, NAMELY, PROMOTING DIVERSITY IN THE RESTAURANT AND HOTEL INDUSTRIES ON BEHALF OF EMPLOYEES, VENDORS, MANAGEMENT, AND OWNERS; AUCTION MANAGEMENT SERVICES PROVIDED TO OTHERS OVER AN ON-LINE WEB SITE ACCESSED THROUGH A GLOBAL COMPUTER NETWORK; BRIDAL REGISTRY SERVICES; BUSINESS ADMINISTRATION AND MANAGEMENT; BUSINESS ADMINISTRATION AND OFFICE WORK; BUSINESS ADMINISTRATION CONSULTANCY; BUSINESS ADVISORY SERVICES, CONSULTANCY AND INFORMATION; BUSINESS CARD DESIGN SERVICES; BUSINESS CONSULTATION SERVICES; BUSINESS CONSULTATION SERVICES TO ASSIST NON-PROFIT ORGANIZATIONS IN PLANNING, MANAGING, AND CONDUCTING FUND RAISING ACTIVITIES VIA A GLOBAL COMPUTER NETWORK; BUSINESS CONSULTING AND INFORMATION SERVICES; BUSINESS CONSULTING SERVICE IN THE FIELD OF MEDICAL IMAGING CENTERS; BUSINESS CONSULTING SERVICES IN THE FIELD OF BUSINESS KNOWLEDGE TRANSFER THROUGH AUDIO TOOLS, NAMELY, RECORDING INTERVIEWS WITH SUBJECT MATTER EXPERTS FOR AN ORGANIZATION'S CAPTURE AND FUTURE USE; BUSINESS CONSULTING SERVICES IN THE FIELD OF ORGANIZATIONAL CHANGE MANAGEMENT; BUSINESS CONSULTING SERVICES RELATING TO PRODUCT DISTRIBUTION, OPERATIONS MANAGEMENT SERVICES, LOGISTICS, REVERSE LOGISTICS, SUPPLY CHAIN, AND PRODUCTION SYSTEMS AND DISTRIBUTION SOLUTIONS; BUSINESS CONSULTING SERVICES, NAMELY, ASSISTING LEGAL PROFESSIONALS IN ORGANIZING AND SETTING UP THEIR PRACTICES FOR OFFERING DIVORCE PLANNING AND FACILITATION AND LEGAL DOCUMENT SERVICES TO THEIR CLIENTS; BUSINESS DEVELOPMENT SERVICES, NAMELY, PROVIDING START-UP SUPPORT FOR BUSINESSES OF OTHERS; BUSINESS INFORMATION AND ACCOUNTING ADVISORY SERVICES; BUSINESS INFORMATION SERVICES AND APPRAISALS; BUSINESS INFORMATION SERVICES IN THE NATURE OF PROVIDING INFORMATION ON BUSINESS OPPORTUNITIES; BUSINESS INTERMEDIARY AND ADVISORY SERVICES IN THE FIELD OF SELLING PRODUCTS AND RENDERING SERVICES; BUSINESS INVOICING SERVICES; BUSINESS MANAGEMENT AND CONSULTING SERVICES FOR THE HEALTH CARE INDUSTRY, NAMELY, CUSTOMER SERVICE, ACCOUNTING SERVICES, AND WEB-BASED ADVERTISING AND MARKETING SERVICES; BUSINESS MANAGEMENT CONSULTANCY AND ADVISORY SERVICES; BUSINESS MANAGEMENT CONSULTANCY SERVICES; BUSINESS MANAGEMENT CONSULTING AND ADVISORY SERVICES; BUSINESS MANAGEMENT INFORMATION ON A WIDE VARIETY OF TOPICS TO SERVICE PROVIDING PROFESSIONALS; BUSINESS MANAGEMENT SERVICES, NAMELY, ADMINISTRATION OF COMPETITIONS FOR INTERNET DOMAIN NAMES; BUSINESS MANAGEMENT SERVICES, NAMELY, AIRCRAFT MANAGEMENT FOR OTHERS; BUSINESS MANAGEMENT SERVICES, NAMELY, MANAGING LOGISTICS, REVERSE LOGISTICS, SUPPLY CHAIN SERVICES, SUPPLY CHAIN VISIBILITY AND SYNCHRONIZATION, SUPPLY AND DEMAND FORECASTING AND PRODUCT DISTRIBUTION PROCESSES FOR OTHERS; BUSINESS MANAGEMENT SERVICES, NAMELY, PURCHASING OF AND SELLING OF COMPANIES FOR OTHERS; BUSINESS MARKETING AND DIRECT MAIL CONSULTING SERVICES; BUSINESS MARKETING CONSULTING SERVICES; BUSINESS MARKETING CONSULTING SERVICES TO CHILDCARE ORGANIZATIONS; BUSINESS MARKETING SERVICES; BUSINESS MERCHANDISING DISPLAY SERVICES; BUSINESS MONITORING SERVICES, NAMELY, TRACKING WEB SITES OF OTHERS TO PROVIDE DETAILS ABOUT USER CLICK TRAFFIC OR VISITS TO THE WEB SITE; BUSINESS OPERATION, BUSINESS ADMINISTRATION AND OF-

CLASS 35—(Continued).

FICE FUNCTIONS; BUSINESS ORGANISATION AND MANAGEMENT CONSULTING SERVICES; BUSINESS PROCESS OUTSOURCING SERVICES IN THE FIELD OF INTERNET DOMAIN NAMES; BUSINESS PROCESS RE-ENGINEERING SERVICES; BUSINESS RESEARCH SERVICES, NAMELY, PROVIDING ANALYSIS OF RETAIL DATA ON SPECIFIC BUSINESS LOCATIONS; BUSINESS SERVICES FOR FUND RAISING PROGRAMS, NAMELY, DEVELOPING FUND RAISING PROGRAM CATALOGS, BROCHURES, PRICE SHEETS, ORDER FORMS, AND OTHER DOCUMENTS FOR NOT-FOR-PROFIT ORGANIZATIONS; BUSINESS SERVICES, NAMELY, ASSISTING OTHERS IN THE ESTABLISHMENT OF CHARITABLE ORGANIZATIONS; BUSINESS SERVICES, NAMELY, FACILITIES MANAGEMENT OF TECHNICAL OPERATIONS; BUSINESS SERVICES, NAMELY, INDEPENDENT MEDICAL MANAGEMENT SERVICES FOR SELF-FUNDED MAJOR MEDICAL HEALTH PLANS; BUSINESS SERVICES, NAMELY, MATCHING POTENTIAL PRIVATE INVESTORS WITH ENTREPRENEURS NEEDING FUNDING; BUSINESS SERVICES, NAMELY, PROCURING QUALIFIED AND CREDENTIALLED THIRD-PARTY EXPERTS, PROFESSIONALS AND OTHER QUALIFIED PERSONNEL, AND DOCUMENTATION AND INFORMATION ALL ON BEHALF OF OTHERS; BUSINESS SERVICES, NAMELY, PROVIDING COMPUTER DATABASES REGARDING THE PURCHASE AND SALE OF A WIDE VARIETY OF PRODUCTS AND SERVICES OF OTHERS; BUSINESS SERVICES, NAMELY, REGISTERING, SCREENING, CREDENTIALING, AND ORGANIZING THIRD-PARTY VENDORS, SUPPLIERS, AND CONTRACTORS, AND DOCUMENTATION AND INFORMATION ON BEHALF OF OTHERS; BUSINESS SERVICES, NAMELY, TRACKING, COMPARING AND MONITORING EMPLOYEE COST ITEMS FOR OTHERS; CATALOG ORDERING SERVICE FEATURING INTERNET DOMAIN NAMES; CHARITABLE SERVICES, NAMELY PROVIDING ADMINISTRATION AND MANAGEMENT OF CARE FACILITIES, HOUSING FACILITIES, AND NURSING HOME FACILITIES FOR OTHERS, NAMELY, THE ELDERLY, CHILDREN IN NEED, AND ADULTS WITH DISABILITIES; CHARITABLE SERVICES, NAMELY, COORDINATION OF THE PROCUREMENT AND DISTRIBUTION OF FOOD DONATIONS FROM MANUFACTURERS, WHOLESALERS, RETAILERS, AND GOVERNMENT AGENCIES TO ORGANIZATIONS PROVIDING FREE FOOD TO NEEDY PEOPLE; CHARITABLE SERVICES, NAMELY, ORGANIZING AND CONDUCTING VOLUNTEER PROGRAMS AND COMMUNITY SERVICE PROJECTS; CHARITABLE SERVICES, NAMELY, ORGANIZING AND CONDUCTING VOLUNTEER PROGRAMS AND COMMUNITY SERVICE PROJECTS AIMED AT INCREASING SUPPORT AND MORALE OF MEMBERS OF THE U.S. MILITARY; CHARITABLE SERVICES, NAMELY, ORGANIZING WOMEN'S GROUPS TO UNDERTAKE PROJECTS WHICH BENEFIT THE HOMELESS, ABUSED, AT RISK WOMEN AND WOMEN IN TRANSITION AND IN PAIN, WHILE ENCOURAGING EMPOWERMENT AMONG WOMEN OF ALL AGES AND ETHNICITIES; CHARITABLE SERVICES, NAMELY, ORGANIZING YOUTH GROUPS TO UNDERTAKE CHARITABLE PROJECTS IN THE FIELD OF DISASTER RESPONSE; CHARITABLE SERVICES, NAMELY, ORGANIZING YOUTH GROUPS TO UNDERTAKE PROJECTS TO BENEFIT THE NEEDY AND THE COMMUNITY TO ENCOURAGE LEADERSHIP, CHARACTER, COMPASSION, AND GOOD CITIZENSHIP; CHARITABLE SERVICES, NAMELY, PROMOTING PUBLIC AWARENESS ABOUT POVERTY IN THE UNITED STATES THROUGH A MEDIA FAST PROGRAM CONDUCTED BY YOUNG PEOPLE; CHARITABLE SERVICES, NAMELY, PROVIDING OFFICE EQUIPMENT TO THOSE IN NEED; CHARITABLE SERVICES, NAMELY, PROVIDING OFFICE FACILITIES TO THOSE IN NEED; CLERICAL SERVICES; COMMERCIAL ADMINISTRATION OF THE LICENSING OF THE GOODS AND SERVICES OF OTHERS; COMMERCIAL ADMINISTRATION OF THE LICENSING OF INTERNET DOMAIN NAMES OF OTHERS; COMMERCIAL MAIL RECEIVING AGENCY, NAMELY, PROVIDING SPECIALIZED MAIL MANAGEMENT SERVICES; COMMERCIAL REGISTERED AGENT SERVICES; COMPARISON SHOPPING SERVICES; COMPTROLLER SERVICES; COMPUTER SERVICES, NAMELY, ADDRESS CHANGE NOTIFICATION SERVICES IN THE NATURE OF POSTING NOTIFICATIONS OF CHANGES OF ADDRESSES

CLASS 35—(Continued).

FOR BUSINESSES VIA THE INTERNET; COMPUTER SERVICES, NAMELY, PROVIDING CONSUMER INFORMATION IN THE FIELD OF ANIMALS AND PETS RELATING TO PET PRODUCTS, PET TREATS AND PET TOYS; COMPUTERIZED ACCOUNTING SERVICES; COMPUTERIZED ON-LINE GIFT ORDERING SERVICE WHICH MATCHES THE GIFT GIVER'S REQUIREMENTS WITH THE GIFT RECIPIENT'S WANTS AND NEEDS; COMPUTERIZED ON-LINE ORDERING SERVICES IN THE FIELD OF INTERNET DOMAIN NAMES; COMPUTERIZED ON-LINE RETAIL STORE SERVICES IN THE FIELD OF INTERNET DOMAIN NAMES; CONDUCTING QUALITY ASSURANCE SURVEYS IN HOSPITALS TO DETERMINE SERVICE QUALITY; CONSULTANCY SERVICES REGARDING BUSINESS STRATEGIES; CONSULTATION SERVICES IN THE FIELD OF COMPANY, BUSINESS SECTOR AND INDUSTRY DATA AND RESEARCH; CONSULTING SERVICES IN BUSINESS ORGANIZATION AND MANAGEMENT; CONSULTING SERVICES IN THE AREA OF SUSTAINABLE BUSINESS SOLUTIONS; CONSULTING SERVICES IN THE COST AND PAYMENT MANAGEMENT OF HEALTH CARE; CONSULTING SERVICES IN THE FIELD OF DENTAL PRACTICE MANAGEMENT; CONSULTING SERVICES IN THE FIELD OF HIGHER EDUCATION ADMINISTRATION; CONSULTING SERVICES IN THE FIELD OF HUMAN RESOURCES DEVELOPMENT, NAMELY, FOR THE PROMOTION OF EMPLOYEE RETENTION, CAREER GROWTH, AND INCREASED PRODUCTIVITY FOR EMPLOYEES AND EMPLOYERS; CONSULTING SERVICES IN THE FIELD OF HUMAN RESOURCES DEVELOPMENT, NAMELY, UTILIZING TECHNOLOGY FOR THE PROMOTION OF EMPLOYEE RETENTION, CAREER GROWTH AND INCREASED PRODUCTIVITY FOR EMPLOYEES AND EMPLOYERS; CONSULTING SERVICES IN THE FIELD OF MANAGING INTELLECTUAL PROPERTIES; CONSULTING SERVICES RELATED TO THE ADMINISTRATIVE COORDINATION OF ORGANIZATIONS PROVIDING HUMANITARIAN ACTIVITIES; CONSULTING SERVICES RELATING TO PUBLICITY; CONSULTING SERVICES, NAMELY, PROVIDING EXPECTANT PARENTS WITH CONSUMER INFORMATION ON ALL TYPES OF BABY PRODUCTS AND SERVICES; CONSUMER LOYALTY SERVICES FOR COMMERCIAL, PROMOTIONAL, AND/OR ADVERTISING PURPOSES, NAMELY, ADMINISTRATION OF FREQUENT FLYER PROGRAM THAT ALLOWS MEMBERS TO REDEEM MILES FOR POINTS OR AWARDS OFFERED BY OTHER LOYALTY PROGRAMS; CONTESTS AND INCENTIVE AWARD PROGRAMS TO PROMOTE THE SALE OF PRODUCTS AND SERVICES OF OTHERS; COOPERATIVE ADVERTISING AND MARKETING SERVICES BY WAY OF SOLICITATION, CUSTOMER SERVICE AND PROVIDING MARKETING INFORMATION VIA WEB SITES ON A GLOBAL COMPUTER NETWORK; CORPORATE IMAGE CONSULTING SERVICES; COST ASSESSMENT SERVICES; CREATION OF MARKETING TOOLS DESIGNED TO INCREASE A CLIENT COMPANY'S KNOWLEDGE OF CUSTOMER NEEDS, AND ITS COMPETITORS' PRODUCTS AND SERVICES, PRICING, ADVERTISING STRATEGY AND SALES STRATEGY; CREATIVE MARKETING DESIGN SERVICES; CUSTOM WRITING SERVICES COMPRISING PUBLIC RELATIONS AND MARKETING MATERIALS FOR THE AUDIO, VIDEO AND TECHNOLOGY INDUSTRIES; CUSTOMER LOYALTY SERVICES AND CUSTOMER CLUB SERVICES, FOR COMMERCIAL, PROMOTIONAL AND/OR ADVERTISING PURPOSES; CUSTOMER SERVICE IN THE FIELD OF INTERNET DOMAIN NAMES; CUSTOMS CLEARANCE SERVICES; DATA MANAGEMENT SERVICE FOR USE IN REPORTING DEBT COLLECTION ACCOUNTS TO A COLLECTION AGENCY; DATA MANAGEMENT SERVICES FOR USE IN DEBT COLLECTION, NAMELY, ELECTRONIC DATA COLLECTION AND ONLINE CLAIMS MANAGEMENT; DATA PROCESSING SERVICES; DEMONSTRATION OF GOODS AND SERVICES BY ELECTRONIC MEANS, ALSO FOR THE BENEFIT OF THE SO-CALLED TELESHOPPING AND HOMESHOPPING SERVICES; DESIGN OF INTERNET ADVERTISING; DIRECT MARKETING CONSULTING SERVICES; DIRECT MARKETING SERVICES; DIRECT RESPONSE RETAIL SERVICES BY MEANS OF INFOMERCIALS IN THE FIELD OF INTERNET DOMAIN NAMES; DISASTER RECOVERY SERVICES, NAMELY, BUSINESS PLANNING AND

CLASS 35—(Continued).

BUSINESS CONTINUITY CONSULTING; DISSEMINATION OF ADVERTISING FOR OTHERS VIA AN ONLINE COMMUNICATIONS NETWORK ON THE INTERNET; DISSEMINATION OF ADVERTISING FOR OTHERS VIA THE INTERNET; DISTRIBUTORSHIP SERVICES IN THE FIELD OF ALUMINUM AND STAINLESS STEEL SHEETS AND COILS; DISTRIBUTORSHIP SERVICES IN THE FIELD OF AUTOMATED PARKING GARAGE SYSTEMS; DISTRIBUTORSHIP SERVICES IN THE FIELD OF INTERNET DOMAIN NAMES; DRIVE-THROUGH RETAIL STORE SERVICES FEATURING COFFEE AND RELATED GOODS; ELECTRONIC CATALOG SERVICES FEATURING INTERNET DOMAIN NAMES; ELECTRONIC COMMERCE SERVICES, NAMELY, PROVIDING INFORMATION ABOUT PRODUCTS VIA TELECOMMUNICATION NETWORKS FOR ADVERTISING AND SALES PURPOSES; ELECTRONIC SIGNATURE VERIFICATION SERVICES PROVIDED IN CONNECTION WITH BANKING AND FINANCIAL SERVICES; EMPLOYEE RELATIONS INFORMATION SERVICES; EMPLOYMENT HIRING, RECRUITING, PLACEMENT, STAFFING AND CAREER NETWORKING SERVICES; EMPLOYMENT OUTPLACEMENT SERVICES; ENERGY MANAGEMENT SERVICES, NAMELY, PROVIDING A SERVICE THAT ALLOWS CUSTOMERS TO PURCHASE ENERGY, NAMELY, ELECTRICITY, NATURAL GAS AND RENEWABLE ENERGY, AT A FIXED PRICE; ENERGY PRICE COMPARISON SERVICES; ENERGY USAGE MANAGEMENT INFORMATION SERVICES; ENTERTAINMENT ADMISSION VENUE CONTROL SERVICES, NAMELY, THE REMOTE VERIFICATION OF TICKET VALIDITY UPON PRESENTATION OF TICKETS AT AN ENTERTAINMENT VENUE; ENTERTAINMENT MARKETING SERVICES, NAMELY, MARKETING, PROMOTION AND ADVERTISING FOR INDEPENDENT RECORDING ARTISTS; EXCHANGE SERVICES, NAMELY, BARTERING OF GOODS FOR OTHERS; EXECUTIVE SEARCH AND PLACEMENT SERVICES; FACILITATING GROUP PURCHASE OF BANKING SERVICES; FACILITATING THE EXCHANGE OF NEEDED INFORMATION FOR FINANCIAL COMPENSATION VIA THE INTERNET; FOOD KIOSK SERVICES; FORESTRY MANAGEMENT SERVICES; FRANCHISE SERVICES, NAMELY, OFFERING BUSINESS MANAGEMENT ASSISTANCE IN THE ESTABLISHMENT AND OPERATION OF INTERNET DOMAIN NAMES; GENERAL BUSINESS MERCHANDISING SERVICES, NAMELY, MARKETING; GENERAL BUSINESS NETWORKING REFERRAL SERVICES, NAMELY, PROMOTING THE GOODS AND SERVICES OF OTHERS BY PASSING BUSINESS LEADS AND REFERRALS AMONG GROUP MEMBERS; GIFT REGISTRY SERVICES; GOODS OR SERVICES PRICE QUOTATIONS; HEALTH CARE UTILIZATION AND REVIEW SERVICES; HOSPITAL ADMINISTRATION SERVICES; HUMAN CAPITAL MANAGEMENT OUTSOURCING SERVICES; HUMAN RESOURCES SERVICES IN THE FIELD OF EDUCATION, NAMELY, OFFERING OF ASSESSMENTS AND SURVEYS IN THE FIELD OF EDUCATOR TRAINING AND PERFORMANCE FOR THE PURPOSE OF TEACHER PLACEMENT BASED ON SUCCESS IN AN ACADEMIC PROGRAM; HUMAN RESOURCES SERVICES, NAMELY, PERSONNEL SELECTION FOR OTHERS; IMPLEMENTATION AND FOLLOW-UP OF ADVICE IN THE FIELDS OF MARKETING; INDUSTRIAL ASSET MANAGEMENT SERVICES, NAMELY, AUCTIONING, LIQUIDATING AND REMARKETING INDUSTRIAL ASSETS OF OTHERS; INFOMEDIARY SERVICES, NAMELY, FACILITATING TRANSACTIONS BETWEEN BUYERS AND SELLERS THROUGH PROVIDING BUYERS WITH INFORMATION ABOUT SELLERS, GOODS, AND/OR SERVICES; INFORMATION MANAGEMENT SERVICES, NAMELY, SHIPMENT PROCESSING, PREPARING SHIPPING DOCUMENTS AND INVOICES, TRACKING DOCUMENTS, PACKAGES AND FREIGHT OVER COMPUTER NETWORKS, INTRANETS AND INTERNETS; INFORMATION SERVICES RELATING TO BUSINESS MATTERS; INFORMATION, ADVISORY AND CONSULTANCY SERVICES RELATING TO BUSINESS AND MANAGEMENT OR BUSINESS ADMINISTRATION, INCLUDING SUCH SERVICES PROVIDED ON LINE OR VIA THE INTERNET; INSTITUTIONAL RETAIL PHARMACY SERVICES; INSURANCE CLAIMS AUDITING SERVICES; INSURANCE LEAD COLLECTION AND MATCHING SERVICES, NAMELY, MATCHING CON-

CLASS 35—(Continued).

SUMER REQUESTS FOR INSURANCE POLICY QUOTES COLLECTED OVER THE INTERNET TO PRE-QUALIFIED INSURANCE BROKERS, AGENTS AND AGENCIES INTERESTED IN THOSE REQUESTS; INTERACTIVE RECORD-KEEPING SERVICES FOR USE IN RISK MANAGEMENT AND REGULATORY COMPLIANCE BY INSURERS AND PROFESSIONALS IN THE MEDICAL FIELD; INTERNET ADVERTISING SERVICES; INVOICING SERVICES; INVOICING SERVICES IN THE FIELD OF INTERNET DOMAIN NAMES; ISSUING GIFT CERTIFICATES WHICH MAY THEN BE REDEEMED FOR GOODS OR SERVICES; LAYOUT SERVICES FOR ADVERTISING PURPOSES; LOBBYING SERVICES, NAMELY, PROMOTING THE INTERESTS OF INTERNATIONAL, REAL ESTATE AND NONPROFIT COMPANIES IN THE FIELDS OF POLITICS, LEGISLATION, AND REGULATION; MAIL ORDER CATALOG SERVICES FEATURING INTERNET DOMAIN NAMES; MAIL ORDER SERVICES FEATURING INTERNET DOMAIN NAMES; MANAGED CARE SERVICES, NAMELY, ELECTRONIC PROCESSING OF HEALTH CARE INFORMATION; MANAGED CARE SERVICES, NAMELY, UTILIZATION REVIEW AND PRE-CERTIFICATION SERVICES; MANAGEMENT AND BUSINESS CONSULTING SERVICES IN THE FIELD OF TRAINING AND RECRUITMENT; MANAGEMENT AND BUSINESS CONSULTING SERVICES IN THE FIELD OF INTERNET DOMAIN NAMES; MANAGEMENT SERVICES PROVIDED TO PHARMACIES FOR CONTROLLING DRUG INVENTORIES; MANAGING TELECOMMUNICATIONS NETWORKS FOR OTHERS, NAMELY, MANAGING TELEPHONE SERVICE FOR OTHER CARRIERS; MARKET MANIPULATION, RESEARCH AND ANALYSIS, WHETHER OR NOT VIA THE INTERNET; MARKET RESEARCH SERVICES; MARKETING AND ADVERTISING SERVICES FOR AUTOMOBILE DEALERSHIPS; MARKETING SERVICES IN THE FIELD OF PLANNED-GIVING FOR NON-PROFIT AND CHARITABLE ORGANIZATIONS; MARKETING SERVICES, NAMELY, PROVIDING INFORMATIONAL WEB PAGES DESIGNED TO GENERATE SALES TRAFFIC VIA HYPERLINKS TO OTHER WEB SITES; MARKETING, PROMOTIONAL AND ADVERTISING SERVICES PROVIDED BY MOBILE TELEPHONE CONNECTIONS; MATCHING CONSUMERS WITH PROFESSIONALS IN THE FIELD OF RESIDENTIAL AND COMMERCIAL SERVICES VIA COMPUTER NETWORK; MATCHING CONSUMERS WITH REAL ESTATE PROFESSIONALS IN THE FIELD OF REAL ESTATE SERVICES VIA COMPUTER NETWORK; MEDIA PRODUCTION LOCATION SCOUTING SERVICES FOR ADVERTISING PURPOSES; MEDICAL BILLING SUPPORT SERVICES; MEDICAL CLAIMS MANAGEMENT SERVICES, NAMELY, ELECTRONIC RE-PRICING OF PHYSICIAN, HOSPITAL, AND ANCILLARY MEDICAL CARE PROVIDER TRANSACTIONS VIA THE GLOBAL INFORMATION NETWORK; MEDICAL CLAIMS MANAGEMENT SERVICES, NAMELY, RECEIVING, DATA ENTERING, AND RE-PRICING OF TRANSACTIONS THAT ARE ORIGINATED BY PHYSICIANS, HOSPITALS, AND ANCILLARY MEDICAL CARE PROVIDERS; MEDICAL TRANSCRIPTION SERVICES; MEMBERSHIP CLUB SERVICES PROVIDING DISCOUNTS AND PROCESSING REBATES FOR THE SERVICES OF OTHERS; MERCHANDISING SERVICES FOR INDUCING THE PURCHASING PUBLIC TO BUY THE GOODS OF OTHERS THROUGH A PROMOTIONAL GIFT REDEMPTION PROGRAM; MODELING SERVICES FOR ADVERTISING OR SALES PROMOTION; MONITORING SERVICES FOR BUSINESS PURPOSES TO ASCERTAIN THE GEOGRAPHIC LOCATIONS OF MOVABLE OBJECTS, NAMELY, MOTOR VEHICLES AND INDIVIDUALS; MOVING AND RELOCATION SERVICES, NAMELY PLANNING AND IMPLEMENTING MOVES OF HOMES FOR OTHERS; MOVING AND RELOCATION SERVICES, NAMELY PLANNING AND PROJECT OVERSIGHT OF HOME MOVING FOR OTHERS; MOVING AND RELOCATION SERVICES, NAMELY, PLANNING AND IMPLEMENTING MOVES OF HOMES AND OFFICES; MULTI-LEVEL MARKETING BUSINESS SERVICES; MUSIC SELECTION SERVICES FOR USE IN ADVERTISING; NEW BUSINESS VENTURE DEVELOPMENT AND FORMATION CONSULTING SERVICES; NEWS CLIPPING SERVICES; NEWS REPORTING SERVICES, NAMELY, PROVIDING REAL-TIME INFORMATION RELATED TO THE TRACKING OF SALES OF THOROUGHBRED HORSES; OFFICE ADMINISTRA-

CLASS 35—(Continued).

TION SERVICES; ON-LINE ADVERTISING AND MARKETING SERVICES; ON-LINE CONSIGNMENT SERVICES WHEREBY GOODS ARE RECEIVED ON CONSIGNMENT FOR AUCTION ON AN ONLINE AUCTION SITE; ON-LINE ORDERING SERVICES FEATURING INTERNET DOMAIN NAMES; ON-LINE ORDERING SERVICES IN THE FIELD OF RESTAURANT TAKE-OUT AND DELIVERY; ON-LINE RETAIL STORE SERVICES FEATURING DOWNLOADABLE PRE-RECORDED MUSIC AND VIDEO; ON-LINE RETAIL STORE SERVICES FEATURING DOWNLOADABLE RING TONES; ON-LINE RETAIL STORE SERVICES FEATURING INTERNET DOMAIN NAMES; ON-LINE SERVICES, NAMELY, ORDERING AND INVENTORY MONITORING FOR INTERNET DOMAIN NAMES; ON-LINE TRADING SERVICES IN WHICH SELLER POSTS PRODUCTS TO BE AUCTIONED AND BIDDING IS DONE VIA THE INTERNET; ONLINE AUCTION SERVICES; ONLINE BUSINESS NETWORKING SERVICES; ONLINE BUYERS GUIDE SERVICE PROVIDING INFORMATION IN THE FIELD OF INTERNET DOMAIN NAMES; ONLINE TRACKING FOR OTHERS OF SERVICE CONTRACTS FOR RESIDENTIAL APPLIANCES AND CONSUMER GOODS; OPERATING AN ONLINE SHOPPING SITE IN THE FIELD OF INTERNET DOMAIN NAMES; OPERATING ON-LINE MARKETPLACES FOR SELLERS OF GOODS AND/OR SERVICES; OPERATION AND ADMINISTRATION OF TELECOMMUNICATION SYSTEMS AND NETWORKS FOR OTHERS; ORDER FULFILLMENT SERVICES; ORGANISATION FOR A THIRD PARTY OF TELEPHONE WELCOMING SERVICES AND OF TELEPHONE RECEPTIONIST SERVICES; ORGANISATION OF INTERNET AUCTIONS; ORGANIZATIONAL SERVICES FOR BUSINESS PURPOSES; OUT-OF-HOME ADVERTISING SERVICES, NAMELY, RENTAL OF ADVERTISING SPACE, AND PREPARING AND PLACING ADVERTISEMENTS FOR OTHERS; OUTSOURCING SERVICES; PAYROLL PROCESSING SERVICES; PERSONAL MANAGEMENT SERVICES FOR ENTERTAINERS; PERSONAL MANAGEMENT SERVICES FOR MUSICAL PERFORMERS; PHARMACEUTICAL COST MANAGEMENT SERVICES AND DRUG UTILIZATION REVIEW SERVICES; POST-PRODUCTION EDITING SERVICES FOR VIDEO AND AUDIO COMMERCIALS; PRICE COMPARISON SERVICES; PROCESSING TELEPHONE INQUIRIES REGARDING ADVERTISED GOODS AND SERVICES; PROCUREMENT, NAMELY, PURCHASING INTERNET DOMAIN NAMES FOR OTHERS; PRODUCT DEMONSTRATION SERVICES IN SHOP WINDOWS BY LIVE MODELS; PRODUCTION OF TELEVISION COMMERCIALS AND PUBLIC SERVICE ANNOUNCEMENTS; PROJECT MANAGEMENT SERVICES FOR OTHERS IN THE FIELDS OF LANGUAGE TRANSLATION, CUSTOM WRITING, TEXT ADAPTATION, INTERPRETING AND PROOFREADING; PROMOTING PUBLIC INTEREST IN EDUCATION, RECOGNITION, CAREER ADVANCEMENT, AND LEADERSHIP FOR ELITE MANAGERS AND EXECUTIVES IN CORPORATIONS AND PROFESSIONAL SERVICE FIRMS; PROMOTING THE GOODS AND SERVICES OF OTHERS BY ARRANGING FOR SPONSORS TO AFFILIATE THEIR GOODS AND SERVICES WITH AN AWARDS PROGRAM, A SPORTS COMPETITION AND SPORTING ACTIVITIES; PROMOTING THE GOODS AND SERVICES OF OTHERS BY ARRANGING FOR SPONSORS TO AFFILIATE THEIR GOODS AND SERVICES WITH INTERNET DOMAIN NAMES; PROMOTING THE GOODS AND SERVICES OF OTHERS BY DISTRIBUTING ADVERTISING MATERIALS THROUGH A VARIETY OF METHODS; PROMOTING THE GOODS AND SERVICES OF OTHERS BY LICENSING A TOLL-FREE TELEPHONE NUMBER; PROMOTING THE GOODS AND SERVICES OF OTHERS BY MEANS OF A PREFERRED CUSTOMER PROGRAM FEATURING INTERNET DOMAIN NAMES; PROMOTING THE GOODS AND SERVICES OF OTHERS BY MEANS OF OPERATING AN ON-LINE SHOPPING MALL WITH LINKS TO THE RETAIL WEB SITES OF OTHERS; PROMOTING THE GOODS AND SERVICES OF OTHERS BY PREPARING AND PLACING ADVERTISEMENTS IN AN ELECTRONIC MAGAZINE ACCESSED THROUGH A GLOBAL COMPUTER NETWORK; PROMOTING THE GOODS AND SERVICES OF OTHERS BY PROVIDING A COMMUNITY-DRIVEN WEB SITE FEATURING USER-SUBMITTED CONTENT IN THE NATURE OF COUPONS, REBATES, PRICE-COMPARISON INFORMATION, PRODUCT REVIEWS,

CLASS 35—(Continued).

LINKS TO THE RETAIL WEB SITES OF OTHERS, AND DISCOUNT INFORMATION; PROVIDING CONSULTING SERVICES IN THE FIELD OF FACILITATING THE PLANNING, BUYING, AND SELLING OF MEDIA; PROVIDING CONSUMER INFORMATION IN THE FIELD OF INTERNET DOMAIN NAMES; PROVIDING CONSUMER INFORMATION SERVICES AND MAKING REFERRALS IN THE FIELD OF ENTERTAINMENT SERVICES FOR PRODUCTS, SERVICES, EVENTS, ACTIVITIES, FACILITIES AND LOCATIONS; PROVIDING CONSUMER PRODUCT INFORMATION VIA THE INTERNET; PROVIDING DOOR-TO-DOOR SHOPPING SERVICES IN THE FIELD OF INTERNET SERVICES; PROVIDING HOME SHOPPING SERVICES IN THE FIELD OF INTERNET SERVICES BY MEANS OF TELEVISION; PROVIDING INFORMATION ABOUT AND MAKING REFERRALS IN THE FIELD OF CONSUMER PRODUCTS AND SERVICES FOR RETAIL SERVICES CONCERNING PRODUCTS, SERVICES, EVENTS, ACTIVITIES, ATTRACTIONS AND FACILITIES IN PARTICULAR GEOGRAPHIC LOCATIONS; PROVIDING INFORMATION ABOUT AUTOMOBILES FOR SALE BY MEANS OF THE INTERNET; PROVIDING INFORMATION ABOUT THE GOODS AND SERVICES OF OTHERS VIA THE GLOBAL COMPUTER NETWORK; PROVIDING INFORMATION IN THE FIELD OF AVIATION FUEL MANAGEMENT VIA THE INTERNET, NAMELY, THE AMOUNT OF FUEL LOADED ONTO AIRCRAFT AND MAINTAINING OPERATIONAL CONTROL OF FUEL AVAILABLE AND DELIVERED TO AIRCRAFT; PROVIDING INFORMATION IN THE FIELD OF MARKETING AND ON-LINE MARKETING MEDIA VIA THE INTERNET; PROVIDING INTERACTIVE SALES ASSESSMENT SERVICES VIA THE TELEPHONE FOR MEASURING THE SKILLS AND KNOWLEDGE OF FIELD SALES FORCES IN REAL WORLD SELLING SITUATIONS; PROVIDING LABOR RELATIONS SERVICES, NAMELY, ESTABLISHING COMMITTEES WITH UNIONS TO PROMOTE IMPROVED RELATIONS BETWEEN EMPLOYERS AND UNIONS; PROVIDING LEGAL DOCKET MANAGEMENT SERVICES FOR OTHERS; PROVIDING OFFICE SUPPORT STAFF SERVICES; PROVIDING ONLINE DIRECTORY INFORMATION SERVICES ALSO FEATURING HYPERLINKS TO OTHER WEB SITES; PROVIDING ON-LINE FACILITIES FEATURING TRANSACTION ORDER ENTRY, ORDER DIRECTING AND ORDER CONFIRMATION SERVICES TO CUSTOMERS IN THE FIELD OF INVESTING; PROVIDING ORGANIZATIONAL DEVELOPMENT CONSULTING SERVICES; PROVIDING ORGANIZING SERVICES FOR BELONGINGS AND SPACES IN A RESIDENCE OR OFFICE SUCH AS PAPERS AND TIME; PROVIDING A WEB SITE FEATURING ONLINE REGISTRATION SERVICES FOR CAR CLUB MEMBERSHIP; PROVIDING A WEB SITE WHERE USERS CAN POST RATINGS, REVIEWS AND RECOMMENDATIONS ON PRODUCTS AND SERVICES; PROVIDING A WEB SITE WHEREBY BUYERS OF GOODS OR SERVICES LOCATE AND RECEIVE QUOTATIONS FROM MULTIPLE COMPETITIVE SOURCES AND SELLERS OF GOODS OR SERVICES IDENTIFY AND BID ON MULTIPLE NEW SALES OPPORTUNITIES; PROVIDING A WEB SITE WHICH FEATURES ADVERTISEMENTS FOR THE GOODS AND SERVICES OF OTHERS ON A GLOBAL COMPUTER NETWORK; PROVIDING A WEB-BASED SERVICE THAT ENABLES INDIVIDUALS TO MANAGE THE PRODUCTION AND PUBLICATION OF ELECTRONIC BOOKS (E-BOOKS) AND RELATED DIGITAL CONTENT AND OFFER THEM FOR SALE TO THE GENERAL PUBLIC; PROVIDING ACADEMIC COURSE ADMINISTRATION SERVICES FOR OTHER ACADEMIC INSTITUTIONS, NAMELY, ON-LINE COURSE REGISTRATION; PROVIDING ADVERTISING SERVICES USING 3D AND ANIMATION DESIGNS; PROVIDING ADVERTISING, MARKETING AND PROMOTIONAL SERVICES FOR THE PHARMACEUTICAL AND MEDICAL INDUSTRY; PROVIDING ADVERTISING, MARKETING AND PROMOTIONAL SERVICES FOR THE PHARMACEUTICAL AND MEDICAL PRODUCTS OF OTHERS; PROVIDING ADVERTISING, MARKETING AND PROMOTIONAL SERVICES, NAMELY, DEVELOPMENT OF ADVERTISING CAMPAIGNS FOR INTERNET DOMAIN NAMES; PROVIDING AN INTERACTIVE WEB SITE FOR PERSONS TO REGISTER COMPLAINTS AGAINST COMPANIES AND/OR SERVICES OF ALL TYPES; PROVIDING AN INTERNET-BASED DATABASE OF PATIENT MEDICAL IN-

CLASS 35—(Continued).

FORMATION DESIGNED TO FACILITATE PATIENT-AUTHORIZED, HIPAA-COMPLIANT SHARING AND MAINTENANCE OF PATIENT MEDICAL INFORMATION AMONGST A PATIENT'S DOCTORS SUCH THAT THIS INFORMATION CAN BE DIRECTLY INSERTED INTO THE DOCTOR'S MEDICAL REPORTS AS A MEANS OF INCREASING MEDICAL RECORD GENERATION EFFICIENCY AND ACCURACY; PROVIDING AN ON-LINE COMMERCIAL INFORMATION DIRECTORY ON THE INTERNET; PROVIDING AN ONLINE DIRECTORY INFORMATION SERVICE FEATURING INFORMATION REGARDING INTERNET DOMAIN NAMES; PROVIDING AND RENTAL OF ADVERTISING SPACE ON THE INTERNET; PROVIDING BUSINESS INFORMATION, ALSO VIA INTERNET, THE CABLE NETWORK OR OTHER FORMS OF DATA TRANSFER; PROVIDING BUSINESS MANAGEMENT INFORMATION IN CONNECTION WITH CONSULTING AND ADVISORY SERVICES IN THE FIELD OF STRATEGIC PLANNING; PROVIDING BUSINESS RESEARCH SERVICES, NAMELY, RESEARCHING DENTAL PATIENT INSURANCE INFORMATION FOR DENTAL OFFICES; PROMOTING THE GOODS AND SERVICES OF OTHERS BY PROVIDING A WEB SITE AT WHICH USERS CAN LINK TO INTERNET DOMAIN NAMES; PROMOTING THE GOODS AND SERVICES OF OTHERS BY PROVIDING A WEB SITE FEATURING COUPONS, REBATES, PRICE-COMPARISON INFORMATION, PRODUCT REVIEWS, LINKS TO THE RETAIL WEB SITES OF OTHERS, AND DISCOUNT INFORMATION; PROMOTING THE GOODS AND SERVICES OF OTHERS BY PROVIDING HYPERTEXT LINKS TO THE WEB SITES OF OTHERS; PROMOTING THE GOODS AND SERVICES OF OTHERS THROUGH INFOMERCIALS PLAYED ON CUSTOMER POINT OF PURCHASE TELEVISION MONITORS IN RETAIL STORES; PROMOTING THE GOODS AND SERVICES OF OTHERS THROUGH ON-LINE ORDERING AND CATALOGING OF THOSE GOODS AND SERVICES; PROMOTING THE GOODS AND SERVICES OF OTHERS THROUGH SEARCH ENGINE REFERRAL TRAFFIC ANALYSIS AND REPORTING; PROMOTING THE GOODS AND SERVICES OF OTHERS THROUGH THE DISTRIBUTION OF DISCOUNT CARDS; PROMOTING THE GOODS AND SERVICES OF OTHERS VIA A GLOBAL COMPUTER NETWORK; PROMOTING THE INTERESTS OF WOUNDED UNITED STATES SERVICE PERSONS IN MILITARY HOSPITALS WORLDWIDE BY SOLICITING VOLUNTEERS TO CORRESPOND WITH AND SEND BACKPACKS WITH AMENITIES TO SAID SERVICE-PERSONS; PROMOTING THE SALE OF CREDIT CARD ACCOUNTS THROUGH THE ADMINISTRATION OF INCENTIVE AWARD PROGRAMS; PROMOTING THE SALE OF GOODS AND SERVICES OF OTHERS BY AWARDED PURCHASE POINTS FOR CREDIT CARD USE; PROMOTING THE SALE OF GOODS AND SERVICES OF OTHERS THROUGH THE DISTRIBUTION OF PRINTED MATERIAL AND PROMOTIONAL CONTESTS; PROMOTION AND MARKETING SERVICES AND RELATED CONSULTING; PROMOTION OF FINANCIAL AND INSURANCE SERVICES, ON BEHALF OF THIRD PARTIES; PROMOTIONAL SERVICES, NAMELY, PROMOTING THE CHARITIES OF OTHERS; PROVIDING A GUARANTEED PRICING PROGRAM SERVICE IN THE FIELD OF INTERNET REGISTRARS; PROVIDING A LIVE FORUM FOR COMPANIES TO SHOWCASE, DISPLAY, DEMONSTRATE AND PROMOTE NEW AND INNOVATIVE IDEAS, PRODUCTS AND SERVICES IN THE CONVENTION/MEETING MANAGEMENT ARENA; PROVIDING A SEARCHABLE ONLINE ADVERTISING GUIDE FEATURING THE GOODS AND SERVICES OF OTHER ON-LINE VENDORS ON THE INTERNET; PROVIDING A SECURED ACCESS DATABASE VIA THE INTERNET THROUGH WHICH DOCUMENTS AND IMAGES CAN BE VIEWED, COPIED, AND PRINTED FOR PURPOSES OF CONDUCTING CORPORATE TRANSACTIONS; PROVIDING A WEB SITE AT WHICH FITNESS PROFESSIONALS AND FACILITIES CAN POST PROMOTIONAL PROFILES AND RESPOND TO ADVERTISEMENTS FOR THEIR SERVICES; XEROGRAPHY SERVICES; TELEPHONE ANSWERING SERVICE; TELEPHONE DIRECTORY ASSISTANCE SERVICES; TELEPHONE OPERATOR SERVICES; TELEPHONE ORDER-TAKING SERVICES FOR OTHERS; TRACKING, LOCATING AND MONITORING OF VEHICLES, MARITIME VESSELS AND AIRCRAFT SERVICES FOR COMMERCIAL PUR-

CLASS 35—(Continued).

POSES; TRANSPORTATION LOGISTICS SERVICES, NAMELY, ARRANGING THE TRANSPORTATION OF GOODS FOR OTHERS; TRANSPORTATION LOGISTICS SERVICES, NAMELY, PLANNING AND SCHEDULING SHIPMENTS FOR USERS OF TRANSPORTATION SERVICES; TRANSPORTATION MANAGEMENT SERVICES, NAMELY, PLANNING AND COORDINATING TRANSPORTATION OF PEOPLE FOR OTHERS; TURNKEY RETAIL START-UP SERVICES, NAMELY, COORDINATION AND ASSUMPTION OF RESPONSIBILITY FOR ALL ASPECTS OF THE STORE-OPENING PROCESS OF OTHERS; UTILITY BILL MANAGEMENT SERVICES, NAMELY, TRACKING, REPORTING, ANALYZING AND DELIVERING ENERGY INFORMATION IN THE FORM OF UTILITY BILLS AND UTILITY METER DATA RATE SCHEDULES; VALUE-ADDED RESELLER SERVICES, NAMELY, DISTRIBUTORSHIP SERVICES FEATURING COMPUTER SOFTWARE; VENDING MACHINE SERVICES; VESSEL HUSBANDING, NAMELY, THE COORDINATION OF AND ARRANGING FOR VESSEL-RELATED SERVICES ON BEHALF OF SEAFARING CLIENTS WHILE IN PORT; VIDEO PRODUCTION SERVICES IN THE FIELD OF EMPLOYMENT RECRUITING; VOTING SERVICES, NAMELY, SERVICES ALLOWING USERS TO CAST VOTES IN CONTESTS USING TELEPHONES; WHOLESALE ORDERING SERVICES IN THE FIELD OF INTERNET REGISTRARS; WINDOW DISPLAY ARRANGEMENT SERVICES; WINDOW DRESSING AND DISPLAY ARRANGEMENT SERVICES; WORD PROCESSING AND TYPING SERVICES; WORD PROCESSING SERVICES; SERVICES RELATING TO THE ANALYSIS, EVALUATION, CREATION AND BRAND ESTABLISHMENT OF TRADEMARKS, TRADE NAMES AND DOMAIN NAMES; SERVICES RENDERED BY A FRANCHISOR, NAMELY, ASSISTANCE IN THE RUNNING OR MANAGEMENT OF INDUSTRIAL OR COMMERCIAL ENTERPRISES; SERVICES TO DETERMINE THE AUDIENCE AFFECTED BY ADVERTISEMENTS; SERVICES WITH REGARD TO PRODUCT PRESENTATION TO THE PUBLIC; SHARE REGISTRATION SERVICES, NAMELY, REGISTERING THE OWNERSHIP OF STOCKS AND BONDS; SHAREHOLDER RECORD KEEPING SERVICES; SHOP WINDOW DISPLAY ARRANGEMENT SERVICES; SHOPPING BY RESEARCHERS WHO POSE AS CUSTOMERS TO EVALUATE THE QUALITY OF SERVICE DELIVERED; SHORTHAND SECRETARIAL SERVICES; SHORTHAND SERVICES; SPORTS RECRUITING SERVICES FOR HIGH SCHOOL ATHLETES; STREET VENDOR SERVICES FEATURING INTERNET INFORMATION SERVICES; SUBSCRIPTION TO A TELEMATICS, TELEPHONE OR COMPUTER SERVICE; SUPPLY CHAIN MANAGEMENT SERVICES; TAKE-OUT BAKERY SERVICES; TAX ADVISORY SERVICES; TAX AND TAXATION PLANNING, ADVICE, INFORMATION AND CONSULTANCY SERVICES; TAX DECLARATION PROCEDURE SERVICES; TAX FILING SERVICES; TAX LIEN MANAGEMENT SERVICES; RETAIL DRUG STORE SERVICES; RETAIL GASOLINE SUPPLY SERVICES; RETAIL PHARMACY SERVICES; RETAIL SHOP WINDOW DISPLAY ARRANGEMENT SERVICES; RETAIL STORE SERVICES FEATURING A WIDE VARIETY OF CONSUMER GOODS OF OTHERS; RETAIL STORE SERVICES FEATURING CONVENIENCE STORE ITEMS AND GASOLINE; RETAIL STORE SERVICES FEATURING TELECOMMUNICATIONS SERVICE PLANS AND TELECOMMUNICATIONS SERVICE ACTIVATION; RETAIL STORE SERVICES FEATURING TELECOMMUNICATIONS, ELECTRIC AND UTILITY SERVICES OF OTHERS; RETAIL STORE SERVICES FEATURING INTERNET DOMAIN NAMES; RETAIL STORE SERVICES IN THE FIELD OF INTERNET SERVICES FEATURING A BONUS INCENTIVE PROGRAM FOR CUSTOMERS; RETAIL STORE SERVICES IN THE FIELD OF DOMAIN NAMES THAT CAN BE PURCHASED UNDER A RENT-TO-OWN CONTRACT; SALES PROMOTION FOR OTHERS PROVIDED THROUGH THE DISTRIBUTION AND THE ADMINISTRATION OF PRIVILEGED USER CARDS; SALES PROMOTION SERVICES; SECRETARIAL AND CLERICAL SERVICES; SERVICES COMPRISING THE RECORDING, TRANSCRIPTION, COMPOSITION, COMPILATION AND SYSTEMATIZATION OF WRITTEN COMMUNICATIONS AND RECORDINGS, AS WELL AS THE COMPILATION OF MATHEMATICAL OR STATISTICAL DATA; SERVICES CONSISTING OF THE REGISTRATION, COLLECTION, TRANSCRIPTION, COMPILATION AND

CLASS 35—(Continued).

SYSTEMIZATION OF WRITTEN COMMUNICATIONS AND DATA; SERVICES FOR PROVISION OF FOREIGN TRADE INFORMATION; PROVIDING ORGANIZING SERVICES FOR INDIVIDUALS AT HOME, IN HOME OFFICES AND IN BUSINESS OFFICES, THAT PROVIDES HELP WITH TIME AND PAPER MANAGEMENT; PROVIDING PROMOTIONAL MARKETING SERVICES TO BUSINESSES IN THE BROADBAND AND MEDIA INDUSTRIES; PROVIDING SPACE AT A WEB SITE FOR THE ADVERTISEMENT OF THE GOODS AND SERVICES OF OTHERS; PROVIDING TRACKING SERVICES AND INFORMATION CONCERNING TRACKING OF ASSETS IN TRANSIT, NAMELY, VEHICLES, TRAILERS, DRIVERS, CARGO AND DELIVERY CONTAINERS; PROVIDING VIRTUAL ONLINE OFFICE SUPPORT STAFF SERVICES FOR BUSINESSES; PUBLIC POLICY RESEARCH SERVICES; PUBLICITY AND SALES PROMOTION RELATING TO GOODS AND SERVICES, OFFERED AND ORDERED BY TELECOMMUNICATION OR THE ELECTRONIC WAY; PUBLICITY AND SALES PROMOTION SERVICES; PURCHASING AND PROCUREMENT SERVICES, NAMELY, PROCURING OF CONTRACTS FOR OTHERS FOR THE PURCHASE OF GOODS AND LABOR CONTRACTING SERVICES; REAL ESTATE ADVERTISING SERVICES; REAL ESTATE MARKETING SERVICES, NAMELY, ON-LINE SERVICES FEATURING TOURS OF RESIDENTIAL AND COMMERCIAL REAL ESTATE; REAL ESTATE MARKETING SERVICES, NAMELY, ONLINE SERVICES FEATURING THE PROMOTION OF RESIDENTIAL NEW CONSTRUCTION, WHICH ALSO CONTAINS BACK OFFICE SOLUTIONS FOR BUILDERS; RECORDS MANAGEMENT SERVICES, NAMELY, DOCUMENT INDEXING FOR OTHERS; RECRUITMENT ADVERTISEMENT SERVICES, NAMELY, POSTING OF CLINICAL TRIAL NOTICES FOR THE PURPOSE OF RECRUITING PATIENTS FOR PARTICIPATION IN CLINICAL TRIALS FOR THE TESTING OF DRUGS; RESELLER SERVICES, NAMELY, DISTRIBUTORSHIP SERVICES IN THE FIELD OF SATELLITE TELEVISION ENTERTAINMENT PRODUCTS AND SERVICES; RETAIL BOOK STORE SERVICES; RETAIL DELICATESSEN SERVICES; RETAIL DEPARTMENT STORE SERVICES (U.S. CLS. 100, 101 AND 102).

DAVID MILLER, EXAMINING ATTORNEY

CLASS 35—(Continued).

SN 77-388,175. XZIEX, INC, LAKE SHORE, MN. FILED 2-4-2008.

XZIEX

THE MARK CONSISTS OF STANDARD CHARACTERS WITHOUT CLAIM TO ANY PARTICULAR FONT, STYLE, SIZE, OR COLOR.

THE WORDING "XZIEX" HAS NO MEANING IN A FOREIGN LANGUAGE.

FOR MULTI-LEVEL MARKETING BUSINESS SERVICES, IN THE FIELDS OF GENERAL HOUSEHOLD MERCHANDISE, HEALTH, BEAUTY AND NUTRITIONAL CARE, DOMESTIC AND COMMERCIAL WATER AND AIR TREATMENT DEVICES, HOME FURNISHINGS, HOME APPLIANCES; MAIL ORDER RETAIL SERVICES, CATALOG RETAIL SERVICES, AND E-COMMERCE RETAIL SERVICES, ALL IN THE FIELD OF GENERAL MERCHANDISE, NAMELY, DIETARY AND/OR FOOD SUPPLEMENTS, COSMETICS AND TOILETRIES, CLOTHING, JEWELRY, ATMOSPHERIC WATER GENERATORS, DOMESTIC AND COMMERCIAL WATER TREATMENT SYSTEMS, DOMESTIC AND COMMERCIAL AIR TREATMENT SYSTEMS, HOME FURNISHINGS, HOME APPLIANCES; ONLINE ORDERING SERVICE VIA COMPUTER NETWORKS AND GLOBAL COMMUNICATION NETWORKS IN THE FIELDS OF GENERAL MERCHANDISE, NAMELY, DIETARY AND/OR FOOD SUPPLEMENTS, COSMETICS AND TOILETRIES, CLOTHING, JEWELRY, DOMESTIC WATER TREATMENT SYSTEMS, DOMESTIC AIR TREATMENT SYSTEMS, BOOKS, CLOTHING, GROCERIES AND FOOD, ELECTRONICS, SPORTS AND OUTDOOR EQUIPMENT, HOME FURNISHINGS, HOME APPLIANCES, MAGAZINES, WATCHES, GENERAL HOUSEHOLD MERCHANDISE, HEALTH, BEAUTY AND NUTRITIONAL CARE ITEMS; ASSISTING OTHERS IN PLACING AND RUNNING ADVERTISEMENTS ON COMPUTER NETWORKS AND GLOBAL COMMUNICATION NETWORKS; AND BUSINESS INFORMATION SERVICES IN THE NATURE OF PROVIDING INFORMATION ON SMALL BUSINESSES AND SMALL BUSINESS OPPORTUNITIES VIA ONLINE ELECTRONIC COMPUTER NETWORKS (U.S. CLS. 100, 101 AND 102).

JAMES STEIN, EXAMINING ATTORNEY

SN 77-392,341. USI TECHNOLOGIES, INC., DBA UPSSELLIT.COM, CAMARILLO, CA. FILED 2-8-2008.

SAVE A SALE

THE MARK CONSISTS OF STANDARD CHARACTERS WITHOUT CLAIM TO ANY PARTICULAR FONT, STYLE, SIZE, OR COLOR.

FOR ONLINE SALES PROMOTION AND MARKETING SERVICES, NAMELY, PROMOTING THE SALE OF GOODS AND SERVICES OF OTHERS TO CUSTOMERS THROUGH INTERACTIVE ONLINE CHAT AND/OR INSTANT MESSAGING (U.S. CLS. 100, 101 AND 102).

FIRST USE 5-15-2006; IN COMMERCE 5-15-2006.
DORITT L. CARROLL, EXAMINING ATTORNEY

CLASS 35—(Continued).

SN 77-394,700. ADVANTAGE OFFICE SUITES, LLC, PHOENIX, AZ. FILED 2-12-2008.



NO CLAIM IS MADE TO THE EXCLUSIVE RIGHT TO USE "OFFICE SUITES", APART FROM THE MARK AS SHOWN.

THE MARK CONSISTS OF THE WORDS "ADVANTAGE OFFICE SUITES", WITH THE SECOND "A" IN "ADVANTAGE" BEING STYLIZED, AND A CONTEMPORARY DESIGN DEPICTING TWO BUILDINGS.

FOR PROVIDING OFFICE BUSINESS ADMINISTRATION, BUSINESS OPERATION, AND OFFICE FUNCTIONS; PROVIDING MANAGEMENT ON BEHALF OF BUSINESSES IN TERMS OF SUPPLYING THEM WITH OFFICE REQUISITES; PROVIDING OFFICE SUPPORT STAFF SERVICES; PROVIDING PERSONNEL MANAGEMENT FEATURING SHARING OF PERSONNEL; PROVIDING CLERICAL OFFICE SERVICES; PROVIDING VIRTUAL OFFICE SERVICES, NAMELY, COMPUTERIZED OFFICE BUSINESS ADMINISTRATION, BUSINESS OPERATION, OFFICE FUNCTIONS, AND BUSINESS MANAGEMENT (U.S. CLS. 100, 101 AND 102).

FIRST USE 10-24-2006; IN COMMERCE 10-24-2006.
HOWARD B. LEVINE, EXAMINING ATTORNEY

CLASS 35—(Continued).

SN 77-395,947. CROCODILES NOT WATERLILIES ENTERTAINMENT, LLC, SAN FRANCISCO, CA. FILED 2-13-2008.

CROCKIDS

THE MARK CONSISTS OF STANDARD CHARACTERS WITHOUT CLAIM TO ANY PARTICULAR FONT, STYLE, SIZE, OR COLOR.

FOR RETAIL STORE SERVICES FEATURING MERCHANDISE, NAMELY, GENERAL CONSUMER MERCHANDISE RELATED TO ANIMATED MOTION PICTURES (U.S. CLS. 100, 101 AND 102).

SONYA STEPHENS, EXAMINING ATTORNEY

SN 77-395,919. CROCODILES NOT WATERLILIES ENTERTAINMENT, LLC, SAN FRANCISCO, CA. FILED 2-13-2008.

CROCKIDS

THE MARK CONSISTS OF STANDARD CHARACTERS WITHOUT CLAIM TO ANY PARTICULAR FONT, STYLE, SIZE, OR COLOR.

FOR ONLINE RETAIL STORE SERVICES FEATURING MERCHANDISE, NAMELY, GENERAL CONSUMER MERCHANDISE RELATED TO ANIMATED MOTION PICTURES (U.S. CLS. 100, 101 AND 102).

SONYA STEPHENS, EXAMINING ATTORNEY



NO CLAIM IS MADE TO THE EXCLUSIVE RIGHT TO USE "CLUB", APART FROM THE MARK AS SHOWN.

FOR ADMINISTRATION OF A DISCOUNT PROGRAM TO CUSTOMERS OF APPLICANT'S CATALOG SERVICES FOR ENABLING PARTICIPANTS TO OBTAIN DISCOUNTS ON GOODS AND SERVICES THROUGH USE OF A DISCOUNT MEMBERSHIP CARD (U.S. CLS. 100, 101 AND 102).

MONIQUE MILLER, EXAMINING ATTORNEY

CLASS 35—(Continued).

SN 77-396,244. WEINBLATT, LEE S., TEANECK, NJ. FILED 2-13-2008.

ADGIFTZ

THE MARK CONSISTS OF STANDARD CHARACTERS WITHOUT CLAIM TO ANY PARTICULAR FONT, STYLE, SIZE, OR COLOR.

FOR PROVIDING AUDIENCE RATING DETERMINATION FOR RADIO AND TELEVISION BROADCASTS AND SERVICES TO DETERMINE THE AUDIENCE AFFECTED BY ADVERTISEMENTS, NAMELY, PROVIDING ADVERTISERS WITH AUDIENCE INFORMATION REGARDING DESIGNATED PROGRAMS AND/OR COMMERCIALS BROADCAST ON TELEVISION AND/OR RADIO TO WHICH VIEWERS AND LISTENERS ARE ATTRACTED, BY OFFERING REWARDS, COUPONS, PRICE DISCOUNTS AND CONTEST ENTRIES IN ORDER TO MEASURE THE DESIRABILITY OF DIFFERENT DISCOUNT OFFERS (U.S. CLS. 100, 101 AND 102).

FIRST USE 9-1-2007; IN COMMERCE 9-1-2007.
CHARISMA HAMPTON, EXAMINING ATTORNEY

SN 77-399,318. TONAL POEM'S MULTIMEDIA INCORPORATED, DBA MARKET READER PRO, GERMANSVILLE, PA. FILED 2-18-2008.

PRIVATE RESPONSE

THE MARK CONSISTS OF STANDARD CHARACTERS WITHOUT CLAIM TO ANY PARTICULAR FONT, STYLE, SIZE, OR COLOR.

FOR MARKETING CONSULTING; MARKET RESEARCH SERVICES, NAMELY, CONSUMER MARKETING RESEARCH (U.S. CLS. 100, 101 AND 102).

PATRICIA EVANKO, EXAMINING ATTORNEY

SN 77-399,936. EDCARE MANAGEMENT, INC., FORT LAUDERDALE, FL. FILED 2-19-2008.

EDCARE

THE MARK CONSISTS OF STANDARD CHARACTERS WITHOUT CLAIM TO ANY PARTICULAR FONT, STYLE, SIZE, OR COLOR.

FOR EMPLOYMENT STAFFING FOR MEDICAL OFFICES; MEDICAL OFFICE MANAGEMENT SERVICES, NAMELY, MANAGEMENT OF MEDICAL OFFICE BUSINESS AFFAIRS, EMPLOYEE ATTENDANCE, DUTY ASSIGNMENTS, PAYROLL, JOB COSTING, OFFICE ADMINISTRATION, PATIENT SCHEDULING, AND BILLINGS (U.S. CLS. 100, 101 AND 102).

FIRST USE 2-0-2002; IN COMMERCE 2-0-2002.
ARETHA SOMERVILLE, EXAMINING ATTORNEY

CLASS 35—(Continued).

SN 77-399,938. EDCARE MANAGEMENT, INC., FORT LAUDERDALE, FL. FILED 2-19-2008.



FOR EMPLOYMENT STAFFING FOR MEDICAL OFFICES; MEDICAL OFFICE MANAGEMENT SERVICES, NAMELY, MANAGEMENT OF MEDICAL OFFICE BUSINESS AFFAIRS, EMPLOYEE ATTENDANCE, DUTY ASSIGNMENTS, PAYROLL, JOB COSTING, OFFICE ADMINISTRATION, PATIENT SCHEDULING, AND BILLINGS (U.S. CLS. 100, 101 AND 102).

FIRST USE 2-0-2002; IN COMMERCE 2-0-2002.
ARETHA SOMERVILLE, EXAMINING ATTORNEY

SN 77-400,088. ALPHAM&A, NEW ULM, TX. FILED 2-19-2008.

AlphaM&A

THE MARK CONSISTS OF STANDARD CHARACTERS WITHOUT CLAIM TO ANY PARTICULAR FONT, STYLE, SIZE, OR COLOR.

FOR MANAGEMENT AND BUSINESS CONSULTING SERVICES IN THE FIELD OF MERGERS AND ACQUISITIONS (U.S. CLS. 100, 101 AND 102).

FIRST USE 6-30-2006; IN COMMERCE 6-30-2006.
ROBERT C. CLARK JR., EXAMINING ATTORNEY

CLASS 35—(Continued).

SN 77-400,421. YOUNG MENS CHRISTIAN ASSOCIATION OF GREATER LOUISVILLE, THE, DBA THE YMCA OF GREATER LOUISVILLE, LOUISVILLE, KY. FILED 2-19-2008.



THE MARK CONSISTS OF A SINGLE LINE DIAMOND SHAPED BORDER AROUND THE SILHOUETTE OF A HOUSE BEHIND A STYLIZED SILHOUETTE OF A HUMAN HEAD AND ARMS WRAPPED AROUND ANOTHER STYLIZED SILHOUETTE OF A SMALLER HUMAN HEAD AND SHOULDERS ABOVE THE WORDS "SAFE PLACE".

SEC. 2(F) AS TO "SAFE PLACE".
 FOR PROMOTING PUBLIC AWARENESS OF PUBLIC LOCATIONS IN THE COMMUNITY THROUGH WHICH A YOUTH CAN GAIN IMMEDIATE ACCESS TO SAFETY, SHELTER, AND COUNSELING SERVICES (U.S. CLS. 100, 101 AND 102).
 FIRST USE 10-4-1983; IN COMMERCE 1-30-1984.
 CHARISMA HAMPTON, EXAMINING ATTORNEY

SN 77-400,820. DIGIUM, INC., HUNTSVILLE, AL. FILED 2-19-2008.

ASTRICON

THE MARK CONSISTS OF STANDARD CHARACTERS WITHOUT CLAIM TO ANY PARTICULAR FONT, STYLE, SIZE, OR COLOR.
 FOR ARRANGING AND CONDUCTING TRADE SHOWS IN THE FIELD OF TELEPHONY (U.S. CLS. 100, 101 AND 102).
 FIRST USE 9-22-2004; IN COMMERCE 9-22-2004.
 MICHAEL LITZAU, EXAMINING ATTORNEY

CLASS 35—(Continued).

SN 77-402,281. EDUCATION WORLD, INC., SAN DIEGO, CA. FILED 2-21-2008.

THE EDUCATOR'S BEST FRIEND

THE MARK CONSISTS OF STANDARD CHARACTERS WITHOUT CLAIM TO ANY PARTICULAR FONT, STYLE, SIZE, OR COLOR.
 NO CLAIM IS MADE TO THE EXCLUSIVE RIGHT TO USE "EDUCATOR'S", APART FROM THE MARK AS SHOWN.
 FOR ADVERTISING AND BUSINESS SERVICES FOR OTHERS, NAMELY, PROMOTING THE EDUCATION-RELATED GOODS AND SERVICES OF OTHERS BY PREPARING AND PLACING ADVERTISEMENTS THAT ARE ACCESSIBLE AT A SITE ON A GLOBAL COMPUTER NETWORK (U.S. CLS. 100, 101 AND 102).
 COLLEEN DOMBROW, EXAMINING ATTORNEY

SN 77-402,708. CSR COMPANY, INC., OMAHA, NE. FILED 2-21-2008.

PRICE CHOMP DOWN

THE MARK CONSISTS OF STANDARD CHARACTERS WITHOUT CLAIM TO ANY PARTICULAR FONT, STYLE, SIZE, OR COLOR.
 FOR CATALOG ORDERING SERVICES AND ONLINE RETAIL STORE SERVICES FEATURING VETERINARY SUPPLIES, PET SUPPLIES AND HORSE SUPPLIES (U.S. CLS. 100, 101 AND 102).
 FIRST USE 9-30-2007; IN COMMERCE 9-30-2007.
 SHAUNIA CARLYLE, EXAMINING ATTORNEY

CLASS 35—(Continued).

SN 77-403,428. TABLE 10 GROUP, LLC, HOBOKEN, NJ. FILED 2-22-2008.

AntSul Group

THE MARK CONSISTS OF STANDARD CHARACTERS WITHOUT CLAIM TO ANY PARTICULAR FONT, STYLE, SIZE, OR COLOR.

NO CLAIM IS MADE TO THE EXCLUSIVE RIGHT TO USE "GROUP", APART FROM THE MARK AS SHOWN.

FOR RESTAURANT MANAGEMENT FOR OTHERS; ASSISTANCE IN FRANCHISED COMMERCIAL BUSINESS MANAGEMENT; FRANCHISE SERVICES, NAMELY, OFFERING BUSINESS MANAGEMENT ASSISTANCE IN THE ESTABLISHMENT AND OPERATION OF RESTAURANTS, BARS AND LOUNGES; RESTAURANT FRANCHISING; BUSINESS CONSULTATION SERVICES; BUSINESS CONSULTING, MANAGEMENT, PLANNING AND SUPERVISION; BUSINESS MANAGEMENT AND CONSULTATION; BUSINESS MANAGEMENT AND CONSULTATION IN THE FIELD OF RESTAURANTS, BARS AND LOUNGES (U.S. CLS. 100, 101 AND 102).

MICHAEL ENGEL, EXAMINING ATTORNEY

SN 77-404,500. CHANGING WAVES CONSULTING, LLC, DBA CHANGING WAVES CONSULTING, OAKLAND, CA. FILED 2-23-2008.



NO CLAIM IS MADE TO THE EXCLUSIVE RIGHT TO USE "CONSULTING", APART FROM THE MARK AS SHOWN.

THE MARK CONSISTS OF A WAVE DESIGN ON THE LEFT SIDE OF THE MARK. THE WORDING "CHANGING WAVES CONSULTING" APPEARS TO THE RIGHT OF THE WAVE DESIGN. THE WORD "CONSULTING" IS UNDER THE WORDS "CHANGING WAVES".

FOR MANAGEMENT AND BUSINESS CONSULTING SERVICES IN THE FIELD OF HUMAN RESOURCES AND ORGANIZATION DEVELOPMENT (U.S. CLS. 100, 101 AND 102).

FIRST USE 1-1-2008; IN COMMERCE 2-1-2008.

DAVID MURRAY, EXAMINING ATTORNEY

SN 77-407,487. TRANSOURCE, LLC, GREENVILLE, SC. FILED 2-27-2008.

Technology Co-Management

NO CLAIM IS MADE TO THE EXCLUSIVE RIGHT TO USE "TECHNOLOGY" AND "CO-MANAGEMENT", APART FROM THE MARK AS SHOWN.

FOR BUSINESS CONSULTING SERVICES RELATING TO SUPPLY CHAIN AND LOGISTICS MANAGEMENT; TRANSPORTATION LOGISTICS SERVICES, NAMELY, PROVIDING AN ON-LINE DATABASE FOR PLANNING AND COORDINATING TRANSPORTATION OF GOODS FOR OTHERS AND CONSULTATION IN CONNECTION THEREWITH (U.S. CLS. 100, 101 AND 102).

TARA PATE, EXAMINING ATTORNEY

CLASS 35—(Continued).

SN 77-407,832. ALL ABOUT SHOES, INC., SAN ANTONIO, TX. FILED 2-27-2008.

ALL ABOUT SHOES

THE MARK CONSISTS OF STANDARD CHARACTERS WITHOUT CLAIM TO ANY PARTICULAR FONT, STYLE, SIZE, OR COLOR.

NO CLAIM IS MADE TO THE EXCLUSIVE RIGHT TO USE "SHOES", APART FROM THE MARK AS SHOWN.

FOR RETAIL SHOE STORE SERVICES (U.S. CLS. 100, 101 AND 102).

FIRST USE 1-1-2007; IN COMMERCE 1-1-2007.

TIMOTHY FINNEGAN, EXAMINING ATTORNEY

SN 77-407,987. AMERICANA RESOURCES, INC., GAITHERSBURG, MD. FILED 2-27-2008.

Collectors Trade Show

THE MARK CONSISTS OF STANDARD CHARACTERS WITHOUT CLAIM TO ANY PARTICULAR FONT, STYLE, SIZE, OR COLOR.

NO CLAIM IS MADE TO THE EXCLUSIVE RIGHT TO USE "TRADE SHOW", APART FROM THE MARK AS SHOWN.

SEC. 2(F).

FOR ARRANGING AND CONDUCTING TRADE SHOW EXHIBITIONS IN THE FIELD OF PRODUCTS AND SERVICES FOR COLLECTING INDIVIDUALS, CLUBS, SOCIETIES, AND ORGANIZATIONS OF ANTIQUES AND COLLECTIBLES; CONDUCTING AN ON-LINE TRADE SHOW EXHIBITION, IN THE FIELD OF PRODUCTS AND SERVICES FOR COLLECTING INDIVIDUALS, CLUBS, SOCIETIES, AND ORGANIZATIONS OF ANTIQUES AND COLLECTIBLES (U.S. CLS. 100, 101 AND 102).

FIRST USE 3-1-2002; IN COMMERCE 3-1-2002.

KATHRYN COWARD, EXAMINING ATTORNEY

CLASS 35—(Continued).

SN 77-409,719. LATINO FAMILY MEDIA, INC., REDONDO BEACH, CA. FILED 2-29-2008.



NO CLAIM IS MADE TO THE EXCLUSIVE RIGHT TO USE "LATINO FAMILY MEDIA", APART FROM THE MARK AS SHOWN.

THE COLOR(S) PINK AND ORANGE IS/ARE CLAIMED AS A FEATURE OF THE MARK.

THE MARK CONSISTS OF THE WORDING "LATINOFAMILYMEDIA" IN LOWER-CASED, UNSPACED LETTERING, WITH "LATINO" AND "MEDIA" IN PINK AND "FAMILY" IN ORANGE, AND A DESIGN FEATURING PINK CIRCLES FORMING AN ARCH ABOVE THE WORD "FAMILY".

FOR ARRANGING AND CONDUCTING MARKETING PROMOTIONAL EVENTS FOR OTHERS (U.S. CLS. 100, 101 AND 102).

FIRST USE 5-1-2007; IN COMMERCE 5-1-2007.
KATHY DE JONGE, EXAMINING ATTORNEY

SN 77-411,091. NORTHEAST OHIO TECHNOLOGY COALITION, CLEVELAND, OH. FILED 3-3-2008.

THE NANOPAGES

THE MARK CONSISTS OF STANDARD CHARACTERS WITHOUT CLAIM TO ANY PARTICULAR FONT, STYLE, SIZE, OR COLOR.

FOR PROVIDING AN ON-LINE DIRECTORY INFORMATION SERVICE FEATURING INFORMATION IN THE FIELD OF NANOSCIENCE AND NANOTECHNOLOGY RESEARCH AND INDUSTRIAL ACTIVITIES (U.S. CLS. 100, 101 AND 102).

WENDY GOODMAN, EXAMINING ATTORNEY

SN 77-411,234. E+CO, BLOOMFIELD, NJ. FILED 3-3-2008.



NO CLAIM IS MADE TO THE EXCLUSIVE RIGHT TO USE "ENERGY", APART FROM THE MARK AS SHOWN.

THE DESIGN IS AN ELECTRICAL PLUG THAT ALSO SPELLS OUT "ECO" WITH THE LETTERS "E+CO" TO THE RIGHT OF THE DESIGN AND THE WORDS "ENERGY THROUGH ENTERPRISE" UNDERNEATH.

FOR BUSINESS VENTURE DEVELOPMENT AND FORMATION CONSULTING FOR THE RENEWABLE ENERGY INDUSTRY (U.S. CLS. 100, 101 AND 102).

FIRST USE 8-0-2001; IN COMMERCE 8-0-2001.
ROBIN CHOSID, EXAMINING ATTORNEY

CLASS 35—(Continued).

SN 77-411,905. SKLAVER, STACY G., ROCKVILLE, MD. FILED 3-3-2008.

ArtMatters

THE MARK CONSISTS OF STANDARD CHARACTERS WITHOUT CLAIM TO ANY PARTICULAR FONT, STYLE, SIZE, OR COLOR.

FOR CONSULTING SERVICES IN THE FIELD OF ART, NAMELY, ASSISTING CLIENTS IN SELECTING ART FOR PURCHASE AND IN SELECTING LOCATIONS FOR PLACEMENT AND DISPLAY IN COMMERCIAL AND RESIDENTIAL PROPERTIES OF CLIENTS (U.S. CLS. 100, 101 AND 102).

FIRST USE 6-0-2003; IN COMMERCE 6-0-2003.
JANICE KIM, EXAMINING ATTORNEY

SN 77-411,989. DOCTATIONS, INC., GARDEN CITY, NY. FILED 3-3-2008.

SPDB SHARED PATIENT DATABASE

THE MARK CONSISTS OF STANDARD CHARACTERS WITHOUT CLAIM TO ANY PARTICULAR FONT, STYLE, SIZE, OR COLOR.

NO CLAIM IS MADE TO THE EXCLUSIVE RIGHT TO USE "SHARED PATIENT DATABASE", APART FROM THE MARK AS SHOWN.

FOR PROVIDING AN INTERNET-BASED DATABASE OF PATIENT MEDICAL INFORMATION DESIGNED TO FACILITATE PATIENT-AUTHORIZED, HIPAA-COMPLIANT SHARING AND MAINTENANCE OF PATIENT MEDICAL INFORMATION AMONGST A PATIENT'S DOCTORS SUCH THAT THIS INFORMATION CAN BE DIRECTLY INSERTED INTO THE DOCTOR'S MEDICAL REPORTS AS A MEANS OF INCREASING MEDICAL RECORD GENERATION EFFICIENCY AND ACCURACY (U.S. CLS. 100, 101 AND 102).

ZACHARY BELLO, EXAMINING ATTORNEY

CLASS 35—(Continued).

SN 77-412,932. SEEKING SITTERS FRANCHISE SYSTEM, INC., TULSA, OK. FILED 3-4-2008.



OWNER OF U.S. REG. NO. 3,086,918.
NO CLAIM IS MADE TO THE EXCLUSIVE RIGHT TO USE "SEEKING SITTERS" AND "EASY, SAFE BABYSITTING", APART FROM THE MARK AS SHOWN.

THE MARK CONSISTS OF A BOY AND GIRL HOLDING A BANNER DISPLAYING THE WORDS "SEEKING SITTERS EASY, SAFE BABYSITTING SOLUTIONS".

FOR REFERRAL SERVICE OF EXPERIENCED AND PRESCREENED ON-CALL BABYSITTERS (U.S. CLS. 100, 101 AND 102).

FIRST USE 7-0-2006; IN COMMERCE 7-0-2006.
JIM RINGLE, EXAMINING ATTORNEY

SN 77-413,513. WESTERN REFINING, INC., EL PASO, TX. FILED 3-5-2008.

WESTERN EXPRESS

THE MARK CONSISTS OF STANDARD CHARACTERS WITHOUT CLAIM TO ANY PARTICULAR FONT, STYLE, SIZE, OR COLOR.

NO CLAIM IS MADE TO THE EXCLUSIVE RIGHT TO USE "EXPRESS", APART FROM THE MARK AS SHOWN.

FOR RETAIL STORE SERVICES FEATURING CONVENIENCE STORE ITEMS AND GASOLINE (U.S. CLS. 100, 101 AND 102).

TIMOTHY FINNEGAN, EXAMINING ATTORNEY

SN 77-413,644. ROBERTSON, SHEILA, HOUSTON, TX. FILED 3-5-2008.

PageantFaces.com

THE MARK CONSISTS OF STANDARD CHARACTERS WITHOUT CLAIM TO ANY PARTICULAR FONT, STYLE, SIZE, OR COLOR.

FOR ONLINE WEBSITE FEATURING BUSINESS, COMMERCIAL, ADVERTISING AND MARKETING, AND MANAGEMENT INFORMATION AND CONSULTATION AND RELATED NEWS ABOUT THE BEAUTY PAGEANT INDUSTRY (U.S. CLS. 100, 101 AND 102).

FIRST USE 1-1-2007; IN COMMERCE 1-1-2007.
MARY ROSSMAN, EXAMINING ATTORNEY

CLASS 35—(Continued).

SN 77-414,092. CBS STUDIOS INC., NEW YORK, NY. FILED 3-5-2008.

STAR TREK

THE MARK CONSISTS OF STANDARD CHARACTERS WITHOUT CLAIM TO ANY PARTICULAR FONT, STYLE, SIZE, OR COLOR.

OWNER OF U.S. REG. NOS. 1,583,006, 1,802,943 AND OTHERS.

FOR ARRANGING AND CONDUCTING TRADE SHOW EXHIBITIONS IN THE FIELD OF MOTION PICTURES AND TV SERIES (U.S. CLS. 100, 101 AND 102).

FIRST USE 12-31-2001; IN COMMERCE 12-31-2001.
MARTHA FROMM, EXAMINING ATTORNEY

SN 77-414,200. DRAGON MEDIA ONLINE, INC., OAKLAND, CA. FILED 3-5-2008.

DRAGONSTAR

THE MARK CONSISTS OF STANDARD CHARACTERS WITHOUT CLAIM TO ANY PARTICULAR FONT, STYLE, SIZE, OR COLOR.

OWNER OF U.S. REG. NO. 3,434,967.

FOR ADVERTISING AND BUSINESS MANAGEMENT CONSULTANCY; ADVERTISING AND COMMERCIAL INFORMATION SERVICES, VIA THE INTERNET; ADVERTISING AND MARKETING; ADVERTISING AND PROMOTION SERVICES AND RELATED CONSULTING; ADVERTISING AND PUBLICITY SERVICES; ADVERTISING BY TRANSMISSION OF ONLINE PUBLICITY FOR THIRD PARTIES THROUGH ELECTRONIC COMMUNICATIONS NETWORKS; ADVERTISING CONSULTATION; ADVERTISING PARTICULARLY SERVICES FOR THE PROMOTION OF GOODS; ADVERTISING SERVICES, NAMELY, CREATING CORPORATE AND BRAND IDENTITY FOR OTHERS; ADVERTISING VIA ELECTRONIC MEDIA AND SPECIFICALLY THE INTERNET; ADVERTISING, INCLUDING PROMOTION RELATING TO THE SALE OF ARTICLES AND SERVICES FOR THIRD PARTIES BY THE TRANSMISSION OF ADVERTISING MATERIAL AND THE DISSEMINATION OF ADVERTISING MESSAGES ON COMPUTER NETWORKS; ADVERTISING, MARKETING AND PROMOTION SERVICES; CONSULTANCY SERVICES REGARDING BUSINESS STRATEGIES; COOPERATIVE ADVERTISING AND MARKETING SERVICES BY WAY OF SOLICITATION, CUSTOMER SERVICE AND PRO-

CLASS 35—(Continued).

VIDING MARKETING INFORMATION VIA WEBSITES ON A GLOBAL COMPUTER NETWORK, CREATION OF MARKETING TOOLS DESIGNED TO INCREASE A CLIENT COMPANY'S KNOWLEDGE OF CUSTOMER NEEDS, AND ITS COMPETITORS' PRODUCTS AND SERVICES, PRICING, ADVERTISING STRATEGY AND SALES STRATEGY; DIRECT MARKETING ADVERTISING FOR OTHERS; DISSEMINATION OF ADVERTISING FOR OTHERS VIA AN ONLINE COMMUNICATIONS NETWORK ON THE INTERNET; DISSEMINATION OF ADVERTISING FOR OTHERS VIA THE INTERNET; MARKETING CONSULTING; MARKETING SERVICES, NAMELY PROVIDING INFORMATIONAL WEB PAGES DESIGNED TO GENERATE SALES TRAFFIC VIA HYPERLINKS TO OTHER WEB SITES; PROMOTION, ADVERTISING AND MARKETING OF ONLINE WEBSITES, ALL OF THE ABOVE SERVICES EXCLUDING INCENTIVE AWARD PROGRAMS AND INCENTIVE AWARD PROGRAMS FOR RETAILERS OF GAMES AND BOOKS (U.S. CLS. 100, 101 AND 102).

FIRST USE 2-0-2008; IN COMMERCE 2-0-2008.
LINDA LAVACHE, EXAMINING ATTORNEY

CLASS 35—(Continued).

SN 77-416,945. BLUE PILLAR, INC., ALPHARETTA, GA. FILED 3-8-2008.

KNOW.

THE MARK CONSISTS OF STANDARD CHARACTERS WITHOUT CLAIM TO ANY PARTICULAR FONT, STYLE, SIZE, OR COLOR.

FOR BUSINESS CONSULTATION IN THE FIELD OF POWER MANAGEMENT SOLUTIONS, NAMELY, PROVIDING COORDINATION, COMPLIANCE AND CRITICAL INSIGHT IN TIMES OF UTILITY POWER LOSS (U.S. CLS. 100, 101 AND 102).

FIRST USE 6-0-2007; IN COMMERCE 6-0-2007.
VIVIAN MICZNIK FIRST, EXAMINING ATTORNEY

SN 77-415,892. CONSTELLATION ENERGY GROUP, INC., BALTIMORE, MD. FILED 3-7-2008.

SN 77-418,379. HUG YOUR HERO GIFTS, INC., LAWRENCEVILLE, GA. FILED 3-11-2008.

Hug Your Hero

NEWRESPONSE

THE MARK CONSISTS OF STANDARD CHARACTERS WITHOUT CLAIM TO ANY PARTICULAR FONT, STYLE, SIZE, OR COLOR.

FOR OPERATING AN ONLINE SHOPPING SITE IN THE FIELD OF GIFTWARE (U.S. CLS. 100, 101 AND 102).

FIRST USE 12-13-2007; IN COMMERCE 12-13-2007.
KIMBERLY FRYE, EXAMINING ATTORNEY

THE MARK CONSISTS OF STANDARD CHARACTERS WITHOUT CLAIM TO ANY PARTICULAR FONT, STYLE, SIZE, OR COLOR.

OWNER OF U.S. REG. NOS. 2,488,649, 2,553,313 AND OTHERS.

FOR CONSULTATION SERVICES IN THE FIELDS OF ENERGY CONSUMPTION, ENERGY CONSERVATION, ENERGY EFFICIENCY, ENERGY USE AND DEMAND MANAGEMENT, RISK TOLERANCE, AND LOAD RESPONSE; ENERGY MANAGEMENT SERVICES, NAMELY, FORMULATING ENERGY LOAD REDUCTION PLANS; INFORMATION SERVICES, NAMELY, PROVIDING ON-LINE INFORMATION REGARDING ENERGY CONSUMPTION, ENERGY LOAD REDUCTION, AND ENERGY COSTS; ENERGY AUDITING, NAMELY, REVIEW AND ANALYSIS OF ENERGY CONSUMPTION; PROVIDING ENERGY EFFICIENCY AND ENERGY MANAGEMENT CONSULTATION UTILIZING EQUIPMENT WHICH MONITORS ENERGY LOAD RESPONSE, ENERGY EFFICIENCY AND ENERGY DEMAND; ENERGY USAGE MANAGEMENT SERVICES WHICH ASSIST CUSTOMERS IN REDUCING ENERGY CONSUMPTION IN RESPONSE TO ENERGY PRICES, SYSTEM RESOURCE CAPACITY NEEDS AND IN MAINTAINING ELECTRIC SYSTEM STABILITY (U.S. CLS. 100, 101 AND 102).

FIRST USE 9-1-2007; IN COMMERCE 9-1-2007.
KELLEY WELLS, EXAMINING ATTORNEY

SN 77-419,384. HCC CORP, AUSTIN, TX. FILED 3-11-2008.

Create A Remarkable Experience

THE MARK CONSISTS OF STANDARD CHARACTERS WITHOUT CLAIM TO ANY PARTICULAR FONT, STYLE, SIZE, OR COLOR.

FOR CONSULTING SERVICES IN THE FIELD OF HUMAN RESOURCES DEVELOPMENT, NAMELY, UTILIZING TECHNOLOGY FOR THE PROMOTION OF EMPLOYEE RETENTION, CAREER GROWTH AND INCREASED PRODUCTIVITY FOR EMPLOYEES AND EMPLOYERS (U.S. CLS. 100, 101 AND 102).

FIRST USE 12-1-2005; IN COMMERCE 1-4-2006.
BARNEY CHARLON, EXAMINING ATTORNEY

CLASS 35—(Continued).

SN 77-419,914. KORNBLUH, LARA, BROOKLYN, NY.
FILED 3-12-2008.

ICON STYLE BY LARA KORNBLUH

THE MARK CONSISTS OF STANDARD CHARACTERS WITHOUT CLAIM TO ANY PARTICULAR FONT, STYLE, SIZE, OR COLOR.

THE NAME "LARA KORNBLUH" IDENTIFIES A LIVING INDIVIDUAL WHOSE CONSENT IS OF RECORD.

FOR RETAIL STORE AND ONLINE RETAIL STORE FEATURING ANTIQUE JEWELRY, VINTAGE FASHION AND ACCESSORIES (U.S. CLS. 100, 101 AND 102).

FIRST USE 5-0-2005; IN COMMERCE 5-0-2005.
KYLE PEETE, EXAMINING ATTORNEY

SN 77-421,335. TREISTMAN GROUP, THE, NEW YORK, NY.
FILED 3-13-2008.

EYEVAlUE

THE MARK CONSISTS OF STANDARD CHARACTERS WITHOUT CLAIM TO ANY PARTICULAR FONT, STYLE, SIZE, OR COLOR.

FOR MARKETING CONSULTING SERVICES, NAMELY, PROVIDING CONSULTING SERVICES RELATING TO MARKETING, ADVERTISING, PUBLIC RELATIONS AND SALES; BUSINESS CONSULTING AND RESEARCH, NAMELY, MARKETING AND COMMUNICATIONS RESEARCH AS IT RELATES TO CONSUMER TRACKING BEHAVIOR, CONSUMER TREND ANALYSIS, BRANDING, MARKETING AND ADVERTISING; DEVELOPMENT OF MARKETING STRATEGIES AND CONCEPTS (U.S. CLS. 100, 101 AND 102).

FIRST USE 2-0-2008; IN COMMERCE 2-0-2008.
INGA ERVIN, EXAMINING ATTORNEY

SN 77-423,192. ECHALK INC, NEW YORK, NY. FILED 3-16-2008.

eChalk

THE MARK CONSISTS OF STANDARD CHARACTERS WITHOUT CLAIM TO ANY PARTICULAR FONT, STYLE, SIZE, OR COLOR.

OWNER OF U.S. REG. NO. 2,618,569.

FOR BUSINESS CONSULTATION IN THE FIELD OF EDUCATION, NAMELY, ASSISTING SCHOOL DISTRICTS AND SCHOOLS IN SETTING UP AND MAINTAINING WEB SITES, ONLINE CLASSROOMS, ONLINE AND DOWNLOADABLE EDUCATIONAL SOFTWARE, ONLINE MEETING AND MESSAGING SITES AND EMAIL AND FILE STORAGE (U.S. CLS. 100, 101 AND 102).

FIRST USE 9-30-1999; IN COMMERCE 9-30-1999.
ERIN FALK, EXAMINING ATTORNEY

CLASS 35—(Continued).

SN 77-426,635. TATWEER DUBAI LLC, DUBAI, UNITED ARAB EMIR., FILED 3-19-2008.

DUBAILAND

THE MARK CONSISTS OF STANDARD CHARACTERS WITHOUT CLAIM TO ANY PARTICULAR FONT, STYLE, SIZE, OR COLOR.

FOR ONLINE RETAIL STORE SERVICES FEATURING SOUVENIR MERCHANDISE (U.S. CLS. 100, 101 AND 102).

FRANK LATTUCA, EXAMINING ATTORNEY

SN 77-428,168. SEARS BRANDS, LLC, HOFFMAN ESTATES, IL. FILED 3-21-2008.

TOTALLY GHOUL

THE MARK CONSISTS OF STANDARD CHARACTERS WITHOUT CLAIM TO ANY PARTICULAR FONT, STYLE, SIZE, OR COLOR.

FOR RETAIL GIFT STORE SERVICES FEATURING HALLOWEEN PRODUCTS; RETAIL DEPARTMENT STORE SERVICES FEATURING HALLOWEEN PRODUCTS AS A SEASONAL DEPARTMENT; RETAIL STORE SERVICES FEATURING PRIMARILY HALLOWEEN PRODUCTS, NAMELY, CANDY, HALLOWEEN COSTUMES, HALLOWEEN DECORATIONS FOR THE HOME, TOYS, BAKING SPICES, STRINGS OF ELECTRIC LIGHTS, TOY FOG MACHINES, AND HAND TOOLS FOR USE IN CARVING OR DECORATING PUMPKINS, MINI-PUMPKINS, GOURDS, AND OTHER FRUITS AND VEGETABLES, NAMELY, KNIVES, SAWS, SCOOPS, CHISELS AND DRILLS (U.S. CLS. 100, 101 AND 102).

HANNO RITTNER, EXAMINING ATTORNEY

SN 77-429,578. BR CONSULTING, INC., SEDONA, AZ. FILED 3-24-2008.

SEDONA STORY

THE MARK CONSISTS OF STANDARD CHARACTERS WITHOUT CLAIM TO ANY PARTICULAR FONT, STYLE, SIZE, OR COLOR.

NO CLAIM IS MADE TO THE EXCLUSIVE RIGHT TO USE "SEDONA", APART FROM THE MARK AS SHOWN.

FOR RETAIL SHOPS FEATURING GIFTS, BAKED GOODS AND BEVERAGES (U.S. CLS. 100, 101 AND 102).
KATHY DE JONGE, EXAMINING ATTORNEY

CLASS 35—(Continued).

SN 77-429,843. BRENNER ASSOCIATES INC., DBA NATIONAL MARKETING SERVICES, EDISON, NJ. FILED 3-24-2008.

NMS

THE MARK CONSISTS OF STANDARD CHARACTERS WITHOUT CLAIM TO ANY PARTICULAR FONT, STYLE, SIZE, OR COLOR.

FOR IN STORE BUSINESS USE MERCHANDISING DISPLAY SERVICE FOR MANUFACTURERS (U.S. CLS. 100, 101 AND 102).

FIRST USE 0-0-1978; IN COMMERCE 0-0-1978.
KARANENDRA S. CHHINA, EXAMINING ATTORNEY



SN 77-431,122. JOHN ARAMIAN, RIDGEWOOD, NJ. FILED 3-25-2008.

H2O Foundation

THE MARK CONSISTS OF STANDARD CHARACTERS WITHOUT CLAIM TO ANY PARTICULAR FONT, STYLE, SIZE, OR COLOR.

NO CLAIM IS MADE TO THE EXCLUSIVE RIGHT TO USE "FOUNDATION", APART FROM THE MARK AS SHOWN.

FOR ADVERTISING, MARKETING AND PROMOTION SERVICES (U.S. CLS. 100, 101 AND 102).
TIMOTHY FINNEGAN, EXAMINING ATTORNEY



SN 77-432,391. VIDEOEGG, INC., SAN FRANCISCO, CA. FILED 3-26-2008.

VIDEOEGG

THE MARK CONSISTS OF STANDARD CHARACTERS WITHOUT CLAIM TO ANY PARTICULAR FONT, STYLE, SIZE, OR COLOR.

OWNER OF U.S. REG. NO. 3,385,937.
FOR ADVERTISING SERVICES, NAMELY, THE DISSEMINATION OF ADVERTISING FOR OTHERS VIA ELECTRONIC MEDIA, CREATION AND DESIGN OF ADVERTISING MATERIAL FOR OTHERS, AND TRACKING METRICS OF ADVERTISING FOR OTHERS (U.S. CLS. 100, 101 AND 102).

FIRST USE 1-18-2005; IN COMMERCE 9-1-2006.
NATALIE POLZER, EXAMINING ATTORNEY

CLASS 35—(Continued).

SN 77-435,685. AMERICAN AUTOMOBILE ASSOCIATION, INC., HEATHROW, FL. FILED 3-31-2008.

AAA SHOPLOCATOR

THE MARK CONSISTS OF STANDARD CHARACTERS WITHOUT CLAIM TO ANY PARTICULAR FONT, STYLE, SIZE, OR COLOR.

OWNER OF U.S. REG. NOS. 829,265 AND 2,900,596.
NO CLAIM IS MADE TO THE EXCLUSIVE RIGHT TO USE "SHOP LOCATOR", APART FROM THE MARK AS SHOWN.

FOR ON-LINE BUSINESS DIRECTORIES FEATURING MOTOR VEHICLE REPAIR SHOPS, PROVIDED VIA AN INTERACTIVE WEBSITE; MAKING VEHICLE REPAIR APPOINTMENTS VIA AN INTERACTIVE WEBSITE (U.S. CLS. 100, 101 AND 102).
MICHAEL GAAFAR, EXAMINING ATTORNEY



SN 77-437,690. WATERMARK RETIREMENT COMMUNITIES, INC., TUCSON, AZ. FILED 4-2-2008.



WATERMARK

THE MARK CONSISTS OF A STYLIZED LETTER "W" WITH A CIRCLE AROUND IT AND THE WORD "WATERMARK" UNDERNEATH.

FOR BUSINESS CONSULTING, MANAGEMENT, PLANNING AND SUPERVISION OF RETIREMENT COMMUNITIES AND ASSISTED LIVING FACILITIES IN THE SENIOR HOUSING INDUSTRY; ACCOUNTING SERVICES (U.S. CLS. 100, 101 AND 102).

FIRST USE 11-7-2006; IN COMMERCE 11-7-2006.
TOBY BULLOFF, EXAMINING ATTORNEY

CLASS 35—(Continued).

SN 77-438,228. IM MY ZONE LLC, NASHUA, NH. FILED 4-2-2008.

QUANTUM BALANCE

THE MARK CONSISTS OF STANDARD CHARACTERS WITHOUT CLAIM TO ANY PARTICULAR FONT, STYLE, SIZE, OR COLOR.

FOR ON-LINE RETAIL STORE SERVICES FEATURING NON-NUTRITIONAL AND NON-MEDICINAL PRODUCTS NOT FOR HUMAN APPLICATION OR CONSUMPTION, FOR ENHANCING A PERSON'S ENERGY AND FOR IMPARTING ENERGY TO OR SHIELDING NEGATIVE ENERGY FROM THE HUMAN BODY IN THE NATURE OF CARDS TO BE PLACED UNDER OR IN CONTACT WITH OBJECTS, STICKERS TO BE APPLIED TO SURFACES OF AN OBJECT, AND SPRAY TO BE SPRAYED TOWARD OR AROUND THE BODY (U.S. CLS. 100, 101 AND 102).

KAREN BRACEY, EXAMINING ATTORNEY

SN 77-440,564. APOTHECARY BOTANICA, A PHARMACY CORPORATION, DBA EL MACERO PHARMACY, DAVIS, CA. FILED 4-4-2008.

Apothecary Romantica

THE MARK CONSISTS OF STANDARD CHARACTERS WITHOUT CLAIM TO ANY PARTICULAR FONT, STYLE, SIZE, OR COLOR.

NO CLAIM IS MADE TO THE EXCLUSIVE RIGHT TO USE "APOTHECARY", APART FROM THE MARK AS SHOWN.

THE FOREIGN WORDING IN THE MARK TRANSLATES INTO ENGLISH AS "ROMANTIC".

FOR RETAIL PHARMACY SERVICES (U.S. CLS. 100, 101 AND 102).

MATTHEW EINSTEIN, EXAMINING ATTORNEY

CLASS 35—(Continued).

SN 77-445,259. AMERICAN AGRI-WOMEN, MANHATTAN, KS. FILED 4-10-2008.



OWNER OF U.S. REG. NO. 1,129,718.
NO CLAIM IS MADE TO THE EXCLUSIVE RIGHT TO USE "AMERICAN", APART FROM THE MARK AS SHOWN.
THE COLOR(S) GREEN IS/ARE CLAIMED AS A FEATURE OF THE MARK.

THE MARK CONSISTS OF GREEN CIRCLE WITH THREE GREEN LEAVES INSIDE, FEMALE SYMBOL, WITH GREEN WORDS ABOVE "AMERICAN AGRI-WOMEN".

FOR ASSOCIATION SERVICES, NAMELY, PROMOTING THE INTERESTS OF RURAL AMERICAN WOMEN AND PROMOTING THE INTERESTS OF FARMERS AND RANCHERS (U.S. CLS. 100, 101 AND 102).

FIRST USE 4-1-1976; IN COMMERCE 4-1-1976.
CAROLYN GRAY, EXAMINING ATTORNEY

SN 77-452,880. GABBIDON, ANDREW, QUEENS VILLAGE, NY. AND GABBIDON, KISHA, QUEENS VILLAGE, NY. FILED 4-20-2008.

MOCHA BRIDE

THE MARK CONSISTS OF STANDARD CHARACTERS WITHOUT CLAIM TO ANY PARTICULAR FONT, STYLE, SIZE, OR COLOR.

NO CLAIM IS MADE TO THE EXCLUSIVE RIGHT TO USE "BRIDE", APART FROM THE MARK AS SHOWN.

FOR ON-LINE RETAIL STORE SERVICES FEATURING SPECIAL OCCASION PARTY FAVORS, SPECIAL OCCASION GIFTS, MULTICULTURAL GIFTS, WEDDING SUPPLIES, AND SPECIAL OCCASION AND MULTICULTURAL APPAREL (U.S. CLS. 100, 101 AND 102).

CORY BOONE, EXAMINING ATTORNEY

CLASS 35—(Continued).

SN 77-453,684. ENVIRONMENTS, INC., BEAUFORT, SC. FILED 4-21-2008.

CLASS 35—(Continued).

SN 77-461,050. SECURING AMERICA'S FUTURE ENERGY ALLIANCE, INC., WASHINGTON, DC. AND SECURING AMERICA'S FUTURE ENERGY FOUNDATION, WASHINGTON, DC. FILED 4-29-2008.

BOOMBARS

THE MARK CONSISTS OF STANDARD CHARACTERS WITHOUT CLAIM TO ANY PARTICULAR FONT, STYLE, SIZE, OR COLOR.

FOR DISTRIBUTORSHIPS IN THE FIELD OF INFANTS' AND CHILDREN'S FURNITURE, TOYS AND GAMES, WHEELED TOYS, INDOOR PLAY EQUIPMENT, COSTUMES FOR CHILDREN, BOOKS, DOLLS AND DOLLS' ACCESSORIES, PUZZLES, MUSICAL INSTRUMENTS, PRERECORDED COMPACT DISCS FEATURING CHILDREN'S MUSIC, AND EDUCATIONAL MATERIALS (U.S. CLS. 100, 101 AND 102).

FIRST USE 2-15-2008; IN COMMERCE 2-15-2008.
KATHY DE JONGE, EXAMINING ATTORNEY

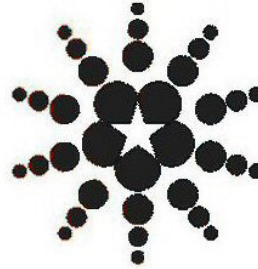

SN 77-457,561. MARSHALL RETAIL GROUP, LAS VEGAS, NV. FILED 4-24-2008.



THE COLOR(S) ORANGE, BLUE, YELLOW, PURPLE, GREEN AND GRAY IS/ARE CLAIMED AS A FEATURE OF THE MARK.

THE MARK CONSISTS OF A STYLIZED ORANGE "B", A BLUE "R", A YELLOW "A", A PURPLE "T", AND A GREEN "S" WITH A GRAY OUTLINE.

FOR RETAIL CLOTHING STORES (U.S. CLS. 100, 101 AND 102).

FIRST USE 11-30-1982; IN COMMERCE 11-30-1982.
ANGELA M. MICHELI, EXAMINING ATTORNEY

FOR PROVIDING INFORMATION IN THE FIELDS OF FUEL AND ENERGY USAGE MANAGEMENT AND CONSERVATION; PROMOTING THE INTERESTS OF FUEL AND ENERGY MANAGEMENT AND CONSERVATION VIA THE PROVISION OF INFORMATION; PROVIDING INFORMATION IN THE FIELDS OF FUEL AND ENERGY PUBLIC POLICY; PROVIDING INFORMATION AND ANALYSIS IN THE FIELDS OF ECONOMICS AND BUSINESS CONCERNING FUEL AND ENERGY; POLITICAL CONSULTANCY CONCERNING FUEL AND ENERGY; PROVIDING INFORMATION REGARDING POLITICAL ISSUES, NAMELY, POLITICAL ISSUES IN THE FIELDS OF FUEL AND ENERGY RESOURCES, POLICY, SECURITY, MANAGEMENT AND CONSERVATION, AND ALTERNATIVE FUEL SOURCES, ALTERNATIVE ENERGY SOURCES, AND ENVIRONMENTAL MATTERS CONCERNING FUEL AND ENERGY; LOBBYING SERVICES, NAMELY, PROMOTING THE INTERESTS OF THE PUBLIC IN THE FIELDS OF LEGISLATION AND REGULATION CONCERNING FUEL AND ENERGY RESOURCES, POLICY, SECURITY, MANAGEMENT AND CONSERVATION, AND ALTERNATIVE FUEL SOURCES, ALTERNATIVE ENERGY SOURCES, AND ENVIRONMENTAL MATTERS CONCERNING FUEL AND ENERGY; PUBLIC POLICY RESEARCH SERVICES (U.S. CLS. 100, 101 AND 102).

CHERYL CLAYTON, EXAMINING ATTORNEY

CLASS 35—(Continued).

SN 77-462,763. TPI HOLDINGS, INC., NORFOLK, VA. FILED 5-1-2008.

EQUIPMENT TRADER

THE MARK CONSISTS OF STANDARD CHARACTERS WITHOUT CLAIM TO ANY PARTICULAR FONT, STYLE, SIZE, OR COLOR.

OWNER OF U.S. REG. NOS. 1,473,136, 3,420,543 AND OTHERS.

NO CLAIM IS MADE TO THE EXCLUSIVE RIGHT TO USE "EQUIPMENT", APART FROM THE MARK AS SHOWN.

FOR ADVERTISING SERVICES, NAMELY, PREPARING AND DISSEMINATING ADVERTISING FOR OTHERS VIA AN ONLINE ELECTRONIC COMMUNICATIONS NETWORK; COMPUTER SERVICES, NAMELY, PROVIDING A DATABASE FEATURING SALES INFORMATION, DEALERSHIP SERVICES INFORMATION, AND CLASSIFIED AND DISPLAY ADVERTISING CONCERNING HEAVY EQUIPMENT PRODUCTS VIA AN ONLINE ELECTRONIC COMMUNICATIONS NETWORK (U.S. CLS. 100, 101 AND 102).

FIRST USE 10-1-2007; IN COMMERCE 10-1-2007.
KRISTIN CARLSON, EXAMINING ATTORNEY

SN 77-470,275. NOVANTAS, LLC, NEW YORK, NY. FILED 5-9-2008.

 **BRANCHSCAPE**

OWNER OF U.S. REG. NO. 3,498,842.

THE COLOR(S) GOLD, DARK BLUE, AND LIGHT BLUE IS/ARE CLAIMED AS A FEATURE OF THE MARK.

THE MARK CONSISTS OF THE COLORS GOLD, LIGHT BLUE, AND DARK BLUE, WITH THE DESIGN OF A RAM'S HORN APPEARING IN GOLD, FOLLOWED BY THE WORD "BRANCHSCAPE" WITH THE WORD "BRANCH" APPEARING IN DARK BLUE BOLD CAPITAL LETTERS, FOLLOWED BY THE WORD "SCAPE" APPEARING IN NON-BOLD LIGHT BLUE CAPITAL LETTERS. THE COLOR WHITE REPRESENTS THE BACKGROUND AND IS NOT CLAIMED AS PART OF THE MARK.

FOR BUSINESS MANAGEMENT CONSULTING WITH RELATION TO STRATEGY, MARKETING, SALES, OPERATION, PRODUCT DESIGN PARTICULARLY SPECIALIZING IN THE USE OF ANALYTIC AND STATISTIC MODELS FOR THE UNDERSTANDING AND PREDICTING OF CONSUMERS, BUSINESSES, AND MARKET TRENDS AND ACTIONS (U.S. CLS. 100, 101 AND 102).

FIRST USE 8-25-2006; IN COMMERCE 8-25-2006.
JEFF DEFORD, EXAMINING ATTORNEY

CLASS 35—(Continued).

SN 77-473,195. FEDERAL RESERVE BANK OF ATLANTA, ATLANTA, GA. FILED 5-13-2008.

 **americas center**

NO CLAIM IS MADE TO THE EXCLUSIVE RIGHT TO USE "AMERICAS CENTER", APART FROM THE MARK AS SHOWN.

THE MARK CONSISTS OF THE WORDS "AMERICAS CENTER" WITH THE DESIGN OF A SUN RISING OVER THE LETTER "I".

FOR PROMOTING INTERNATIONAL UNDERSTANDING, COOPERATION AND COORDINATION IN THE AREA OF BANKING, ECONOMICS, MONETARY POLICY AND REGIONAL PAYMENT PROCESSING (U.S. CLS. 100, 101 AND 102).

FIRST USE 6-0-2005; IN COMMERCE 6-0-2005.
JAY FLOWERS, EXAMINING ATTORNEY

SN 77-486,434. OFFICEFURNITURE.COM, LLC, MILWAUKEE, WI. FILED 5-29-2008.

officefurniture.com

OWNER OF U.S. REG. NO. 2,634,907.

NO CLAIM IS MADE TO THE EXCLUSIVE RIGHT TO USE "OFFICEFURNITURE.COM", APART FROM THE MARK AS SHOWN.

THE MARK CONSISTS OF THE WORD "OFFICEFURNITURE.COM" IN A STYLIZED FORM, UNDERLINED WITH AN ELEMENT THAT RESEMBLES A COMET TAIL.

FOR ONLINE RETAIL STORE SERVICES FEATURING OFFICE FURNITURE AND ACCESSORIES (U.S. CLS. 100, 101 AND 102).

FIRST USE 10-30-2006; IN COMMERCE 10-30-2006.
TRACY CROSS, EXAMINING ATTORNEY

CLASS 35—(Continued).

SN 77-489,530. LEVINE-MARTIN, INC., DIX HILLS, NY. FILED 6-3-2008.



NO CLAIM IS MADE TO THE EXCLUSIVE RIGHT TO USE "MARKETING", APART FROM THE MARK AS SHOWN.

THE MARK CONSISTS OF A BLACK BACKGROUND WITH WHITE LETTERS THAT SPELL "SMART" IN THE UPPER LEFT CORNER OF THE IMAGE AND SPELL "MARKETING" IN THE LOWER LEFT CORNER OF THE IMAGE. IN THE CENTER IS A WHITE DRAWING OF A MAN'S PROFILE WITH A LINE COMING OFF THE BRIDGE OF HIS NOSE.

FOR ADVERTISING AND PUBLICITY SERVICES; ADVERTISING SERVICES, PUBLIC RELATIONS AND MARKETING SERVICES, NAMELY, PROMOTING AND MARKETING THE GOODS AND SERVICES OF OTHERS THROUGH ALL PUBLIC COMMUNICATION MEANS (U.S. CLS. 100, 101 AND 102).

FIRST USE 12-1-1994; IN COMMERCE 12-1-1994.
STEPHANIE ALI, EXAMINING ATTORNEY

CLASS 35—(Continued).

SN 77-494,958. DISCOUNT STEEL, INC., MINNEAPOLIS, MN. FILED 6-10-2008.



THE MARK CONSISTS OF THE WHITE LETTERS "OMS" WITH A DIAMOND DESIGN ABOVE THE LETTER "M". A BLACK BACKGROUND APPEARS BEHIND THE LETTERING AND DIAMOND DESIGN.

FOR ONLINE STORE SERVICES FEATURING RAW METAL IN UNFINISHED FORM FOR USE IN FURTHER MANUFACTURE (U.S. CLS. 100, 101 AND 102).

ROSELLE HERRERA, EXAMINING ATTORNEY

SN 77-497,032. CVS PHARMACY, INC., WOONSOCKET, RI. FILED 6-12-2008.

BEAUTY 360

THE MARK CONSISTS OF STANDARD CHARACTERS WITHOUT CLAIM TO ANY PARTICULAR FONT, STYLE, SIZE, OR COLOR.

NO CLAIM IS MADE TO THE EXCLUSIVE RIGHT TO USE "BEAUTY", APART FROM THE MARK AS SHOWN.

FOR RETAIL STORE SERVICES AND ONLINE RETAIL STORE SERVICES FEATURING HEALTH AND BEAUTY PRODUCTS AND GENERAL CONSUMER MERCHANDISE (U.S. CLS. 100, 101 AND 102).

PAUL CROWLEY, EXAMINING ATTORNEY

SN 77-493,790. EPPS, JOHN D. DBA EPPS AUTO CO. LLC, WASHINGTON, DC. FILED 6-8-2008.

EPPS AUTO CO.



NO CLAIM IS MADE TO THE EXCLUSIVE RIGHT TO USE "AUTO CO.", APART FROM THE MARK AS SHOWN.

THE MARK CONSISTS OF THE WORDING "EPPS AUTO CO." AND THE DESIGN OF AN AUTOMOBILE GRILL WITH A STYLIZED "E" IN THE CENTER.

FOR RETAIL AUTOMOBILE PARTS AND ACCESSORIES STORES (U.S. CLS. 100, 101 AND 102).

HOWARD B. LEVINE, EXAMINING ATTORNEY

SN 77-498,400. PERSONAVITA, INC., SACRAMENTO, CA. FILED 6-13-2008.

BEaT

THE MARK CONSISTS OF STANDARD CHARACTERS WITHOUT CLAIM TO ANY PARTICULAR FONT, STYLE, SIZE, OR COLOR.

FOR BUSINESS SERVICES FEATURING THE IMPLEMENTATION OF A METHODOLOGY FOR SCORING OR RANKING AN INDIVIDUAL BASED ON ATTRIBUTES, PEER FEEDBACK, AND INTERESTS, FOR USE IN BUSINESS NETWORKING (U.S. CLS. 100, 101 AND 102).

LINDA E. BLOHM, EXAMINING ATTORNEY

CLASS 35—(Continued).

SN 77-500,545. THE NIELSEN COMPANY (US), LLC, SCHAUMBURG, IL. FILED 6-17-2008.

HEALTHSCAPE

THE MARK CONSISTS OF STANDARD CHARACTERS WITHOUT CLAIM TO ANY PARTICULAR FONT, STYLE, SIZE, OR COLOR.

FOR MARKET RESEARCH SERVICES RELATED TO PHARMACEUTICAL MARKETING AND SALES, RETAIL DRUG STORES, HEALTHCARE PRODUCT MARKETING AND SALES, AND PATIENT AND CUSTOMER PURCHASING AND CONSUMPTION BEHAVIOR AND ADVERTISING RESEARCH SERVICES RELATED TO HEALTHCARE AND PHARMACEUTICAL ADVERTISING AND MEDIA EXPENDITURES (U.S. CLS. 100, 101 AND 102).

INGA ERVIN, EXAMINING ATTORNEY

SN 77-502,005. CUNNINGHAM RESEARCH GROUP, INC., ORMOND BEACH, FL. FILED 6-18-2008.

TESTAMERICA

THE MARK CONSISTS OF STANDARD CHARACTERS WITHOUT CLAIM TO ANY PARTICULAR FONT, STYLE, SIZE, OR COLOR.

FOR PROVIDING RESEARCH SERVICES TO OTHERS REGARDING MARKETING, CONSUMER ATTITUDES AND PERCEPTIONS, AND POLLING INFORMATION (U.S. CLS. 100, 101 AND 102).

FIRST USE 5-0-2005; IN COMMERCE 5-0-2005.

WILLIAM BRECKENFELD, EXAMINING ATTORNEY

SN 77-507,707. GRAGG ADVERTISING, INC., KANSAS CITY, MO. FILED 6-25-2008.

INTERNET2PHONE

THE MARK CONSISTS OF STANDARD CHARACTERS WITHOUT CLAIM TO ANY PARTICULAR FONT, STYLE, SIZE, OR COLOR.

FOR PROVIDING DEMAND CREATION AND LEAD GENERATION ACTIVITIES AND SERVICES, NAMELY, MATCHING PROSPECTIVE CUSTOMER REQUESTS FOR PRODUCT OR SERVICE INFORMATION COLLECTED OVER THE INTERNET TO A PROVIDER OF THE REQUESTED PRODUCT OR SERVICE (U.S. CLS. 100, 101 AND 102).

FIRST USE 2-0-2008; IN COMMERCE 2-0-2008.

JOHN SCHUYLER YARD, EXAMINING ATTORNEY

CLASS 35—(Continued).

SN 77-510,257. BULLDOZER LLC, O'FALLON, IL. FILED 6-27-2008.

BULLDOZER

THE MARK CONSISTS OF STANDARD CHARACTERS WITHOUT CLAIM TO ANY PARTICULAR FONT, STYLE, SIZE, OR COLOR.

FOR ADVERTISING SERVICES, PUBLIC RELATIONS SERVICES, MARKETING SERVICES, AND CREATIVE MARKETING DESIGN SERVICES (U.S. CLS. 100, 101 AND 102).

KRISTIN CARLSON, EXAMINING ATTORNEY

SN 77-511,405. ECOM PPO ADVISORS, INC., DALLAS, TX. FILED 6-30-2008.

PPO Report Card

THE MARK CONSISTS OF STANDARD CHARACTERS WITHOUT CLAIM TO ANY PARTICULAR FONT, STYLE, SIZE, OR COLOR.

NO CLAIM IS MADE TO THE EXCLUSIVE RIGHT TO USE "PPO", APART FROM THE MARK AS SHOWN.

FOR BUSINESS CONSULTING, MANAGEMENT, PLANNING AND SUPERVISION; COST MANAGEMENT FOR THE HEALTH CARE BENEFIT PLANS OF OTHERS (U.S. CLS. 100, 101 AND 102).

ELLEN PERKINS, EXAMINING ATTORNEY

SN 77-511,474. MARS ADVERTISING, INC., SOUTHFIELD, MI. FILED 6-30-2008.

WHERE THE SHOPPER IS THE HERO

THE MARK CONSISTS OF STANDARD CHARACTERS WITHOUT CLAIM TO ANY PARTICULAR FONT, STYLE, SIZE, OR COLOR.

FOR ADVERTISING AND PROMOTIONAL SERVICES (U.S. CLS. 100, 101 AND 102).

FIRST USE 4-23-2008; IN COMMERCE 4-23-2008.

MAYUR VAGHANI, EXAMINING ATTORNEY

CLASS 35—(Continued).

SN 77-512,084. MOTION FITNESS, PALATINE, IL. FILED 7-1-2008.

MOTION FITNESS

THE MARK CONSISTS OF STANDARD CHARACTERS WITHOUT CLAIM TO ANY PARTICULAR FONT, STYLE, SIZE, OR COLOR.

NO CLAIM IS MADE TO THE EXCLUSIVE RIGHT TO USE "FITNESS", APART FROM THE MARK AS SHOWN.

FOR THE BRINGING TOGETHER, FOR THE BENEFIT OF OTHERS, OF A VARIETY OF GOODS, ENABLING CUSTOMERS TO CONVENIENTLY VIEW AND PURCHASE THOSE GOODS IN THE FIELD OF EXERCISE EQUIPMENT, FITNESS PRODUCTS, BACK CARE PRODUCTS (U.S. CLS. 100, 101 AND 102).

FIRST USE 5-4-1998; IN COMMERCE 5-4-1998.
TASNEEM HUSSAIN, EXAMINING ATTORNEY

CLASS 35—(Continued).

SN 77-522,144. CORNELIA STREET GROUP, INC., NEW YORK, NY. FILED 7-15-2008.



The logo for "Murray's by Mail" features the word "Murray's" in a stylized, cursive script font with a thick underline, followed by the words "by Mail" in a clean, sans-serif font.

OWNER OF U.S. REG. NOS. 2,230,051, 2,859,620 AND 2,864,447.

NO CLAIM IS MADE TO THE EXCLUSIVE RIGHT TO USE "BY MAIL", APART FROM THE MARK AS SHOWN.

THE MARK CONSISTS OF THE WORD "MURRAY'S" IN SCRIPT, ON A SLIGHTLY UPWARD ANGLE AND UNDERLINED BEGINNING FROM AND CONTINUING FROM THE LETTER "Y", THE WORDS "BY MAIL" IN BLOCK PRINT.

FOR MAIL ORDER SERVICES, NAMELY, THE ORDERING OF CHEESE, CHEESE SPREADS AND CHEESE SUBSTITUTES (U.S. CLS. 100, 101 AND 102).

TARA PATE, EXAMINING ATTORNEY

SN 77-521,257. TASTY DESIGNS, DBA TASTY CONCEPTS, WASHINGTON, DC. FILED 7-14-2008.

tasty concepts

THE MARK CONSISTS OF STANDARD CHARACTERS WITHOUT CLAIM TO ANY PARTICULAR FONT, STYLE, SIZE, OR COLOR.

FOR ADVERTISING AGENCIES PROVIDING THE STRATEGY, DESIGN AND EXECUTION OF PROGRAMS TO PROMOTE BUSINESSES IN THE FOOD AND FOODSERVICE INDUSTRIES; BUSINESS CARD DESIGN SERVICES; CREATIVE MARKETING DESIGN SERVICES; DESIGN OF ADVERTISING FLYERS FOR OTHERS; DESIGN OF ADVERTISING MATERIALS FOR OTHERS; DESIGN OF INTERNET ADVERTISING; MARKETING SERVICES, NAMELY, PROVIDING INFORMATIONAL WEB PAGES DESIGNED TO GENERATE SALES TRAFFIC VIA HYPERLINKS TO OTHER WEB SITES; PROVIDING ADVERTISING SERVICES USING 3D AND ANIMATION DESIGNS; PROVIDING ADVERTISING, MARKETING AND PROMOTIONAL SERVICES, NAMELY, DEVELOPMENT OF ADVERTISING CAMPAIGNS FOR WEB DESIGN, PRINT, CD ROM (U.S. CLS. 100, 101 AND 102).

EDWARD NELSON, EXAMINING ATTORNEY

SN 77-525,619. CAREERSCRIBE, LLC, ZIONSVILLE, IN. FILED 7-18-2008.

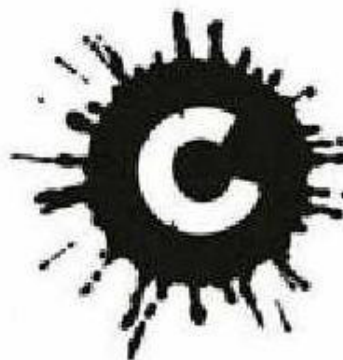

THE MARK CONSISTS OF THE LETTER "C" WITHIN AN INK SPLATTER SPOT DESIGN.

FOR EMPLOYMENT COUNSELING AND RECRUITING; PERSONNEL RECRUITMENT SERVICES AND EMPLOYMENT AGENCIES; PROVIDING AN INTERACTIVE WEB SITE THAT FACILITATES THE RECRUITING, INTERVIEWING AND HIRING PROCESS (U.S. CLS. 100, 101 AND 102).

FIRST USE 4-0-2008; IN COMMERCE 4-0-2008.
JACLYN KIDWELL, EXAMINING ATTORNEY

CLASS 35—(Continued).

SN 77-526,302. JOHN PALING & CO. INC., GAINESVILLE, FL. FILED 7-18-2008.



THE MARK CONSISTS OF THE MARK IS THE "EARTH" BEING APPROACHED BY HUMAN HANDS ON EITHER SIDE.

FOR PROMOTING THE AWARENESS OF THE NEED FOR ENVIRONMENTAL RESPONSIBILITY THROUGH THE PRESENTATION OF AN AWARD (U.S. CLS. 100, 101 AND 102).

FIRST USE 6-1-2008; IN COMMERCE 6-1-2008.
HEATHER SAPP, EXAMINING ATTORNEY

SN 77-529,772. SHAKIB, SIMON K., LAS VEGAS, NV. FILED 7-23-2008.



NO CLAIM IS MADE TO THE EXCLUSIVE RIGHT TO USE "PERSIAN POLITICAL ACTION COMMITTEE" AND "PERSIAN PAC", APART FROM THE MARK AS SHOWN.

THE COLOR(S) WHITE, GOLD, BLUE, RED, GREEN, BROWN, TAN AND BLACK IS/ARE CLAIMED AS A FEATURE OF THE MARK.

THE MARK CONSISTS OF A CIRCULAR SEAL, WITH A BLUE OUTER RIM, OUTLINED IN BLACK AND THE CIRCULAR INSCRIPTION STATING, "CONTRIBUTION OF PERSIAN EXCELLENCE TO INTERNATIONAL CIVILIZATION", WHICH IS WRITTEN IN WHITE AND OUTLINED IN BLACK. THE OUTER RIM AND THE INNER CIRCLE ARE SEPARATED BY A GOLD BAND. INSIDE THE INNER CIRCLE, CENTERED ON THE TOP AND FOLLOWING THE CONTOUR OF THE CIRCLE, WRITTEN IN WHITE AND OUTLINED IN BLACK IT STATES, "PERSIAN POLITICAL ACTION COMMITTEE". AT THE BOTTOM OF THE INNER CIRCLE, "PERSIAN PAC" IS WRITTEN IN WHITE STYLIZED WRITING HORIZONTALLY AND OUTLINED IN BLACK. IN THE BACKGROUND ON THE LEFT HALF OF THE INNER CIRCLE

CLASS 35—(Continued).

IS A PARTIAL DISPLAY OF THE AMERICAN FLAG WITH A WHITE BALD EAGLE CENTERED THEREON. THE AMERICAN FLAG AND EAGLE ARE ENAMORED IN THE TRADITIONAL COLORS OF RED, WHITE, BLUE, GOLD AND BROWN. ON THE RIGHT SIDE OF THE INNER CIRCLE IS A PARTIAL DISPLAY OF THE IRANIAN FLAG WHICH HAS A LION CENTERED THEREON. THE IRANIAN FLAG AND LION ARE ENAMORED IN THE TRADITIONAL COLORS OF GREEN, WHITE, RED, TAN AND BROWN.

FOR LOBBYING SERVICES, NAMELY, PROMOTING THE INTERESTS OF INTERNATIONAL, REAL ESTATE AND NONPROFIT COMPANIES IN THE FIELDS OF POLITICS, LEGISLATION, AND REGULATION; POLITICAL ACTION COMMITTEE SERVICES, NAMELY, PROMOTING THE INTERESTS OF AMERICAN IRANIANS TO PROMOTE THE ESTABLISHMENT OF HUMAN RIGHTS AND SECULAR DEMOCRACY IN IRAN IN THE FIELD OF POLITICS (U.S. CLS. 100, 101 AND 102).

FIRST USE 3-1-2007; IN COMMERCE 3-1-2007.
JULIE GUTTADAURO, EXAMINING ATTORNEY

SN 77-531,669. ULTRALUX, LLC, HOLLYWOOD, FL. FILED 7-25-2008.

DEXCLUSIVE

THE MARK CONSISTS OF THE WORDING "DEXCLUSIVE" UNDERLINED WITH MULTIPLE DOTS ABOVE THE LETTER "I".

FOR ONLINE RETAIL STORE SERVICES FEATURING WATCHES AND JEWELRY (U.S. CLS. 100, 101 AND 102).

FIRST USE 6-0-2006; IN COMMERCE 6-0-2006.
WON TEAK OH, EXAMINING ATTORNEY

SN 77-532,046. ZUBER & TAILLIEU LLP, LOS ANGELES, CA. FILED 7-25-2008.

LawLoop.com

THE MARK CONSISTS OF STANDARD CHARACTERS WITHOUT CLAIM TO ANY PARTICULAR FONT, STYLE, SIZE, OR COLOR.

FOR ON-LINE ADVERTISING AND MARKETING SERVICES (U.S. CLS. 100, 101 AND 102).

CIMMERIAN COLEMAN, EXAMINING ATTORNEY

CLASS 35—(Continued).

SN 77-532,623. HOTEL EFFECTIVENESS LLC, ATLANTA, GA. FILED 7-28-2008.

HOTEL EFFECTIVENESS

THE MARK CONSISTS OF STANDARD CHARACTERS WITHOUT CLAIM TO ANY PARTICULAR FONT, STYLE, SIZE, OR COLOR.

NO CLAIM IS MADE TO THE EXCLUSIVE RIGHT TO USE "HOTEL", APART FROM THE MARK AS SHOWN.

FOR BUSINESS PROCESS OUTSOURCING SERVICES IN THE FIELD OF HOSPITALITY; OFFICE ADMINISTRATION SERVICES (U.S. CLS. 100, 101 AND 102).

FIRST USE 12-10-2007; IN COMMERCE 1-22-2008.

DAVID I, EXAMINING ATTORNEY

SN 77-533,271. SOURCE INTERLINK DISTRIBUTION, LLC, NEW YORK, NY. FILED 7-29-2008.

MAGVISION

THE MARK CONSISTS OF STANDARD CHARACTERS WITHOUT CLAIM TO ANY PARTICULAR FONT, STYLE, SIZE, OR COLOR.

FOR PROVIDING AN ON-LINE COMPUTER DATABASE AND WEBSITE FEATURING PROPRIETARY BUSINESS INFORMATION RELATED TO THE MAGAZINE AND PUBLICATION INDUSTRIES (U.S. CLS. 100, 101 AND 102).

STEVEN PEREZ, EXAMINING ATTORNEY

SN 77-537,720. LAPLANTE CHERYL A., ONEIDA, WI. FILED 8-3-2008.

Vivid Pages

THE MARK CONSISTS OF STANDARD CHARACTERS WITHOUT CLAIM TO ANY PARTICULAR FONT, STYLE, SIZE, OR COLOR.

NO CLAIM IS MADE TO THE EXCLUSIVE RIGHT TO USE "PAGES", APART FROM THE MARK AS SHOWN.

FOR ADVERTISING SERVICES, NAMELY, AN ON-LINE YELLOW PAGE DIRECTORY; PROMOTING THE GOODS AND SERVICES OF OTHERS BY PREPARING AND PLACING ADVERTISEMENTS, HYPERLINKS AND INFORMATION OF CITY AND BUSINESS LISTINGS IN DIRECTORY DATABASES ACCESSED THROUGH A GLOBAL COMPUTER NETWORK AND DISTRIBUTION AND DISSEMINATION OF ADVERTISING MATERIAL (U.S. CLS. 100, 101 AND 102).

HEATHER BIDDULPH, EXAMINING ATTORNEY

CLASS 35—(Continued).

SN 77-538,870. DAVID L. THOMAS II, DBA DAVE THOMAS, JONESBORO, GA. FILED 8-4-2008.

**DT Enterprises (DTE)
Executive Business
Consultants
Better! Faster! Easier!
Smarter!**

THE MARK CONSISTS OF STANDARD CHARACTERS WITHOUT CLAIM TO ANY PARTICULAR FONT, STYLE, SIZE, OR COLOR.

NO CLAIM IS MADE TO THE EXCLUSIVE RIGHT TO USE "ENTERPRISES" AND "EXECUTIVE BUSINESS CONSULTANTS", APART FROM THE MARK AS SHOWN.

FOR BUSINESS CONSULTING SERVICES IN THE FIELD OF ORGANIZATIONAL CHANGE MANAGEMENT; BUSINESS CONSULTING SERVICES, NAMELY, PROVIDING ASSISTANCE IN DEVELOPMENT OF BUSINESS STRATEGIES AND CREATIVE IDEATION; BUSINESS CONSULTING, MANAGEMENT, PLANNING AND SUPERVISION; BUSINESS MANAGEMENT CONSULTANCY AS WELL AS DEVELOPMENT OF PROCESSES FOR THE ANALYSIS AND THE IMPLEMENTATION OF STRATEGY PLANS AND MANAGEMENT PROJECTS; BUSINESS MANAGEMENT CONSULTATION; BUSINESS MANAGEMENT CONSULTATION IN THE FIELD OF EXECUTIVE AND LEADERSHIP DEVELOPMENT; BUSINESS MANAGEMENT CONSULTING; BUSINESS MANAGEMENT CONSULTING AND ADVISORY SERVICES; BUSINESS ORGANISATION AND MANAGEMENT CONSULTING SERVICES; BUSINESS ORGANISATION CONSULTING; BUSINESS ORGANIZATION AND MANAGEMENT CONSULTING; CONSULTING SERVICES IN BUSINESS LEADERSHIP DEVELOPMENT AND BUSINESS MANAGEMENT; CONSULTING SERVICES IN BUSINESS ORGANIZATION AND MANAGEMENT; CONSULTING SERVICES IN THE AREA OF SUSTAINABLE BUSINESS SOLUTIONS; CONSULTING SERVICES IN THE COST AND PAYMENT MANAGEMENT OF HEALTH CARE; CONSULTING SERVICES IN THE FIELD OF HUMAN RESOURCES DEVELOPMENT, NAMELY, FOR THE PROMOTION OF EMPLOYEE RETENTION, CAREER GROWTH, AND INCREASED PRODUCTIVITY FOR EMPLOYEES AND EMPLOYERS; CONSULTING SERVICES IN THE FIELD OF HUMAN RESOURCES DEVELOPMENT, NAMELY, UTILIZING TECHNOLOGY FOR THE PROMOTION OF EMPLOYEE RETENTION, CAREER GROWTH AND INCREASED PRODUCTIVITY FOR EMPLOYEES AND EMPLOYERS; HUMAN RESOURCES CONSULTATION; MANAGEMENT AND BUSINESS CONSULTING SERVICES IN THE FIELD OF TRAINING AND RECRUITMENT; MARKETING CONSULTING; PERSONNEL MANAGEMENT CONSULTATION; PROFESSIONAL BUSINESS CONSULTING; PROMOTION AND MARKETING SERVICES AND RELATED CONSULTING; PROVIDING BUSINESS MANAGEMENT INFORMATION IN CONNECTION WITH CONSULTING AND ADVISORY SERVICES IN THE FIELD OF STRATEGIC PLANNING; PROVIDING ORGANIZATIONAL DEVELOPMENT CONSULTING SERVICES (U.S. CLS. 100, 101 AND 102).

HEATHER BIDDULPH, EXAMINING ATTORNEY

CLASS 35—(Continued).

SN 77-540,903. COMMERCIAL INSURANCE SOLUTIONS GROUP, L.L.C., DALLAS, TX. FILED 8-6-2008.



OWNER OF U.S. REG. NO. 3,385,082.
THE MARK CONSISTS OF THE LETTERS "AIS" SUPERIMPOSED ON A TRIANGLE THAT IS POSITIONED UNDER AN INVERTED "V".
FOR BUSINESS RISK MANAGEMENT SERVICES PROVIDED TO OWNERS AND MANAGERS OF COMMERCIAL REAL ESTATE (U.S. CLS. 100, 101 AND 102).
FIRST USE 6-0-2003; IN COMMERCE 6-0-2003.
BRENDAN REGAN, EXAMINING ATTORNEY

SN 77-541,200. RESTAURANTS.COM INC., DORAL, FL. FILED 8-7-2008.



RESTAURANTS.COM
ALL THE RESTAURANTS OF THE WORLD

NO CLAIM IS MADE TO THE EXCLUSIVE RIGHT TO USE "RESTAURANTS.COM ALL THE RESTAURANTS OF THE WORLD", APART FROM THE MARK AS SHOWN.
THE MARK CONSISTS OF THE WORDING "RESTAURANTS.COM ALL THE RESTAURANTS OF THE WORLD" TOGETHER WITH A DESIGN ELEMENT IN THE NATURE OF THREE OVALS CONNECTED AT THE BOTTOM FANNED OUT IN A FLOWER DESIGN.
FOR BUSINESS SERVICES, NAMELY, PROVIDING A WEBSITE FEATURING AN ONLINE BUSINESS INFORMATION DIRECTORY FEATURING INFORMATION ABOUT VARIOUS RESTAURANTS (U.S. CLS. 100, 101 AND 102).
LINDA ESTRADA, EXAMINING ATTORNEY

CLASS 35—(Continued).

SN 77-542,301. HMSHOST CORPORATION, BETHESDA, MD. FILED 8-8-2008.

DAILY NEWS

THE MARK CONSISTS OF STANDARD CHARACTERS WITHOUT CLAIM TO ANY PARTICULAR FONT, STYLE, SIZE, OR COLOR.
NO CLAIM IS MADE TO THE EXCLUSIVE RIGHT TO USE "NEWS", APART FROM THE MARK AS SHOWN.
SEC. 2(F).
FOR RETAIL STORE SERVICES FEATURING MAGAZINES, PERIODICALS, BOOKS, STATIONERY, SOUVENIRS, GIFTS, CANDY, SNACKS, CLOTHING, FILM, SUNDRIES, CIGARETTES, AND REGIONAL NOVELTIES; RETAIL STORE SERVICES FEATURING A WIDE VARIETY OF CONSUMER GOODS OF OTHERS (U.S. CLS. 100, 101 AND 102).
FIRST USE 12-12-1997; IN COMMERCE 12-12-1997.
JOHN DWYER, EXAMINING ATTORNEY

SN 77-544,785. GREENBAX ENTERPRISES, INC., CHARLESTON, SC. FILED 8-12-2008.

PRICE WISE FOODS

THE MARK CONSISTS OF STANDARD CHARACTERS WITHOUT CLAIM TO ANY PARTICULAR FONT, STYLE, SIZE, OR COLOR.
NO CLAIM IS MADE TO THE EXCLUSIVE RIGHT TO USE "FOODS", APART FROM THE MARK AS SHOWN.
FOR RETAIL GROCERY STORE SERVICES (U.S. CLS. 100, 101 AND 102).
RICHARD A. STRASER, EXAMINING ATTORNEY

SN 77-545,675. CITY OF RIVERSIDE, RIVERSIDE, CA. FILED 8-13-2008.

City of Arts and Culture

THE COLOR(S) NAVY BLUE IS/ARE CLAIMED AS A FEATURE OF THE MARK.
THE MARK CONSISTS OF THE COLOR NAVY BLUE, WITH THE COLOR NAVY BLUE APPEARING IN THE WORDS "CITY OF ARTS AND CULTURE". THE MARK CONSISTS OF THE STYLIZED WORDS "CITY OF ARTS AND CULTURE".
FOR ADVERTISING AND MARKETING (U.S. CLS. 100, 101 AND 102).
FIRST USE 10-16-2007; IN COMMERCE 7-18-2008.
MARGERY A. TIERNEY, EXAMINING ATTORNEY

CLASS 35—(Continued).

SN 77-546,118. PRIMO TO GO, LLC, WINSTON-SALEM, NC. FILED 8-13-2008.

PRIMO TO GO

THE MARK CONSISTS OF STANDARD CHARACTERS WITHOUT CLAIM TO ANY PARTICULAR FONT, STYLE, SIZE, OR COLOR.

FOR DISTRIBUTORSHIP SERVICES FEATURING BOTTLED DRINKING WATER (U.S. CLS. 100, 101 AND 102).

DAWN FELDMAN, EXAMINING ATTORNEY

SN 77-546,334. THE PROPERTY TAX GROUP, LLC, PORT WASHINGTON, NY. FILED 8-13-2008.



NO CLAIM IS MADE TO THE EXCLUSIVE RIGHT TO USE "PROPERTY TAX GROUP", APART FROM THE MARK AS SHOWN.

THE COLOR(S) DARK BROWN, LIGHT BROWN, WHITE AND GREY IS/ARE CLAIMED AS A FEATURE OF THE MARK.

THE MARK CONSISTS OF THE LITERAL ELEMENT "THE PROPERTY TAX GROUP" IN DARK BROWN AGAINST A WHITE BACKGROUND AND A DESIGN ELEMENT COMPRISED OF FOUR SQUARES. THE FIRST SQUARE HAS AN IMAGE OF A LIGHT BROWN BUILDING WITH A DARK BROWN SHADOW AGAINST A LIGHT GRAY BACKGROUND. THE SECOND SQUARE HAS THE LETTER "P" IN WHITE AGAINST A GREY BACKGROUND. THE THIRD SQUARE HAS THE LETTER "G" IN WHITE AGAINST A DARK BROWN BACKGROUND. THE FOURTH SQUARE HAS THE LETTER "T" IN WHITE AGAINST A LIGHT BROWN BACKGROUND.

FOR TAX ASSESSMENT (U.S. CLS. 100, 101 AND 102). FIRST USE 8-11-2008; IN COMMERCE 8-11-2008. ANGELA GAW, EXAMINING ATTORNEY

SN 77-547,584. VAUGHAN, DONALD C., DBA PRIMA COMPLI, NOVATO, CA. AND VAUGHAN, KATHLEEN A., DBA PRIMA COMPLI, NOVATO, CA. FILED 8-14-2008.

Prima Compli

THE MARK CONSISTS OF STANDARD CHARACTERS WITHOUT CLAIM TO ANY PARTICULAR FONT, STYLE, SIZE, OR COLOR.

THE FOREIGN WORDING IN THE MARK HAS NO MEANING IN ENGLISH.

FOR COMPUTERIZED ON-LINE ORDERING FEATURING GENERAL MERCHANDISE AND GENERAL CONSUMER GOODS (U.S. CLS. 100, 101 AND 102).

ERNEST SHOSHO, EXAMINING ATTORNEY

CLASS 35—(Continued).

SN 77-547,615. OPTIMAL MODIFICATION, INC., AUSTIN, TX. FILED 8-14-2008.

Optimal Modification Inc

THE MARK CONSISTS OF STANDARD CHARACTERS WITHOUT CLAIM TO ANY PARTICULAR FONT, STYLE, SIZE, OR COLOR.

NO CLAIM IS MADE TO THE EXCLUSIVE RIGHT TO USE "INC", APART FROM THE MARK AS SHOWN.

FOR BUSINESS CONSULTATION; BUSINESS CONSULTATION SERVICES (U.S. CLS. 100, 101 AND 102).

FIRST USE 10-12-2006; IN COMMERCE 10-12-2006.

SANI KHOURI, EXAMINING ATTORNEY

SN 77-547,671. THE PLUM GROUP, INC., NEW YORK, NY. FILED 8-14-2008.

VOICERESOLVE

THE MARK CONSISTS OF STANDARD CHARACTERS WITHOUT CLAIM TO ANY PARTICULAR FONT, STYLE, SIZE, OR COLOR.

FOR CUSTOMER SERVICES, NAMELY, PROVIDING CUSTOMER SERVICE AND PRODUCT INQUIRY SERVICES THROUGH THE LIVE MONITORING OF INTERACTIVE VOICE MONITORING SYSTEMS (U.S. CLS. 100, 101 AND 102).

FIRST USE 3-1-2007; IN COMMERCE 3-1-2007.

MARK T. MULLEN, EXAMINING ATTORNEY

SN 77-548,048. THE POTOMAC BEAD COMPANY LLC, CHAMBERSBURG, PA. FILED 8-15-2008.



NO CLAIM IS MADE TO THE EXCLUSIVE RIGHT TO USE "THE POTOMAC BEAD COMPANY", APART FROM THE MARK AS SHOWN.

THE MARK CONSISTS OF A STYLIZED BEAD TO THE LEFT OF THE WORDS "THE POTOMAC BEAD COMPANY" IN STYLIZED LETTERING STACKED ABOVE EACH OTHER, WITH EACH WORD INDENTED AND THE TAG LINE "DREAM, DESIGN, CREATE..." IN SMALL STYLIZED LETTERING UNDER "COMPANY", AND SEPARATED BY A THIN LINE STRETCHING FROM RIGHT TO LEFT FROM THE "Y" IN "COMPANY".

FOR RETAIL STORES FEATURING BEADS AND JEWELRY-MAKING COMPONENTS, NAMELY, GEMSTONES, GLASS, SILVER, WIRE, TOOLS, AND FINDINGS (U.S. CLS. 100, 101 AND 102).

FIRST USE 9-1-2005; IN COMMERCE 9-1-2005.

JEFFREY LOOK, EXAMINING ATTORNEY

CLASS 35—(Continued).

SN 77-549,533. GIOCO LABORATORIES, INC., DENVER, CO. FILED 8-18-2008.

redrivet

THE MARK CONSISTS OF THE WORDING "REDRIVET" IN STYLIZED FONT WITH THE LETTER "D" IN THE WORD "RED" CONNECTED TO THE LETTER "R" IN THE WORD "RIVET" BY TWO CIRCLES OF NEGATIVE SPACE.

FOR DISSEMINATION OF CUSTOM ADVERTISING VIA MULTIPLE MEDIA CHANNELS; PREPARING AND PLACING ADVERTISING FOR OTHERS VIA E-MAIL MESSAGES, WEB PAGES, PDA PAGES AND THE INTERNET; ADVERTISING AGENCIES, NAMELY, PROMOTING THE SERVICES OF OTHERS THROUGH THE DISTRIBUTION OF PRINTED AND AUDIO PROMOTION MATERIALS AND BY RENDERING SALES AND MARKETING PROMOTION ADVICE; DIRECT MARKETING ADVERTISING FOR OTHERS; PROMOTING THE GOODS AND SERVICES OF OTHERS BY PREPARING AND PLACING ADVERTISEMENTS ACCESSED THROUGH A GLOBAL COMPUTER NETWORK AND TELECOMMUNICATION MEANS; PREPARATION AND MANAGEMENT OF CUSTOM ADVERTISEMENT AND CUSTOM PROMOTIONAL PRODUCTS FOR OTHERS (U.S. CLS. 100, 101 AND 102).

RUSS HERMAN, EXAMINING ATTORNEY

SN 77-549,817. POLIZZI, ARTHUR, HILLSBORO, MO. FILED 8-18-2008.

Baby Fitters

THE MARK CONSISTS OF STANDARD CHARACTERS WITHOUT CLAIM TO ANY PARTICULAR FONT, STYLE, SIZE, OR COLOR.

NO CLAIM IS MADE TO THE EXCLUSIVE RIGHT TO USE "BABY", APART FROM THE MARK AS SHOWN.

FOR RETAIL STORE AND ON-LINE RETAIL STORE SERVICES FEATURING BABY CLOTHING (U.S. CLS. 100, 101 AND 102).

JANICE KIM, EXAMINING ATTORNEY

SN 77-550,152. LUNCHMD, DALLAS, TX. FILED 8-19-2008.

ScheduleRep Scheduling Solutions

THE MARK CONSISTS OF STANDARD CHARACTERS WITHOUT CLAIM TO ANY PARTICULAR FONT, STYLE, SIZE, OR COLOR.

NO CLAIM IS MADE TO THE EXCLUSIVE RIGHT TO USE "SCHEDULING SOLUTIONS", APART FROM THE MARK AS SHOWN.

FOR APPOINTMENT SCHEDULING SERVICES PROVIDED VIA THE INTERNET (U.S. CLS. 100, 101 AND 102).

FIRST USE 5-1-2008; IN COMMERCE 7-1-2008.

NAAKWAMA ANKRAH, EXAMINING ATTORNEY

CLASS 35—(Continued).

SN 77-551,326. HOMESTEAD INDEPENDENCE, INC., CU-DAHY, WI. FILED 8-20-2008.

Snore No More CPAP Store

THE MARK CONSISTS OF STANDARD CHARACTERS WITHOUT CLAIM TO ANY PARTICULAR FONT, STYLE, SIZE, OR COLOR.

NO CLAIM IS MADE TO THE EXCLUSIVE RIGHT TO USE "CPAP STORE", APART FROM THE MARK AS SHOWN.

FOR RETAIL STORES FEATURING PRODUCTS AND ACCESSORIES TO DIAGNOSE AND TREAT OBSTRUCTIVE SLEEP APNEA AND OTHER SLEEP-RELATED BREATHING DISORDERS, NAMELY, HOME SLEEP STUDIES, CPAP MACHINES, VARIOUS CPAP MASKS AND CLEANING/CARE PRODUCTS, PORTABLE OXYGEN EQUIPMENT, NEBULIZERS, PULSE OXIMETERS, CPAP PILLOWS, NASAL STRIPS AND ORAL POSITIONING DEVICES (U.S. CLS. 100, 101 AND 102).

TASNEEM HUSSAIN, EXAMINING ATTORNEY

SN 77-553,768. D.L. RYAN COMPANIES, LTD., WILTON, CT. FILED 8-22-2008.

PANAVISTA

THE MARK CONSISTS OF STANDARD CHARACTERS WITHOUT CLAIM TO ANY PARTICULAR FONT, STYLE, SIZE, OR COLOR.

THE ENGLISH TRANSLATION OF THE WORD "PANAVISTA" IN THE MARK IS "WIDE VIEW".

FOR ADVERTISING, MARKETING AND PROMOTIONAL SERVICES FOR THE SPANISH-SPEAKING MARKET; BUSINESS CONSULTING SERVICES FOR THE SPANISH-SPEAKING MARKET (U.S. CLS. 100, 101 AND 102).

FIRST USE 0-0-1998; IN COMMERCE 0-0-1998.

ERIN FALK, EXAMINING ATTORNEY

SN 77-553,846. BIOMET MANUFACTURING CORP., WARSAW, IN. FILED 8-22-2008.

ONE PATIENT

THE MARK CONSISTS OF STANDARD CHARACTERS WITHOUT CLAIM TO ANY PARTICULAR FONT, STYLE, SIZE, OR COLOR.

NO CLAIM IS MADE TO THE EXCLUSIVE RIGHT TO USE "PATIENT", APART FROM THE MARK AS SHOWN.

FOR PUBLIC ADVOCACY TO PROMOTE AWARENESS OF PATIENT ACCESS TO SPECIALTY ORTHOPEDIC CARE AND RATIONAL REIMBURSEMENT POLICIES TO MEDICAL PROVIDERS AND GOVERNMENT LEGISLATORS (U.S. CLS. 100, 101 AND 102).

PATRICIA EVANKO, EXAMINING ATTORNEY

CLASS 35—(Continued).

SN 77-554,311. THE IMAGE PHARMACY, FORMERLY WATERFALL BRANDS, SEATTLE, WA. FILED 8-24-2008.

the image PHARMACY

THE MARK CONSISTS OF STANDARD CHARACTERS WITHOUT CLAIM TO ANY PARTICULAR FONT, STYLE, SIZE, OR COLOR.

FOR ADVERTISING, MARKETING AND PROMOTION SERVICES (U.S. CLS. 100, 101 AND 102).
ESTHER A. BORSUK, EXAMINING ATTORNEY

SN 77-555,352. RITTER, LORRAINE, MONROEVILLE, PA. FILED 8-25-2008.

NEIGHBORSCOPE

THE MARK CONSISTS OF STANDARD CHARACTERS WITHOUT CLAIM TO ANY PARTICULAR FONT, STYLE, SIZE, OR COLOR.

FOR PROMOTING THE SALE OF REAL ESTATE OF OTHERS THROUGH A SEARCHABLE DATABASE, ACCESSIBLE VIA A COMPUTER NETWORK, CONTAINING DEMOGRAPHIC INFORMATION ABOUT THE OCCUPANTS OF NEIGHBORING REAL ESTATE PROPERTIES (U.S. CLS. 100, 101 AND 102).
KIMBERLY FRYE, EXAMINING ATTORNEY

SN 77-555,922. HONG KONG BRIDAL MANUFACTURER, INC., BELLAIRE, TX. FILED 8-26-2008.

HAUTE BRIDAL FASHION

THE MARK CONSISTS OF STANDARD CHARACTERS WITHOUT CLAIM TO ANY PARTICULAR FONT, STYLE, SIZE, OR COLOR.

OWNER OF U.S. REG. NO. 3,425,823.
NO CLAIM IS MADE TO THE EXCLUSIVE RIGHT TO USE "BRIDAL FASHION", APART FROM THE MARK AS SHOWN.

FOR RETAIL CLOTHING STORE SERVICES; RETAIL STORE SERVICES FEATURING VEILS, SHOES, HEADPIECES, JEWELRY AND WEDDING ACCESSORIES; WHOLESALE DISTRIBUTORSHIPS FEATURING CLOTHING; WHOLESALE DISTRIBUTORSHIPS FEATURING VEILS, SHOES, HEADPIECES, JEWELRY AND WEDDING ACCESSORIES (U.S. CLS. 100, 101 AND 102).
FIRST USE 8-1-2005; IN COMMERCE 8-1-2005.
ELIZABETH HUGHITT, EXAMINING ATTORNEY

CLASS 35—(Continued).

SN 77-556,364. VALLEY FORGE PRESS, INC., NORRISTOWN, PA. FILED 8-26-2008.

EVOLUTIONS THROUGH HEALTHCARE

THE MARK CONSISTS OF STANDARD CHARACTERS WITHOUT CLAIM TO ANY PARTICULAR FONT, STYLE, SIZE, OR COLOR.

NO CLAIM IS MADE TO THE EXCLUSIVE RIGHT TO USE "HEALTHCARE", APART FROM THE MARK AS SHOWN.

FOR PROVIDING A WEBSITE FEATURING ONLINE CAREER EVENTS IN THE NATURE OF JOB FAIRS IN THE FIELD OF HEALTHCARE (U.S. CLS. 100, 101 AND 102).
JANET LEE, EXAMINING ATTORNEY

SN 77-556,651. MOONEY & AYRES LLC, NEW WILMINGTON, PA. FILED 8-27-2008.

IMS GROUP

THE MARK CONSISTS OF STANDARD CHARACTERS WITHOUT CLAIM TO ANY PARTICULAR FONT, STYLE, SIZE, OR COLOR.

NO CLAIM IS MADE TO THE EXCLUSIVE RIGHT TO USE "GROUP", APART FROM THE MARK AS SHOWN.

FOR WHOLESALE DISTRIBUTORSHIPS FEATURING COMMERCIAL AND INDUSTRIAL MINING EQUIPMENT AND SUPPLIES; WHOLESALE OUTLET STORES FEATURING COMMERCIAL AND INDUSTRIAL MINING EQUIPMENT AND SUPPLIES; PROCUREMENT FOR OTHERS OF COMMERCIAL AND INDUSTRIAL MINING EQUIPMENT AND SUPPLIES; AND PROVIDING MARKETING CONSULTING AND CONSUMER PRODUCT INFORMATION SERVICES REGARDING COMMERCIAL AND INDUSTRIAL MINING EQUIPMENT AND SUPPLIES (U.S. CLS. 100, 101 AND 102).
GRETCHEN ULRICH, EXAMINING ATTORNEY

CLASS 35—(Continued).

SN 77-556,716. HONG KONG BRIDAL MANUFACTURER, INC., BELLAIRE, TX. FILED 8-27-2008.

WINNIE COUTURE

THE MARK CONSISTS OF STANDARD CHARACTERS WITHOUT CLAIM TO ANY PARTICULAR FONT, STYLE, SIZE, OR COLOR.

OWNER OF U.S. REG. NO. 2,809,245.

NO CLAIM IS MADE TO THE EXCLUSIVE RIGHT TO USE "COUTURE", APART FROM THE MARK AS SHOWN. THE NAME "WINNIE COUTURE" IDENTIFIES A LIVING INDIVIDUAL WHOSE CONSENT IS OF RECORD.

FOR RETAIL CLOTHING STORE SERVICES; RETAIL STORE SERVICES FEATURING VEILS, SHOES, HEADPIECES, JEWELRY AND WEDDING ACCESSORIES; WHOLESALE DISTRIBUTORSHIPS FEATURING CLOTHING; WHOLESALE DISTRIBUTORSHIPS FEATURING VEILS, SHOES, HEADPIECES, JEWELRY AND OTHER WEDDING ACCESSORIES (U.S. CLS. 100, 101 AND 102).

FIRST USE 9-1-2003; IN COMMERCE 9-1-2003.

ELIZABETH HUGHITT, EXAMINING ATTORNEY

SN 77-556,742. DEAN, STEVEN, SHERMAN OAKS, CA. FILED 8-27-2008.

LAS VEGASIM

THE MARK CONSISTS OF STANDARD CHARACTERS WITHOUT CLAIM TO ANY PARTICULAR FONT, STYLE, SIZE, OR COLOR.

FOR DISSEMINATION FOR OTHERS OF ADVERTISING AND PROMOTIONAL MATTER CONCERNING GOODS AND SERVICES OVER ON-LINE ELECTRONIC GLOBAL COMMUNICATIONS NETWORKS; ONLINE RETAIL STORE SERVICES FEATURING BOOKS, MUSIC, VIDEOTAPES, AUDIOCASSETTES, COMPACT DISCS, FLOPPY DISCS AND CD-ROMS, PRINTED MATTERS, PHONOGRAPHS, RECORDED MUSIC, TOYS, HOUSEHOLD ELECTRONIC APPLIANCES, APPLIED ELECTRONIC MACHINES AND APPARATUS, PHOTOGRAPHY INSTRUMENTS, MUSICAL INSTRUMENTS AND FITTINGS THEREOF, PHOTOGRAPHS, STATIONERY, JEWELRY, HOROLOGICAL INSTRUMENTS AND PARTS THEREOF, MOTOR VEHICLES AND PARTS AND ACCESSORIES THEREOF, MANUAL AND POWER TOOLS, MEASURING INSTRUMENTS, PHYSICAL AND CHEMICAL INSTRUMENTS, CHEMICALS, SOAPS, PERFUMERY, COSMETICS, PAINTS, ADHESIVE FOR INDUSTRIAL PURPOSES, PRESERVATIVES, LEATHER, IMITATION LEATHER, BAGS AND THEIR SUBSTITUTES, UMBRELLAS, WALKING STICKS, SADDLERY, MATERIALS FOR BUILDING AND CONSTRUCTION, FURNITURE, FABRIC, INDOOR ORNAMENTS OF TEXTILE, TOBACCO NOT OF MEDICAL USE, SMOKERS ARTICLES, PLANTS, PHARMACEUTICALS, LIGHTS, IRONS AND STEELS, POTS, TABLEWARE, HEATERS, COSMETIC UTENSILS, YARNS AND THREAD FOR TEXTILE USE, KITCHEN AND HOUSEHOLD UTENSILS, GAMES AND PLAYTHINGS, ELECTRONIC PUBLICATIONS AND GREETING CARDS; ONLINE MAIL ORDER SERVICES FEATURING BOOKS, MUSIC, VIDEOTAPES, AUDIOCASSETTES, COMPACT DISCS, FLOPPY DISCS AND CD-ROMS, PRINTED MATTERS, PHONOGRAPHS, RECORDED MUSIC, TOYS, HOUSEHOLD ELECTRONIC

CLASS 35—(Continued).

APPLIANCES, APPLIED ELECTRONIC MACHINES AND APPARATUS, PHOTOGRAPHY INSTRUMENTS, MUSICAL INSTRUMENTS AND FITTINGS THEREOF, PHOTOGRAPHS, STATIONERY, JEWELRY, HOROLOGICAL INSTRUMENTS AND PARTS THEREOF, MOTOR VEHICLES AND PARTS AND ACCESSORIES THEREOF, MANUAL AND POWER TOOLS, MEASURING INSTRUMENTS, PHYSICAL AND CHEMICAL INSTRUMENTS, CHEMICALS, SOAPS, PERFUMERY, COSMETICS, PAINTS, ADHESIVE FOR INDUSTRIAL PURPOSES, PRESERVATIVES, LEATHER, IMITATION LEATHER, BAGS AND THEIR SUBSTITUTES, UMBRELLAS, WALKING STICKS, SADDLERY, MATERIALS FOR BUILDING AND CONSTRUCTION, FURNITURE, FABRIC, INDOOR ORNAMENTS OF TEXTILE, TOBACCO, NOT OF MEDICAL USE, SMOKERS ARTICLES, PLANTS, PHARMACEUTICALS, LIGHTS, IRONS AND STEELS, POTS, TABLEWARE, HEATERS, COSMETIC UTENSILS, YARNS AND THREAD FOR TEXTILE USE, KITCHEN AND HOUSEHOLD UTENSILS, GAMES AND PLAYTHINGS, ELECTRONIC PUBLICATIONS AND GREETING CARDS (U.S. CLS. 100, 101 AND 102).

SANI KHOURI, EXAMINING ATTORNEY

SN 77-556,861. NATIONAL SHOOTING SPORTS FOUNDATION, INC., NEWTOWN, CT. FILED 8-27-2008.

TASK FORCE 20/20

THE MARK CONSISTS OF STANDARD CHARACTERS WITHOUT CLAIM TO ANY PARTICULAR FONT, STYLE, SIZE, OR COLOR.

NO CLAIM IS MADE TO THE EXCLUSIVE RIGHT TO USE "TASK FORCE", APART FROM THE MARK AS SHOWN.

FOR PROMOTING THE INTERESTS OF PEOPLE INVOLVED AND CONCERNED WITH HUNTING AND SHOOTING SPORTS THROUGH CONSOLIDATED RESEARCH, STRATEGIC PLANNING, AND PROGRAM IMPLEMENTATION (U.S. CLS. 100, 101 AND 102).

FIRST USE 8-22-2008; IN COMMERCE 8-22-2008.

JEFFERY COWARD, EXAMINING ATTORNEY

SN 77-557,360. STATIC LABS LLC, DBA STATIC LABS, BROOKLYN, NY. FILED 8-27-2008.

staticlabs

THE MARK CONSISTS OF THE STYLIZED WORDING "STATICLABS".

FOR ADVERTISING SERVICES, NAMELY, PROMOTING AND MARKETING THE GOODS AND SERVICES OF OTHERS THROUGH ALL PUBLIC COMMUNICATION MEANS; BUSINESS MARKETING CONSULTING SERVICES; BUSINESS MARKETING SERVICES; DEVELOPMENT OF MARKETING STRATEGIES AND CONCEPTS; PROVIDING ADVERTISING, MARKETING AND PROMOTIONAL SERVICES, NAMELY, DEVELOPMENT OF ADVERTISING CAMPAIGNS FOR HOLLYWOOD MOVIE STUDIOS (U.S. CLS. 100, 101 AND 102).

FIRST USE 10-22-2002; IN COMMERCE 10-22-2002.

DAVID TOOLEY, EXAMINING ATTORNEY

CLASS 35—(Continued).

SN 77-557,697. DECOR & YOU, INC., SOUTHBURY, CT. FILED 8-28-2008.

FABRICLUTCH

THE MARK CONSISTS OF STANDARD CHARACTERS WITHOUT CLAIM TO ANY PARTICULAR FONT, STYLE, SIZE, OR COLOR.

FOR DISTRIBUTION OF FABRIC PRODUCT SAMPLES; DISTRIBUTION OF FABRIC SAMPLES FOR PUBLICITY PURPOSES; DISTRIBUTION OF FABRIC SAMPLES, NAMELY, SAMPLES OF FABRICS FOR DRAPERIES, CURTAINS, VALENCES, WINDOW BLINDS, BEDDING, PILLOWS, CORNICES, TABLE COVERS AND TABLE RUNNERS; CONDUCTING MARKETING PROGRAMS IN THE NATURE OF LIVE AT-HOME AND SHOWROOM PRESENTATIONS OF FABRIC SAMPLES TO AID CONSUMERS IN THEIR SELECTION OF PRODUCTS THAT ARE MADE WITH THE FABRICS; MERCHANDISING PROGRAM IN THE NATURE OF PROVIDING AND DISTRIBUTING FABRIC SAMPLES TO CONSUMERS IN ORDER TO INFORM AND EDUCATE CONSUMERS ABOUT THE FABRICS AND TO AID CONSUMERS IN THE SELECTION AND PURCHASE OF PRODUCTS MADE WITH THE FABRICS; PRODUCT MERCHANDISING (U.S. CLS. 100, 101 AND 102).

FRED CARL, EXAMINING ATTORNEY

SN 77-557,737. STRUNGLIKETHEPROS.COM, LLC, SAINT PETERSBURG, FL. FILED 8-28-2008.

STRUNGLIKETHEPROS.COM THINK YOU CAN BEAT 'EM? BE COOL. LOOK COOL. PLAY HARD.

THE MARK CONSISTS OF STANDARD CHARACTERS WITHOUT CLAIM TO ANY PARTICULAR FONT, STYLE, SIZE, OR COLOR.

FOR ON-LINE AUCTION SERVICES (U.S. CLS. 100, 101 AND 102).

MARIAM MAHMOUDI, EXAMINING ATTORNEY

SN 77-557,802. DEBBIE'S STAFFING SERVICES, INC., WINSTON-SALEM, NC. FILED 8-28-2008.

Debbie's Staffing

THE MARK CONSISTS OF STANDARD CHARACTERS WITHOUT CLAIM TO ANY PARTICULAR FONT, STYLE, SIZE, OR COLOR.

NO CLAIM IS MADE TO THE EXCLUSIVE RIGHT TO USE "STAFFING", APART FROM THE MARK AS SHOWN. FOR EMPLOYMENT HIRING, RECRUITING, PLACEMENT, CONSULTING AND STAFFING SERVICES (U.S. CLS. 100, 101 AND 102).

FIRST USE 1-15-1986; IN COMMERCE 1-15-1986.
JEFF DEFORD, EXAMINING ATTORNEY

CLASS 35—(Continued).

SN 77-557,868. DRAGON MEDIA ONLINE, INC., OAKLAND, CA. FILED 8-28-2008.

DRAGONFTO

THE MARK CONSISTS OF STANDARD CHARACTERS WITHOUT CLAIM TO ANY PARTICULAR FONT, STYLE, SIZE, OR COLOR.

OWNER OF U.S. REG. NO. 3,434,967.

FOR ADVERTISING AND BUSINESS MANAGEMENT CONSULTANCY; ADVERTISING AND COMMERCIAL INFORMATION SERVICES, VIA THE INTERNET; ADVERTISING AND MARKETING; ADVERTISING AND PROMOTION SERVICES AND RELATED CONSULTING; ADVERTISING AND PUBLICITY SERVICES; ADVERTISING BY TRANSMISSION OF ONLINE PUBLICITY FOR THIRD PARTIES THROUGH ELECTRONIC COMMUNICATIONS NETWORKS; ADVERTISING CONSULTATION; ADVERTISING PARTICULARLY SERVICES FOR THE PROMOTION OF GOODS; ADVERTISING SERVICES, NAMELY, CREATING CORPORATE AND BRAND IDENTITY FOR OTHERS; ADVERTISING VIA ELECTRONIC MEDIA AND SPECIFICALLY THE INTERNET; ADVERTISING, INCLUDING PROMOTION RELATING TO THE SALE OF ARTICLES AND SERVICES FOR THIRD PARTIES BY THE TRANSMISSION OF ADVERTISING MATERIAL AND THE DISSEMINATION OF ADVERTISING MESSAGES ON COMPUTER NETWORKS; ADVERTISING, MARKETING AND PROMOTION SERVICES; CONSULTANCY SERVICES REGARDING BUSINESS STRATEGIES; COOPERATIVE ADVERTISING AND MARKETING SERVICES BY WAY OF SOLICITATION, CUSTOMER SERVICE AND PROVIDING MARKETING INFORMATION VIA WEBSITES ON A GLOBAL COMPUTER NETWORK, CREATION OF MARKETING TOOLS DESIGNED TO INCREASE A CLIENT COMPANY'S KNOWLEDGE OF CUSTOMER NEEDS, AND ITS COMPETITORS' PRODUCTS AND SERVICES, PRICING, ADVERTISING STRATEGY AND SALES STRATEGY; DIRECT MARKETING ADVERTISING FOR OTHERS; DISSEMINATION OF ADVERTISING FOR OTHERS VIA AN ONLINE COMMUNICATIONS NETWORK ON THE INTERNET; DISSEMINATION OF ADVERTISING FOR OTHERS VIA THE INTERNET; MARKETING CONSULTING; MARKETING SERVICES, NAMELY, PROVIDING INFORMATIONAL WEB PAGES DESIGNED TO GENERATE SALES TRAFFIC VIA HYPERLINKS TO OTHER WEBSITES; PROMOTION, ADVERTISING AND MARKETING OF ONLINE WEBSITES, ALL OF THE ABOVE SERVICES EXCLUDING INCENTIVE AWARD PROGRAMS AND INCENTIVE AWARD PROGRAMS FOR RETAILERS OF GAMES AND BOOKS (U.S. CLS. 100, 101 AND 102).

FIRST USE 8-6-2008; IN COMMERCE 8-6-2008.
REBECCA POVARCHUK, EXAMINING ATTORNEY

SN 77-558,069. TRIPLE K VENTURES, INC., TEMPE, AZ. FILED 8-28-2008.



THE COLOR(S) BLUE, GREEN AND WHITE IS/ARE CLAIMED AS A FEATURE OF THE MARK.
THE MARK CONSISTS OF THE WORDS AND LETTERS

CLASS 35—(Continued).

"YOURAPPLIANCEHOME.COM" TO THE RIGHT OF THE DESIGN OF AN APPLIANCE WITH A ROOF OVER THE TOP OF THE APPLIANCE AND A CORD WRAPPED AROUND THE APPLIANCE AND THE ROOF DESIGN. THE COLOR GREEN APPEARS IN THE WORDS "YOUR" AND "HOME" AND IN THE CORD DESIGN. THE COLOR BLUE APPEARS IN THE WORD "APPLIANCE" AND THE CHARACTERS FOR ".COM" AND IN THE APPLIANCE AND ROOF DESIGN. THE COLOR WHITE APPEARS IN THE RECTANGLE AND CIRCLES IN THE APPLIANCE.

FOR ONLINE RETAIL STORE SERVICES FEATURING TELEVISIONS AND APPLIANCES (U.S. CLS. 100, 101 AND 102).

FIRST USE 6-25-2008; IN COMMERCE 6-25-2008.
ANTHONY RINKER, EXAMINING ATTORNEY

SN 77-558,378. KONTERA TECHNOLOGIES, INC., SAN FRANCISCO, CA. FILED 8-28-2008.

KONTERA

THE MARK CONSISTS OF STANDARD CHARACTERS WITHOUT CLAIM TO ANY PARTICULAR FONT, STYLE, SIZE, OR COLOR.

FOR PROMOTING THE GOODS AND SERVICES OF OTHERS, WHO ADVERTISE ON THE INTERNET, BY MODIFYING PUBLISHERS' WEB PAGES SO THAT WHEN KEY WORDS, PHRASES OR IMAGES ARE HIGHLIGHTED, ADVERTISING MATERIAL OR INFORMATION BY ADVERTISERS IS PRESENTED (U.S. CLS. 100, 101 AND 102).

FIRST USE 2-10-2003; IN COMMERCE 2-10-2003.
HAI-LY LAM, EXAMINING ATTORNEY

SN 77-558,565. LEMELSON FOUNDATION, THE, PORTLAND, OR. FILED 8-29-2008.

INVENTING GREEN

THE MARK CONSISTS OF STANDARD CHARACTERS WITHOUT CLAIM TO ANY PARTICULAR FONT, STYLE, SIZE, OR COLOR.

FOR PROMOTING THE GOODS AND SERVICES OF OTHERS BY CREATING, PUBLISHING AND DISTRIBUTING MARKETING COLLATERAL IN ELECTRONIC AND PRINT FORMATS FEATURING ENERGY-EFFICIENT TECHNOLOGIES AND PRACTICES (U.S. CLS. 100, 101 AND 102).

DAVID ELTON, EXAMINING ATTORNEY

CLASS 35—(Continued).

SN 77-558,757. THE PARADIGM GROUP, INC., REDDING, CA. FILED 8-29-2008.

DOLCE VANITA

THE MARK CONSISTS OF STANDARD CHARACTERS WITHOUT CLAIM TO ANY PARTICULAR FONT, STYLE, SIZE, OR COLOR.

THE FOREIGN WORDING IN THE MARK TRANSLATES INTO ENGLISH AS SWEET VANITY.

FOR RETAIL STORE SERVICES, INTERNET AND MAIL ORDER SERVICES FEATURING PERFUMES, PERFUMERY PRODUCTS, NAMELY, COLOGNES, TOILET WATERS, ESSENTIAL OILS FOR PERSONAL USE, NAMELY, BATH OILS, BODY OILS AND MASSAGE OILS, SOAPS AND COSMETICS, NAMELY, BATH GELS, BATH POWDERS, NON-MEDICATED BATH SALTS, BEAUTY MASKS, BODY CREAMS, BODY POWDERS, COSMETIC PENCILS, HAND CREAMS, NIGHT CREAMS, SKIN CLEANSING CREAMS, SKIN CREAMS, VANISHING CREAMS, EYE CREAMS, SKIN LOTIONS, FACIAL LOTIONS, BODY LOTIONS, SKIN MOISTURIZERS, SHOWER GELS, SKIN CLARIFIERS, SKIN SOAPS, SUN TANNING PREPARATIONS AND TOILET SOAPS, MAKE-UP PRODUCTS, NAMELY, EYE MAKEUP, EYE MAKEUP REMOVER, EYE PENCILS, EYE SHADOW, EYEBROW PENCILS, EYELINER, FACE POWDER, LIPSTICK, MAKEUP MASCARA, NAIL POLISH, NAIL POLISH REMOVER AND ROUGE, HAIR LOTIONS, HAIR SHAMPOOS, COSMETIC FACE POWDERS FOR THE SKIN AND MINERAL MAKEUP (U.S. CLS. 100, 101 AND 102).

PAULA MAHONEY, EXAMINING ATTORNEY

SN 77-558,868. DEBBIE'S STAFFING SERVICES, INC., WINSTON-SALEM, NC. FILED 8-29-2008.



NO CLAIM IS MADE TO THE EXCLUSIVE RIGHT TO USE "STAFFING", APART FROM THE MARK AS SHOWN.

THE MARK CONSISTS OF A RECTANGLE WITH WORDS "DEBBIE'S STAFFING" STACKED IN THE CENTER WITH A STYLIZED PERSON ON THE LEFT SIDE LEANING AGAINST THE RECTANGLE

FOR EMPLOYMENT HIRING, RECRUITING, PLACEMENT, CONSULTING AND STAFFING SERVICES (U.S. CLS. 100, 101 AND 102).

FIRST USE 7-1-2001; IN COMMERCE 7-1-2001.
JEFF DEFORD, EXAMINING ATTORNEY

CLASS 35—(Continued).

SN 77-558,975. PHI SOCIETY HOLDINGS, INC., CHEVY CHASE, MD. FILED 8-29-2008.

Phi Society

THE MARK CONSISTS OF STANDARD CHARACTERS WITHOUT CLAIM TO ANY PARTICULAR FONT, STYLE, SIZE, OR COLOR.

NO CLAIM IS MADE TO THE EXCLUSIVE RIGHT TO USE "SOCIETY", APART FROM THE MARK AS SHOWN.

FOR ASSOCIATION SERVICES, NAMELY, ORGANIZING CHAPTERS OF A FRATERNITY AND PROMOTING THE INTERESTS OF THE MEMBERS THEREOF (U.S. CLS. 100, 101 AND 102).

FIRST USE 10-5-2002; IN COMMERCE 10-5-2002.
CARRIE GENOVESE, EXAMINING ATTORNEY

SN 77-559,053. RODALE INC., EMMAUS, PA. FILED 8-29-2008.



OWNER OF U.S. REG. NOS. 694,267, 1,959,078 AND 2,222,899.

NO CLAIM IS MADE TO THE EXCLUSIVE RIGHT TO USE "BEAUTY AWARDS", APART FROM THE MARK AS SHOWN.

THE MARK CONSISTS OF CONCENTRIC CIRCLES WITH THE WORD "PREVENTION" WRITTEN SEVEN TIMES IN THE OUTER PORTION OF THE CIRCLE. THE WORDS "DEFY-YOUR-AGE" ARE WRITTEN ACROSS A BANNER WHICH INTERSECTS THE CIRCLE. THE INNER CIRCLE CONTAINS THE WORDS "BEAUTY AWARDS".

FOR CONDUCTING AWARD PROGRAMS TO PROMOTE THE SALE OF HEALTH AND BEAUTY PRODUCTS OF OTHERS; CONTESTS AND AWARD PROGRAMS TO PROMOTE THE SALE OF PRODUCTS AND SERVICES OF OTHERS (U.S. CLS. 100, 101 AND 102).

FIRST USE 8-28-2008; IN COMMERCE 8-28-2008.
MARIA-VICTORIA SUAREZ, EXAMINING ATTORNEY

CLASS 35—(Continued).

SN 77-559,081. PHI SOCIETY HOLDINGS, INC., CHEVY CHASE, MD. FILED 8-29-2008.

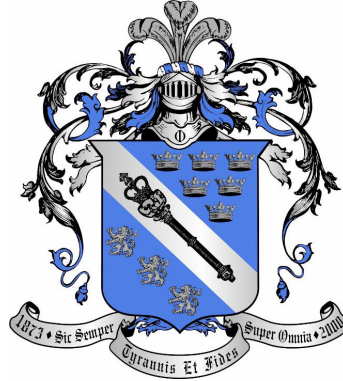

NO CLAIM IS MADE TO THE EXCLUSIVE RIGHT TO USE THE DATES "1873" AND "2000", APART FROM THE MARK AS SHOWN.

THE COLOR(S) BLACK, BLUE, AND SILVER IS/ARE CLAIMED AS A FEATURE OF THE MARK.

THE MARK CONSISTS OF THE ARMS, OR CENTER SHIELD IN WHICH A SILVER MACE RUNS DIAGONAL ON A FIELD OF BLUE. BELOW THE MACE ARE THREE LIONS IN SILVER ON A FIELD OF BLUE. ABOVE THE MACE ARE SIX CROWNS IN BLACK AND SILVER ON A FIELD OF BLUE. ABOVE THE ARMS IS THE SILVER "HELM" WHICH CONSISTS OF THE HELMET OF A KNIGHT, FACING FORWARD. THE FACEPLATE OF WHICH CONTAINS SIX COLUMNS IN BLACK. ON THE BREASTPLATE IS THE GREEK LETTER, PH, OR "PHI" IN ENGLISH. ABOVE THE HELM IS THE "CREST" WHICH CONSISTS OF THREE OSTRICH PLUMES IN SILVER, WITH PLANT BRANCHES EXTENDING FROM THEM IN THE COLORS BLACK, SILVER AND BLUE. BELOW THE ARMS IS A SILVER SCROLL OUTLINED IN BLACK CONTAINING THE YEARS "1873" AND "2000" AND THE LATIN MOTTO "SIC SEMPER TYRANNIS ET FIDES SUPER OMNIA" APPEARING IN BLACK.

THE ENGLISH TRANSLATION OF THE LATIN PHRASE "SIC SEMPER TYRANNIS ET FIDES SUPER OMNIA" IS "THUS ALWAYS TO TYRANTS AND LOYALTY ABOVE ALL".

FOR ASSOCIATION SERVICES, NAMELY, ORGANIZING CHAPTERS OF A FRATERNITY AND PROMOTING THE INTERESTS OF THE MEMBERS THEREOF (U.S. CLS. 100, 101 AND 102).

FIRST USE 0-0-2003; IN COMMERCE 0-0-2003.
CARRIE GENOVESE, EXAMINING ATTORNEY

SN 77-559,613. GUNELIUS, SUSAN M., CLERMONT, FL. FILED 8-31-2008.

KeySplash Creative

THE MARK CONSISTS OF STANDARD CHARACTERS WITHOUT CLAIM TO ANY PARTICULAR FONT, STYLE, SIZE, OR COLOR.

FOR ADVERTISING, MARKETING AND PROMOTION SERVICES (U.S. CLS. 100, 101 AND 102).

SKYE YOUNG, EXAMINING ATTORNEY

CLASS 35—(Continued).

SN 77-559,824. PACE ELECTRONICS INC., ROCHESTER, MN. FILED 9-1-2008.

Master Vendor Procurement MVP

THE MARK CONSISTS OF STANDARD CHARACTERS WITHOUT CLAIM TO ANY PARTICULAR FONT, STYLE, SIZE, OR COLOR.

NO CLAIM IS MADE TO THE EXCLUSIVE RIGHT TO USE "MASTER VENDOR PROCUREMENT", APART FROM THE MARK AS SHOWN.

FOR BUSINESS SERVICES, NAMELY, PROCURING QUALIFIED AND CREDENTIALLED THIRD-PARTY EXPERTS, PROFESSIONALS AND OTHER QUALIFIED PERSONNEL, AND DOCUMENTATION AND INFORMATION ALL ON BEHALF OF OTHERS; PROCUREMENT, NAMELY, PURCHASING TOOLS AND ELECTRONIC GOODS FOR OTHERS (U.S. CLS. 100, 101 AND 102).

H. M. FISHER, EXAMINING ATTORNEY

CLASS 35—(Continued).

SN 77-559,935. JILL C. AHNER, DBA CUTTING EDGE TRANSCRIPTION SERVICE, STUDIO CITY, CA. FILED 9-2-2008.

Cutting Edge Transcription Service

THE MARK CONSISTS OF STANDARD CHARACTERS WITHOUT CLAIM TO ANY PARTICULAR FONT, STYLE, SIZE, OR COLOR.

NO CLAIM IS MADE TO THE EXCLUSIVE RIGHT TO USE "TRANSCRIPTION SERVICE", APART FROM THE MARK AS SHOWN.

FOR TRANSCRIPTION OF MEDICAL REPORTS (U.S. CLS. 100, 101 AND 102).

FIRST USE 4-30-2007; IN COMMERCE 4-30-2007.

ANDREA K. NADELMAN, EXAMINING ATTORNEY

SN 77-560,029. RLF COMMUNICATIONS, LLC, HIGH POINT, NC. FILED 9-2-2008.

RLF Communications

THE MARK CONSISTS OF STANDARD CHARACTERS WITHOUT CLAIM TO ANY PARTICULAR FONT, STYLE, SIZE, OR COLOR.

NO CLAIM IS MADE TO THE EXCLUSIVE RIGHT TO USE "COMMUNICATIONS", APART FROM THE MARK AS SHOWN.

FOR ADVERTISING AGENCIES, NAMELY, PROMOTING THE GOODS AND SERVICES OF OTHERS; ADVERTISING AND ADVERTISEMENT SERVICES; ADVERTISING AND PUBLICITY SERVICES, NAMELY, PROMOTING THE GOODS, SERVICES, BRAND IDENTITY AND COMMERCIAL INFORMATION AND NEWS OF THIRD PARTIES THROUGH PRINT, AUDIO, VIDEO, DIGITAL AND ON-LINE MEDIUM; ADVERTISING SERVICES; ADVERTISING SERVICES, PUBLIC RELATIONS AND MARKETING SERVICES, NAMELY, PROMOTING AND MARKETING THE GOODS AND SERVICES OF OTHERS THROUGH ALL PUBLIC COMMUNICATION MEANS; ADVERTISING THROUGH ALL PUBLIC COMMUNICATION MEANS; BRAND CONCEPT AND BRAND DEVELOPMENT SERVICES FOR CORPORATE CLIENTS; BUSINESS MARKETING CONSULTING SERVICES; BUSINESS MONITORING SERVICES, NAMELY, TRACKING WEB SITES OF OTHERS TO PROVIDE DETAILS ABOUT USER CLICK TRAFFIC OR VISITS TO THE WEB SITE; DESIGN OF ADVERTISING MATERIALS FOR OTHERS; DEVELOPMENT OF MARKETING STRATEGIES AND CONCEPTS; DIRECT MAIL ADVERTISING; DIRECT MARKETING ADVERTISING FOR OTHERS; DIRECT MARKETING CONSULTING SERVICES; DIRECT MARKETING SERVICES; MEDIA BUYING ADVICE, NAMELY, ADVISING THE CLIENT HOW MUCH MEDIA TIME, AND AT WHAT TIMES THE CLIENT SHOULD BE PURCHASING ADVERTISING; PROVIDING MARKETING AND PROMOTION OF SPECIAL EVENTS; PUBLIC RELATIONS (U.S. CLS. 100, 101 AND 102).

FIRST USE 3-1-2007; IN COMMERCE 4-1-2007.

TARA PATE, EXAMINING ATTORNEY

SN 77-559,830. WOMEN'S ALLIANCE NETWORK, INC., CARDIFF, CA. FILED 9-1-2008.



NO CLAIM IS MADE TO THE EXCLUSIVE RIGHT TO USE "WOMENS ALLIANCE NETWORK", APART FROM THE MARK AS SHOWN.

THE MARK CONSISTS OF THE ACRONYM "WAN", WITHIN THE MIDDLE OF THREE RECTANGLES, THE TOP AND BOTTOM RECTANGLES BEING SHADED, AND THE TOP RECTANGLE CONTAINING THE DESIGN OF THREE LEAVES ON STEMS FEATURING PORTIONS OF LEAVES, ALL OVER THE WORDS, "WOMENS ALLIANCE NETWORK".

FOR ON-LINE SOCIAL NETWORKING SERVICES; PROVIDING CONSULTATION AND INFORMATION IN THE FIELD OF WOMEN'S EMPOWERMENT, SPECIFICALLY SELF-IMPROVEMENT TECHNIQUES AND INFORMATION ON HOW TO SUCCEED PERSONALLY AND PROFESSIONALLY (U.S. CLS. 100, 101 AND 102).

BARBARA A. GOLD, EXAMINING ATTORNEY

CLASS 35—(Continued).

SN 77-560,175. CHECKERS DRIVE-IN RESTAURANTS, INC., TAMPA, FL. FILED 9-2-2008.

FLAVORHOOD

THE MARK CONSISTS OF STANDARD CHARACTERS WITHOUT CLAIM TO ANY PARTICULAR FONT, STYLE, SIZE, OR COLOR.

FOR ARRANGING, CONDUCTING, AND PROMOTING A CUSTOMER LOYALTY PROGRAM (U.S. CLS. 100, 101 AND 102).

EDWARD NELSON, EXAMINING ATTORNEY

SN 77-560,285. CERTIF-A-GIFT COMPANY, ARLINGTON HEIGHTS, IL. FILED 9-2-2008.

PICK-A-GIFT

THE MARK CONSISTS OF STANDARD CHARACTERS WITHOUT CLAIM TO ANY PARTICULAR FONT, STYLE, SIZE, OR COLOR.

FOR MAIL ORDER SERVICES FEATURING HOUSEHOLD GOODS (U.S. CLS. 100, 101 AND 102).

FIRST USE 9-0-1964; IN COMMERCE 9-0-1964.

KATHERINE STOIDES, EXAMINING ATTORNEY

SN 77-560,486. MR. HANDYMAN INTERNATIONAL, LLC, ANN ARBOR, MI. FILED 9-2-2008.

MrHandyman.com

THE MARK CONSISTS OF STANDARD CHARACTERS WITHOUT CLAIM TO ANY PARTICULAR FONT, STYLE, SIZE, OR COLOR.

OWNER OF U.S. REG. NOS. 2,600,952, 2,834,696 AND OTHERS.

FOR FRANCHISE SERVICES, NAMELY, OFFERING ASSISTANCE IN THE ESTABLISHMENT AND OPERATION OF A HOME REPAIR AND GENERAL MAINTENANCE BUSINESS; FRANCHISE CONSULTANCY SERVICES; BUSINESS ADVICE RELATING TO FRANCHISING; ADVERTISING; BUSINESS MANAGEMENT; BUSINESS ADMINISTRATION (U.S. CLS. 100, 101 AND 102).

DAVID TOOLEY, EXAMINING ATTORNEY

CLASS 35—(Continued).

SN 77-561,111. BANDED NETWORKS, INC., NEW YORK, NY. FILED 9-3-2008.



NO CLAIM IS MADE TO THE EXCLUSIVE RIGHT TO USE ".COM", APART FROM THE MARK AS SHOWN.

THE MARK CONSISTS OF THE WORD "THE" OVER THE WORD "BANDED" WITH THE WORDS "THE BANDED .COM" ACROSS THE BOTTOM; A WIDE LINE FORMING A HALF CIRCLE ORIGINATES BEHIND THE FIRST LETTER "D" IN "BANDED" AND CONTINUES UNTIL IT FADES JUST PAST THE LETTER "B" IN "BANDED" ON THE LEFT SIDE; A SOLID HALF CIRCLE APPEARS BEHIND THE LETTERS "THE BAN" TOWARDS THE MIDDLE OF THE MARK AND FADES ABOVE THE LETTER "B" IN "BANDED"; INSIDE THE LETTER "B" IN "BANDED" ARE TWO SMALL CONCENTRIC CIRCLES.

FOR CONTESTS AND INCENTIVE AWARD PROGRAMS TO PROMOTE THE SALE OF PRODUCTS AND SERVICES OF OTHERS (U.S. CLS. 100, 101 AND 102).

MICHAEL LITZAU, EXAMINING ATTORNEY

SN 77-561,233. AUTO SUPPLY COMPANY, INC., WINSTON-SALEM, NC. FILED 9-3-2008.

**Auto Supply Company, Inc.
The Home of Great Service**

THE MARK CONSISTS OF STANDARD CHARACTERS WITHOUT CLAIM TO ANY PARTICULAR FONT, STYLE, SIZE, OR COLOR.

NO CLAIM IS MADE TO THE EXCLUSIVE RIGHT TO USE "AUTO SUPPLY COMPANY, INC.", APART FROM THE MARK AS SHOWN.

FOR WHOLESALE DISTRIBUTORSHIP SERVICES IN THE FIELD OF AUTOMOTIVE PARTS AND ACCESSORIES (U.S. CLS. 100, 101 AND 102).

FIRST USE 1-15-1987; IN COMMERCE 1-15-1987.

LAURIE MAYES, EXAMINING ATTORNEY

CLASS 35—(Continued).

SN 77-561,236. AUTO SUPPLY COMPANY, INC., WINSTON-SALEM, NC. FILED 9-3-2008.

One Call No Matter What Hood You're Under

THE MARK CONSISTS OF STANDARD CHARACTERS WITHOUT CLAIM TO ANY PARTICULAR FONT, STYLE, SIZE, OR COLOR.

FOR WHOLESALE DISTRIBUTORSHIP SERVICES IN THE FIELD OF AUTOMOTIVE PARTS AND ACCESSORIES (U.S. CLS. 100, 101 AND 102).

FIRST USE 3-15-2008; IN COMMERCE 3-15-2008.
LAURIE MAYES, EXAMINING ATTORNEY

SN 77-561,907. U-SWIRL INTERNATIONAL, INC., HENDERSON, NV. FILED 9-4-2008.



NO CLAIM IS MADE TO THE EXCLUSIVE RIGHT TO USE "FROZEN YOGURT", APART FROM THE MARK AS SHOWN.

THE COLOR(S) GREEN, WHITE, BLUE IS/ARE CLAIMED AS A FEATURE OF THE MARK.

THE MARK CONSISTS OF A LOWER CASE BLUE LETTER "U" WITH A STYLIZED GREEN SWIRL FIGURE. THE LETTER "U" IS THEN FOLLOWED BY A BLUE DASH FOLLOWED BY THE WORD "SWIRL", ALL IN LOWER CASE. ALL OF THE PROCEEDING IS DIRECTLY ABOVE THE WORD "FROZEN YOGURT" WHICH IS DEPICTED IN ALL CAPITAL WHITE LETTERS AGAINST A DARK GREEN OVAL BACKGROUND.

FOR RETAIL STORE SERVICES FEATURING THE SALE OF FROZEN YOGURT (U.S. CLS. 100, 101 AND 102).

FIRST USE 4-19-2008; IN COMMERCE 4-19-2008.
DEZMONA MIZELLE, EXAMINING ATTORNEY

CLASS 35—(Continued).

SN 77-561,967. DIRK ELLER, SAN ANTONIO, TX. FILED 9-4-2008.

BETTER THAN LIVE

THE MARK CONSISTS OF STANDARD CHARACTERS WITHOUT CLAIM TO ANY PARTICULAR FONT, STYLE, SIZE, OR COLOR.

FOR DISTRIBUTORSHIP SERVICES IN THE FIELD OF CONSUMER AND COMMERCIAL ELECTRONICS, COMPUTER SYSTEMS, COMPUTER HARDWARE, AND COMPUTER SOFTWARE; DISTRIBUTORSHIP SERVICES IN THE FIELD OF MUSIC, SOUND RECORDINGS, AUDIO-VISUAL PROGRAMS, TELEVISION PROGRAMS, MOVIES, AND RADIO PROGRAMS; RETAIL STORE SERVICES FEATURING CONSUMER AND COMMERCIAL ELECTRONICS, COMPUTER SYSTEMS, COMPUTER HARDWARE, AND COMPUTER SOFTWARE; RETAIL STORE SERVICES FEATURING MUSIC, SOUND RECORDINGS, AUDIO-VISUAL PROGRAMS, TELEVISION PROGRAMS, MOVIES, AND RADIO PROGRAMS; ONLINE RETAIL STORE SERVICES FEATURING CONSUMER AND COMMERCIAL ELECTRONICS, COMPUTER SYSTEMS, COMPUTER HARDWARE, AND COMPUTER SOFTWARE; ONLINE RETAIL STORE SERVICES FEATURING MUSIC, SOUND RECORDINGS, AUDIO-VISUAL PROGRAMS, TELEVISION PROGRAMS, MOVIES, AND RADIO PROGRAMS (U.S. CLS. 100, 101 AND 102).

LOURDES AYALA, EXAMINING ATTORNEY

SN 77-562,032. OOHPOP.COM, INC., RIVER FOREST, IL. FILED 9-4-2008.

OOHPOP

THE MARK CONSISTS OF STANDARD CHARACTERS WITHOUT CLAIM TO ANY PARTICULAR FONT, STYLE, SIZE, OR COLOR.

FOR ADVERTISING SERVICES, NAMELY, TRACKING AND CONFIRMING PLACEMENT OF "OUT OF HOME MEDIA" ADVERTISEMENTS SUCH AS BILLBOARD ADVERTISEMENTS (U.S. CLS. 100, 101 AND 102).

FIRST USE 3-5-2007; IN COMMERCE 3-5-2007.
SOPHIA S. KIM, EXAMINING ATTORNEY

CLASS 35—(Continued).

SN 77-562,195. RUEHRDANZ, PATRICK, GLENVIEW, IL. FILED 9-4-2008.

NORTHSIDER IRISH

THE MARK CONSISTS OF STANDARD CHARACTERS WITHOUT CLAIM TO ANY PARTICULAR FONT, STYLE, SIZE, OR COLOR.

FOR SPORTS MARKETING SERVICES (U.S. CLS. 100, 101 AND 102).

DAVID MILLER, EXAMINING ATTORNEY

CLASS 35—(Continued).

SN 77-562,835. XTREME CONVENIENCE STORE LLC, LAKE FOREST, CA. FILED 9-4-2008.

XTREME RACING FUEL

THE MARK CONSISTS OF STANDARD CHARACTERS WITHOUT CLAIM TO ANY PARTICULAR FONT, STYLE, SIZE, OR COLOR.

NO CLAIM IS MADE TO THE EXCLUSIVE RIGHT TO USE "RACING FUEL", APART FROM THE MARK AS SHOWN.

FOR RETAIL STORE SERVICES FEATURING CONVENIENCE STORE ITEMS AND GASOLINE (U.S. CLS. 100, 101 AND 102).

RONALD AIKENS, EXAMINING ATTORNEY

SN 77-562,862. SIP ACADEMY USA, LLC, SALT LAKE CITY, UT. FILED 9-4-2008.

SIP ACADEMY

THE MARK CONSISTS OF STANDARD CHARACTERS WITHOUT CLAIM TO ANY PARTICULAR FONT, STYLE, SIZE, OR COLOR.

NO CLAIM IS MADE TO THE EXCLUSIVE RIGHT TO USE "ACADEMY", APART FROM THE MARK AS SHOWN.

FOR FRANCHISE SERVICES, NAMELY, OFFERING BUSINESS MANAGEMENT ASSISTANCE IN THE ESTABLISHMENT AND OPERATION OF A BUSINESS THAT PROVIDES INSTRUCTION FOR CHILDREN AT THE PRIMARY LEVEL IN THE SUBJECTS OF MATH, ART, LINGUISTICS AND PHONETICS, ABACUS SKILLS AND THE FIVE SENSES (U.S. CLS. 100, 101 AND 102).

DAVID TOOLEY, EXAMINING ATTORNEY

SN 77-562,863. XTREME CONVENIENCE STORE LLC, LAKE FOREST, CA. FILED 9-4-2008.

XTREME CONVENIENCE

THE MARK CONSISTS OF STANDARD CHARACTERS WITHOUT CLAIM TO ANY PARTICULAR FONT, STYLE, SIZE, OR COLOR.

NO CLAIM IS MADE TO THE EXCLUSIVE RIGHT TO USE "CONVENIENCE", APART FROM THE MARK AS SHOWN.

FOR RETAIL STORE SERVICES FEATURING CONVENIENCE STORE ITEMS AND GASOLINE (U.S. CLS. 100, 101 AND 102).

RONALD AIKENS, EXAMINING ATTORNEY

SN 77-562,501. ABLE GLASS AND MIRROR CO., INC., DBA ABLE AMMO, HUNTSVILLE, TX. FILED 9-4-2008.

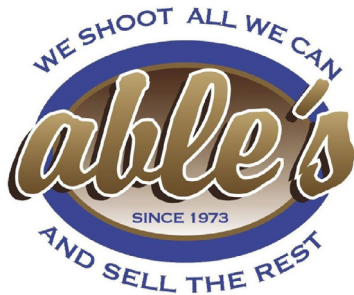

NO CLAIM IS MADE TO THE EXCLUSIVE RIGHT TO USE "SINCE 1973", APART FROM THE MARK AS SHOWN.

THE COLOR(S) TAN, BROWN, BLUE AND WHITE IS/ARE CLAIMED AS A FEATURE OF THE MARK.

THE MARK CONSISTS OF THE WORD "ABLE'S" IN TAN, OUTLINED IN WHITE ACROSS AN OVAL WITH A BROWN AND TAN BACKGROUND AND THE WORDS "SINCE 1973" BELOW THE WORD "ABLE'S" IN BLUE. THE OVAL IS OUTLINED IN BLUE. THE WORDS "WE SHOOT ALL WE CAN" BEING ABOVE THE TOP OF THE OVAL IN BLUE AND THE WORDS "AND SELL THE REST" IN BLUE BELOW THE OVAL.

FOR ONLINE RETAIL STORE SERVICE IN THE FIELD OF HUNTING AND SHOOTING SUPPLIES (U.S. CLS. 100, 101 AND 102).

FIRST USE 12-31-1975; IN COMMERCE 12-31-1975.
TRACY FLETCHER, EXAMINING ATTORNEY

CLASS 35—(Continued).

SN 77-562,947. PONTBRIAND, ERIC C., WATERTOWN, CT. FILED 9-5-2008.

VOLOPTO

THE MARK CONSISTS OF STANDARD CHARACTERS WITHOUT CLAIM TO ANY PARTICULAR FONT, STYLE, SIZE, OR COLOR.

FOR BUSINESS ADVICE AND INFORMATION; BUSINESS DEVELOPMENT SERVICES, NAMELY, PROVIDING START-UP SUPPORT FOR BUSINESSES OF OTHERS; BUSINESS NETWORKING; ON-LINE BUSINESS NETWORKING SERVICES; PROVIDING INFORMATION ABOUT COMMERCIAL BUSINESS AND COMMERCIAL INFORMATION VIA THE GLOBAL COMPUTER NETWORK (U.S. CLS. 100, 101 AND 102).

SHAUNIA CARLYLE, EXAMINING ATTORNEY

SN 77-562,954. FIZZBERG EQUITY PARTNERS LLC, BROOKLYN, NY. FILED 9-5-2008.

FIZZBURG

THE MARK CONSISTS OF STANDARD CHARACTERS WITHOUT CLAIM TO ANY PARTICULAR FONT, STYLE, SIZE, OR COLOR.

FOR ADVERTISING AGENCY SPECIALIZING IN THE DESIGN AND EXECUTION OF WORD OF MOUTH, VIRAL, BUZZ AND EXPERIENTIAL MARKETING PROGRAMS; ADVERTISING, MARKETING AND PROMOTION SERVICES; BUSINESS MARKETING SERVICES; DEVELOPMENT OF MARKETING STRATEGIES AND CONCEPTS; MARKETING CONSULTING; PREPARATION AND REALIZATION OF MEDIA AND ADVERTISING PLANS AND CONCEPTS; PROMOTION AND MARKETING SERVICES AND RELATED CONSULTING; PROMOTIONAL SERVICES, NAMELY, GUERRILLA MARKETING SERVICES; SOCIAL MEDIA STRATEGY AND MARKETING CONSULTANCY FOCUSING ON HELPING CLIENTS CREATE AND EXTEND THEIR PRODUCT AND BRAND STRATEGIES BY BUILDING VIRALLY ENGAGING MARKETING SOLUTIONS (U.S. CLS. 100, 101 AND 102).

FIRST USE 0-0-2006; IN COMMERCE 0-0-2006.
SHAUNIA CARLYLE, EXAMINING ATTORNEY

CLASS 35—(Continued).

SN 77-563,002. ON THE BUTTON, LLC, EASTON, CT. FILED 9-5-2008.

ON THE BUTTON

THE MARK CONSISTS OF STANDARD CHARACTERS WITHOUT CLAIM TO ANY PARTICULAR FONT, STYLE, SIZE, OR COLOR.

FOR ON-LINE RETAIL STORE SERVICES FEATURING GIFT SHOP GOODS AND SPORTING GOODS RELATED TO THE SPORT OF CURLING (U.S. CLS. 100, 101 AND 102).

DANNEAN HETZEL, EXAMINING ATTORNEY

SN 77-563,121. ENLOE, ROBIN, HAMPTON, VA. FILED 9-5-2008.

"WAG"ITTARIUS

THE MARK CONSISTS OF STANDARD CHARACTERS WITHOUT CLAIM TO ANY PARTICULAR FONT, STYLE, SIZE, OR COLOR.

FOR PRODUCT MERCHANDISING (U.S. CLS. 100, 101 AND 102).

KATINA MISTER, EXAMINING ATTORNEY

SN 77-563,129. ENLOE, ROBIN, HAMPTON, VA. FILED 9-5-2008.

CAP"PAW"CORN

THE MARK CONSISTS OF STANDARD CHARACTERS WITHOUT CLAIM TO ANY PARTICULAR FONT, STYLE, SIZE, OR COLOR.

FOR PRODUCT MERCHANDISING (U.S. CLS. 100, 101 AND 102).

KATINA MISTER, EXAMINING ATTORNEY

CLASS 35—(Continued).

SN 77-563,138. ENLOE, ROBIN, HAMPTON, VA. FILED 9-5-2008.

HOUNDSCOPE

THE MARK CONSISTS OF STANDARD CHARACTERS WITHOUT CLAIM TO ANY PARTICULAR FONT, STYLE, SIZE, OR COLOR.

FOR PRODUCT MERCHANDISING (U.S. CLS. 100, 101 AND 102).

KATINA MISTER, EXAMINING ATTORNEY

SN 77-563,152. MECCA, FRANK, MIDDLEBURY, CT. FILED 9-5-2008.

ON YOUR BIRTHDAY WHO
DESERVES FLOWERS MORE THAN
YOUR MOTHER

THE MARK CONSISTS OF STANDARD CHARACTERS WITHOUT CLAIM TO ANY PARTICULAR FONT, STYLE, SIZE, OR COLOR.

FOR RETAIL FLORIST SHOPS; ONLINE, MAIL ORDER, AND TELEPHONE ORDER FLORIST SHOPS; DISTRIBUTORSHIPS IN THE FIELD OF FLOWERS AND FLORAL ARRANGEMENTS (U.S. CLS. 100, 101 AND 102).

JEFF DEFORD, EXAMINING ATTORNEY

SN 77-563,180. SCHARLAT, MICHAEL, MILFORD, CT. FILED 9-5-2008.

"RITA'S, FAJITAS AND ROCK
N' ROLL"

THE MARK CONSISTS OF STANDARD CHARACTERS WITHOUT CLAIM TO ANY PARTICULAR FONT, STYLE, SIZE, OR COLOR.

FOR RESTAURANT AND BAR SERVICES (U.S. CLS. 100, 101 AND 102).

FIRST USE 5-5-2008; IN COMMERCE 5-5-2008.

DOUGLAS LEE, EXAMINING ATTORNEY

CLASS 35—(Continued).

SN 77-563,184. SMOKE INN, LLC, WEST PALM BEACH, FL. FILED 9-5-2008.



NO CLAIM IS MADE TO THE EXCLUSIVE RIGHT TO USE "SMOKE", APART FROM THE MARK AS SHOWN.

THE MARK CONSISTS OF THE IMAGE OF A SMOKING CIGAR WITH THE WORDS "SMOKE INN" APPEARING THEREIN, WITH THE "O" OF THE WORD "SMOKE" FASHIONED TO APPEAR AS A CIGAR BAND AROUND THE SMOKING CIGAR.

FOR RETAIL STORE SERVICES FEATURING CIGARS, CIGARETTES, TOBACCO, AND RELATED SMOKING ACCESSORIES (U.S. CLS. 100, 101 AND 102).

FIRST USE 9-1-1996; IN COMMERCE 9-1-1996.

LINDA LAVACHE, EXAMINING ATTORNEY

SN 77-563,185. BOESCH, KRISTIN, FORT COLLINS, CO. FILED 9-5-2008.

choose people

THE MARK CONSISTS OF STANDARD CHARACTERS WITHOUT CLAIM TO ANY PARTICULAR FONT, STYLE, SIZE, OR COLOR.

FOR MANAGEMENT AND BUSINESS CONSULTING SERVICES IN THE FIELD OF HUMAN RESOURCES (U.S. CLS. 100, 101 AND 102).

JAY BESCH, EXAMINING ATTORNEY

CLASS 35—(Continued).

SN 77-563,263. SANCHEZ CECARELLI NETWORKS LLC, ORLANDO, FL. FILED 9-5-2008.

WORLDTOPUS

THE MARK CONSISTS OF STANDARD CHARACTERS WITHOUT CLAIM TO ANY PARTICULAR FONT, STYLE, SIZE, OR COLOR.

FOR PROVIDING AN ONLINE COMMERCIAL INFORMATION DIRECTORY AND MARKETPLACE FOR BUYERS AND SELLERS OF GOODS AND SERVICES VIA THE INTERNET; FACILITATING THE EXCHANGE OF NEEDED INFORMATION FOR FINANCIAL COMPENSATION VIA THE INTERNET; ADVERTISING SERVICES, NAMELY, PROMOTING THE GOODS AND SERVICES OF OTHERS BY PREPARING AND PLACING ADVERTISEMENTS IN DIRECTORY LISTING DATABASES ACCESSED THROUGH A GLOBAL INFORMATION NETWORK; ADVERTISING AND PUBLICITY SERVICES, NAMELY, PROMOTING THE GOODS, SERVICES, BRAND IDENTITY, COMMERCIAL INFORMATION AND NEWS OF THIRD PARTIES THROUGH PRINT, AUDIO, VIDEO, DIGITAL AND ONLINE MEDIA; ADVERTISING AND BUSINESS SERVICES, NAMELY, SECURING AIRTIME ON ALL FORMS OF MEDIA COMMUNICATIONS STATIONS, SYSTEMS, NETWORKS, AND SERVICES FOR THE PURPOSE OF PROMOTING THE GOODS AND SERVICES OF OTHERS; ADVERTISING THROUGH ALL PUBLIC COMMUNICATION MEANS; DIRECT MARKETING ADVERTISING FOR OTHERS; BUSINESS ORGANIZATION AND MANAGEMENT CONSULTING; CREATION OF MARKETING TOOLS DESIGNED TO INCREASE A CLIENT COMPANY'S KNOWLEDGE OF CUSTOMER NEEDS, AND ITS COMPETITORS' PRODUCTS AND SERVICES, PRICING, ADVERTISING STRATEGY AND SALES STRATEGY; ONLINE BUSINESS NETWORKING SERVICES; CUSTOMER LOYALTY SERVICES AND CUSTOMER CLUB SERVICES, FOR COMMERCIAL, PROMOTIONAL AND/OR ADVERTISING PURPOSES; PROVIDING A WEBSITE WHERE USER CAN POST REAL TIME RATINGS, REVIEWS AND RECOMMENDATIONS PERTAINING TO PRODUCTS AND SERVICES OF BUSINESSES AND BUSINESS ORGANIZATIONS (U.S. CLS. 100, 101 AND 102).

KATHLEEN M. VANSTON, EXAMINING ATTORNEY

CLASS 35—(Continued).

SN 77-563,386. EAST COAST BODYBOARDING, LLC, NEW YORK, NY. FILED 9-5-2008.

ECBB

THE MARK CONSISTS OF STANDARD CHARACTERS WITHOUT CLAIM TO ANY PARTICULAR FONT, STYLE, SIZE, OR COLOR.

FOR PROMOTING THE GOODS AND SERVICES OF OTHERS BY PROVIDING A WEB SITE FEATURING USER-SUBMITTED CONTENT IN THE NATURE OF PRODUCT REVIEWS, PRICE-COMPARISON INFORMATION, LINKS TO THE WEB SITES OF OTHERS, AND DISCOUNT INFORMATION; PROVIDING MARKETING AND PROMOTION OF SPECIAL EVENTS; ON-LINE RETAIL STORE SERVICES FEATURING BODY BOARDS, RIVER BOARDS, FINS, BODY BOARD LEASHES AND BICEP LEASHED, WETSUITS, CLOTHING, POSTERS, PRINTS, DVDS, MAGAZINES, SUNSCREEN, FIN SOCKS, FIN ANKLE PADS, FIN PADS, FIN TETHERS, WAX, BODY BOARD PLUGS, BOARD SOCK, SOCKS, FIN SAVER CINCHES AND FIN SAVER STRINGS AND WET SUIT REPAIR SEALANT (U.S. CLS. 100, 101 AND 102).

FIRST USE 7-0-2000; IN COMMERCE 11-28-2000.

HENRY S. ZAK, EXAMINING ATTORNEY

SN 77-563,493. SENSIBILL MEDICAL BILLING MANAGEMENT, FORT WORTH, TX. FILED 9-5-2008.



THE COLOR(S) TEAL AND BROWN IS/ARE CLAIMED AS A FEATURE OF THE MARK.

THE MARK CONSISTS OF THE WORD SENSIBILL AND A PINWHEEL DESIGN FOR THE FIRST "I" IN THE DESIGN WHICH CONTAINS TWO COLORS: COLOR TEAL IS USED ON THE LETTERS "SENSI" AND THE PINWHEEL DESIGN, THE COLOR BROWN IS USED ON THE LETTERS "BILL". FOR MEDICAL BILLING SUPPORT SERVICES (U.S. CLS. 100, 101 AND 102).

FIRST USE 4-1-2007; IN COMMERCE 4-1-2007.

AMOS T. MATTHEWS, JR., EXAMINING ATTORNEY

CLASS 35—(Continued).

SN 77-563,516. SHOP2EARN NET, DBA SHOPTO EARN, LAS VEGAS, NV. FILED 9-5-2008.

SHOPTO EARTH

THE MARK CONSISTS OF STANDARD CHARACTERS WITHOUT CLAIM TO ANY PARTICULAR FONT, STYLE, SIZE, OR COLOR.

FOR PROMOTING THE GOODS AND SERVICES OF OTHERS BY PROVIDING A WEBSITE FEATURING COUPONS, REBATES, PRICE-COMPARISON INFORMATION, PRODUCT REVIEWS, LINKS TO THE RETAIL WEBSITES OF OTHERS, AND DISCOUNT INFORMATION AND A DISTRIBUTIVE, VIRAL, WORD-OF-MOUTH MARKETING SYSTEM BASED ON AN INTERNET PORTAL THAT OFFERS GREEN AND EARTH FRIENDLY PRODUCTS AND SERVICES THROUGH ITS ONLINE RETAIL WEBSITE (U.S. CLS. 100, 101 AND 102).

FIRST USE 3-1-2006; IN COMMERCE 3-1-2006.
MATTHEW KLINE, EXAMINING ATTORNEY

SN 77-563,637. SHOP2EARN NET, DBA SHOPTO EARN, LAS VEGAS, NV. FILED 9-5-2008.



THE MARK CONSISTS OF THE WORDS "SHOP TO EARTH", WITH A PICTURE OF THE WORLD GLOBE AS BACKGROUND TO THE WORD "TO".

FOR PROMOTING THE GOODS AND SERVICES OF OTHERS BY PROVIDING A WEBSITE FEATURING COUPONS, REBATES, PRICE-COMPARISON INFORMATION, PRODUCT REVIEWS, LINKS TO THE RETAIL WEBSITES OF OTHERS, AND DISCOUNT INFORMATION AND A DISTRIBUTIVE, VIRAL, WORD-OF-MOUTH MARKETING SYSTEM BASED ON AN INTERNET PORTAL THAT OFFERS GREEN AND EARTH FRIENDLY PRODUCTS AND SERVICES THROUGH ITS ONLINE RETAIL WEBSITE (U.S. CLS. 100, 101 AND 102).

FIRST USE 3-1-2006; IN COMMERCE 3-1-2006.
MATTHEW KLINE, EXAMINING ATTORNEY

CLASS 35—(Continued).

SN 77-563,690. V AND YA, INC., GREENSBORO, NC. FILED 9-5-2008.

PET INNOVATION

THE MARK CONSISTS OF STANDARD CHARACTERS WITHOUT CLAIM TO ANY PARTICULAR FONT, STYLE, SIZE, OR COLOR.

NO CLAIM IS MADE TO THE EXCLUSIVE RIGHT TO USE "PET", APART FROM THE MARK AS SHOWN.

FOR RETAIL STORE AND ON-LINE RETAIL STORE SERVICES FEATURING PET FOOD, INCLUDING ORGANIC, NATURAL AND HOLISTIC PET FOOD, PET SUPPLEMENTS, INCLUDING ORGANIC, NATURAL, AND HOLISTIC PET SUPPLEMENTS, PET SUPPLIES, PET TOYS, BIRDS, REPTILES, FISH, FISH TANK SUPPLIES, AND WATER GARDEN SUPPLIES (U.S. CLS. 100, 101 AND 102).

MARIA-VICTORIA SUAREZ, EXAMINING ATTORNEY

SN 77-563,725. FRED'S CAPITAL MANAGEMENT COMPANY, WILMINGTON, DE. FILED 9-5-2008.



OWNER OF U.S. REG. NOS. 972,584, 3,051,906 AND OTHERS.

THE MARK CONSISTS OF THE STYLIZED WORD "FRED'S" WHICH IS ABOVE A CURVED LINE.

FOR RETAIL GENERAL MERCHANDISE STORE SERVICES; RETAIL PHARMACY SERVICES (U.S. CLS. 100, 101 AND 102).

FIRST USE 10-0-2005; IN COMMERCE 10-0-2005.
APRIL HESIK, EXAMINING ATTORNEY

SN 77-563,804. BAD JOAN, LLC, LOS ANGELES, CA. FILED 9-5-2008.



THE LIKENESS (OR, "PORTRAIT") IN THE MARK IDENTIFIES A LIVING INDIVIDUAL WHOSE CONSENT IS OF RECORD.

THE MARK CONSISTS OF THE IMAGE OF A WOMAN WITH SHOPPING BAGS AND A CELL PHONE IN BETWEEN THE WORDS "BAD" AND "JOAN".

FOR ONLINE RETAIL STORE SERVICES FEATURING APPAREL AND FOOTWEAR (U.S. CLS. 100, 101 AND 102).

FIRST USE 4-2-2008; IN COMMERCE 4-2-2008.
KELLY MCCOY, EXAMINING ATTORNEY

CLASS 35—(Continued).

SN 77-563,832. ALLIED ATHLETE GROUP, INC., ATLANTA, GA. FILED 9-5-2008.



NO CLAIM IS MADE TO THE EXCLUSIVE RIGHT TO USE "ATHLETE GROUP", APART FROM THE MARK AS SHOWN.

THE COLOR(S) ORANGE AND GRAY IS/ARE CLAIMED AS A FEATURE OF THE MARK.

THE MARK CONSISTS OF THE LITERAL ELEMENT "ALLIED" IS IN AN ORANGE FONT. THE LITERAL ELEMENT "ATHLETE GROUP" IS IN A GRAY FONT. TWO IMAGES SIMILAR TO CHECK MARKS LAID ON THEIR SIDE CROSS ONE ANOTHER TO THE RIGHT OF THE LITERAL ELEMENT. TO THE LEFT OF WHERE THEY CROSS THEY ARE COLORED ORANGE AND TO THE RIGHT OF WHERE THEY MEET THEY ARE COLORED GRAY.

FOR ASSOCIATION SERVICES, NAMELY, PROMOTING THE INTERESTS OF PROFESSIONAL ATHLETES (U.S. CLS. 100, 101 AND 102).

FIRST USE 4-1-2008; IN COMMERCE 4-1-2008.
SALLY SHIH, EXAMINING ATTORNEY

CLASS 35—(Continued).

SN 77-563,912. PRACTICAL COMMUNICATIONS, INC., PALATINE, IL. FILED 9-5-2008.

OSP EXPO

THE MARK CONSISTS OF STANDARD CHARACTERS WITHOUT CLAIM TO ANY PARTICULAR FONT, STYLE, SIZE, OR COLOR.

NO CLAIM IS MADE TO THE EXCLUSIVE RIGHT TO USE "EXPO", APART FROM THE MARK AS SHOWN.

SEC. 2(F).

FOR ARRANGING AND CONDUCTING TRADE SHOW EXHIBITIONS IN THE FIELD OF TELECOMMUNICATIONS AND CABLE TELEVISION INDUSTRIES (U.S. CLS. 100, 101 AND 102).

FIRST USE 1-0-1998; IN COMMERCE 1-0-1998.
ROBIN CHOSID, EXAMINING ATTORNEY

SN 77-564,009. GOVERNMENT STAFFING SERVICES, INC., DBA MUNITEMPS - MUNICIPAL STAFFING SOLUTIONS, IMPERIAL BEACH, CA. FILED 9-6-2008.

It's not just a job, it's public service

THE MARK CONSISTS OF STANDARD CHARACTERS WITHOUT CLAIM TO ANY PARTICULAR FONT, STYLE, SIZE, OR COLOR.

FOR EMPLOYMENT COUNSELING AND RECRUITING; EMPLOYMENT STAFFING IN THE FIELD OF MUNICIPAL GOVERNMENT; JOB AND PERSONNEL PLACEMENT; PERSONNEL RECRUITMENT SERVICES AND EMPLOYMENT AGENCIES; TEMPORARY EMPLOYMENT AGENCIES (U.S. CLS. 100, 101 AND 102).

FIRST USE 7-3-2006; IN COMMERCE 7-3-2006.
ANTHONY RINKER, EXAMINING ATTORNEY

SN 77-563,891. T'S ACCESSORIES, LLC, SCOTTSDALE, AZ. FILED 9-5-2008.



NO CLAIM IS MADE TO THE EXCLUSIVE RIGHT TO USE "ACCESSORIES", APART FROM THE MARK AS SHOWN.

"T" DOES NOT IDENTIFY A LIVING INDIVIDUAL.

THE COLOR(S) RED AND BLACK IS/ARE CLAIMED AS A FEATURE OF THE MARK.

THE MARK CONSISTS OF "T'S ACCESSORIES" IN BLACK SUPERIMPOSED OVER A RED HEART. THE WORDS "AND MORE" AND THE THREE PERIODS ARE IN BLACK AND UNDERNEATH THE WORD "ACCESSORIES." THE WHITE PORTIONS OF THE MARK REPRESENT TRANSPARENT AREAS AND ARE NOT PART OF THE MARK.

FOR RETAIL STORE AND ON-LINE RETAIL STORE SERVICES FEATURING JEWELRY, WATCHES, AND KEY CHAINS, HANDBAGS, EVENING BAGS, AND OTHER SMALL LEATHER GOODS, NAMELY, WALLET, BRIEFCASES, AND KEY CHAINS, AND CLOTHING ARTICLES, NAMELY BELTS, SCARVES, SHOES, HATS, AND HAIR ACCESSORIES (U.S. CLS. 100, 101 AND 102).

FIRST USE 3-17-2007; IN COMMERCE 3-17-2007.
KATHLEEN M. VANSTON, EXAMINING ATTORNEY

SN 77-564,198. SUNTRUST BANKS, INC, ORLANDO, FL. FILED 9-8-2008.

Refer2Earn

THE MARK CONSISTS OF STANDARD CHARACTERS WITHOUT CLAIM TO ANY PARTICULAR FONT, STYLE, SIZE, OR COLOR.

FOR REFERRALS IN THE FIELD OF BANKING, NAMELY, A CLIENT REFERRAL PROMOTIONAL PROGRAM FOR OPENING NEW CHECKING ACCOUNTS (U.S. CLS. 100, 101 AND 102).

HANNO RITTNER, EXAMINING ATTORNEY

CLASS 35—(Continued).

SN 77-564,200. SOFTWARE AND INFORMATION TECHNOLOGY ASSOCIATION OF KANSAS, INC., LENEXA, KS. FILED 9-8-2008.

sitaks

THE MARK CONSISTS OF THE LITERAL ELEMENT "SITAKS" WITH THE LOWER CASE LETTERS "I" AND "A". FOR ASSOCIATION SERVICES, NAMELY, PROMOTING THE INTERESTS OF SOFTWARE, INFORMATION TECHNOLOGY, AND TELECOMMUNICATIONS COMPANIES, AND COMPANIES, UNIVERSITIES, COLLEGES, AND OTHER ENTITIES WITH SIGNIFICANT SOFTWARE, INFORMATION TECHNOLOGY AND/OR TELECOMMUNICATIONS OPERATIONS (U.S. CLS. 100, 101 AND 102).

FIRST USE 6-12-2008; IN COMMERCE 7-1-2008.
JACQUELINE A. LAVINE, EXAMINING ATTORNEY

SN 77-564,214. NATIONAL ACADEMY OF RECORDING ARTS & SCIENCES, INC., SANTA MONICA, CA. FILED 9-8-2008.

GRAMMY U

THE MARK CONSISTS OF STANDARD CHARACTERS WITHOUT CLAIM TO ANY PARTICULAR FONT, STYLE, SIZE, OR COLOR.

OWNER OF U.S. REG. NOS. 887,642, 3,202,214 AND OTHERS.

FOR ASSOCIATION SERVICES, NAMELY, PROMOTING THE INTERESTS OF COLLEGE STUDENTS WHO ARE PURSUING CAREERS IN THE MUSIC INDUSTRY (U.S. CLS. 100, 101 AND 102).

COLLEEN DOMBROW, EXAMINING ATTORNEY

SN 77-564,225. ORIGINAL PIECE, LLC, JACKSONVILLE, FL. FILED 9-8-2008.

ORIGINAL PIECE

THE MARK CONSISTS OF STANDARD CHARACTERS WITHOUT CLAIM TO ANY PARTICULAR FONT, STYLE, SIZE, OR COLOR.

NO CLAIM IS MADE TO THE EXCLUSIVE RIGHT TO USE "ORIGINAL", APART FROM THE MARK AS SHOWN.

FOR ON-LINE RETAIL STORE SERVICES FEATURING GIFTS AND APPAREL (U.S. CLS. 100, 101 AND 102).

ROBERT STRUCK, EXAMINING ATTORNEY

CLASS 35—(Continued).

SN 77-564,236. CENTRAL MASS SOUTH THE CHAMBER AT THE CROSSROADS OF NEW ENGLAND, INC., AKA THE CENTRAL MASS SOUTH CHAMBER OF COMMERCE, STURBRIDGE, MA. FILED 9-8-2008.

EVERYTHING BUT ORDINARY

THE MARK CONSISTS OF STANDARD CHARACTERS WITHOUT CLAIM TO ANY PARTICULAR FONT, STYLE, SIZE, OR COLOR.

FOR CHAMBER OF COMMERCE SERVICES, NAMELY, PROMOTING BUSINESS AND TOURISM IN THE STURBRIDGE, MASSACHUSETTS AREA, AND SURROUNDING AREAS (U.S. CLS. 100, 101 AND 102).

RUSS HERMAN, EXAMINING ATTORNEY

SN 77-564,349. EDEALZ, LLC, EDMOND, OK. FILED 9-8-2008.

THE COLOR(S) GREEN, BLACK AND RED IS/ARE CLAIMED AS A FEATURE OF THE MARK.

THE MARK CONSISTS OF THE STYLIZED LETTER "E" IN GREEN, THE WORD "DEALZ" IN BLACK, AND THE STYLIZED LETTER "Z" IN RED.

FOR ONLINE WHOLESALE AND RETAIL STORE SERVICES FEATURING CONSUMER ELECTRONICS (U.S. CLS. 100, 101 AND 102).

FIRST USE 11-25-2007; IN COMMERCE 11-25-2007.

JENNIFER MARTIN, EXAMINING ATTORNEY

SN 77-564,362. SIP ACADEMY USA, LLC, SALT LAKE CITY, UT. FILED 9-8-2008.

SIP

THE MARK CONSISTS OF STANDARD CHARACTERS WITHOUT CLAIM TO ANY PARTICULAR FONT, STYLE, SIZE, OR COLOR.

FOR FRANCHISE SERVICES, NAMELY, OFFERING BUSINESS MANAGEMENT ASSISTANCE IN THE ESTABLISHMENT AND OPERATION OF A BUSINESS THAT PROVIDES INSTRUCTION FOR CHILDREN AT THE PRIMARY LEVEL IN THE SUBJECTS OF MATH, ART, LINGUISTICS AND PHONETICS, ABACUS SKILLS AND THE FIVE SENSES (U.S. CLS. 100, 101 AND 102).

DAVID TOOLEY, EXAMINING ATTORNEY

CLASS 35—(Continued).

SN 77-564,413. ANFORRA LLC, NEW YORK, NY. FILED 9-8-2008.

The Pop Bag

THE MARK CONSISTS OF STANDARD CHARACTERS WITHOUT CLAIM TO ANY PARTICULAR FONT, STYLE, SIZE, OR COLOR.

FOR ADVERTISING, MARKETING AND PROMOTION SERVICES (U.S. CLS. 100, 101 AND 102).

FIRST USE 10-1-2006; IN COMMERCE 12-1-2006.
CHERYL CLAYTON, EXAMINING ATTORNEY

SN 77-564,456. MOSTMASSMEDIA, INC., RYE, NY. FILED 9-8-2008.



THE MARK CONSISTS OF THE STYLIZED WORD "TAGSALE.COM". IN THE BACKGROUND OF THE TEXT IS AN IMAGE OF A TAG.

FOR PROMOTING THE GOODS AND SERVICES OF OTHERS; NAMELY, THROUGH ADVERTISEMENTS DISSEMINATED BY AN ON-LINE ELECTRONIC COMMUNICATIONS NETWORK (U.S. CLS. 100, 101 AND 102).

FIRST USE 1-1-1996; IN COMMERCE 12-1-1997.
CHERYL CLAYTON, EXAMINING ATTORNEY

SN 77-564,500. WIZZARD SOFTWARE, CORP., PITTSBURGH, PA. FILED 9-8-2008.

COUPOD

THE MARK CONSISTS OF STANDARD CHARACTERS WITHOUT CLAIM TO ANY PARTICULAR FONT, STYLE, SIZE, OR COLOR.

FOR ADVERTISING SERVICES, NAMELY, PROMOTING THE GOODS AND SERVICES OF OTHERS BY PRODUCING VIDEO ADVERTISEMENTS AND ELECTRONIC COUPONS DOWNLOADABLE FROM A GLOBAL COMPUTER NETWORK (U.S. CLS. 100, 101 AND 102).

WARREN L. OLANDRIA, EXAMINING ATTORNEY

CLASS 35—(Continued).

SN 77-564,569. ACCOUNTONIT, LLP, SAN DIEGO, CA. FILED 9-8-2008.

ACCOUNTONIT

THE MARK CONSISTS OF STANDARD CHARACTERS WITHOUT CLAIM TO ANY PARTICULAR FONT, STYLE, SIZE, OR COLOR.

FOR ACCOUNTING SERVICES FOR INDIVIDUALS AND BUSINESSES; ACCOUNTING AND BUSINESS AUDITING SERVICES; TAX PREPARATION, COMPLIANCE AND CONSULTATION SERVICES; BOOKKEEPING SERVICES (U.S. CLS. 100, 101 AND 102).

FIRST USE 6-1-2003; IN COMMERCE 6-1-2003.
LEIGH CAROLINE CASE, EXAMINING ATTORNEY

SN 77-564,574. COUPONS4THETRIAD INC., GREENSBORO, NC. FILED 9-8-2008.

Surf-N-Save

THE MARK CONSISTS OF STANDARD CHARACTERS WITHOUT CLAIM TO ANY PARTICULAR FONT, STYLE, SIZE, OR COLOR.

FOR ON-LINE ADVERTISING AND MARKETING SERVICES (U.S. CLS. 100, 101 AND 102).

FIRST USE 7-1-2004; IN COMMERCE 7-1-2004.
ZACHARY BELLO, EXAMINING ATTORNEY

SN 77-564,697. WILBURN, WAYNE, SPRING HILL, TN. FILED 9-8-2008.

GO-TO HEALTHCARE PLACEMENT

THE MARK CONSISTS OF STANDARD CHARACTERS WITHOUT CLAIM TO ANY PARTICULAR FONT, STYLE, SIZE, OR COLOR.

NO CLAIM IS MADE TO THE EXCLUSIVE RIGHT TO USE "HEALTHCARE PLACEMENT", APART FROM THE MARK AS SHOWN.

FOR PROVIDING TEMPORARY, PERMANENT AND CONTRACT EMPLOYMENT PLACEMENT, CONSULTING AND RECRUITING SERVICES AND PROVIDING INFORMATION ON EMPLOYMENT, CAREERS AND TEMPORARY STAFFING (U.S. CLS. 100, 101 AND 102).

DEIRDRE ROBERTSON, EXAMINING ATTORNEY

CLASS 35—(Continued).

SN 77-564,754. SPRINGS GLOBAL US, INC., FORT MILL, SC. FILED 9-8-2008.

SURPRISE AND DELIGHT

THE MARK CONSISTS OF STANDARD CHARACTERS WITHOUT CLAIM TO ANY PARTICULAR FONT, STYLE, SIZE, OR COLOR.
FOR ADVERTISING AND MARKETING (U.S. CLS. 100, 101 AND 102).
LAKEISHA LEWIS, EXAMINING ATTORNEY

SN 77-564,833. WEST CORPORATION, OMAHA, NE. FILED 9-8-2008.

ESSENTIAL SAVINGS

THE MARK CONSISTS OF STANDARD CHARACTERS WITHOUT CLAIM TO ANY PARTICULAR FONT, STYLE, SIZE, OR COLOR.
NO CLAIM IS MADE TO THE EXCLUSIVE RIGHT TO USE "SAVINGS", APART FROM THE MARK AS SHOWN.
FOR ADMINISTRATION OF A DISCOUNT PROGRAM FOR ENABLING PARTICIPANTS TO OBTAIN DISCOUNTS ON GOODS AND SERVICES THROUGH USE OF A DISCOUNT MEMBERSHIP CARD (U.S. CLS. 100, 101 AND 102).
JIM RINGLE, EXAMINING ATTORNEY

SN 77-564,840. GAZILLION & ONE, INC., GRAND HAVEN, MI. FILED 9-8-2008.

GAZILLION & ONE

THE MARK CONSISTS OF STANDARD CHARACTERS WITHOUT CLAIM TO ANY PARTICULAR FONT, STYLE, SIZE, OR COLOR.
FOR ADVERTISING, MARKETING AND PROMOTION SERVICES (U.S. CLS. 100, 101 AND 102).
MARK T. MULLEN, EXAMINING ATTORNEY

CLASS 35—(Continued).

SN 77-564,937. WOMEN'S CAMPAIGN FORUM, WASHINGTON, DC. FILED 9-8-2008.

SHE SHOULD RUN

THE MARK CONSISTS OF STANDARD CHARACTERS WITHOUT CLAIM TO ANY PARTICULAR FONT, STYLE, SIZE, OR COLOR.
FOR RECRUITMENT PROGRAM THAT IDENTIFIES, RECRUITS AND EDUCATES PRO-CHOICE WOMEN AS CANDIDATES FOR LOCAL, STATE AND FEDERAL PUBLIC OFFICE (U.S. CLS. 100, 101 AND 102).
FIRST USE 6-1-2007; IN COMMERCE 6-1-2007.
JOHN WILKE, EXAMINING ATTORNEY

SN 77-564,938. ANALYTICARE, LLC, GLENVIEW, IL. FILED 9-8-2008.



NO CLAIM IS MADE TO THE EXCLUSIVE RIGHT TO USE "INTELLIGENCE", APART FROM THE MARK AS SHOWN.

THE COLOR(S) BLUE, GREEN, AND WHITE IS/ARE CLAIMED AS A FEATURE OF THE MARK.

THE MARK CONSISTS OF "ANALYTICARE", "INSIGHT", "ADVANTAGE", AND "INTELLIGENCE" IN STANDARD BLOCK TYPE SUPERIMPOSED OVER A WHITE BACKGROUND. THE LETTERS OF "ANALYTICARE" ARE COLORED AS FOLLOWS: "ANALYTI" CONSISTS OF BLUE; AND "CARE" CONSISTS OF GREEN. THE WORDS "INSIGHT", "ADVANTAGE", AND "INTELLIGENCE" ARE POSITIONED HORIZONTALLY BELOW "ANALYTICARE" IN BLUE TYPE, WITH THE TERMS "INSIGHT", "ADVANTAGE", AND "INTELLIGENCE" BEING SEPARATED AND PUNCTUATED BY TWO SMALL BLUE CIRCLES IN BETWEEN "INSIGHT" AND "ADVANTAGE" AS WELL AS "ADVANTAGE" AND "INTELLIGENCE". A BLUE HERALD'S STAFF ENTWINED BY TWO SERPENTS IN THE FORM OF A DOUBLE HELIX AND SURMOUNTED BY TWO GREEN WINGS (COMMONLY KNOWN AS A CADUCEUS) IS POSITIONED VERTICALLY TO THE RIGHT OF THE LITERAL ELEMENTS OF THE MARK AND SUPERIMPOSED OVER A WHITE BACKGROUND.

FOR BUSINESS MANAGEMENT INFORMATION FOR THE HEALTHCARE INDUSTRY, PRIMARILY LONG TERM CARE PROVIDERS, NAMELY, PRODUCING REPORTS AND ANALYSIS WHICH INTEGRATE FINANCIAL, MARKET, CLINICAL, AND PHARMACEUTICAL DATA (U.S. CLS. 100, 101 AND 102).

FIRST USE 7-3-2007; IN COMMERCE 7-3-2007.
MICHAEL KEATING, EXAMINING ATTORNEY

CLASS 35—(Continued).

SN 77-565,136. CREDITBACK, INC., OREM, UT. FILED 9-8-2008.



NO CLAIM IS MADE TO THE EXCLUSIVE RIGHT TO USE "POINT REWARDS", APART FROM THE MARK AS SHOWN.

THE MARK CONSISTS OF A STYLIZED IMAGE WHICH RESEMBLES A FLOWER ON A STEM WITH FOUR OUTLINED PETALS. THE STEM MEETS THE GRASS, AND THERE IS A SEED IN EACH PETAL REFERENCED TOWARD THE CENTER OF THE FLOWER. THE STYLIZED WORDS "LEARNING POINT REWARDS" ARE WRITTEN NEXT TO THE FLOWER.

FOR PROVIDING INCENTIVE AWARD PROGRAMS FOR CUSTOMERS TO FREQUENT PARTICIPATING PARTNERS; FACILITATING THE ASSOCIATION BETWEEN RETAILERS, AND SCHOOLS AND OTHER ASSOCIATIONS FOR PARTICIPATION IN INCENTIVE AWARD PROGRAMS FOR EDUCATIONAL FUNDING; PROPRIETARY BUSINESS SERVICES IN THE NATURE OF MARKETING AND ADVERTISING, CUSTOMER RELATIONSHIP MANAGEMENT, BUSINESS CONSULTING, COMPUTERIZED DATABASE MANAGEMENT AND REPORTING AS IT RELATES TO THE INCENTIVE AWARD PROGRAMS (U.S. CLS. 100, 101 AND 102).

FIRST USE 2-1-2008; IN COMMERCE 3-3-2008.
LINDA E. BLOHM, EXAMINING ATTORNEY

SN 77-565,152. INFINITY BUSINESS SUPPORT SYSTEMS, LLC, DBA INFINITY CONSULTING, KAMUELA, HI. FILED 9-8-2008.



NO CLAIM IS MADE TO THE EXCLUSIVE RIGHT TO USE "CONSULTING", APART FROM THE MARK AS SHOWN.

THE COLOR(S) BLACK, GOLD, AND GREY IS/ARE CLAIMED AS A FEATURE OF THE MARK.

THE MARK CONSISTS OF THE WORDS "INFINITY

CLASS 35—(Continued).

"CONSULTING" IN BLACK, WRITTEN SUCH THAT THE WORD "INFINITY" CREATES AN INFINITY SYMBOL INSIDE OF ITSELF. THE "F" CREATES HALF OF THE INFINITY SYMBOL AND A GOLD MARK HIGHLIGHTED WITH LIGHT GREY CREATES THE SECOND HALF OF THE INFINITY SYMBOL. THE GOLD MARK ALSO TOUCHES THE EDGES OF THE LETTERS "I N I N I", WHICH ALONG WITH THE "F", CREATE THE INFINITY SYMBOL. THE WORD "CONSULTING" IS WRITTEN IN SMALLER LETTERS, BELOW THE WORD "INFINITY".

FOR ADVERTISING AND BUSINESS MANAGEMENT CONSULTANCY; ADVERTISING AND MARKETING; ADVERTISING SERVICES, NAMELY, CREATING CORPORATE AND BRAND IDENTITY FOR OTHERS; ADVICE RELATING TO THE ORGANISATION AND MANAGEMENT OF BUSINESS; ADVISORY SERVICE FOR ORGANIZATIONAL ISSUES AND BUSINESS ADMINISTRATION, WITH AND WITHOUT THE HELP OF ELECTRONIC DATA BASES; ASSISTANCE WITH BUSINESS MANAGEMENT AND PLANNING; ASSISTANCE, ADVISORY SERVICES AND CONSULTANCY WITH REGARD TO BUSINESS PLANNING, BUSINESS ANALYSIS, BUSINESS MANAGEMENT, AND BUSINESS ORGANIZATION; BRAND IMAGERY CONSULTING SERVICES; BUSINESS ADVICE AND ANALYSIS OF MARKETS; BUSINESS CARD DESIGN SERVICES; BUSINESS CONSULTATION; BUSINESS CONSULTATION AND MANAGEMENT REGARDING MARKETING ACTIVITIES AND LAUNCHING OF NEW PRODUCTS; BUSINESS CONSULTING SERVICES, NAMELY, PROVIDING ASSISTANCE IN DEVELOPMENT OF BUSINESS STRATEGIES AND CREATIVE IDEATION; BUSINESS MARKETING CONSULTING SERVICES; CREATIVE MARKETING DESIGN SERVICES; DEVELOPMENT OF MARKETING STRATEGIES AND CONCEPTS (U.S. CLS. 100, 101 AND 102).

FIRST USE 4-25-2008; IN COMMERCE 4-25-2008.
IRA J. GOODSAD, EXAMINING ATTORNEY

SN 77-565,254. NATURES CANDY DESIGNS, LTD., LANGHORNE, PA. FILED 9-9-2008.

WHAT'S YOUR ELEMENT?

THE MARK CONSISTS OF STANDARD CHARACTERS WITHOUT CLAIM TO ANY PARTICULAR FONT, STYLE, SIZE, OR COLOR.

FOR ELECTRONIC CATALOG SERVICES FEATURING JEWELRY, CLOTHING AND GIFTWARE (U.S. CLS. 100, 101 AND 102).

VIVIAN MICZNIK FIRST, EXAMINING ATTORNEY

SN 77-565,409. CARPIN, DENNIS, MOUNT PLEASANT, SC. FILED 9-9-2008.

"OUR PRODUCTS WILL FLOOR YOU, OUR PRICES WON'T"

THE MARK CONSISTS OF STANDARD CHARACTERS WITHOUT CLAIM TO ANY PARTICULAR FONT, STYLE, SIZE, OR COLOR.

FOR RETAIL STORES FEATURING FLOOR COVERINGS (U.S. CLS. 100, 101 AND 102).

FIRST USE 7-1-1995; IN COMMERCE 7-1-1995.
JILL PRATER, EXAMINING ATTORNEY

CLASS 35—(Continued).

SN 77-565,420. EL METATE FOODS, SANTA ANA, CA. FILED 9-9-2008.

Fresh for Less

THE MARK CONSISTS OF STANDARD CHARACTERS WITHOUT CLAIM TO ANY PARTICULAR FONT, STYLE, SIZE, OR COLOR.
FOR RETAIL GROCERY STORES (U.S. CLS. 100, 101 AND 102).
FIRST USE 6-1-2006; IN COMMERCE 6-1-2006.
JULIE GUTTADAURO, EXAMINING ATTORNEY

SN 77-565,447. WORLD WEB SEARCH, INC., CARDIFF, CA. FILED 9-9-2008.

Get Degrees

THE MARK CONSISTS OF STANDARD CHARACTERS WITHOUT CLAIM TO ANY PARTICULAR FONT, STYLE, SIZE, OR COLOR.
FOR PROVIDING AN ON-LINE DIRECTORY INFORMATION SERVICE FEATURING INFORMATION FOR DISTANCE LEARNING EDUCATION TO STUDENTS, PROFESSIONALS AND POST-SECONDARY STUDENTS DAILY TO FIND INFORMATION ON TOPICS SUCH AS THE BEST MEDICAL TRAINING PROGRAMS, LEGAL TRAINING, CULINARY, GRADUATE AND MBA DEGREES (U.S. CLS. 100, 101 AND 102).
FIRST USE 1-1-2000; IN COMMERCE 1-1-2000.
JENNY PARK, EXAMINING ATTORNEY

SN 77-565,487. OWEN, AARON L., SAN BERNADINO, CA. FILED 9-9-2008.

BAND OF ANGELS

THE MARK CONSISTS OF STANDARD CHARACTERS WITHOUT CLAIM TO ANY PARTICULAR FONT, STYLE, SIZE, OR COLOR.
FOR RETAIL STORE SERVICE AND WHOLESALE DISTRIBUTORSHIP SERVICE FEATURING JEWELRY (U.S. CLS. 100, 101 AND 102).
JESSICA A. POWERS, EXAMINING ATTORNEY

CLASS 35—(Continued).

SN 77-565,501. HRNCIAR, PETER, HAMDEN, CT. FILED 9-9-2008.

ELLANOVA

THE MARK CONSISTS OF STANDARD CHARACTERS WITHOUT CLAIM TO ANY PARTICULAR FONT, STYLE, SIZE, OR COLOR.
FOR PHARMACEUTICAL RESEARCH OUTSOURCING SERVICES (U.S. CLS. 100, 101 AND 102).
ANTHONY RINKER, EXAMINING ATTORNEY

SN 77-565,531. SALES CONSULTANTS OF CHICAGO-DOWNTOWN, INC., CHICAGO, IL. FILED 9-9-2008.

WORLD CONCERT

THE MARK CONSISTS OF STANDARD CHARACTERS WITHOUT CLAIM TO ANY PARTICULAR FONT, STYLE, SIZE, OR COLOR.
FOR EMPLOYMENT COUNSELING AND RECRUITING; EMPLOYMENT HIRING, RECRUITING, PLACEMENT, STAFFING AND CAREER NETWORKING SERVICES; EMPLOYMENT RECRUITING CONSULTATION; EXECUTIVE SEARCH AND PLACEMENT SERVICES; HUMAN RESOURCES MANAGEMENT; HUMAN RESOURCES SERVICES, NAMELY, PERSONNEL SELECTION FOR OTHERS; PERSONNEL PLACEMENT AND RECRUITMENT; SERVING AS A HUMAN RESOURCES DEPARTMENT FOR OTHERS (U.S. CLS. 100, 101 AND 102).
LAURA KOVALSKY, EXAMINING ATTORNEY

SN 77-565,540. YROCKET, UPPER DARBY, PA. FILED 9-9-2008.

YRocket

THE MARK CONSISTS OF STANDARD CHARACTERS WITHOUT CLAIM TO ANY PARTICULAR FONT, STYLE, SIZE, OR COLOR.
FOR ON-LINE RETAIL STORE SERVICES FEATURING CLOTHING, EARRINGS, SHOES, BAGS AND FASHION ACCESSORIES (U.S. CLS. 100, 101 AND 102).
LINDA LAVACHE, EXAMINING ATTORNEY

CLASS 35—(Continued).

SN 77-565,744. TOMPKINS INDUSTRIES, INC., OLATHE, KS. FILED 9-9-2008.

TOMPKINS

THE MARK CONSISTS OF STANDARD CHARACTERS WITHOUT CLAIM TO ANY PARTICULAR FONT, STYLE, SIZE, OR COLOR.

SEC. 2(F).

FOR DISTRIBUTORSHIP SERVICES FEATURING ADAPTERS AND FLUID POWER PRODUCTS OF OTHERS; ONLINE RETAIL STORE SERVICES FEATURING HYDRAULIC ADAPTERS AND FLUID POWER PRODUCTS (U.S. CLS. 100, 101 AND 102).

FIRST USE 10-0-1967; IN COMMERCE 10-0-1967.

AMY HELLA, EXAMINING ATTORNEY

SN 77-565,772. GROWTH TECHNOLOGIES, TAMPA, FL. FILED 9-9-2008.

AutoGroove

THE MARK CONSISTS OF STANDARD CHARACTERS WITHOUT CLAIM TO ANY PARTICULAR FONT, STYLE, SIZE, OR COLOR.

FOR ADVERTISING, MARKETING AND PROMOTIONAL SERVICES FOR AUTOMOTIVE DEALERSHIPS; ARRANGING AND CONDUCTING AUCTIONS IN THE FIELD OF AUTOMOTIVE SALES; ARRANGING AND CONDUCTION OF AUCTION SALES; AUCTION MANAGEMENT SERVICES PROVIDED TO OTHERS OVER AN ON-LINE WEB SITE ACCESSED THROUGH A GLOBAL COMPUTER NETWORK; ON-LINE AUCTION BIDDING FOR OTHERS; ON-LINE AUCTION SERVICES; ON-LINE BUSINESS RESEARCH SERVICE THAT ALLOWS THE USER TO ANALYZE OPINION TRENDS CONTAINED IN DOCUMENTS ON THE INTERNET; PROVIDING A WEB SITE THAT FEATURES AN ON-LINE MARKET FOR USERS TO LIST OFFERED OR WANTED PERSONAL AND BUSINESS ASSETS AND SKILLS FOR HIRE, RENT, SALE OR AUCTION TRANSACTED ON THE BASIS OF PREDEFINED PERFORMANCE AND CLOSING TERMS AND CONDITIONS; PROVIDING ON-LINE AUCTION SERVICES (U.S. CLS. 100, 101 AND 102).

KARANENDRA S. CHHINA, EXAMINING ATTORNEY

CLASS 35—(Continued).

SN 77-565,828. STOCKMEUP, INC., OLATHE, KS. FILED 9-9-2008.

STOCKMEUP.COM

THE MARK CONSISTS OF STANDARD CHARACTERS WITHOUT CLAIM TO ANY PARTICULAR FONT, STYLE, SIZE, OR COLOR.

FOR ONLINE RETAIL STORE SERVICES FEATURING GENERAL CONSUMER MERCHANDISE (U.S. CLS. 100, 101 AND 102).

FIRST USE 9-0-2007; IN COMMERCE 9-0-2007.

ESTHER BELENKER, EXAMINING ATTORNEY

SN 77-565,854. CROSS COMMERCE MEDIA, INC., NEW YORK, NY. FILED 9-9-2008.

YINZO

THE MARK CONSISTS OF STANDARD CHARACTERS WITHOUT CLAIM TO ANY PARTICULAR FONT, STYLE, SIZE, OR COLOR.

FOR ADVERTISING, MARKETING AND PUBLICITY SERVICES, NAMELY, PROMOTING THE GOODS AND SERVICES OF OTHERS BY DISTRIBUTING ADVERTISING MATERIALS THROUGH A VARIETY OF METHODS; ADVERTISING CONSULTATION SERVICES, CREATION OF MARKETING TOOLS DESIGNED TO INCREASE A CLIENT COMPANY'S KNOWLEDGE OF CUSTOMER NEEDS, AND ITS COMPETITORS' PRODUCTS AND SERVICES, PRICING, ADVERTISING STRATEGY AND SALES STRATEGY (U.S. CLS. 100, 101 AND 102).

FIRST USE 7-24-2008; IN COMMERCE 7-24-2008.

SUSAN RICHARDS, EXAMINING ATTORNEY

SN 77-565,857. J. WALTER THOMPSON COMPANY, NEW YORK, NY. FILED 9-9-2008.

JWT INSIDE Track

THE MARK CONSISTS OF STANDARD CHARACTERS WITHOUT CLAIM TO ANY PARTICULAR FONT, STYLE, SIZE, OR COLOR.

OWNER OF U.S. REG. NOS. 2,045,699 AND 2,629,031.

FOR MARKET RESEARCH AND MEDIA RESEARCH IN THE FIELD OF EMPLOYMENT AND RECRUITMENT; TRACKING ADVERTISING PLACEMENT AND EFFECTIVENESS IN ONLINE AND OFFLINE MEDIA IN THE FIELD OF EMPLOYMENT AND RECRUITMENT; PROVIDING AN ONLINE DATABASE THAT ALLOWS OTHERS TO TRACK ADVERTISING PLACEMENT AND EFFECTIVENESS IN THE FIELD OF EMPLOYMENT AND RECRUITMENT (U.S. CLS. 100, 101 AND 102).

BARBARA RUTLAND, EXAMINING ATTORNEY

CLASS 35—(Continued).

SN 77-565,905. ELDRIDGE, DAVID G, DBA PRO ENGINEER PORTAL, SALINAS, CA. FILED 9-9-2008.

ProEngineerPortal

THE MARK CONSISTS OF STANDARD CHARACTERS WITHOUT CLAIM TO ANY PARTICULAR FONT, STYLE, SIZE, OR COLOR.
 FOR BUSINESS DEVELOPMENT SERVICES, NAMELY, PROVIDING START-UP SUPPORT FOR BUSINESSES OF OTHERS (U.S. CLS. 100, 101 AND 102).
 FIRST USE 1-10-2006; IN COMMERCE 1-10-2006.
 JENNY PARK, EXAMINING ATTORNEY

CLASS 35—(Continued).

SN 77-565,973. 4 SALE 4 NOW, INC., EAST DUNDEE, IL. FILED 9-9-2008.

NO BIDDING. JUST BUYING.

THE MARK CONSISTS OF STANDARD CHARACTERS WITHOUT CLAIM TO ANY PARTICULAR FONT, STYLE, SIZE, OR COLOR.
 FOR ON-LINE TRADING SERVICES IN WHICH SELLER POSTS PRODUCTS TO BE AUCTIONED AND BIDDING IS DONE VIA THE INTERNET (U.S. CLS. 100, 101 AND 102).
 ANGELA M. MICHELI, EXAMINING ATTORNEY

SN 77-565,913. CAMBRIA COVE LLC, TOPKEA, KS. FILED 9-9-2008.

CAMBRIA COVE

THE MARK CONSISTS OF STANDARD CHARACTERS WITHOUT CLAIM TO ANY PARTICULAR FONT, STYLE, SIZE, OR COLOR.
 FOR RETAIL STORE AND ON-LINE RETAIL STORE SERVICES FEATURING GIFTS AND PERSONAL ACCESSORY ITEMS INCLUDING STATIONERY, BOOKS, MUSIC, HOME DECOR, GOURMET FOOD, MEMORY KEEPING, BATH AND BODY PRODUCTS (U.S. CLS. 100, 101 AND 102).
 ANGELA M. MICHELI, EXAMINING ATTORNEY

SN 77-565,975. 4 SALE 4 NOW, INC., EAST DUNDEE, IL. FILED 9-9-2008.

STOP BIDDING. START BUYING.

THE MARK CONSISTS OF STANDARD CHARACTERS WITHOUT CLAIM TO ANY PARTICULAR FONT, STYLE, SIZE, OR COLOR.
 FOR ON-LINE TRADING SERVICES IN WHICH SELLER POSTS PRODUCTS TO BE AUCTIONED AND BIDDING IS DONE VIA THE INTERNET (U.S. CLS. 100, 101 AND 102).
 ANGELA M. MICHELI, EXAMINING ATTORNEY

SN 77-565,972. 4 SALE 4 NOW, INC., EAST DUNDEE, IL. FILED 9-9-2008.

BETTER DEALS BY THE DAY

THE MARK CONSISTS OF STANDARD CHARACTERS WITHOUT CLAIM TO ANY PARTICULAR FONT, STYLE, SIZE, OR COLOR.
 FOR ON-LINE TRADING SERVICES IN WHICH SELLER POSTS PRODUCTS TO BE AUCTIONED AND BIDDING IS DONE VIA THE INTERNET (U.S. CLS. 100, 101 AND 102).
 ANGELA M. MICHELI, EXAMINING ATTORNEY

SN 77-565,983. INFEGY, INC., KANSAS CITY, MO. FILED 9-9-2008.

Social Radar

THE MARK CONSISTS OF STANDARD CHARACTERS WITHOUT CLAIM TO ANY PARTICULAR FONT, STYLE, SIZE, OR COLOR.
 FOR MARKET MANIPULATION, RESEARCH AND ANALYSIS, WHETHER OR NOT VIA THE INTERNET; ON-LINE BUSINESS RESEARCH SERVICE THAT ALLOWS THE USER TO ANALYZE OPINION TRENDS CONTAINED IN DOCUMENTS ON THE INTERNET; PROVIDING INFORMATION IN THE FIELD OF MARKETING AND ON-LINE MARKETING MEDIA VIA THE INTERNET (U.S. CLS. 100, 101 AND 102).
 FIRST USE 2-2-2007; IN COMMERCE 2-2-2007.
 MELISSA VALLILLO, EXAMINING ATTORNEY

CLASS 35—(Continued).

SN 77-566,008. K ERIC LANIER, NEWBERG, OR. FILED 9-9-2008.

CLASS 35—(Continued).

SN 77-566,085. AMNESTY INTERNATIONAL OF THE U.S.A., INC., DBA AMNESTY INTERNATIONAL, NEW YORK, NY. FILED 9-9-2008.

INSOLEUTIONS

THE MARK CONSISTS OF STANDARD CHARACTERS WITHOUT CLAIM TO ANY PARTICULAR FONT, STYLE, SIZE, OR COLOR.

FOR RETAIL STORE AND ON-LINE RETAIL STORE SERVICES FEATURING INSOLES (U.S. CLS. 100, 101 AND 102).

FIRST USE 7-28-2008; IN COMMERCE 7-28-2008.

JOHN DWYER, EXAMINING ATTORNEY

PROTECT THE HUMAN

THE MARK CONSISTS OF STANDARD CHARACTERS WITHOUT CLAIM TO ANY PARTICULAR FONT, STYLE, SIZE, OR COLOR.

FOR ASSOCIATION SERVICES, NAMELY, PROMOTING HUMAN RIGHTS (U.S. CLS. 100, 101 AND 102).

BILL DAWE, EXAMINING ATTORNEY

SN 77-566,035. UNITED STATES ANTI-DOPING AGENCY, AKA USADA, COLORADO SPRINGS, CO. FILED 9-9-2008.

SN 77-566,116. METALLURG VANADIUM CORPORATION, CAMBRIDGE, OH. FILED 9-9-2008.



My Victory.
I compete clean.

METVAN

OWNER OF U.S. REG. NOS. 3,220,102 AND 3,239,326.
THE MARK CONSISTS OF THE WORDS "MY VICTORY. I COMPETE CLEAN." IN STYLIZED LETTERS WITH THE "V" IN "VICTORY" EMPHASIZED IN A LARGER FONT AND A HORIZONTAL SLASH BENEATH THE STYLIZED MARK.

FOR PROMOTING PUBLIC AWARENESS OF SPORTSMANSHIP, FAIR PLAY, SPORTS VALUES, SPORTS ETHICS AND PARTICIPATION IN SPORTS WITHOUT THE USE OF PERFORMANCE-ENHANCING DRUGS OR METHODS (U.S. CLS. 100, 101 AND 102).

FIRST USE 4-24-2008; IN COMMERCE 4-24-2008.

JILL C. ALT, EXAMINING ATTORNEY

THE MARK CONSISTS OF STANDARD CHARACTERS WITHOUT CLAIM TO ANY PARTICULAR FONT, STYLE, SIZE, OR COLOR.

OWNER OF U.S. REG. NO. 2,690,052.
FOR DISTRIBUTORSHIPS IN THE FIELD OF METAL ALLOYS AND SPECIALTY METAL PRODUCTS (U.S. CLS. 100, 101 AND 102).

BARBARA BROWN, EXAMINING ATTORNEY

SN 77-566,071. WEBPOWER, INC., LAKE WORTH, FL. FILED 9-9-2008.

SN 77-566,205. HORNBECK, STEPHEN R., DALLAS, TX. FILED 9-10-2008.

CC4**PAPA SOUL**

THE MARK CONSISTS OF STANDARD CHARACTERS WITHOUT CLAIM TO ANY PARTICULAR FONT, STYLE, SIZE, OR COLOR.

FOR CUSTOMER SERVICE IN THE FIELD OF ON-LINE TRANSACTION INFORMATION (U.S. CLS. 100, 101 AND 102).

ROBIN CHOSID, EXAMINING ATTORNEY

THE MARK CONSISTS OF STANDARD CHARACTERS WITHOUT CLAIM TO ANY PARTICULAR FONT, STYLE, SIZE, OR COLOR.

FOR RETAIL STORE AND ON-LINE RETAIL STORE SERVICES FEATURING CLOTHING AND APPAREL (U.S. CLS. 100, 101 AND 102).

ELISSA GARBER KON, EXAMINING ATTORNEY

CLASS 35—(Continued).

SN 77-566,395. PARK, NAM K, DULUTH, GA. FILED 9-10-2008.

BNB Beauty N Beyond

THE MARK CONSISTS OF STANDARD CHARACTERS WITHOUT CLAIM TO ANY PARTICULAR FONT, STYLE, SIZE, OR COLOR.

FOR RETAIL STORE AND ON-LINE RETAIL STORE SERVICES FEATURING GENERAL BEAUTY SUPPLIES (U.S. CLS. 100, 101 AND 102).

ZACHARY BELLO, EXAMINING ATTORNEY

CLASS 35—(Continued).

SN 77-566,477. CAFEGIVE, LLC, BEND, OR. FILED 9-10-2008.

CAFEGIVE

THE MARK CONSISTS OF STANDARD CHARACTERS WITHOUT CLAIM TO ANY PARTICULAR FONT, STYLE, SIZE, OR COLOR.

FOR AFFINITY MARKETING SERVICES, NAMELY, THE CREATION, IMPLEMENTATION AND MANAGEMENT OF ONLINE JOINT MARKETING PROGRAMS FOR OTHERS (U.S. CLS. 100, 101 AND 102).

JESSICA A. POWERS, EXAMINING ATTORNEY

SN 77-566,431. BLOOD DIAGNOSTICS, INC., IRMO, SC. FILED 9-10-2008.

BDIPharma

OWNER OF U.S. REG. NO. 2,905,678. THE MARK CONSISTS OF THE TEXT "BDIPHARMA" TO THE RIGHT OF A HIGHLY STYLIZED DESIGN DERIVED FROM THE CURVES IN THE LETTERS "B" AND "D".

FOR WHOLESALE DISTRIBUTION OF PHARMACEUTICALS (U.S. CLS. 100, 101 AND 102).

JILL PRATER, EXAMINING ATTORNEY

SN 77-566,543. PHU, MARK, HOUSTON, TX. FILED 9-10-2008.

KAMIKAZECON

THE MARK CONSISTS OF STANDARD CHARACTERS WITHOUT CLAIM TO ANY PARTICULAR FONT, STYLE, SIZE, OR COLOR.

FOR ARRANGING AND CONDUCTING TRADE SHOW EXHIBITIONS IN THE FIELD OF ANIMATION, COMICS, AND GAMES (U.S. CLS. 100, 101 AND 102).

NAKIA HENRY, EXAMINING ATTORNEY

SN 77-566,458. GARRETT ADKINS, SCOTTSDALE, AZ. FILED 9-10-2008.

LITTLESWAG

THE MARK CONSISTS OF STANDARD CHARACTERS WITHOUT CLAIM TO ANY PARTICULAR FONT, STYLE, SIZE, OR COLOR.

FOR ON-LINE RETAIL STORE SERVICES FEATURING CLOTHING FOR CHILDREN, TODDLERS AND BABIES (U.S. CLS. 100, 101 AND 102).

LINDA POWELL, EXAMINING ATTORNEY

SN 77-566,576. FINGERHUT DIRECT MARKETING, INC., EDEN PRAIRIE, MN. FILED 9-10-2008.

CAREFREE LIVING

THE MARK CONSISTS OF STANDARD CHARACTERS WITHOUT CLAIM TO ANY PARTICULAR FONT, STYLE, SIZE, OR COLOR.

OWNER OF U.S. REG. NO. 1,505,333. FOR ONLINE RETAIL STORE SERVICES AND ON-LINE ORDERING SERVICES IN THE FIELD OF GENERAL MERCHANDISE (U.S. CLS. 100, 101 AND 102).

ANN E. SAPPENFIELD, EXAMINING ATTORNEY

CLASS 35—(Continued).

SN 77-566,584. FLY BY NIGHT, INC., NORTHAMPTON, MA. FILED 9-10-2008.



THE MARK CONSISTS OF THE WORDS "FLY BY NIGHT" IN A DIVIDED BOX, WITH THE WORDS "FLY BY" BLACK ON WHITE ON THE LEFT, THE WORD "NIGHT" WHITE ON BLACK ON THE RIGHT, AND HALF CIRCLES OF BLACK AND WHITE BETWEEN THE WORDS "BY" AND "NIGHT".

FOR RETAIL STORE AND ON-LINE RETAIL STORE SERVICES FEATURING HOME ACCESSORIES AND FURNITURE (U.S. CLS. 100, 101 AND 102).

FIRST USE 8-1-1988; IN COMMERCE 8-1-1988.

ROBIN CHOSID, EXAMINING ATTORNEY

CLASS 35—(Continued).

SN 77-566,928. FIELDKATZ, LLC, NEW YORK, NY. FILED 9-10-2008.



NO CLAIM IS MADE TO THE EXCLUSIVE RIGHT TO USE "GIFT", APART FROM THE MARK AS SHOWN.

THE MARK CONSISTS OF AN INDIVIDUAL WITH A MASK AND CAPE HOLDING A GIFT BOX IN ITS LEFT HAND THAT APPEARS OVER THE WORDS "GIFT HERO".

FOR COMPUTERIZED ON-LINE ORDERING SERVICES IN THE FIELD OF BIRTHDAY GIFT ITEMS AND SPECIAL OCCASION GIFT ITEMS (U.S. CLS. 100, 101 AND 102).

JENNY PARK, EXAMINING ATTORNEY

SN 77-566,791. DOCUMENT MANAGEMENT SOLUTIONS, INC., MANCHESTER, NH. FILED 9-10-2008.

SOFTLINK

THE MARK CONSISTS OF STANDARD CHARACTERS WITHOUT CLAIM TO ANY PARTICULAR FONT, STYLE, SIZE, OR COLOR.

FOR MARKETING SERVICES, NAMELY, PROVIDING HYPERLINKS FOR INDEPENDENT SOFTWARE VENDORS TO LINK TO INFORMATIONAL WEB PAGES DESIGNED TO GENERATE SALES TRAFFIC VIA HYPERLINKS TO SITES SHOWING RELATED HARDWARE (U.S. CLS. 100, 101 AND 102).

FIRST USE 1-7-2008; IN COMMERCE 1-7-2008.

REBECCA POVARCHUK, EXAMINING ATTORNEY

SN 77-567,000. GO EASY, KALAMAZOO, MI. FILED 9-10-2008.



THE STIPPLING IS FOR SHADING PURPOSES ONLY.

THE MARK CONSISTS OF THE STYLIZED TEXT "GO EASY PRODUCTS THAT TRAVEL WITH LESS HASSLE". ON TOP THERE IS A FIGURE SITTING IN A CHAIR. ALL ARE SURROUNDED BY A BORDER.

FOR RETAIL STORES FEATURING PERSONAL BODY CARE, HOUSEHOLD, CLEANING, TRAVEL PRODUCTS, CLOTHES CARE AND PERSONAL CARE (U.S. CLS. 100, 101 AND 102).

KATINA MISTER, EXAMINING ATTORNEY

CLASS 35—(Continued).

SN 77-567,202. NEW EARTH SCOOTERS LLC, STUART, FL. FILED 9-10-2008.

BUY ONE, GAS SEEMS FREE

THE MARK CONSISTS OF STANDARD CHARACTERS WITHOUT CLAIM TO ANY PARTICULAR FONT, STYLE, SIZE, OR COLOR.

FOR DEALERSHIPS IN THE FIELD OF MOTORCYCLES, AUTOMOBILES AND SCOOTERS (U.S. CLS. 100, 101 AND 102).

TASNEEM HUSSAIN, EXAMINING ATTORNEY

CLASS 35—(Continued).

SN 77-567,401. MATTRESS INN, INC., NASHVILLE, TN. FILED 9-11-2008.

Experience it Before you
Buy it!

THE MARK CONSISTS OF STANDARD CHARACTERS WITHOUT CLAIM TO ANY PARTICULAR FONT, STYLE, SIZE, OR COLOR.

FOR RETAIL STORES FEATURING MATTRESSES THAT CUSTOMERS CAN TRY BEFORE PURCHASING (U.S. CLS. 100, 101 AND 102).

FIRST USE 9-1-2007; IN COMMERCE 9-1-2007.

TRACY FLETCHER, EXAMINING ATTORNEY

SN 77-568,044. ABT ELECTRONICS, INC., GLENVIEW, IL. FILED 9-11-2008.

SN 77-567,275. MADISON,JEFF, NEW ORLEANS, LA. FILED 9-10-2008.

Cool Hand Nuke

THE MARK CONSISTS OF STANDARD CHARACTERS WITHOUT CLAIM TO ANY PARTICULAR FONT, STYLE, SIZE, OR COLOR.

FOR CONSULTANCY OF PERSONNEL RECRUITMENT; EMPLOYMENT COUNSELING AND RECRUITING; EMPLOYMENT HIRING, RECRUITING, PLACEMENT, STAFFING AND CAREER NETWORKING SERVICES; EMPLOYMENT RECRUITING CONSULTATION; MANAGEMENT AND BUSINESS CONSULTING SERVICES IN THE FIELD OF TRAINING AND RECRUITMENT; PERSONNEL PLACEMENT AND RECRUITMENT; PERSONNEL RECRUITMENT SERVICES AND EMPLOYMENT AGENCIES; PROVIDING A WEB SITE THAT FEATURES AN ON-LINE MARKET FOR USERS TO LIST OFFERED OR WANTED PERSONAL AND BUSINESS ASSETS AND SKILLS FOR HIRE, RENT, SALE OR AUCTION TRANSACTED ON THE BASIS OF PREDEFINED PERFORMANCE AND CLOSING TERMS AND CONDITIONS; PROVIDING AN INTERACTIVE WEB SITE THAT FACILITATES THE PREPARATION OF RESUMES; PROVIDING AN ON-LINE SEARCHABLE DATABASE FEATURING CLASSIFIED AD LISTINGS AND EMPLOYMENT OPPORTUNITIES; PROVIDING CAREER INFORMATION; PROVIDING INFORMATION ON THE TOPIC OF DETERMINING JOB SATISFACTION; PROVIDING ON-LINE DIRECTORY INFORMATION SERVICES ALSO FEATURING HYPERLINKS TO OTHER WEB SITES (U.S. CLS. 100, 101 AND 102).

JIM RINGLE, EXAMINING ATTORNEY



OWNER OF U.S. REG. NOS. 2,648,019 AND 3,010,264. THE MARK CONSISTS OF THE WORD "ABT" UNDERSCORED BY A BOLT OF LIGHTNING.

FOR ON-LINE RETAIL STORE SERVICES FEATURING CONSUMER ELECTRONICS AND APPLIANCES (U.S. CLS. 100, 101 AND 102).

FIRST USE 7-7-1997; IN COMMERCE 7-7-1997.

KEVON CHISOLM, EXAMINING ATTORNEY

SN 77-568,578. METALLURG VANADIUM CORPORATION, CAMBRIDGE, OH. FILED 9-12-2008.

METGREEN

THE MARK CONSISTS OF STANDARD CHARACTERS WITHOUT CLAIM TO ANY PARTICULAR FONT, STYLE, SIZE, OR COLOR.

FOR DISTRIBUTORSHIPS IN THE FIELD OF METAL ALLOYS AND SPECIALTY METAL PRODUCTS (U.S. CLS. 100, 101 AND 102).

BARBARA BROWN, EXAMINING ATTORNEY

CLASS 35—(Continued).

SN 77-570,082. FILL-N-THRILL, LLC, ST. CHARLES, MO. FILED 9-15-2008.

NEIGHBORHOOD TV NETWORK

THE MARK CONSISTS OF STANDARD CHARACTERS WITHOUT CLAIM TO ANY PARTICULAR FONT, STYLE, SIZE, OR COLOR.

NO CLAIM IS MADE TO THE EXCLUSIVE RIGHT TO USE "TV NETWORK", APART FROM THE MARK AS SHOWN.

FOR DISSEMINATION OF ADVERTISING FOR OTHERS VIA AN ONLINE ELECTRONIC COMMUNICATIONS NETWORK; RENTAL OF ADVERTISING SPACE; CREATING, COMPILING AND DISSEMINATING ADVERTISING MATTER FOR OTHERS THROUGH AUDIO-VISUAL DISPLAYS; AND ADVERTISING SERVICES, NAMELY, PREPARING AUDIO-VISUAL DISPLAYS IN THE FIELD OF ADVERTISING NEWS (U.S. CLS. 100, 101 AND 102).

TASNEEM HUSSAIN, EXAMINING ATTORNEY

SN 77-570,250. SPECKOZ, INC., ALPHARETTA, GA. FILED 9-15-2008.

THE POWER OF PARTNERSHIP

THE MARK CONSISTS OF STANDARD CHARACTERS WITHOUT CLAIM TO ANY PARTICULAR FONT, STYLE, SIZE, OR COLOR.

FOR DISTRIBUTORSHIP SERVICES IN THE FIELD OF PEST CONTROL PRODUCTS (U.S. CLS. 100, 101 AND 102).

FIRST USE 6-25-2008; IN COMMERCE 6-25-2008.
KIM SAITO, EXAMINING ATTORNEY

SN 77-571,628. BLACK BOATERS CLUB OF AMERICA, RIVERDALE, GA. FILED 9-16-2008.



NO CLAIM IS MADE TO THE EXCLUSIVE RIGHT TO USE "BLACK BOATERS CLUB OF AMERICA", APART FROM THE MARK AS SHOWN.

THE STIPPLING IS FOR SHADING PURPOSES ONLY.

THE MARK CONSISTS OF THE STYLIZED TEXT "BBCA BLACK BOATERS CLUB OF AMERICA" WITH A SHIP AND A FLAG ON THE LEFT.

FOR CLUB SERVICES, NAMELY, PROMOTING THE INTERESTS OF BOATING ENTHUSIASTS (U.S. CLS. 100, 101 AND 102).

FIRST USE 1-15-2008; IN COMMERCE 1-15-2008.
GINA FINK, EXAMINING ATTORNEY

CLASS 35—(Continued).

SN 77-572,674. MALTESE PROCESS MANAGEMENT, LLC, SPRINGFIELD, PA. FILED 9-17-2008.

The Bridge To Better Business

THE MARK CONSISTS OF STANDARD CHARACTERS WITHOUT CLAIM TO ANY PARTICULAR FONT, STYLE, SIZE, OR COLOR.

FOR CONSULTATION SERVICES IN THE FIELD OF PROCESS MANAGEMENT (U.S. CLS. 100, 101 AND 102).
ESTHER BELENKER, EXAMINING ATTORNEY

SN 77-572,897. THE OFFICE GURUS, LTDA DE C.V., SAN SALVADOR, EL SALVADOR, FILED 9-18-2008.



THE COLOR(S) BLACK, BLUE, GRAY AND WHITE IS/ ARE CLAIMED AS A FEATURE OF THE MARK.

"THE OFFICE GURUS" IS IN BLACK; THE "O" IN "OFFICE" IS A GLOBE OF THE EARTH WITH THE OCEANS IN BLUE AND THE LAND IN SHADES OF GRAY, OUTLINED IN BLACK; THE COMPUTER MOUSE IS GRAY AND WHITE; THE CORD IS BLACK.

FOR BUSINESS PROCESS OUTSOURCING SERVICES IN THE FIELD OF BUSINESS ASSISTANCE TO A WIDE VARIETY OF BUSINESSES, FEATURING ORDER ENTRY, INVENTORY CONTROL, CUSTOMER SERVICE, ACCOUNTING, AND OTHER ADMINISTRATIVE AND BACK OFFICE TASKS (U.S. CLS. 100, 101 AND 102).

FIRST USE 11-24-2008; IN COMMERCE 11-24-2008.
PAUL E. FAHRENKOPF, EXAMINING ATTORNEY

SN 77-575,221. ADAM N SUMMERS, GLEN BURNIE, MD. FILED 9-21-2008.

PowerRating

THE MARK CONSISTS OF STANDARD CHARACTERS WITHOUT CLAIM TO ANY PARTICULAR FONT, STYLE, SIZE, OR COLOR.

FOR PROVIDING INFORMATION ABOUT AND MAKING REFERRALS IN THE FIELD OF CONSUMER PRODUCTS AND SERVICES FOR RETAIL SERVICES CONCERNING PRODUCTS, SERVICES, EVENTS, ACTIVITIES, ATTRACTIONS AND FACILITIES IN PARTICULAR GEOGRAPHIC LOCATIONS (U.S. CLS. 100, 101 AND 102).

FIRST USE 1-7-2008; IN COMMERCE 7-1-2008.
BARBARA BROWN, EXAMINING ATTORNEY

CLASS 35—(Continued).

SN 77-575,665. SUPERVALU INC., EDEN PRAIRIE, MN. FILED 9-22-2008.



THE MARK CONSISTS OF THE TIME OF "4:15" USING THE NUMBER "4", THE DOLLAR SIGN AND CLOCK, AND THE NUMBER "15".

FOR RETAIL GROCERY STORE SERVICES (U.S. CLS. 100, 101 AND 102).

JILL PRATER, EXAMINING ATTORNEY

SN 77-576,087. OWEN, AARON L., SAN BERNADINO, CA. FILED 9-22-2008.



BAND OF ANGELS

THE MARK CONSISTS OF THE WORDS "BAND OF ANGELS" BENEATH THE DRAWING OF A HEART WITH WINGS.

FOR RETAIL STORE SERVICE AND WHOLESALE DISTRIBUTORSHIP SERVICE FEATURING JEWELRY (U.S. CLS. 100, 101 AND 102).

JESSICA A. POWERS, EXAMINING ATTORNEY

SN 77-579,444. TOTAL SYSTEM SERVICES, INC., COLUMBUS, GA. FILED 9-26-2008.



NO CLAIM IS MADE TO THE EXCLUSIVE RIGHT TO USE "REWARDS.COM", APART FROM THE MARK AS SHOWN.

THE MARK CONSISTS OF THE WORDING "POINT-QUEST REWARDS.COM" AND THE DESIGN OF A PACKAGE TIED WITH A RIBBON TO THE LEFT OF THE TERM "POINTQUEST".

FOR PROMOTING THE GOODS AND SERVICES OF OTHERS THROUGH THE ADMINISTRATION OF INCENTIVE REWARDS PROGRAMS; ADMINISTRATION OF INCENTIVE REWARDS PROGRAMS FOR OTHERS (U.S. CLS. 100, 101 AND 102).

KEVIN DINALLO, EXAMINING ATTORNEY

CLASS 35—(Continued).

SN 77-580,393. 24HOURBOOK, DBA HIBOOTH, SAN DIEGO, CA. FILED 9-26-2008.



NO CLAIM IS MADE TO THE EXCLUSIVE RIGHT TO USE "BOOTH", APART FROM THE MARK AS SHOWN.

THE COLOR(S) WHITE, ORANGE, AND BLUE IS/ARE CLAIMED AS A FEATURE OF THE MARK.

THE MARK CONSISTS OF "HI" IN WHITE IN AN ORANGE SQUARE WITH AN ORANGE SHADOW WITH THE "I" AS A STICK FIGURE. THE WORDING "BOOTH" AND "CREATE YOUR OWN OPPORTUNITIES" ARE IN BLUE.

FOR ADVERTISING, MARKETING, AND PROMOTING THE GOODS AND SERVICES OF OTHERS THROUGH AN INTERNET BASED VIRTUAL BOOTH; EMPLOYMENT HIRING, RECRUITING, PLACEMENT, STAFFING AND CAREER NETWORKING SERVICES THROUGH AN INTERNET BASED VIRTUAL BOOTH (U.S. CLS. 100, 101 AND 102).

FIRST USE 8-26-2008; IN COMMERCE 8-26-2008.

KAPIL BHANOT, EXAMINING ATTORNEY

SN 77-583,264. HEWLETT-PACKARD DEVELOPMENT COMPANY, L.P., HOUSTON, TX. FILED 10-1-2008.

DIGITAL OASIS

THE MARK CONSISTS OF STANDARD CHARACTERS WITHOUT CLAIM TO ANY PARTICULAR FONT, STYLE, SIZE, OR COLOR.

NO CLAIM IS MADE TO THE EXCLUSIVE RIGHT TO USE "DIGITAL", APART FROM THE MARK AS SHOWN.

FOR MARKETING AND PROMOTIONAL PROGRAM SERVICES IN THE FIELD OF ELECTRONIC MULTI-MEDIA PRODUCTS (U.S. CLS. 100, 101 AND 102).

MORGAN WYNNE, EXAMINING ATTORNEY

SN 77-584,354. SUPERVALU INC., EDEN PRAIRIE, MN. FILED 10-2-2008.

MORE WAYS TO SAVE

THE MARK CONSISTS OF STANDARD CHARACTERS WITHOUT CLAIM TO ANY PARTICULAR FONT, STYLE, SIZE, OR COLOR.

FOR RETAIL GROCERY STORE SERVICES (U.S. CLS. 100, 101 AND 102).

FIRST USE 12-31-2004; IN COMMERCE 12-31-2004.

JILL PRATER, EXAMINING ATTORNEY

CLASS 35—(Continued).

SN 77-585,090. NATIONAL ACADEMY OF RECORDING ARTS & SCIENCES, INC., SANTA MONICA, CA. FILED 10-3-2008.



OWNER OF U.S. REG. NOS. 1,018,537, 3,533,789 AND OTHERS.

THE MARK CONSISTS OF A CIRCLE, INSIDE OF THE CIRCLE IS AN OUTLINE OF THE U.S. CAPITOL DOME, INSIDE OF THE OUTLINE OF THE U.S. CAPITOL DOME IS AN OUTLINE OF A GRAMOPHONE.

FOR PUBLIC ADVOCACY TO PROMOTE AWARENESS OF THE RIGHTS OF THE MUSIC COMMUNITY (U.S. CLS. 100, 101 AND 102).

FIRST USE 11-0-2007; IN COMMERCE 11-0-2007.
COLLEEN DOMBROW, EXAMINING ATTORNEY

SN 77-588,038. DIRECT GENERAL CORPORATION, NASHVILLE, TN. FILED 10-8-2008.

THE MARK CONSISTS OF THE STYLIZED WORD "DIRECT".

FOR INCOME TAX CONSULTATION; INCOME TAX PREPARATION (U.S. CLS. 100, 101 AND 102).

FIRST USE 10-6-2008; IN COMMERCE 10-6-2008.
JILL PRATER, EXAMINING ATTORNEY

SN 77-592,671. ASSOCIATED WHOLESALE GROCERS, INC., KANSAS CITY, KS. FILED 10-14-2008.

PUMP&CENTS

THE MARK CONSISTS OF STANDARD CHARACTERS WITHOUT CLAIM TO ANY PARTICULAR FONT, STYLE, SIZE, OR COLOR.

FOR RETAIL STORE SERVICES FEATURING MOTOR FUEL; PROMOTING THE GOODS AND SERVICES OF OTHERS BY OFFERING DISCOUNTS ON THE PRICE OF MOTOR FUEL TO PURCHASERS OF THOSE GOODS (U.S. CLS. 100, 101 AND 102).

FIRST USE 7-14-2008; IN COMMERCE 7-14-2008.
BRIAN NEVILLE, EXAMINING ATTORNEY

CLASS 35—(Continued).

SN 77-592,679. ASSOCIATED WHOLESALE GROCERS, INC., KANSAS CITY, KS. FILED 10-14-2008.



THE MARK CONSISTS OF GASOLINE PUMP CHARACTER.

FOR RETAIL STORE SERVICES FEATURING MOTOR FUEL; PROMOTING THE GOODS AND SERVICES OF OTHERS BY OFFERING DISCOUNTS ON THE PRICE OF MOTOR FUEL TO PURCHASERS OF THOSE GOODS (U.S. CLS. 100, 101 AND 102).

FIRST USE 7-14-2008; IN COMMERCE 7-14-2008.
BRIAN NEVILLE, EXAMINING ATTORNEY

SN 77-593,901. 2187291 ONTARIO INC., MISSISSAUGA, CANADA, FILED 10-16-2008.

COTTON GINNY KIDS

THE MARK CONSISTS OF STANDARD CHARACTERS WITHOUT CLAIM TO ANY PARTICULAR FONT, STYLE, SIZE, OR COLOR.

NO CLAIM IS MADE TO THE EXCLUSIVE RIGHT TO USE "KIDS", APART FROM THE MARK AS SHOWN.

FOR DISTRIBUTORSHIP, RETAIL STORE AND ONLINE RETAIL STORE SERVICES FEATURING CLOTHING AND ACCESSORIES FOR MEN, WOMEN AND CHILDREN (U.S. CLS. 100, 101 AND 102).

IRA J. GOODSaid, EXAMINING ATTORNEY

SN 77-593,927. 2187291 ONTARIO INC., MISSISSAUGA, CANADA, FILED 10-16-2008.

COTTON GINNY PLUS

THE MARK CONSISTS OF STANDARD CHARACTERS WITHOUT CLAIM TO ANY PARTICULAR FONT, STYLE, SIZE, OR COLOR.

FOR DISTRIBUTORSHIP, RETAIL STORE AND ONLINE RETAIL STORE SERVICES FEATURING CLOTHING AND ACCESSORIES FOR MEN, WOMEN AND CHILDREN (U.S. CLS. 100, 101 AND 102).

IRA J. GOODSaid, EXAMINING ATTORNEY

CLASS 35—(Continued).

SN 77-593,946. 2187291 ONTARIO INC., MISSISSAUGA, CANADA, FILED 10-16-2008.

COTTON GINNY NATURALLY

THE MARK CONSISTS OF STANDARD CHARACTERS WITHOUT CLAIM TO ANY PARTICULAR FONT, STYLE, SIZE, OR COLOR.

FOR DISTRIBUTORSHIP, RETAIL STORE AND ON-LINE RETAIL STORE SERVICES FEATURING CLOTHING AND ACCESSORIES FOR MEN, WOMEN AND CHILDREN (U.S. CLS. 100, 101 AND 102).

IRA J. GOODSaid, EXAMINING ATTORNEY

CLASS 35—(Continued).

SN 77-606,199. SUPERVALU INC., EDEN PRAIRIE, MN. FILED 11-3-2008.

INDEPENDENT MINDED

THE MARK CONSISTS OF STANDARD CHARACTERS WITHOUT CLAIM TO ANY PARTICULAR FONT, STYLE, SIZE, OR COLOR.

FOR BUSINESS CONSULTING SERVICES IN THE RETAIL GROCERY STORE FIELD, NAMELY, PROVIDE SUPPORT AND HELP TO DEVELOP THE BUSINESS; AND, ASSIST WITH MERCHANDISING PROGRAMS AND MARKETING SERVICES (U.S. CLS. 100, 101 AND 102).

JILL PRATER, EXAMINING ATTORNEY

SN 77-595,257. DENTSPLY INTERNATIONAL INC., YORK, PA. FILED 10-17-2008.



THE MARK CONSISTS OF A WINGED CHARACTER WEARING DENTAL HYGIENIST SCRUBS.

FOR ON-LINE RETAIL STORE SERVICES FEATURING DENTAL AND X-RAY PRODUCTS; RETAIL SERVICES BY DIRECT SOLICITATION BY SALES AGENTS IN THE FIELD OF DENTAL AND X-RAY PRODUCTS (U.S. CLS. 100, 101 AND 102).

HENRY S. ZAK, EXAMINING ATTORNEY

SN 78-845,563. BATH & BODY WORKS BRAND MANAGEMENT, INC., REYNOLDSBURG, OH. FILED 3-24-2006.

YOU LUCKY DUCK

THE MARK CONSISTS OF STANDARD CHARACTERS WITHOUT CLAIM TO ANY PARTICULAR FONT, STYLE, SIZE, OR COLOR.

FOR RETAIL STORE SERVICES, MAIL ORDER RETAIL SERVICES AND ONLINE RETAIL STORE SERVICES ALL IN THE FIELD OF PERSONAL CARE PRODUCTS, COSMETICS, HOME FRAGRANCE PRODUCTS AND ACCESSORIES, AND RETAIL STORE SERVICES IN THE FIELD OF PERSONAL CARE, HOME FRAGRANCE AND ACCESSORY PRODUCTS FEATURING A BONUS INCENTIVE PROGRAM FOR CUSTOMERS (U.S. CLS. 100, 101 AND 102).

KATHERINE M. DUBRAY, EXAMINING ATTORNEY

SN 77-602,793. SUPERVALU INC., EDEN PRAIRIE, MN. FILED 10-29-2008.

FLAVORS YOU CRAVE

THE MARK CONSISTS OF STANDARD CHARACTERS WITHOUT CLAIM TO ANY PARTICULAR FONT, STYLE, SIZE, OR COLOR.

FOR RETAIL GROCERY STORE SERVICES (U.S. CLS. 100, 101 AND 102).

JILL PRATER, EXAMINING ATTORNEY

SN 79-057,579. XAVIER BRUNET I PALOU, SPAIN, FILED 4-29-2008.



PRIORITY DATE OF 4-16-2008 IS CLAIMED. OWNER OF INTERNATIONAL REGISTRATION 0973816 DATED 4-29-2008, EXPIRES 4-29-2018.

THE COLOR(S) GREEN AND BLACK IS/ARE CLAIMED AS A FEATURE OF THE MARK.

THE MARK CONSISTS OF THE COLORS GREEN AND BLACK, WITH THE COLOR GREEN APPEARING IN THE THREE-QUADRILATERAL DESIGN AT THE LEFT OF THE MARK, AND IN THE LETTER "M" IN THE WORDING "DECOMAT", COMPRISING TWO VERTICAL QUADRILATERALS. THE REMAINDER OF THE WORDING "DECOMAT" APPEARS IN BLACK.

THE WORDING "DECOMAT" IN THE MARK HAS NO ANY MEANING IN A FOREIGN LANGUAGE.

FOR RETAIL OUTLET SERVICES FEATURING FURNITURE, TEXTILE ARTICLES FOR THE HOME, DECORATIVE PRODUCTS AND LIGHTING FIXTURES (U.S. CLS. 100, 101 AND 102).

MARK PILARO, EXAMINING ATTORNEY

CLASS 36—INSURANCE AND FINANCIAL

SN 76-685,863. ARGENT MANAGEMENT CO., LLC, GREENWICH, CT. FILED 1-17-2008.



FOR FINANCIAL AND MONETARY SERVICES, NAMELY, INVESTMENT TRUST OPERATIONS FOR HOLDING COMPANIES (U.S. CLS. 100, 101 AND 102).
FIRST USE 5-23-2007; IN COMMERCE 5-23-2007.
EMILY CARLSEN, EXAMINING ATTORNEY

SN 76-691,963. ALZHEIMER'S FOUNDATION OF AMERICA, INC., NEW YORK, NY. FILED 8-12-2008.

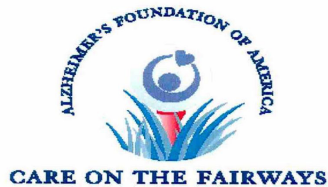

OWNER OF U.S. REG. NOS. 3,099,830 AND 3,209,517.
NO CLAIM IS MADE TO THE EXCLUSIVE RIGHT TO USE "ALZHEIMERS FOUNDATION OF AMERICA", APART FROM THE MARK AS SHOWN.

THE COLOR(S) BLUE AND RED IS/ARE CLAIMED AS A FEATURE OF THE MARK.

THE MARK CONSISTS OF BLUE BLADES OF GRASS AND A RED GOLF TEE WITH A BLUE FIGURE HOLDING A BLUE HEART MADE TO LOOK LIKE THE SHAPE OF A GOLF BALL. THE WORDING, "CARE ON THE FAIRWAYS" APPEARS IN BLUE BENEATH THE DESIGN AND THE WORDING, "ALZHEIMERS FOUNDATION OF AMERICA", IN BLUE APPEARS ABOVE THE DESIGN.

FOR CHARITABLE FUNDRAISING, NAMELY, ORGANIZING AND CONDUCTING AN ANNUAL FUNDRAISING EVENT TO RAISE AWARENESS OF AND SUPPORT TREATMENT OF ALZHEIMER'S DISEASE OR RELATED DEMENTIAS (U.S. CLS. 100, 101 AND 102).
FIRST USE 6-1-2005; IN COMMERCE 6-1-2005.

ROBIN CHOSID, EXAMINING ATTORNEY

CLASS 36—(Continued).

SN 76-691,987. IMPERIAL COMMUNITY FINANCIAL CORPORATION, WASHINGTON, DC. FILED 8-12-2008.

IMPERIAL COMMUNITY BANK

THE MARK CONSISTS OF STANDARD CHARACTERS WITHOUT CLAIM TO ANY PARTICULAR FONT, STYLE, SIZE, OR COLOR.

NO CLAIM IS MADE TO THE EXCLUSIVE RIGHT TO USE "COMMUNITY BANK", APART FROM THE MARK AS SHOWN.

FOR INDIVIDUAL, COMMERCIAL AND SMALL BUSINESS BANKING, INVESTMENT AND FINANCIAL SERVICES, NAMELY, CHECKING ACCOUNTS, SAVINGS ACCOUNTS, INDIVIDUAL RETIREMENT ACCOUNTS, ISSUING CERTIFICATES OF DEPOSIT, SWEEP ACCOUNTS, PROVIDING SECURED AND UNSECURED PERSONAL LINES OF CREDIT, CONSUMER LOANS, RESIDENTIAL AND COMMERCIAL MORTGAGE LOANS, HOME EQUITY LOANS AND LINES OF CREDIT, CREDIT AND DEBIT CARD SERVICES, PROVIDING COMMERCIAL AND SMALL BUSINESS LOANS INCLUDING LINES OF CREDIT, CONSTRUCTION AND LAND DEVELOPMENT LOANS, CASH MANAGEMENT SERVICES, FINANCIAL CLEARING HOUSE SERVICES, NAMELY, AUTOMATED CLEARINGHOUSE ORIGINATOR SERVICES, MONEY WIRE TRANSFER SERVICES, NIGHT DEPOSITORY SERVICES, DISTRIBUTION OF ANNUITIES, BILL PAYMENT SERVICES, TRUST SERVICES, NAMELY, INVESTMENT AND TRUST COMPANY SERVICES, RETIREMENT PLANNING AND REMOTE DEPOSIT CAPTURE SERVICES, AND PROVIDING ALL OF THE FOREGOING SERVICES BY TRADITIONAL METHODS, BY TELEPHONE, AND BY A GLOBAL COMPUTER NETWORK, AND SAFE DEPOSIT BOX RENTAL (U.S. CLS. 100, 101 AND 102).

ALLISON HALL, EXAMINING ATTORNEY

SN 76-692,033. UNITED SERVICES OF AMERICA FEDERAL CREDIT UNION, SAN DIEGO, CA. FILED 8-13-2008.



OWNER OF U.S. REG. NOS. 1,481,042, 2,991,387 AND OTHERS.

NO CLAIM IS MADE TO THE EXCLUSIVE RIGHT TO USE "FED", APART FROM THE MARK AS SHOWN.

THE MARK CONSISTS OF A DESIGN COMPRISING A STAR AND STRIPES WITH THE WORDING "USA FED" UNDERNEATH THE DESIGN.

SEC. 2(F) AS TO "USA".

FOR CREDIT UNION SERVICES AND CONSUMER AND COMMERCIAL LENDING SERVICES (U.S. CLS. 100, 101 AND 102).

FIRST USE 5-5-2008; IN COMMERCE 5-5-2008.

JACLYN KIDWELL, EXAMINING ATTORNEY

CLASS 36—(Continued).

SN 76-692,354. IAT REINSURANCE COMPANY, LTD., HAMILTON, HMII, BERMUDA, FILED 8-25-2008.

IAT Reinsurance Group

THE MARK CONSISTS OF STANDARD CHARACTERS WITHOUT CLAIM TO ANY PARTICULAR FONT, STYLE, SIZE, OR COLOR.

NO CLAIM IS MADE TO THE EXCLUSIVE RIGHT TO USE "REINSURANCE GROUP", APART FROM THE MARK AS SHOWN.

FOR REINSURANCE UNDERWRITING (U.S. CLS. 100, 101 AND 102).

FIRST USE 1-0-2002; IN COMMERCE 1-0-2002.

ESTHER BELENKER, EXAMINING ATTORNEY

CLASS 36—(Continued).

SN 77-228,081. ZAIS GROUP, LLC, RED BANK, NJ. FILED 7-12-2007.

ZAIS

THE MARK CONSISTS OF STANDARD CHARACTERS WITHOUT CLAIM TO ANY PARTICULAR FONT, STYLE, SIZE, OR COLOR.

OWNER OF U.S. REG. NO. 3,355,069.

SEC. 2(F).

FOR FINANCIAL ANALYSIS AND CONSULTATION; FINANCIAL CONSULTATION; FINANCIAL DUE DILIGENCE; FINANCIAL FORECASTING; FINANCIAL INFORMATION PROVIDED BY ELECTRONIC MEANS; FINANCIAL INFORMATION PROCESSING; FINANCIAL INVESTMENT IN THE FIELDS OF SECURITIES AND REAL ESTATE; FINANCIAL MANAGEMENT; FINANCIAL PORTFOLIO MANAGEMENT; FINANCIAL RESEARCH; FINANCIAL RISK MANAGEMENT; FINANCIAL SERVICES, NAMELY, PROVIDING INFORMATION IN THE FIELDS OF FOREIGN CURRENCY, COMMODITIES, FINANCIAL DERIVATIVES, INTEREST RATE PRODUCTS AND EQUITIES VIA THE INTERNET AND INTRANET SYSTEMS; INVESTMENT ADVICE (U.S. CLS. 100, 101 AND 102).

FIRST USE 10-1-1997; IN COMMERCE 10-1-1997.

JEFF DEFORD, EXAMINING ATTORNEY

SN 77-008,487. THE RICH MATTESON FOUNDATION, INC., JACKSONVILLE, FL. FILED 9-27-2006.



NO CLAIM IS MADE TO THE EXCLUSIVE RIGHT TO USE "FOUNDATION", APART FROM THE MARK AS SHOWN.

"RICH MATTESON" DOES NOT IDENTIFY A LIVING INDIVIDUAL.

FOR PROVIDING EDUCATIONAL SCHOLARSHIPS IN THE FIELD OF JAZZ MUSIC (U.S. CLS. 100, 101 AND 102).

FIRST USE 9-1-2003; IN COMMERCE 9-1-2003.

SIMON TENG, EXAMINING ATTORNEY

SN 77-256,788. F.N.B. CORPORATION, HERMITAGE, PA. FILED 8-16-2007.

MADE FOR ME CHECKING

THE MARK CONSISTS OF STANDARD CHARACTERS WITHOUT CLAIM TO ANY PARTICULAR FONT, STYLE, SIZE, OR COLOR.

NO CLAIM IS MADE TO THE EXCLUSIVE RIGHT TO USE "CHECKING", APART FROM THE MARK AS SHOWN.

FOR DEPOSITORY SERVICES, NAMELY, ADMINISTRATION OF HOLIDAY AND VACATION CLUB ACCOUNTS, AUTOMATED TELLER MACHINE SERVICES; BANKING SERVICES; CHECKING ACCOUNT SERVICES; CREDIT CARD SERVICES, DEBIT CARD SERVICES; BANKING SERVICES, NAMELY, DIRECT DEPOSIT SERVICES, ELECTRONIC INTERACTIVE BANKING SERVICES, FINANCIAL INFORMATION PROVIDED BY ELECTRONIC MEANS, FINANCIAL MANAGEMENT SERVICES, FINANCIAL CLEARING HOUSE SERVICES, FINANCIAL GUARANTEE AND SURETY SERVICES, FINANCIAL VALUATION OF PERSONAL PROPERTY AND REAL ESTATE, FINANCIAL ANALYSIS AND CONSULTATION, FINANCIAL FORECASTING SERVICES, FINANCIAL EXCHANGE SERVICES, FINANCIAL PORTFOLIO MANAGEMENT, FINANCIAL PLANNING, FINANCING SERVICES, FINANCING FOR LOW AND MODERATE INCOME PERSONS, HOME EQUITY LOANS, PROVIDING INDIVIDUAL RETIREMENT ACCOUNTS, PROVIDING SELF EMPLOYED QUALIFIED RETIREMENT PLANS, INTERNET BANKING SERVICES, INTERNET BILL PAYMENT, LEASE-PURCHASE FINANCING, LENDING SERVICES, NAMELY, MORTGAGE, CONSUMER, RETAIL AND COMMERCIAL LOANS, LOAN FINANCING, MONEY MARKET ACCOUNT SERVICES, NIGHT DEPOSIT BOX SERVICES, PROVIDING FINANCIAL INFORMATION IN THE NATURE OF RATES OF EXCHANGE, REMOTE DEPOSIT SERVICES, RENT SE-

CLASS 36—(Continued).

CURITY ACCOUNTS, SAFE DEPOSIT BOX SERVICES, SAVINGS ACCOUNT SERVICES, TELEPHONE BANKING SERVICES, WIRE TRANSFER SERVICES OF MONEY, INFORMATION SERVICES FOR ALL OF THE FOREGOING PROVIDED VIA A GLOBAL COMPUTER NETWORK; FINANCIAL ADVICE AND BROKERAGE SERVICES IN CONNECTION WITH INDIVIDUAL RETIREMENT ACCOUNTS; FINANCIAL ADVICE AND BROKERAGE SERVICES IN CONNECTION WITH SELF EMPLOYED QUALIFIED RETIREMENT PLANS; CAPITAL INVESTMENT CONSULTATION AND ADVICE; CAPITAL INVESTMENT SERVICES; FINANCIAL INFORMATION PROVIDED BY ELECTRONIC/INTERACTIVE MEANS; ELECTRONIC FINANCIAL PLANNING AND BANKING SERVICES; FINANCIAL INVESTMENT ADVICE AND CONSULTATION; FINANCIAL PORTFOLIO MANAGEMENT; FINANCIAL PLANNING; FINANCIAL INFORMATION PROVIDED BY ELECTRONIC MEANS; FINANCIAL RESEARCH; FINANCIAL VALUATION OF INVESTMENT PORTFOLIO; FINANCIAL INFORMATION IN THE NATURE OF RATES OF EXCHANGE, FINANCIAL EXCHANGE, FINANCIAL INFORMATION IN THE NATURE OF FINANCIAL FORECASTING AND FINANCIAL GUARANTEE AND SURETY, FINANCIAL ANALYSIS AND CONSULTATION; FINANCIAL AND INVESTMENT MANAGEMENT; FUND INVESTMENT CONSULTATION; FUNDS INVESTMENT; INDIVIDUAL INVESTMENT ADVISORY SERVICES; INVESTMENT ADVICE AND BROKERAGE SERVICES IN THE FIELD OF FIXED AND VARIABLE ANNUITIES; INTERNET INVESTMENT AND BROKERAGE SERVICES, INVESTMENT ADVICE, INVESTMENT CONSULTATION, INVESTMENT MANAGEMENT, INVESTMENT ADVICE AND BROKERAGE SERVICES IN THE FIELD OF MUTUAL FUNDS AND SECURITIES; MANAGEMENT AND ADMINISTRATION OF DEFINED BENEFIT PLANS, PROFIT SHARING PLANS AND NON-QUALIFIED RETIREMENT PLANS; ADMINISTRATION OF MUNICIPAL AND COUNTY GOVERNMENT EMPLOYEE PENSION SERVICES; MUTUAL FUND BROKERAGE, DISTRIBUTION AND INVESTMENT SERVICES; FINANCIAL RISK MANAGEMENT AND CONSULTATION AND PLANNING IN THE FIELDS OF HEALTH CARE, DISABILITY, LONG-TERM CARE AND LIFE INSURANCE; SECURITIES BROKERAGE SERVICES, STOCK AND BOND PORTFOLIO MANAGEMENT AND ADVICE, INFORMATION SERVICES FOR ALL OF THE FOREGOING PROVIDED VIA A GLOBAL COMPUTER NETWORK; CONSUMER FINANCING SERVICES AND LOAN FINANCING; ELECTRONIC CONSUMER FINANCE SERVICES; FINANCIAL VALUATION OF PERSONAL PROPERTY AND REAL ESTATE; FINANCING HOUSING FOR MODERATE INCOME CITIZENS; INTERNET CONSUMER FINANCING SERVICES; LEASE-PURCHASE FINANCING; LENDING SERVICES, NAMELY, MORTGAGE, CONSUMER, RETAIL AND COMMERCIAL LOANS, LOAN FINANCING, BROKERAGE OF SUBORDINATED NOTES, NAMELY, SHORT-TERM DEBT SECURITIES, CASH FLOW SERVICES, NAMELY, PROVIDING CASH TO MORTGAGE NOTE HOLDERS IN RETURN FOR OWNERSHIP OF THE NOTE; INFORMATION SERVICES FOR ALL OF THE FOREGOING PROVIDED VIA A GLOBAL COMPUTER NETWORK; INSURANCE ACTUARIAL SERVICES INCLUDING APPRAISAL, ADMINISTRATION, AGENCY, BROKERAGE, CONSULTATION, AND SUBROGATION IN THE FIELDS OF AUTO, LIFE, HEALTH, LONG TERM CARE, PROPERTY, CASUALTY, ACCIDENT, FIRE, MARINE, MEDICAL, PRE-PAID HEALTH-CARE; APPRAISALS AND EVALUATION OF INSURANCE COVERAGES OF PERSONAL PROPERTY AND REAL ESTATE; INFORMATION SERVICES FOR ALL OF THE FOREGOING PROVIDED VIA A GLOBAL COMPUTER NETWORK; BUSINESS SUCCESSOR'S FINANCIAL PLANNING; FINANCIAL PLANNING FOR RETIREMENT; MAINTAINING AND ADMINISTERING CORPORATE ESCROW SERVICES AND CUSTODIAL SERVICES; CORPORATE TRUST AND BOND TRANSFER AGENCY SERVICES; FINANCIAL DEPOSITORY SERVICES RELATED TO TRUST AND BENEFIT ACCOUNTS; EDUCATION FINANCIAL PLANNING; PROVIDING EDUCATIONAL FUNDING IN THE NATURE OF (529) ACCOUNTS; ELECTRONIC INTERACTIVE FINANCIAL TRUST MANAGEMENT ACCOUNT SERVICES; FINANCIAL ADMINISTRATION OF EMPLOYER RETIREMENT ACCOUNTS; ESTATE PLANNING; TRUST MANAGEMENT ACCOUNTS SERVICES AS

CLASS 36—(Continued).

TRUSTEE, EXECUTOR AND TRUST UNDER WILL; ESTATE PLANNING SERVICES INCLUDING LIVING, TESTAMENTARY AND CHARITABLE REMAINDER TRUSTS; ESTATE PLANNING, SETTLEMENT AND ADMINISTRATION; FIDUCIARY REPRESENTATIVE SERVICES AND TRUST ADMINISTRATION; FINANCIAL MANAGEMENT IN THE NATURE OF INSTITUTIONAL CUSTODIAL SERVICES; INTERNET TRUST MANAGEMENT ACCOUNT SERVICES; ESTATE PLANNING FOR TAX DEDUCTION AND GIFTING PROGRAMS; TRUST SERVICES, NAMELY, INVESTMENT AND TRUST COMPANY SERVICES; AND INFORMATION SERVICES FOR ALL OF THE FOREGOING PROVIDED VIA A GLOBAL COMPUTER NETWORK (U.S. CLS. 100, 101 AND 102).

AMY HELLA, EXAMINING ATTORNEY

SN 77-282,366. EDITH P WRIGHT BREAST CANCER FOUNDATION INC., LANDOVER, MD. FILED 9-18-2007.



EDITH P. WRIGHT
BREAST CANCER
FOUNDATION

NO CLAIM IS MADE TO THE EXCLUSIVE RIGHT TO USE "BREAST CANCER FOUNDATION", APART FROM THE MARK AS SHOWN.

THE NAME(S), PORTRAIT(S), AND/OR SIGNATURE(S) SHOWN IN THE MARK DOES NOT IDENTIFY A PARTICULAR LIVING INDIVIDUAL.

THE MARK CONSISTS OF THE WORDS "EDITH P. WRIGHT BREAST CANCER FOUNDATION" WITH A MUSICAL NOTATION.

FOR CHARITABLE FUNDRAISING SERVICES; CHARITABLE SERVICES, NAMELY, PROVIDING FINANCIAL ASSISTANCE PROGRAMS FOR INDIVIDUALS UNDERGOING BREAST CANCER TREATMENT (U.S. CLS. 100, 101 AND 102).

DAVID MURRAY, EXAMINING ATTORNEY

CLASS 36—(Continued).

SN 77-306,547. ING DIRECT BANCORP, WILMINGTON, DE. FILED 10-17-2007.

CreditGlance

THE MARK CONSISTS OF STANDARD CHARACTERS WITHOUT CLAIM TO ANY PARTICULAR FONT, STYLE, SIZE, OR COLOR.

FOR FINANCIAL SERVICES IN THE NATURE OF CREDIT MODELING, NAMELY, THE EVALUATION OF CREDIT AND OTHER DATA AS CREDIT RISK PREDICTORS, CREDIT SCORING SERVICES, AND ANALYTICAL SERVICES, NAMELY, EVALUATION OF CREDIT AND OTHER DATA AS CREDIT RISK PREDICTORS, ALL FOR PURPOSES OF EVALUATING CREDIT WORTHINESS (U.S. CLS. 100, 101 AND 102).

AISHA SALEM, EXAMINING ATTORNEY

SN 77-326,287. PEBBLE BEACH COMPANY, PEBBLE BEACH, CA. FILED 11-9-2007.

PEBBLE BEACH

THE MARK CONSISTS OF STANDARD CHARACTERS WITHOUT CLAIM TO ANY PARTICULAR FONT, STYLE, SIZE, OR COLOR.

OWNER OF U.S. REG. NOS. 1,065,027, 1,884,513 AND OTHERS.

FOR CHARITABLE FUNDRAISING SERVICES; AND FINANCIAL SPONSORSHIP OF SPORTS TOURNAMENTS AND SPORTING EXHIBITIONS (U.S. CLS. 100, 101 AND 102).

FIRST USE 0-0-1952; IN COMMERCE 0-0-1952.
TRACY FLETCHER, EXAMINING ATTORNEY

CLASS 36—(Continued).

SN 77-351,933. PRIZE CAPITAL, LLC, SAN DIEGO, CA. FILED 12-14-2007.

EARTH 2.0

THE MARK CONSISTS OF STANDARD CHARACTERS WITHOUT CLAIM TO ANY PARTICULAR FONT, STYLE, SIZE, OR COLOR.

FOR FINANCIAL MANAGEMENT SERVICES, NAMELY, INVESTMENT ADVISORY, SUPERVISORY, AND MANAGEMENT SERVICES TO INDIVIDUAL AND INSTITUTIONAL INVESTORS; FUND ADVISORY AND INVESTMENT SERVICES, NAMELY, INDIVIDUAL BOND AND EQUITY SECURITIES, AND MUNICIPAL, BOND, MONEY MARKET, INCOME, VALUE, GROWTH, AND STOCK EQUITY MUTUAL FUNDS; PROVIDING SEPARATE INVESTMENT BROKERAGE AND RETIREMENT ACCOUNTS, NAMELY, TRADING, MAINTENANCE, AND MANAGEMENT OF FINANCIAL SECURITIES, STOCKS, BONDS, AND OTHER INVESTMENTS; MORTGAGE BANKING SERVICES; MORTGAGE LENDING SERVICES; CHARITABLE FUND RAISING AND ELEEMOSYNARY SERVICES, NAMELY, PROVIDING ASSISTANCE ON THE ESTABLISHMENT OF CHARITABLE AND PHILANTHROPIC FOUNDATIONS AND TRUSTS; CHARITABLE FUND RAISING AND ELEEMOSYNARY SERVICES, NAMELY, PROVIDING INFORMATION ON THE TOPIC OF ESTABLISHING CHARITABLE AND PHILANTHROPIC FOUNDATIONS AND TRUSTS; CHARITABLE FUND RAISING AND ELEEMOSYNARY SERVICES IN THE FIELD OF MONETARY DONATIONS; FINANCIAL SPONSORSHIP OF AN AWARDS PROGRAM FOR INNOVATIVE AND TECHNOLOGICAL ACHIEVEMENT AND NEW PRODUCT DEVELOPMENTS; INTELLECTUAL PROPERTY RIGHTS BROKERAGE SERVICES; INVESTMENT ADVICE AND CONSULTATION AND INVESTMENT MANAGEMENT SERVICES; FINANCIAL VALUATION SERVICES, NAMELY, PROVIDING FINANCIAL INFORMATION IN THE NATURE OF BUSINESS, ASSET, AND INTELLECTUAL PROPERTY VALUATIONS; FINANCIAL PORTFOLIO MANAGEMENT; PROVIDING INFORMATION VIA A GLOBAL COMPUTER NETWORK ON THE SUBJECT OF FINANCIAL SERVICES, VENTURE PHILANTHROPY, VENTURE CAPITAL, FINANCIAL CAPITAL, MERGERS, ACQUISITIONS, PRIZE COMPETITIONS, AND VENTURE CAPITAL FINANCING (U.S. CLS. 100, 101 AND 102).

DOMINICK J. SALEMI, EXAMINING ATTORNEY

SN 77-361,283. PROSPECT MANAGEMENT, LLC, ROCHESTER, NY. FILED 12-28-2007.

The Prospect Fund LP

THE MARK CONSISTS OF STANDARD CHARACTERS WITHOUT CLAIM TO ANY PARTICULAR FONT, STYLE, SIZE, OR COLOR.

NO CLAIM IS MADE TO THE EXCLUSIVE RIGHT TO USE "FUND LP", APART FROM THE MARK AS SHOWN.

FOR FINANCIAL SERVICES, NAMELY, INVESTMENT MANAGEMENT SERVICES (U.S. CLS. 100, 101 AND 102).

FIRST USE 12-1-1994; IN COMMERCE 12-1-1994.
ROBIN CHOSID, EXAMINING ATTORNEY

CLASS 36—(Continued).

SN 77-366,360. AMERICANS FOR UNFPA, INC., NEW YORK, NY. FILED 1-8-2008.

Americans for UNFPA

THE MARK CONSISTS OF STANDARD CHARACTERS WITHOUT CLAIM TO ANY PARTICULAR FONT, STYLE, SIZE, OR COLOR.

NO CLAIM IS MADE TO THE EXCLUSIVE RIGHT TO USE "AMERICANS", APART FROM THE MARK AS SHOWN.

FOR CHARITABLE FUND RAISING SERVICES (U.S. CLS. 100, 101 AND 102).

FIRST USE 8-0-2005; IN COMMERCE 9-0-2005.
KEVIN DINALLO, EXAMINING ATTORNEY

SN 77-370,791. RIPTRADE INC., JUPITER, FL. FILED 1-14-2008.



THE MARK CONSISTS OF THE STYLIZED WORD "RIPTRADE" WITH A STYLIZED BORDER AROUND THE WORD.

FOR CONSULTATION SERVICES IN THE FIELD OF EQUITIES, OPTIONS, COMMODITIES AND CURRENCY MARKETS (U.S. CLS. 100, 101 AND 102).
INGA ERVIN, EXAMINING ATTORNEY

SN 77-396,170. WEINGARTEN REALTY INVESTORS, HOUSTON, TX. FILED 2-13-2008.

RIVER OAKS PROMENADE

THE MARK CONSISTS OF STANDARD CHARACTERS WITHOUT CLAIM TO ANY PARTICULAR FONT, STYLE, SIZE, OR COLOR.

NO CLAIM IS MADE TO THE EXCLUSIVE RIGHT TO USE "RIVER OAKS", APART FROM THE MARK AS SHOWN.

FOR MANAGEMENT AND LEASING OF REAL ESTATE (U.S. CLS. 100, 101 AND 102).

SCOTT BIBB, EXAMINING ATTORNEY

CLASS 36—(Continued).

SN 77-397,726. FREEMLS, SANTA CRUZ, CA. FILED 2-14-2008.

REAL ESTATE POWER TO THE PEOPLE

THE MARK CONSISTS OF STANDARD CHARACTERS WITHOUT CLAIM TO ANY PARTICULAR FONT, STYLE, SIZE, OR COLOR.

NO CLAIM IS MADE TO THE EXCLUSIVE RIGHT TO USE "REAL ESTATE", APART FROM THE MARK AS SHOWN.

FOR NETWORK OF REAL ESTATE WEBSITES PROVIDING LISTING OF REAL ESTATE AND ALLOWING FOR SEARCH THERETO (U.S. CLS. 100, 101 AND 102).

FIRST USE 1-1-2002; IN COMMERCE 1-1-2002.
WILLIAM VERHOSEK, EXAMINING ATTORNEY

SN 77-401,162. IDT NETHERLANDS, B.V. (PUERTO RICO BRANCH), SAN JUAN, PUERTO RICO, FILED 2-20-2008.

BHARAT MATA

THE MARK CONSISTS OF STANDARD CHARACTERS WITHOUT CLAIM TO ANY PARTICULAR FONT, STYLE, SIZE, OR COLOR.

NO CLAIM IS MADE TO THE EXCLUSIVE RIGHT TO USE "BHARAT", APART FROM THE MARK AS SHOWN.

THE FOREIGN WORDING IN THE MARK TRANSLATES INTO ENGLISH AS MOTHER INDIA.

FOR PREPAID TELEPHONE CALLING CARD AND TELEPHONE DEBIT CARD SERVICES (U.S. CLS. 100, 101 AND 102).

FIRST USE 3-9-2006; IN COMMERCE 3-9-2006.
THOMAS MANOR, EXAMINING ATTORNEY

SN 77-402,662. IAC/INTERACTIVECORP, NEW YORK, NY. FILED 2-21-2008.



THE MARK CONSISTS OF A DEPICTION OF THE EXTERIOR OF THE APPLICANT'S OFFICE BUILDING.

FOR CORPORATE INFORMATION AND ANALYSIS, NAMELY, SHARE PRICE INFORMATION AND FINANCIAL ANALYSIS (U.S. CLS. 100, 101 AND 102).

NICHOLAS COLEMAN, EXAMINING ATTORNEY

CLASS 36—(Continued).

SN 77-402,672. IAC/INTERACTIVECORP, NEW YORK, NY. FILED 2-21-2008.



THE MARK CONSISTS OF A DEPICTION OF THE EXTERIOR OF THE APPLICANT'S OFFICE BUILDING. FOR CORPORATE INFORMATION AND ANALYSIS, NAMELY, SHARE PRICE INFORMATION AND FINANCIAL ANALYSIS (U.S. CLS. 100, 101 AND 102).
NICHOLAS COLEMAN, EXAMINING ATTORNEY

CLASS 36—(Continued).

SN 77-408,038. CARTER JACOBS, LLC, SHERMAN OAKS, CA. FILED 2-27-2008.



THE NAME "CARTER JACOBS" DOES NOT IDENTIFY A LIVING INDIVIDUAL.
THE COLOR(S) DARK BLUE, LIGHT BLUE, WHITE AND GRAY IS/ARE CLAIMED AS A FEATURE OF THE MARK.
THE TERM "CARTER" APPEARS IN DARK BLUE, THE TERM "JACOBS" APPEARS IN GRAY, THE STYLIZED CIRCLE APPEARS IN DARK BLUE AND WHITE, WITH LIGHT BLUE WAVY LINES.
FOR FINANCIAL AND PHILANTHROPIC SERVICES, NAMELY, INVESTMENT MANAGEMENT AND CHARITABLE CONSULTING IN THE NATURE OF ACCEPTING AND ADMINISTERING MONETARY CHARITABLE CONTRIBUTIONS (U.S. CLS. 100, 101 AND 102).
FIRST USE 11-15-2007; IN COMMERCE 11-15-2007.
AMY ALFIERI, EXAMINING ATTORNEY

SN 77-402,679. IAC/INTERACTIVECORP, NEW YORK, NY. FILED 2-21-2008.



THE MARK CONSISTS OF A DEPICTION OF THE EXTERIOR OF THE APPLICANT'S OFFICE BUILDING. FOR CORPORATE INFORMATION AND ANALYSIS, NAMELY, SHARE PRICE INFORMATION AND FINANCIAL ANALYSIS (U.S. CLS. 100, 101 AND 102).
NICHOLAS COLEMAN, EXAMINING ATTORNEY

SN 77-408,041. CARTER JACOBS, LLC, SHERMAN OAKS, CA. FILED 2-27-2008.

CARTER JACOBS

THE MARK CONSISTS OF STANDARD CHARACTERS WITHOUT CLAIM TO ANY PARTICULAR FONT, STYLE, SIZE, OR COLOR.
THE NAME "CARTER JACOBS" DOES NOT IDENTIFY A LIVING INDIVIDUAL.
FOR FINANCIAL AND PHILANTHROPIC SERVICES, NAMELY, INVESTMENT MANAGEMENT AND CHARITABLE CONSULTING IN THE NATURE OF ACCEPTING AND ADMINISTERING MONETARY CHARITABLE CONTRIBUTIONS (U.S. CLS. 100, 101 AND 102).
FIRST USE 11-15-2007; IN COMMERCE 11-15-2007.
AMY ALFIERI, EXAMINING ATTORNEY

CLASS 36—(Continued).

SN 77-408,933. HAPPY HATS FOR KIDS, TORRANCE, CA. FILED 2-28-2008.



THE COLOR(S) BLUE, RED, GOLD AND BLACK IS/ARE CLAIMED AS A FEATURE OF THE MARK.

THE MARK CONSISTS OF "HAPPY HATS FOR KIDS HAPPINESS STARTS HERE!" IN BLACK WHERE THE LETTER "A" IN THE WORDS "HAPPY" AND "HATS" IS REPLACED BY A BLUE HAT FEATURING A GOLD STAR, GOLD WING, AND RED TRIM, ALL OUTLINED IN BLACK. A LARGER BLUE HAT FEATURING A GOLD STAR, GOLD WING, AND RED TRIM, ALL OUTLINED IN BLACK, APPEARS ABOVE THE WORDING.

FOR CHARITABLE FUND RAISING (U.S. CLS. 100, 101 AND 102).

FIRST USE 2-1-2008; IN COMMERCE 2-1-2008.
LINDA LAVACHE, EXAMINING ATTORNEY

SN 77-412,453. DUN & BRADSTREET, INC., SHORT HILLS, NJ. FILED 3-4-2008.

PAYDEX PLUS

THE MARK CONSISTS OF STANDARD CHARACTERS WITHOUT CLAIM TO ANY PARTICULAR FONT, STYLE, SIZE, OR COLOR.

OWNER OF U.S. REG. NO. 1,205,670.
FOR CREDIT RATING SERVICES, NAMELY, RATING PAYMENT PERFORMANCE (U.S. CLS. 100, 101 AND 102).

BILL DAWE, EXAMINING ATTORNEY

SN 77-412,599. PARFUMERIE DOULGAS GMBH, HAGEN, FED REP GERMANY, FILED 3-4-2008.

Douglas makes
life
beautiful

FOR CREDIT AND DEBIT CARD SERVICES; ISSUANCE OF CHECK GUARANTEE CARDS AND IDENTIFICATION CARDS FOR THE PAYMENT OF GOODS AND/OR SERVICES (U.S. CLS. 100, 101 AND 102).

ROBIN CHOSID, EXAMINING ATTORNEY

CLASS 36—(Continued).

SN 77-421,979. ALLSTATE INSURANCE COMPANY, NORTHBROOK, IL. FILED 3-14-2008.

BONO DE CONDUCTOR PRECAVIDO

THE MARK CONSISTS OF STANDARD CHARACTERS WITHOUT CLAIM TO ANY PARTICULAR FONT, STYLE, SIZE, OR COLOR.

NO CLAIM IS MADE TO THE EXCLUSIVE RIGHT TO USE "BONO", APART FROM THE MARK AS SHOWN.

THE FOREIGN WORDING IN THE MARK TRANSLATES INTO ENGLISH AS "SAFE DRIVING BONUS".

SEC. 2(F).

FOR INSURANCE SERVICES, NAMELY, UNDERWRITING AUTOMOBILE INSURANCE POLICIES WHICH FEATURE MONETARY DISCOUNT PROVISIONS FOR DRIVERS WITH GOOD DRIVING RECORDS (U.S. CLS. 100, 101 AND 102).

FIRST USE 1-0-2006; IN COMMERCE 1-0-2006.

CHRISTINA SOBRAL, EXAMINING ATTORNEY

SN 77-422,674. ROBBINS WEALTHPARTNERS LLC, BROOKFIELD, WI. FILED 3-14-2008.

ROBBINS WEALTHPARTNERS
YOUR WEALTH. CONSIDERED.

THE MARK CONSISTS OF STANDARD CHARACTERS WITHOUT CLAIM TO ANY PARTICULAR FONT, STYLE, SIZE, OR COLOR.

FOR FINANCIAL ADVISORY AND CONSULTANCY SERVICES; FINANCIAL AND INVESTMENT SERVICES, NAMELY, MANAGEMENT AND BROKERAGE IN THE FIELDS OF STOCKS, BONDS, OPTIONS, COMMODITIES, AND OTHER SECURITIES, AND THE INVESTMENT OF FUNDS FOR OTHERS; AND FINANCIAL PLANNING AND INVESTMENT ADVISORY SERVICES (U.S. CLS. 100, 101 AND 102).

ANNE MADDEN, EXAMINING ATTORNEY

CLASS 36—(Continued).

SN 77-423,758. ALLSTATE INSURANCE COMPANY, NORTHBROOK, IL. FILED 3-17-2008.

DESCUENTO EN EL DEDUCIBLE

THE MARK CONSISTS OF STANDARD CHARACTERS WITHOUT CLAIM TO ANY PARTICULAR FONT, STYLE, SIZE, OR COLOR.

NO CLAIM IS MADE TO THE EXCLUSIVE RIGHT TO USE "DESCUENTO", APART FROM THE MARK AS SHOWN.

THE FOREIGN WORDING IN THE MARK TRANSLATES INTO ENGLISH AS "DEDUCTIBLE REWARDS".
SEC. 2(F).

FOR INSURANCE SERVICES, NAMELY, UNDERWRITING AUTOMOBILE INSURANCE POLICIES WHICH FEATURE DISCOUNTS FOR POLICY HOLDERS WITH SAFE DRIVING RECORDS (U.S. CLS. 100, 101 AND 102).

FIRST USE 1-0-2006; IN COMMERCE 1-0-2006.
CHRISTINA SOBRAL, EXAMINING ATTORNEY

SN 77-429,878. CENTRAL BANCOMPANY, INC., JEFFERSON CITY, MO. FILED 3-24-2008.

METCALF BANK

THE MARK CONSISTS OF STANDARD CHARACTERS WITHOUT CLAIM TO ANY PARTICULAR FONT, STYLE, SIZE, OR COLOR.

NO CLAIM IS MADE TO THE EXCLUSIVE RIGHT TO USE "BANK", APART FROM THE MARK AS SHOWN.

SEC. 2(F).
FOR BANKING SERVICES (U.S. CLS. 100, 101 AND 102).

FIRST USE 2-17-1997; IN COMMERCE 12-31-1997.
WENDY JUN, EXAMINING ATTORNEY

SN 77-436,015. MARION CENTER BANK, MARION CENTER, PA. FILED 3-31-2008.

MC Bank

THE MARK CONSISTS OF STANDARD CHARACTERS WITHOUT CLAIM TO ANY PARTICULAR FONT, STYLE, SIZE, OR COLOR.

NO CLAIM IS MADE TO THE EXCLUSIVE RIGHT TO USE "BANK", APART FROM THE MARK AS SHOWN.

FOR BANKING AND FINANCING SERVICES (U.S. CLS. 100, 101 AND 102).

FIRST USE 3-31-2005; IN COMMERCE 3-31-2005.
MIDGE BUTLER, EXAMINING ATTORNEY

CLASS 36—(Continued).

SN 77-445,100. BRUCE FISHER REALTY, LLC, LAS VEGAS, NV. FILED 4-10-2008.



NO CLAIM IS MADE TO THE EXCLUSIVE RIGHT TO USE "REALTY", APART FROM THE MARK AS SHOWN.

THE NAME "BRUCE FISHER" IDENTIFIES A LIVING INDIVIDUAL WHOSE CONSENT IS OF RECORD.

THE COLOR(S) BLUE IS/ARE CLAIMED AS A FEATURE OF THE MARK.

THE MARK CONSISTS OF THE STYLIZED CAPITAL LETTERS "B & F" WITH THE LETTER "B" REVERSED AND CONNECTED TO THE LETTER "F". THIS DESIGN APPEARS TO THE LEFT OF THE WORDING "BRUCE FISHER REALTY". THE PHRASE "REPUTATION FOR RESULTS" IS BELOW "BRUCE FISHER REALTY". THE ENTIRE MARK IS IN BLUE.

FOR PROVIDING REAL ESTATE LISTINGS AND REAL ESTATE INFORMATION VIA THE INTERNET; REAL ESTATE INVESTMENT SERVICES IN THE NATURE OF PURCHASING AND SELLING OF REAL ESTATE FOR OTHERS (U.S. CLS. 100, 101 AND 102).

KIM SAITO, EXAMINING ATTORNEY

SN 77-445,631. PADDA, LTD, SAINT LOUIS, MO. FILED 4-10-2008.



NO CLAIM IS MADE TO THE EXCLUSIVE RIGHT TO USE "FOUNDATION", APART FROM THE MARK AS SHOWN.

FOR CHARITABLE FUND RAISING (U.S. CLS. 100, 101 AND 102).

CHRIS WELLS, EXAMINING ATTORNEY

CLASS 36—(Continued).

SN 77-446,216. CREDIT UNION 24, INC, TALLAHASSEE, FL. FILED 4-11-2008.

CREDIT UNION 24 ADVANTAGE
SERVICES

THE MARK CONSISTS OF STANDARD CHARACTERS WITHOUT CLAIM TO ANY PARTICULAR FONT, STYLE, SIZE, OR COLOR.

OWNER OF U.S. REG. NO. 3,082,316.

NO CLAIM IS MADE TO THE EXCLUSIVE RIGHT TO USE "CREDIT UNION" AND "SERVICES", APART FROM THE MARK AS SHOWN.

FOR COMPUTERIZED ELECTRONIC FUNDS TRANSFER SERVICES BETWEEN CREDIT UNIONS AND RETAILERS, AND CREDIT UNIONS THEMSELVES, PROVIDED, INCLUDING WITHOUT LIMITATION, IN CONJUNCTION WITH AUTOMATED TELLER MACHINES (U.S. CLS. 100, 101 AND 102).

WILLIAM P. SHANAHAN, EXAMINING ATTORNEY

SN 77-451,950. PORTABLE PRACTICAL EDUCATIONAL PREPARATION, INC., TUCSON, AZ. FILED 4-18-2008.

PPEP INC.

THE MARK CONSISTS OF STANDARD CHARACTERS WITHOUT CLAIM TO ANY PARTICULAR FONT, STYLE, SIZE, OR COLOR.

NO CLAIM IS MADE TO THE EXCLUSIVE RIGHT TO USE "INC.", APART FROM THE MARK AS SHOWN.

FOR FINANCIAL SERVICES, NAMELY, MICRO-ENTERPRISE LENDING AND MICRO-BUSINESS LENDING, NAMELY, MONEY LENDING, COMMERCIAL LENDING AND REAL ESTATE LENDING; FINANCIAL CONSULTING IN THE FIELDS OF MICRO-ENTERPRISE DEVELOPMENT, MICRO-BUSINESS LENDING (U.S. CLS. 100, 101 AND 102).

FIRST USE 12-31-1985; IN COMMERCE 12-31-1985.

SANI KHOURI, EXAMINING ATTORNEY

SN 77-455,188. U.S. ONE, INC., RENO, NV. FILED 4-22-2008.

U.S. ONE

THE MARK CONSISTS OF STANDARD CHARACTERS WITHOUT CLAIM TO ANY PARTICULAR FONT, STYLE, SIZE, OR COLOR.

NO CLAIM IS MADE TO THE EXCLUSIVE RIGHT TO USE "U.S.", APART FROM THE MARK AS SHOWN.

FOR INVESTMENT ADVICE; MUTUAL FUND INVESTMENT (U.S. CLS. 100, 101 AND 102).

KIM SAITO, EXAMINING ATTORNEY

CLASS 36—(Continued).

SN 77-455,198. U.S. ONE, INC., RENO, NV. FILED 4-22-2008.

ONE FUND

THE MARK CONSISTS OF STANDARD CHARACTERS WITHOUT CLAIM TO ANY PARTICULAR FONT, STYLE, SIZE, OR COLOR.

NO CLAIM IS MADE TO THE EXCLUSIVE RIGHT TO USE "FUND", APART FROM THE MARK AS SHOWN.

FOR INVESTMENT ADVICE; MUTUAL FUND INVESTMENT (U.S. CLS. 100, 101 AND 102).

KIM SAITO, EXAMINING ATTORNEY

SN 77-455,203. U.S. ONE, INC., RENO, NV. FILED 4-22-2008.

U.S. ONE FUND

THE MARK CONSISTS OF STANDARD CHARACTERS WITHOUT CLAIM TO ANY PARTICULAR FONT, STYLE, SIZE, OR COLOR.

NO CLAIM IS MADE TO THE EXCLUSIVE RIGHT TO USE "U.S." AND "FUND", APART FROM THE MARK AS SHOWN.

FOR INVESTMENT ADVICE; MUTUAL FUND INVESTMENT (U.S. CLS. 100, 101 AND 102).

KIM SAITO, EXAMINING ATTORNEY

SN 77-458,400. SANDY SPRING BANK, OLNEY, MD. FILED 4-25-2008.

THE IDEA BANK

THE MARK CONSISTS OF STANDARD CHARACTERS WITHOUT CLAIM TO ANY PARTICULAR FONT, STYLE, SIZE, OR COLOR.

NO CLAIM IS MADE TO THE EXCLUSIVE RIGHT TO USE "BANK", APART FROM THE MARK AS SHOWN.

FOR BANKING SERVICES (U.S. CLS. 100, 101 AND 102).

ZACHARY BELLO, EXAMINING ATTORNEY

CLASS 36—(Continued).

SN 77-462,255. MEDICARD FINANCE INC. - SERVICE FINANCIERS MEDICARD INC., TORONTO, CANADA, FILED 4-30-2008.

MEDICARD

THE MARK CONSISTS OF STANDARD CHARACTERS WITHOUT CLAIM TO ANY PARTICULAR FONT, STYLE, SIZE, OR COLOR.
 FOR FINANCING SERVICES (U.S. CLS. 100, 101 AND 102).
 FIRST USE 9-1-1996; IN COMMERCE 9-1-1996.
 BRIAN PINO, EXAMINING ATTORNEY

SN 77-479,938. MIRACLE RECREATION EQUIPMENT COMPANY, MONETT, MO. FILED 5-21-2008.

MIRACLE GRANTS FOR AMERICA'S SCHOOLS

THE MARK CONSISTS OF STANDARD CHARACTERS WITHOUT CLAIM TO ANY PARTICULAR FONT, STYLE, SIZE, OR COLOR.
 OWNER OF U.S. REG. NOS. 841,174, 2,043,224 AND 2,988,973.
 NO CLAIM IS MADE TO THE EXCLUSIVE RIGHT TO USE "GRANTS FOR AMERICA'S SCHOOLS", APART FROM THE MARK AS SHOWN.
 FOR PROVIDING GRANTS FOR THE PURCHASE OF PLAYGROUND EQUIPMENT (U.S. CLS. 100, 101 AND 102).
 FIRST USE 5-0-2008; IN COMMERCE 5-8-2008.
 KATINA MISTER, EXAMINING ATTORNEY

SN 77-479,946. MIRACLE RECREATION EQUIPMENT COMPANY, MONETT, MO. FILED 5-21-2008.

MIRACLE'S GRANTS FOR AMERICA'S SCHOOLS

THE MARK CONSISTS OF STANDARD CHARACTERS WITHOUT CLAIM TO ANY PARTICULAR FONT, STYLE, SIZE, OR COLOR.
 OWNER OF U.S. REG. NOS. 841,174, 2,043,224 AND 2,988,973.
 NO CLAIM IS MADE TO THE EXCLUSIVE RIGHT TO USE "GRANTS FOR AMERICA'S SCHOOLS", APART FROM THE MARK AS SHOWN.
 FOR PROVIDING GRANTS FOR THE PURCHASE OF PLAYGROUND EQUIPMENT (U.S. CLS. 100, 101 AND 102).
 FIRST USE 5-0-2008; IN COMMERCE 5-0-2008.
 KATINA MISTER, EXAMINING ATTORNEY

CLASS 36—(Continued).

SN 77-482,490. SPREADZERO HOLDINGS, INC., NEW YORK, NY. FILED 5-23-2008.



NO CLAIM IS MADE TO THE EXCLUSIVE RIGHT TO USE "LIQUIDITY" OR "PRICE", APART FROM THE MARK AS SHOWN.
 THE COLOR(S) RED AND BLACK IS/ARE CLAIMED AS A FEATURE OF THE MARK.
 THE MARK CONSISTS OF A RED ZERO SURROUNDED BY BLACK ARROWS NEXT TO THE TERM "SPREAD-ZERO". THE WORD "SPREAD" IS BLACK AND "ZERO" IS RED. UNDERNEATH ARE THE WORDS "LIQUIDITY" IN RED AND "PRICE" IN BLACK.
 FOR FINANCIAL SERVICES, NAMELY, PROVIDING SECURITIES TRADE EXECUTION SERVICES FEATURING THE AUTOMATED MATCHING, CROSSING AND EXECUTING OF INVESTMENT TRANSACTION ORDERS; AND THE PROVISION OF FINANCIAL INFORMATION (U.S. CLS. 100, 101 AND 102).
 JAMES GRIFFIN, EXAMINING ATTORNEY

SN 77-483,508. COASTAL CAROLINA BANCSHARES, INC., MYRTLE BEACH, SC. FILED 5-27-2008.



NO CLAIM IS MADE TO THE EXCLUSIVE RIGHT TO USE "COASTAL CAROLINA NATIONAL BANK", APART FROM THE MARK AS SHOWN.
 THE MARK CONSISTS OF A PELICAN IN FLIGHT LOCATED BELOW A SEMI-CIRCLE AND ABOVE THE WORDING "COASTAL CAROLINA" IN A STYLIZED FONT. THE WORDING "NATIONAL BANK" APPEARS IN A STYLIZED FONT BELOW THE WORDING "COASTAL CAROLINA".
 FOR BANKING AND FINANCING SERVICES; BANKING CONSULTATION; INVESTMENT BANKING SERVICES; ISSUANCE OF BANK CHECKS; MERCHANT BANKING AND INVESTMENT BANKING SERVICES; MORTGAGE BANKING; ON-LINE BANKING SERVICES; SAVINGS BANK SERVICES (U.S. CLS. 100, 101 AND 102).
 SONYA STEPHENS, EXAMINING ATTORNEY

CLASS 36—(Continued).

SN 77-485,139. THE BANK OF NEW YORK MELLON CORPORATION, NEW YORK, NY. FILED 5-28-2008.

BNY MELLON DR INDEX

THE MARK CONSISTS OF STANDARD CHARACTERS WITHOUT CLAIM TO ANY PARTICULAR FONT, STYLE, SIZE, OR COLOR.

OWNER OF U.S. REG. NO. 3,260,500.

NO CLAIM IS MADE TO THE EXCLUSIVE RIGHT TO USE "DR INDEX", APART FROM THE MARK AS SHOWN. FOR FINANCIAL REPORTING SERVICES, NAMELY, CALCULATING, MEASURING, INDEXING IN RELATION TO A BASE VALUE AND REPORTING THE FLUCTUATION IN AGGREGATE MARKET VALUE OF A SELECT GROUP OF DEPOSITARY RECEIPTS (U.S. CLS. 100, 101 AND 102).

RUSS HERMAN, EXAMINING ATTORNEY

SN 77-485,753. BLANCO, PAUL, SHELTON, CT. FILED 5-29-2008.

BARNUM FINANCIAL GROUP

THE MARK CONSISTS OF STANDARD CHARACTERS WITHOUT CLAIM TO ANY PARTICULAR FONT, STYLE, SIZE, OR COLOR.

NO CLAIM IS MADE TO THE EXCLUSIVE RIGHT TO USE "FINANCIAL GROUP", APART FROM THE MARK AS SHOWN.

SEC. 2(F).

FOR ADMINISTRATION OF EMPLOYEE BENEFIT PLANS CONCERNING INSURANCE AND FINANCE; ADVICE RELATING TO INVESTMENTS; ADVISORY SERVICES RELATING TO CREDIT AND DEBIT CONTROL, INVESTMENT, GRANTS AND FINANCING OF LOANS; AGENCIES FOR BROKERAGE OF SECURITIES TRADING IN OVERSEAS SECURITIES MARKETS AND OF TRANSACTIONS ON COMMISSION OF OVERSEAS MARKET SECURITIES FUTURES; AGENCIES IN THE FIELD OF BONDS AND OTHER SECURITIES; BANKING AND FINANCING SERVICES; BROKERAGE HOUSES IN THE FIELD OF STOCKS, COMMODITIES, AND FUTURES; BROKERAGE OF SHARES OR STOCKS AND OTHER SECURITIES; ESTATE PLANNING; FINANCIAL ADVICE AND CONSULTANCY SERVICES; FINANCIAL ADVISORY AND CONSULTANCY SERVICES; FINANCIAL ANALYSIS AND CONSULTATION; FINANCIAL RESEARCH SERVICES; FINANCIAL AND INVESTMENT SERVICES, NAMELY, MANAGEMENT AND BROKERAGE IN THE FIELDS OF STOCKS, BONDS, OPTIONS, COMMODITIES, FUTURES AND OTHER SECURITIES, AND THE INVESTMENT OF FUNDS OF OTHERS; FINANCIAL CONSULTANCY AND INSURANCE CONSULTANCY; FINANCIAL CONSULTATION; FINANCIAL CONSULTING; FINANCIAL EVALUATION FOR INSURANCE PURPOSES; FINANCIAL FORECASTING; FINANCIAL INVESTMENT IN THE FIELD OF SECURITIES; FINANCIAL PLANNING AND INVESTMENT ADVISORY SERVICES; FINANCIAL PLANNING CONSULTATION; FINANCIAL PLANNING FOR RETIREMENT; FINANCIAL PLANNING, NAMELY, THE CREATION OF PERSONALIZED STRATEGIES TO ACHIEVE FINANCIAL INDEPENDENCE; FINANCIAL PORTFOLIO MANAGEMENT; FINANCIAL PORTFOLIO ANALYSIS SERVICES; FINANCIAL RESEARCH; FINANCIAL RISK MANAGEMENT CONSUL-

CLASS 36—(Continued).

TATION; FINANCIAL SERVICES IN THE NATURE OF AN INVESTMENT SECURITY; FINANCIAL SERVICES, NAMELY, INVESTMENT FUND TRANSFER AND TRANSACTION SERVICES; FINANCIAL SERVICES, NAMELY, ASSISTING OTHERS WITH THE COMPLETION OF FINANCIAL TRANSACTIONS FOR STOCKS, BONDS, SECURITIES AND EQUITIES; FINANCIAL SERVICES, NAMELY, A TOTAL PORTFOLIO OFFERING FOR HIGH NET WORTH CLIENTS CONSISTING OF BOTH SEPARATE ACCOUNTS AND MUTUAL FUNDS FOR EQUITY AND FIXED INCOME INVESTMENTS; FUNDS INVESTMENT; INDIVIDUAL RETIREMENT ACCOUNT SERVICES; INSURANCE AGENCIES; INSURANCE AGENCIES IN THE FIELD OF HOME, ACCIDENT, LIFE; INSURANCE AGENCY AND BROKERAGE; INSURANCE AND FINANCIAL INFORMATION AND CONSULTANCY SERVICES; INSURANCE BROKERAGE IN THE FIELD OF HOME INSURANCE, ACCIDENT INSURANCE; INSURANCE CONSULTANCY; INSURANCE CONSULTANCY SERVICES, NAMELY, PROVIDING ADVICE IN THE FIELD OF PROPERTY AND CASUALTY INSURANCE; INSURANCE INFORMATION AND CONSULTANCY; INSURANCE SERVICES, NAMELY, WRITING PROPERTY AND CASUALTY INSURANCE; INVESTMENT ADVICE; INVESTMENT ADVISORY SERVICES; INVESTMENT BANKING SERVICES; INVESTMENT BROKERAGE; INVESTMENT CONSULTATION; INVESTMENT MANAGEMENT; INVESTMENT MANAGEMENT OF AND DISTRIBUTION OF VARIABLE ANNUITIES; INVESTMENT MANAGEMENT OF AND DISTRIBUTION OF ANNUITIES; INVESTMENT OF FUNDS FOR OTHERS; INVESTMENT SERVICES, NAMELY, ASSET ACQUISITION, CONSULTATION, DEVELOPMENT AND MANAGEMENT SERVICES; LIFE INSURANCE BROKERAGE; MANAGEMENT OF A CAPITAL INVESTMENT FUND; MANAGEMENT OF PORTFOLIOS COMPRISING SECURITIES; MANAGEMENT OF PORTFOLIOS OF TRANSFERABLE SECURITIES; MANAGEMENT OF PRIVATE EQUITY FUNDS; MUTUAL FUND BROKERAGE; MUTUAL FUND INVESTMENT; MUTUAL FUNDS AND CAPITAL INVESTMENT; SECURITY BROKERAGE; SECURITIES TRADING AND INVESTING SERVICES FOR OTHERS VIA THE INTERNET; SECURITY BROKERAGE; STOCK BROKERAGE (U.S. CLS. 100, 101 AND 102).

FIRST USE 12-31-2002; IN COMMERCE 12-31-2002.

CARYN GLASSER, EXAMINING ATTORNEY

SN 77-498,973. GENOVESE COLVIN, MARY, PHILADELPHIA, PA. FILED 6-13-2008.

.....Mary On The Square

THE MARK CONSISTS OF STANDARD CHARACTERS WITHOUT CLAIM TO ANY PARTICULAR FONT, STYLE, SIZE, OR COLOR.

FOR REAL ESTATE AGENT SERVICES, NAMELY, CONSULTATION AND LISTING OF RESIDENTIAL PROPERTIES (U.S. CLS. 100, 101 AND 102).

FIRST USE 1-0-1995; IN COMMERCE 1-0-1995.

DORITT L. CARROLL, EXAMINING ATTORNEY

CLASS 36—(Continued).

SN 77-500,816. LONDON BUTLER & COMPANY, LP, WASHINGTON, DC. FILED 6-17-2008.

INVESTMENTS THAT BUILD

THE MARK CONSISTS OF STANDARD CHARACTERS WITHOUT CLAIM TO ANY PARTICULAR FONT, STYLE, SIZE, OR COLOR.

FOR FINANCIAL SERVICES, NAMELY, DEVELOPMENT AND SERVICING OF REAL ESTATE INVESTMENT FUNDS (U.S. CLS. 100, 101 AND 102).

FIRST USE 6-15-2006; IN COMMERCE 6-15-2006.

DAVID MURRAY, EXAMINING ATTORNEY

CLASS 36—(Continued).

SN 77-521,119. CERTIFIED HOMES, INC., PORTSMOUTH, NH. FILED 7-14-2008.



THE COLOR(S) YELLOW AND BLUE IS/ARE CLAIMED AS A FEATURE OF THE MARK.

THE MARK CONSISTS OF A BLUE OUTLINE OF A HOUSE WITH A BLUE CHECK MARK INSIDE AND EXTENDING OUTWARD INSIDE A YELLOW SEAL WITH RAISED EDGES.

FOR PROVIDING HOME VALUE OR REAL ESTATE APPRAISAL SERVICES (U.S. CLS. 100, 101 AND 102).

ZACHARY BELLO, EXAMINING ATTORNEY

SN 77-500,891. LONDON BUTLER & COMPANY, LP, WASHINGTON, DC. FILED 6-17-2008.

LONDON BUTLER & COMPANY

THE MARK CONSISTS OF STANDARD CHARACTERS WITHOUT CLAIM TO ANY PARTICULAR FONT, STYLE, SIZE, OR COLOR.

NO CLAIM IS MADE TO THE EXCLUSIVE RIGHT TO USE "COMPANY", APART FROM THE MARK AS SHOWN.

FOR FINANCIAL SERVICES, NAMELY, DEVELOPMENT AND SERVICING OF REAL ESTATE INVESTMENT FUNDS (U.S. CLS. 100, 101 AND 102).

FIRST USE 2-15-1982; IN COMMERCE 2-15-1982.

DAVID MURRAY, EXAMINING ATTORNEY

SN 77-529,843. AMERICAL FINANCIAL, CALISTOGA, CA. FILED 7-23-2008.



SN 77-512,569. INFINITY INSURANCE COMPANY, BIRMINGHAM, AL. FILED 7-1-2008.

INSTRIDE.COM

THE MARK CONSISTS OF STANDARD CHARACTERS WITHOUT CLAIM TO ANY PARTICULAR FONT, STYLE, SIZE, OR COLOR.

FOR INSURANCE SERVICES, NAMELY, WRITING PROPERTY AND CASUALTY INSURANCE (U.S. CLS. 100, 101 AND 102).

FIRST USE 10-22-2007; IN COMMERCE 10-22-2007.

SUSAN STIGLITZ, EXAMINING ATTORNEY

NO CLAIM IS MADE TO THE EXCLUSIVE RIGHT TO USE "CAL," "GREEN," AND "LENDING", APART FROM THE MARK AS SHOWN.

THE MARK CONSISTS OF THE STYLIZED WORDS "CAL GREEN LENDING". ABOVE THE LETTER "N" IN THE WORD "GREEN" IS AN IMAGE OF A LEAF. TO THE LEFT OF THE STYLIZED WORDS IS AN IMAGE OF A HOUSE WITH LEAVES IN THE CENTER AND A SUN RISING OVER THE RIGHT SIDE OF THE ROOF.

FOR FINANCING SERVICES (U.S. CLS. 100, 101 AND 102).

FIRST USE 6-12-2008; IN COMMERCE 6-12-2008.

JENNY PARK, EXAMINING ATTORNEY

CLASS 36—(Continued).

SN 77-536,031. KNAPTON, KURT RODRICK, ARLINGTON, TX. FILED 7-31-2008.



THE MARK CONSISTS OF AN ADULT'S HAND HOLDING A CHILD'S HAND WITH THE WORDS "THE BENEVOLENT HAND".

FOR CHARITABLE AND NON-PROFIT SERVICES, NAMELY, PROVIDING FINANCIAL SUPPORT FOR UNDERPRIVILEGED CHILDREN (U.S. CLS. 100, 101 AND 102).

NICHOLAS COLEMAN, EXAMINING ATTORNEY

CLASS 36—(Continued).

SN 77-536,685. CITY LOAN INC., LONG BEACH, CA. FILED 8-1-2008.



THE COLOR(S) ORANGE, GREEN, BLACK AND WHITE IS/ARE CLAIMED AS A FEATURE OF THE MARK.

THE MARK CONSISTS OF THE WORD "CITYLOAN" ALL IN LOWER CASE. THE WORD "CITY" IS ORANGE AND THE WORD "LOAN" IS GREEN. THE WORD "CITY" IS ATTACHED WITH TWO BLACK TIRES AND THE WORD "LOAN" IS ATTACHED WITH TWO GREEN AND WHITE DOLLAR BILLS.

FOR INSURANCE BROKERAGE; FINANCIAL CONSULTING; MONETARY EXCHANGE; REAL ESTATE BROKERAGE (U.S. CLS. 100, 101 AND 102).

FIRST USE 4-1-2008; IN COMMERCE 4-1-2008. BERYL GARDNER, EXAMINING ATTORNEY

SN 77-536,036. KNAPTON, KURT RODRICK, ARLINGTON, TX. FILED 7-31-2008.

THE BENEVOLENT HAND

THE MARK CONSISTS OF STANDARD CHARACTERS WITHOUT CLAIM TO ANY PARTICULAR FONT, STYLE, SIZE, OR COLOR.

FOR CHARITABLE AND NON-PROFIT SERVICES, NAMELY, PROVIDING FINANCIAL SUPPORT FOR UNDERPRIVILEGED CHILDREN (U.S. CLS. 100, 101 AND 102).

NICHOLAS COLEMAN, EXAMINING ATTORNEY

SN 77-540,052. MUTUAL OF OMAHA INSURANCE COMPANY, OMAHA, NE. FILED 8-6-2008.

OFFICIAL SPONSOR OF THE AHA MOMENT

THE MARK CONSISTS OF STANDARD CHARACTERS WITHOUT CLAIM TO ANY PARTICULAR FONT, STYLE, SIZE, OR COLOR.

FOR INSURANCE UNDERWRITING IN THE FIELD OF LIFE, HEALTH, DISABILITY, DENTAL, LONG-TERM CARE, MEDICARE SUPPLEMENT, CRITICAL ILLNESS, ACCIDENTAL DEATH AND DISMEMBERMENT, HOSPITAL INCOME, ANNUITIES, RETIREMENT PLANS AND MUTUAL FUNDS (U.S. CLS. 100, 101 AND 102).

SUE LAWRENCE, EXAMINING ATTORNEY

CLASS 36—(Continued).

SN 77-542,268. MADISON W PROPERTIES, LLC, NEW YORK, NY. FILED 8-8-2008.



NO CLAIM IS MADE TO THE EXCLUSIVE RIGHT TO USE "PROPERTIES", APART FROM THE MARK AS SHOWN.

THE MARK CONSISTS OF "MADISON W PROPERTIES" IN STYLIZED LETTERING.

FOR REAL ESTATE INVESTMENT, MANAGEMENT AND VALUATION (U.S. CLS. 100, 101 AND 102).

FIRST USE 10-8-2008; IN COMMERCE 10-8-2008.

DAWN HAN, EXAMINING ATTORNEY

CLASS 36—(Continued).

SN 77-543,823. GODADDY.COM, INC., SCOTTSDALE, AZ. FILED 8-11-2008.



OWNER OF U.S. REG. NO. 2,904,954.

THE COLOR(S) ORANGE, YELLOW, GREEN, BLACK, WHITE AND GRAY IS/ARE CLAIMED AS A FEATURE OF THE MARK.

THE MARK CONSISTS OF A STYLIZED BUST OF A MAN'S HEAD OUTLINED IN BLACK AND SHADED IN WHITE, WEARING GLASSES OUTLINED IN BLACK WITH GREEN LENSES, A YELLOW STAR OUTLINED IN BLACK AT THE TOP LEFT OF THE HEAD AND CURVED ORANGE LINES ON TOP OF THE HEAD WITH THE WORDS "GODADDY.COM" SHADED IN BLACK TO THE RIGHT OF THE HEAD WITH THE ".COM" APPEARING WITHIN A YELLOW OVAL PARTIALLY OUTLINED IN BLACK.

FOR FINANCIAL SPONSORSHIP OF ATHLETES AND ATHLETIC EVENTS (U.S. CLS. 100, 101 AND 102).

FIRST USE 8-9-2006; IN COMMERCE 8-9-2006.

BRIAN CALLAGHAN, EXAMINING ATTORNEY

SN 77-545,923. DMCR INVESTMENTS, LLC, MARIETTA, GA. FILED 8-13-2008.

A 2nd Chance Bail Bonds

SN 77-542,650. MYARCWORLD, INC., SAN ANTONIO, TX. FILED 8-8-2008.



THE MARK CONSISTS OF AN ARC WITH THE STYLIZED TEXT "MY ARCWORLD "ONE COMPANY...ONE SOURCE"".

FOR CREDIT CARD TRANSACTION PROCESSING SERVICES (U.S. CLS. 100, 101 AND 102).

FIRST USE 2-1-2005; IN COMMERCE 2-1-2005.

JULIE VEPPUMTHARA, EXAMINING ATTORNEY

THE MARK CONSISTS OF STANDARD CHARACTERS WITHOUT CLAIM TO ANY PARTICULAR FONT, STYLE, SIZE, OR COLOR.

NO CLAIM IS MADE TO THE EXCLUSIVE RIGHT TO USE "BAIL BONDS", APART FROM THE MARK AS SHOWN.

FOR BAIL BONDING (U.S. CLS. 100, 101 AND 102).

FIRST USE 3-1-2007; IN COMMERCE 3-1-2007.

ALEX KEAM, EXAMINING ATTORNEY

SN 77-548,339. VIST FINANCIAL, FORMERLY LEESPORT FINANCIAL, WYOMISSING, PA. FILED 8-15-2008.



THE COLOR(S) GRAY, ORANGE, YELLOW AND BROWN IS/ARE CLAIMED AS A FEATURE OF THE MARK.

THE MARK CONSISTS OF THE WORD "EQUILOCK"

CLASS 36—(Continued).

WHERE A PADLOCK FORMS THE LETTER "O" IN THE WORD "LOCK". THERE IS AN OUTLINE OF A HOUSE AROUND THE LETTERS "EQU" IN THE WORD "EQUI". THE COLOR GRAY APPEARS IN THE LETTERS "EQUI", THE TOP PORTION OF THE PADLOCK AND THE OUTLINE OF THE HOUSE. THE COLOR ORANGE APPEARS IN THE WORD "LOCK". THE COLOR YELLOW APPEARS IN THE BOTTOM CIRCULAR PORTION OF THE PADLOCK. THE COLOR BROWN APPEARS IN THE KEYHOLE PORTION OF THE PADLOCK.

FOR FINANCIAL SERVICES, NAMELY, HOME EQUITY LOANS AND LINES OF CREDIT (U.S. CLS. 100, 101 AND 102).

TINA BROWN, EXAMINING ATTORNEY

CLASS 36—(Continued).

SN 77-550,969. BLUE DIAMOND ENTERPRISE, LLC, COSTA MESA, CA. FILED 8-19-2008.



OWNER OF U.S. REG. NO. 3,034,113.
NO CLAIM IS MADE TO THE EXCLUSIVE RIGHT TO USE "BANKERS FUNDING", APART FROM THE MARK AS SHOWN.

THE MARK CONSISTS OF THE WORDS "BANKERS FUNDING" IN STYLIZED FONT COMBINED WITH A DESIGN THAT FEATURES THE LETTER "B" IN A CIRCLE AGAINST A SQUARE BACKGROUND.

FOR MORTGAGE BANKING; MORTGAGE BROKERAGE; MORTGAGE LENDING (U.S. CLS. 100, 101 AND 102).

FIRST USE 12-31-2007; IN COMMERCE 12-31-2007.
RUSS HERMAN, EXAMINING ATTORNEY

SN 77-549,138. AON CORPORATION, CHICAGO, IL. FILED 8-18-2008.

Aon ReSearch

SN 77-551,059. LIVE BALANCE FREE, LLC, DBA LIVE BALANCE FREE, LLC, KINGSTON, WA. FILED 8-19-2008.



THE MARK CONSISTS OF STANDARD CHARACTERS WITHOUT CLAIM TO ANY PARTICULAR FONT, STYLE, SIZE, OR COLOR.

OWNER OF U.S. REG. NOS. 1,496,123, 3,254,615 AND OTHERS.

NO CLAIM IS MADE TO THE EXCLUSIVE RIGHT TO USE "RESEARCH", APART FROM THE MARK AS SHOWN.

FOR INSURANCE SERVICES, NAMELY, PROVIDING INFORMATION AND ON-LINE COMPUTER DATABASES FOR THE PURPOSE OF ACCESSING AND REVIEWING DATA ON REINSURERS AND RELATED INFORMATION (U.S. CLS. 100, 101 AND 102).

FIRST USE 4-1-2008; IN COMMERCE 4-1-2008.
LAKEISHA LEWIS, EXAMINING ATTORNEY

THE COLOR(S) YELLOW, ORANGE, GOLD, BLACK, WHITE IS/ARE CLAIMED AS A FEATURE OF THE MARK.

THE MARK CONSISTS OF A DESIGN OF A SUN WITH A CHI GUY SITTING INSIDE. THE SUN CONSISTS OF THE COLORS YELLOW, ORANGE, GOLD AND WHITE FOR ITS OUTLINE; THE CHI GUY CONSISTS OF THE COLOR BLACK. THE LANGUAGE "LIVE BALANCE FREE" APPEARS IN BLACK UNDER THE DESIGN PORTION.

FOR FINANCIAL ANALYSIS AND CONSULTATION (U.S. CLS. 100, 101 AND 102).

FIRST USE 2-1-2008; IN COMMERCE 2-1-2008.
LAURIE MAYES, EXAMINING ATTORNEY

CLASS 36—(Continued).

SN 77-551,633. INVESTORS MORTGAGE HOLDINGS INC., SCOTTSDALE, AZ. FILED 8-20-2008.

SMART FINANCING - SELLER
MORTGAGES AT REASONABLE
TERMS

THE MARK CONSISTS OF STANDARD CHARACTERS WITHOUT CLAIM TO ANY PARTICULAR FONT, STYLE, SIZE, OR COLOR.

FOR FINANCIAL SERVICES, NAMELY, LOAN ORIGINATION, ACQUISITION, SERVICING, SECURITIZATION AND BROKERAGE; MONEY LENDING; MORTGAGE BANKING; LOAN SALES, NAMELY, PURCHASING AND BROKERING THE SALES OF LOANS AT PAR, PREMIUM, OR DISCOUNTS; MONEY LENDING VIA LOAN PARTICIPATIONS; PROVIDING SALES FINANCE LOANS; FACTORING AGENCIES; MAINTAINING MORTGAGE ESCROW ACCOUNTS; MORTGAGE BROKERAGE; MORTGAGE LENDING; MORTGAGE BANKING SERVICES, NAMELY, ORIGINATION, ACQUISITION, SERVICING, AND BROKERAGE OF MORTGAGE LOANS; MORTGAGE PROCUREMENT FOR OTHERS (U.S. CLS. 100, 101 AND 102).

ANDREA BUTLER, EXAMINING ATTORNEY

SN 77-551,637. INVESTORS MORTGAGE HOLDINGS INC., SCOTTSDALE, AZ. FILED 8-20-2008.

START – SALES TRANSACTION
AT REASONABLE TERMS

THE MARK CONSISTS OF STANDARD CHARACTERS WITHOUT CLAIM TO ANY PARTICULAR FONT, STYLE, SIZE, OR COLOR.

FOR FINANCIAL SERVICES, NAMELY, LOAN ORIGINATION, ACQUISITION, SERVICING, SECURITIZATION AND BROKERAGE; MONEY LENDING; MORTGAGE BANKING; LOAN SALES, NAMELY, PURCHASING AND BROKERING THE SALES OF LOANS AT PAR, PREMIUM, OR DISCOUNTS; MONEY LENDING VIA LOAN PARTICIPATIONS; PROVIDING SALES FINANCE LOANS; FACTORING AGENCIES; MAINTAINING MORTGAGE ESCROW ACCOUNTS; MORTGAGE BROKERAGE; MORTGAGE LENDING; MORTGAGE BANKING SERVICES, NAMELY, ORIGINATION, ACQUISITION, SERVICING, AND BROKERAGE OF MORTGAGE LOANS; MORTGAGE PROCUREMENT FOR OTHERS (U.S. CLS. 100, 101 AND 102).

ANDREA BUTLER, EXAMINING ATTORNEY

CLASS 36—(Continued).

SN 77-552,033. ANDRAOS CAPITAL MANAGEMENT, GLENDALE, CA. FILED 8-20-2008.

ANDRAOS CAPITAL MANAGEMENT

THE MARK CONSISTS OF STANDARD CHARACTERS WITHOUT CLAIM TO ANY PARTICULAR FONT, STYLE, SIZE, OR COLOR.

NO CLAIM IS MADE TO THE EXCLUSIVE RIGHT TO USE "CAPITAL MANAGEMENT", APART FROM THE MARK AS SHOWN.

SEC. 2(F).

FOR CONSULTATION CONCERNING FINANCIAL AFFAIRS; CONSULTATION CONCERNING MONETARY AFFAIRS; INSURANCE CONSULTATION; FINANCIAL ANALYSIS; CAPITAL INVESTMENT SERVICES; FINANCIAL CONSULTANCY; CONSULTANCY AND ADVISORY SERVICES IN RELATION TO FINANCIAL INVESTMENTS (U.S. CLS. 100, 101 AND 102).

FIRST USE 6-15-2000; IN COMMERCE 12-31-2000.

ALICIA COLLINS, EXAMINING ATTORNEY

SN 77-553,535. WEE, ERIC L., PASADENA, CA. FILED 8-22-2008.

TAHOEBLISS

THE MARK CONSISTS OF STANDARD CHARACTERS WITHOUT CLAIM TO ANY PARTICULAR FONT, STYLE, SIZE, OR COLOR.

FOR RENTAL OF VACATION HOMES AND CABINS; REAL ESTATE MANAGEMENT SERVICES IN THE FIELD OF HOUSES FOR TOURISTS (U.S. CLS. 100, 101 AND 102).

FIRST USE 12-2-2007; IN COMMERCE 12-2-2007.

DAWN FELDMAN, EXAMINING ATTORNEY

SN 77-554,559. AMERITAS HOLDING COMPANY, LINCOLN, NE. FILED 8-25-2008.

On Your Team. Toward Your
Goal.

THE MARK CONSISTS OF STANDARD CHARACTERS WITHOUT CLAIM TO ANY PARTICULAR FONT, STYLE, SIZE, OR COLOR.

FOR INSURANCE AND FINANCIAL SERVICES, NAMELY, ADMINISTRATION OF RETIREMENT PLANS AND/OR PROVIDING INDIVIDUAL RETIREMENT ACCOUNT SERVICES (U.S. CLS. 100, 101 AND 102).

FIRST USE 8-1-2007; IN COMMERCE 8-1-2007.

KEVON CHISOLM, EXAMINING ATTORNEY

CLASS 36—(Continued).

SN 77-559,279. CFO4LIFE, INC., COPPELL, TX. FILED 8-29-2008.



THE COLOR(S) GREY, RED, AND BLACK IS/ARE CLAIMED AS A FEATURE OF THE MARK.

THE MARK CONSISTS OF FOUR ARROWS CIRCLING THE WORD "CFO4LIFE" IN A CLOCKWISE MANNER, WITH ALTERNATING RED AND GREY ARROWS, AND THE WORDS "CFO4LIFE" ARE IN BLACK WITH A RED FLAME MARK OVER THE LETTER 'T', WHICH LETTER IS IN THE FORM OF A TORCH. THE COLOR WHITE INDICATES TRANSPARENT AREAS AND IS NOT A PART OF THE MARK.

FOR FINANCIAL PLANNING (U.S. CLS. 100, 101 AND 102).

FIRST USE 1-1-2007; IN COMMERCE 1-1-2007.
CAROL SPILS, EXAMINING ATTORNEY

SN 77-559,995. ZERINGUE, STEVE, CHICAGO, IL. FILED 9-2-2008.

PAYAWAY

THE MARK CONSISTS OF STANDARD CHARACTERS WITHOUT CLAIM TO ANY PARTICULAR FONT, STYLE, SIZE, OR COLOR.

FOR CREDIT AND LOAN SERVICES; EVALUATION OF THE CREDIT WORTHINESS OF COMPANIES AND PRIVATE INDIVIDUALS; INSTALLMENT LOANS; LOAN FINANCING (U.S. CLS. 100, 101 AND 102).

JAMES MACFARLANE, EXAMINING ATTORNEY

SN 77-560,186. AON CORPORATION, CHICAGO, IL. FILED 9-2-2008.

AON CLASSIC

THE MARK CONSISTS OF STANDARD CHARACTERS WITHOUT CLAIM TO ANY PARTICULAR FONT, STYLE, SIZE, OR COLOR.

OWNER OF U.S. REG. NOS. 1,496,123, 3,254,615 AND OTHERS.

FOR ANNUITY UNDERWRITING AND INVESTMENT MANAGEMENT OF AND DISTRIBUTION OF ANNUITIES (U.S. CLS. 100, 101 AND 102).

LAKEISHA LEWIS, EXAMINING ATTORNEY

CLASS 36—(Continued).

SN 77-560,188. THE FOUNDATION FOR FIGHTING T-CELL LYMPHOMA, GULFPORT, MS. FILED 9-2-2008.



THE MARK CONSISTS OF THE STYLIZED WORDS "WHEN YOUR ROAD BENDS" WRITTEN ON A RIBBON.

FOR FUND RAISING SERVICES, NAMELY, ORGANIZING, ARRANGING AND CONDUCTING FUND RAISING PROGRAMS FOR THE BENEFIT OF SCHOOLS AND NON-PROFIT ORGANIZATIONS (U.S. CLS. 100, 101 AND 102).

TARA PATE, EXAMINING ATTORNEY

SN 77-560,505. MONEY MOVERS OF AMERICA, INC., WESTCHESTER, IL. FILED 9-2-2008.

PINK PAY

THE MARK CONSISTS OF STANDARD CHARACTERS WITHOUT CLAIM TO ANY PARTICULAR FONT, STYLE, SIZE, OR COLOR.

NO CLAIM IS MADE TO THE EXCLUSIVE RIGHT TO USE "PAY", APART FROM THE MARK AS SHOWN.

FOR CHARITABLE FUND RAISING; PAYMENT PROCESSING SERVICES, NAMELY, CREDIT CARD AND DEBIT CARD TRANSACTION PROCESSING SERVICES (U.S. CLS. 100, 101 AND 102).

LINDA M. KING, EXAMINING ATTORNEY

SN 77-560,507. THE TCW GROUP INC., LOS ANGELES, CA. FILED 9-2-2008.

TCW INSIGHT THAT WORKS FOR YOU

THE MARK CONSISTS OF STANDARD CHARACTERS WITHOUT CLAIM TO ANY PARTICULAR FONT, STYLE, SIZE, OR COLOR.

OWNER OF U.S. REG. NOS. 1,731,608, 3,427,532 AND OTHERS.

FOR INVESTMENT MANAGEMENT, INVESTMENT CONSULTATION AND INVESTMENT ADVISORY SERVICES (U.S. CLS. 100, 101 AND 102).

SUZANNE BLANE, EXAMINING ATTORNEY

CLASS 36—(Continued).

SN 77-560,577. GERRI-LYNN FIVES, SAN DIEGO, CA. FILED 9-2-2008.

**EXPECT MORE THAN A
HOME.....CREATE A
LIFESTYLE IN CORONADO!**

THE MARK CONSISTS OF STANDARD CHARACTERS WITHOUT CLAIM TO ANY PARTICULAR FONT, STYLE, SIZE, OR COLOR.

FOR PROVIDING INFORMATION IN THE FIELD OF REAL ESTATE VIA THE INTERNET; PROVIDING REAL ESTATE LISTINGS AND REAL ESTATE INFORMATION VIA THE INTERNET; REAL ESTATE ACQUISITION SERVICES; LAND ACQUISITION, NAMELY, REAL ESTATE BROKERAGE; REAL ESTATE AGENCIES; REAL ESTATE BROKERAGE; REAL ESTATE CONSULTATION; REAL ESTATE LISTING (U.S. CLS. 100, 101 AND 102).

FIRST USE 7-1-2008; IN COMMERCE 7-1-2008.
EMILY CHUO, EXAMINING ATTORNEY



SN 77-561,069. THE TCW GROUP INC., LOS ANGELES, CA. FILED 9-3-2008.

INSIGHT THAT WORKS FOR YOU

THE MARK CONSISTS OF STANDARD CHARACTERS WITHOUT CLAIM TO ANY PARTICULAR FONT, STYLE, SIZE, OR COLOR.

OWNER OF U.S. REG. NOS. 1,731,608, 3,427,532 AND OTHERS.

FOR INVESTMENT MANAGEMENT, INVESTMENT CONSULTATION AND INVESTMENT ADVISORY SERVICES (U.S. CLS. 100, 101 AND 102).

SUZANNE BLANE, EXAMINING ATTORNEY



SN 77-561,410. TULSA TEACHERS CREDIT UNION, TULSA, OK. FILED 9-3-2008.

YOU SWIPE, WE DONATE.

THE MARK CONSISTS OF STANDARD CHARACTERS WITHOUT CLAIM TO ANY PARTICULAR FONT, STYLE, SIZE, OR COLOR.

FOR BANKING SERVICES AND DEBIT CARD SERVICES (U.S. CLS. 100, 101 AND 102).

FIRST USE 11-1-2007; IN COMMERCE 11-1-2007.
NICHOLAS COLEMAN, EXAMINING ATTORNEY

CLASS 36—(Continued).

SN 77-561,679. GLEN LAKE APARTMENTS, LLC, WEST PALM BEACH, FL. FILED 9-3-2008.

**GLEN LAKE A RESIDENTIAL
RESORT**

THE MARK CONSISTS OF STANDARD CHARACTERS WITHOUT CLAIM TO ANY PARTICULAR FONT, STYLE, SIZE, OR COLOR.

NO CLAIM IS MADE TO THE EXCLUSIVE RIGHT TO USE "A RESIDENTIAL RESORT", APART FROM THE MARK AS SHOWN.

FOR LEASING OF APARTMENTS; LEASING OF REAL ESTATE; REAL ESTATE MANAGEMENT; RENTAL OF APARTMENTS (U.S. CLS. 100, 101 AND 102).

ESTHER BELENKER, EXAMINING ATTORNEY



SN 77-561,686. GLEN LAKE APARTMENTS, LLC, WEST PALM BEACH, FL. FILED 9-3-2008.



GLEN LAKE
A RESIDENTIAL RESORT

NO CLAIM IS MADE TO THE EXCLUSIVE RIGHT TO USE "A RESIDENTIAL RESORT", APART FROM THE MARK AS SHOWN.

THE MARK CONSISTS OF A STYLIZED CRESCENT MOON TO THE LEFT OF A STARRY SKY, ALL WITHIN A DARK CIRCLE. ABOVE THE WORDS "GLEN LAKE A RESIDENTIAL RESORT", WHICH IS SHOWN IN STYLIZED, UPPER-CASE FONT.

FOR LEASING OF APARTMENTS; LEASING OF REAL ESTATE; REAL ESTATE MANAGEMENT; RENTAL OF APARTMENTS (U.S. CLS. 100, 101 AND 102).

ESTHER BELENKER, EXAMINING ATTORNEY

CLASS 36—(Continued).

SN 77-561,804. GAST, CATHERINE, WAYLAND, MA. FILED 9-3-2008.

MONEY AMENDS\$

THE MARK CONSISTS OF STANDARD CHARACTERS WITHOUT CLAIM TO ANY PARTICULAR FONT, STYLE, SIZE, OR COLOR.

NO CLAIM IS MADE TO THE EXCLUSIVE RIGHT TO USE "MONEY", APART FROM THE MARK AS SHOWN.

FOR FINANCIAL ADVISORY AND CONSULTANCY SERVICES; FINANCIAL INFORMATION AND ADVISORY SERVICES; FINANCIAL INFORMATION AND EVALUATIONS; FINANCIAL MANAGEMENT (U.S. CLS. 100, 101 AND 102).

FIRST USE 6-17-2008; IN COMMERCE 7-1-2008.
ANGELA GAW, EXAMINING ATTORNEY

SN 77-561,928. VANBREDA INTERNATIONAL, NAAMLOZE VENNOOTSCHAP, ANTWERP, BELGIUM, FILED 9-4-2008.

access to health

THE MARK CONSISTS OF STANDARD CHARACTERS WITHOUT CLAIM TO ANY PARTICULAR FONT, STYLE, SIZE, OR COLOR.

FOR ACCIDENT INSURANCE UNDERWRITING; ADMINISTRATION OF EMPLOYEE BENEFIT PLANS CONCERNING INSURANCE AND FINANCE; APPRAISALS FOR INSURANCE CLAIMS OF PERSONAL PROPERTY; APPRAISALS FOR INSURANCE CLAIMS OF REAL ESTATE; ARRANGING AND PROVISION OF CREDIT, LOANS, INSURANCE, CURRENCY EXCHANGE AND TRAVELLERS CHEQUES; CLAIMS ADJUSTMENT IN THE FIELD OF INSURANCE; CLAIMS ADMINISTRATION SERVICES IN THE FIELD OF HEALTH INSURANCE; DENTAL HEALTH INSURANCE ADMINISTRATION; DENTAL HEALTH INSURANCE UNDERWRITING AND ADMINISTRATION; FINANCIAL CONSULTANCY AND INSURANCE CONSULTANCY; FINANCIAL EVALUATION FOR INSURANCE PURPOSES; FIRE INSURANCE UNDERWRITING; HEALTH INSURANCE UNDERWRITING; HEALTHCARE INSURANCE SERVICES FOR LASIK SURGERY; INSURANCE ACTUARIAL SERVICES; INSURANCE ADMINISTRATION; INSURANCE ADMINISTRATION IN THE FIELD OF HEALTH CARE; INSURANCE AGENCIES; INSURANCE AGENCIES IN THE FIELD OF HEALTH CARE; INSURANCE AGENCY AND BROKERAGE; INSURANCE AND FINANCIAL INFORMATION AND CONSULTANCY SERVICES; INSURANCE BROKERAGE; INSURANCE CLAIMS ADMINISTRATION; INSURANCE CLAIMS PROCESSING; INSURANCE CONSULTANCY; INSURANCE CONSULTANCY SERVICES, NAMELY, PROVIDING ADVICE IN THE FIELD OF PROPERTY AND CASUALTY INSURANCE; INSURANCE INFORMATION AND CONSULTANCY; INSURANCE SERVICES, NAMELY, PROVIDING INFORMATION AND ON-LINE COMPUTER DATABASES FOR THE PURPOSE OF REVIEW AND VERIFICATION OF MEDICAID ELIGIBILITY STATUS AND RELATED

CLASS 36—(Continued).

INFORMATION; INSURANCE SERVICES, NAMELY, UNDERWRITING, ISSUING AND ADMINISTRATION OF LIFE INSURANCE; INSURANCE UNDERWRITING IN THE FIELD OF HEALTH CARE; INSURANCE UNDERWRITING SERVICES FOR ALL TYPES OF INSURANCE; LIFE INSURANCE BROKERAGE; LIFE INSURANCE UNDERWRITING; MEDICAL INSURANCE CASE AND UTILIZATION REVIEW AND INSURANCE CLAIMS ADJUSTMENT SERVICES FOR HEALTHCARE PURCHASERS AND PAYORS AND PROVIDERS AND MEDICARE BENEFICIARIES; MEDICAL INSURANCE UNDERWRITING; PROVIDING A DATABASE FOR TRACKING, MONITORING, AND GENERATING REPORTS ON INFORMATION AND STATISTICS ABOUT PATIENT REIMBURSEMENT AND INSURANCE COVERAGE FOR PHARMACEUTICALS AND MEDICAL DEVICES; PROVIDING INFORMATION IN INSURANCE MATTERS; UNDERWRITING INSURANCE FOR PRE-PAID HEALTH CARE; UNDERWRITING INSURANCE FOR PRE-PAID LEGAL SERVICES (U.S. CLS. 100, 101 AND 102).

NICHOLAS ALTREE, EXAMINING ATTORNEY

SN 77-562,577. TEXAS DOW EMPLOYEES CREDIT UNION, LAKE JACKSON, TX. FILED 9-4-2008.

Triple the Buying Power

THE MARK CONSISTS OF STANDARD CHARACTERS WITHOUT CLAIM TO ANY PARTICULAR FONT, STYLE, SIZE, OR COLOR.

FOR FINANCIAL SERVICES, NAMELY, CREDIT CARD SERVICES (U.S. CLS. 100, 101 AND 102).

PAUL E. FAHRENKOPF, EXAMINING ATTORNEY

SN 77-562,622. ADVOCATES FOR CLERGY, LLC, CLEVELAND HTS., OH. FILED 9-4-2008.

Loaves and Fishes

THE MARK CONSISTS OF STANDARD CHARACTERS WITHOUT CLAIM TO ANY PARTICULAR FONT, STYLE, SIZE, OR COLOR.

FOR FINANCIAL ADVICE FOR CLERGY (U.S. CLS. 100, 101 AND 102).

DOUGLAS LEE, EXAMINING ATTORNEY

CLASS 36—(Continued).

SN 77-563,156. ALLIANZ SE, MUNCHEN, FED REP GER-MANY, FILED 9-5-2008.

ALLIANZ HAS SOLVED THE PENGUIN PROBLEM.

THE MARK CONSISTS OF STANDARD CHARACTERS WITHOUT CLAIM TO ANY PARTICULAR FONT, STYLE, SIZE, OR COLOR.

OWNER OF U.S. REG. NOS. 2,145,557, 2,256,628 AND 2,391,129.

THE FOREIGN WORDING IN THE MARK TRANSLATES INTO ENGLISH AS ALLIANCE.

FOR ANNUITY UNDERWRITING; FINANCIAL ADVICE AND CONSULTANCY SERVICES; FINANCIAL CONSULTATION IN THE FIELD OF ANNUITIES; INSURANCE ACTUARIAL SERVICES; INSURANCE ADMINISTRATION; INSURANCE AGENCY AND BROKERAGE; INSURANCE AND FINANCIAL INFORMATION AND CONSULTANCY SERVICES; INSURANCE CLAIMS ADMINISTRATION; INSURANCE CLAIMS PROCESSING; INSURANCE INFORMATION AND CONSULTANCY (U.S. CLS. 100, 101 AND 102).

FIRST USE 9-4-2008; IN COMMERCE 9-4-2008.
JEFF DEFORD, EXAMINING ATTORNEY

SN 77-563,368. THE MOTLEY FOOL HOLDINGS, INC., ALEXANDRIA, VA. FILED 9-5-2008.

DECLARE YOUR INDEPENDENCE

THE MARK CONSISTS OF STANDARD CHARACTERS WITHOUT CLAIM TO ANY PARTICULAR FONT, STYLE, SIZE, OR COLOR.

FOR ASSET MANAGEMENT SERVICES; HEDGE FUND INVESTMENT SERVICES; MUTUAL FUND INVESTMENT SERVICES; FINANCIAL PLANNING AND INVESTMENT ADVISORY SERVICES (U.S. CLS. 100, 101 AND 102).

JAMES GRIFFIN, EXAMINING ATTORNEY

CLASS 36—(Continued).

SN 77-563,599. BELLABAY REALTY, LLC, GRAND RAPIDS, MI. FILED 9-5-2008.

Bellabay

THE MARK CONSISTS OF STANDARD CHARACTERS WITHOUT CLAIM TO ANY PARTICULAR FONT, STYLE, SIZE, OR COLOR.

"BELLABAY" APPEARING IN THE MARK HAS NO SIGNIFICANCE IN THE RELEVANT TRADE OR INDUSTRY OR AS APPLIED TO THE GOODS/SERVICES LISTED IN THE APPLICATION, NO GEOGRAPHICAL SIGNIFICANCE, NOR ANY MEANING IN A FOREIGN LANGUAGE.

FOR REAL ESTATE BROKERAGE; REAL ESTATE MANAGEMENT (U.S. CLS. 100, 101 AND 102).
FIRST USE 1-1-2007; IN COMMERCE 1-1-2007.
KEVON CHISOLM, EXAMINING ATTORNEY

SN 77-563,658. HOWLETT CONSULTING GROUP LLC, NEW ALBANY, IN. FILED 9-5-2008.

SIMPLY FAIR AND FREE

THE MARK CONSISTS OF STANDARD CHARACTERS WITHOUT CLAIM TO ANY PARTICULAR FONT, STYLE, SIZE, OR COLOR.

FOR BANKING SERVICES (U.S. CLS. 100, 101 AND 102).
JORDAN BAKER, EXAMINING ATTORNEY

SN 77-563,674. HOWLETT CONSULTING GROUP LLC, NEW ALBANY, IN. FILED 9-5-2008.

SIMPLY FAIR

THE MARK CONSISTS OF STANDARD CHARACTERS WITHOUT CLAIM TO ANY PARTICULAR FONT, STYLE, SIZE, OR COLOR.

FOR BANKING SERVICES (U.S. CLS. 100, 101 AND 102).
JORDAN BAKER, EXAMINING ATTORNEY

CLASS 36—(Continued).

SN 77-563,692. HOWLETT CONSULTING GROUP LLC, NEW ALBANY, IN. FILED 9-5-2008.

FREE AND FAIR

THE MARK CONSISTS OF STANDARD CHARACTERS WITHOUT CLAIM TO ANY PARTICULAR FONT, STYLE, SIZE, OR COLOR.

FOR BANKING SERVICES (U.S. CLS. 100, 101 AND 102).

JORDAN BAKER, EXAMINING ATTORNEY

SN 77-563,702. HOWLETT CONSULTING GROUP LLC, NEW ALBANY, IN. FILED 9-5-2008.

NO GOUGE

THE MARK CONSISTS OF STANDARD CHARACTERS WITHOUT CLAIM TO ANY PARTICULAR FONT, STYLE, SIZE, OR COLOR.

FOR BANKING SERVICES (U.S. CLS. 100, 101 AND 102).

JORDAN BAKER, EXAMINING ATTORNEY

SN 77-563,763. TRANSAMERICA FINANCIAL LIFE INSURANCE COMPANY, FORMERLY TRANSAMERICA LIFE INSURANCE COMPANY OF NEW YORK, PURCHASE, NY. FILED 9-5-2008.

WRAPPLAN

THE MARK CONSISTS OF STANDARD CHARACTERS WITHOUT CLAIM TO ANY PARTICULAR FONT, STYLE, SIZE, OR COLOR.

FOR LIFE INSURANCE UNDERWRITING (U.S. CLS. 100, 101 AND 102).

FIRST USE 1-1-1996; IN COMMERCE 1-1-1996.

FRED CARL, EXAMINING ATTORNEY

CLASS 36—(Continued).

SN 77-563,790. WASATCH FRONT REGIONAL MULTIPLE LISTING SERVICE, INC., SANDY, UT. FILED 9-5-2008.

METIS

THE MARK CONSISTS OF STANDARD CHARACTERS WITHOUT CLAIM TO ANY PARTICULAR FONT, STYLE, SIZE, OR COLOR.

FOR ONLINE SYSTEM FOR PROVIDING REAL ESTATE MULTIPLE LISTING SERVICES; PROVIDING ONLINE A DATABASE OF REAL ESTATE LISTINGS AND REAL ESTATE INFORMATION FOR REAL ESTATE PROFESSIONALS WHO ARE SUBSCRIBERS TO THE MULTIPLE LISTING SERVICE (U.S. CLS. 100, 101 AND 102).

KELLY MCCOY, EXAMINING ATTORNEY

SN 77-564,201. THE HOME SAVINGS AND LOAN COMPANY, YOUNGSTOWN, OH. FILED 9-8-2008.

Stepping Stone

THE MARK CONSISTS OF STANDARD CHARACTERS WITHOUT CLAIM TO ANY PARTICULAR FONT, STYLE, SIZE, OR COLOR.

FOR CHECKING ACCOUNT SERVICES (U.S. CLS. 100, 101 AND 102).

JACQUELINE A. LAVINE, EXAMINING ATTORNEY

SN 77-564,356. TRAVELERS AID & HOMELESS ASSISTANCE CENTER, INC., OKLAHOMA CITY, OK. FILED 9-8-2008.

UPWARD TRANSITIONS

THE MARK CONSISTS OF STANDARD CHARACTERS WITHOUT CLAIM TO ANY PARTICULAR FONT, STYLE, SIZE, OR COLOR.

FOR CHARITABLE FUND RAISING SERVICES, NAMELY, ORGANIZING AND CONDUCTING FUNDRAISING PROGRAMS (U.S. CLS. 100, 101 AND 102).

MICHAEL ENGEL, EXAMINING ATTORNEY

CLASS 36—(Continued).

SN 77-564,678. CNL INTELLECTUAL PROPERTIES, INC., ORLANDO, FL. FILED 9-8-2008.

CNL GLOBAL REAL ESTATE FUND

THE MARK CONSISTS OF STANDARD CHARACTERS WITHOUT CLAIM TO ANY PARTICULAR FONT, STYLE, SIZE, OR COLOR.

OWNER OF U.S. REG. NOS. 1,478,007, 3,006,086 AND OTHERS.

NO CLAIM IS MADE TO THE EXCLUSIVE RIGHT TO USE "GLOBAL REAL ESTATE FUND", APART FROM THE MARK AS SHOWN.

FOR INVESTMENT SERVICES FOR MUTUAL FUNDS; BROKERAGE SERVICES FOR MUTUAL FUNDS; MANAGEMENT SERVICES FOR MUTUAL FUNDS; INVESTMENT OF FUNDS OF OTHERS (U.S. CLS. 100, 101 AND 102).

KEVIN DINALLO, EXAMINING ATTORNEY

SN 77-564,688. CNL INTELLECTUAL PROPERTIES, INC., ORLANDO, FL. FILED 9-8-2008.

THE CNL FUNDS

THE MARK CONSISTS OF STANDARD CHARACTERS WITHOUT CLAIM TO ANY PARTICULAR FONT, STYLE, SIZE, OR COLOR.

OWNER OF U.S. REG. NOS. 1,478,007, 3,006,086 AND OTHERS.

NO CLAIM IS MADE TO THE EXCLUSIVE RIGHT TO USE "FUNDS", APART FROM THE MARK AS SHOWN.

FOR INVESTMENT SERVICES FOR MUTUAL FUNDS AND MONEY MARKET FUNDS; BROKERAGE SERVICES FOR MUTUAL FUNDS AND MONEY MARKET FUNDS; MANAGEMENT SERVICES FOR MUTUAL FUNDS AND MONEY MARKET FUNDS; INVESTMENT OF FUNDS OF OTHERS (U.S. CLS. 100, 101 AND 102).

KEVIN DINALLO, EXAMINING ATTORNEY

SN 77-564,731. ITS TIME TO DONATE, INC., NORTH-BROOK, IL. FILED 9-8-2008.

ITS TIME TO DONATE

THE MARK CONSISTS OF STANDARD CHARACTERS WITHOUT CLAIM TO ANY PARTICULAR FONT, STYLE, SIZE, OR COLOR.

FOR FUNDRAISING SERVICES, NAMELY, ASSISTING THIRD PARTIES IN FUNDRAISING ACTIVITIES (U.S. CLS. 100, 101 AND 102).

FIRST USE 3-1-2008; IN COMMERCE 3-1-2008.

WILLIAM P. SHANAHAN, EXAMINING ATTORNEY

CLASS 36—(Continued).

SN 77-564,757. DREAM TOWN REALTY, INC., CHICAGO, IL. FILED 9-8-2008.

FIND EXACTLY WHAT YOU'RE LOOKING FOR

THE MARK CONSISTS OF STANDARD CHARACTERS WITHOUT CLAIM TO ANY PARTICULAR FONT, STYLE, SIZE, OR COLOR.

FOR REAL ESTATE BROKERAGE SERVICES (U.S. CLS. 100, 101 AND 102).

CHRISTINA SOBRAL, EXAMINING ATTORNEY

SN 77-564,760. PRIVATE WEALTH GROUP, LLC, TAMPA, FL. FILED 9-8-2008.

PWG

THE MARK CONSISTS OF STANDARD CHARACTERS WITHOUT CLAIM TO ANY PARTICULAR FONT, STYLE, SIZE, OR COLOR.

FOR INVESTMENT ADVISORY SERVICES (U.S. CLS. 100, 101 AND 102).

FIRST USE 11-10-2003; IN COMMERCE 11-10-2003.

NATALIE POLZER, EXAMINING ATTORNEY

SN 77-564,856. CALVERT GROUP, LTD., BETHESDA, MD. FILED 9-8-2008.

H2Oportunity

THE MARK CONSISTS OF STANDARD CHARACTERS WITHOUT CLAIM TO ANY PARTICULAR FONT, STYLE, SIZE, OR COLOR.

FOR FINANCIAL AND INVESTMENT SERVICES, NAMELY, MANAGEMENT AND BROKERAGE IN THE FIELDS OF STOCKS, BONDS, OPTIONS, COMMODITIES, FUTURES AND OTHER SECURITIES, AND THE INVESTMENT OF FUNDS OF OTHERS (U.S. CLS. 100, 101 AND 102).

GEOFFREY FOSDICK, EXAMINING ATTORNEY

CLASS 36—(Continued).

SN 77-565,492. WACHOVIA CORPORATION, CHARLOTTE, NC. FILED 9-9-2008.

WACHOVIA HEDGEWISE

THE MARK CONSISTS OF STANDARD CHARACTERS WITHOUT CLAIM TO ANY PARTICULAR FONT, STYLE, SIZE, OR COLOR.

FOR FINANCIAL SERVICES, NAMELY, PROVIDING INFORMATION ON-LINE IN THE FIELD OF DERIVATIVES INVESTMENTS AND PROVIDING INFORMATION AS TO CLIENTS' DERIVATIVES INVESTMENT PORTFOLIO TRANSACTIONS AND ACTIVITIES (U.S. CLS. 100, 101 AND 102).

JACQUELINE A. LAVINE, EXAMINING ATTORNEY

SN 77-565,512. WACHOVIA CORPORATION, CHARLOTTE, NC. FILED 9-9-2008.

HEDGEWISE

THE MARK CONSISTS OF STANDARD CHARACTERS WITHOUT CLAIM TO ANY PARTICULAR FONT, STYLE, SIZE, OR COLOR.

FOR FINANCIAL SERVICES, NAMELY, PROVIDING INFORMATION ON-LINE IN THE FIELD OF DERIVATIVES INVESTMENTS AND PROVIDING INFORMATION AS TO CLIENTS' DERIVATIVES INVESTMENT PORTFOLIO TRANSACTIONS AND ACTIVITIES (U.S. CLS. 100, 101 AND 102).

JACQUELINE A. LAVINE, EXAMINING ATTORNEY

SN 77-565,609. MECKLENBURG CITIZENS FOR PUBLIC EDUCATION, CHARLOTTE, NC. FILED 9-9-2008.

MECKED

THE MARK CONSISTS OF STANDARD CHARACTERS WITHOUT CLAIM TO ANY PARTICULAR FONT, STYLE, SIZE, OR COLOR.

FOR CHARITABLE FUNDRAISING SERVICES (U.S. CLS. 100, 101 AND 102).

EMILY CHUO, EXAMINING ATTORNEY

CLASS 36—(Continued).

SN 77-565,768. THE TRUSTEES OF THE WISEMAN FAMILY TRUST, THE TRUSTEES COMPRISING TROY D. WISEMAN, A U.S. CITIZEN AND TINA WISEMAN, A U.S. CITIZEN, BARRINGTON HILLS, IL. FILED 9-9-2008.

TRILINC

THE MARK CONSISTS OF STANDARD CHARACTERS WITHOUT CLAIM TO ANY PARTICULAR FONT, STYLE, SIZE, OR COLOR.

FOR FINANCIAL PLANNING AND INVESTMENT ADVICE, PRIVATE EQUITY FUNDS INVESTMENT, REAL ESTATE INVESTMENTS, REAL ESTATE DEVELOPMENT, INVESTMENT IN SECURITIES AND MUTUAL FUNDS, CHARITABLE FUND RAISING SERVICES (U.S. CLS. 100, 101 AND 102).

ESTHER BELENKER, EXAMINING ATTORNEY

SN 77-565,825. GENERAL ATLANTIC SERVICE COMPANY, LLC, GREENWICH, CT. FILED 9-9-2008.

General Atlantic 

OWNER OF U.S. REG. NOS. 2,948,417, 3,166,363 AND 3,289,919.

THE MARK CONSISTS OF THE WORDS "GENERAL ATLANTIC" IN A TYPED FONT TO THE LEFT OF A SHADED CIRCLE HAVING TWO LIGHT-COLORED, INTERTWINING LINES CURVING ACROSS IT.

FOR FINANCIAL SERVICES, NAMELY, PRIVATE EQUITY INVESTMENT, GROWTH INVESTMENT, VENTURE CAPITAL INVESTMENT, FINANCIAL INVESTMENT IN COMPANIES DRIVEN BY INFORMATION TECHNOLOGY OR INTELLECTUAL PROPERTY, INVESTMENT MANAGEMENT AND INVESTMENT OF FUNDS FOR OTHERS (U.S. CLS. 100, 101 AND 102).

FIRST USE 9-20-2005; IN COMMERCE 9-20-2005.

ESTHER BELENKER, EXAMINING ATTORNEY

SN 77-565,830. THE TRUSTEES OF THE WISEMAN FAMILY TRUST, BARRINGTON HILLS, IL. FILED 9-9-2008.

WISDOM THROUGH EXPERIENCE

THE MARK CONSISTS OF STANDARD CHARACTERS WITHOUT CLAIM TO ANY PARTICULAR FONT, STYLE, SIZE, OR COLOR.

FOR FINANCIAL PLANNING AND INVESTMENT ADVICE, PRIVATE EQUITY FUNDS INVESTMENT, REAL ESTATE INVESTMENTS, REAL ESTATE DEVELOPMENT, INVESTMENT IN SECURITIES AND MUTUAL FUNDS, CHARITABLE FUND RAISING SERVICES (U.S. CLS. 100, 101 AND 102).

ESTHER BELENKER, EXAMINING ATTORNEY

CLASS 36—(Continued).

SN 77-565,833. LITERACY PARTNERS, NEW YORK, NY. FILED 9-9-2008.

EVERYONE DESERVES A CHANCE
TO READ.

THE MARK CONSISTS OF STANDARD CHARACTERS WITHOUT CLAIM TO ANY PARTICULAR FONT, STYLE, SIZE, OR COLOR.

FOR CHARITABLE FUND RAISING SERVICES; ACCEPTING AND ADMINISTERING MONETARY CHARITABLE CONTRIBUTIONS (U.S. CLS. 100, 101 AND 102).
CHERYL CLAYTON, EXAMINING ATTORNEY

SN 77-565,852. AMERICAN INTERNATIONAL GROUP, INC., NEW YORK, NY. FILED 9-9-2008.

OPTO VALUE

THE MARK CONSISTS OF STANDARD CHARACTERS WITHOUT CLAIM TO ANY PARTICULAR FONT, STYLE, SIZE, OR COLOR.

NO CLAIM IS MADE TO THE EXCLUSIVE RIGHT TO USE "VALUE", APART FROM THE MARK AS SHOWN.

FOR INSURANCE UNDERWRITING IN THE FIELD OF PROFESSIONAL LIABILITY AND GENERAL LIABILITY (U.S. CLS. 100, 101 AND 102).

ANGELA GAW, EXAMINING ATTORNEY

SN 77-565,855. THE LUTHERAN HOME ASSOCIATION, BELLE PLAINE, MN. FILED 9-9-2008.

A Community of Purpose

THE MARK CONSISTS OF STANDARD CHARACTERS WITHOUT CLAIM TO ANY PARTICULAR FONT, STYLE, SIZE, OR COLOR.

FOR INDEPENDENT LIVING SERVICES, NAMELY, RENTING OF APARTMENTS TO SENIOR CITIZENS (U.S. CLS. 100, 101 AND 102).

ANGELA GAW, EXAMINING ATTORNEY

CLASS 36—(Continued).

SN 77-566,113. BEANSTALK FOUNDATION, DENVER, CO. FILED 9-9-2008.

BEANSTALK FOUNDATION

THE MARK CONSISTS OF STANDARD CHARACTERS WITHOUT CLAIM TO ANY PARTICULAR FONT, STYLE, SIZE, OR COLOR.

NO CLAIM IS MADE TO THE EXCLUSIVE RIGHT TO USE "FOUNDATION", APART FROM THE MARK AS SHOWN.

FOR CHARITABLE FUND RAISING SERVICES AND ADMINISTERING MONETARY CHARITABLE CONTRIBUTIONS (U.S. CLS. 100, 101 AND 102).

FIRST USE 3-0-2008; IN COMMERCE 3-0-2008.
SUE LAWRENCE, EXAMINING ATTORNEY

SN 77-566,124. LIBERTY TREE FINANCIAL SERVICES, INC., UNION, NE. FILED 9-9-2008.

F. A. T. E.

THE MARK CONSISTS OF STANDARD CHARACTERS WITHOUT CLAIM TO ANY PARTICULAR FONT, STYLE, SIZE, OR COLOR.

FOR BROKERAGE IN THE FIELD OF FIXED INSURANCE AND SECURITIES (U.S. CLS. 100, 101 AND 102).

EVELYN BRADLEY, EXAMINING ATTORNEY

SN 77-566,291. AVESIS, AKA AVESIS THIRD PARTY ADMINISTRATORS, OWINGS MILLS, MD. FILED 9-10-2008.

**i
care
u care
we all care
for eye care**

THE MARK CONSISTS OF STANDARD CHARACTERS WITHOUT CLAIM TO ANY PARTICULAR FONT, STYLE, SIZE, OR COLOR.

FOR THIRD PARTY ADMINISTRATION OF EMPLOYEE BENEFIT PROGRAMS (U.S. CLS. 100, 101 AND 102).

PAM WILLIS, EXAMINING ATTORNEY

CLASS 36—(Continued).

SN 77-566,351. LITERACY PARTNERS, NEW YORK, NY.
FILED 9-10-2008.



THE MARK CONSISTS OF THE IMAGE OF SIX HANDS REACHING UPWARD TOWARD AN OPEN BOOK.
FOR CHARITABLE FUND RAISING SERVICES; ACCEPTING AND ADMINISTERING MONETARY CHARITABLE CONTRIBUTIONS (U.S. CLS. 100, 101 AND 102).
CHERYL CLAYTON, EXAMINING ATTORNEY

SN 77-566,493. SUN CREDIT UNION, HOLLYWOOD, FL.
FILED 9-10-2008.



NO CLAIM IS MADE TO THE EXCLUSIVE RIGHT TO USE "CREDIT UNION", APART FROM THE MARK AS SHOWN.

THE COLOR(S) BLUE, ORANGE AND WHITE IS/ARE CLAIMED AS A FEATURE OF THE MARK.

THE MARK CONSISTS OF THE WORDING "SUN CREDIT UNION" IN BLUE IN A STYLIZED FONT SUPERIMPOSED OVER A DESIGN OF AN ORANGE AND WHITE SUN ABOVE A LIGHT BLUE WAVE.

FOR CREDIT UNION SERVICES (U.S. CLS. 100, 101 AND 102).

FIRST USE 4-30-2008; IN COMMERCE 4-30-2008.
RENEE MCCRAY, EXAMINING ATTORNEY

CLASS 36—(Continued).

SN 77-566,848. DUN & BRADSTREET, INC., SHORT HILLS, NJ. FILED 9-10-2008.

LIVECAPITAL

THE MARK CONSISTS OF STANDARD CHARACTERS WITHOUT CLAIM TO ANY PARTICULAR FONT, STYLE, SIZE, OR COLOR.

FOR LOAN FINANCING AND PROVIDING FINANCIAL INFORMATION RELATING TO LOANS AND LINES OF CREDIT VIA ELECTRONIC MEANS (U.S. CLS. 100, 101 AND 102).

PAUL E. FAHRENKOPF, EXAMINING ATTORNEY

SN 77-566,922. VELOX INSURANCE, INC., MARIETTA, GA.
FILED 9-10-2008.

VELOX

THE MARK CONSISTS OF STANDARD CHARACTERS WITHOUT CLAIM TO ANY PARTICULAR FONT, STYLE, SIZE, OR COLOR.

FOR INSURANCE AGENCIES (U.S. CLS. 100, 101 AND 102).

FIRST USE 4-30-2007; IN COMMERCE 4-30-2007.
GEORGE LORENZO, EXAMINING ATTORNEY

SN 77-566,958. DOMINION HOMES, INC., DUBLIN, OH.
FILED 9-10-2008.

HELPING HAND

THE MARK CONSISTS OF STANDARD CHARACTERS WITHOUT CLAIM TO ANY PARTICULAR FONT, STYLE, SIZE, OR COLOR.

FOR CHARITABLE SERVICES, NAMELY, PROVIDING DOWN PAYMENT ASSISTANCE TO FAMILIES TO PURCHASE HOMES (U.S. CLS. 100, 101 AND 102).

ALICE SUE CARRUTHERS, EXAMINING ATTORNEY

CLASS 36—(Continued).

SN 77-567,154. SHOWROOM REALTY GROUP, SUGAR HILL, GA. FILED 9-10-2008.



NO CLAIM IS MADE TO THE EXCLUSIVE RIGHT TO USE "REALTY GROUP", APART FROM THE MARK AS SHOWN.

THE MARK CONSISTS OF THE STYLIZED TEXT "SHOWROOM REALTY GROUP S" WITH A DESIGN OF A HOUSE IN THE BACKGROUND.

FOR REAL ESTATE BROKERAGE (U.S. CLS. 100, 101 AND 102).

FIRST USE 10-0-2007; IN COMMERCE 1-0-2008.

ALICE SUE CARRUTHERS, EXAMINING ATTORNEY

SN 77-567,324. PHYSICIANS HEALTH PLAN OF MID-MICHIGAN, LANSING, MI. FILED 9-11-2008.



THE MARK CONSISTS OF A BUTTERFLY WITH A HEART IN THE CENTER AND THE OUTSIDE OF EACH WING REPRESENTING A HUMAN SIHOUETTE.

FOR HEALTH INSURANCE UNDERWRITING (U.S. CLS. 100, 101 AND 102).

FIRST USE 0-0-1985; IN COMMERCE 0-0-1985.

GEOFFREY FOSDICK, EXAMINING ATTORNEY

CLASS 36—(Continued).

SN 77-567,337. PRIVATE WEALTH GROUP, LLC, TAMPA, FL. FILED 9-11-2008.



THE MARK CONSISTS OF ELEVATED SIDE PROFILE OF MAN WEARING HELMET WITH WING DECORATION.

FOR INVESTMENT ADVISORY SERVICES (U.S. CLS. 100, 101 AND 102).

FIRST USE 1-29-2007; IN COMMERCE 1-29-2007.

NATALIE POLZER, EXAMINING ATTORNEY

SN 77-567,629. CLOUDLEAP PARTNERS, LLC, CHICAGO, IL. FILED 9-11-2008.

Cloudleap Partners

THE MARK CONSISTS OF STANDARD CHARACTERS WITHOUT CLAIM TO ANY PARTICULAR FONT, STYLE, SIZE, OR COLOR.

NO CLAIM IS MADE TO THE EXCLUSIVE RIGHT TO USE "PARTNERS", APART FROM THE MARK AS SHOWN. FOR FINANCIAL PLANNING AND INVESTMENT ADVISORY SERVICES (U.S. CLS. 100, 101 AND 102).

JEAN IM, EXAMINING ATTORNEY

SN 77-568,033. CAPITAL ONE FINANCIAL CORPORATION, RICHMOND, VA. FILED 9-11-2008.

SMARTSWITCH

THE MARK CONSISTS OF STANDARD CHARACTERS WITHOUT CLAIM TO ANY PARTICULAR FONT, STYLE, SIZE, OR COLOR.

FOR FINANCIAL SERVICES, NAMELY, ELECTRONIC FUNDS TRANSFER (U.S. CLS. 100, 101 AND 102).

FIRST USE 11-1-2007; IN COMMERCE 11-1-2007.

DAVID I, EXAMINING ATTORNEY

CLASS 36—(Continued).

SN 77-570,293. SOCORE ENERGY, CHICAGO, IL. FILED 9-15-2008.

OmniPPA

THE MARK CONSISTS OF STANDARD CHARACTERS WITHOUT CLAIM TO ANY PARTICULAR FONT, STYLE, SIZE, OR COLOR.

FOR BANKING AND FINANCING SERVICES; CONSULTANCY CONCERNING FINANCING OF ENERGY PROJECTS; EQUIPMENT FINANCING SERVICES (U.S. CLS. 100, 101 AND 102).

KELLY CHOE, EXAMINING ATTORNEY

SN 77-571,406. GLOBAL CREDIT ADVISERS LLC, NEW YORK, NY. FILED 9-16-2008.

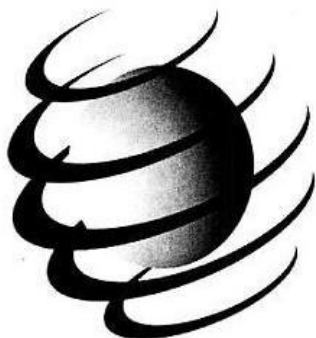

THE MARK CONSISTS OF A STYLIZED GLOBE.

FOR CAPITAL INVESTMENT CONSULTATION; CAPITAL INVESTMENT SERVICES; FUNDS INVESTMENT; INVESTMENT ADVICE; INVESTMENT ADVISORY SERVICES; INVESTMENT CONSULTATION; INVESTMENT MANAGEMENT; INVEST OF FUNDS FOR OTHERS; INVESTMENT SERVICES, NAMELY, ASSET ACQUISITION, CONSULTATION, DEVELOPMENT AND MANAGEMENT SERVICES; MUTUAL FUNDS AND CAPITAL INVESTMENT (U.S. CLS. 100, 101 AND 102).

LAURIE KAUFMAN, EXAMINING ATTORNEY

CLASS 36—(Continued).

SN 77-593,092. CHICAGO CLIMATE EXCHANGE, INC., CHICAGO, IL. FILED 10-15-2008.

LATIN AMERICA CLIMATE EXCHANGE

THE MARK CONSISTS OF STANDARD CHARACTERS WITHOUT CLAIM TO ANY PARTICULAR FONT, STYLE, SIZE, OR COLOR.

OWNER OF U.S. REG. NOS. 2,692,174 AND 3,099,021.

NO CLAIM IS MADE TO THE EXCLUSIVE RIGHT TO USE "LATIN AMERICA" AND "EXCHANGE", APART FROM THE MARK AS SHOWN.

FOR COMMODITY, DERIVATIVES AND FUTURES EXCHANGE SERVICES AND FINANCIAL INSTRUMENTS AND INDICES THAT FACILITATE THE COMMODITIZATION OF AND TRADING OF ENVIRONMENTAL PRODUCTS, SERVICES AND RESOURCES, POLLUTANTS, EMISSIONS ALLOWANCES AND OFFSETS BETWEEN BUSINESS AND OTHER MARKET PARTICIPANTS; FINANCIAL CLEARING SERVICES, NAMELY, THE CLEARING AND SETTLEMENT OF TRADING TRANSACTIONS IN FINANCIAL MARKETS (U.S. CLS. 100, 101 AND 102).

JASON LOTT, EXAMINING ATTORNEY

SN 77-593,129. CHICAGO CLIMATE EXCHANGE, INC., CHICAGO, IL. FILED 10-15-2008.

CCX

THE MARK CONSISTS OF STANDARD CHARACTERS WITHOUT CLAIM TO ANY PARTICULAR FONT, STYLE, SIZE, OR COLOR.

OWNER OF U.S. REG. NOS. 2,591,531 AND 3,185,757.

FOR COMMODITY, DERIVATIVES AND FUTURES EXCHANGE SERVICES AND FINANCIAL INSTRUMENTS AND INDICES THAT FACILITATE THE COMMODITIZATION OF AND TRADING OF ENVIRONMENTAL PRODUCTS, SERVICES AND RESOURCES, POLLUTANTS, EMISSIONS ALLOWANCES AND OFFSETS BETWEEN BUSINESS AND OTHER MARKET PARTICIPANTS; FINANCIAL CLEARING SERVICES, NAMELY, THE CLEARING AND SETTLEMENT OF TRADING TRANSACTIONS IN FINANCIAL MARKETS (U.S. CLS. 100, 101 AND 102).

FIRST USE 1-1-2002; IN COMMERCE 9-29-2003.

MELISSA VALLILLO, EXAMINING ATTORNEY

CLASS 36—(Continued).

SN 77-598,653. ORSUS ADVISORY SERVICES, LLC, MINNEAPOLIS, MN. FILED 10-23-2008.

WHERE SOLUTIONS BEGIN

THE MARK CONSISTS OF STANDARD CHARACTERS WITHOUT CLAIM TO ANY PARTICULAR FONT, STYLE, SIZE, OR COLOR.

FOR FINANCIAL SERVICES, NAMELY, BUSINESS VALUATION SERVICES (U.S. CLS. 100, 101 AND 102).
 LYDIA BELZER, EXAMINING ATTORNEY

SN 77-621,281. CALVERT GROUP, LTD., BETHESDA, MD. FILED 11-25-2008.

H2Opportunity

THE MARK CONSISTS OF STANDARD CHARACTERS WITHOUT CLAIM TO ANY PARTICULAR FONT, STYLE, SIZE, OR COLOR.

FOR FINANCIAL SERVICES, NAMELY, ADMINISTRATION OF TRANSACTIONS INVOLVING FUNDS DRAWN FROM SECURITIES, STOCKS, FUNDS, EQUITIES, BONDS, CASH, OR OTHER TYPES OF FINANCIAL INVESTMENTS IN RETIREMENT PLANS USING A CREDIT OR DEBIT CARD OVER A GLOBAL DATA NETWORK (U.S. CLS. 100, 101 AND 102).
 GEOFFREY FOSDICK, EXAMINING ATTORNEY

SN 78-653,435. VERIDIAN CREDIT UNION, WATERLOO, IA. FILED 6-17-2005.

VERIDIAN CREDIT UNION

THE MARK CONSISTS OF STANDARD CHARACTERS WITHOUT CLAIM TO ANY PARTICULAR FONT, STYLE, SIZE, OR COLOR.

NO CLAIM IS MADE TO THE EXCLUSIVE RIGHT TO USE "CREDIT UNION", APART FROM THE MARK AS SHOWN.

FOR CREDIT UNION SERVICES EXCLUDING LIFE INSURANCE AND ANNUITIES (U.S. CLS. 100, 101 AND 102).

FIRST USE 1-1-2006; IN COMMERCE 1-1-2006.
 MARC LEIPZIG, EXAMINING ATTORNEY

CLASS 36—(Continued).

SN 79-042,538. SAM GROUP HOLDING AG, SWITZERLAND, FILED 7-31-2007.

SAM CREATING SUSTAINABLE VALUE

THE MARK CONSISTS OF STANDARD CHARACTERS WITHOUT CLAIM TO ANY PARTICULAR FONT, STYLE, SIZE, OR COLOR.

OWNER OF INTERNATIONAL REGISTRATION 0934288 DATED 7-31-2007, EXPIRES 7-31-2017.

OWNER OF U.S. REG. NOS. 2,453,375 AND 2,803,877. NO CLAIM IS MADE TO THE EXCLUSIVE RIGHT TO USE "SAM", APART FROM THE MARK AS SHOWN.

FOR INSURANCE AGENCY AND BROKERAGE AND INSURANCE CONSULTATION; FINANCIAL CONSULTANCY AND FINANCIAL ADVICE, ASSET MANAGEMENT; FINANCIAL ANALYSES, FINANCIAL MANAGEMENT, INVESTMENT CONSULTING, CAPITAL INVESTMENT; MONETARY AFFAIRS, NAMELY, FINANCIAL PLANNING AND PORTFOLIO MANAGEMENT; FUNDS CONSTITUTION, NAMELY, CREATION, MANAGEMENT AND ADVISORY OF INVESTMENT FUNDS; REAL ESTATE APPRAISAL, BROKERAGE AND REAL ESTATE CONSULTATION (U.S. CLS. 100, 101 AND 102).

ELLEN PERKINS, EXAMINING ATTORNEY

SN 79-053,118. STATE CAPITAL BANCORP HOLDING S.A., I-20122 MILANO, SPAIN, FILED 2-6-2008.



PRIORITY DATE OF 12-11-2007 IS CLAIMED. OWNER OF INTERNATIONAL REGISTRATION 0962310 DATED 2-6-2008, EXPIRES 2-6-2018.

NO CLAIM IS MADE TO THE EXCLUSIVE RIGHT TO USE "CAPITAL", APART FROM THE MARK AS SHOWN.

THE COLOR(S) LIGHT GREY AND LIGHT BLUE IS/ARE CLAIMED AS A FEATURE OF THE MARK.

THE COLOR LIGHT GREY APPEARS IN THE ASTERISK; THE COLOR LIGHT BLUE APPEARS IN THE WORDING "STATE CAPITAL".

FOR FINANCIAL AFFAIRS, NAMELY, PLACEMENT OF HEDGE FUNDS, PRIVATE EQUITY FUNDS, SECURITIES AND DERIVATIVES FOR OTHERS, MANAGEMENT OF INVESTMENT FUNDS FOR OTHERS (U.S. CLS. 100, 101 AND 102).

DANIEL BRODY, EXAMINING ATTORNEY

CLASS 36—(Continued).

SN 79-058,466. CHINA REINSURANCE (GROUP); CORPORATION, CHINA, FILED 6-12-2008.



PRIORITY DATE OF 2-1-2008 IS CLAIMED.
OWNER OF INTERNATIONAL REGISTRATION 0976251
DATED 6-12-2008, EXPIRES 6-12-2018.

NO CLAIM IS MADE TO THE EXCLUSIVE RIGHT TO
USE "CHINA RE", APART FROM THE MARK AS SHOWN.

FOR MARINE INSURANCE UNDERWRITING; FIRE
INSURANCE UNDERWRITING; HEALTH INSURANCE
UNDERWRITING; LIFE INSURANCE UNDERWRITING;
ACCIDENT INSURANCE UNDERWRITING; IN-
SURANCE UNDERWRITING SERVICES FOR ALL
TYPES OF INSURANCE; INSURANCE BROKERAGE;
ACTUARIAL SERVICES; INSURANCE INFORMATION;
INSURANCE CONSULTANCY; SAFETY DEPOSIT BOX
SERVICES, NAMELY, DEPOSITS OF VALUABLES;
CHECK VERIFICATION; EXCHANGING MONEY;
FUND INVESTMENTS; DEBIT CARD SERVICES; FI-
NANCING LOANS; FINANCING SERVICES; FINAN-
CIAL MANAGEMENT; FINANCIAL EVALUATION;
FINANCIAL INFORMATION; FINANCIAL SPONSOR-
SHIP OF SPORTING EVENTS AND EDUCATIONAL
ACTIVITIES; FINANCIAL CONSULTANCY; BUSINESS
LIQUIDATION SERVICES; FINANCIAL CLEARING;
ISSUANCE OF CREDIT CARDS; CREDIT CARD SER-
VICES; BANKING; ISSUE OF TOKENS OF VALUE;
SECURITIES BROKERAGE; CAPITAL INVESTMENTS;
SAVINGS BANKS; MUTUAL FUND, NAMELY, MU-
TUAL FUND BROKERAGE, MUTUAL FUND INVEST-
MENT AND MUTUAL FUND DISTRIBUTION; ART
APPRAISAL; RENTAL OF OFFICES, RENTAL OF REAL
ESTATE, NAMELY, RENTAL OF RESIDENTIAL HOUS-
ING, RENTAL OF VACATION HOMES; REAL ESTATE
MANAGEMENT; REAL ESTATE AGENCIES; BROKER-
AGE, NAMELY, ART BROKERAGE, COMMODITY
BROKERAGE; FINANCIAL GUARANTEES; FIDU-
CIARY REPRESENTATIVES; REINSURANCE UNDER-
WRITING FOR PROPERTY INSURANCE;
REINSURANCE UNDERWRITING FOR LIFE INSUR-
ANCE; REINSURANCE SERVICE CONSULTANCY FOR
PROPERTY INSURANCE; REINSURANCE SERVICE
CONSULTANCY FOR LIFE INSURANCE (U.S. CLS.
100, 101 AND 102).

ALLISON SCHRODY, EXAMINING ATTORNEY

CLASS 37—CONSTRUCTION AND REPAIR

SN 76-691,514. BRANDED CONCEPT DEVELOPMENT, INC.,
NEW YORK, NY. FILED 7-23-2008.

FROM CONCEPT TO CONCRETE

THE MARK CONSISTS OF STANDARD CHARACTERS
WITHOUT CLAIM TO ANY PARTICULAR FONT, STYLE,
SIZE, OR COLOR.

FOR CONSTRUCTION MANAGEMENT OF RESTAU-
RANTS AND RETAIL STORES (U.S. CLS. 100, 103 AND
106).

DAWN HAN, EXAMINING ATTORNEY

SN 77-207,346. MANSFIELD OIL COMPANY OF GAINES-
VILLE, INC., GAINESVILLE, GA. FILED 6-15-2007.



THE MARK CONSISTS OF A STYLIZED LETTER "M".
FOR CONSTRUCTION MANAGEMENT OF COMMER-
CIAL AND RETAIL FUEL FACILITIES; MANAGEMENT
AND SUPERVISION OF THE REPAIR AND MAINTEN-
ANCE OF COMMERCIAL AND RETAIL FUEL EQUIP-
MENT (U.S. CLS. 100, 103 AND 106).

FIRST USE 12-31-2005; IN COMMERCE 12-31-2005.
MICHELE SWAIN, EXAMINING ATTORNEY

SN 77-332,897. ELEVATOR WORX & INDUSTRIAL EQUIP-
MENT LLC, FRIENDSWOOD, TX. FILED 11-19-2007.



NO CLAIM IS MADE TO THE EXCLUSIVE RIGHT TO
USE "ELEVATOR WORKS INDUSTRIAL CONSTRU-
TION", APART FROM THE MARK AS SHOWN.

THE MARK CONSISTS OF A DESIGN OF GLOBE WITH
OUTLINE OF CONTINENTS WITHIN A GEAR AND THE
WORDING "ELEVATOR WORX INDUSTRIAL CONSTRU-
TION".

FOR INSTALLATION, MAINTENANCE AND REPAIR
OF ELEVATORS AND ELEVATOR PARTS (U.S. CLS. 100,
103 AND 106).

FIRST USE 12-10-2006; IN COMMERCE 12-10-2006.
KATHERINE STOIDES, EXAMINING ATTORNEY

CLASS 37—(Continued).

SN 77-372,519. WEEKLEY HOMES, L.P., HOUSTON, TX. FILED 1-15-2008.

CLASS 37—(Continued).

SN 77-489,327. INSURANCE FIRE AND WATER RESTORATIONS, LLC, FT. MYERS, FL. FILED 6-3-2008.

DAVID WEEKLEY HOMES GREEN



THE MARK CONSISTS OF STANDARD CHARACTERS WITHOUT CLAIM TO ANY PARTICULAR FONT, STYLE, SIZE, OR COLOR.

OWNER OF U.S. REG. NOS. 2,569,399, 2,762,211 AND OTHERS.

NO CLAIM IS MADE TO THE EXCLUSIVE RIGHT TO USE "HOMES GREEN", APART FROM THE MARK AS SHOWN.

THE NAME "DAVID WEEKLEY" IDENTIFIES A LIVING INDIVIDUAL WHOSE CONSENT IS OF RECORD.

FOR CUSTOM CONSTRUCTION OF HOMES, REAL ESTATE DEVELOPMENT (U.S. CLS. 100, 103 AND 106).

FIRST USE 1-1-2008; IN COMMERCE 1-1-2008.
ANDREA BUTLER, EXAMINING ATTORNEY

NO CLAIM IS MADE TO THE EXCLUSIVE RIGHT TO USE "INSURANCE FIRE & WATER RESTORATIONS", APART FROM THE MARK AS SHOWN.

THE MARK CONSISTS OF THE LETTERS "IFW" IN A CIRCLE WITH A LINE COMING OUT OF THE RIGHT SIDE UNDER THE WORD "INSURANCE", FOLLOWED BY THE WORDS "FIRE & WATER RESTORATIONS".

FOR RESTORATION OF BUILDINGS (U.S. CLS. 100, 103 AND 106).

SKYE YOUNG, EXAMINING ATTORNEY

SN 77-394,798. U.S. DISASTER SERVICES, L.L.C., MADISON HEIGHTS, MI. FILED 2-12-2008.

SN 77-507,344. SORELLA GROUP, INC., LENEXA, KS. FILED 6-25-2008.

DON'T PANIC, JUST PUSH OUR
BUTTONS

SORELLA GROUP

THE MARK CONSISTS OF STANDARD CHARACTERS WITHOUT CLAIM TO ANY PARTICULAR FONT, STYLE, SIZE, OR COLOR.

FOR RESTORATION OF BUILDINGS DAMAGED BY WATER, FIRE AND DISASTER; RESIDENTIAL AND COMMERCIAL CARPET CLEANING (U.S. CLS. 100, 103 AND 106).

TARA PATE, EXAMINING ATTORNEY

THE MARK CONSISTS OF STANDARD CHARACTERS WITHOUT CLAIM TO ANY PARTICULAR FONT, STYLE, SIZE, OR COLOR.

NO CLAIM IS MADE TO THE EXCLUSIVE RIGHT TO USE "GROUP", APART FROM THE MARK AS SHOWN.

THE FOREIGN WORDING IN THE MARK TRANSLATES INTO ENGLISH AS SISTER.

FOR SPECIALTY BUILDING CONTRACTOR SERVICES (U.S. CLS. 100, 103 AND 106).

FIRST USE 10-0-2006; IN COMMERCE 10-0-2006.
LEIGH CAROLINE CASE, EXAMINING ATTORNEY

CLASS 37—(Continued).

SN 77-513,948. ROCCIA, JOHN N., PENNSAUKEN, NJ.
FILED 7-2-2008.

Roofers to Trust

THE MARK CONSISTS OF STANDARD CHARACTERS WITHOUT CLAIM TO ANY PARTICULAR FONT, STYLE, SIZE, OR COLOR.

NO CLAIM IS MADE TO THE EXCLUSIVE RIGHT TO USE "ROOFERS", APART FROM THE MARK AS SHOWN, FOR ROOFING SERVICES (U.S. CLS. 100, 103 AND 106).

BILL DAWE, EXAMINING ATTORNEY

SN 77-547,072. FERRELLE, DODD I., DBA SPRAYWELL E.D.D., WINTERVILLE, GA. FILED 8-14-2008.

SPRAYwell E.D.D.

THE MARK CONSISTS OF STANDARD CHARACTERS WITHOUT CLAIM TO ANY PARTICULAR FONT, STYLE, SIZE, OR COLOR.

FOR DISINFECTING (U.S. CLS. 100, 103 AND 106).

RENEE MCCRAY, EXAMINING ATTORNEY

SN 77-547,287. FARINA HARDSCAPES LLC, HACKETTSTOWN, NJ. FILED 8-14-2008.



OWNER OF U.S. REG. NO. 3,469,916.

NO CLAIM IS MADE TO THE EXCLUSIVE RIGHT TO USE "HARDSCAPES", APART FROM THE MARK AS SHOWN.

THE COLOR(S) GREY, TAN AND WHITE IS/ARE CLAIMED AS A FEATURE OF THE MARK.

THE MARK CONSISTS OF AN UPPER-CASE LETTER "F" FORMING THE ENTIRE LEFT PORTION OF THE IMAGE

CLASS 37—(Continued).

AND MOST OF THE TOP OF THE IMAGE WHICH LETTER "F" IS COMPRISED OF GREY BRICK-LIKE RECTANGLES AND PARTS THEREOF ARRANGED IN A HERRINGBONE PATTERN, TOGETHER WITH TWO TAN RECTANGLES, ONE TAN QUADRILATERAL, ONE TAN TRIANGLE AND ONE WHITE TRIANGLE, WHICH ARE COLLECTIVELY ARRANGED IN AN OVERALL SHAPE THAT IS APPROXIMATELY SQUARE, ALONG WITH THE WORDS "FARINA HARDSCAPES" IN GREY APPEARING UNDER THE ABOVE-DESCRIBED ELEMENTS.

FOR INSTALLING LANDSCAPING, NAMELY, BRICK AND STONE MASONRY, PAVERS, PATIOS, COURTYARDS, DECKS, ARBORS, PERGOLAS, WALKS, STAIRWAYS, DRIVEWAYS, WATER FEATURES, IRRIGATION, DRAINAGE STRUCTURES, WALLS, AND LIGHTING; SITE GRADING; INSTALLATION AND MAINTENANCE OF IRRIGATION SYSTEMS; MAINTENANCE OF ELECTRIC LANDSCAPE LIGHTING; LANDSCAPE CONSTRUCTION, NAMELY, CONSULTING, CONSTRUCTION AND INSTALLATION IN THE FIELD OF BRICK AND STONE MASONRY, PAVERS, PATIOS, COURTYARDS, DECKS, ARBORS, PERGOLAS, WALKS, STAIRWAYS, DRIVEWAYS, WATER FEATURES, IRRIGATION, DRAINAGE STRUCTURES, WALLS, AND LIGHTING (U.S. CLS. 100, 103 AND 106).

FIRST USE 5-31-2008; IN COMMERCE 5-31-2008.

SIMON TENG, EXAMINING ATTORNEY

SN 77-547,370. FARINA HARDSCAPES, HACKETTSTOWN, NJ. FILED 8-14-2008.

We Plant Stone

THE MARK CONSISTS OF STANDARD CHARACTERS WITHOUT CLAIM TO ANY PARTICULAR FONT, STYLE, SIZE, OR COLOR.

NO CLAIM IS MADE TO THE EXCLUSIVE RIGHT TO USE "PLANT STONE", APART FROM THE MARK AS SHOWN.

FOR INSTALLING LANDSCAPING, NAMELY, BRICK AND STONE MASONRY, PAVERS, PATIOS, COURTYARDS, DECKS, ARBORS, PERGOLAS, WALKS, STAIRWAYS, DRIVEWAYS, WATER FEATURES, IRRIGATION, DRAINAGE STRUCTURES, WALLS, AND LIGHTING; SITE GRADING; INSTALLATION AND MAINTENANCE OF IRRIGATION SYSTEMS; MAINTENANCE OF ELECTRIC LANDSCAPE LIGHTING; LANDSCAPE CONSTRUCTION, NAMELY, CONSULTING, CONSTRUCTION AND INSTALLATION IN THE FIELD OF BRICK AND STONE MASONRY, PAVERS, PATIOS, COURTYARDS, DECKS, ARBORS, PERGOLAS, WALKS, STAIRWAYS, DRIVEWAYS, WATER FEATURES, IRRIGATION, DRAINAGE STRUCTURES, WALLS, AND LIGHTING (U.S. CLS. 100, 103 AND 106).

FIRST USE 5-31-2008; IN COMMERCE 5-31-2008.

SIMON TENG, EXAMINING ATTORNEY

CLASS 37—(Continued).

SN 77-548,291. NORDHOFF, SCOTT, BEDFORD, IN. FILED 8-15-2008.



FOR BASEMENT WATERPROOFING (U.S. CLS. 100, 103 AND 106).
 FIRST USE 8-30-2007; IN COMMERCE 8-30-2007.
 CHRISTINA SOBRAL, EXAMINING ATTORNEY

CLASS 37—(Continued).

SN 77-554,008. "L" MONTY BODY SHOP, INC. SO. EL MONTE, CA. FILED 8-22-2008.

"L" Monty Body Shop

THE MARK CONSISTS OF STANDARD CHARACTERS WITHOUT CLAIM TO ANY PARTICULAR FONT, STYLE, SIZE, OR COLOR.
 NO CLAIM IS MADE TO THE EXCLUSIVE RIGHT TO USE "BODY SHOP", APART FROM THE MARK AS SHOWN.
 FOR AUTOMOBILE REPAIR AND MAINTENANCE (U.S. CLS. 100, 103 AND 106).
 FIRST USE 2-1-1968; IN COMMERCE 2-1-1968.
 JANICE KIM, EXAMINING ATTORNEY

SN 77-552,253. INTERTRADE SERVICES CORP., FORSYTH, IL. FILED 8-21-2008.



NO CLAIM IS MADE TO THE EXCLUSIVE RIGHT TO USE "BUG", APART FROM THE MARK AS SHOWN.
 THE COLOR(S) RED, BLACK, GREEN, WHITE AND GRAY IS/ARE CLAIMED AS A FEATURE OF THE MARK.
 THE MARK CONSISTS OF A GREEN INSECT WITH BLACK DETAILING, WHITE ANTENNAS WITH BLACK DETAILING, WHITE GLOVES WITH BLACK DETAILING AND WHITE AND GRAY SHOES WITH BLACK DETAILING; THREE WHITE SHOOTING STARS WITH FIVE POINTS EACH ABOVE THE BUG'S HEAD, AND THE STYLIZED WORDING "MUG A BUG" IN RED. THE WORDS "MUG A" ARE STACKED ABOVE THE BUG AND THE WORD "BUG" IS BENEATH THE BUG. THE ENTIRE MARK IS OUTLINED IN BLACK.
 FOR INSECTICIDE SPRAYING; PEST CONTROL; PEST CONTROL AND EXTERMINATION OTHER THAN FOR AGRICULTURAL PURPOSES (U.S. CLS. 100, 103 AND 106).
 FIRST USE 4-1-1986; IN COMMERCE 4-1-1986.
 JULIE GUTTADAURO, EXAMINING ATTORNEY

SN 77-555,237. HOTWELL GMBH, KLINGENBACH, AUSTRIA, FILED 8-25-2008.



THE MARK CONSISTS OF IMAGE OF THE MARK "HOTWELL" WITH SOUND WAVE LINES SHOWING THE MARK AS USED IN COMMERCE.
 FOR RENTAL OF WELL LOGGING EQUIPMENT (U.S. CLS. 100, 103 AND 106).
 FIRST USE 4-3-2007; IN COMMERCE 4-3-2007.
 SHANNON TWOHIG, EXAMINING ATTORNEY

SN 77-555,247. OSBORNE, JOSEPH DARREN, HICKORY, NC. FILED 8-25-2008.

The Mosquito Authority

THE MARK CONSISTS OF STANDARD CHARACTERS WITHOUT CLAIM TO ANY PARTICULAR FONT, STYLE, SIZE, OR COLOR.
 NO CLAIM IS MADE TO THE EXCLUSIVE RIGHT TO USE "MOSQUITO", APART FROM THE MARK AS SHOWN.
 FOR PEST CONTROL AND EXTERMINATION OTHER THAN FOR AGRICULTURAL PURPOSES (U.S. CLS. 100, 103 AND 106).
 FIRST USE 1-1-2008; IN COMMERCE 1-1-2008.
 MARCIE MILONE, EXAMINING ATTORNEY

CLASS 37—(Continued).

SN 77-556,642. U.S. PRO PAINTERS, SPRINGFIELD, OH.
FILED 8-27-2008.



NO CLAIM IS MADE TO THE EXCLUSIVE RIGHT TO USE "U.S. PRO PAINTERS", APART FROM THE MARK AS SHOWN.

THE MARK CONSISTS OF THE STYLIZED WORDS "U.S. PRO PAINTERS", TO THE LEFT OF THE WORD "U.S. PRO" IS AN IMAGE OF A STAR. THE WORD "PAINTERS" IS IN A RECTANGULAR BOX.

FOR PAINTING (U.S. CLS. 100, 103 AND 106).
FIRST USE 1-1-2006; IN COMMERCE 1-1-2006.
MARCIE MILONE, EXAMINING ATTORNEY

SN 77-559,622. WEST-NARDICCHIO, BARBARA J., DICKSON, TN. AND NARDICCHIO, JOSEPH R., DICKSON, TN.
FILED 8-31-2008.

Seniorplex

THE MARK CONSISTS OF STANDARD CHARACTERS WITHOUT CLAIM TO ANY PARTICULAR FONT, STYLE, SIZE, OR COLOR.

FOR HOUSING SERVICES, NAMELY, DEVELOPMENT OF REAL PROPERTY, NAMELY, REPAIR, IMPROVEMENT, AND NEW CONSTRUCTION (U.S. CLS. 100, 103 AND 106).

SKYE YOUNG, EXAMINING ATTORNEY

SN 77-560,488. MR. HANDYMAN INTERNATIONAL, LLC, ANN ARBOR, MI. FILED 9-2-2008.

MrHandyman.com

THE MARK CONSISTS OF STANDARD CHARACTERS WITHOUT CLAIM TO ANY PARTICULAR FONT, STYLE, SIZE, OR COLOR.

OWNER OF U.S. REG. NOS. 2,600,952, 2,834,696 AND OTHERS.

FOR HOME REPAIR AND GENERAL MAINTENANCE SERVICES; BUILDING CONSTRUCTION; INSTALLATION SERVICES, NAMELY, BRICKLAYING, CEILING FAN INSTALLATION, KITCHEN APPLIANCE INSTALLATION, WINDOW AND DOOR INSTALLATION, DRY-WALL INSTALLATION AND REPAIR, WINDOW SHADE AND BLIND INSTALLATION, TILE INSTALLATION AND REPAIR, FENCE INSTALLATION AND REPAIR, INSTALLATION AND REPAIR OF CABINETS, COUNTER-TOPS, MOLDING, TRIM, SHELVEING, DECKS, RAMPS AND HAND RAILS (U.S. CLS. 100, 103 AND 106).

DAVID TOOLEY, EXAMINING ATTORNEY

CLASS 37—(Continued).

SN 77-561,198. XKL, LLC., REDMOND, WA. FILED 9-3-2008.

TRAVEL LIGHT

THE MARK CONSISTS OF STANDARD CHARACTERS WITHOUT CLAIM TO ANY PARTICULAR FONT, STYLE, SIZE, OR COLOR.

FOR INSTALLATION, REPAIR, AND MAINTENANCE OF OPTICAL TELECOMMUNICATION EQUIPMENT (U.S. CLS. 100, 103 AND 106).

ANDREW LEASER, EXAMINING ATTORNEY

SN 77-561,312. D AND W FOAM INSULATION, LLC, SCHAUMBURG, IL. FILED 9-3-2008.



NO CLAIM IS MADE TO THE EXCLUSIVE RIGHT TO USE "FOAM INSULATION", APART FROM THE MARK AS SHOWN.

THE COLOR(S) BLACK, GRAY, GOLD, BROWN AND WHITE IS/ARE CLAIMED AS A FEATURE OF THE MARK.

THE MARK CONSISTS OF THE WORDING "D AND W FOAM INSULATION" IN BLACK LETTERING AND THE WORDING "INSULATING TO PROTECT AND SAVE" IN BLACK LETTERING IMMEDIATELY UNDERNEATH. TO THE LEFT OF THE WORDING IS A DESIGN OF A SWORD WITH A SILVER AND WHITE BLADE AND A BROWN AND BLACK HANDLE WHICH IS DEPICTED AGAINST A DESIGN OF A SHIELD THAT IS COMPRISED OF 6 CONCENTRIC CIRCLES WITH ALTERNATING SHADES OF WHITE, GRAY AND BLACK AND A GOLD CENTER WITH THE WORDING "D&W" IN GRAY LETTERING, ALL OF THE FOREGOING AGAINST A GRAY BACKGROUND.

FOR INSTALLATION OF BUILDING INSULATION (U.S. CLS. 100, 103 AND 106).

FIRST USE 7-18-2008; IN COMMERCE 9-2-2008.

HAI-LY LAM, EXAMINING ATTORNEY

SN 77-561,947. STEVAL CONSULTING, INC., BOCA RATON, FL. FILED 9-4-2008.



THE COLOR(S) BURGUNDY, BLACK, GRAY AND WHITE IS/ARE CLAIMED AS A FEATURE OF THE MARK.

THE MARK CONSISTS OF THE WORDS "STEVAL EXCELLENCE BY DESIGN" IN STYLIZED LETTERING AND ASSOCIATED DESIGN ELEMENTS. THE LETTERS "S" AND "V" APPEAR IN BURGUNDY AND ALL OTHER LETTERS APPEAR IN BLACK. THE "S" APPEARS IN TWO SHADES OF BURGUNDY TO CREATE A BEVELED EFFECT AND GRAY DROP SHADOWING APPEARS BELOW AND ON ITS SIDE TO CREATE A RAISED EFFECT.

CLASS 37—(Continued).

THE ENDS OF LETTER "V" EXTEND HORIZONTALLY TO THE LEFT AND RIGHT AND CREATE A LINE OVER THE LETTERS "T", "E", "A", AND "L", AS WELL AS OVER THE RECTANGULAR SHAPED DESIGN. THE DESIGN IS OF A LARGE RECTANGLE COMPRISED OF TWO INNER BURGUNDY RECTANGLES, SYMBOLIZING ARROW HEADS POINTING AT EACH OTHER. THE BURGUNDY RECTANGLES ARE BORDERED BY WHITE, AND THE REST OF THE LARGE RECTANGLE APPEARS IN BLACK. NO OTHER BACKGROUND COLOR IS CLAIMED.

FOR PLUMBING (U.S. CLS. 100, 103 AND 106).
JUDITH HELFMAN, EXAMINING ATTORNEY

CLASS 37—(Continued).

SN 77-564,692. THE GROUT MEDIC, LLC, DBA THE GROUT MEDIC, AURORA, IL. FILED 9-8-2008.

**Bringing Grout and Tile
Back to Life!**

THE MARK CONSISTS OF STANDARD CHARACTERS WITHOUT CLAIM TO ANY PARTICULAR FONT, STYLE, SIZE, OR COLOR.

FOR GROUTING SERVICES (U.S. CLS. 100, 103 AND 106).

FIRST USE 2-0-2000; IN COMMERCE 2-0-2000.
KEVIN DINALLO, EXAMINING ATTORNEY

SN 77-562,847. XTREME CONVENIENCE STORE LLC, LAKE FOREST, CA. FILED 9-4-2008.

XTREME RACING FUEL

THE MARK CONSISTS OF STANDARD CHARACTERS WITHOUT CLAIM TO ANY PARTICULAR FONT, STYLE, SIZE, OR COLOR.

NO CLAIM IS MADE TO THE EXCLUSIVE RIGHT TO USE "RACING FUEL", APART FROM THE MARK AS SHOWN.

FOR AUTOMOBILE SERVICE STATION SERVICES (U.S. CLS. 100, 103 AND 106).
RONALD AIKENS, EXAMINING ATTORNEY

SN 77-565,275. NITEWORX ILLUMINATION, INC., ALPHARETTA, GA. FILED 9-9-2008.

NiteWorx

THE MARK CONSISTS OF STANDARD CHARACTERS WITHOUT CLAIM TO ANY PARTICULAR FONT, STYLE, SIZE, OR COLOR.

FOR INSTALLATION OF OUTDOOR LIGHTING SYSTEMS (U.S. CLS. 100, 103 AND 106).

FIRST USE 8-27-2008; IN COMMERCE 8-27-2008.
CHARLOTTE CORWIN, EXAMINING ATTORNEY

SN 77-563,207. AAC BUILDERS, INC., VERO BEACH, FL. FILED 9-5-2008.

SOLID INSIDE AND OUT

THE MARK CONSISTS OF STANDARD CHARACTERS WITHOUT CLAIM TO ANY PARTICULAR FONT, STYLE, SIZE, OR COLOR.

FOR RESIDENTIAL BUILDING CONSTRUCTION, REPAIR AND IMPROVEMENT (U.S. CLS. 100, 103 AND 106).

HELENE LIWINSKI, EXAMINING ATTORNEY

SN 77-565,337. HARRELL'S EQUIPMENT & SUPPLY CO., INC., INDIANAPOLIS, IN. FILED 9-9-2008.

WASH. DRY. RIDE.

THE MARK CONSISTS OF STANDARD CHARACTERS WITHOUT CLAIM TO ANY PARTICULAR FONT, STYLE, SIZE, OR COLOR.

FOR AUTOMATED MOTORCYCLE WASHING SERVICES (U.S. CLS. 100, 103 AND 106).

ZHALEH DELANEY, EXAMINING ATTORNEY

CLASS 37—(Continued).

SN 77-565,571. DIGITAL RECEPTION SERVICES, INC., DBA DRS, TAMPA, FL. FILED 9-9-2008.



NO CLAIM IS MADE TO THE EXCLUSIVE RIGHT TO USE "DIGITAL RECEPTION SERVICES, INC.", APART FROM THE MARK AS SHOWN.

THE COLOR(S) RED AND BLACK IS/ARE CLAIMED AS A FEATURE OF THE MARK.

THE MARK CONSISTS OF THE TEXT "DIGITAL RECEPTION SERVICES, INC." TO THE RIGHT OF A GEOMETRIC SQUARE, IN THE LOWER LEFT QUADRANT OF WHICH IS DEPICTED A STYLIZED BLACK CONCAVE SATELLITE DISH EMITTING A SIGNAL, WHICH SIGNAL IS REPRESENTED AS THREE PROGRESSIVELY LONGER BLACK CONVEX LINES AGAINST A RED BACKGROUND.

FOR INSTALLING SATELLITE DISHES; SATELLITE DISH INSTALLATION AND REPAIR (U.S. CLS. 100, 103 AND 106).

FIRST USE 12-31-1999; IN COMMERCE 12-31-1999.
CORY BOONE, EXAMINING ATTORNEY

CLASS 37—(Continued).

SN 77-566,373. MR. ROOF HOLDING COMPANY LLC, COLUMBUS, OH. FILED 9-10-2008.



FOR ROOFING SERVICES (U.S. CLS. 100, 103 AND 106).

FIRST USE 12-31-2005; IN COMMERCE 4-30-2006.
ERNEST SHOSHO, EXAMINING ATTORNEY

SN 77-565,817. ENVIRONMENTAL WASTE MINIMIZATION, INC., NORTHAMPTON, PA. FILED 9-9-2008.

EWMI

THE MARK CONSISTS OF STANDARD CHARACTERS WITHOUT CLAIM TO ANY PARTICULAR FONT, STYLE, SIZE, OR COLOR.

FOR ENVIRONMENTAL REMEDIATION SERVICES, NAMELY, HAZARDOUS AND NON-HAZARDOUS WASTE CLEAN-UP AND DISPOSAL (U.S. CLS. 100, 103 AND 106).

FIRST USE 9-11-1995; IN COMMERCE 9-11-1995.
TRACY FLETCHER, EXAMINING ATTORNEY

SN 77-567,469. MIRISOLA, PETER, HUNTSVILLE, AL. FILED 9-11-2008.

KleanSleep

THE MARK CONSISTS OF STANDARD CHARACTERS WITHOUT CLAIM TO ANY PARTICULAR FONT, STYLE, SIZE, OR COLOR.

FOR MATTRESS AND UPHOLSTERED FURNITURE CLEANING SERVICES (U.S. CLS. 100, 103 AND 106).

FIRST USE 12-1-2007; IN COMMERCE 12-1-2007.
CHARLOTTE CORWIN, EXAMINING ATTORNEY

SN 77-565,979. EUROPA VILLAGE, LLC, MURRIETA, CA. FILED 9-9-2008.

THE ART OF LIVING WELL - PERFECTED

THE MARK CONSISTS OF STANDARD CHARACTERS WITHOUT CLAIM TO ANY PARTICULAR FONT, STYLE, SIZE, OR COLOR.

FOR REAL ESTATE DEVELOPMENT (U.S. CLS. 100, 103 AND 106).

SALLY SHIH, EXAMINING ATTORNEY

SN 77-568,996. ENVIRONMENTAL WASTE MINIMIZATION, INC., NORTHAMPTON, PA. FILED 9-12-2008.



THE MARK CONSISTS OF A TRIANGLE WITH HALF OF AN ARROW HEAD ON EACH SIDE OF THE TRIANGLE WITH A PICTURE OF THE EARTH IN THE MIDDLE OF THE TRIANGLE AND THE CAPITAL BLOCK LETTERS "EWMI" TO THE RIGHT OF THE TRIANGLE WITH THE LOWER LEFT CORNER OF THE "E" TOUCHING THE LOWER RIGHT SIDE OF THE TRIANGLE.

FOR ENVIRONMENTAL REMEDIATION SERVICES, NAMELY, HAZARDOUS AND NON-HAZARDOUS WASTE CLEAN-UP AND DISPOSAL (U.S. CLS. 100, 103 AND 106).

FIRST USE 9-11-1995; IN COMMERCE 9-11-1995.
TRACY FLETCHER, EXAMINING ATTORNEY

CLASS 37—(Continued).

SN 77-576,933. WEB SERVICE COMPANY, LLC, REDONDO BEACH, CA. FILED 9-23-2008.

WEB SERVICE COMPANY, LLC

THE MARK CONSISTS OF STANDARD CHARACTERS WITHOUT CLAIM TO ANY PARTICULAR FONT, STYLE, SIZE, OR COLOR.

OWNER OF U.S. REG. NOS. 1,645,075, 2,800,675 AND OTHERS.

NO CLAIM IS MADE TO THE EXCLUSIVE RIGHT TO USE "SERVICE COMPANY, LLC", APART FROM THE MARK AS SHOWN.

FOR LEASING, MAINTENANCE AND REPAIR OF LAUNDRY EQUIPMENT (U.S. CLS. 100, 103 AND 106).

FIRST USE 9-11-2007; IN COMMERCE 9-11-2007.

ALYSSA STEEL, EXAMINING ATTORNEY

CLASS 38—(Continued).

SN 77-215,053. T-MOBILE USA, INC., BELLEVUE, WA. FILED 6-25-2007.

SHADOW

THE MARK CONSISTS OF STANDARD CHARACTERS WITHOUT CLAIM TO ANY PARTICULAR FONT, STYLE, SIZE, OR COLOR.

FOR TELECOMMUNICATIONS SERVICES, NAMELY, WIRELESS VOICE AND DATA TRANSMISSION, TWO WAY WIRELESS TRANSMISSION OF EMAIL AND TEXT BETWEEN WIRELESS TELECOMMUNICATIONS TERMINALS AND COMPUTERS, AND PROVIDING MULTIPLE-USER ACCESS TO A GLOBAL COMPUTER NETWORK (U.S. CLS. 100, 101 AND 104).

AISHA CLARKE, EXAMINING ATTORNEY

SN 77-215,536. TELEFONICA, S.A., 28013 MADRID, SPAIN, FILED 6-26-2007.

CLASS 38—COMMUNICATION

SN 76-692,660. ANGELS BASEBALL LP, ANAHEIM, CA. FILED 9-9-2008.

THE BIG A

THE MARK CONSISTS OF STANDARD CHARACTERS WITHOUT CLAIM TO ANY PARTICULAR FONT, STYLE, SIZE, OR COLOR.

OWNER OF U.S. REG. NOS. 2,665,314, 3,231,140 AND OTHERS.

FOR TELECOMMUNICATION SERVICES, NAMELY, AUDIO BROADCASTING, TELEVISION BROADCASTING, SUBSCRIPTION TELEVISION BROADCASTING, CABLE TELEVISION BROADCASTING, VIDEO BROADCASTING, SATELLITE TELEVISION BROADCASTING, RADIO BROADCASTING; COMMUNICATION SERVICES, NAMELY, AUDIO, VIDEO AND AUDIO-VISUAL BROADCASTING SERVICES (U.S. CLS. 100, 101 AND 104).

CHARISMA HAMPTON, EXAMINING ATTORNEY



PRIORITY CLAIMED UNDER SEC. 44(D) ON ERPN CMNTY TM OFC APPLICATION NO. 5987383, FILED 6-11-2007, REG. NO. 005987383, DATED 8-7-2008, EXPIRES 6-11-2017.

THE COLOR(S) BLUE, GREEN IS/ARE CLAIMED AS A FEATURE OF THE MARK.

THE MARK CONSISTS OF A DEPICTION OF A HOUSE WITH THREE WINDOWS AND A DOOR WHEREIN THE HOUSE IS SET FORTH IN THE COLOR BLUE AND THE ROOF AND THE DOOR ARE SET FORTH IN THE COLOR GREEN.

FOR TELECOMMUNICATION SERVICES, NAMELY, ELECTRONIC MAIL SERVICES, ELECTRONIC TRANSMISSION OF MESSAGES AND DATA, CELLULAR TELEPHONE SERVICES; COMMUNICATIONS VIA COMPUTER TERMINALS; COMMUNICATIONS SERVICES, NAMELY, TRANSMITTING STREAMED SOUND AND AUDIO VISUAL RECORDINGS VIA THE INTERNET; ELECTRONIC TRANSMISSION OF DATA AND DOCUMENTS AMONG USERS OF COMPUTERS; TELEPHONE COMMUNICATION SERVICES (U.S. CLS. 100, 101 AND 104).

SUSAN RICHARDS, EXAMINING ATTORNEY

CLASS 38—(Continued).

SN 77-358,992. ARMENTANO, MARIA JOSEFINA, BUENOS
ARIES, ARGENTINA, FILED 12-24-2007.



NO CLAIM IS MADE TO THE EXCLUSIVE RIGHT TO
USE "FLORIDA", APART FROM THE MARK AS SHOWN.

THE MARK CONSISTS OF THE WORD "VIVA" ABOVE
"FLORIDA", "VIVA" BEING IN LOWER CASE AND "FLOR-
IDA" IN ALL CAPITAL LETTERS, WITH THE WORD
"FLORIDA" WITHIN A CONTRASTING BOX.

FOR BROADCASTING OF TELEVISION PRO-
GRAMMES; TRANSMISSION OF INFORMATION BY
ELECTRONIC COMMUNICATIONS NETWORKS (U.S.
CLS. 100, 101 AND 104).

FIRST USE 11-30-2002; IN COMMERCE 11-30-2002.
BONNIE LUKEN, EXAMINING ATTORNEY

SN 77-379,313. BROTHERS MEDIA GROUP, LLC, PONTE
VEDRA BEACH, FL. FILED 1-24-2008.

ABN

THE MARK CONSISTS OF STANDARD CHARACTERS
WITHOUT CLAIM TO ANY PARTICULAR FONT, STYLE,
SIZE, OR COLOR.

FOR PRIVATE, SUBSCRIPTION BROADCASTING
SERVICES TO BE DISTRIBUTED VIA SATELLITE TO
AUTOMOTIVE DEALERS AND AUTOMOTIVE REPAIR
AND SUPPLY SHOPS, IN THE FIELD OF AUTOMO-
BILES (U.S. CLS. 100, 101 AND 104).

FIRST USE 11-16-2007; IN COMMERCE 11-16-2007.
RICHARD WHITE, EXAMINING ATTORNEY

CLASS 38—(Continued).

SN 77-406,051. IZODIC ONLINE, INC., PORT ORCHARD,
WA. FILED 2-26-2008.

IZODIC

THE MARK CONSISTS OF STANDARD CHARACTERS
WITHOUT CLAIM TO ANY PARTICULAR FONT, STYLE,
SIZE, OR COLOR.

FOR PROVIDING ONLINE INTERACTIVE BULLETIN
BOARDS FOR TRANSMISSION OF MESSAGES AMONG
USERS CONCERNING FREE AND PAID CLASSIFIED
ADVERTISEMENT LISTINGS OFFERING BUSINESS
SERVICES FOR SALE AND PRODUCTS FOR RENT;
AND ELECTRONIC TRANSMISSION OF MESSAGES,
DATA AND IMAGES (U.S. CLS. 100, 101 AND 104).

SARA THOMAS, EXAMINING ATTORNEY

SN 77-409,736. GHYABI, MARYAM, ORMOND, FL. FILED 2-
29-2008.

WIEE

THE MARK CONSISTS OF STANDARD CHARACTERS
WITHOUT CLAIM TO ANY PARTICULAR FONT, STYLE,
SIZE, OR COLOR.

FOR PROVIDING ONLINE FORUMS FOR TRANSMIS-
SION AND RECEPTION OF MESSAGES AMONG COM-
PUTER USERS CONCERNING IMPORT AND EXPORT
FOR WOMEN (U.S. CLS. 100, 101 AND 104).

EDWARD FENNESSY, EXAMINING ATTORNEY

SN 77-413,886. SUNFLOWER ENTERPRISES, INC., SUN-
FLOWER, MS. FILED 3-5-2008.

VARICOM

THE MARK CONSISTS OF STANDARD CHARACTERS
WITHOUT CLAIM TO ANY PARTICULAR FONT, STYLE,
SIZE, OR COLOR.

FOR TELECOMMUNICATIONS SERVICES, NAMELY,
LOCAL AND LONG DISTANCE TELEPHONE SER-
VICES; INTERNET SERVICE PROVIDER SERVICES,
NAMELY, PROVIDING TELECOMMUNICATIONS CON-
NECTIONS TO THE GLOBAL COMPUTER NETWORK;
TELEVISION, CABLE AND VIDEO ON-DEMAND
TRANSMISSION SERVICES (U.S. CLS. 100, 101 AND 104).

KIMBERLY FRYE, EXAMINING ATTORNEY

CLASS 38—(Continued).

SN 77-415,947. IZODIC ONLINE, INC., PORT ORCHARD, WA. FILED 3-7-2008.

THE MARK CONSISTS OF THE WORD "IZODIC" CONTAINING TWO OPPOSING ARROWS LOCATED IN THE "O" OF THE WORD.

FOR PROVIDING ONLINE INTERACTIVE BULLETIN BOARDS FOR TRANSMISSION OF MESSAGES AMONG USERS CONCERNING FREE AND PAID CLASSIFIED ADVERTISEMENT LISTINGS OFFERING BUSINESS SERVICES FOR SALE AND PRODUCTS FOR RENT; AND ELECTRONIC TRANSMISSION OF MESSAGES, DATA AND IMAGES (U.S. CLS. 100, 101 AND 104).

SARA THOMAS, EXAMINING ATTORNEY

SN 77-442,458. DEUTSCHE TELEKOM, BONN, FED REP GERMANY, FILED 4-8-2008.

web'n'walk Stick

THE MARK CONSISTS OF STANDARD CHARACTERS WITHOUT CLAIM TO ANY PARTICULAR FONT, STYLE, SIZE, OR COLOR.

OWNER OF FED REP GERMANY REG. NO. 30758553, DATED 2-6-2008, EXPIRES 9-30-2017.

OWNER OF U.S. REG. NOS. 3,250,718, 3,257,839 AND OTHERS.

NO CLAIM IS MADE TO THE EXCLUSIVE RIGHT TO USE "STICK", APART FROM THE MARK AS SHOWN.

FOR TELECOMMUNICATIONS SERVICES, NAMELY, WIRELESS PHONE SERVICES, ELECTRIC, DIGITAL, CELLULAR AND WIRELESS TRANSMISSION OF VOICE, DATA, INFORMATION, IMAGES, MESSAGES AND TRANSMISSION OF VOICE, DATA, IMAGES, AUDIO, VIDEO AND INFORMATION VIA TELEPHONE, TELEVISION AND GLOBAL COMMUNICATION NETWORKS; PROVIDING TELECOMMUNICATIONS CONNECTIONS OVER A GLOBAL COMMUNICATIONS NETWORK; ELECTRONIC MAIL, VOICE MAIL AND MESSAGING SERVICES, NAMELY, THE RECORDING AND STORAGE AND SUBSEQUENT TRANSMISSION OF VOICE MESSAGES BY TELEPHONE; AUDIO AND VIDEO TELECONFERENCING; RENTAL OF TELECOMMUNICATIONS EQUIPMENT, NAMELY, EQUIPMENT FOR ELECTRONIC ACCESS TO GLOBAL TELECOMMUNICATIONS NETWORK, EQUIPMENT FOR TRANSMITTING, RECEIVING, RECORDING AND MONITORING VOICE, DATA, INFORMATION, IMAGES, SIGNALS, MESSAGES AND TELECOMMUNICATIONS HARDWARE INCLUDING COMPONENTS AND PERIPHERALS THEREOF FOR USE IN THE TELECOMMUNICATIONS INDUSTRY; RENTAL OF EQUIPMENT FOR TRANSMITTING AND RECEIVING COMPUTER PROGRAMS FOR USE IN OPERATING AND ACCESSING TELECOMMUNICATIONS SYSTEMS; AUDIO AND VIDEO BROADCASTING FEATURING ENTERTAINMENT IN THE NATURE OF LIVE VISUAL AND AUDIO PERFORMANCES OF MUSICAL, VARIETY, NEWS AND COMEDY SHOWS; PROVIDING ACCESS TO COMPUTER INFORMATION NETWORKS; PERSONAL COMMUNICATIONS SERVICES; PAGING SERVICES; ELECTRONIC MAIL SERVICES; TRANSMISSION AND BROADCAST OF AUDIO AND VIDEO PROGRAMMING; PROVIDING MULTIPLE-USER ACCESS TO A GLOBAL COMMUNICATION NETWORK; LEASING TELECOMMUNICATIONS EQUIPMENT, COMPONENTS, SYSTEMS AND SUPPLIES (U.S. CLS. 100, 101 AND 104).

PAUL F. GAST, EXAMINING ATTORNEY

CLASS 38—(Continued).

SN 77-462,528. IQZONE INC., SCOTTSDALE, AZ. FILED 4-30-2008.

IQ Classifieds

THE MARK CONSISTS OF STANDARD CHARACTERS WITHOUT CLAIM TO ANY PARTICULAR FONT, STYLE, SIZE, OR COLOR.

NO CLAIM IS MADE TO THE EXCLUSIVE RIGHT TO USE "CLASSIFIEDS", APART FROM THE MARK AS SHOWN.

FOR ELECTRONIC TRANSMISSION OF ADVERTISEMENTS OF THIRD PARTIES VIA MOBILE TELEPHONE SERVICES (U.S. CLS. 100, 101 AND 104).

ERNEST SHOSHO, EXAMINING ATTORNEY

SN 77-497,810. OPENCAPE CORPORATION, WEST BARNSTABLE, MA. FILED 6-12-2008.



THE COLOR(S) BLUE, ORANGE, AND GREY IS/ARE CLAIMED AS A FEATURE OF THE MARK.

THE MARK CONSISTS OF A DESIGN WITH THE WORD "OPENCAPE" UNDERNEATH. THE DESIGN AND COLORS FROM LEFT TO RIGHT ARE AS FOLLOWS: THE LETTER "C" IS BLUE, THE LETTER "O" IS ORANGE, AND A SERIES OF GREY CURVED LINES IN GRADUATED SIZES REPRESENT SOUND WAVES. THE WORD "OPENCAPE" IS DISPLAYED UNDERNEATH THE DESIGN AND FROM LEFT TO RIGHT THE COLORS ARE AS FOLLOWS: "OPEN" IS THE COLOR ORANGE AND "CAPE" IS THE COLOR BLUE.

FOR TELECOMMUNICATION SERVICES, NAMELY, PROVIDING INTERNET ACCESS VIA BROADBAND OPTICAL OR WIRELESS NETWORKS (U.S. CLS. 100, 101 AND 104).

FIRST USE 6-20-2006; IN COMMERCE 6-20-2006.

ANTHONY RINKER, EXAMINING ATTORNEY

SN 77-508,284. LAN-ACES, INCORPORATED, HOUSTON, TX. FILED 6-25-2008.

AVITEXT

THE MARK CONSISTS OF STANDARD CHARACTERS WITHOUT CLAIM TO ANY PARTICULAR FONT, STYLE, SIZE, OR COLOR.

FOR ELECTRONIC MAIL AND MESSAGING SERVICES (U.S. CLS. 100, 101 AND 104).

FIRST USE 10-1-2007; IN COMMERCE 11-11-2007.

MARCIE MILONE, EXAMINING ATTORNEY

CLASS 38—(Continued).

SN 77-517,231. SPRING WIRELESS, INC., WILMINGTON, DE. FILED 7-8-2008.

SPRING WIRELESS

THE MARK CONSISTS OF STANDARD CHARACTERS WITHOUT CLAIM TO ANY PARTICULAR FONT, STYLE, SIZE, OR COLOR.

NO CLAIM IS MADE TO THE EXCLUSIVE RIGHT TO USE "WIRELESS", APART FROM THE MARK AS SHOWN.

FOR TELECOMMUNICATION SERVICES, NAMELY, TRANSMISSION OF VOICE, DATA, AND VIDEO BY MEANS OF BROADBAND WIRELESS NETWORKS (U.S. CLS. 100, 101 AND 104).

SETH A. RAPPAPORT, EXAMINING ATTORNEY

SN 77-520,234. ANABEL GROUP INC., ROAD TOWN, BR. VIRGIN ISLANDS, FILED 7-11-2008.

ANABEL

THE MARK CONSISTS OF STANDARD CHARACTERS WITHOUT CLAIM TO ANY PARTICULAR FONT, STYLE, SIZE, OR COLOR.

FOR TELECOMMUNICATION AND WIRELESS COMMUNICATION SERVICES, NAMELY, SATELLITE TRANSMISSION, TELEPHONE COMMUNICATION, ELECTRONIC MAIL, TELEVISION AND RADIO BROADCASTING, ELECTRONIC VOICE MESSAGING, NAMELY, RECORDING AND SUBSEQUENT TRANSMISSION OF VOICE MESSAGES BY TELEPHONE, VIDEO TELECONFERENCING, ELECTRONIC TRANSMISSION OF VOICE, VIDEO, MESSAGES AND DIGITAL DATA, VOICE MAIL, DIGITAL TEXT MESSAGING, FACSIMILE MAIL AND PAGING SERVICES; WEBCASTING SERVICES; PROVIDING TELECOMMUNICATION CONNECTIONS VIA A GLOBAL COMPUTER NETWORK; PROVIDING MULTIPLE-USER ACCESS TO A GLOBAL COMPUTER INFORMATION NETWORK VIA COMPUTERS, WIRELESS DEVICES, CELLULAR OR MOBILE TELEPHONES AND PERSONAL DIGITAL ASSISTANTS; PROVIDING INFORMATION ON CALLING PLANS AND SERVICES OF OTHERS IN THE FIELD OF CELLULAR OR MOBILE PHONES; INTERNATIONAL TELEPHONE SERVICES (U.S. CLS. 100, 101 AND 104).

EMILY CARLSEN, EXAMINING ATTORNEY

CLASS 38—(Continued).

SN 77-525,353. METRO-GOLDWYN-MAYER STUDIOS INC., LOS ANGELES, CA. FILED 7-17-2008.

THIS TV

THE MARK CONSISTS OF STANDARD CHARACTERS WITHOUT CLAIM TO ANY PARTICULAR FONT, STYLE, SIZE, OR COLOR.

NO CLAIM IS MADE TO THE EXCLUSIVE RIGHT TO USE "TV", APART FROM THE MARK AS SHOWN.

FOR COMMUNICATION SERVICES, NAMELY, CABLE TELEVISION AND SATELLITE TELEVISION BROADCASTING SERVICES (U.S. CLS. 100, 101 AND 104).

FIRST USE 11-1-2008; IN COMMERCE 11-1-2008.
CAROLYN CATALDO, EXAMINING ATTORNEY

SN 77-547,088. PROCON, INC., KNOXVILLE, TN. FILED 8-14-2008.



THE COLOR(S) BLACK, WHITE, GRAY AND RED IS/ ARE CLAIMED AS A FEATURE OF THE MARK.

THE MARK CONSISTS OF A CROSS AND CIRCLE DESIGN COMPRISING A WHITE CROSS WITH A BLACK BORDER ON A RED CIRCULAR BACKGROUND, THE RED CIRCULAR BACKGROUND HAVING A BLACK

CLASS 38—(Continued).

BORDER WITH FOUR NOTCHES IN THE BORDER SEPARATED BY 90 DEGREES, THE RED CIRCULAR BACKGROUND SURROUNDED BY A CIRCULAR RING FORMED BY FOUR BLACK CIRCULAR SEGMENTS, EACH SEGMENT HAVING A GRAY BORDER, WITH A WHITE SPACE BETWEEN THE CIRCULAR RING AND THE RED CIRCULAR BACKGROUND, AND THE WORD "SAFELIFE" IN CAPITAL LETTERS IN A GRAY-BORDERED BLACK STYLIZED FONT POSITIONED BELOW THE CROSS AND CIRCLE DESIGN.

FOR ELECTRONIC TRANSMISSION OF DATA AND INFORMATION VIA A GLOBAL COMPUTER NETWORK FOR TRACKING THE LOCATION OF A WIRELESS DEVICE; DATA TRANSMISSION AND RECEPTION SERVICES VIA TELECOMMUNICATION MEANS; ELECTRONIC EXCHANGE OF DATA STORED IN DATABASES ACCESSIBLE VIA TELECOMMUNICATION NETWORKS; PROVIDING ELECTRONIC TELECOMMUNICATION CONNECTIONS; TELECOMMUNICATION ACCESS SERVICES; TELECOMMUNICATION SERVICES, NAMELY, LOCAL AND LONG DISTANCE TRANSMISSION OF VOICE, DATA, GRAPHICS BY MEANS OF TELEPHONE, TELEGRAPHIC, CABLE, AND SATELLITE TRANSMISSIONS; TELECOMMUNICATIONS SERVICES, NAMELY, PERSONAL COMMUNICATION SERVICES; TEXT AND NUMERIC WIRELESS DIGITAL MESSAGING SERVICES; TRANSFER OF DATA BY TELECOMMUNICATION; WIRELESS COMMUNICATIONS SERVICES, NAMELY, TRANSMISSION OF GRAPHICS TO MOBILE TELEPHONES; WIRELESS DIGITAL MESSAGING SERVICES; WIRELESS ELECTRONIC TRANSMISSION OF VOICE SIGNALS, DATA, FACSIMILES, IMAGES AND INFORMATION; ELECTRONIC TRANSMISSION, RECEPTION AND PROCESSING OF CODED AND EMERGENCY SIGNALS AND ELECTRONIC TRANSMISSION AND RECEPTION OF DATA AND INFORMATION, ALL FOR TRACKING LOCATIONS OF WIRELESS DEVICES (U.S. CLS. 100, 101 AND 104).

ANGELA GAW, EXAMINING ATTORNEY

CLASS 38—(Continued).

DESIGN COMPRISING A CROSS ON A CIRCULAR BACKGROUND, THE CIRCULAR BACKGROUND HAVING FOUR NOTCHES SEPARATED BY 90 DEGREES ALONG ITS OUTER EDGE, THE CIRCULAR BACKGROUND SURROUNDED BY A CIRCULAR RING FORMED BY FOUR CIRCULAR SEGMENTS, AND THE WORD "SAFELIFE" IN A STYLIZED FONT POSITIONED BELOW THE CROSS AND CIRCLE DESIGN, AND THE WORDS "LIVE BY IT" IN A SMALLER STYLIZED FONT POSITIONED BELOW THE WORD "SAFELIFE".

FOR ELECTRONIC TRANSMISSION OF DATA AND INFORMATION VIA A GLOBAL COMPUTER NETWORK FOR TRACKING THE LOCATION OF A WIRELESS DEVICE; DATA TRANSMISSION AND RECEPTION SERVICES VIA TELECOMMUNICATION MEANS; ELECTRONIC EXCHANGE OF DATA STORED IN DATABASES ACCESSIBLE VIA TELECOMMUNICATION NETWORKS; PROVIDING ELECTRONIC TELECOMMUNICATION CONNECTIONS; TELECOMMUNICATION ACCESS SERVICES; TELECOMMUNICATION SERVICES, NAMELY, LOCAL AND LONG DISTANCE TRANSMISSION OF VOICE, DATA, GRAPHICS BY MEANS OF TELEPHONE, TELEGRAPHIC, CABLE, AND SATELLITE TRANSMISSIONS; TELECOMMUNICATIONS SERVICES, NAMELY, PERSONAL COMMUNICATION SERVICES; TEXT AND NUMERIC WIRELESS DIGITAL MESSAGING SERVICES; TRANSFER OF DATA BY TELECOMMUNICATION; WIRELESS COMMUNICATIONS SERVICES, NAMELY, TRANSMISSION OF GRAPHICS TO MOBILE TELEPHONES; WIRELESS DIGITAL MESSAGING SERVICES; WIRELESS ELECTRONIC TRANSMISSION OF VOICE SIGNALS, DATA, FACSIMILES, IMAGES AND INFORMATION; ELECTRONIC TRANSMISSION, RECEPTION AND PROCESSING OF CODED AND EMERGENCY SIGNALS AND ELECTRONIC TRANSMISSION AND RECEPTION OF DATA AND INFORMATION, ALL FOR TRACKING LOCATIONS OF WIRELESS DEVICES (U.S. CLS. 100, 101 AND 104).

ANGELA GAW, EXAMINING ATTORNEY

SN 77-547,210. PROCON, INC., KNOXVILLE, TN. FILED 8-14-2008.

SN 77-552,575. FMR LLC, BOSTON, MA. FILED 8-21-2008.



THE MARK CONSISTS OF A CROSS AND CIRCLE

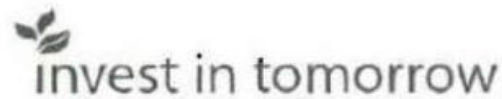

THE MARK CONSISTS OF THE WORDS "INVEST IN TOMORROW" WITH A DESIGN OF THREE LEAVES FORMING THE DOT OVER THE "I" IN "INVEST".

FOR DELIVERY OF DOCUMENTS BY ELECTRONIC MEANS (U.S. CLS. 100, 101 AND 104).

JAMES GRIFFIN, EXAMINING ATTORNEY

CLASS 38—(Continued).

SN 77-556,819. FITZSIMMONS, BECKY B., CINCINNATI, OH. FILED 8-27-2008.

FETCH

THE MARK CONSISTS OF STANDARD CHARACTERS WITHOUT CLAIM TO ANY PARTICULAR FONT, STYLE, SIZE, OR COLOR.

FOR TELECOMMUNICATIONS SERVICES, NAMELY, PROVIDING A TAXICAB SCHEDULING SERVICE WHEREBY CALLS ARE ROUTED THROUGH A CENTRAL PHONE NUMBER TO LOCAL THIRD PARTY TAXI-CAB DISPATCHERS IN THE VICINITY OF THE CALLER (U.S. CLS. 100, 101 AND 104).

ALICIA COLLINS, EXAMINING ATTORNEY

SN 77-557,421. MUNHWA BROADCASTING CORPORATION, SEOUL 150-728, REPUBLIC OF KOREA, FILED 8-27-2008.

MBCD

THE MARK CONSISTS OF STANDARD CHARACTERS WITHOUT CLAIM TO ANY PARTICULAR FONT, STYLE, SIZE, OR COLOR.

FOR BROADCASTING SERVICES AND PROVISION OF TELECOMMUNICATION ACCESS TO FILMS AND TELEVISION PROGRAMMES PROVIDED VIA A VIDEO-ON-DEMAND SERVICE; TELEVISION BROADCASTING; VIDEO BROADCASTING (U.S. CLS. 100, 101 AND 104).

FIRST USE 8-1-2008; IN COMMERCE 8-1-2008.
MARY BOAGNI, EXAMINING ATTORNEY

SN 77-558,343. KINGDOM TELECOMMUNICATIONS, INC., AUXVASSE, MO. FILED 8-28-2008.

KINGDOM MOBILE

THE MARK CONSISTS OF STANDARD CHARACTERS WITHOUT CLAIM TO ANY PARTICULAR FONT, STYLE, SIZE, OR COLOR.

NO CLAIM IS MADE TO THE EXCLUSIVE RIGHT TO USE "MOBILE", APART FROM THE MARK AS SHOWN.

FOR COMMUNICATION SERVICES, NAMELY, TRANSMISSION OF VOICE, AUDIO, VISUAL IMAGES AND DATA BY TELECOMMUNICATIONS NETWORKS, WIRELESS COMMUNICATION NETWORKS, THE INTERNET, INFORMATION SERVICES NETWORKS AND DATA NETWORKS (U.S. CLS. 100, 101 AND 104).

BILL DAWE, EXAMINING ATTORNEY

CLASS 38—(Continued).

SN 77-561,964. DIRK ELLER, SAN ANTONIO, TX. FILED 9-4-2008.

BETTER THAN LIVE

THE MARK CONSISTS OF STANDARD CHARACTERS WITHOUT CLAIM TO ANY PARTICULAR FONT, STYLE, SIZE, OR COLOR.

FOR AUDIO AND VIDEO BROADCASTING SERVICES OVER THE INTERNET; INTERNET BROADCASTING SERVICES; STREAMING OF AUDIO MATERIAL ON THE INTERNET; STREAMING OF VIDEO MATERIAL ON THE INTERNET; AUDIO BROADCASTING; VIDEO BROADCASTING; AUDIO TELECONFERENCING; VIDEO TELECONFERENCING; TELECOMMUNICATION SERVICES, NAMELY, TRANSMISSION OF WEBCASTS; TELECOMMUNICATION SERVICES, NAMELY, TRANSMISSION OF PODCASTS; VIDEO ON-DEMAND TRANSMISSION SERVICES (U.S. CLS. 100, 101 AND 104).

LOURDES AYALA, EXAMINING ATTORNEY

SN 77-562,739. CHRISTIAN BROADCASTING SYSTEM, LTD., FLINT, MI. FILED 9-4-2008.



NO CLAIM IS MADE TO THE EXCLUSIVE RIGHT TO USE "CHRISTIAN BROADCASTING SYSTEM LTD", APART FROM THE MARK AS SHOWN.

THE MARK CONSISTS OF THE WORDS "CHRISTIAN BROADCASTING SYSTEM LTD" WITH THE WORD "BROADCASTING" SUPERIMPOSED OVER THE IMAGE OF A BIRD THAT HAS A SHADOWED EFFECT TO ITS MIDSECTION.

FOR INTERNET BROADCASTING SERVICES; RADIO BROADCASTING (U.S. CLS. 100, 101 AND 104).

FIRST USE 1-1-2004; IN COMMERCE 1-1-2004.
TOBY BULLOFF, EXAMINING ATTORNEY

SN 77-563,391. TOWER OF BABEL LLC, AKA KBTV, SACRAMENTO, CA. FILED 9-5-2008.

CROSSINGS TV

THE MARK CONSISTS OF STANDARD CHARACTERS WITHOUT CLAIM TO ANY PARTICULAR FONT, STYLE, SIZE, OR COLOR.

NO CLAIM IS MADE TO THE EXCLUSIVE RIGHT TO USE "TV", APART FROM THE MARK AS SHOWN.

FOR TELEVISION, CABLE, SATELLITE, INTERNET AND ONLINE WORLD WIDE NETWORK BROADCASTING SERVICES (U.S. CLS. 100, 101 AND 104).

HENRY S. ZAK, EXAMINING ATTORNEY

CLASS 38—(Continued).

SN 77-563,481. BUILDINGBLOK LLC, NEW YORK, NY. FILED 9-5-2008.

buildingblok

THE MARK CONSISTS OF STANDARD CHARACTERS WITHOUT CLAIM TO ANY PARTICULAR FONT, STYLE, SIZE, OR COLOR.

FOR A REMOTE COMMUNICATION AND PROJECT MANAGEMENT SERVICE TARGETED TO THE CONSTRUCTION INDUSTRY, WHEREBY PARTIES WORKING ON A CONSTRUCTION PROJECT CAN REMOTELY ACCESS AND TRANSMIT DATA AND DOCUMENTS FROM AND TO EACH OTHER UTILIZING PORTABLE HANDHELD DEVICES AND A WEBSITE (U.S. CLS. 100, 101 AND 104).

FIRST USE 1-1-2008; IN COMMERCE 8-1-2008.
THEODORE MCBRIDE, EXAMINING ATTORNEY

SN 77-563,567. BUILDINGBLOK LLC, NEW YORK, NY. FILED 9-5-2008.



THE MARK CONSISTS OF A CITY SKYLINE ABOVE THE WORD BUILDINGBLOK (WITH THE SKYLINE GENERALLY CENTERED OVER THE "BUILDING" PART OF THE WORD).

FOR A REMOTE COMMUNICATION AND PROJECT MANAGEMENT SERVICE TARGETED TO THE CONSTRUCTION INDUSTRY, WHEREBY PARTIES WORKING ON A CONSTRUCTION PROJECT CAN REMOTELY ACCESS AND TRANSMIT DATA AND DOCUMENTS FROM AND TO EACH OTHER UTILIZING PORTABLE HANDHELD DEVICES AND A WEBSITE (U.S. CLS. 100, 101 AND 104).

FIRST USE 1-1-2008; IN COMMERCE 8-1-2008.
THEODORE MCBRIDE, EXAMINING ATTORNEY

SN 77-564,597. COMUNICACIONES SAN MILLAN S.A. DE C.V., SAN LUIS, AZ. FILED 9-8-2008.

ESTEREO JOYA

THE MARK CONSISTS OF STANDARD CHARACTERS WITHOUT CLAIM TO ANY PARTICULAR FONT, STYLE, SIZE, OR COLOR.

NO CLAIM IS MADE TO THE EXCLUSIVE RIGHT TO USE "ESTEREO", APART FROM THE MARK AS SHOWN.

THE ENGLISH TRANSLATION OF ESTEREO JOYA IS "STEREO JEWEL".

FOR AUDIO BROADCASTING; BROADCASTING OF RADIO PROGRAMMES (U.S. CLS. 100, 101 AND 104).
NICHOLAS ALTREE, EXAMINING ATTORNEY

CLASS 38—(Continued).

SN 77-564,659. COMUNICACIONES SAN MILLAN S.A. DE C.V., SAN LUIS, AZ. FILED 9-8-2008.

RIO

THE MARK CONSISTS OF STANDARD CHARACTERS WITHOUT CLAIM TO ANY PARTICULAR FONT, STYLE, SIZE, OR COLOR.

THE ENGLISH TRANSLATION OF RIO IS "RIVER".
FOR AUDIO BROADCASTING; BROADCASTING OF RADIO PROGRAMMES (U.S. CLS. 100, 101 AND 104).
NICHOLAS ALTREE, EXAMINING ATTORNEY

SN 77-564,746. BORDER MEDIA PARTNERS, LLC, DALLAS, TX. FILED 9-8-2008.

San Antonio Life

THE MARK CONSISTS OF STANDARD CHARACTERS WITHOUT CLAIM TO ANY PARTICULAR FONT, STYLE, SIZE, OR COLOR.

NO CLAIM IS MADE TO THE EXCLUSIVE RIGHT TO USE "SAN ANTONIO", APART FROM THE MARK AS SHOWN.

FOR COMMUNICATION VIA RADIO, TELEVISION, ON-LINE AND MOBILE TRANSMISSIONS (U.S. CLS. 100, 101 AND 104).

MIDGE BUTLER, EXAMINING ATTORNEY

SN 77-566,398. GRAND STADIUM, LLC, MINNETONKA, MN. FILED 9-10-2008.

GRAND STADIUM

THE MARK CONSISTS OF STANDARD CHARACTERS WITHOUT CLAIM TO ANY PARTICULAR FONT, STYLE, SIZE, OR COLOR.

FOR ONLINE STREAMING OF AUDIO AND VIDEO OF SPORTS AND SCHOOL EVENTS (U.S. CLS. 100, 101 AND 104).

ROBERT LAVACHE, EXAMINING ATTORNEY

CLASS 38—(Continued).

SN 77-567,689. LOGIC PRODUCT DEVELOPMENT COMPANY, MINNEAPOLIS, MN. FILED 9-11-2008.

LOGIC

THE MARK CONSISTS OF STANDARD CHARACTERS WITHOUT CLAIM TO ANY PARTICULAR FONT, STYLE, SIZE, OR COLOR.

FOR PROVIDING AN ONLINE FORUM FOR THE TRANSMISSION OF MESSAGES AMONG COMPUTER USERS CONCERNING COMPUTER SOFTWARE DEVELOPMENT (U.S. CLS. 100, 101 AND 104).

FIRST USE 1-11-1999; IN COMMERCE 1-11-1999.
HAI-LY LAM, EXAMINING ATTORNEY

SN 77-976,171. NINTENDO CO., LTD., KYOTO-SHI, KYOTO, JAPAN, FILED 10-4-2006.

VirtualConsole

THE MARK CONSISTS OF STANDARD CHARACTERS WITHOUT CLAIM TO ANY PARTICULAR FONT, STYLE, SIZE, OR COLOR.

OWNER OF JAPAN REG. NO. 4992532, DATED 9-29-2006, EXPIRES 9-29-2016.

FOR COMMUNICATION BY MOBILE TELEPHONE; PROVIDING INFORMATION ABOUT TELECOMMUNICATION, EXCLUDING BROADCASTING; TRANSMISSION OF INFORMATION VIA A TELEPRINTER; PAGING SERVICES; RENTAL OF TELECOMMUNICATION EQUIPMENT INCLUDING TELEPHONES AND FACSIMILE APPARATUS (U.S. CLS. 100, 101 AND 104).

ANNE E. GUSTASON, EXAMINING ATTORNEY

CLASS 39—TRANSPORTATION AND STORAGE

SN 76-561,489. YRC WORLDWIDE INC., OVERLAND PARK, KS. FILED 11-24-2003.

YELLOW ROADWAY

THE MARK CONSISTS OF STANDARD CHARACTERS WITHOUT CLAIM TO ANY PARTICULAR FONT, STYLE, SIZE, OR COLOR.

OWNER OF U.S. REG. NOS. 1,212,749, 1,212,750 AND 1,212,751.

FOR DOMESTIC AND INTERNATIONAL COMMON CARRIER FREIGHT TRANSPORTATION BY MEANS OF TRUCK, AIR, OR SEA, AND DOMESTIC AND INTERNATIONAL FREIGHT FORWARDING SERVICES (U.S. CLS. 100 AND 105).

ANN E. SAPPENFIELD, EXAMINING ATTORNEY

SN 76-692,443. AAA SERVICE LEASING, INC., UNION, NJ. FILED 8-28-2008.

ECONO-CAR

THE MARK CONSISTS OF STANDARD CHARACTERS WITHOUT CLAIM TO ANY PARTICULAR FONT, STYLE, SIZE, OR COLOR.

FOR DAILY, WEEKLY AND MONTHLY RENTAL OF AUTOMOBILES AND TRUCKS (U.S. CLS. 100 AND 105).
FIRST USE 11-1-1961; IN COMMERCE 11-1-1961.

GISELLE AGOSTO, EXAMINING ATTORNEY

SN 77-201,173. HOPE AIR, TORONTO, ONTARIO, CANADA, FILED 6-8-2007.

HOPE AIR

THE MARK CONSISTS OF STANDARD CHARACTERS WITHOUT CLAIM TO ANY PARTICULAR FONT, STYLE, SIZE, OR COLOR.

PRIORITY CLAIMED UNDER SEC. 44(D) ON CANADA APPLICATION NO. 1,329,717, FILED 12-28-2006, REG. NO. TMA707639, DATED 2-18-2008, EXPIRES 2-18-2023.

NO CLAIM IS MADE TO THE EXCLUSIVE RIGHT TO USE "AIR", APART FROM THE MARK AS SHOWN.

FOR CHARITABLE SERVICES, NAMELY, ARRANGING FREE TRANSPORT BY AIR OF DISADVANTAGED PASSENGERS IN NEED OF MEDICAL TREATMENT (U.S. CLS. 100 AND 105).

PAUL F. GAST, EXAMINING ATTORNEY

CLASS 39—(Continued).

SN 77-334,648. 1-800 MR. RUBBISH BRANDS LLC, BROOKLYN, NY. FILED 11-20-2007.



THE COLOR(S) RED, OFF-WHITE, WHITE, BLACK, BROWN, YELLOW, GRAY, GREEN AND PEACH IS/ARE CLAIMED AS A FEATURE OF THE MARK.

THE MARK CONSISTS OF A CARTOON CHARACTER WITH THE COLORS WHITE, GRAY, AND BLACK USED FOR THE CHARACTER'S HAIR AND FACIAL FEATURES. THE COLOR PEACH IS USED TO DEPICT THE SKIN-TONE OF THE CHARACTER'S FACE. THE CHARACTER'S UNIFORM IS IN A RED COLOR, WITH A WHITE RECYCLING DESIGN ON HIS RIGHT ARM, AND A CENTRAL YELLOW AND BLACK PENTAGON EMBLEM WITH A BLACK LETTER "R." THE CHARACTER HAS BLACK AND GRAY GLOVES AND BOOTS, AND A BROWN AND GRAY BELT. THE CHARACTER IS CARRYING A GREEN AND YELLOW BROOM, A GRAY AND BROWN SHOVEL, A GRAY AND BROWN HAMMER, AND A GREEN AND OFF-WHITE SPRAY BOTTLE. THE COLOR BLACK IS USED AS OUTLINING THROUGHOUT THE CHARACTER.

FOR JUNK REMOVAL (U.S. CLS. 100 AND 105).
FIRST USE 4-11-2006; IN COMMERCE 4-11-2006.
TEJBIR SINGH, EXAMINING ATTORNEY

SN 77-335,651. 1-800 MR. RUBBISH BRANDS LLC, BROOKLYN, NY. FILED 11-21-2007.

1-800 Mr. Rubbish

THE MARK CONSISTS OF STANDARD CHARACTERS WITHOUT CLAIM TO ANY PARTICULAR FONT, STYLE, SIZE, OR COLOR.

NO CLAIM IS MADE TO THE EXCLUSIVE RIGHT TO USE "RUBBISH", APART FROM THE MARK AS SHOWN. FOR JUNK REMOVAL (U.S. CLS. 100 AND 105).
TEJBIR SINGH, EXAMINING ATTORNEY

CLASS 39—(Continued).

SN 77-337,077. 1-800 MR. RUBBISH BRANDS LLC, BROOKLYN, NY. FILED 11-26-2007.

1-866 Mr. Rubbish

THE MARK CONSISTS OF STANDARD CHARACTERS WITHOUT CLAIM TO ANY PARTICULAR FONT, STYLE, SIZE, OR COLOR.

NO CLAIM IS MADE TO THE EXCLUSIVE RIGHT TO USE "RUBBISH", APART FROM THE MARK AS SHOWN. FOR JUNK REMOVAL (U.S. CLS. 100 AND 105).
FIRST USE 1-31-2005; IN COMMERCE 1-31-2005.
TEJBIR SINGH, EXAMINING ATTORNEY

SN 77-380,779. 1-800 MR. RUBBISH BRANDS LLC, BROOKLYN, NY. FILED 1-25-2008.

Mr. Rubbish

THE MARK CONSISTS OF STANDARD CHARACTERS WITHOUT CLAIM TO ANY PARTICULAR FONT, STYLE, SIZE, OR COLOR.

NO CLAIM IS MADE TO THE EXCLUSIVE RIGHT TO USE "RUBBISH", APART FROM THE MARK AS SHOWN. FOR JUNK REMOVAL (U.S. CLS. 100 AND 105).
FIRST USE 1-31-2005; IN COMMERCE 1-31-2005.
TEJBIR SINGH, EXAMINING ATTORNEY

SN 77-381,063. EURAIR, INC., CANYON COUNTRY, CA. FILED 1-25-2008.

EUROPEBYAIR

THE MARK CONSISTS OF STANDARD CHARACTERS WITHOUT CLAIM TO ANY PARTICULAR FONT, STYLE, SIZE, OR COLOR.

OWNER OF U.S. REG. NOS. 2,491,635, 2,503,320 AND 2,545,370.
SEC. 2(F).
FOR TRAVEL SERVICES, NAMELY, TRAVEL INFORMATION SERVICES AND TRAVEL RESERVATION SERVICES FOR AIR TRAVEL, TRANSPORTATION (U.S. CLS. 100 AND 105).
FIRST USE 9-0-1999; IN COMMERCE 9-0-1999.
DANIEL BRODY, EXAMINING ATTORNEY

CLASS 39—(Continued).

SN 77-384,642. GOLDEN LION TRANSPORTATION, COVINA, CA. FILED 1-30-2008.



THE COLOR(S) LIGHT BLUE AND DARK BLUE IS/ARE CLAIMED AS A FEATURE OF THE MARK.

THE MARK CONSISTS OF TWO LARGE SPLASHES NEAR THE CENTER OF THE MARK AND TWO OVALS NEAR THE UPPER PORTION OF THE MARK IN LIGHT BLUE. THE CURVED LINES NEAR THE UPPER LEFT AND BOTTOM RIGHT CORNERS OF THE MARK ARE DARK BLUE. THE MARK APPEARS ON A TRANSPARENT BACKGROUND, AND NO OTHER COLOR IS CLAIMED AS A FEATURE OF THE MARK.

FOR BUS CHARTERING (U.S. CLS. 100 AND 105).
FIRST USE 1-1-1996; IN COMMERCE 1-1-1996.
DAVID MILLER, EXAMINING ATTORNEY

SN 77-459,655. AUTO EUROPE, LLC, PORTLAND, ME. FILED 4-28-2008.

AUTOEUROPA

THE MARK CONSISTS OF STANDARD CHARACTERS WITHOUT CLAIM TO ANY PARTICULAR FONT, STYLE, SIZE, OR COLOR.

OWNER OF U.S. REG. NOS. 2,827,877, 2,942,198 AND OTHERS.

FOR TRAVEL AGENCY SERVICES, NAMELY, MAKING RESERVATIONS AND BOOKINGS FOR TRANSPORTATION; CAR RENTAL (U.S. CLS. 100 AND 105).

ANDREA SAUNDERS, EXAMINING ATTORNEY

SN 77-520,245. ANABEL GROUP INC., ROAD TOWN, BR. VIRGIN ISLANDS, FILED 7-11-2008.

ANABEL

THE MARK CONSISTS OF STANDARD CHARACTERS WITHOUT CLAIM TO ANY PARTICULAR FONT, STYLE, SIZE, OR COLOR.

FOR NAVIGATION SERVICES, NAMELY, PROVIDING DIRECTIONS AND ROUTE SUPPORT TO DRIVERS AND PEDESTRIANS; PROVIDING MAP IMAGING, NAVIGATION, TRAFFIC, TRAVEL AND POINT-OF-INTEREST INFORMATION VIA TELECOMMUNICATION NETWORKS, MOBILE TELEPHONES AND COMMUNICATION EQUIPMENT AND WIRELESS NAVIGATION DEVICES (U.S. CLS. 100 AND 105).

EMILY CARLSEN, EXAMINING ATTORNEY

CLASS 39—(Continued).

SN 77-526,935. FMR LLC, BOSTON, MA. FILED 7-21-2008.

BEING THERE STARTS HERE

THE MARK CONSISTS OF STANDARD CHARACTERS WITHOUT CLAIM TO ANY PARTICULAR FONT, STYLE, SIZE, OR COLOR.

FOR CHAUFFEURING AND PRIVATE BUS TRANSPORTATION SERVICES (U.S. CLS. 100 AND 105).
JAMES GRIFFIN, EXAMINING ATTORNEY

SN 77-532,264. WILLIAM M. WINTER, NAIROBI, KENYA, FILED 7-27-2008.



THE COLOR(S) THE COLOR BROWNISH ORANGE IS/ARE CLAIMED AS A FEATURE OF THE MARK.

THE MARK CONSISTS OF THE COLOR BROWNISH ORANGE, WITH THE COLOR BROWNISH ORANGE APPEAR IN THE ENTIRE DESIGN OF THE MARK.

FOR ARRANGING AND CONDUCTING SAFARI EXPEDITIONS; TRAVEL AGENCY SERVICES, NAMELY, FACILITATING RESERVATIONS AND BOOKINGS FOR SAFARI EXPEDITIONS (U.S. CLS. 100 AND 105).

FIRST USE 1-22-2004; IN COMMERCE 4-24-2004.
MARGARET POWER, EXAMINING ATTORNEY

CLASS 39—(Continued).

SN 77-551,514. DANILUK, JOSEPH, AURORA, CO. FILED 8-20-2008.



NO CLAIM IS MADE TO THE EXCLUSIVE RIGHT TO USE "SUPERLOADS", APART FROM THE MARK AS SHOWN.

THE COLOR(S) BLUE, RED AND BLACK IS/ARE CLAIMED AS A FEATURE OF THE MARK.

THE MARK CONSISTS OF A LARGE "S" IN THE COLOR BLUE, FOLLOWED BY "UPER" IN SMALLER LETTERS IN THE COLOR RED. A LARGE "L" IN THE COLOR BLUE, FOLLOWED BY "OADS" IN SMALLER LETTERS IN THE COLOR RED. BELOW THE WORD "SUPERLOADS" A LINEAR DESIGN DEPICTING RAILROAD TRACKS IN THE COLOR BLACK.

FOR GLOBAL TRANSPORTATION OF FREIGHT FOR OTHERS BY ALL AVAILABLE MEANS (U.S. CLS. 100 AND 105).

FIRST USE 9-1-2003; IN COMMERCE 9-1-2003.
MARK PILARO, EXAMINING ATTORNEY

SN 77-557,043. ATHERTON ASSOCIATES, INC., CORONA DEL MAR, CA. FILED 8-27-2008.

AUTOVINO

THE MARK CONSISTS OF STANDARD CHARACTERS WITHOUT CLAIM TO ANY PARTICULAR FONT, STYLE, SIZE, OR COLOR.

FOR RENTAL OF WAREHOUSE SPACE (U.S. CLS. 100 AND 105).

FIRST USE 6-16-2008; IN COMMERCE 8-5-2008.
JANET LEE, EXAMINING ATTORNEY

SN 77-557,213. ATHERTON ASSOCIATES, INC., CORONA DEL MAR, CA. FILED 8-27-2008.



THE MARK CONSISTS OF A STEERING WHEEL WITH WINGS WITH THE LETTERS "AV" IN THE CENTER OF THE STEERING WHEEL.

FOR RENTAL OF WAREHOUSE SPACE (U.S. CLS. 100 AND 105).

FIRST USE 8-5-2008; IN COMMERCE 8-5-2008.
JANET LEE, EXAMINING ATTORNEY

CLASS 39—(Continued).

SN 77-559,023. CHILDREN'S HOSPITAL MEDICAL CENTER OF AKRON, AKRON, OH. FILED 8-29-2008.

AIR BEAR

THE MARK CONSISTS OF STANDARD CHARACTERS WITHOUT CLAIM TO ANY PARTICULAR FONT, STYLE, SIZE, OR COLOR.

NO CLAIM IS MADE TO THE EXCLUSIVE RIGHT TO USE "AIR", APART FROM THE MARK AS SHOWN.

FOR AIR TRANSPORTATION SERVICES FOR MEDICAL PATIENTS (U.S. CLS. 100 AND 105).

ANDREA SAUNDERS, EXAMINING ATTORNEY

SN 77-562,605. TALLGRASS TRANSMISSION, LLC, OKLAHOMA CITY, OK. FILED 9-4-2008.

TALLGRASS TRANSMISSION

THE MARK CONSISTS OF STANDARD CHARACTERS WITHOUT CLAIM TO ANY PARTICULAR FONT, STYLE, SIZE, OR COLOR.

NO CLAIM IS MADE TO THE EXCLUSIVE RIGHT TO USE "TRANSMISSION", APART FROM THE MARK AS SHOWN.

FOR ELECTRICITY DISTRIBUTION; UTILITY SERVICES, NAMELY, TRANSMISSION OF ELECTRICITY (U.S. CLS. 100 AND 105).

BERYL GARDNER, EXAMINING ATTORNEY

SN 77-563,958. BRESHELL ENTERPRISES, INC., JACKSONVILLE, FL. FILED 9-6-2008.

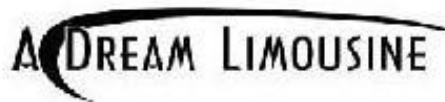

NO CLAIM IS MADE TO THE EXCLUSIVE RIGHT TO USE "LIMOUSINE", APART FROM THE MARK AS SHOWN.

THE MARK CONSISTS OF A CURVED LINE THROUGH THE WORDS "A DREAM LIMOUSINE".

FOR LIMOUSINE SERVICES (U.S. CLS. 100 AND 105).

FIRST USE 5-4-2008; IN COMMERCE 5-4-2008.
THOMAS MANOR, EXAMINING ATTORNEY

CLASS 39—(Continued).

SN 77-564,794. RISING TIDE DEVELOPMENT, LLC, CLEVELAND, OH. FILED 9-8-2008.

COMPASS

THE MARK CONSISTS OF STANDARD CHARACTERS WITHOUT CLAIM TO ANY PARTICULAR FONT, STYLE, SIZE, OR COLOR.

FOR PROVIDING SELF-STORAGE FACILITIES FOR OTHERS (U.S. CLS. 100 AND 105).

FIRST USE 12-18-2007; IN COMMERCE 2-1-2008.

MARIA-VICTORIA SUAREZ, EXAMINING ATTORNEY

SN 77-564,826. RISING TIDE DEVELOPMENT, LLC, CLEVELAND, OH. FILED 9-8-2008.

COMPASS SELF STORAGE

THE MARK CONSISTS OF STANDARD CHARACTERS WITHOUT CLAIM TO ANY PARTICULAR FONT, STYLE, SIZE, OR COLOR.

NO CLAIM IS MADE TO THE EXCLUSIVE RIGHT TO USE "SELF STORAGE", APART FROM THE MARK AS SHOWN.

FOR PROVIDING SELF-STORAGE FACILITIES FOR OTHERS (U.S. CLS. 100 AND 105).

FIRST USE 12-18-2007; IN COMMERCE 2-1-2008.

MARIA-VICTORIA SUAREZ, EXAMINING ATTORNEY

SN 77-564,843. NATIONAL FLEET CLAIMS INC., LONG ISLAND CITY, NY. FILED 9-8-2008.

SCHOOGLE

THE MARK CONSISTS OF STANDARD CHARACTERS WITHOUT CLAIM TO ANY PARTICULAR FONT, STYLE, SIZE, OR COLOR.

FOR SCHOOL BUS TRANSPORTATION SERVICES, NAMELY, TRANSPORTATION OF PASSENGERS BY SCHOOL BUS (U.S. CLS. 100 AND 105).

TINA KUAN, EXAMINING ATTORNEY

CLASS 39—(Continued).

SN 77-564,902. ALEX E. KHAJAVI, PAVAS, SAN JOSE, COSTA RICA, FILED 9-8-2008.

NATURE ROVERS

THE MARK CONSISTS OF STANDARD CHARACTERS WITHOUT CLAIM TO ANY PARTICULAR FONT, STYLE, SIZE, OR COLOR.

FOR RENTAL OF OFF-ROAD VEHICLES (U.S. CLS. 100 AND 105).

FIRST USE 7-0-2005; IN COMMERCE 7-0-2005.

JORDAN BAKER, EXAMINING ATTORNEY

SN 77-564,992. RISING TIDE DEVELOPMENT, LLC, CLEVELAND, OH. FILED 9-8-2008.



THE COLOR(S) YELLOW, BLUE, WHITE IS/ARE CLAIMED AS A FEATURE OF THE MARK.

THE MARK CONSISTS OF A STYLIZED WHITE ARROW OUTLINED IN BLUE WITHIN A YELLOW CIRCLE.

FOR PROVIDING SELF-STORAGE FACILITIES FOR OTHERS (U.S. CLS. 100 AND 105).

FIRST USE 3-31-2008; IN COMMERCE 4-30-2008.

MARIA-VICTORIA SUAREZ, EXAMINING ATTORNEY

SN 77-565,003. RISING TIDE DEVELOPMENT, LLC, CLEVELAND, OH. FILED 9-8-2008.

WE MAKE IT EASIER

THE MARK CONSISTS OF STANDARD CHARACTERS WITHOUT CLAIM TO ANY PARTICULAR FONT, STYLE, SIZE, OR COLOR.

FOR PROVIDING SELF-STORAGE FACILITIES FOR OTHERS (U.S. CLS. 100 AND 105).

FIRST USE 3-31-2008; IN COMMERCE 4-30-2008.

MARIA-VICTORIA SUAREZ, EXAMINING ATTORNEY

CLASS 39—(Continued).

SN 77-565,013. JACIW, JENNIFER, MILPITAS, CA. FILED 9-8-2008.

LONE STAR LIMOUSINE

THE MARK CONSISTS OF STANDARD CHARACTERS WITHOUT CLAIM TO ANY PARTICULAR FONT, STYLE, SIZE, OR COLOR.

NO CLAIM IS MADE TO THE EXCLUSIVE RIGHT TO USE "LIMOUSINE", APART FROM THE MARK AS SHOWN.

FOR LIMOUSINE TRANSPORTATION SERVICES (U.S. CLS. 100 AND 105).

ROBIN MITTLER, EXAMINING ATTORNEY

CLASS 39—(Continued).

SN 77-567,032. SUNCO CARRIERS, INC., LAKELAND, FL. FILED 9-10-2008.

THE CLIMATE ASSURED CARRIER

THE MARK CONSISTS OF STANDARD CHARACTERS WITHOUT CLAIM TO ANY PARTICULAR FONT, STYLE, SIZE, OR COLOR.

NO CLAIM IS MADE TO THE EXCLUSIVE RIGHT TO USE "CARRIER", APART FROM THE MARK AS SHOWN.

FOR FREIGHT TRANSPORTATION BY TRUCK; STORAGE OF REFRIGERATED AND DRY FREIGHT (U.S. CLS. 100 AND 105).

FIRST USE 5-19-2008; IN COMMERCE 5-19-2008.
LINDA POWELL, EXAMINING ATTORNEY

SN 77-565,303. LUNDBLAD, DAVID A., DBA BEST MISSION TRAVEL, ST. CATHARINES, CANADA, FILED 9-9-2008.

BEST MISSION TRAVEL

THE MARK CONSISTS OF STANDARD CHARACTERS WITHOUT CLAIM TO ANY PARTICULAR FONT, STYLE, SIZE, OR COLOR.

NO CLAIM IS MADE TO THE EXCLUSIVE RIGHT TO USE "TRAVEL", APART FROM THE MARK AS SHOWN.

FOR TRAVEL AGENCY SERVICES, NAMELY, MAKING RESERVATIONS AND BOOKINGS FOR TRANSPORTATION (U.S. CLS. 100 AND 105).

JAY FLOWERS, EXAMINING ATTORNEY

SN 77-567,063. SUNCO CARRIERS, INC., LAKELAND, FL. FILED 9-10-2008.



OWNER OF U.S. REG. NO. 2,282,925.

THE MARK IS COMPRISED OF THE STYLIZED WORDING "SUNCO" WITH A PARTIALLY EXPOSED STYLIZED RISING SUN OVER THE RIGHT SIDE OF THE WORDING.

FOR FREIGHT TRANSPORTATION BY TRUCK; STORAGE OF REFRIGERATED AND DRY FREIGHT (U.S. CLS. 100 AND 105).

FIRST USE 5-19-2008; IN COMMERCE 5-19-2008.
LINDA POWELL, EXAMINING ATTORNEY

SN 77-566,441. TIM LIVESAY, ANDERSON, IN. FILED 9-10-2008.

Low Cost Mobility

THE MARK CONSISTS OF STANDARD CHARACTERS WITHOUT CLAIM TO ANY PARTICULAR FONT, STYLE, SIZE, OR COLOR.

NO CLAIM IS MADE TO THE EXCLUSIVE RIGHT TO USE "LOW OR COST", APART FROM THE MARK AS SHOWN.

FOR RENTAL OF SCOOTERS FOR TRANSPORTATION PURPOSES (U.S. CLS. 100 AND 105).

FIRST USE 1-15-2005; IN COMMERCE 1-15-2005.
JILL PRATER, EXAMINING ATTORNEY

SN 77-567,360. BRIAN SCOTT ALPERSTEIN, WASHINGTON, DC. FILED 9-11-2008.

Taste of Peru

THE MARK CONSISTS OF STANDARD CHARACTERS WITHOUT CLAIM TO ANY PARTICULAR FONT, STYLE, SIZE, OR COLOR.

NO CLAIM IS MADE TO THE EXCLUSIVE RIGHT TO USE "PERU", APART FROM THE MARK AS SHOWN.

FOR ORGANIZING AND CONDUCTING CULINARY TOURS IN PERU (U.S. CLS. 100 AND 105).

FIRST USE 1-1-2005; IN COMMERCE 5-1-2005.
KELLEY WELLS, EXAMINING ATTORNEY

CLASS 39—(Continued).

SN 77-568,018. JEN NY INC., DBA FARE BUZZ, NEW YORK, NY. FILED 9-11-2008.

GENESIZ

THE MARK CONSISTS OF STANDARD CHARACTERS WITHOUT CLAIM TO ANY PARTICULAR FONT, STYLE, SIZE, OR COLOR.

FOR RENTAL CAR RESERVATION; TRAVEL AGENCY SERVICES, NAMELY, MAKING RESERVATIONS AND BOOKINGS FOR TRANSPORTATION (U.S. CLS. 100 AND 105).

BARNEY CHARLON, EXAMINING ATTORNEY

SN 77-568,061. JEN NY INC., DBA FARE BUZZ, NEW YORK, NY. FILED 9-11-2008.

GENESIS

THE MARK CONSISTS OF STANDARD CHARACTERS WITHOUT CLAIM TO ANY PARTICULAR FONT, STYLE, SIZE, OR COLOR.

FOR RENTAL CAR RESERVATION; TRAVEL AGENCY SERVICES, NAMELY, MAKING RESERVATIONS AND BOOKINGS FOR TRANSPORTATION (U.S. CLS. 100 AND 105).

BARNEY CHARLON, EXAMINING ATTORNEY

CLASS 40—MATERIAL TREATMENT

SN 77-257,869. UPM PHARMACEUTICALS, INC., BALTIMORE, MD. FILED 8-17-2007.

TRAP AND TRIGGER

THE MARK CONSISTS OF STANDARD CHARACTERS WITHOUT CLAIM TO ANY PARTICULAR FONT, STYLE, SIZE, OR COLOR.

FOR DRUG FORMULATION SERVICES, NAMELY, CUSTOM MANUFACTURE OF PHARMACEUTICALS IN ORAL SUSPENSION FOR CONTROLLED RELEASE DELIVERY (U.S. CLS. 100, 103 AND 106).

BRENDAN REGAN, EXAMINING ATTORNEY

CLASS 40—(Continued).

SN 77-282,602. MASTERS, JEFFREY C., RIVERSIDE, CA. FILED 9-18-2007.



NO CLAIM IS MADE TO THE EXCLUSIVE RIGHT TO USE "CAMPUS TOGS", APART FROM THE MARK AS SHOWN.

THE MARK CONSISTS OF A LARGE LETTER "C" WITH A BANNER LAYING ACROSS THE "C" WITH THE NAME "CAMPUS TOGS" IN THE BANNER.

FOR CUSTOM IMPRINTING OF CLOTHING AND PROMOTIONAL ITEMS, EMBROIDERY SERVICES, SCREEN PRINTING SERVICES (U.S. CLS. 100, 103 AND 106).

FIRST USE 4-17-2007; IN COMMERCE 4-18-2007.
SONYA STEPHENS, EXAMINING ATTORNEY

SN 77-308,683. UPM PHARMACEUTICALS, INC., BALTIMORE, MD. FILED 10-19-2007.

CUSHIONING BEADS

THE MARK CONSISTS OF STANDARD CHARACTERS WITHOUT CLAIM TO ANY PARTICULAR FONT, STYLE, SIZE, OR COLOR.

NO CLAIM IS MADE TO THE EXCLUSIVE RIGHT TO USE "BEADS", APART FROM THE MARK AS SHOWN.

FOR DRUG FORMULATION SERVICES, NAMELY, CUSTOM MANUFACTURE OF PHARMACEUTICALS COMPRESSED INTO SOLID DOSAGE FORM FOR CONTROLLED RELEASE DELIVERY (U.S. CLS. 100, 103 AND 106).

BRENDAN REGAN, EXAMINING ATTORNEY

CLASS 40—(Continued).

SN 77-343,090. CUSTOM T-SHIRT OUTFITTERS, LLC, TEMPLE, TX. FILED 12-3-2007.

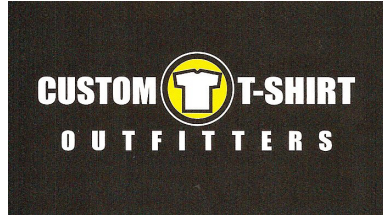

NO CLAIM IS MADE TO THE EXCLUSIVE RIGHT TO USE "CUSTOM T-SHIRT OUTFITTERS", APART FROM THE MARK AS SHOWN.

THE COLOR(S) YELLOW, WHITE AND BLACK IS/ARE CLAIMED AS A FEATURE OF THE MARK.

THE MARK CONSISTS OF A CIRCLE WITH A T-SHIRT INSIDE THE CIRCLE. THE MARK CONSISTS OF THE COLORS YELLOW, WHITE AND BLACK, WITH THE COLOR WHITE APPEARING IN THE T-SHIRT DESIGN, WHICH IS OUTLINED IN BLACK AND AGAINST A ROUND YELLOW AND WHITE CIRCLE DESIGN. THE WORDING "CUSTOM T-SHIRT OUTFITTERS" IS IN WHITE. THE BACKGROUND OF THE MARK IS BLACK.

FOR T-SHIRT EMBROIDERING SERVICES (U.S. CLS. 100, 103 AND 106).

FIRST USE 5-26-2006; IN COMMERCE 5-26-2006.
DAWN HAN, EXAMINING ATTORNEY

SN 77-376,124. PAGE, RICHARD W., DBA R. JEMITHAN TIMBER FRAME COMPANY, LIMINGTON, ME. FILED 1-19-2008.



NO CLAIM IS MADE TO THE EXCLUSIVE RIGHT TO USE "TIMBER FRAME COMPANY" AND "THE MAINE TIMBER FRAMER", APART FROM THE MARK AS SHOWN.

THE NAME(S), PORTRAIT(S), AND/OR SIGNATURE(S) SHOWN IN THE MARK DOES NOT IDENTIFY A PARTICULAR LIVING INDIVIDUAL.

THE COLOR(S) WHITE AND JOHN DEERE GREEN IS/ARE CLAIMED AS A FEATURE OF THE MARK.

THE MARK CONSISTS OF WHITE BACKGROUND WITH JOHN DEERE GREEN LETTERS. SIMPLE, "WIRE FRAME" ROOF DESIGN IN JOHN DEERE GREEN ABOVE THE NAME: "R. JEMITHAN" (BRODY FONT AND UNDERLINED) IN JOHN DEERE GREEN, NEXT LINE IS: "TIMBER FRAME COMPANY" (GARAMOND FONT) IN JOHN DEERE GREEN, WITH A SLICK CHISEL WIRE FRAME OUTLINED HANDLE AND A SOLID BLADE IN JOHN DEERE GREEN UNDER THE WORDS "TIMBER FRAME COMPANY". BELOW THE SLICK CHISEL ARE THE WORDS IN ITALICS WITHIN APOSTROPHIES "THE MAINE TIMBER FRAMER" IN JOHN DEERE GREEN.

FOR SAWING SERVICES FEATURING CUSTOM SAWED TIMBER, CUSTOM WIDE BOARDS AND PLANKS (U.S. CLS. 100, 103 AND 106).

FIRST USE 6-1-2007; IN COMMERCE 6-1-2007.
DANIEL BRODY, EXAMINING ATTORNEY

CLASS 40—(Continued).

SN 77-420,853. ALGENOL BIOFUELS INC., NAPLES, FL. FILED 3-13-2008.

CAPTURES TECHNOLOGY

THE MARK CONSISTS OF STANDARD CHARACTERS WITHOUT CLAIM TO ANY PARTICULAR FONT, STYLE, SIZE, OR COLOR.

NO CLAIM IS MADE TO THE EXCLUSIVE RIGHT TO USE "TECHNOLOGY", APART FROM THE MARK AS SHOWN.

FOR FUEL TREATMENT SERVICES WHEREBY PLANTS, ALGAE AND ORGANISMS ARE USED TO TREAT BIOFUELS IN THE NATURE OF PRIMARY, SECONDARY AND TERTIARY ALCOHOLS, ETHANOL, BUTANOL, BIO-DIESEL AND HYDROGEN FUELS (U.S. CLS. 100, 103 AND 106).

FIRST USE 7-1-2007; IN COMMERCE 7-1-2007.

LEIGH CAROLINE CASE, EXAMINING ATTORNEY

SN 77-453,697. U.S. COTTON, LLC, RIO RANCHO, NM. FILED 4-21-2008.

U.S. COTTON, LLC

THE MARK CONSISTS OF STANDARD CHARACTERS WITHOUT CLAIM TO ANY PARTICULAR FONT, STYLE, SIZE, OR COLOR.

NO CLAIM IS MADE TO THE EXCLUSIVE RIGHT TO USE "COTTON", APART FROM THE MARK AS SHOWN.

SEC. 2(F).

FOR MANUFACTURING SERVICES FOR OTHERS IN THE FIELD OF COTTON PRODUCTS, NAMELY, HEALTH, BEAUTY AIDE, PHARMACEUTICAL, AND INDUSTRIAL COTTON FIBER PRODUCTS (U.S. CLS. 100, 103 AND 106).

FIRST USE 1-1-1996; IN COMMERCE 1-1-1996.

BRIAN NEVILLE, EXAMINING ATTORNEY

SN 77-461,629. ROTO-FAB, WARREN, IN. FILED 4-30-2008.

ROTO-FAB

THE MARK CONSISTS OF STANDARD CHARACTERS WITHOUT CLAIM TO ANY PARTICULAR FONT, STYLE, SIZE, OR COLOR.

FOR MANUFACTURING SERVICES FOR OTHERS IN THE FIELD OF ENGINE ACCESSORIES (U.S. CLS. 100, 103 AND 106).

FIRST USE 4-15-1999; IN COMMERCE 4-15-1999.

JENNY PARK, EXAMINING ATTORNEY

CLASS 40—(Continued).

SN 77-536,349. SCRAP WIRE AND CABLE CORPORATION, FREDERICK, MD. FILED 7-31-2008.



NO CLAIM IS MADE TO THE EXCLUSIVE RIGHT TO USE "SCRAP WIRE AND CABLE CORPORATION", APART FROM THE MARK AS SHOWN.

THE COLOR(S) ORANGE AND BLACK IS/ARE CLAIMED AS A FEATURE OF THE MARK.

THE MARK CONSISTS OF THE WORDS "SCRAP WIRE AND CABLE CORPORATION" IN BLACK. TO THE LEFT OF THE TEXT IS A GRAPHIC OF WIRE ENDS IN ORANGE AND THE TEXT IS ALSO UNDERLINED BY A SWOOSH GRAPHIC THAT IS ALSO ORANGE.

FOR RECYCLING (U.S. CLS. 100, 103 AND 106).
FIRST USE 2-1-2008; IN COMMERCE 3-1-2008.
ALYSSA STEEL, EXAMINING ATTORNEY

CLASS 40—(Continued).

SN 77-552,769. RAIL SPLITTER WIND FARM, LLC, HOUSTON, TX. FILED 8-21-2008.



SN 77-537,622. BOOKEY, JOHN, R. BROOKINGS, OR. AND STAFFORD, KOLLEEN K. BROOKINGS, OR. FILED 8-2-2008.

Got Throttle?

THE MARK CONSISTS OF STANDARD CHARACTERS WITHOUT CLAIM TO ANY PARTICULAR FONT, STYLE, SIZE, OR COLOR.

FOR IMPRINTING MESSAGES ON WEARING APPAREL, ACCESSORIES AND MUGS (U.S. CLS. 100, 103 AND 106).

KIMBERLY FRYE, EXAMINING ATTORNEY

NO CLAIM IS MADE TO THE EXCLUSIVE RIGHT TO USE "WIND FARM", APART FROM THE MARK AS SHOWN.

FOR GENERATION OF ENERGY (U.S. CLS. 100, 103 AND 106).

FIRST USE 12-18-2007; IN COMMERCE 12-18-2007.
GRETTA YAO, EXAMINING ATTORNEY

SN 77-557,913. PHOTOS ETC. CORPORATION, IRVINE, CA. FILED 8-28-2008.

ScanMyPhotos

SN 77-549,184. DEVONNA M. CRANER, DBA HOT CHICKS RECYCLE, ORLANDO, FL. FILED 8-18-2008.

Hot Chicks Recycle

THE MARK CONSISTS OF STANDARD CHARACTERS WITHOUT CLAIM TO ANY PARTICULAR FONT, STYLE, SIZE, OR COLOR.

FOR IMPRINTING MESSAGES ON T-SHIRTS (U.S. CLS. 100, 103 AND 106).

STEVEN JACKSON, EXAMINING ATTORNEY

THE MARK CONSISTS OF STANDARD CHARACTERS WITHOUT CLAIM TO ANY PARTICULAR FONT, STYLE, SIZE, OR COLOR.

OWNER OF U.S. REG. NO. 3,316,602.
FOR DIGITAL PHOTOGRAPHIC PRESERVATION PROCESSING AND FINISHING SERVICES (U.S. CLS. 100, 103 AND 106).

FIRST USE 1-4-2007; IN COMMERCE 1-4-2007.
SARA THOMAS, EXAMINING ATTORNEY

CLASS 40—(Continued).

SN 77-558,217. SADYKOV, VADIM, BROOKLYN, NY. FILED 8-28-2008.



NO CLAIM IS MADE TO THE EXCLUSIVE RIGHT TO USE "LAS VEGAS", APART FROM THE MARK AS SHOWN. THE COLOR(S) WHITE, BLACK, RED IS/ARE CLAIMED AS A FEATURE OF THE MARK.

THE MARK CONSISTS OF "I" IN BLACK, FOLLOWED BY A SPADE IN BLACK, ON WHICH IS OVERLAID A RED HEART, WHICH IS FOLLOWED BY THE STYLIZED WORDING "LAS VEGAS", ON A WHITE BACKGROUND.

FOR CUSTOM IMPRINTING OF CLOTHING WITH DECORATIVE DESIGNS; IMPRINTING MESSAGES ON T-SHIRTS; IMPRINTING MESSAGES ON WEARING APPAREL, ACCESSORIES AND MUGS; T-SHIRT EMBROIDERING SERVICES (U.S. CLS. 100, 103 AND 106).
EDWARD FENNESSY, EXAMINING ATTORNEY

SN 77-562,239. DESIGNER CREATION, LLC, EVANSVILLE, IN. FILED 9-4-2008.

DECOTOPS

THE MARK CONSISTS OF STANDARD CHARACTERS WITHOUT CLAIM TO ANY PARTICULAR FONT, STYLE, SIZE, OR COLOR.

FOR MANUFACTURE OF FURNITURE TO ORDER AND/OR SPECIFICATION OF OTHERS (U.S. CLS. 100, 103 AND 106).

FIRST USE 2-1-2005; IN COMMERCE 2-1-2005.
MICHELE SWAIN, EXAMINING ATTORNEY

SN 77-564,637. SPEEDPRO USA LLC, SCOTTSDALE, AZ. FILED 9-8-2008.

EYE CATCHING COLOR

THE MARK CONSISTS OF STANDARD CHARACTERS WITHOUT CLAIM TO ANY PARTICULAR FONT, STYLE, SIZE, OR COLOR.

FOR CUSTOM MANUFACTURE OF SIGNS, TRADE SHOW EXHIBITS AND DISPLAYS, ARCHITECTURAL RENDERINGS AND BLUEPRINTS; CUSTOM PRINTING SERVICES; CUSTOM SIGN LETTERING (U.S. CLS. 100, 103 AND 106).
BRENDAN MCCAULEY, EXAMINING ATTORNEY

CLASS 40—(Continued).

SN 77-564,928. RINCON STONE & TILE, LLC, TUCSON, AZ. FILED 9-8-2008.

RINCON STONE

THE MARK CONSISTS OF STANDARD CHARACTERS WITHOUT CLAIM TO ANY PARTICULAR FONT, STYLE, SIZE, OR COLOR.

NO CLAIM IS MADE TO THE EXCLUSIVE RIGHT TO USE "STONE", APART FROM THE MARK AS SHOWN.

THE FOREIGN WORDING IN THE MARK TRANSLATES INTO ENGLISH AS CORNER.

FOR CUSTOM FABRICATION OF GRANITE, MARBLE AND NATURAL STONE (U.S. CLS. 100, 103 AND 106).

VIVIAN MICZNIK FIRST, EXAMINING ATTORNEY

SN 77-565,010. JAROB, INC., GRAND RAPIDS, MI. FILED 9-8-2008.

eco-sense

THE MARK CONSISTS OF STANDARD CHARACTERS WITHOUT CLAIM TO ANY PARTICULAR FONT, STYLE, SIZE, OR COLOR.

FOR MANUFACTURING SERVICES FOR OTHERS IN THE FIELD OF INTERIOR AND EXTERIOR COMMERCIAL AND RETAIL SIGNAGE (U.S. CLS. 100, 103 AND 106).

JOHN WILKE, EXAMINING ATTORNEY

SN 77-565,138. RONEY, KATHLEEN, PLEASANTON, CA. FILED 9-8-2008.

invited ink

THE MARK CONSISTS OF STANDARD CHARACTERS WITHOUT CLAIM TO ANY PARTICULAR FONT, STYLE, SIZE, OR COLOR.

FOR CUSTOM CONSTRUCTION OF STATIONERY, PRINTED INVITATIONS, ANNOUNCEMENT CARDS, GREETING CARDS, AND ENVELOPES; DESIGN PRINTING FOR OTHERS (U.S. CLS. 100, 103 AND 106).

FIRST USE 1-1-2004; IN COMMERCE 5-1-2004.
ALYSSA STEEL, EXAMINING ATTORNEY

CLASS 40—(Continued).

SN 77-565,445. SWING LABELS, SHIRLEY, MA. FILED 9-9-2008.

Swing Labels

THE MARK CONSISTS OF STANDARD CHARACTERS WITHOUT CLAIM TO ANY PARTICULAR FONT, STYLE, SIZE, OR COLOR.

NO CLAIM IS MADE TO THE EXCLUSIVE RIGHT TO USE "LABELS", APART FROM THE MARK AS SHOWN.

FOR PRINTING OF BAR CODE LABELS, SHIPPING LABELS, ADHESIVE LABELS, BLANK OR PARTIALLY PRINTED PAPER LABELS, PRINTING FOR PRIVATE LABEL SERVICES (U.S. CLS. 100, 103 AND 106).

FIRST USE 4-1-1999; IN COMMERCE 4-1-1999.

KATHERINE CONNOLLY, EXAMINING ATTORNEY

SN 77-567,437. WEINGARD, ANNA D, NEW MARKET, MD. FILED 9-11-2008.

WWJU

THE MARK CONSISTS OF STANDARD CHARACTERS WITHOUT CLAIM TO ANY PARTICULAR FONT, STYLE, SIZE, OR COLOR.

FOR IMPRINTING MESSAGES ON WEARING APPAREL, ACCESSORIES AND MUGS (U.S. CLS. 100, 103 AND 106).

YAT SYE, LEE, EXAMINING ATTORNEY

SN 77-571,130. PHOTOS ETC. CORPORATION, IRVINE, CA. FILED 9-16-2008.

PHOTO SOAP

THE MARK CONSISTS OF STANDARD CHARACTERS WITHOUT CLAIM TO ANY PARTICULAR FONT, STYLE, SIZE, OR COLOR.

NO CLAIM IS MADE TO THE EXCLUSIVE RIGHT TO USE "PHOTO", APART FROM THE MARK AS SHOWN.

FOR DIGITAL PHOTOFINISHING TO ENHANCE FADED PHOTOS (U.S. CLS. 100, 103 AND 106).

FIRST USE 9-11-2008; IN COMMERCE 9-11-2008.

SARA THOMAS, EXAMINING ATTORNEY

CLASS 40—(Continued).

SN 77-575,581. ICE SYSTEMS & SUPPLIES, INC., ROCK HILL, SC. FILED 9-22-2008.

ISSI

THE MARK CONSISTS OF STANDARD CHARACTERS WITHOUT CLAIM TO ANY PARTICULAR FONT, STYLE, SIZE, OR COLOR.

FOR MANUFACTURING SERVICES FOR OTHERS IN THE FIELD OF CUSTOM COMMERCIAL ICE SYSTEMS (U.S. CLS. 100, 103 AND 106).

FIRST USE 0-0-1977; IN COMMERCE 0-0-1977.

KELLY MCCOY, EXAMINING ATTORNEY

CLASS 41—EDUCATION AND ENTERTAINMENT

SN 76-636,346. HOMIESHOP PROPERTIES, L.L.C., FAIRFIELD, CA. FILED 4-18-2005.

COUNTY DOGPOUND

THE MARK CONSISTS OF STANDARD CHARACTERS WITHOUT CLAIM TO ANY PARTICULAR FONT, STYLE, SIZE, OR COLOR.

FOR ENTERTAINMENT SERVICES IN THE NATURE OF ON-GOING BROADCAST TELEVISION PROGRAMS AND CABLE TELEVISION PROGRAMS IN THE FIELDS OF ANIMATED AND LIVE ACTION COMEDY AND DRAMA; THEATER PRODUCTIONS; MUSICAL THEATER PRODUCTIONS; PRODUCTION AND DISTRIBUTION OF MOTION PICTURES; RADIO ENTERTAINMENT PRODUCTION AND PROGRAMMING; AND PRODUCTION OF LIVE PERFORMANCES BY MUSICAL GROUPS (U.S. CLS. 100, 101 AND 107).

KELLY CHOE, EXAMINING ATTORNEY

SN 76-687,401. AWABA GROUP PTY. LTD, VICTORIA, AUSTRALIA, FILED 3-6-2008.

GET UP'N MOVE

THE MARK CONSISTS OF STANDARD CHARACTERS WITHOUT CLAIM TO ANY PARTICULAR FONT, STYLE, SIZE, OR COLOR.

FOR ENTERTAINMENT SERVICES IN THE NATURE OF LIVE-ACTION CHILDREN'S SHOWS AND ON-GOING TELEVISION SHOWS IN THE PERFORMING ARTS, NAMELY, DANCING, CLASSIC BALLET, FUNK, HIP HOP, JAZZ, BALLET, SINGING, ACTING, AND MUSICAL INSTRUMENTS; MULTI-MEDIA TV PRODUCTION SERVICES, NAMELY, DIRECTING, PRODUCING AND SCRIPT WRITING (U.S. CLS. 100, 101 AND 107).

FIRST USE 2-27-2008; IN COMMERCE 2-27-2008.

ANGELA M. MICHELI, EXAMINING ATTORNEY

CLASS 41—(Continued).

SN 76-692,500. FREMANTLE MEDIA OPERATIONS, B.V., 1217 GP HILVERSUM, NETHERLANDS, FILED 8-29-2008.



THE ENGLISH TRANSLATION OF "DAME LA PISTA" IS "GIVE ME THE CLUE."

FOR ENTERTAINMENT SERVICES, NAMELY, A RECURRING TELEVISED GAME SHOW (U.S. CLS. 100, 101 AND 107).

TRACY FLETCHER, EXAMINING ATTORNEY

SN 76-692,634. WALTERS, JOSE, BROOKLYN, NY. FILED 9-9-2008.

GODDESSES BBW

THE MARK CONSISTS OF STANDARD CHARACTERS WITHOUT CLAIM TO ANY PARTICULAR FONT, STYLE, SIZE, OR COLOR.

NO CLAIM IS MADE TO THE EXCLUSIVE RIGHT TO USE "BBW", APART FROM THE MARK AS SHOWN.

FOR ENTERTAINMENT SERVICES, NAMELY, CONDUCTING SINGLES PARTIES FOR BIG BEAUTIFUL WOMEN (BBWS) AND THEIR ADMIRERS FOR THE PURPOSE OF DATING AND SOCIAL INTRODUCTION (U.S. CLS. 100, 101 AND 107).

FIRST USE 1-1-1991; IN COMMERCE 1-1-1991.
BARBARA GAYNOR, EXAMINING ATTORNEY

SN 76-692,642. WOOLF, BOB, PHOENIX, AZ. FILED 9-9-2008.

FLIP DUNK

THE MARK CONSISTS OF STANDARD CHARACTERS WITHOUT CLAIM TO ANY PARTICULAR FONT, STYLE, SIZE, OR COLOR.

FOR FAMILY FITNESS, TRAINING AND EXERCISE FACILITIES (U.S. CLS. 100, 101 AND 107).

TASNEEM HUSSAIN, EXAMINING ATTORNEY

SN 77-023,492. PARISI, DAN, NEW YORK, NY. FILED 10-18-2006.

MYSPO RTS

THE MARK CONSISTS OF STANDARD CHARACTERS WITHOUT CLAIM TO ANY PARTICULAR FONT, STYLE, SIZE, OR COLOR.

FOR PROVIDING SPORTS INFORMATION VIA THE GLOBAL COMPUTER INFORMATION NETWORK (U.S. CLS. 100, 101 AND 107).

FIRST USE 4-8-1996; IN COMMERCE 4-8-1996.
NANCY CLARKE, EXAMINING ATTORNEY

CLASS 41—(Continued).

SN 77-128,222. CHARISM, CPR, LLC, LAFAYETTE, LA. FILED 3-12-2007.

DEEPMATH

THE MARK CONSISTS OF STANDARD CHARACTERS WITHOUT CLAIM TO ANY PARTICULAR FONT, STYLE, SIZE, OR COLOR.

FOR INSTRUCTION IN MATHEMATICS, NAMELY, A PROGRAM OF MATHEMATICS INSTRUCTION FOR BOTH STUDENTS AND TEACHERS FOCUSING ON GRADES KINDERGARTEN THROUGH 9 (U.S. CLS. 100, 101 AND 107).

FIRST USE 12-31-2000; IN COMMERCE 12-31-2000.
KELLY MCCOY, EXAMINING ATTORNEY

SN 77-155,302. ANTONIO GJON DIAZ, MARBELLA (MALAGA), SPAIN, AND LUIS DE VAL MINGUEZ, MARBELLA (MALAGA), SPAIN, FILED 4-12-2007.

LA PASARELA DEL ALCOHOL

THE MARK CONSISTS OF STANDARD CHARACTERS WITHOUT CLAIM TO ANY PARTICULAR FONT, STYLE, SIZE, OR COLOR.

OWNER OF ERP N CMNTY TM OFC REG. NO. 5702428, DATED 4-2-2008, EXPIRES 6-8-2017.

"THE FOREIGN WORDING IN THE MARK TRANSLATES INTO ENGLISH AS THE RUNWAY OF ALCOHOL."

FOR EDUCATION SERVICES, NAMELY, SEMINARS, CLASSES IN THE FIELD OF CINEMATOGRAPHIC STUDIES, MOVIE PRODUCTION, VIDEO PRODUCTION, MUSIC PRODUCTION, TELEVISION PROGRAM PRODUCTION, LIVE PERFORMANCE PRODUCTION; PROVIDING TRAINING IN THE FIELD OF MOVIE PRODUCTION, VIDEO PRODUCTION, MUSIC PRODUCTION, TELEVISION PROGRAM PRODUCTION, LIVE PERFORMANCE PRODUCTION; ENTERTAINMENT SERVICES, NAMELY, NIGHTCLUBS AND DISCOTHEQUES; ORGANIZING COMMUNITY SPORTING AND CULTURAL EVENTS (U.S. CLS. 100, 101 AND 107).

JILL PRATER, EXAMINING ATTORNEY

SN 77-184,691. 3RD EYE FILMS, INC., AVONDALE ESTATES, GA. FILED 5-18-2007.

SHOW YOUR LOVE

THE MARK CONSISTS OF STANDARD CHARACTERS WITHOUT CLAIM TO ANY PARTICULAR FONT, STYLE, SIZE, OR COLOR.

FOR EDUCATIONAL SERVICES, NAMELY, PROVIDING WORKSHOPS AND SEMINARS ABOUT THE SPREAD OF HIV/AIDS (U.S. CLS. 100, 101 AND 107).

ANNE FARRELL, EXAMINING ATTORNEY

CLASS 41—(Continued).

SN 77-222,509. BROWN, GABRIEL, KINGSTREE, SC. FILED 7-5-2007.



NO CLAIM IS MADE TO THE EXCLUSIVE RIGHT TO USE "ENT.", APART FROM THE MARK AS SHOWN.

THE COLOR(S) BLACK, YELLOW, WHITE AND GREEN IS/ARE CLAIMED AS A FEATURE OF THE MARK.

THE MARK CONSISTS OF A BLACK SQUARE, WITH A WHITE CIRCLE REPRESENTING A HEAD HAVING A BLACK INTERIOR CONTAINING A SMILEY FACE WITH A YELLOW GRILL AS ITS MOUTH AND TWO GREEN DOLLAR SIGNS AS ITS EYES. BELOW THE CIRCLE IS THE TERM "ENT." IN A WHITE OUTLINE AND ABOVE THE CIRCLE ARE THE WORDS "MONEY MAN" IN A WHITE OUTLINE.

FOR ENTERTAINMENT, NAMELY, MUSIC PRODUCTION SERVICES (U.S. CLS. 100, 101 AND 107).

BRENDAN MCCAULEY, EXAMINING ATTORNEY

SN 77-232,973. BIERMANN PRODUCTIONS LLC, WICHITA, KS. FILED 7-18-2007.

FIGHTCENTRAL PRESENTS

THE MARK CONSISTS OF STANDARD CHARACTERS WITHOUT CLAIM TO ANY PARTICULAR FONT, STYLE, SIZE, OR COLOR.

NO CLAIM IS MADE TO THE EXCLUSIVE RIGHT TO USE "PRESENTS", APART FROM THE MARK AS SHOWN.

FOR PRODUCTION AND CONTENT PREPARATION OF AUDIO AND VIDEO ENTERTAINMENT PROGRAMS AND RECORDINGS DELIVERED VIA TELEVISION, RADIO, INTERNET, AND WIRELESS AND MOBILE DEVICES; PRODUCTION OF DVD'S, COMPACT DISKS, AUDIO TAPES AND VIDEOTAPES FEATURING ENTERTAINMENT IN THE FIELDS OF MUSIC, COMEDY, SPORTS, NEWS, FASHION AND THE ARTS (U.S. CLS. 100, 101 AND 107).

MATTHEW MCDOWELL, EXAMINING ATTORNEY

CLASS 41—(Continued).

SN 77-239,275. CONNECTED VENTURES, LLC, NEW YORK, NY. FILED 7-26-2007.



THE MARK CONSISTS OF THE WORD "COLLEGEHUMOR" WITH A JESTER.

SEC. 2(F).

FOR ENTERTAINMENT SERVICES, NAMELY, PROVIDING A WEBSITE FEATURING FUNNY VIDEOS, HUMOR, NEWS, FUNNY ARTICLES, AND GAMES; PROVIDING LINKS TO THE WEBSITES OF OTHERS FEATURING NEWS, HUMOR, FUNNY VIDEOS, AND GAMES (U.S. CLS. 100, 101 AND 107).

FIRST USE 1-0-2000; IN COMMERCE 1-0-2000.

CHARLES L. JENKINS, EXAMINING ATTORNEY

SN 77-240,044. BIERMANN PRODUCTIONS LLC, WICHITA, KS. FILED 7-26-2007.

**ARTISTSCENTRALCASTS
STREAMINGCHOICE CONTROL**

THE MARK CONSISTS OF STANDARD CHARACTERS WITHOUT CLAIM TO ANY PARTICULAR FONT, STYLE, SIZE, OR COLOR.

NO CLAIM IS MADE TO THE EXCLUSIVE RIGHT TO USE "CONTROL", APART FROM THE MARK AS SHOWN.

FOR PRODUCTION AND CONTENT PREPARATION OF AUDIO AND VIDEO ENTERTAINMENT PROGRAMS AND RECORDINGS DELIVERED VIA TELEVISION, RADIO, INTERNET, AND WIRELESS AND MOBILE DEVICES; PRODUCTION OF DVD'S, COMPACT DISKS, AUDIO TAPES AND VIDEOTAPES FEATURING ENTERTAINMENT IN THE FIELDS OF MUSIC, COMEDY, SPORTS, NEWS, FASHION AND THE ARTS (U.S. CLS. 100, 101 AND 107).

MATTHEW MCDOWELL, EXAMINING ATTORNEY

SN 77-243,632. 10 BEST QUESTIONS, LLC, CARSON CITY, NV. FILED 7-31-2007.

10 WORST QUESTIONS

THE MARK CONSISTS OF STANDARD CHARACTERS WITHOUT CLAIM TO ANY PARTICULAR FONT, STYLE, SIZE, OR COLOR.

FOR EDUCATIONAL SERVICES, NAMELY, WORKSHOPS, LECTURES, LIFE COACHING, MENTORING, SEMINARS, CLASSES, COURSES OF INSTRUCTION, CONFERENCES AND GIVING SPEECHES IN THE FIELDS OF NEWS, BUSINESS, RELIGION, HISTORY, ART, ENVIRONMENT, SOCIAL SCIENCES, SCIENCE, MEDICINE, TECHNOLOGY, CURRENT EVENTS, HEALTH, CAREERS, SECURITY, EDUCATION AND LIFE, WELLNESS, SPORTS, REAL ESTATE, HOBBIES, LOVE, ROMANCE, SEX, PETS, TRAVEL; PROVIDING COURSES OF INSTRUCTION IN THE FIELDS OF NEWS, BUSINESS, RELIGION, HISTORY, ART, ENVIR-

CLASS 41—(Continued).

ONMENT, SOCIAL SCIENCES, SCIENCE, MEDICINE, TECHNOLOGY, CURRENT EVENTS, HEALTH, CAREERS, SECURITY, EDUCATION AND LIFE, WELLNESS, SPORTS, REAL ESTATE, HOBBIES, LOVE, ROMANCE, SEX, PETS, TRAVEL FOR INDIVIDUALS, COMPANIES AND OTHER INTERESTED PARTIES BY CREATING AND FACILITATING GROUPS INTERACTIONS; EDUCATIONAL SERVICES, NAMELY, PROVIDING WEB-SEMINARS AND TELESEMINARS IN THE FIELDS OF NEWS, BUSINESS, RELIGION, HISTORY, ART, ENVIRONMENT, SOCIAL SCIENCES, SCIENCE, MEDICINE, TECHNOLOGY, CURRENT EVENTS, HEALTH, CAREERS, SECURITY, EDUCATION AND LIFE, WELLNESS, SPORTS, REAL ESTATE, HOBBIES, LOVE, ROMANCE, SEX, PETS, TRAVEL; PROVIDING LEARNING AND TRAINING CENTERS IN THE FIELDS OF NEWS, BUSINESS, RELIGION, HISTORY, ART, ENVIRONMENT, SOCIAL SCIENCES, SCIENCE, MEDICINE, TECHNOLOGY, CURRENT EVENTS, HEALTH, CAREERS, SECURITY, EDUCATION AND LIFE, WELLNESS, SPORTS, REAL ESTATE, HOBBIES, LOVE, ROMANCE, SEX, PETS, TRAVEL; EDUCATIONAL SERVICES, NAMELY, PROVIDING TRAIN-THE-TRAINER CLASSES IN THE FIELDS OF NEWS, BUSINESS, RELIGION, HISTORY, ART, ENVIRONMENT, SOCIAL SCIENCES, SCIENCE, MEDICINE, TECHNOLOGY, CURRENT EVENTS, HEALTH, CAREERS, SECURITY, EDUCATION AND LIFE, WELLNESS, SPORTS, REAL ESTATE, HOBBIES, LOVE, ROMANCE, SEX, PETS, TRAVEL; PROVIDING ONLINE AT-HOME LEARNING CLASSES IN THE FIELDS OF NEWS, BUSINESS, RELIGION, HISTORY, ART, ENVIRONMENT, SOCIAL SCIENCES, SCIENCE, MEDICINE, TECHNOLOGY, CURRENT EVENTS, HEALTH, CAREERS, SECURITY, EDUCATION AND LIFE, WELLNESS, SPORTS, REAL ESTATE, HOBBIES, LOVE, ROMANCE, SEX, PETS, TRAVEL; EDUCATIONAL SERVICES, NAMELY, PROVIDING MOTIVATIONAL AND EDUCATIONAL SPEAKERS; ENTERTAINMENT SERVICES IN THE NATURE OF AN ON-GOING REALITY BASED TELEVISION PROGRAM IN THE FIELDS OF NEWS, BUSINESS, RELIGION, HISTORY, ART, ENVIRONMENT, SOCIAL SCIENCES, SCIENCE, MEDICINE, TECHNOLOGY, CURRENT EVENTS, HEALTH, CAREERS, SECURITY, EDUCATION AND LIFE, WELLNESS, SPORTS, REAL ESTATE, HOBBIES, LOVE, ROMANCE, SEX, PETS, TRAVEL; PUBLICATION OF ELECTRONIC NEWSPAPERS ACCESSIBLE VIA A GLOBAL COMPUTER NETWORK; ON-LINE PUBLICATION OF E-BOOKS, E-ZINES AND NEWSLETTERS IN THE FIELDS OF NEWS, BUSINESS, RELIGION, HISTORY, ART, ENVIRONMENT, SOCIAL SCIENCES, SCIENCE, MEDICINE, TECHNOLOGY, CURRENT EVENTS, HEALTH, CAREERS, SECURITY, EDUCATION AND LIFE, WELLNESS, SPORTS, REAL ESTATE, HOBBIES, LOVE, ROMANCE, SEX, PETS, TRAVEL; PROVIDING ONGOING RADIO PROGRAMS IN THE FIELDS OF NEWS, BUSINESS, RELIGION, HISTORY, ART, ENVIRONMENT, SOCIAL SCIENCES, SCIENCE, MEDICINE, TECHNOLOGY, CURRENT EVENTS, HEALTH, CAREERS, SECURITY, EDUCATION AND LIFE, WELLNESS, SPORTS, REAL ESTATE, HOBBIES, LOVE, ROMANCE, SEX, PETS, TRAVEL; PRODUCTION OF TELEVISION PROGRAMS; TRAINING COURSES IN STRATEGIC PLANNING RELATING TO ADVERTISING, PROMOTION, MARKETING AND BUSINESS; ENTERTAINMENT SERVICES, NAMELY, PRODUCTION, AND RENTAL OF MOTION PICTURE FILMS, TELEVISION, AND RADIO PROGRAMS, RECORDED ON CDS SOUND AND VIDEO RECORDINGS; ENTERTAINMENT SERVICES, NAMELY, PROVIDING ONLINE COMPUTER GAMES; ENTERTAINMENT SERVICES IN THE

CLASS 41—(Continued).

NATURE OF ON-GOING ANIMATED TELEVISION PROGRAMS; PROVIDING ON-LINE REVIEWS AND INFORMATION ABOUT MOVIES VIA A GLOBAL COMPUTER NETWORK; ENTERTAINMENT IN THE NATURE OF THEATER PRODUCTIONS; ON-LINE JOURNALS, NAMELY, BLOGS IN THE FIELDS OF NEWS, BUSINESS, RELIGION, HISTORY, ART, ENVIRONMENT, SOCIAL SCIENCES, SCIENCE, MEDICINE, TECHNOLOGY, CURRENT EVENTS, HEALTH, CAREERS, SECURITY, EDUCATION AND LIFE, WELLNESS, SPORTS, REAL ESTATE, HOBBIES, LOVE, ROMANCE, SEX, PETS, TRAVEL; PUBLICATION OF BOOKS, MAGAZINES, JOURNALS, MANUALS, AND TEXTBOOKS; SPECIAL EVENT PLANNING; PROVIDING TUTORING SESSIONS IN THE FIELDS OF NEWS, BUSINESS, RELIGION, HISTORY, ART, ENVIRONMENT, SOCIAL SCIENCES, SCIENCE, MEDICINE, TECHNOLOGY, CURRENT EVENTS, HEALTH, CAREERS, SECURITY, EDUCATION AND LIFE, WELLNESS, SPORTS, REAL ESTATE, HOBBIES, LOVE, ROMANCE, SEX, PETS, TRAVEL; EDUCATIONAL AND ENTERTAINMENT SERVICES RENDERED OR RELATING TO RECREATION, NAMELY, ENTERTAINMENT SERVICES IN THE NATURE OF A THEME PARK OR AMUSEMENT PARK SHOW; PRESENTATION OF LIVE STAGE SHOW PERFORMANCES; THEATRICAL PRODUCTIONS; ENTERTAINMENT SERVICES, NAMELY, PRESENTATION OF LIVE SHOW PERFORMANCES; ENTERTAINMENT SERVICES, NAMELY, CONDUCTING FAIRS; ORGANIZING AND PROVIDING EXHIBITIONS AND DISPLAYS AND INTERACTIVE EXHIBITS FOR EDUCATIONAL AND ENTERTAINMENT PURPOSES; PROVIDING ON-LINE COMPUTER GAMES; PRODUCTION AND DISTRIBUTION OF TELEVISION PROGRAMS FOR OTHERS; MUSIC PRODUCTION SERVICES; ONLINE NEWS ANALYSIS AND FEATURES DISTRIBUTION ON SUBJECTS OF GENERAL INTEREST; PROVIDING ONLINE AT-HOME LEARNING CLASSES IN THE FIELDS OF NEWS, BUSINESS, RELIGION, HISTORY, ART, ENVIRONMENT, SOCIAL SCIENCES, SCIENCE, MEDICINE, TECHNOLOGY, CURRENT EVENTS, HEALTH, CAREERS, SECURITY, EDUCATION AND LIFE, WELLNESS, SPORTS, REAL ESTATE, HOBBIES, LOVE, ROMANCE, SEX, PETS, TRAVEL; ENTERTAINMENT SERVICES, NAMELY, PRODUCTION, AND RENTAL OF MOTION PICTURE FILMS, TELEVISION, AND RADIO PROGRAMS, RECORDED ON CDS SOUND AND VIDEO RECORDINGS (U.S. CLS. 100, 101 AND 107).

JANICE L. MCMORROW, EXAMINING ATTORNEY

SN 77-270,546. METABOLIC EFFECT, INC., WINSTON-SALEM, NC. FILED 9-4-2007.

ME METABOLIC EFFECT

THE MARK CONSISTS OF STANDARD CHARACTERS WITHOUT CLAIM TO ANY PARTICULAR FONT, STYLE, SIZE, OR COLOR.

OWNER OF U.S. REG. NO. 3,308,303.
 FOR FITNESS AND EXERCISE INSTRUCTION; EDUCATION SERVICES, NAMELY, CONDUCTING CLASSES, SEMINARS, AND WORKSHOPS ON SUBJECTS OF HEALTH, FITNESS, AND EXERCISE; HEALTH INSTRUCTION (U.S. CLS. 100, 101 AND 107).
 FIRST USE 7-31-2004; IN COMMERCE 7-31-2004.
 MELISSA VALLILLO, EXAMINING ATTORNEY

CLASS 41—(Continued).

SN 77-276,820. COOKIE JAR ENTERTAINMENT INC., MONTREAL, CANADA, FILED 9-11-2007.

METAJETS

THE MARK CONSISTS OF STANDARD CHARACTERS WITHOUT CLAIM TO ANY PARTICULAR FONT, STYLE, SIZE, OR COLOR.

FOR PRODUCTION OF LIVE ACTION AND ANIMATED MOTION PICTURES, PRODUCTION AND DISTRIBUTION OF TELEVISION PROGRAMS; ENTERTAINMENT IN THE NATURE OF LIVE VISUAL, AUDIO, MUSICAL AND THEATRICAL PERFORMANCES FEATURING CHILDREN'S ENTERTAINMENT; ENTERTAINMENT IN THE NATURE OF ONGOING TELEVISION PROGRAMS FEATURING CHILDREN'S ENTERTAINMENT; PROVIDING ONLINE NON-DOWNLOADABLE GAMES FEATURING EDUCATIONAL AND ENTERTAINMENT PROGRAMMING AND INTERACTIVE GAMES VIA A GLOBAL COMPUTER NETWORK AND ON HANDHELD AND WIRELESS DEVICES; PROVIDING ONLINE, NON-DOWNLOADABLE BOOKS FEATURING CHILDREN'S THEMES AND TOPICS (U.S. CLS. 100, 101 AND 107).

KIMBERLY FRYE, EXAMINING ATTORNEY

CLASS 41—(Continued).

SN 77-360,749. RADCLIFFE, DONALD A., COLONIAL HEIGHTS, VA. FILED 12-28-2007.



NO CLAIM IS MADE TO THE EXCLUSIVE RIGHT TO USE "AMERICAN BUSHIDO" AND THE NON-LATIN CHARACTERS THAT MEAN "BUSHIDO EMPTY HANDS", APART FROM THE MARK AS SHOWN.

THE NAME(S), PORTRAIT(S), AND/OR SIGNATURE(S) SHOWN IN THE MARK DOES NOT IDENTIFY A PARTICULAR LIVING INDIVIDUAL.

THE COLOR(S) RED, WHITE, BLUE, BLACK, GOLD IS/ARE CLAIMED AS A FEATURE OF THE MARK.

THE MARK CONSISTS OF RED IS ON THE STRIPES OF THE AMERICAN FLAG, WHITE IS ON THE STRIPES AND THE STARS OF THE AMERICAN FLAG AND ON THE SAMURAI (LOCATED IN THE CENTER OF THE PATCH). BLUE IS THE FIELD BEHIND THE STARS ON THE AMERICAN FLAG. BLACK IS THE BACKGROUND OF THE BORDER AND THE COLOR OF THE SAMURAI. GOLD IS THE WORDING AND THE OUTER BORDER OF THE PATCH.

THE FOREIGN WORDING IN THE MARK TRANSLATES INTO ENGLISH AS LAND OF "RICE BUSHIDO EMPTY HANDS".

THE NON-LATIN CHARACTER(S) IN THE MARK TRANSLITERATE INTO "MY GOK MOW SZE DO HONG SOW".

FOR KARATE INSTRUCTION (U.S. CLS. 100, 101 AND 107).

FIRST USE 8-0-1983; IN COMMERCE 8-0-1983.

RONALD AIKENS, EXAMINING ATTORNEY

SN 77-375,595. CORNERSTONE MARKETING & ADVERTISING, INC, GRAYTON BEACH, FL. FILED 1-18-2008.

VIE PEOPLE + PLACES

THE MARK CONSISTS OF STANDARD CHARACTERS WITHOUT CLAIM TO ANY PARTICULAR FONT, STYLE, SIZE, OR COLOR.

THE FOREIGN WORDING IN THE MARK TRANSLATES INTO ENGLISH AS LIFE.

FOR PROVIDING AN ONLINE MAGAZINE FEATURING TEXT AND GRAPHICS IN THE FIELD OF LIFESTYLE INFORMATION, HUMAN INTEREST STORIES, AND CURRENT EVENTS OF INTEREST (U.S. CLS. 100, 101 AND 107).

FIRST USE 10-0-2008; IN COMMERCE 10-0-2008.

KATHRYN COWARD, EXAMINING ATTORNEY

CLASS 41—(Continued).

SN 77-384,481. ERBAN INK, LTD., GLENDALE HEIGHTS, IL. FILED 1-30-2008.

PrairieMod

THE MARK CONSISTS OF STANDARD CHARACTERS WITHOUT CLAIM TO ANY PARTICULAR FONT, STYLE, SIZE, OR COLOR.

FOR ON-LINE JOURNALS, NAMELY, BLOGS FEATURING DISCUSSIONS OF PHILOSOPHY OF DESIGN, INCLUDING HOUSE DESIGN AND HOUSEHOLD GOODS (U.S. CLS. 100, 101 AND 107).

FIRST USE 2-18-2006; IN COMMERCE 2-18-2006.
NATALIE POLZER, EXAMINING ATTORNEY

CLASS 41—(Continued).

SN 77-388,324. DAVID HENRIE, STUDIO CITY, CA. FILED 2-4-2008.

YUTE COMPOUND

THE MARK CONSISTS OF STANDARD CHARACTERS WITHOUT CLAIM TO ANY PARTICULAR FONT, STYLE, SIZE, OR COLOR.

FOR PROVIDING AN INTERNET WEB SITE FEATURING INFORMATION ABOUT TEEN-RELATED TELEVISION PROGRAMS, FILMS, MUSIC, AND SPORTS (U.S. CLS. 100, 101 AND 107).

DOMINICK J. SALEMI, EXAMINING ATTORNEY

SN 77-387,591. VIACOM INTERNATIONAL INC., NEW YORK, NY. FILED 2-4-2008.

NICKELODEON FANBOY AND CHUM CHUM

THE MARK CONSISTS OF STANDARD CHARACTERS WITHOUT CLAIM TO ANY PARTICULAR FONT, STYLE, SIZE, OR COLOR.

OWNER OF U.S. REG. NOS. 1,217,864, 1,661,169 AND OTHERS.

FOR ENTERTAINMENT SERVICES IN THE NATURE OF TELEVISION SERIES, FEATURING ANIMATION, COMEDY AND DRAMA; PROVIDING ONLINE INFORMATION IN THE FIELD OF ENTERTAINMENT CONCERNING TELEVISION PROGRAMS (U.S. CLS. 100, 101 AND 107).

JEFF DEFORD, EXAMINING ATTORNEY

SN 77-388,428. AMERICAN FOOTBALL SPECIALISTS, INC., BOWLING GREEN, KY. FILED 2-5-2008.

PROKICKER.COM

THE MARK CONSISTS OF STANDARD CHARACTERS WITHOUT CLAIM TO ANY PARTICULAR FONT, STYLE, SIZE, OR COLOR.

FOR INSTRUCTION AND TRAINING IN FOOTBALL KICKING SKILLS (U.S. CLS. 100, 101 AND 107).

FIRST USE 5-7-1999; IN COMMERCE 5-7-1999.
MAYUR VAGHANI, EXAMINING ATTORNEY

SN 77-387,904. LYONS, CHARLES, DBA AUTHENTIC FILMS OR AUTHENTIC PRODUCTIONS, TOLUCA LAKE, CA. FILED 2-4-2008.

Authentic Films

THE MARK CONSISTS OF STANDARD CHARACTERS WITHOUT CLAIM TO ANY PARTICULAR FONT, STYLE, SIZE, OR COLOR.

NO CLAIM IS MADE TO THE EXCLUSIVE RIGHT TO USE "FILMS", APART FROM THE MARK AS SHOWN.

FOR MOTION PICTURE FILM PRODUCTION; PRODUCTION AND DISTRIBUTION OF INDEPENDENT MOTION PICTURES; PRODUCTION AND DISTRIBUTION OF MOTION PICTURES (U.S. CLS. 100, 101 AND 107).

LINDA M. KING, EXAMINING ATTORNEY

SN 77-390,430. TOMLIN MEDIA ENTERPRISES, INC., PALO ALTO, CA. FILED 2-6-2008.

Damn Girl Magazine

THE MARK CONSISTS OF STANDARD CHARACTERS WITHOUT CLAIM TO ANY PARTICULAR FONT, STYLE, SIZE, OR COLOR.

NO CLAIM IS MADE TO THE EXCLUSIVE RIGHT TO USE "GIRL MAGAZINE", APART FROM THE MARK AS SHOWN.

FOR PUBLICATION OF MAGAZINES (U.S. CLS. 100, 101 AND 107).

ODESSA BIBBINS, EXAMINING ATTORNEY

CLASS 41—(Continued).

SN 77-391,784. SPEED CHANNEL, INC., LOS ANGELES, CA. FILED 2-7-2008.



NO CLAIM IS MADE TO THE EXCLUSIVE RIGHT TO USE "SUPERBIKES", APART FROM THE MARK AS SHOWN.

THE MARK CONSISTS OF A PICTURE OF A PERSON RIDING A MOTORCYCLE UNDERNEATH THE WORDING "SUPERBIKES!" APPEARING IN A HIGHLY STYLIZED SCRIPT.

FOR ENTERTAINMENT SERVICES IN THE NATURE OF A TELEVISION SERIES FEATURING TOPICS RELATED TO MOTORSPORTS (U.S. CLS. 100, 101 AND 107).

FIRST USE 6-27-2006; IN COMMERCE 6-27-2006.
RICHARD WHITE, EXAMINING ATTORNEY

SN 77-391,842. POW FITNESS, LLC, METAIRIE, LA. FILED 2-7-2008.

PLAY OR WATCH

THE MARK CONSISTS OF STANDARD CHARACTERS WITHOUT CLAIM TO ANY PARTICULAR FONT, STYLE, SIZE, OR COLOR.

FOR SPORTS TRAINING SERVICES, NAMELY, SPORTS SPEED TRAINING SERVICES, ATHLETIC WEIGHT TRAINING SERVICES AND FOOTBALL TECHNIQUE TRAINING SERVICES (U.S. CLS. 100, 101 AND 107).

MICHAEL WIENER, EXAMINING ATTORNEY

SN 77-393,535. M.A.D. SPORTS TRAINING, LLC, FRANKLIN, TN. FILED 2-11-2008.

M.A.D. Sports Training

THE MARK CONSISTS OF STANDARD CHARACTERS WITHOUT CLAIM TO ANY PARTICULAR FONT, STYLE, SIZE, OR COLOR.

NO CLAIM IS MADE TO THE EXCLUSIVE RIGHT TO USE "SPORTS TRAINING", APART FROM THE MARK AS SHOWN.

FOR PROVIDING ASSISTANCE, PERSONAL TRAINING AND PHYSICAL FITNESS CONSULTATION TO INDIVIDUALS TO HELP THEM MAKE PHYSICAL FITNESS, STRENGTH, CONDITIONING, AND EXERCISE IMPROVEMENT IN THEIR DAILY LIVING (U.S. CLS. 100, 101 AND 107).

FIRST USE 5-7-2007; IN COMMERCE 5-7-2007.
CARYN GLASSER, EXAMINING ATTORNEY

CLASS 41—(Continued).

SN 77-394,506. VIACOM INTERNATIONAL INC., NEW YORK, NY. FILED 2-12-2008.

DANCE ON SUNSET

THE MARK CONSISTS OF STANDARD CHARACTERS WITHOUT CLAIM TO ANY PARTICULAR FONT, STYLE, SIZE, OR COLOR.

NO CLAIM IS MADE TO THE EXCLUSIVE RIGHT TO USE "DANCE", APART FROM THE MARK AS SHOWN.

FOR ENTERTAINMENT SERVICES IN THE NATURE OF TELEVISION SERIES FEATURING LIVE ACTION COMEDY AND DRAMA PROVIDING ONLINE INFORMATION IN THE FIELD OF ENTERTAINMENT CONCERNING TELEVISION PROGRAMS (U.S. CLS. 100, 101 AND 107).

FIRST USE 3-29-2008; IN COMMERCE 3-29-2008.
JEFF DEFORD, EXAMINING ATTORNEY

SN 77-395,843. THERESA D. PATTERSON, BRIARWOOD, NY. FILED 2-13-2008.

Aim 4 Success Tutoring

THE MARK CONSISTS OF STANDARD CHARACTERS WITHOUT CLAIM TO ANY PARTICULAR FONT, STYLE, SIZE, OR COLOR.

NO CLAIM IS MADE TO THE EXCLUSIVE RIGHT TO USE "TUTORING", APART FROM THE MARK AS SHOWN.

FOR EDUCATION SERVICES, NAMELY, PROVIDING TUTORIAL SESSIONS IN THE FIELD(S) OF MATH, SCIENCE, ENGLISH, HISTORY, COLLEGE PREP, ALL ACADEMIC SUBJECTS; EDUCATION SERVICES, NAMELY, PROVIDING TUTORIAL SESSIONS IN THE FIELDS OF MATH, SCIENCE, ENGLISH, HISTORY, COLLEGE PREP, ALL ACADEMIC SUBJECTS; EDUCATION SERVICES, NAMELY, PROVIDING TUTORING IN THE FIELD OF MATH, SCIENCE, ENGLISH, HISTORY, COLLEGE PREP, ALL ACADEMIC SUBJECTS; EDUCATIONAL AND ENTERTAINMENT SERVICES, NAMELY, PROVIDING MOTIVATIONAL AND EDUCATIONAL SPEAKERS; ENTERTAINMENT IN THE NATURE OF AN AMUSEMENT PARK RIDE; CONSULTATION IN THE FIELD OF K-12 EDUCATIONAL SYSTEMS (U.S. CLS. 100, 101 AND 107).

FIRST USE 2-13-2008; IN COMMERCE 2-13-2008.
REGINA DRUMMOND, EXAMINING ATTORNEY

CLASS 41—(Continued).

SN 77-396,209. TRUSTEES OF HAMILTON COLLEGE, CLINTON, NY. FILED 2-13-2008.



THE COLOR(S) BLUE, TAN AND WHITE IS/ARE CLAIMED AS A FEATURE OF THE MARK.
 THE MARK CONSISTS OF THE TERM "HAMILTON" IN BLUE UNDERNEATH A BLUE LINE AND A CUPOLA AND LEAF BOTH OUTLINED IN BLUE AND FILLED BY THE COLORS TAN AND WHITE. THE WHITE BACKGROUND IS NOT CLAIMED AS A FEATURE OF THE MARK.
 FOR EDUCATIONAL SERVICES, NAMELY, CONDUCTING HIGHER EDUCATION CLASSES IN THE FIELD OF LIBERAL ARTS AND DISTRIBUTION OF COURSE MATERIAL IN CONNECTION THEREWITH (U.S. CLS. 100, 101 AND 107).
 FIRST USE 7-1-2002; IN COMMERCE 7-1-2002.
 ANGELA GAW, EXAMINING ATTORNEY

CLASS 41—(Continued).

SN 77-399,689. JUNIOR LEAGUE OF JACKSON, INC., JACKSON, MS. FILED 2-18-2008.

MISTLETOE MARKETPLACE

THE MARK CONSISTS OF STANDARD CHARACTERS WITHOUT CLAIM TO ANY PARTICULAR FONT, STYLE, SIZE, OR COLOR.
 NO CLAIM IS MADE TO THE EXCLUSIVE RIGHT TO USE "MARKETPLACE", APART FROM THE MARK AS SHOWN.
 FOR ORGANIZING AND CONDUCTING AN ONGOING CHRISTMAS FESTIVAL FEATURING FOOD FAIRS, MUSICAL PERFORMANCES, COOKING DEMONSTRATIONS AS WELL AS A VARIETY OF RETAIL MERCHANTS, ARTISTS, ARTISANS, CRAFTSMEN, EXHIBITORS AND AUCTIONS (U.S. CLS. 100, 101 AND 107).
 FIRST USE 0-0-1981; IN COMMERCE 0-0-1981.
 COURTNEY MCCORMICK, EXAMINING ATTORNEY

SN 77-399,703. JUNIOR LEAGUE OF JACKSON, INC., JACKSON, MS. FILED 2-18-2008.

SN 77-398,140. GREENE, ROSS W., NEWTON, MA. FILED 2-15-2008.

THE COLLABORATIVE PROBLEM SOLVING APPROACH



THE MARK CONSISTS OF STANDARD CHARACTERS WITHOUT CLAIM TO ANY PARTICULAR FONT, STYLE, SIZE, OR COLOR.
 OWNER OF U.S. REG. NO. 2,593,295.
 SEC. 2(F).
 FOR EDUCATIONAL SERVICES, NAMELY, CONDUCTING SEMINARS AND WORKSHOPS DIRECTED TO PSYCHOLOGISTS, PSYCHIATRISTS, PARENTS, HEALTH CARE PROFESSIONALS AND OTHER EDUCATION PROFESSIONALS IN THE FIELD OF CHILD AND ADOLESCENT BEHAVIOR PROBLEMS (U.S. CLS. 100, 101 AND 107).
 FIRST USE 2-15-2001; IN COMMERCE 2-15-2001.
 SETH A. RAPPAPORT, EXAMINING ATTORNEY

THE MARK CONSISTS OF A WREATH WITH A BOW COMPRISING THE LOWER PORTION AND MISTLETOE HANGING DOWN IN THE CENTER FROM THE TOP.
 FOR ORGANIZING AND CONDUCTING AN ONGOING CHRISTMAS FESTIVAL FEATURING FOOD FAIRS, MUSICAL PERFORMANCES, COOKING DEMONSTRATIONS AS WELL AS A VARIETY OF RETAIL MERCHANTS, ARTISTS, ARTISANS, CRAFTSMEN, EXHIBITORS AND AUCTIONS (U.S. CLS. 100, 101 AND 107).
 FIRST USE 0-0-1981; IN COMMERCE 0-0-1981.
 COURTNEY MCCORMICK, EXAMINING ATTORNEY

CLASS 41—(Continued).

SN 77-399,717. JUNIOR LEAGUE OF JACKSON, INC., JACKSON, MS. FILED 2-18-2008.



NO CLAIM IS MADE TO THE EXCLUSIVE RIGHT TO USE "MARKETPLACE", APART FROM THE MARK AS SHOWN.

THE MARK CONSISTS OF A WREATH WITH A BOW COMPRISING THE LOWER PORTION AND MISTLETOE HANGING DOWN IN THE CENTER FROM THE TOP, THE WORDS "MISTLETOE MARKETPLACE" FOLLOW ABOVE THE TOP CURVE OF THE WREATH.

FOR ORGANIZING AND CONDUCTING AN ONGOING CHRISTMAS FESTIVAL FEATURING FOOD FAIRS, MUSICAL PERFORMANCES, COOKING DEMONSTRATIONS AS WELL AS A VARIETY OF RETAIL MERCHANTS, ARTISTS, ARTISANS, CRAFTSMEN, EXHIBITORS AND AUCTIONS (U.S. CLS. 100, 101 AND 107).

FIRST USE 0-0-1981; IN COMMERCE 0-0-1981.
COURTNEY MCCORMICK, EXAMINING ATTORNEY

CLASS 41—(Continued).

SN 77-403,426. DIAMOND IN THE ROUGH YOUTH DEVELOPMENT PROGRAM, INC., LAWRENCEVILLE, GA. FILED 2-22-2008.

DIAMOND IN THE ROUGH

THE MARK CONSISTS OF STANDARD CHARACTERS WITHOUT CLAIM TO ANY PARTICULAR FONT, STYLE, SIZE, OR COLOR.

FOR EDUCATIONAL SERVICES IN THE FIELD OF YOUTH DEVELOPMENT AND LEADERSHIP, NAMELY, PROVIDING MENTORING, COACHING, YOUTH PROGRAMS AND YOUTH CAMPS FOR YOUNG PEOPLE AND THEIR FAMILIES IN THE FIELDS OF PERSONAL GROWTH AND DEVELOPMENT, SELF-ESTEEM, STRESS MANAGEMENT, FAMILY DYNAMICS, COMMUNITY EXPECTATIONS, MOTIVATION, ACADEMIC ACHIEVEMENT, HIGHER EDUCATION AND CAREER DEVELOPMENT, AND LEADERSHIP, AND DISTRIBUTING PUBLICATIONS AND COURSE MATERIALS IN CONNECTION THEREWITH; TELEVISION PROGRAM IN THE FIELD OF YOUTH DEVELOPMENT AND LEADERSHIP PROGRAM SERVICES, NAMELY, MENTORING, COACHING, YOUTH PROGRAMS AND YOUTH CAMPS FOR YOUNG PEOPLE AND THEIR FAMILIES IN THE FIELDS OF PERSONAL GROWTH AND DEVELOPMENT, SELF-ESTEEM, STRESS MANAGEMENT, FAMILY DYNAMICS, COMMUNITY EXPECTATIONS, MOTIVATION, ACADEMIC ACHIEVEMENT, HIGHER EDUCATION AND CAREER DEVELOPMENT, AND LEADERSHIP (U.S. CLS. 100, 101 AND 107).

MICHAEL ENGEL, EXAMINING ATTORNEY

SN 77-401,137. BOATPIX.COM, INC., DBA BOATPIX, INC., FT. LAUDERDALE, FL. FILED 2-20-2008.

BOATPIX

THE MARK CONSISTS OF STANDARD CHARACTERS WITHOUT CLAIM TO ANY PARTICULAR FONT, STYLE, SIZE, OR COLOR.

OWNER OF U.S. REG. NO. 2,394,460.
SEC. 2(F).

FOR AERIAL PHOTOGRAPHY; PHOTOGRAPHY; PHOTOGRAPHY SERVICES (U.S. CLS. 100, 101 AND 107).

FIRST USE 12-31-1992; IN COMMERCE 12-31-1992.
FRANK LATTUCA, EXAMINING ATTORNEY

SN 77-403,535. GUENTNER, BRYAN L., OPSREY, FL. FILED 2-22-2008.

The Power of One

THE MARK CONSISTS OF STANDARD CHARACTERS WITHOUT CLAIM TO ANY PARTICULAR FONT, STYLE, SIZE, OR COLOR.

FOR EDUCATION SERVICES, NAMELY, PROVIDING CLASSING AND SEMINARS OVER THE INTERNET AND LIVE IN THE FIELD OF PERSONAL IMPROVEMENT (U.S. CLS. 100, 101 AND 107).

DANNEAN HETZEL, EXAMINING ATTORNEY

CLASS 41—(Continued).

SN 77-404,145. HERSH, ED, NEW YORK, NY. FILED 2-22-2008.

STORYCENTRIC

THE MARK CONSISTS OF STANDARD CHARACTERS WITHOUT CLAIM TO ANY PARTICULAR FONT, STYLE, SIZE, OR COLOR.

FOR FILM AND VIDEO PRODUCTION CONSULTING SERVICES FOR TELEVISION AND CABLE NETWORKS; FILM AND VIDEO PRODUCTION CONSULTING SERVICES FOR DISTRIBUTORS OF PROGRAMS FOR TELEVISION, CABLE, ONLINE, WIRELESS MEDIA, AND OTHER EXISTING FORMS OF MEDIA; FILM AND VIDEO PRODUCTION CONSULTING SERVICES FOR CREATORS OF CONTENT FOR TELEVISION, CABLE, ONLINE, WIRELESS MEDIA, AND OTHER EXISTING FORMS OF MEDIA; FILM AND VIDEO PRODUCTION CONSULTING SERVICES FOR PRODUCERS OF PROGRAMS FOR TELEVISION, CABLE, ONLINE, WIRELESS MEDIA, AND OTHER EXISTING FORMS OF MEDIA; PRODUCTION OF TELEVISION PROGRAMS; MOBILE MEDIA AND ENTERTAINMENT SERVICES IN THE NATURE OF CONTENT PREPARATION TO CREATORS OF CONTENT FOR TELEVISION, CABLE, ONLINE, WIRELESS MEDIA, AND OTHER EXISTING FORMS OF MEDIA; PROVIDING SUPPORT SERVICES TO PRODUCERS OF PROGRAMS FOR TELEVISION, CABLE, ONLINE, WIRELESS MEDIA, AND OTHER EXISTING FORMS OF MEDIA IN THE NATURE OF ENTERTAINMENT SERVICES, NAMELY, MULTIMEDIA PRODUCTION SERVICES (U.S. CLS. 100, 101 AND 107).

FIRST USE 1-26-2008; IN COMMERCE 1-26-2008.
DANIEL CAPSHAW, EXAMINING ATTORNEY

SN 77-405,320. FAITH TABERNACLE ASSOCIATION, INC., OKLAHOMA CITY, OK. FILED 2-25-2008.

DISCOVER FAITH

THE MARK CONSISTS OF STANDARD CHARACTERS WITHOUT CLAIM TO ANY PARTICULAR FONT, STYLE, SIZE, OR COLOR.

OWNER OF U.S. REG. NO. 3,308,670.
NO CLAIM IS MADE TO THE EXCLUSIVE RIGHT TO USE "FAITH", APART FROM THE MARK AS SHOWN.

FOR ENTERTAINMENT SERVICES, NAMELY, AN ON-GOING SERIES FEATURING RELIGION PROVIDED THROUGH TELEVISION AND RADIO BROADCASTS (U.S. CLS. 100, 101 AND 107).

FIRST USE 8-4-2005; IN COMMERCE 3-18-2007.
TINA L. SNAPP, EXAMINING ATTORNEY

CLASS 41—(Continued).

SN 77-405,964. AIGNER-CLARK LLC, LONE TREE, CO. FILED 2-26-2008.

THE SAFE SIDE

THE MARK CONSISTS OF STANDARD CHARACTERS WITHOUT CLAIM TO ANY PARTICULAR FONT, STYLE, SIZE, OR COLOR.

OWNER OF U.S. REG. NOS. 3,292,375, 3,379,278 AND OTHERS.

FOR ENTERTAINMENT SERVICES, NAMELY, PROVIDING A WEBSITE FEATURING VIDEO, STREAMING VIDEO, PHOTOGRAPHIC, AUDIO, AND PROSE PRESENTATIONS TO BROWSERS AND MOBILE COMMUNICATIONS DEVICES VIA THE INTERNET AND WIRELESS NETWORKS, ALL IN THE FIELD OF CHILD SAFETY (U.S. CLS. 100, 101 AND 107).

ROBERT STRUCK, EXAMINING ATTORNEY

SN 77-406,480. PORTABLE PRACTICAL EDUCATIONAL PREPARATION, INC., TUCSON, AZ. FILED 2-26-2008.

**PORTABLE PRACTICAL
EDUCATIONAL PREPARATION,
INC.**

THE MARK CONSISTS OF STANDARD CHARACTERS WITHOUT CLAIM TO ANY PARTICULAR FONT, STYLE, SIZE, OR COLOR.

NO CLAIM IS MADE TO THE EXCLUSIVE RIGHT TO USE "PRACTICAL EDUCATIONAL PREPARATION, INC.", APART FROM THE MARK AS SHOWN.

FOR CHARTER SCHOOL SERVICES; EDUCATIONAL SERVICES, NAMELY, PROVIDING INTERNET AND PRINT-BASED COURSES OF INSTRUCTIONS, PROVIDING CLASSES AND TRAINING IN THE FIELDS OF MICRO-ENTERPRISE DEVELOPMENT AND MICRO-BUSINESS LENDING, SOCIAL EDUCATION AND DEVELOPMENT, BEHAVIORAL HEALTH, COUNSELING AND JOB TRAINING (U.S. CLS. 100, 101 AND 107).

FIRST USE 12-31-1967; IN COMMERCE 12-31-1967.
SANI KHOURI, EXAMINING ATTORNEY

SN 77-410,012. JETBLUE AIRWAYS CORPORATION, FOREST HILLS, NY. FILED 2-29-2008.

JETBLUE FEATURES

THE MARK CONSISTS OF STANDARD CHARACTERS WITHOUT CLAIM TO ANY PARTICULAR FONT, STYLE, SIZE, OR COLOR.

NO CLAIM IS MADE TO THE EXCLUSIVE RIGHT TO USE "FEATURES", APART FROM THE MARK AS SHOWN.

FOR ENTERTAINMENT SERVICES, NAMELY, PROVIDING MOTION PICTURE FILMS, TELEVISION PROGRAMS AND VIDEO SHORTS FOR EXHIBITION ON AIRLINES (U.S. CLS. 100, 101 AND 107).

ANDREA SAUNDERS, EXAMINING ATTORNEY

CLASS 41—(Continued).

SN 77-412,468. LEV LEYTZAN: THE COMPASSIONATE CLOWN ALLEY, INC., LAWRENCE, NY. FILED 3-4-2008.

THE COMPASSIONATE CLOWN
ALLEY, INC.

THE MARK CONSISTS OF STANDARD CHARACTERS WITHOUT CLAIM TO ANY PARTICULAR FONT, STYLE, SIZE, OR COLOR.

NO CLAIM IS MADE TO THE EXCLUSIVE RIGHT TO USE "INC.", APART FROM THE MARK AS SHOWN.

FOR EDUCATION SERVICES, NAMELY, PROVIDING CLASSES, TRAINING, SEMINARS AND WORKSHOPS IN THE CLOWN FIELD AS WELL AS PUPPETRY, BALLOON SCULPTING, MUSIC, MAGIC, DANCE AND COMEDY; CHARITABLE SERVICES, NAMELY, ARRANGING AND CONDUCTING ENTERTAINMENT SHOWS, PERFORMANCES AND/OR EVENTS IN THE NATURE OF THERAPEUTIC CLOWNING AND LIVE PERFORMANCES OF CLOWNS FOR CHILDREN, YOUNG ADULTS, SENIOR CITIZENS AND/OR INDIVIDUALS WHO ARE PHYSICALLY AND/OR MENTALLY ILL AND/OR INCAPACITATED IN HOSPITALS, NURSING HOMES, HOSPICES AND HOMES; ENTERTAINMENT SERVICES IN THE NATURE OF CLOWN EVENTS, SHOWS OR PERFORMANCES; PROVIDING MENTORING AND TRAINING TO INDIVIDUALS WITH DISABILITIES OR ILLNESS IN THE FIELD OF LEADERSHIP (U.S. CLS. 100, 101 AND 107).

FIRST USE 8-1-2003; IN COMMERCE 8-1-2003.
SIMON TENG, EXAMINING ATTORNEY

CLASS 41—(Continued).

SN 77-412,812. REVOLUTION FIGHT CLUB LLC, HOLLYWOOD, FL. FILED 3-4-2008.



NO CLAIM IS MADE TO THE EXCLUSIVE RIGHT TO USE "FIGHT CLUB", APART FROM THE MARK AS SHOWN.

THE MARK CONSISTS OF "REVOLUTION" APPEARING ON TOP OF A DESIGN OF AN EAGLE WITH A STAR SUPERIMPOSED OVER THE EAGLE WITH FIRE AND RAYS OF LIGHT EMANATING FROM BEHIND THE EAGLE. THE TERM "FIGHT" APPEARS ON THE LEFT SIDE OF THE EAGLE AND THE TERM "CLUB" APPEARS ON THE RIGHT SIDE OF THE EAGLE, WITH BOTH TERMS OVERLAPPING THE DESIGN IN THE MIDDLE.

FOR ENTERTAINMENT, NAMELY, LIVE STAGE SHOWS AND PERFORMANCES FEATURING MIXED MARTIAL ARTS; EDUCATIONAL SERVICES, NAMELY, PROVIDING INFORMATION ON THE SUBJECT OF SPORTS AND ENTERTAINMENT; PROVIDING AN INTERNET WEBSITE FEATURING INFORMATION ON THE SUBJECT OF SPORTS AND ENTERTAINMENT (U.S. CLS. 100, 101 AND 107).

ANDREA BUTLER, EXAMINING ATTORNEY

SN 77-412,723. PARFUMERIE DOUGLAS GMBH, HAGEN, FED REP GERMANY, FILED 3-4-2008.

Douglas makes
life
beautiful

THE MARK CONSISTS OF THE STYLIZED TEXT AS SHOWN IN THE ATTACHED ARTWORK.

FOR EDUCATIONAL SERVICES, NAMELY, PROVIDING COURSES IN THE FIELD OF TRAINING OF THIRD PARTIES IN THE AREA OF BEAUTY CARE AND COSMETICS, PARTICULARLY THEORETICAL AND PRACTICAL INSTRUCTION ON THE APPLICATION OF AGENTS THAT ARE USED FOR CARING AND/OR DECORATIVE COSMETICS (U.S. CLS. 100, 101 AND 107).

MARGERY A. TIERNEY, EXAMINING ATTORNEY

SN 77-412,851. REVOLUTION FIGHT CLUB LLC, HOLLYWOOD, FL. FILED 3-4-2008.

REVOLUTION FIGHT CLUB

THE MARK CONSISTS OF STANDARD CHARACTERS WITHOUT CLAIM TO ANY PARTICULAR FONT, STYLE, SIZE, OR COLOR.

NO CLAIM IS MADE TO THE EXCLUSIVE RIGHT TO USE "FIGHT CLUB", APART FROM THE MARK AS SHOWN.

FOR ENTERTAINMENT, NAMELY, LIVE STAGE SHOWS AND PERFORMANCES FEATURING MIXED MARTIAL ARTS; EDUCATIONAL SERVICES, NAMELY, PROVIDING INFORMATION ON THE SUBJECT OF SPORTS AND ENTERTAINMENT; PROVIDING AN INTERNET WEBSITE FEATURING INFORMATION ON THE SUBJECT OF SPORTS AND ENTERTAINMENT (U.S. CLS. 100, 101 AND 107).

ANDREA BUTLER, EXAMINING ATTORNEY

CLASS 41—(Continued).

SN 77-412,899. REVOLUTION FIGHT CLUB LLC, HOLLYWOOD, FL. FILED 3-4-2008.

REVOLUTION FIGHTING CHAMPIONSHIPS

THE MARK CONSISTS OF STANDARD CHARACTERS WITHOUT CLAIM TO ANY PARTICULAR FONT, STYLE, SIZE, OR COLOR.

NO CLAIM IS MADE TO THE EXCLUSIVE RIGHT TO USE "FIGHTING CHAMPIONSHIPS", APART FROM THE MARK AS SHOWN.

FOR ENTERTAINMENT, NAMELY, LIVE STAGE SHOWS AND PERFORMANCES FEATURING MIXED MARTIAL ARTS; EDUCATIONAL SERVICES, NAMELY, PROVIDING INFORMATION ON THE SUBJECT OF SPORTS AND ENTERTAINMENT; PROVIDING AN INTERNET WEBSITE FEATURING INFORMATION ON THE SUBJECT OF SPORTS AND ENTERTAINMENT (U.S. CLS. 100, 101 AND 107).

ANDREA BUTLER, EXAMINING ATTORNEY

CLASS 41—(Continued).

SN 77-414,485. BARRETT PRODUCTIONS, INC., MISSOULA, MT. FILED 3-6-2008.

FLY FISHING AMERICA

THE MARK CONSISTS OF STANDARD CHARACTERS WITHOUT CLAIM TO ANY PARTICULAR FONT, STYLE, SIZE, OR COLOR.

SEC. 2(F).

FOR MULTIMEDIA PRODUCTION OF ENTERTAINMENT PROGRAMMING FEATURING OUTDOOR ACTIVITIES (U.S. CLS. 100, 101 AND 107).

FIRST USE 12-31-1991; IN COMMERCE 12-31-1991.
ANGELA M. MICHELI, EXAMINING ATTORNEY

SN 77-413,309. BOATPIX.COM, INC., FORMERLY BOATPIX, INC., FT. LAUDERDALE, FL. FILED 3-5-2008.

BOATPIX.COM

THE MARK CONSISTS OF STANDARD CHARACTERS WITHOUT CLAIM TO ANY PARTICULAR FONT, STYLE, SIZE, OR COLOR.

OWNER OF U.S. REG. NO. 2,394,460.
SEC. 2(F).

FOR AERIAL PHOTOGRAPHY; PHOTOGRAPHY; PHOTOGRAPHY SERVICES (U.S. CLS. 100, 101 AND 107).

FIRST USE 12-31-1997; IN COMMERCE 12-31-1997.
FRANK LATTUCA, EXAMINING ATTORNEY

SN 77-419,394. BOOKRENTER.COM, INC., SAN JOSE, CA. FILED 3-11-2008.



OWNER OF U.S. REG. NO. 3,276,364.

NO CLAIM IS MADE TO THE EXCLUSIVE RIGHT TO USE "BOOKRENTER.COM", APART FROM THE MARK AS SHOWN.

THE COLOR(S) GRAY, WHITE, ORANGE, GREEN, BLACK AND BROWN IS/ARE CLAIMED AS A FEATURE OF THE MARK.

THE MARK CONSISTS OF THE DESIGN OF A TIKIMAN HOLDING A SPEAR IN ONE HAND WITH THREE BOOKS AT THE TOP OF THE SPEAR TO THE LEFT OF THE WORDING "BOOKRENTER.COM". THE TIKIMAN HAS A BROWN BODY WITH ORANGE HIGHLIGHTS ON HIS TOES, ARMS, FINGERS AND BODY AND AN ORANGE FACE WITH A BROWN AND ORANGE NOSE, A DARK BROWN AND WHITE MOUTH AND PAIR OF EYES, AND DARK BROWN HORIZONTAL TRIBAL MARKINGS ON HIS FACE. THE SPEAR IS DARK BROWN WITH A GRAY AND DARK BROWN BLADE, AND THE BOOKS ON THE SPEAR ARE BROWN WITH ORANGE ACCENTS, DARK BROWN BINDINGS AND GRAY PAGES. THE TIKIMAN IS WEARING A DARK AND LIGHT GREEN GRASS SKIRT AND A DARK BROWN AND WHITE NECKLACE. THE WORDING "BOOK" AND ".COM" IS BLACK, AND THE WORD "RENTER" IS ORANGE.

FOR BOOK RENTALS (U.S. CLS. 100, 101 AND 107).
FIRST USE 8-20-2007; IN COMMERCE 8-20-2007.
SONYA STEPHENS, EXAMINING ATTORNEY

SN 77-414,111. INTERVET INC., MILLSBORO, DE. FILED 3-5-2008.



OWNER OF U.S. REG. NOS. 1,520,254, 3,011,718 AND OTHERS.

NO CLAIM IS MADE TO THE EXCLUSIVE RIGHT TO USE "ANIMAL HEALTH", APART FROM THE MARK AS SHOWN.

THE COLOR(S) BLACK AND RED IS/ARE CLAIMED AS A FEATURE OF THE MARK.

THE MARK CONSISTS OF A STYLIZED "SP" IN RED TO THE LEFT OF THE BLACK WORDING "INTERVET SCHERING-PLOUGH ANIMAL HEALTH".

FOR EDUCATIONAL SERVICES, NAMELY, TRAINING CLASSES AND SEMINARS IN THE FIELD OF VETERINARY CARE AND MEDICINE (U.S. CLS. 100, 101 AND 107).

REBECCA GILBERT, EXAMINING ATTORNEY

CLASS 41—(Continued).

SN 77-420,132. FOURTH STORY MEDIA LLC, NEW YORK, NY. FILED 3-12-2008.

The Amanda Project

THE MARK CONSISTS OF STANDARD CHARACTERS WITHOUT CLAIM TO ANY PARTICULAR FONT, STYLE, SIZE, OR COLOR.

FOR ENTERTAINMENT SERVICES, NAMELY, PROVIDING AN ON-LINE COMPUTER GAME; ELECTRONIC PUBLICATION SERVICES, NAMELY, PUBLICATION OF ELECTRONIC BOOKS, MAGAZINES AND NEWS LETTERS FEATURING ANIMATED CARTOONS, STORIES AND EDUCATIONAL GAMES, COMPETITION AND QUIZZES, AND FAN CLUBS; MOTION PICTURE AND ANIMATED FILM PRODUCTION; LIVE PERFORMANCES AND PERSONAL APPEARANCES BY A COSTUMED CHARACTER; ENTERTAINMENT SERVICES IN THE NATURE OF ORGANIZATION OF COMPETITIONS, NAMELY, ORGANIZATION OF PUZZLES AND QUIZZES; PROVISION OF ON-LINE AND WIRELESS INFORMATION RELATING TO ENTERTAINMENT AND EDUCATION; RADIO PROGRAM PRODUCTION; TELEVISION PROGRAM PRODUCTION, TV ENTERTAINMENT SERVICES, NAMELY, PROVIDING TELEVISION PROGRAMS IN THE FIELD OF CHILDREN'S ENTERTAINMENT; PUBLICATION OF ONLINE BOOKS, NAMELY, COMIC BOOKS AND GRAPHIC NOVELS; PRODUCTION AND DISTRIBUTION OF TELEVISION SHOWS AND MOVIES; PROVIDING ON-LINE EDUCATIONAL COMPUTER GAMES; GAMES, PRODUCTION OF ON-LINE MAGAZINES AND NEWS-LETTERS IN THE FIELD OF CHILDREN'S ENTERTAINMENT AIMED AT CHILDREN/TEENS (U.S. CLS. 100, 101 AND 107).

CAROLYN CATALDO, EXAMINING ATTORNEY

CLASS 41—(Continued).

SN 77-420,145. FOURTH STORY MEDIA LLC, NEW YORK, NY. FILED 3-12-2008.

Druids Awakening

THE MARK CONSISTS OF STANDARD CHARACTERS WITHOUT CLAIM TO ANY PARTICULAR FONT, STYLE, SIZE, OR COLOR.

FOR ENTERTAINMENT SERVICES, NAMELY, PROVIDING AN ON-LINE COMPUTER GAME; ELECTRONIC PUBLICATION SERVICES, NAMELY, PUBLICATION OF ELECTRONIC BOOKS, MAGAZINES AND NEWS LETTERS FEATURING ANIMATED CARTOONS, STORIES AND EDUCATIONAL GAMES, COMPETITION AND QUIZZES, AND FAN CLUBS; MOTION PICTURE AND ANIMATED FILM PRODUCTION; LIVE PERFORMANCES AND PERSONAL APPEARANCES BY A COSTUMED CHARACTER; ENTERTAINMENT SERVICES IN THE NATURE OF ORGANIZATION OF COMPETITIONS, NAMELY, ORGANIZATION OF PUZZLES AND QUIZZES; PROVISION OF ON-LINE AND WIRELESS INFORMATION RELATING TO ENTERTAINMENT AND EDUCATION; RADIO PROGRAM PRODUCTION; TELEVISION PROGRAM PRODUCTION, TV ENTERTAINMENT SERVICES, NAMELY, PROVIDING TELEVISION PROGRAMS IN THE FIELD OF CHILDREN'S ENTERTAINMENT; PUBLICATION OF ONLINE BOOKS, NAMELY, COMIC BOOKS AND GRAPHIC NOVELS; PRODUCTION AND DISTRIBUTION OF TELEVISION SHOWS AND MOVIES; PROVIDING ON-LINE EDUCATIONAL COMPUTER GAMES; GAMES, PRODUCTION OF ON-LINE MAGAZINES AND NEWS-LETTERS IN THE FIELD OF CHILDREN'S ENTERTAINMENT AIMED AT CHILDREN/TEENS (U.S. CLS. 100, 101 AND 107).

CAROLYN CATALDO, EXAMINING ATTORNEY

SN 77-424,196. GROSSMAN, JAMIE J., GLENVIEW, IL. FILED 3-17-2008.

TURNTABLE DESIGN

THE MARK CONSISTS OF STANDARD CHARACTERS WITHOUT CLAIM TO ANY PARTICULAR FONT, STYLE, SIZE, OR COLOR.

FOR ENTERTAINMENT SERVICES, NAMELY, DISC JOCKEY SERVICES FOR BIRTHDAY, ANNIVERSARY, WEDDING, SCHOOL, COMPANY, CLUB, PUBLIC, PRIVATE, AND OTHER PARTIES, INDOOR, OUTDOOR, AND SPECIAL EVENTS; CONDUCTING EXHIBITION SERVICES IN THE NATURE OF MUSIC FESTIVALS AND THE PRESENTATION OF LIVE AND RECORDED MUSIC PERFORMANCES AND CONCERTS (U.S. CLS. 100, 101 AND 107).

DEIRDRE ROBERTSON, EXAMINING ATTORNEY

CLASS 41—(Continued).

SN 77-426,055. THE WIGGLES PTY LIMITED, NEW SOUTH WALES, AUSTRALIA, FILED 3-19-2008.

CLASS 41—(Continued).

SN 77-426,061. THE WIGGLES PTY LIMITED, NEW SOUTH WALES, AUSTRALIA, FILED 3-19-2008.

THE KINGDOM OF PARAMITHI

THE MARK CONSISTS OF STANDARD CHARACTERS WITHOUT CLAIM TO ANY PARTICULAR FONT, STYLE, SIZE, OR COLOR.

FOR ENTERTAINMENT IN THE NATURE OF ONGOING TELEVISION PROGRAMS IN THE FIELD OF CHILDREN'S ENTERTAINMENT; PRODUCTION AND DISTRIBUTION OF CHILDREN'S TELEVISION SERIES, CARTOON TELEVISION PROGRAMS, AND INTERSTITIAL, NAMELY, SHORT PROGRAMS THAT FILL THE SPACES BETWEEN OTHER PROGRAMS; PRODUCTION AND DISTRIBUTION OF TELEVISION PROGRAMS, MOTION PICTURES; ENTERTAINMENT IN THE NATURE OF THEATRICAL PROGRAMS; PRODUCTION OF ENTERTAINMENT, EDUCATIONAL AND INFORMATIONAL PROGRAMS AND CONTENT ON CDS, DVDS, AUDIO CASSETTES AND AUDIO VISUAL CASSETTES, MULTIMEDIA SOFTWARE RECORDED ON CD-ROMS FEATURING ENTERTAINMENT AND EDUCATION FOR CHILDREN, SOUND RECORDINGS, COMPACT DISCS (READ-ONLY- MEMORY), DIGITAL VIDEO DISCS (DVD), VIDEO RECORDINGS AND VIDEO DISK RECORDINGS; PROVIDING ON-LINE ENTERTAINMENT AND ENTERTAINMENT VIA A GLOBAL COMMUNICATIONS NETWORK FEATURING INFORMATION RELATING TO ANIMATED PROGRAMS AND FEATURING ACTIVITIES FOR CHILDREN; PROVIDING ON- LINE ENTERTAINMENT FOR CHILDREN AND ADULTS IN THE NATURE OF STORIES, SONGS, MUSIC, GAMES, MATHEMATICS, DRAMA, AND MAGIC TRICKS, AS WELL AS EDUCATIONAL INFORMATION PERTAINING TO THE FOREGOING AND TO READING AND WRITING (U.S. CLS. 100, 101 AND 107).

JERI J. FICKES, EXAMINING ATTORNEY

KINGDOM PARAMITHI

THE MARK CONSISTS OF STANDARD CHARACTERS WITHOUT CLAIM TO ANY PARTICULAR FONT, STYLE, SIZE, OR COLOR.

FOR ENTERTAINMENT IN THE NATURE OF ONGOING TELEVISION PROGRAMS IN THE FIELD OF CHILDREN'S ENTERTAINMENT; PRODUCTION AND DISTRIBUTION OF CHILDREN'S TELEVISION SERIES, CARTOON TELEVISION PROGRAMS, AND INTERSTITIAL, NAMELY SHORT PROGRAMS THAT FILL THE SPACES BETWEEN OTHER PROGRAMS; PRODUCTION AND DISTRIBUTION OF TELEVISION PROGRAMS, MOTION PICTURES; ENTERTAINMENT IN THE NATURE OF THEATRICAL PROGRAMS; PRODUCTION OF ENTERTAINMENT, EDUCATIONAL AND INFORMATIONAL PROGRAMS AND CONTENT ON CDS, DVDS, AUDIO CASSETTES AND AUDIO VISUAL CASSETTES, MULTIMEDIA SOFTWARE RECORDED ON CD-ROMS FEATURING ENTERTAINMENT AND EDUCATION FOR CHILDREN, SOUND RECORDINGS, COMPACT DISCS (READ-ONLY- MEMORY), DIGITAL VIDEO DISCS (DVD), VIDEO RECORDINGS AND VIDEO DISK RECORDINGS; PROVIDING ON-LINE ENTERTAINMENT AND ENTERTAINMENT VIA A GLOBAL COMMUNICATIONS NETWORK FEATURING INFORMATION RELATING TO ANIMATED PROGRAMS AND FEATURING ACTIVITIES FOR CHILDREN; PROVIDING ON- LINE ENTERTAINMENT FOR CHILDREN AND ADULTS IN THE NATURE OF STORIES, SONGS, MUSIC, GAMES, MATHEMATICS, DRAMA, AND MAGIC TRICKS, AS WELL AS EDUCATIONAL INFORMATION PERTAINING TO THE FOREGOING AND TO READING AND WRITING (U.S. CLS. 100, 101 AND 107).

JERI J. FICKES, EXAMINING ATTORNEY

SN 77-432,300. AZPB LIMITED PARTNERSHIP, DBA ARIZONA DIAMONDBACKS, PHOENIX, AZ. FILED 3-26-2008.

FAWTSY

THE MARK CONSISTS OF STANDARD CHARACTERS WITHOUT CLAIM TO ANY PARTICULAR FONT, STYLE, SIZE, OR COLOR.

FOR ENTERTAINMENT SERVICES, NAMELY, PROVIDING LIVE BASEBALL GAMES, EXHIBITIONS AND COMPETITIONS; ENTERTAINMENT SERVICES, NAMELY, CONDUCTING LIVE EVENTS AND ACTIVITIES IN THE FIELD OF BASEBALL; PROVIDING INFORMATION IN THE FIELD OF BASEBALL (U.S. CLS. 100, 101 AND 107).

BARBARA BROWN, EXAMINING ATTORNEY

CLASS 41—(Continued).

SN 77-432,345. AZPB LIMITED PARTNERSHIP, DBA ARIZONA DIAMONDBACKS, PHOENIX, AZ. FILED 3-26-2008.

FIND A WAY TO SAY YES

THE MARK CONSISTS OF STANDARD CHARACTERS WITHOUT CLAIM TO ANY PARTICULAR FONT, STYLE, SIZE, OR COLOR.

FOR ENTERTAINMENT SERVICES, NAMELY, PROVIDING LIVE BASEBALL GAMES, EXHIBITIONS AND COMPETITIONS; ENTERTAINMENT SERVICES, NAMELY, CONDUCTING LIVE EVENTS AND ACTIVITIES IN THE FIELD OF BASEBALL; PROVIDING INFORMATION IN THE FIELD OF BASEBALL (U.S. CLS. 100, 101 AND 107).

BARBARA BROWN, EXAMINING ATTORNEY

SN 77-432,790. MUD PUDDLE FILMS, LOS ANGELES, CA. FILED 3-27-2008.



NO CLAIM IS MADE TO THE EXCLUSIVE RIGHT TO USE "FILMS", APART FROM THE MARK AS SHOWN.

THE MARK CONSISTS OF A DRAWING OF A BOOT SPLASHING IN A PUDDLE OF MUDDY WATER. THE DRAWING IS SET ON A SINGLE FRAME OF FILM. THE WORDS "MUD PUDDLE FILMS" ARE ABOVE THE FRAME, SLANTED ON AN ANGLE, IN STYLIZED CAPITAL LETTERS.

FOR PRODUCTION OF RELIGIOUS FILMS AND VIDEOS WITH CHRISTIAN THEMES (U.S. CLS. 100, 101 AND 107).

FIRST USE 6-1-2003; IN COMMERCE 6-1-2003.
ANGELA GAW, EXAMINING ATTORNEY

CLASS 41—(Continued).

SN 77-435,722. HICKORY DICKORY DOCK, HICKORY, NC. FILED 3-31-2008.



OWNER OF U.S. REG. NO. 2,086,540.

THE NAME(S), PORTRAIT(S), AND/OR SIGNATURE(S) SHOWN IN THE MARK DOES NOT IDENTIFY A PARTICULAR LIVING INDIVIDUAL.

THE MARK CONSISTS OF A SMILING JUMPING MOUSE WITH OUTSTRETCHED HANDS AND FEET..

SEC. 2(F).

FOR CHILDREN'S ENTERTAINMENT AND AMUSEMENT CENTERS, NAMELY, INTERACTIVE PLAY AREAS (U.S. CLS. 100, 101 AND 107).

FIRST USE 6-24-1996; IN COMMERCE 6-24-1996.

ALEX KEAM, EXAMINING ATTORNEY

SN 77-439,531. JAMES CAMPAGNA, NEW YORK, NY. FILED 4-3-2008.

THE APPLE BROS.

THE MARK CONSISTS OF STANDARD CHARACTERS WITHOUT CLAIM TO ANY PARTICULAR FONT, STYLE, SIZE, OR COLOR.

FOR ENTERTAINMENT SERVICES IN THE NATURE OF LIVE MUSICAL PERFORMANCES (U.S. CLS. 100, 101 AND 107).

FIRST USE 5-1-2002; IN COMMERCE 5-1-2002.

ANDREA K. NADELMAN, EXAMINING ATTORNEY

CLASS 41—(Continued).

SN 77-442,677. SMITHKLINE BEECHAM CORPORATION, PHILADELPHIA, PA. FILED 4-8-2008.

LIVE LIFE MORE FULLY AND
STAY ON THE MOVE WITH
HER2+ BREAST CANCER

THE MARK CONSISTS OF STANDARD CHARACTERS WITHOUT CLAIM TO ANY PARTICULAR FONT, STYLE, SIZE, OR COLOR.

FOR PROVIDING ONLINE EDUCATIONAL INFORMATION DIRECTED TO BREAST CANCER PATIENTS CONCERNING HEALTH, LIFESTYLE AND TRAVEL, AND CANCER TREATMENTS (U.S. CLS. 100, 101 AND 107).

ANNE MADDEN, EXAMINING ATTORNEY

SN 77-442,921. KORDUCKI, DAVID, V, DBA BOWLJET, LLC, DELAFIELD, WI. FILED 4-8-2008.

BOWLJET

THE MARK CONSISTS OF STANDARD CHARACTERS WITHOUT CLAIM TO ANY PARTICULAR FONT, STYLE, SIZE, OR COLOR.

FOR TICKET RESERVATION AND BOOKING SERVICES FOR SPORTING EVENTS (U.S. CLS. 100, 101 AND 107).

FIRST USE 8-8-2007; IN COMMERCE 12-5-2007.

LINDA M. KING, EXAMINING ATTORNEY

SN 77-442,994. MATTEL, INC., EL SEGUNDO, CA. FILED 4-8-2008.

MONSTER HIGH

THE MARK CONSISTS OF STANDARD CHARACTERS WITHOUT CLAIM TO ANY PARTICULAR FONT, STYLE, SIZE, OR COLOR.

FOR ENTERTAINMENT SERVICES, NAMELY, PRODUCTION AND DISTRIBUTION OF TELEVISION SHOWS AND MOVIES; ENTERTAINMENT SERVICES IN THE NATURE OF AN ONGOING TELEVISION PROGRAM FEATURING CHILDREN'S ENTERTAINMENT (U.S. CLS. 100, 101 AND 107).

SUE LAWRENCE, EXAMINING ATTORNEY

CLASS 41—(Continued).

SN 77-444,409. BUILT ENTERTAINMENT GROUP, INC., UNIVERSAL CITY, CA. FILED 4-9-2008.

After the Game

THE MARK CONSISTS OF STANDARD CHARACTERS WITHOUT CLAIM TO ANY PARTICULAR FONT, STYLE, SIZE, OR COLOR.

FOR EDUCATIONAL AND ENTERTAINMENT SERVICES, NAMELY, A CONTINUING PROGRAM ABOUT SPORTS, ATHLETES AND ENTERTAINERS ACCESSIBLE BY RADIO, TELEVISION, SATELLITE, AUDIO, VIDEO AND COMPUTER NETWORKS (U.S. CLS. 100, 101 AND 107).

FIRST USE 4-1-2007; IN COMMERCE 4-1-2007.

H. M. FISHER, EXAMINING ATTORNEY

SN 77-444,879. SEATNATION, L.L.C., PHOENIX, AZ. FILED 4-10-2008.



THE MARK CONSISTS OF THE TERM "SEATNATION SN" AND DESIGN. THE LETTERS "SN" IS STYLIZED, A STAR APPEARS BETWEEN THE LETTER "S" AND THE LETTER "N". A RECTANGLE APPEARS BELOW THE LETTERS "SN" AND ALL OF THESE ELEMENTS APPEAR WITHIN A RECTANGLE. THE TERM "SEATNATION" IS STYLIZED AND APPEARS BELOW THE RECTANGLE DESIGN.

FOR ARRANGING FOR TICKET RESERVATIONS FOR SHOWS AND OTHER ENTERTAINMENT EVENTS; ENTERTAINMENT TICKET AGENCY SERVICES; ONLINE ENTERTAINMENT TICKET AGENCY SERVICES; TICKET RESERVATION AND BOOKING SERVICES FOR ENTERTAINMENT, SPORTING AND CULTURAL EVENTS (U.S. CLS. 100, 101 AND 107).

FIRST USE 11-30-2007; IN COMMERCE 11-30-2007.

MARLENE BELL, EXAMINING ATTORNEY

CLASS 41—(Continued).

SN 77-447,373. D.O.G. INC., DBA BIRMINGHAM CONSULTING, LONG BEACH, CA. FILED 4-14-2008.

THE ESTEEM PRINCIPLE

THE MARK CONSISTS OF STANDARD CHARACTERS WITHOUT CLAIM TO ANY PARTICULAR FONT, STYLE, SIZE, OR COLOR.

NO CLAIM IS MADE TO THE EXCLUSIVE RIGHT TO USE "ESTEEM", APART FROM THE MARK AS SHOWN.

FOR EDUCATIONAL SERVICES, NAMELY, CONDUCTING CLASSES, SEMINARS AND TRAINING IN THE FIELDS OF INTERPERSONAL COMMUNICATION, HEALTH, SELF-ESTEEM AND WELL-BEING, DRUG PREVENTION, PROBLEM-SOLVING, LIFE TRANSITION ADJUSTMENT, AND DIVERSITY; LIFE COACHING SERVICES IN THE FIELDS OF INTERPERSONAL COMMUNICATION, HEALTH, SELF-ESTEEM AND WELL-BEING, DRUG PREVENTION, PROBLEM-SOLVING, LIFE TRANSITION ADJUSTMENT, AND DIVERSITY (U.S. CLS. 100, 101 AND 107).

CIMMERIAN COLEMAN, EXAMINING ATTORNEY

SN 77-460,983. RN ON CALL, INC., CORVALLIS, OR. FILED 4-29-2008.



NO CLAIM IS MADE TO THE EXCLUSIVE RIGHT TO USE "GLUTEN FREE RN", APART FROM THE MARK AS SHOWN.

THE COLOR(S) BLACK, RED AND GREY IS/ARE CLAIMED AS A FEATURE OF THE MARK.

THE MARK CONSISTS OF THE WORD "GLUTEN" IN BLACK UPPER CASE LETTERS, THE WORD "FREE" IN RED LOWER CASE LETTERS, A STYLIZED IMAGE OF A WHEAT STALK IN THE COLOR GREY BEHIND THE WORD "FREE" AND THE WORD "RN" IN BLACK UPPER CASE LETTERS.

FOR EDUCATIONAL SERVICES, NAMELY, CONDUCTING CLASSES, SEMINARS, WORKSHOPS, LECTURES IN THE FIELD OF CELIAC DISEASE AND GLUTEN INTOLERANCE AND DISTRIBUTION THEREWITH (U.S. CLS. 100, 101 AND 107).

FIRST USE 5-1-2007; IN COMMERCE 5-1-2007.

CORY BOONE, EXAMINING ATTORNEY

CLASS 41—(Continued).

SN 77-461,498. AVEC ERIC, LLC, NEW YORK, NY. FILED 4-30-2008.

AVEC ERIC

THE MARK CONSISTS OF STANDARD CHARACTERS WITHOUT CLAIM TO ANY PARTICULAR FONT, STYLE, SIZE, OR COLOR.

THE ENGLISH TRANSLATION OF "AVEC" IS "WITH". FOR EDUCATION SERVICES, NAMELY, CONDUCTING CLASSES, SEMINARS, LIVE EXHIBITIONS AND CONFERENCES IN THE FIELDS OF FOOD, WINE, BEVERAGES, COOKING, BAKING, ENTERTAINING, RECIPES, DIET, NUTRITIONAL ADVICE, DINING AND RESTAURANT INFORMATION, KITCHEN DESIGN, EQUIPMENT AND ACCESSORIES, ETIQUETTE AND TRAVEL; ENTERTAINMENT, NAMELY, A CONTINUING COOKING, FOOD AND TRAVEL SHOW BROADCAST OVER TELEVISION, SATELLITE TELEVISION, AND THE INTERNET (U.S. CLS. 100, 101 AND 107).

LESLIE RICHARDS, EXAMINING ATTORNEY

SN 77-465,130. CARMEL J CERAVOLO, FORT WALTON BEACH, FL. FILED 5-3-2008.

PROLIFIC

THE MARK CONSISTS OF STANDARD CHARACTERS WITHOUT CLAIM TO ANY PARTICULAR FONT, STYLE, SIZE, OR COLOR.

FOR ENTERTAINMENT IN THE NATURE OF VISUAL AND AUDIO PERFORMANCES, NAMELY, MUSICAL BAND, ROCK GROUP, AND DANCE PERFORMANCES (U.S. CLS. 100, 101 AND 107).

FIRST USE 2-5-1999; IN COMMERCE 4-5-2000.

PAUL F. GAST, EXAMINING ATTORNEY

CLASS 41—(Continued).

SN 77-467,544. EPIK ONE, INC., WILLISTON, VT. FILED 5-7-2008.

OM BOOTCAMP

THE MARK CONSISTS OF STANDARD CHARACTERS WITHOUT CLAIM TO ANY PARTICULAR FONT, STYLE, SIZE, OR COLOR.

NO CLAIM IS MADE TO THE EXCLUSIVE RIGHT TO USE "OM", APART FROM THE MARK AS SHOWN.

FOR EDUCATIONAL SERVICES, NAMELY, PROVIDING TRAINING, CLASSES, WORKSHOPS, SEMINARS AND ONLINE TRAINING IN THE FIELD OF ONLINE MARKETING AND ADVERTISING, WEB ANALYTICS, SEARCH ENGINE MARKETING AND ADVERTISING, WEB PUBLISHING AND USABILITY (U.S. CLS. 100, 101 AND 107).

FIRST USE 6-0-2006; IN COMMERCE 3-0-2007.
ERNEST SHOSHO, EXAMINING ATTORNEY

SN 77-471,002. COUNTY OF ALAMEDA, STATE OF CALIFORNIA, OAKLAND, CA. FILED 5-9-2008.

URBAN SHIELD

THE MARK CONSISTS OF STANDARD CHARACTERS WITHOUT CLAIM TO ANY PARTICULAR FONT, STYLE, SIZE, OR COLOR.

FOR TRAINING SERVICES IN THE FIELD OF RESPONSES TO LARGE-SCALE NATURAL DISASTERS, TERRORIST ATTACKS, AND HOSTAGE-TAKING SITUATIONS (U.S. CLS. 100, 101 AND 107).

FIRST USE 9-28-2007; IN COMMERCE 9-28-2007.
JANET LEE, EXAMINING ATTORNEY

SN 77-471,026. COUNTY OF ALAMEDA, STATE OF CALIFORNIA, OAKLAND, CA. FILED 5-9-2008.



THE MARK CONSISTS OF THE WORDS "URBAN SHIELD" WITH A CITY SKYLINE IN THE BACKGROUND. FOR TRAINING SERVICES IN THE FIELD OF RESPONSES TO LARGE-SCALE NATURAL DISASTERS, TERRORIST ATTACKS, AND HOSTAGE-TAKING SITUATIONS (U.S. CLS. 100, 101 AND 107).

FIRST USE 10-1-2007; IN COMMERCE 10-1-2007.
JANET LEE, EXAMINING ATTORNEY

CLASS 41—(Continued).

SN 77-472,953. DESIRE STREET MINISTRIES, DESTIN, FL. FILED 5-13-2008.



THE MARK CONSISTS OF THE HEAD OF A LION CENTERED ON A SHIELD DIVIDED INTO FOUR SECTIONS.

FOR EDUCATIONAL SERVICES, NAMELY, PROVIDING A SCHOOL FEATURING COURSES OF INSTRUCTION AT THE MIDDLE AND HIGH SCHOOL LEVEL GRADES 7-12 AND DISTRIBUTION OF COURSE MATERIAL IN CONNECTION THEREWITH; PROVIDING EDUCATIONAL MENTORING, TUTORING, AND CONSULTING IN THE FIELD OF COLLEGE ADMISSIONS; CHARITABLE SERVICES, NAMELY, PROVIDING SCHOOL SUPPLIES TO CHILDREN IN NEED; ENTERTAINMENT SERVICES, NAMELY, CONDUCTING PARTIES, GALA EVENTS, CONTESTS AND INCENTIVE AWARD PROGRAMS TO ENCOURAGE STUDENTS AND ORGANIZATION MEMBERS TO SET UP AND ACHIEVE GOALS IN ACADEMICS, ATTENDANCE, CITIZENSHIP AND CONDUCT; ARRANGING AND CONDUCTING FOOTBALL, BASKETBALL, BASEBALL, CROSS COUNTRY, TRACK AND GOLF ATHLETIC PROGRAMS AND ATHLETIC COMPETITIONS; ENTERTAINMENT IN THE NATURE OF THEATER PRODUCTIONS AND LIVE MUSICAL PERFORMANCES (U.S. CLS. 100, 101 AND 107).

FIRST USE 9-1-2005; IN COMMERCE 9-1-2005.
TRACY CROSS, EXAMINING ATTORNEY

SN 77-477,492. LANGER, ROBERT A., FOREST HILLS, NY. FILED 5-18-2008.

Coordinated Chaos Productions

THE MARK CONSISTS OF STANDARD CHARACTERS WITHOUT CLAIM TO ANY PARTICULAR FONT, STYLE, SIZE, OR COLOR.

NO CLAIM IS MADE TO THE EXCLUSIVE RIGHT TO USE "PRODUCTIONS", APART FROM THE MARK AS SHOWN.

FOR MULTIMEDIA ENTERTAINMENT SERVICES IN THE NATURE OF RECORDING, PRODUCTION AND POST-PRODUCTION SERVICES IN THE FIELDS OF MUSIC, VIDEO, AND FILMS (U.S. CLS. 100, 101 AND 107).

FIRST USE 5-15-2008; IN COMMERCE 10-1-2008.
LESLEY LAMOTHE, EXAMINING ATTORNEY

CLASS 41—(Continued).

SN 77-478,466. COE, KENNETH, CARY, NC. FILED 5-19-2008.

MYVATAR

THE MARK CONSISTS OF STANDARD CHARACTERS WITHOUT CLAIM TO ANY PARTICULAR FONT, STYLE, SIZE, OR COLOR.

FOR DIGITAL IMAGING SERVICES, NAMELY, CREATING FULL BODIED SCANNED IMAGES OF CONSUMERS (U.S. CLS. 100, 101 AND 107).

FRANK LATTUCA, EXAMINING ATTORNEY

SN 77-481,753. VENOM, LLC, SAN FRANCISCO, CA. FILED 5-22-2008.

DEADLOCKE

THE MARK CONSISTS OF STANDARD CHARACTERS WITHOUT CLAIM TO ANY PARTICULAR FONT, STYLE, SIZE, OR COLOR.

FOR ENTERTAINMENT SERVICES IN THE NATURE OF PROVIDING ONLINE COMPUTER GAMES; PROVIDING INFORMATION ABOUT ONLINE COMPUTER GAMES AND VIDEO GAMES AND ENHANCEMENTS FOR SUCH GAMES VIA THE INTERNET; ARRANGING AND CONDUCTING COMPETITIONS FOR VIDEO GAMERS AND COMPUTER GAME PLAYERS; PROVIDING MULTIPLAYER INTERACTIVE GAMES PROVIDED OVER THE INTERNET; ARRANGING ONLINE COMPETITIONS FOR INTERACTIVE GAME PLAYERS; FAN CLUBS; PROVIDING TRAINING COURSES, NAMELY, PROVIDING TRAINING COURSES, SEMINARS AND WORKSHOPS IN THE MASTERY OF ONLINE COMPUTER GAMES AND WORKSHOPS IN THE FIELD OF COMPUTER GAMES; ORGANIZING COMMUNITY SPORTING AND CULTURAL ACTIVITIES; ORGANIZING ONLINE COMMUNITY EVENTS; ORGANIZING ONLINE COMPUTER EVENTS, NAMELY, ENTERTAINMENT EXHIBITIONS FEATURING COMPUTER GAME PROGRAMS AND ENTERTAINMENT EXHIBITIONS FEATURING FILMS OR PORTIONS THEREOF, AND ONLINE INTERACTIVE GAMES; RENTAL OF COMPUTER GAME PROGRAMS; AMUSEMENT ARCADES; AMUSEMENT PARKS; AMUSEMENT CENTERS; DIGITAL VIDEO, AUDIO AND MULTIMEDIA PUBLISHING SERVICES; DIRECTION AND MAKING OF RADIO AND TELEVISION PROGRAMS; DIRECTION AND PRESENTATION OF PLAYS; ENTERTAINMENT IN THE NATURE OF DANCE PERFORMANCES; ENTERTAINMENT IN THE NATURE OF ONGOING TELEVISION PROGRAMS IN THE FIELD OF CHILDREN'S ENTERTAINMENT; ENTERTAINMENT IN THE NATURE OF MOTION PICTURES; ENTERTAINMENT IN THE NATURE OF THEATER PRODUCTIONS; ENTERTAINMENT IN THE NATURE OF AMUSEMENT PARK SHOWS; ENTERTAINMENT IN THE NATURE OF AMUSEMENT PARK RIDES; ENTERTAINMENT IN THE NATURE OF AMUSEMENT PARK ATTRACTIONS, NAMELY, A THEMED AREA; NON-DOWNLOADABLE RINGTONES; PRE-RECORDED MUSIC, VIDEO, AND GRAPHICS PRESENTED TO MOBILE COMMUNICATIONS DEVICES VIA A GLOBAL COMPUTER NETWORK OF WIRELESS NETWORKS; ENTERTAINMENT SERVICES, NAMELY PROVIDING A WEBSITE FEATURING PHOTOGRAPHIC, AUDIO, VIDEO AND PROSE PRE-

CLASS 41—(Continued).

SENTATIONS FEATURING FANTASY; PROVIDING WEB CASTS IN THE FIELD OF FANTASY, PODCASTS IN THE FIELD OF FANTASY; FILM AND VIDEO PRODUCTION; GAMBLING SERVICES; ON-LINE JOURNALS, NAMELY BLOGS FEATURING FANTASY; PRODUCTION AND DISTRIBUTION OF MOTION PICTURES; PROVIDING A COMPUTER GAME THAT MAY BE ACCESSED NETWORK-WIDE BY NETWORK USERS; PROVIDING ON-LINE CARD GAMES; PROVIDING ON-LINE NON-DOWNLOADABLE ELECTRONIC DICTIONARIES; RENTAL AND COMPUTERIZED ONLINE RENTAL SERVICES FEATURING INTERACTIVE SOFTWARE AND HARDWARE HOME ENTERTAINMENT AND CONSUMER ELECTRONICS IN THE NATURE OF MOTION PICTURES, AUDIO RECORDINGS AND VIDEO RECORDINGS IN THE FANTASY AND SCIENCE FICTION GENRES; THEATRICAL AND MUSICAL FLOOR SHOWS PROVIDED AT DISCOTHEQUES AND NIGHTCLUBS; AND THEATRICAL AND MUSICAL FLOOR SHOWS PROVIDED AT PERFORMANCE VENUES (U.S. CLS. 100, 101 AND 107).

ELISSA GARBER KON, EXAMINING ATTORNEY

SN 77-484,061. SCREAMFEST HORROR FILM FESTIVAL, BEVERLY HILLS, CA. FILED 5-27-2008.

SCREAMFEST

THE MARK CONSISTS OF STANDARD CHARACTERS WITHOUT CLAIM TO ANY PARTICULAR FONT, STYLE, SIZE, OR COLOR.

OWNER OF U.S. REG. NOS. 2,324,616 AND 3,162,000.

FOR EDUCATIONAL AND ENTERTAINMENT AUDIO AND VISUAL PERFORMANCES, NAMELY, CONDUCTING SEMINARS AND MOTION PICTURE DEMONSTRATIONS IN THE FIELD OF TEACHING WRITING, STORY DEVELOPMENT, SPECIAL EFFECTS HORROR ARTISTRY, AND TECHNICAL FUNCTIONS, SUCH AS CINEMATOGRAPHY, EDITING AND ALL FUNCTIONS NECESSITATED IN CREATING A HORROR FILM OR SCREENPLAY, AND COMPETITION IN THE FIELD OF HORROR FILM SCREENWRITING AND FILMMAKING, HOSTING EVENTS WHERE FANS CAN MEET ACTORS, WRITERS, DIRECTORS AND OTHER PEOPLE INVOLVED IN THE PRODUCTION OF HORROR MOVIES (U.S. CLS. 100, 101 AND 107).

FIRST USE 8-15-2001; IN COMMERCE 8-15-2001.

CHRISTOPHER BUONGIORNO, EXAMINING ATTORNEY

CLASS 41—(Continued).

SN 77-489,151. GRANT BRAWITH, DBA TOKAY JR TIGERS YOUTH FOOTBALL & CHEER, LODI, CA. FILED 6-2-2008.



THE COLOR(S) BLACK, VEGAS GOLD, WHITE IS/ARE CLAIMED AS A FEATURE OF THE MARK.

THE MARK CONSISTS OF BLACK OUTLINE OF TIGER HEAD VEGAS GOLD FACE AND MANE WHITE ACCENTS ALONG FACE, MANE, EAR, EYE AND MOUTH.

FOR AMATEUR YOUTH SPORTS SERVICES, NAMELY, ORGANIZING, PROVIDING AND MANAGING YOUTH SPORTS ACTIVITIES (U.S. CLS. 100, 101 AND 107).

FIRST USE 5-16-2008; IN COMMERCE 5-16-2008.
INGA ERVIN, EXAMINING ATTORNEY

SN 77-490,542. JOEY LOGANO RACING, LLC, CONCORD, NC. FILED 6-4-2008.

Sliced Bread

THE MARK CONSISTS OF STANDARD CHARACTERS WITHOUT CLAIM TO ANY PARTICULAR FONT, STYLE, SIZE, OR COLOR.

"SLICED BREAD" IS A NICKNAME USED TO IDENTIFY JOEY LOGANO, A PARTICULAR LIVING INDIVIDUAL WHOSE CONSENT IS OF RECORD.

FOR ENTERTAINMENT SERVICES IN THE NATURE OF COMPETING IN PROFESSIONAL AUTOMOBILE RACES (U.S. CLS. 100, 101 AND 107).

KATHERINE STOIDES, EXAMINING ATTORNEY

SN 77-491,802. BOARD OF EDUCATION OF THE KENTON COUNTY SCHOOL DISTRICT, FORT WRIGHT, KY. FILED 6-5-2008.



NO CLAIM IS MADE TO THE EXCLUSIVE RIGHT TO USE "KENTON COUNTRY SCHOOL DISTRICT", APART FROM THE MARK AS SHOWN.

FOR EDUCATION, NAMELY, PROVIDING COURSES OF INSTRUCTION AT THE PRIMARY AND SECONDARY LEVEL (U.S. CLS. 100, 101 AND 107).

FIRST USE 2-22-2007; IN COMMERCE 2-22-2007.
CARRIE GENOVESE, EXAMINING ATTORNEY

CLASS 41—(Continued).

SN 77-494,483. WESTERN NEWS& INFO, YUMA, AZ. FILED 6-9-2008.

CAMP VERDE BUGLE

THE MARK CONSISTS OF STANDARD CHARACTERS WITHOUT CLAIM TO ANY PARTICULAR FONT, STYLE, SIZE, OR COLOR.

NO CLAIM IS MADE TO THE EXCLUSIVE RIGHT TO USE "CAMP VERDE", APART FROM THE MARK AS SHOWN.

FOR ONLINE ELECTRONIC PUBLISHING OF BOOKS AND PERIODICALS FROM THE PRIMARY SOURCE (U.S. CLS. 100, 101 AND 107).

FIRST USE 1-1-1985; IN COMMERCE 1-1-1985.
LAURA HAMMEL, EXAMINING ATTORNEY

SN 77-496,609. THE JOHNSON GROUP, MCLEAN, VA. FILED 6-11-2008.

PAPER CLIPS

THE MARK CONSISTS OF STANDARD CHARACTERS WITHOUT CLAIM TO ANY PARTICULAR FONT, STYLE, SIZE, OR COLOR.

FOR PRODUCTION AND DISTRIBUTION OF MOTION PICTURE FILMS, DOCUMENTARY FILMS, AND TELEVISION SHOWS; PRODUCTION OF VIDEO TAPES, CASSETTES, FILMS AND DISCS; PRODUCTION OF MUSIC RECORDINGS; PRODUCTION OF AUDIO AND VIDEO RECORDINGS FEATURING A WIDE VARIETY OF THEMES; SCREENPLAY WRITING AND SCRIPT WRITING SERVICES; SCRIPT AND SCREENPLAY WRITING ASSISTANCE SERVICES, NAMELY, ANALYSIS OF AND CONSULTATIONS ABOUT SCRIPTS AND SCREENPLAY; PROVIDING A WEBSITE FEATURING INFORMATION IN THE FIELD OF EDUCATION AND ENTERTAINMENT, NAMELY, MOTION PICTURE FILMS, MUSIC, TELEVISION PROGRAMS, BIOGRAPHICAL AND HISTORICAL PROFILES (U.S. CLS. 100, 101 AND 107).

MARY ROSSMAN, EXAMINING ATTORNEY

CLASS 41—(Continued).

SN 77-501,897. BURGER KING BRANDS, INC., MIAMI, FL. FILED 6-18-2008.

TU CIUDAD TU MUSICA

THE MARK CONSISTS OF STANDARD CHARACTERS WITHOUT CLAIM TO ANY PARTICULAR FONT, STYLE, SIZE, OR COLOR.

THE FOREIGN WORDING IN THE MARK TRANSLATES INTO ENGLISH AS YOUR CITY YOUR MUSIC.

FOR ENTERTAINMENT SERVICES, NAMELY, ORGANIZING AND CONDUCTING MUSICAL COMPETITIONS AND LIVE MUSIC CONCERTS (U.S. CLS. 100, 101 AND 107).

FIRST USE 3-9-2007; IN COMMERCE 3-9-2007.
BRIAN PINO, EXAMINING ATTORNEY

SN 77-507,044. WESTON EDUCATIONAL, INC., DENVER, CO. FILED 6-24-2008.

HERITAGE EDUCATION

THE MARK CONSISTS OF STANDARD CHARACTERS WITHOUT CLAIM TO ANY PARTICULAR FONT, STYLE, SIZE, OR COLOR.

OWNER OF U.S. REG. NO. 3,284,433.

NO CLAIM IS MADE TO THE EXCLUSIVE RIGHT TO USE "EDUCATION", APART FROM THE MARK AS SHOWN.

FOR EDUCATIONAL SERVICES, NAMELY, PROVIDING COURSES OF INSTRUCTION AT THE POSTSECONDARY AND PROFESSIONAL LEVEL AND DISTRIBUTION OF COURSE MATERIAL IN CONNECTION THEREWITH (U.S. CLS. 100, 101 AND 107).

FIRST USE 6-22-2001; IN COMMERCE 6-22-2001.
ESTHER BELENKER, EXAMINING ATTORNEY

SN 77-509,757. PLAYGR8, LLC, SOUTHEASTERN, PA. FILED 6-27-2008.

PlayGr8

THE MARK CONSISTS OF STANDARD CHARACTERS WITHOUT CLAIM TO ANY PARTICULAR FONT, STYLE, SIZE, OR COLOR.

FOR ONLINE VIDEO TENNIS INSTRUCTION; PROVIDING NEWS AND INFORMATION IN THE FIELD OF TENNIS (U.S. CLS. 100, 101 AND 107).

LINDA ORNDORFF, EXAMINING ATTORNEY

CLASS 41—(Continued).

SN 77-511,939. GUZZO, SHERRY L. DBA ADDRESSING ELEGANCE, OFALLON, MO. FILED 7-1-2008.

Addressing Elegance

THE MARK CONSISTS OF STANDARD CHARACTERS WITHOUT CLAIM TO ANY PARTICULAR FONT, STYLE, SIZE, OR COLOR.

FOR CALLIGRAPHY SERVICES (U.S. CLS. 100, 101 AND 107).

FIRST USE 10-7-1994; IN COMMERCE 10-7-1994.
GEOFFREY FOSDICK, EXAMINING ATTORNEY

SN 77-512,290. ADAMS, YOLANDA, HOUSTON, TX. FILED 7-1-2008.

Yolanda Adams Radio Network

THE MARK CONSISTS OF STANDARD CHARACTERS WITHOUT CLAIM TO ANY PARTICULAR FONT, STYLE, SIZE, OR COLOR.

NO CLAIM IS MADE TO THE EXCLUSIVE RIGHT TO USE "RADIO NETWORK", APART FROM THE MARK AS SHOWN.

THE NAME "YOLANDA ADAMS" IDENTIFIES A LIVING INDIVIDUAL WHOSE CONSENT IS OF RECORD.

FOR RADIO ENTERTAINMENT SERVICES, NAMELY, RADIO PROGRAMS FEATURING PERFORMANCES BY A RADIO PERSONALITY (U.S. CLS. 100, 101 AND 107).

WILLIAM VERHOSEK, EXAMINING ATTORNEY

CLASS 41—(Continued).

SN 77-518,425. LOCKHART, LISA, LAGUNA NIGUEL, CA. FILED 7-9-2008.

Conscious Performance

THE MARK CONSISTS OF STANDARD CHARACTERS WITHOUT CLAIM TO ANY PARTICULAR FONT, STYLE, SIZE, OR COLOR.

NO CLAIM IS MADE TO THE EXCLUSIVE RIGHT TO USE "PERFORMANCE", APART FROM THE MARK AS SHOWN.

FOR EDUCATIONAL SERVICES, NAMELY, PROVIDING CLASSES, SEMINARS, AND WORKSHOPS IN THE FIELD OF A MODEL AND METHODOLOGY OF BENCHMARKING AND MEASURING PERFORMANCE WITHIN ANY FOR-PROFIT, GOVERNMENT, OR NON-PROFIT ORGANIZATION IN KEY AREAS THAT ARE BASED ON UNIVERSAL HUMAN VALUES WHICH HAVE BEEN DEMONSTRATED TO TRANSLATE INTO WELL-BEING AND SUCCESS FOR BOTH THE INDIVIDUAL EMPLOYEE AND THE ORGANIZATION; TRAINING SERVICES IN THE FIELD OF CLASSES, SEMINARS, AND WORKSHOPS IN THE FIELD OF A MODEL AND METHODOLOGY OF BENCHMARKING AND MEASURING PERFORMANCE WITHIN ANY FOR-PROFIT, GOVERNMENT, OR NON-PROFIT ORGANIZATION IN KEY AREAS THAT ARE BASED ON UNIVERSAL HUMAN VALUES WHICH HAVE BEEN DEMONSTRATED TO TRANSLATE INTO WELL-BEING AND SUCCESS FOR BOTH THE INDIVIDUAL EMPLOYEE AND THE ORGANIZATION (U.S. CLS. 100, 101 AND 107).

FIRST USE 2-5-2006; IN COMMERCE 2-5-2006.
STEVEN R. FOSTER, EXAMINING ATTORNEY

SN 77-519,636. NGC NETWORK US, LLC, LOS ANGELES, CA. FILED 7-10-2008.

EXPEDITION WEEK

THE MARK CONSISTS OF STANDARD CHARACTERS WITHOUT CLAIM TO ANY PARTICULAR FONT, STYLE, SIZE, OR COLOR.

FOR ENTERTAINMENT SERVICES IN THE NATURE OF TELEVISION PROGRAMMING FEATURING ADVENTURE, DRAMA AND DOCUMENTARY SHOWS (U.S. CLS. 100, 101 AND 107).

SHAILA SETTLES, EXAMINING ATTORNEY

CLASS 41—(Continued).

SN 77-522,001. WOLSLEBEN, BILL, PORTLAND, OR. FILED 7-14-2008.

GHOSTHALO

THE MARK CONSISTS OF STANDARD CHARACTERS WITHOUT CLAIM TO ANY PARTICULAR FONT, STYLE, SIZE, OR COLOR.

FOR PROVIDING A WEB SITE FEATURING EDUCATIONAL AND ENTERTAINMENT RELATED ARTICLES CONCERNING THE PARANORMAL, ENTERTAINMENT IN THE FORM OF NEWS SHOWS AND ARTICLES AND FORUMS AND ONLINE JOURNALS, NAMELY, BLOGS CONCERNING THE PARANORMAL ALL PROVIDED BY MEANS OF A GLOBAL COMPUTER NETWORK (U.S. CLS. 100, 101 AND 107).

FIRST USE 4-12-2000; IN COMMERCE 11-9-2007.
LINDA MICKLEBURGH, EXAMINING ATTORNEY

SN 77-527,818. NEVADA POPS, INC., LAS VEGAS, NV. FILED 7-21-2008.



NO CLAIM IS MADE TO THE EXCLUSIVE RIGHT TO USE "NEVADA POPS" AND "MUSIC DIRECTOR", APART FROM THE MARK AS SHOWN.

THE NAME "RICHARD MCGEE" IDENTIFIES A LIVING INDIVIDUAL WHOSE CONSENT IS OF RECORD.

THE MARK CONSISTS OF A DESIGN OF A 5 POINT STAR WITH THE WORDING "NEVADA POPS" TO THE RIGHT OF IT AND THE WORDING "RICHARD MCGEE, MUSIC DIRECTOR" APPEARING IMMEDIATELY UNDERNEATH THE WORDING "NEVADA POPS".

FOR ENTERTAINMENT SERVICES IN THE NATURE OF LIVE MUSICAL PERFORMANCES (U.S. CLS. 100, 101 AND 107).

FIRST USE 5-23-2008; IN COMMERCE 5-23-2008.
HAI-LY LAM, EXAMINING ATTORNEY

CLASS 41—(Continued).

SN 77-532,936. ADVENTURES OUTFITTING LLC, BOZEMAN, MT. FILED 7-28-2008.



NO CLAIM IS MADE TO THE EXCLUSIVE RIGHT TO USE "ADVENTURES OUTFITTING", APART FROM THE MARK AS SHOWN.

THE MARK CONSISTS OF THE WORDS "ADVENTURES OUTFITTING" OVER A DRAWING OF A MOUNTAIN WITH AN ELK WALKING BELOW.

FOR ARRANGING AND CONDUCTING LIVE, INTERACTIVE, TREASURE HUNT GAMING ADVENTURES; FISHING GUIDE SERVICES; HUNTING GUIDE SERVICES; PROVIDING INFORMATION ON RECREATIONAL FISHING; RECREATIONAL SERVICES IN THE NATURE OF HORSEBACK TRAIL RIDES AND PACK TRIPS (U.S. CLS. 100, 101 AND 107).

FIRST USE 1-1-2008; IN COMMERCE 1-1-2008.
MICHAEL LITZAU, EXAMINING ATTORNEY

SN 77-534,986. YOOTRAIN, LLC, CARMEL, IN. FILED 7-30-2008.

YOOTRAIN

THE MARK CONSISTS OF STANDARD CHARACTERS WITHOUT CLAIM TO ANY PARTICULAR FONT, STYLE, SIZE, OR COLOR.

FOR PROVIDING A WEBSITE IN THE FIELD OF PERSONAL STRENGTH AND CONDITIONING TRAINING (U.S. CLS. 100, 101 AND 107).

SEAN CROWLEY, EXAMINING ATTORNEY

SN 77-539,102. WELLNESS RESOURCES, INC., MINNEAPOLIS, MN. FILED 8-5-2008.

LEPTIN LIFESTYLE

THE MARK CONSISTS OF STANDARD CHARACTERS WITHOUT CLAIM TO ANY PARTICULAR FONT, STYLE, SIZE, OR COLOR.

OWNER OF U.S. REG. NOS. 3,214,290, 3,220,889 AND 3,238,454.

FOR EDUCATIONAL SERVICES, NAMELY, PROVIDING PODCASTS AND ONLINE SEMINARS IN THE FIELDS OF HEALTH AND NUTRITION (U.S. CLS. 100, 101 AND 107).

MATTHEW PAPPAS, EXAMINING ATTORNEY

CLASS 41—(Continued).

SN 77-539,583. TELEVISA, S.A. DE C.V., COLONIA ZEDEC SANTA FE, MEXICO, FILED 8-5-2008.

DESMADRUGADOS

THE MARK CONSISTS OF STANDARD CHARACTERS WITHOUT CLAIM TO ANY PARTICULAR FONT, STYLE, SIZE, OR COLOR.

OWNER OF MEXICO REG. NO. 1005159, DATED 9-28-2007, EXPIRES 8-23-2017.

THE FOREIGN WORDING IN THE MARK TRANSLATES INTO ENGLISH AS THOSE WHO DON'T WAKE UP EARLY.

FOR ENTERTAINMENT SERVICES IN THE NATURE OF AN ONGOING VARIETY TELEVISION PROGRAM (U.S. CLS. 100, 101 AND 107).

DAYNA BROWNE, EXAMINING ATTORNEY

SN 77-540,081. INFO MARKETING INC., MIAMI BEACH, FL. FILED 8-6-2008.

IMAP

THE MARK CONSISTS OF STANDARD CHARACTERS WITHOUT CLAIM TO ANY PARTICULAR FONT, STYLE, SIZE, OR COLOR.

FOR EDUCATION SERVICES, NAMELY, ONE-ON-ONE MENTORING IN THE FIELD OF BUSINESS MARKETING; EDUCATION SERVICES, NAMELY, PROVIDING TELESEMINARS, WORKSHOPS AND CLASSES IN THE FIELD OF BUSINESS MARKETING (U.S. CLS. 100, 101 AND 107).

FIRST USE 4-0-2007; IN COMMERCE 4-0-2007.

ROBERT C. CLARK JR., EXAMINING ATTORNEY

CLASS 41—(Continued).

SN 77-540,199. BELLE, LAVAL WESLEY, BEVERLY HILLS, CA. FILED 8-6-2008.

CLASS 41—(Continued).

SN 77-540,456. MARSHALL COMMUNITY CREDIT UNION, MARSHALL, MI. FILED 8-6-2008.

CU In School

Celebrating Youth

THE MARK CONSISTS OF STANDARD CHARACTERS WITHOUT CLAIM TO ANY PARTICULAR FONT, STYLE, SIZE, OR COLOR.

NO CLAIM IS MADE TO THE EXCLUSIVE RIGHT TO USE "YOUTH", APART FROM THE MARK AS SHOWN.

FOR EDUCATIONAL AND ENTERTAINMENT SERVICES, NAMELY, A CONTINUING PROGRAM ABOUT YOUTH ACCESSIBLE BY RADIO, TELEVISION, SATELLITE, AUDIO, VIDEO AND COMPUTER NETWORKS; ENTERTAINMENT AND EDUCATION SERVICES IN THE NATURE OF A SERIES OF SHORT SHOWS FEATURING YOUTH PERFORMERS DISTRIBUTED TO MOBILE HANDSETS, WHICH MAY INCLUDE VIDEO, TEXT, PHOTOS, ILLUSTRATIONS OR HYPERTEXT; ENTERTAINMENT AND EDUCATIONAL SERVICES, NAMELY, PROVIDING ADVICE AND INFORMATION FOR MUSIC, VIDEO AND FILM CONCEPT AND SCRIPT DEVELOPMENT; ENTERTAINMENT IN THE NATURE OF AIR SHOWS; ENTERTAINMENT IN THE NATURE OF LIVE PERFORMANCES BY YOUTH; ENTERTAINMENT IN THE NATURE OF ON-GOING TELEVISION PROGRAMS IN THE FIELD OF VARIETY SHOWS / TALENT SHOWS; ENTERTAINMENT IN THE NATURE OF VISUAL AND AUDIO PERFORMANCES, NAMELY, MUSICAL BAND, ROCK GROUP, GYMNASTIC, DANCE, AND BALLET PERFORMANCES; ENTERTAINMENT SERVICES IN THE NATURE OF AN ON-GOING REALITY BASED TELEVISION PROGRAM; ENTERTAINMENT SERVICES IN THE NATURE OF LIVE MUSICAL PERFORMANCES; ENTERTAINMENT SERVICES IN THE NATURE OF ON-GOING TELEVISION PROGRAMS IN THE FIELD OF CHILDREN'S ENTERTAINMENT; ENTERTAINMENT SERVICES, NAMELY, LIVE, TELEVISED AND MOVIE APPEARANCES BY A PROFESSIONAL ENTERTAINER; ENTERTAINMENT SERVICES, NAMELY, AN ON-GOING SERIES FEATURING YOUTH PROVIDED THROUGH CABLE TELEVISION; ENTERTAINMENT SERVICES, NAMELY, AN ON-LINE ACTIVITY WHERE YOU CREATE YOUR OWN MUSIC VIDEOS; ENTERTAINMENT SERVICES, NAMELY, PROVIDING A WEB SITE FEATURING MUSICAL PERFORMANCES, MUSICAL VIDEOS, RELATED FILM CLIPS, PHOTOGRAPHS, AND OTHER MULTIMEDIA MATERIALS; ENTERTAINMENT, NAMELY, LIVE PERFORMANCES BY A MUSICAL BAND; ENTERTAINMENT, NAMELY, LIVE PERFORMANCES BY MUSICAL BANDS; ENTERTAINMENT, NAMELY, LIVE PERFORMANCES BY ROCK GROUPS; MOTION PICTURE FILMS AND FILMS FOR TELEVISION FEATURING CHILDREN'S ENTERTAINMENT; PROVIDING ADVICE AND INFORMATION IN THE FIELD OF EDUCATIONAL AND ENTERTAINMENT ACTIVITIES AND EVENTS FOR CHILDREN (U.S. CLS. 100, 101 AND 107).

LINDA E. BLOHM, EXAMINING ATTORNEY

THE MARK CONSISTS OF STANDARD CHARACTERS WITHOUT CLAIM TO ANY PARTICULAR FONT, STYLE, SIZE, OR COLOR.

FOR CONDUCTING PROGRAMS AND PRESENTATIONS IN AREA SCHOOLS IN THE FIELD OF FINANCIAL EDUCATION (U.S. CLS. 100, 101 AND 107).

FIRST USE 9-2-2002; IN COMMERCE 9-2-2002.

KIMBERLY FRYE, EXAMINING ATTORNEY

SN 77-542,870. HALLAMAN MARKET RESEARCH LLC, ALLEN, TX. FILED 8-8-2008.



OPTION CHRONICLE

NO CLAIM IS MADE TO THE EXCLUSIVE RIGHT TO USE "OPTION CHRONICLE", APART FROM THE MARK AS SHOWN.

THE MARK CONSISTS OF INTERLOCKING LETTERS "O" AND "C" ABOVE THE WORDS "OPTION CHRONICLE".

FOR PROVIDING ON-LINE PUBLICATIONS IN THE NATURE OF NEWSLETTERS ON THE SUBJECT OF STOCKS AND OPTIONS IN THE FIELD OF FINANCE (U.S. CLS. 100, 101 AND 107).

FIRST USE 3-1-2008; IN COMMERCE 4-1-2008.

MARK SHINER, EXAMINING ATTORNEY

CLASS 41—(Continued).

SN 77-542,965. ZOEZA GROUP, LLC, PHILADELPHIA, PA.
FILED 8-8-2008.

Zoeza Institute

THE MARK CONSISTS OF STANDARD CHARACTERS WITHOUT CLAIM TO ANY PARTICULAR FONT, STYLE, SIZE, OR COLOR.

NO CLAIM IS MADE TO THE EXCLUSIVE RIGHT TO USE "INSTITUTE", APART FROM THE MARK AS SHOWN. THE ENGLISH TRANSLATION OF THE WORD "ZOEZA" IN THE MARK IS TO LEARN BY DOING.

FOR EDUCATIONAL SERVICES, NAMELY, PROVIDING WORKSHOPS AND TRAINING COURSES DESIGNED TO FACILITATE THE TRANSITION OF AT-RISK YOUTH INTO PRODUCTIVE CAREERS AND INDEPENDENT LIVING; MENTORING SERVICES IN THE FIELD OF HIGH SCHOOL ACADEMIC SUBJECTS, CULTURAL IMMERSION EXPERIENCES AND PROFESSIONAL CAREER PREPARATION, DESIGNED TO FACILITATE THE TRANSITION OF AT-RISK YOUTH INTO PRODUCTIVE CAREERS AND INDEPENDENT LIVING; CONSULTING SERVICES, NAMELY, EVALUATING EDUCATIONAL PROGRAMS AND TRAINING COURSES TARGETING THE TRANSITION OF AT-RISK YOUTH INTO PRODUCTIVE CAREERS AND INDEPENDENT LIVING; PERSONAL AND PROFESSIONAL COACHING DESIGNED TO FACILITATE THE TRANSITION OF AT-RISK YOUTH INTO PRODUCTIVE CAREERS AND INDEPENDENT LIVING; PROVIDING WORKSHOPS AND TRAINING COURSES DESIGNED TO FOSTER PROFESSIONAL DEVELOPMENT; DEVELOPING AND MAINTAINING A RESOURCE LIBRARY AND PROVIDING AN INTERNET WEBSITE PORTAL FEATURING LINKS TO INFORMATION DEALING WITH DATA FOR DEVELOPING EDUCATIONAL PROGRAMS TO EFFECTUATE THE TRANSITION OF AT-RISK YOUTH INTO PRODUCTIVE CAREERS AND INDEPENDENT LIVING; DESIGNING AND DEVELOPING EDUCATIONAL EXPERIENCES FOR TARGETED SUBJECTS TO FACILITATE THE TRANSITION OF AT-RISK YOUTH INTO PRODUCTIVE CAREERS AND INDEPENDENT LIVING (U.S. CLS. 100, 101 AND 107).

FIRST USE 1-1-2005; IN COMMERCE 1-1-2005.

RUSS HERMAN, EXAMINING ATTORNEY

CLASS 41—(Continued).

SN 77-542,970. ZOEZA GROUP, LLC, PHILADELPHIA, PA.
FILED 8-8-2008.

Guiding the Journey to Responsible Living

THE MARK CONSISTS OF STANDARD CHARACTERS WITHOUT CLAIM TO ANY PARTICULAR FONT, STYLE, SIZE, OR COLOR.

FOR EDUCATIONAL SERVICES, NAMELY, PROVIDING WORKSHOPS AND TRAINING COURSES DESIGNED TO FACILITATE THE TRANSITION OF AT-RISK YOUTH INTO PRODUCTIVE CAREERS AND INDEPENDENT LIVING; MENTORING SERVICES IN THE FIELD OF HIGH SCHOOL ACADEMIC SUBJECTS, CULTURAL IMMERSION EXPERIENCES AND PROFESSIONAL CAREER PREPARATION, DESIGNED TO FACILITATE THE TRANSITION OF AT-RISK YOUTH INTO PRODUCTIVE CAREERS AND INDEPENDENT LIVING; EDUCATIONAL RESEARCH, NAMELY, ANALYZING DATA AND DEVELOPING A TRAINING MODEL TO EFFECTUATE THE TRANSITION OF AT-RISK YOUTH INTO PRODUCTIVE CAREERS AND INDEPENDENT LIVING; DESIGNING AND DEVELOPING EDUCATIONAL EXPERIENCES FOR TARGETED SUBJECTS TO FACILITATE THE TRANSITION OF AT-RISK YOUTH INTO PRODUCTIVE CAREERS AND INDEPENDENT LIVING (U.S. CLS. 100, 101 AND 107).

FIRST USE 1-1-2005; IN COMMERCE 1-1-2005.

RUSS HERMAN, EXAMINING ATTORNEY

SN 77-542,980. ZOEZA GROUP, LLC, PHILADELPHIA, PA.
FILED 8-8-2008.

SMART

THE MARK CONSISTS OF STANDARD CHARACTERS WITHOUT CLAIM TO ANY PARTICULAR FONT, STYLE, SIZE, OR COLOR.

FOR MENTORING SERVICES, NAMELY, PROVIDING INTENSIVE, LONG-TERM, HIGH-TOUCH, PARENT-LIKE, COMPREHENSIVE MENTORING TO TARGETED SUBJECTS TO FACILITATE THE TRANSITION OF AT-RISK YOUTH INTO PRODUCTIVE CAREERS AND INDEPENDENT LIVING; EDUCATIONAL RESEARCH, NAMELY, DEVELOPING A TRAINING MODEL TO EFFECTUATE THE TRANSITION OF AT-RISK YOUTH INTO PRODUCTIVE CAREERS AND INDEPENDENT LIVING (U.S. CLS. 100, 101 AND 107).

FIRST USE 1-1-2005; IN COMMERCE 1-1-2005.

RUSS HERMAN, EXAMINING ATTORNEY

CLASS 41—(Continued).

SN 77-544,467. JOHNSTON, BILL, NEW ORLEANS, LA. FILED 8-12-2008.

JOINT'S JUMPIN'

THE MARK CONSISTS OF STANDARD CHARACTERS WITHOUT CLAIM TO ANY PARTICULAR FONT, STYLE, SIZE, OR COLOR.

FOR ENTERTAINMENT SERVICES IN THE NATURE OF LIVE MUSICAL PERFORMANCES (U.S. CLS. 100, 101 AND 107).

FIRST USE 6-23-2008; IN COMMERCE 6-23-2008. EVELYN BRADLEY, EXAMINING ATTORNEY

SN 77-544,961. GLOBAL BRAND CONSULTING LLC, GREENWICH, CT. FILED 8-12-2008.

SWEET TALK

THE MARK CONSISTS OF STANDARD CHARACTERS WITHOUT CLAIM TO ANY PARTICULAR FONT, STYLE, SIZE, OR COLOR.

FOR TELEVISION SHOW PRODUCTION; CABLE TELEVISION SHOW PRODUCTION; MOTION PICTURE FILM PRODUCTION; FILM EDITING; SPECIAL EFFECTS ANIMATION SERVICES FOR FILM AND VIDEO; ENTERTAINMENT IN THE NATURE OF ON-GOING TELEVISION, CABLE TELEVISION AND RADIO PROGRAMS FEATURING MUSIC, COMEDY, DRAMATIC ACTS, SPOKEN WORD, CARTOONS, ANIMATION AND EDUCATIONAL SUBJECT MATTERS FOR CHILDREN AND YOUNG ADULTS; ENTERTAINMENT IN THE NATURE OF ON-GOING TELEVISION AND CABLE TELEVISION PROGRAMS FEATURING MUSIC, DRAMA, SPOKEN WORD, COMEDY, CARTOONS, ANIMATION AND EDUCATIONAL SUBJECT MATTERS FOR CHILDREN AND YOUNG ADULTS; ENTERTAINMENT, NAMELY, A CONTINUING VARIETY SHOW DISTRIBUTED OVER TELEVISION, CABLE TELEVISION, RADIO, SATELLITE, AUDIO AND VIDEO MEDIA; ENTERTAINMENT, NAMELY, A CONTINUING VARIETY, NEWS, COMEDY, DRAMATIC AND MUSICAL SHOW BROADCAST OVER TELEVISION, SATELLITE, AUDIO AND VIDEO MEDIA; DISTRIBUTION OF TELEVISION PROGRAMS AND RADIO PROGRAMS FOR OTHERS; TELEVISION PROGRAM SYNDICATION; PROGRAMMING ON A GLOBAL COMPUTER NETWORK; DISTRIBUTION OF TELEVISION PROGRAMMING TO CABLE TELEVISION SYSTEMS; CABLE TELEVISION PROGRAMMING; TELEVISION AND RADIO PROGRAMMING; TELEVISION SCHEDULING; ENTERTAINMENT SERVICES, NAMELY, PROVIDING AN ON-LINE COMPUTER GAME; PROVIDING A COMPUTER GAME THAT MAY BE ACCESSED NETWORK-WIDE BY NETWORK USERS; MULTIMEDIA ENTERTAINMENT SOFTWARE PRODUCTION SERVICES; PROVIDING INFORMATION ONLINE RELATING TO

CLASS 41—(Continued).

COMPUTER GAMES AND COMPUTER ENHANCEMENTS FOR GAMES; ENTERTAINMENT SERVICES PROVIDED VIA COMPUTER, NAMELY, PROVIDING ONLINE MOVIE AND MUSIC REVIEWS; ENTERTAINMENT, NAMELY, PERSONAL APPEARANCES BY A TELEVISION STAR, MOVIE STAR, COMEDIAN OR RADIO PERSONALITY; ENTERTAINMENT SERVICES, NAMELY, PROVIDING INFORMATION IN THE FIELD OF TELEVISION SERIES, MOVIES, MUSIC, COMMENTARY AND ARTICLES ABOUT MUSIC, TELEVISION SERIES, AND MOVIES ALL ONLINE VIA A GLOBAL COMPUTER NETWORK; VIDEOTAPE PRODUCTION; MOTION PICTURE SONG PRODUCTION; PRODUCTION OF VIDEO DISCS FOR OTHERS. ENTERTAINMENT SERVICES, NAMELY, PRODUCING MUSICAL AUDIO AND VIDEO PROGRAMS; DISTRIBUTION OF TELEVISION AND RADIO PROGRAMS FEATURING MUSICAL PERFORMANCES; DISTRIBUTION OF MUSICAL AUDIO AND VIDEO RECORDINGS FOR BROADCAST; TELEVISION AND RADIO PRODUCTION (U.S. CLS. 100, 101 AND 107).

LINDA E. BLOHM, EXAMINING ATTORNEY

SN 77-545,870. UNDERGROUND STARS ENTERTAINMENT, UNION, NJ. FILED 8-13-2008.

**U.S.E The One Way Bridge
To Success**

THE MARK CONSISTS OF STANDARD CHARACTERS WITHOUT CLAIM TO ANY PARTICULAR FONT, STYLE, SIZE, OR COLOR.

FOR SPECIAL EVENT PLANNING AND BOOKING SERVICES FOR ENTERTAINMENT EVENTS (U.S. CLS. 100, 101 AND 107).

KELLY BOULTON, EXAMINING ATTORNEY

SN 77-546,257. SNAG, INC., TALLEQUAH, OK. FILED 8-13-2008.

G-BALL

THE MARK CONSISTS OF STANDARD CHARACTERS WITHOUT CLAIM TO ANY PARTICULAR FONT, STYLE, SIZE, OR COLOR.

FOR ENTERTAINMENT SERVICES, NAMELY, ORGANIZING, DISSEMINATING INFORMATION AND TRAINING A SMALL CHILDREN'S LEAGUE IN A GAME RESEMBLING GOLF (U.S. CLS. 100, 101 AND 107).

KEVON CHISOLM, EXAMINING ATTORNEY

CLASS 41—(Continued).

SN 77-548,695. CRAFT, BRACKEN CARTER, HOBOKEN, NJ. FILED 8-15-2008.

Outside New York

THE MARK CONSISTS OF STANDARD CHARACTERS WITHOUT CLAIM TO ANY PARTICULAR FONT, STYLE, SIZE, OR COLOR.

NO CLAIM IS MADE TO THE EXCLUSIVE RIGHT TO USE "NEW YORK", APART FROM THE MARK AS SHOWN. FOR PLANNING ARRANGEMENT OF SHOWING MOVIES, SHOWS, PLAYS, OR MUSICAL PERFORMANCES (U.S. CLS. 100, 101 AND 107).

DOMINIC J. FERRAIUOLO, EXAMINING ATTORNEY

SN 77-548,771. BUCKNER, WILLIAM, COUNTRY CLUB HILLS, IL. FILED 8-16-2008.

TRUNK ROCK MUSIC

THE MARK CONSISTS OF STANDARD CHARACTERS WITHOUT CLAIM TO ANY PARTICULAR FONT, STYLE, SIZE, OR COLOR.

NO CLAIM IS MADE TO THE EXCLUSIVE RIGHT TO USE "ROCK MUSIC", APART FROM THE MARK AS SHOWN.

FOR AUDIO RECORDING AND PRODUCTION; MUSIC PRODUCTION SERVICES (U.S. CLS. 100, 101 AND 107).

KATHERINE M. DUBRAY, EXAMINING ATTORNEY

SN 77-549,077. STROH, TANYA, DOWNINGTOWN, PA. FILED 8-18-2008.

TANYA (TS) STROH
TRAINING SOLUTIONS

NO CLAIM IS MADE TO THE EXCLUSIVE RIGHT TO USE "TRAINING", APART FROM THE MARK AS SHOWN.

THE MARK CONSISTS OF AN OVAL CONSISTING OF TWO UNEVEN RINGS WITH THE STYLIZED TEXT "TS". TO THE LEFT OF THE OVAL IS THE STYLIZED TEXT "TANYA" ABOVE THE STYLIZED TEXT "TRAINING" AND TO THE RIGHT OF THE OVAL IS THE STYLIZED TEXT "STROH" ABOVE THE STYLIZED TEXT "SOLUTIONS".

FOR PHYSICAL FITNESS CONSULTATION; PHYSICAL FITNESS TRAINING SERVICES (U.S. CLS. 100, 101 AND 107).

ALLISON SCHRODY, EXAMINING ATTORNEY

CLASS 41—(Continued).

SN 77-550,340. HARMONY HEALTH INTEGRATED LIVING LLC, SHORELINE, WA. FILED 8-19-2008.

MANY MOONS DANCE COMPANY

THE MARK CONSISTS OF STANDARD CHARACTERS WITHOUT CLAIM TO ANY PARTICULAR FONT, STYLE, SIZE, OR COLOR.

NO CLAIM IS MADE TO THE EXCLUSIVE RIGHT TO USE "DANCE COMPANY", APART FROM THE MARK AS SHOWN.

FOR DANCE INSTRUCTION (U.S. CLS. 100, 101 AND 107).

AISHA CLARKE, EXAMINING ATTORNEY

SN 77-550,491. AZALEA BLOSSOM, INC., RENSSELAERVILLE, NY. FILED 8-19-2008.

THE SAFE THROUGH THE ARTS PROGRAM

THE MARK CONSISTS OF STANDARD CHARACTERS WITHOUT CLAIM TO ANY PARTICULAR FONT, STYLE, SIZE, OR COLOR.

NO CLAIM IS MADE TO THE EXCLUSIVE RIGHT TO USE "PROGRAM", APART FROM THE MARK AS SHOWN.

FOR CONDUCTING WORKSHOPS AND SEMINARS IN AWARENESS AND PREVENTION OF DOMESTIC VIOLENCE AND CHILD ABUSE (U.S. CLS. 100, 101 AND 107).

FIRST USE 6-1-2008; IN COMMERCE 6-1-2008.

KYLE PEETE, EXAMINING ATTORNEY

CLASS 41—(Continued).

SN 77-550,995. TRUSTREAMVIDEO, INC., TALLAHASSEE, FL. FILED 8-19-2008.

Conscious Mastery

THE MARK CONSISTS OF STANDARD CHARACTERS WITHOUT CLAIM TO ANY PARTICULAR FONT, STYLE, SIZE, OR COLOR.

FOR LIFE COACHING IN THE FIELD OF PERSONAL AND PROFESSIONAL DEVELOPMENT RELATED TO PROCESSES AND TECHNIQUES FOR CREATING HEALTHY NEW LIFE PATTERNS, SELF-AWARENESS, SELF-EMPOWERMENT AND SPIRITUAL GROWTH; PERSONAL AND PROFESSIONAL LIFE COACHING SESSIONS, NAMELY, INDIVIDUAL SESSIONS, GROUP SESSIONS, TELESESSIONS AND TELESEMINARS IN THE FIELD OF SELF-AWARENESS, SELF-EMPOWERMENT AND SPIRITUAL GROWTH; EDUCATIONAL SERVICES, NAMELY, CLASSES, SEMINARS, WEBINARS, WORKSHOPS, CONFERENCES AND SPEECHES IN THE FIELDS OF SELF-DISCOVERY, PERSONAL VALUES, PERSONAL BEHAVIOR, GOAL SETTING, ABUNDANCE, FULFILLMENT AND OTHER ISSUES RELATED TO PERSONAL AND PROFESSIONAL GROWTH, AND THE DISTRIBUTION OF TRAINING MATERIAL IN CONNECTION THEREWITH (U.S. CLS. 100, 101 AND 107).

FIRST USE 6-1-2005; IN COMMERCE 9-20-2005.
PRISCILLA MILTON, EXAMINING ATTORNEY

SN 77-551,311. THOMPSON, JOYCE, WEST COLUMBIA, TX. FILED 8-20-2008.



NO CLAIM IS MADE TO THE EXCLUSIVE RIGHT TO USE "LCC", APART FROM THE MARK AS SHOWN.

THE MARK CONSISTS OF THE STYLIZED WORDS "NIQUE LIFE SEASONS, LLC". TO THE LEFT OF THE STYLIZED WORD "NIQUE" IS AN IMAGE OF A TREE TRUNK WITH BRANCHES, A CIRCULAR CROSS-SECTION OF A TREE TRUNK, AND A CAPPED ACORN.

FOR LIFE COACHING SERVICES IN THE FIELD OF GRIEF AND LIFE TRANSITIONS (U.S. CLS. 100, 101 AND 107).

FIRST USE 11-0-2007; IN COMMERCE 11-0-2007.
DOMINIC J. FERRAIUOLO, EXAMINING ATTORNEY

CLASS 41—(Continued).

SN 77-552,257. ALEXANDRIA BROWN INTERNATIONAL, INC., MARINA DEL RAY, CA. FILED 8-21-2008.

MILLIONAIRE PROTEGE CLUB

THE MARK CONSISTS OF STANDARD CHARACTERS WITHOUT CLAIM TO ANY PARTICULAR FONT, STYLE, SIZE, OR COLOR.

NO CLAIM IS MADE TO THE EXCLUSIVE RIGHT TO USE "CLUB", APART FROM THE MARK AS SHOWN.

FOR PROFESSIONAL COACHING SERVICES IN THE FIELD OF SMALL BUSINESS MARKETING AND INTERNET MARKETING; EDUCATIONAL SERVICES, NAMELY, CONDUCTING ONE ON ONE WORKSHOPS IN THE FIELD OF SMALL BUSINESS MARKETING AND INTERNET MARKETING AND DISTRIBUTION OF COURSE MATERIAL IN CONNECTION THEREWITH (U.S. CLS. 100, 101 AND 107).

JULIE GUTTADAURO, EXAMINING ATTORNEY

SN 77-552,672. DESH MUSIC LLC, NEW YORK, NY. FILED 8-21-2008.

RED SQUARE

THE MARK CONSISTS OF STANDARD CHARACTERS WITHOUT CLAIM TO ANY PARTICULAR FONT, STYLE, SIZE, OR COLOR.

FOR ENTERTAINMENT IN THE NATURE OF VISUAL AND AUDIO PERFORMANCES, AND MUSICAL, VARIETY, NEWS AND COMEDY SHOWS; ENTERTAINMENT, NAMELY, LIVE PERFORMANCES BY A MUSICAL BAND; PLANNING ARRANGEMENT OF SHOWING MOVIES, SHOWS, PLAYS OR MUSICAL PERFORMANCES; PRODUCTION OF SOUND AND IMAGE RECORDINGS ON SOUND AND IMAGE CARRIERS; PRODUCTION OF SOUND AND MUSIC VIDEO RECORDINGS (U.S. CLS. 100, 101 AND 107).

WENDY GOODMAN, EXAMINING ATTORNEY

SN 77-552,847. STROLLERFIT INC., CINCINNATI, OH. FILED 8-21-2008.

**BUILDING STRONG CONFIDENT
KIDS BY BUILDING STRONG
CONFIDENT MOMS**

THE MARK CONSISTS OF STANDARD CHARACTERS WITHOUT CLAIM TO ANY PARTICULAR FONT, STYLE, SIZE, OR COLOR.

FOR PHYSICAL FITNESS CONSULTATION, PHYSICAL FITNESS INSTRUCTION, PHYSICAL FITNESS TRAINING SERVICES, PHYSICAL FITNESS CONDITIONING CLASSES, AND PROVIDING FITNESS AND EXERCISE FACILITIES (U.S. CLS. 100, 101 AND 107).

FIRST USE 10-31-2007; IN COMMERCE 10-31-2007.
SONYA STEPHENS, EXAMINING ATTORNEY

CLASS 41—(Continued).

SN 77-552,860. MINNESOTA STATE LOTTERY, MINNEAPOLIS, MN. FILED 8-21-2008.



OWNER OF U.S. REG. NOS. 1,657,887, 3,238,306 AND OTHERS.

NO CLAIM IS MADE TO THE EXCLUSIVE RIGHT TO USE "MINNESOTA" "RAFFLE" AND "\$10", APART FROM THE MARK AS SHOWN.

THE MARK CONSISTS OF THE WORDS "MINNESOTA RAFFLE MILLIONAIRE" ON THREE LINES WITH A DESIGN OF THE HEAD OF A LOON AND "\$10" WITHIN A CIRCLE TO THE LEFT OF THE WORD "RAFFLE". THE WORD "RAFFLE", AND THE BIRD DESIGN WITH THE CIRCLE CONTAINING "\$10" IS WITHIN A RECTANGLE, AND THE ENTIRE MARK IS WITHIN A RECTANGULAR-SHAPED BACKGROUND RESEMBLING THE SHAPE OF A RAFFLE TICKET.

FOR LOTTERY SERVICES (U.S. CLS. 100, 101 AND 107).

FIRST USE 11-1-2007; IN COMMERCE 11-1-2007.
CARYN GLASSER, EXAMINING ATTORNEY

SN 77-553,775. CLEARPOOL, INC., CARMEL, NY. FILED 8-22-2008.

CLEARPOOL

THE MARK CONSISTS OF STANDARD CHARACTERS WITHOUT CLAIM TO ANY PARTICULAR FONT, STYLE, SIZE, OR COLOR.

FOR PROVIDING EDUCATIONAL SERVICES, NAMELY, DAY AND RESIDENTIAL PROGRAMS IN THE FIELDS OF ENVIRONMENTAL SCIENCES, PLANT AND GARDEN SCIENCES, WATERSHED STUDIES, ECOLOGY, BIRDS AND MAMMALS, SOCIAL STUDIES, WRITING AND DRAWING AND EARTH SCIENCE; PROVIDING EDUCATIONAL WORKSHOPS, NAMELY, ECOLOGICAL AND ENVIRONMENTAL WORKSHOPS; RECREATIONAL CAMP SERVICES, NAMELY PROVIDING ADVENTURE PROGRAMS IN THE FIELDS OF TEAM INITIATIVES, CHALLENGE COURSES, SENSORY AWARENESS, HIKING, ORIENTEERING, OUTDOOR LIVING SKILLS, BOATING, RAFT BUILDING AND OVERNIGHT CAMPING; PROVIDING RECREATIONAL CAMP FACILITIES (U.S. CLS. 100, 101 AND 107).

FIRST USE 7-1-1901; IN COMMERCE 7-1-1901.
ERIN FALK, EXAMINING ATTORNEY

CLASS 41—(Continued).

SN 77-554,295. TURNING POINTS RESEARCH INSTITUTE, INC., DENVER, CO. FILED 8-23-2008.

TRUE PATH

THE MARK CONSISTS OF THE STYLIZED WORDING "TRUE PATH", WITH THE WORD "TRUE" APPEARING ABOVE THE WORD "PATH", AND WITH A SPIRAL DESIGN APPEARING BETWEEN THE WORDS.

FOR PROVIDING ON-LINE E-ZINES IN THE FIELDS OF PERSONAL TRANSITIONS, CAREER TRANSITIONS, AND SELF-ASSESSMENT; LIFE COACHING SERVICES IN THE FIELDS OF PERSONAL TRANSITIONS, CAREER TRANSITIONS, AND SELF-ASSESSMENT (U.S. CLS. 100, 101 AND 107).

FIRST USE 5-2-2008; IN COMMERCE 5-13-2008.
CYNTHIA TRIPI, EXAMINING ATTORNEY

SN 77-554,437. CARE MEDIA HOLDINGS CORP, TAMPA, FL. FILED 8-25-2008.



NO CLAIM IS MADE TO THE EXCLUSIVE RIGHT TO USE "WOMEN'S HEALTHCARE TELEVISION NETWORK TV", APART FROM THE MARK AS SHOWN.

THE COLOR(S) PURPLE, BLACK, AND WHITE IS/ARE CLAIMED AS A FEATURE OF THE MARK.

THE MARK CONSISTS OF THE WORDING "WOMEN'S HEALTHCARE TELEVISION NETWORK TV" WITH THE FEMALE BIOLOGICAL SYMBOL INSTEAD OF THE APOSTROPHE IN THE WORDING "WOMEN'S" WITHIN A SHADED SQUARE; THE COLOR PURPLE APPEARING IN THE WORDING "WOMEN'S HEALTHCARE" AND "TV" AND IN THE DESIGN OF THE FEMALE BIOLOGICAL SYMBOL, THE COLOR WHITE APPEARING IN THE WORDING "TELEVISION NETWORKS" AND IN THE BACKGROUND SQUARE, AND THE COLOR BLACK APPEARING IN THE SQUARE AROUND THE WORDING "TELEVISION NETWORK", SHADE OF THE BACKGROUND SQUARE, AND OUTLINING THE WORDING "WOMEN'S HEALTHCARE" AND "TV" AND THE DESIGN OF THE WHITE SQUARE AND FEMALE BIOLOGICAL SYMBOL.

FOR PRODUCTION OF DVDS, VIDEOTAPES AND TELEVISION PROGRAMS FEATURING WOMEN'S WELLNESS ISSUES AND EDUCATIONAL PROGRAMS FOR WAITING ROOMS (U.S. CLS. 100, 101 AND 107).

JANET LEE, EXAMINING ATTORNEY

CLASS 41—(Continued).

SN 77-554,483. FREY, GARRISON, MOUNT AIRY, MD. FILED 8-25-2008.

My Ransomed Soul

THE MARK CONSISTS OF STANDARD CHARACTERS WITHOUT CLAIM TO ANY PARTICULAR FONT, STYLE, SIZE, OR COLOR.

FOR ENTERTAINMENT, NAMELY, LIVE MUSIC CONCERTS (U.S. CLS. 100, 101 AND 107).

FIRST USE 5-1-2007; IN COMMERCE 5-1-2008.

MICHAEL WEBSTER, EXAMINING ATTORNEY

CLASS 41—(Continued).

SN 77-556,163. COLLIN C. CANEVA, LINCOLN, NE. FILED 8-26-2008.

KID COMMAND

THE MARK CONSISTS OF STANDARD CHARACTERS WITHOUT CLAIM TO ANY PARTICULAR FONT, STYLE, SIZE, OR COLOR.

NO CLAIM IS MADE TO THE EXCLUSIVE RIGHT TO USE "KID", APART FROM THE MARK AS SHOWN.

FOR PROVIDING A WEB SITE FOR CHILDREN FEATURING INTERACTIVE ONLINE GAMES CONCERNING ENVIRONMENTAL ISSUES AND THE EFFECTS ON THE PLANET AND THAT TEACHES THE IMPORTANCE OF CARING FOR THE PLANET AND THE ENVIRONMENT (U.S. CLS. 100, 101 AND 107).

DORITT L. CARROLL, EXAMINING ATTORNEY

SN 77-555,074. ROCHESTER, CONRAD A, AKA ROCHESTER, CONRAD, NEW YORK, NY. FILED 8-25-2008.



NO CLAIM IS MADE TO THE EXCLUSIVE RIGHT TO USE "HOUSE DANCE INTERNATIONAL NYC", APART FROM THE MARK AS SHOWN.

THE COLOR(S) WHITE, GREY, LAVENDER AND BLACK IS/ARE CLAIMED AS A FEATURE OF THE MARK.

THE MARK CONSISTS OF FIVE 3-DIMENSIONAL CIRCLES INTERSECTING EACH OTHER PLACED DIRECTLY IN THE CENTER OF A RECTANGLE. UNDER THE DESIGN IS THE WORDING "HOUSE DANCE" ABOVE THE WORD "INTERNATIONAL" WITH THE ABBREVIATION "NYC" JUST BELOW. THE COLORS WHITE, GRAY, AND LAVENDER APPEAR IN THE INTERESTING CIRCLES. THE WORDING "HOUSE DANCE INTERNATIONAL NYC" IS IN WHITE. THE COLOR BLACK APPEARS IN THE BACKGROUND RECTANGLE.

FOR DANCE EVENTS; ORGANIZATION OF DANCING EVENTS (U.S. CLS. 100, 101 AND 107).

FIRST USE 7-12-2007; IN COMMERCE 7-12-2007.

LOURDES AYALA, EXAMINING ATTORNEY

SN 77-556,342. O'REILLY MEDIA, INC., SEBASTOPOL, CA. FILED 8-26-2008.

AMERICAN MAKER

THE MARK CONSISTS OF STANDARD CHARACTERS WITHOUT CLAIM TO ANY PARTICULAR FONT, STYLE, SIZE, OR COLOR.

OWNER OF U.S. REG. NO. 3,198,969.

NO CLAIM IS MADE TO THE EXCLUSIVE RIGHT TO USE "AMERICAN", APART FROM THE MARK AS SHOWN.

FOR EDUCATIONAL AND ENTERTAINMENT SERVICES, NAMELY, CONDUCTING EVENTS FEATURING EXHIBITIONS, WORKSHOPS, DISPLAYS, AND INTERACTIVE DEMONSTRATIONS IN THE FIELDS OF TECHNOLOGY, SCIENCE, MUSIC, CULTURE, TRANSPORTATION, INNOVATION, INVENTION, WEATHER, CRAFTS, SEWING, AND SUBJECTS OF GENERAL INTEREST (U.S. CLS. 100, 101 AND 107).

DARRYL SPRULL, EXAMINING ATTORNEY

CLASS 41—(Continued).

SN 77-556,687. HOME SHOWCASE VIDEOS, INC., NEW-BURGH, NY. FILED 8-27-2008.



NO CLAIM IS MADE TO THE EXCLUSIVE RIGHT TO USE "HOME SHOWCASE VIDEOS, INC.", APART FROM THE MARK AS SHOWN.

THE COLOR(S) LIGHT ORANGE AND LIGHT BLUE IS/ARE CLAIMED AS A FEATURE OF THE MARK.

THE MARK CONSISTS OF THIS IS A LIGHT ORANGE HOUSE WITH TWO CIRCLES AROUND IT. THE INNER CIRCLE IS A LIGHT BLUE, AND THE OUTER CIRCLE IS THE SAME LIGHT ORANGE COLOR AS THE HOUSE. THERE ARE THE WORDS "HOME SHOWCASE VIDEOS, INC." TO THE RIGHT OF THE HOUSE AND CIRCLES, AND THE LETTERING IS DONE IN THE SAME LIGHT ORANGE COLOR AS THE HOUSE.

FOR VIDEOTAPE PRODUCTION (U.S. CLS. 100, 101 AND 107).

FIRST USE 2-27-2008; IN COMMERCE 2-27-2008.
COLLEEN DOMBROW, EXAMINING ATTORNEY

SN 77-556,689. ISENER, ILLA MAE, DBA DIVINATION ENTERTAINMENT STUDIOS, ROSEVILLE, MI. FILED 8-27-2008.

Divination Entertainment Studios

THE MARK CONSISTS OF STANDARD CHARACTERS WITHOUT CLAIM TO ANY PARTICULAR FONT, STYLE, SIZE, OR COLOR.

NO CLAIM IS MADE TO THE EXCLUSIVE RIGHT TO USE "ENTERTAINMENT STUDIOS", APART FROM THE MARK AS SHOWN.

FOR ARRANGING AND CONDUCTING NIGHTCLUB ENTERTAINMENT EVENTS; SOUND RECORDING STUDIOS (U.S. CLS. 100, 101 AND 107).

NELSON SNYDER, EXAMINING ATTORNEY

CLASS 41—(Continued).

SN 77-557,233. BRED AHL, CHARLOTTE, SOLVANG, CA. FILED 8-27-2008.

Setting Up Your Horse For Success

THE MARK CONSISTS OF STANDARD CHARACTERS WITHOUT CLAIM TO ANY PARTICULAR FONT, STYLE, SIZE, OR COLOR.

FOR EDUCATIONAL SERVICES, NAMELY, CONDUCTING CLINICS, CLASSES, SEMINARS, CONFERENCES, AND WORKSHOPS IN THE FIELD OF HORSE TRAINING AND HUMAN MOTIVATIONAL TRAINING AND DISTRIBUTION OF TRAINING MATERIAL IN CONNECTION THEREWITH; HORSE TRAINING (U.S. CLS. 100, 101 AND 107).

TARA PATE, EXAMINING ATTORNEY

SN 77-557,757. REINERS, RANDALL, ALLEN, TX. FILED 8-28-2008.



NO CLAIM IS MADE TO THE EXCLUSIVE RIGHT TO USE "EDUCATION", APART FROM THE MARK AS SHOWN.

THE MARK CONSISTS OF THE STYLIZED WORDS "YORKTOWN EDUCATION". TO THE LEFT OF THE STYLIZED WORDS IS AN IMAGE OF A STYLIZED CHILD STICK FIGURE REACHING FOR SEVEN STARS.

FOR EDUCATIONAL SERVICES IN THE NATURE OF DIPLOMA GRANTING SCHOOLS, NAMELY, PROVIDING COURSES OF INSTRUCTION AT THE ELEMENTARY, MIDDLE SCHOOL, HIGH SCHOOL AND COLLEGE LEVEL (U.S. CLS. 100, 101 AND 107).

FIRST USE 12-10-2007; IN COMMERCE 12-10-2007.
KELLEY WELLS, EXAMINING ATTORNEY

CLASS 41—(Continued).

SN 77-558,843. 5 STAR MEDIA ENTERPRISE LLC, TRENTON, NJ. FILED 8-29-2008.

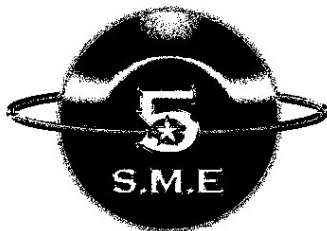

FOR MULTIMEDIA ENTERTAINMENT SERVICES IN THE NATURE OF RECORDING, PRODUCTION AND POST-PRODUCTION SERVICES IN THE FIELDS OF MUSIC, VIDEO, AND FILMS (U.S. CLS. 100, 101 AND 107).

HEATHER BIDDULPH, EXAMINING ATTORNEY

SN 77-559,225. CHRISTENSEN, NATHAN F., BARTLESVILLE, OK. FILED 8-29-2008.

Instant Drama

THE MARK CONSISTS OF STANDARD CHARACTERS WITHOUT CLAIM TO ANY PARTICULAR FONT, STYLE, SIZE, OR COLOR.

NO CLAIM IS MADE TO THE EXCLUSIVE RIGHT TO USE "DRAMA", APART FROM THE MARK AS SHOWN.

FOR PUBLICATION OF TEXTS, BOOKS, JOURNALS (U.S. CLS. 100, 101 AND 107).

DARRYL SPRUILL, EXAMINING ATTORNEY

CLASS 41—(Continued).

SN 77-559,246. MATTICK & ASSOCIATES, LLC, PHOENIX, AZ. FILED 8-29-2008.

Magnify Your Performance

THE MARK CONSISTS OF STANDARD CHARACTERS WITHOUT CLAIM TO ANY PARTICULAR FONT, STYLE, SIZE, OR COLOR.

FOR ARRANGING OF SEMINARS; CONDUCTING WORKSHOPS AND SEMINARS IN PERSONAL AWARENESS; CONDUCTING WORKSHOPS AND SEMINARS IN SELF AWARENESS; CONDUCTING WORKSHOPS AND SEMINARS IN THE IMPROVEMENT OF EMPLOYEE PERFORMANCE, EFFECTIVENESS AND PRODUCTIVITY; CONTINUING EDUCATION SERVICES, NAMELY, PROVIDING LIVE AND ON-LINE CONTINUING PROFESSIONAL EDUCATION SEMINARS IN THE FIELD OF THE IMPROVEMENT OF EMPLOYEE PERFORMANCE, EFFECTIVENESS AND PRODUCTIVITY AND EMPLOYEE DEVELOPMENT; EDUCATION SERVICES, NAMELY, PROVIDING MENTORING, TUTORING, CLASSES, SEMINARS AND WORKSHOPS IN THE FIELD OF THE IMPROVEMENT OF EMPLOYEE PERFORMANCE, EFFECTIVENESS AND PRODUCTIVITY AND EMPLOYEE DEVELOPMENT; EDUCATION SERVICES, NAMELY, PROVIDING CONSULTING AND EDUCATIONAL COURSES IN THE FIELD OF THE IMPROVEMENT OF EMPLOYEE PERFORMANCE, EFFECTIVENESS AND PRODUCTIVITY AND EMPLOYEE DEVELOPMENT; EDUCATIONAL SERVICES, NAMELY, PROVIDING CONSULTING AND EDUCATIONAL COURSES IN THE FIELDS OF THE IMPROVEMENT OF EMPLOYEE PERFORMANCE, EFFECTIVENESS AND PRODUCTIVITY AND EMPLOYEE DEVELOPMENT; EDUCATIONAL SERVICES, NAMELY, CONDUCTING SEMINARS, LECTURES, TELESEMINARS, TELECLASSES, AND WORKSHOPS IN PERSONAL AWARENESS; EDUCATIONAL SERVICES, NAMELY, CONDUCTING CONSULTING AND EDUCATIONAL COURSES IN THE FIELD OF THE IMPROVEMENT OF EMPLOYEE PERFORMANCE, EFFECTIVENESS AND PRODUCTIVITY AND DISTRIBUTION OF TRAINING MATERIAL IN CONNECTION THEREWITH; EDUCATIONAL SERVICES, NAMELY, PROVIDING COURSES, WORKSHOPS AND SEMINARS IN THE FIELDS OF THE IMPROVEMENT OF EMPLOYEE PERFORMANCE, EFFECTIVENESS AND PRODUCTIVITY AND EMPLOYEE DEVELOPMENT; EDUCATIONAL SERVICES, NAMELY, CONDUCTING COURSES, WORKSHOPS AND SEMINARS IN THE FIELD OF THE IMPROVEMENT OF EMPLOYEE PERFORMANCE, EFFECTIVENESS AND PRODUCTIVITY AND THE DISTRIBUTION OF MATERIALS IN CONNECTION THEREWITH; MEETING AND SEMINAR ARRANGING; PROVIDING ON-LINE TRAINING COURSES, WORKSHOPS AND SEMINARS IN THE FIELD OF THE IMPROVEMENT OF EMPLOYEE PERFORMANCE, EFFECTIVENESS AND PRODUCTIVITY; WORKSHOPS AND SEMINARS IN THE FIELD OF THE IMPROVEMENT OF EMPLOYEE PERFORMANCE, EFFECTIVENESS AND PRODUCTIVITY (U.S. CLS. 100, 101 AND 107).

FIRST USE 1-1-2008; IN COMMERCE 1-1-2008.
SUNG IN, EXAMINING ATTORNEY

CLASS 41—(Continued).

SN 77-559,282. MATTICK & ASSOCIATES, LLC, PHOENIX, AZ. FILED 8-29-2008.

Your Business Detective

THE MARK CONSISTS OF STANDARD CHARACTERS WITHOUT CLAIM TO ANY PARTICULAR FONT, STYLE, SIZE, OR COLOR.

FOR ARRANGING OF SEMINARS; CONDUCTING WORKSHOPS AND SEMINARS IN PERSONAL AWARENESS; CONDUCTING WORKSHOPS AND SEMINARS IN SELF AWARENESS; CONDUCTING WORKSHOPS AND SEMINARS IN THE IMPROVEMENT OF EMPLOYEE PERFORMANCE, EFFECTIVENESS AND PRODUCTIVITY; CONTINUING EDUCATION SERVICES, NAMELY, PROVIDING LIVE AND ON-LINE CONTINUING PROFESSIONAL EDUCATION SEMINARS IN THE FIELD OF THE IMPROVEMENT OF EMPLOYEE PERFORMANCE, EFFECTIVENESS AND PRODUCTIVITY AND EMPLOYEE DEVELOPMENT; EDUCATION SERVICES, NAMELY, PROVIDING LIVE AND ON-LINE WORKSHOPS, CONFERENCES AND SEMINARS IN THE FIELD OF THE IMPROVEMENT OF EMPLOYEE PERFORMANCE, EFFECTIVENESS AND PRODUCTIVITY AND EMPLOYEE DEVELOPMENT; EDUCATION SERVICES, NAMELY, PROVIDING MENTORING, TUTORING, CLASSES, SEMINARS AND WORKSHOPS IN THE FIELD OF THE IMPROVEMENT OF EMPLOYEE PERFORMANCE, EFFECTIVENESS AND PRODUCTIVITY AND EMPLOYEE DEVELOPMENT; EDUCATION SERVICES, NAMELY, PROVIDING CONSULTING AND EDUCATIONAL COURSES IN THE FIELD OF THE IMPROVEMENT OF EMPLOYEE PERFORMANCE, EFFECTIVENESS AND PRODUCTIVITY; EDUCATION SERVICES, NAMELY, PROVIDING CONSULTING AND EDUCATIONAL COURSES IN THE FIELDS OF THE IMPROVEMENT OF EMPLOYEE PERFORMANCE, EFFECTIVENESS AND PRODUCTIVITY AND EMPLOYEE DEVELOPMENT; EDUCATIONAL SERVICES, NAMELY, CONDUCTING SEMINARS, LECTURES, TELESEMINARS, TELECLASSES, AND WORKSHOPS IN PERSONAL AWARENESS; EDUCATIONAL SERVICES, NAMELY, CONDUCTING CONSULTING AND EDUCATIONAL COURSES IN THE FIELD OF THE IMPROVEMENT OF EMPLOYEE PERFORMANCE, EFFECTIVENESS AND PRODUCTIVITY AND DISTRIBUTION OF TRAINING MATERIAL IN CONNECTION THEREWITH; EDUCATIONAL SERVICES, NAMELY, CONDUCTING CONSULTING AND EDUCATIONAL COURSES IN THE FIELD OF EMPLOYEE DEVELOPMENT AND DISTRIBUTION OF TRAINING MATERIAL IN CONNECTION THEREWITH; EDUCATIONAL SERVICES, NAMELY, PROVIDING COURSES, WORKSHOPS AND SEMINARS IN THE FIELDS OF THE IMPROVEMENT OF EMPLOYEE PERFORMANCE, EFFECTIVENESS AND PRODUCTIVITY AND EMPLOYEE DEVELOPMENT; EDUCATIONAL SERVICES, NAMELY, CONDUCTING COURSES, WORKSHOPS AND SEMINARS IN THE FIELD OF THE IMPROVEMENT OF EMPLOYEE PERFORMANCE, EFFECTIVENESS AND PRODUCTIVITY AND THE DISTRIBUTION OF MATERIALS IN CONNECTION THEREWITH; MEETING AND SEMINAR ARRANGING; PROVIDING ON-LINE TRAINING COURSES, WORKSHOPS AND SEMINARS IN THE FIELD OF THE IMPROVEMENT OF EMPLOYEE PERFORMANCE, EFFECTIVENESS AND PRODUCTIVITY; WORKSHOPS AND SEMINARS IN THE FIELD OF THE IMPROVEMENT OF EMPLOYEE PERFORMANCE, EFFECTIVENESS AND PRODUCTIVITY (U.S. CLS. 100, 101 AND 107).

FIRST USE 8-29-2008; IN COMMERCE 8-29-2008.
SUNG IN, EXAMINING ATTORNEY

CLASS 41—(Continued).

SN 77-559,757. WELLNESS COALITION, CHARLOTTE, NC. FILED 9-1-2008.

TRAIN FOR LIFE

THE MARK CONSISTS OF STANDARD CHARACTERS WITHOUT CLAIM TO ANY PARTICULAR FONT, STYLE, SIZE, OR COLOR.

FOR ENTERTAINMENT IN THE NATURE OF PROVIDING A TELEVISION PROGRAM IN THE FIELD OF PHYSICAL FITNESS, PHYSICAL THERAPY, HEALTH, NUTRITION, WELLNESS AND SPIRITUALITY AND ON-GOING TELEVISION PROGRAMS IN THE FIELD OF PHYSICAL FITNESS, PHYSICAL THERAPY, HEALTH, NUTRITION, WELLNESS AND SPIRITUALITY (U.S. CLS. 100, 101 AND 107).

FIRST USE 3-31-2008; IN COMMERCE 3-31-2008.
JOHN DWYER, EXAMINING ATTORNEY

SN 77-559,758. ADVANCED COACHING SYSTEMS OF AMERICA LLC, ST. GEORGE, UT. FILED 9-1-2008.

L.I.F.E. Learning Ideas for Empowerment

THE MARK CONSISTS OF STANDARD CHARACTERS WITHOUT CLAIM TO ANY PARTICULAR FONT, STYLE, SIZE, OR COLOR.

NO CLAIM IS MADE TO THE EXCLUSIVE RIGHT TO USE "LEARNING", APART FROM THE MARK AS SHOWN. FOR EDUCATIONAL SERVICES, NAMELY, TRAINING, CONSULTING AND COACHING INDIVIDUALS IN THE FIELDS OF PERSONAL SUCCESS AND WEALTH ENHANCEMENT, AND DISTRIBUTION OF RELATED EDUCATIONAL MATERIALS (U.S. CLS. 100, 101 AND 107).

FIRST USE 8-1-2008; IN COMMERCE 8-1-2008.
DAVID HOFFMAN, EXAMINING ATTORNEY

SN 77-560,000. BRINLEY, SEAN HAMILTON, DURANGO, CO. FILED 9-2-2008.



THE MARK CONSISTS OF STYLIZED LETTERING OF THE MARK "THE FORMLESS".

FOR ENTERTAINMENT, NAMELY, LIVE PERFORMANCES BY A MUSICAL BAND (U.S. CLS. 100, 101 AND 107).

JAMES MACFARLANE, EXAMINING ATTORNEY

CLASS 41—(Continued).

SN 77-560,221. JONES, DENNIS, CHESAPEAKE, VA. FILED 9-2-2008.

Players Life Council

THE MARK CONSISTS OF STANDARD CHARACTERS WITHOUT CLAIM TO ANY PARTICULAR FONT, STYLE, SIZE, OR COLOR.

FOR COUNSELING SERVICES IN THE FIELD OF PHYSICAL FITNESS (U.S. CLS. 100, 101 AND 107).

FRED CARL, EXAMINING ATTORNEY

SN 77-560,420. WINNINGER, THOMAS J., EDINA, MN. FILED 9-2-2008.

THOMAS J. WINNINGER

ABSOLUTE TRUTHS

OF GROWING YOUR BUSINESS

THE COLOR(S) BLACK, RED AND WHITE IS/ARE CLAIMED AS A FEATURE OF THE MARK.

THE MARK CONSISTS OF THE WORD "ABSOLUTE" IN ALL CAPS, ABADI MT BOLD, WHITE TYPE REVERSED OUT OF BLACK RECTANGLE, FOLLOWED BY THE WORD "TRUTHS" IN ALL CAPS, ABADI MT BOLD, ALL CAPS WHITE TYPE REVERSED OUT OF A RED RECTANGLE ALL IN ONE LINE.

FOR EDUCATIONAL AND ENTERTAINMENT SERVICES, NAMELY, PROVIDING MOTIVATIONAL SPEAKING SERVICES IN THE FIELD OF BUSINESS AND CORPORATE GROWTH AND PERFORMANCE INCLUDING SALES, MARKETING, HIRING, BRANDING AND LEADERSHIP SKILLS (U.S. CLS. 100, 101 AND 107).

FIRST USE 8-21-2008; IN COMMERCE 8-21-2008.
TRACY FLETCHER, EXAMINING ATTORNEY

CLASS 41—(Continued).

SN 77-560,479. THE BEST OF FOOD INC., GLENSIDE, PA. FILED 9-2-2008.



THE COLOR(S) PURPLE, ORANGE, AND GREEN IS/ARE CLAIMED AS A FEATURE OF THE MARK.

THE MARK CONSISTS OF SMALL BLOCK LETTERS IN ORANGE FOR "THE BEST OF FOOD". THE WORD "FOOD" IS GREEN AND THE "F" IS REPRESENTED BY A MEAT CLEAVOR WITH A PIECE OF CHEESE, THE "O" OS A PLATE, FOLLOWED BY AN "O" THAT IS A BOWL WITH STEAM RISING FROM IT. THE "D" IS A FRYING PAN. THE BACKGROUND IS PURPLE.

FOR ENTERTAINMENT AND EDUCATIONAL SERVICES, NAMELY, PROVIDING A WEBSITE THAT DISPLAYS VARIOUS REQUESTS, REVIEWS, RECOMMENDATIONS, RANKINGS, TRACKINGS, VOTES, AND INFORMATION RELATING TO UNCREATED, UNRELEASED, NEW, SPECIAL, POPULAR, AND RARE PRODUCTS, SERVICES, AND EVENTS IN THE FIELDS OF POP CULTURE, ENTERTAINMENT, EDUCATION, LIFESTYLE, AND SPORTS, ALL EXCLUSIVELY FOR NON-BUSINESS AND NON-COMMERCIAL TRANSACTIONS AND PURPOSES (U.S. CLS. 100, 101 AND 107).

ROBIN CHOSID, EXAMINING ATTORNEY

SN 77-560,892. PTFB, LLC, DBA INFANTS 'N MORE!!, ROSEDALE, MD. FILED 9-2-2008.

INFANTS 'n MORE!!

NO CLAIM IS MADE TO THE EXCLUSIVE RIGHT TO USE "INFANTS", APART FROM THE MARK AS SHOWN.

THE COLOR(S) RED, BLUE, GREEN, ORANGE, YELLOW IS/ARE CLAIMED AS A FEATURE OF THE MARK.

THE MARK CONSISTS OF THE WORDING "INFANTS 'N MORE!!" IN BLOCK LETTERS, WITH A GREEN ZIG-ZAG LINE BELOW THE GREEN "'N", THE COLOR RED APPEARS IN THE LETTERS "I" AND "T" IN "INFANTS" AND THE "R" IN "MORE", THE COLOR BLUE APPEARS IN BOTH "N'S" AND THE "S" IN "INFANTS" AND THE "O" AND "E" IN "MORE", THE COLOR "GREEN APPEARS IN THE "F" IN "INFANTS", THE COLOR ORANGE APPEARS IN THE "A" IN "INFANTS" AND THE "M" IN "MORE", AND THE COLOR YELLOW APPEARS IN THE TWO EXCLAMATION MARKS.

FOR EDUCATION SERVICES IN THE NATURE OF EARLY CHILDHOOD INSTRUCTION (U.S. CLS. 100, 101 AND 107).

KATHLEEN LORENZO, EXAMINING ATTORNEY

CLASS 41—(Continued).

SN 77-561,188. HEALTHY HABITS WELLNESS CENTER, LLC, MESA, AZ. FILED 9-3-2008.



NO CLAIM IS MADE TO THE EXCLUSIVE RIGHT TO USE "NUTRITION", APART FROM THE MARK AS SHOWN.

THE COLOR(S) RED, GREEN, BROWN AND BLACK IS/ARE CLAIMED AS A FEATURE OF THE MARK.

THE MARK CONSISTS OF THE WORD "YOUNIQUE", WHERE ALL OF THE LETTERS IN "YOUNIQUE" APPEAR IN BLACK, EXCEPT THE LETTER "O", WHICH IS FORMED BY A RED APPLE FEATURING A BROWN STEM AND GREEN LEAF. THE WORD "YOUNIQUE" IS UNDERLINED BY A BROWN BRANCH WITH GREEN LEAVES EXTENDING FROM EITHER SIDE OF THE BRANCH. THE WORD "NUTRITION" APPEARS IN GREEN WITH A BLACK OUTLINE BELOW THE BRANCH.

FOR PROVIDING ASSISTANCE, PERSONAL TRAINING AND PHYSICAL FITNESS CONSULTATION TO INDIVIDUALS TO HELP THEM MAKE PHYSICAL FITNESS, STRENGTH, CONDITIONING, AND EXERCISE IMPROVEMENT IN THEIR DAILY LIVING (U.S. CLS. 100, 101 AND 107).

LINDA LAVACHE, EXAMINING ATTORNEY

SN 77-561,884. INTHECIRKEL.COM, LLC, NORTHFIELD, IL. FILED 9-3-2008.

SkatingCircle

THE MARK CONSISTS OF STANDARD CHARACTERS WITHOUT CLAIM TO ANY PARTICULAR FONT, STYLE, SIZE, OR COLOR.

FOR ENTERTAINMENT SERVICES, NAMELY, PROVIDING A WEB SITE FEATURING INFORMATION, VIDEOS AND COMPETITIONS REGARDING FIGURE SKATING (U.S. CLS. 100, 101 AND 107).

FIRST USE 8-1-2008; IN COMMERCE 8-1-2008.
FRANK LATTUCA, EXAMINING ATTORNEY

CLASS 41—(Continued).

SN 77-561,960. DIRK ELLER, SAN ANTONIO, TX. FILED 9-4-2008.

BETTER THAN LIVE

THE MARK CONSISTS OF STANDARD CHARACTERS WITHOUT CLAIM TO ANY PARTICULAR FONT, STYLE, SIZE, OR COLOR.

FOR PROVIDING AUDIO OR VISUAL STUDIOS; RENTAL SERVICES FOR AUDIO AND VIDEO EQUIPMENT; AUDIO AND VIDEO RECORDING SERVICES; DIGITAL VIDEO, AUDIO, AND MULTIMEDIA PUBLISHING SERVICES; FILM AND VIDEO PRODUCTION; MUSIC VIDEO PRODUCTION; MUSIC PRODUCTION SERVICES; PRODUCTION AND DISTRIBUTION OF TELEVISION SHOWS AND MOVIES; PRODUCTION AND DISTRIBUTION OF RADIO PROGRAMS; PRODUCTION AND DISTRIBUTION OF SOUND RECORDINGS (U.S. CLS. 100, 101 AND 107).

LOURDES AYALA, EXAMINING ATTORNEY

SN 77-561,968. DAVID M.T. CHANDLER, WASHINGTON, DC. FILED 9-4-2008.

TRIPLE CROWN

THE MARK CONSISTS OF STANDARD CHARACTERS WITHOUT CLAIM TO ANY PARTICULAR FONT, STYLE, SIZE, OR COLOR.

FOR ARRANGING AND CONDUCTING NIGHTCLUB ENTERTAINMENT EVENTS; ARRANGING FOR TICKET RESERVATIONS FOR SHOWS AND OTHER ENTERTAINMENT EVENTS; BOOKING OF ENTERTAINMENT HALLS (U.S. CLS. 100, 101 AND 107).

MARK PILARO, EXAMINING ATTORNEY

SN 77-561,999. WRIGHT STATE UNIVERSITY, DAYTON, OH. FILED 9-4-2008.



Boonshoft
School of Medicine
WRIGHT STATE UNIVERSITY

OWNER OF U.S. REG. NOS. 1,423,344, 3,270,001 AND OTHERS.

NO CLAIM IS MADE TO THE EXCLUSIVE RIGHT TO USE "SCHOOL OF MEDICINE" AND "STATE UNIVERSITY", APART FROM THE MARK AS SHOWN.

THE MARK CONSISTS OF A STYLIZED CADUCEUS DESIGN.

FOR MEDICAL EDUCATION SERVICES, NAMELY, PROVIDING COURSES OF INSTRUCTION AT THE POST-GRADUATE LEVEL (U.S. CLS. 100, 101 AND 107).

LINDA M. KING, EXAMINING ATTORNEY

CLASS 41—(Continued).

SN 77-562,200. MUMO, WILMINGTON, NC. FILED 9-4-2008.

CLASS 41—(Continued).

SN 77-562,507. BOY GENIUS 68 PRODUCTIONS LLC, FAIR-LAWN, NJ. FILED 9-4-2008.

M u M o

Dick Colorado

THE MARK CONSISTS OF THE STYLIZED TEXT "MUMO".

FOR EDUCATION SERVICES, NAMELY, PROVIDING CLASSES, SEMINARS, WORKSHOPS IN THE FIELD OF EARLY CHILDHOOD MUSIC (U.S. CLS. 100, 101 AND 107).

APRIL ROACH, EXAMINING ATTORNEY

THE MARK CONSISTS OF STANDARD CHARACTERS WITHOUT CLAIM TO ANY PARTICULAR FONT, STYLE, SIZE, OR COLOR.

THE NAME(S), PORTRAIT(S), AND/OR SIGNATURE(S) SHOWN IN THE MARK DOES NOT IDENTIFY A PARTICULAR LIVING INDIVIDUAL.

FOR ENTERTAINMENT SERVICES IN THE NATURE OF LIVE MUSICAL PERFORMANCES (U.S. CLS. 100, 101 AND 107).

GEOFFREY FOSDICK, EXAMINING ATTORNEY

SN 77-562,341. THE KIDS OF WIDNEY HIGH, CULVER CITY, CA. FILED 9-4-2008.

SN 77-562,653. AMELIA MAE PARADISE, OAKLAND, CA. FILED 9-4-2008.

 the kids of widney high

Diamond Daggers

NO CLAIM IS MADE TO THE EXCLUSIVE RIGHT TO USE "KIDS", APART FROM THE MARK AS SHOWN.

THE MARK CONSISTS OF A COMBINATION OF THE HANDICAPPED LOGO (A PERSON IN A WHEELCHAIR) WITH A MUSICAL NOTE (16TH NOTE), WITH THE BACK OF THE WHEELCHAIR BEING THE STEM OF THE NOTE, AND FIVE LINES TO THE RIGHT OF THE WHEELCHAIR, REPRESENTING SPEED AND MOTION, ALL SHOWN TO THE LEFT OF THE WORDS "THE KIDS OF WIDNEY HIGH", SHOWN IN A STYLIZED FONT.

FOR ENTERTAINMENT IN THE NATURE OF LIVE PERFORMANCES BY MUSICAL BAND; ENTERTAINMENT SERVICES, NAMELY, LIVE, TELEVISED AND MOVIE APPEARANCES BY A PROFESSIONAL ENTERTAINER; ENTERTAINMENT SERVICES, NAMELY, PROVIDING A WEB SITE FEATURING MUSICAL PERFORMANCES, MUSICAL VIDEOS, RELATED FILM CLIPS, PHOTOGRAPHS, AND OTHER MULTIMEDIA MATERIALS; ENTERTAINMENT, NAMELY, LIVE MUSIC CONCERTS (U.S. CLS. 100, 101 AND 107).

FIRST USE 1-1-1995; IN COMMERCE 1-1-1999.
ESTHER BELENKER, EXAMINING ATTORNEY

THE MARK CONSISTS OF STANDARD CHARACTERS WITHOUT CLAIM TO ANY PARTICULAR FONT, STYLE, SIZE, OR COLOR.

FOR CONDUCTING ENTERTAINMENT EXHIBITIONS IN THE NATURE OF BURLESQUE SHOWS; ENTERTAINMENT IN THE NATURE OF DANCE PERFORMANCES; ENTERTAINMENT IN THE NATURE OF LIVE PERFORMANCES BY DANCERS AND MUSICIANS; ENTERTAINMENT IN THE NATURE OF VISUAL AND AUDIO PERFORMANCES, AND MUSICAL, VARIETY, NEWS AND COMEDY SHOWS; ENTERTAINMENT IN THE NATURE OF VISUAL AND AUDIO PERFORMANCES, NAMELY, MUSICAL BAND, ROCK GROUP, GYMNASTIC, DANCE, AND BALLET PERFORMANCES; ENTERTAINMENT IN THE NATURE OF DANCE AND LIVE MUSICAL PERFORMANCES; ENTERTAINMENT SERVICES, NAMELY, PROVIDING LIVE ENTERTAINMENT BY DANCERS VIA THE INTERNET (U.S. CLS. 100, 101 AND 107).

FIRST USE 11-1-2003; IN COMMERCE 11-1-2003.
MARK PILARO, EXAMINING ATTORNEY

CLASS 41—(Continued).

SN 77-562,681. GRAND RAPIDS PUBLIC SCHOOLS, GRAND RAPIDS, MI. FILED 9-4-2008.



NO CLAIM IS MADE TO THE EXCLUSIVE RIGHT TO USE "GRAND RAPIDS PUBLIC SCHOOLS", APART FROM THE MARK AS SHOWN.

THE COLOR(S) ORANGE, BLUE AND WHITE IS/ARE CLAIMED AS A FEATURE OF THE MARK.

THE MARK CONSIST OF THE WORDING "GRPS" IN BLUE, THE WORDING "MY CHOICE" IN BLUE WITH AN ORANGE LETTER "O" AND A FLAME IN DARKER AND LIGHTER SHADES OF ORANGE WITH A WHITE OUTLINE, AND THE WORDING "GRAND RAPIDS PUBLIC SCHOOLS" IN ORANGE.

FOR EDUCATIONAL SERVICES, NAMELY, PROVIDING COURSES OF INSTRUCTION AT THE PRIMARY AND SECONDARY LEVEL AND DISTRIBUTION OF COURSE MATERIAL IN CONNECTION THEREWITH (U.S. CLS. 100, 101 AND 107).

ANGELA GAW, EXAMINING ATTORNEY

SN 77-562,866. SIP ACADEMY USA, LLC, SALT LAKE CITY, UT. FILED 9-4-2008.

SIP ACADEMY

THE MARK CONSISTS OF STANDARD CHARACTERS WITHOUT CLAIM TO ANY PARTICULAR FONT, STYLE, SIZE, OR COLOR.

NO CLAIM IS MADE TO THE EXCLUSIVE RIGHT TO USE "ACADEMY", APART FROM THE MARK AS SHOWN.

FOR EDUCATIONAL SERVICES, NAMELY, PROVIDING COURSES OF INSTRUCTION AT THE PRIMARY LEVEL IN THE SUBJECTS OF MATH, ART, LINGUISTICS AND PHONETICS, ABACUS SKILLS AND THE FIVE SENSES (U.S. CLS. 100, 101 AND 107).

DAVID TOOLEY, EXAMINING ATTORNEY

CLASS 41—(Continued).

SN 77-562,904. PROJECT SIMPLIFY, NEVADA CITY, CA. FILED 9-4-2008.

Natural Professional

THE MARK CONSISTS OF STANDARD CHARACTERS WITHOUT CLAIM TO ANY PARTICULAR FONT, STYLE, SIZE, OR COLOR.

FOR EDUCATIONAL SERVICES, NAMELY, CONDUCTING SEMINARS AND WORKSHOPS IN THE FIELD OF IMPROVING INDIVIDUAL PERFORMANCE, NAMELY, TO HELP OTHERS ORGANIZE THEIR WORK SPACE, SIMPLIFY THEIR WORK HABITS, AND BALANCE THEIR PRIORITIES AND DISTRIBUTION OF COURSE MATERIAL IN CONNECTION THEREWITH (U.S. CLS. 100, 101 AND 107).

FIRST USE 7-16-2008; IN COMMERCE 7-19-2008.

DAVON HATCHETT, EXAMINING ATTORNEY

SN 77-563,037. BAUMAN INK, LTD, AKA ALISA BOWMAN, LTD, EMMAUS, PA. FILED 9-5-2008.

Project Happily Ever After

THE MARK CONSISTS OF STANDARD CHARACTERS WITHOUT CLAIM TO ANY PARTICULAR FONT, STYLE, SIZE, OR COLOR.

FOR ON-LINE JOURNALS, NAMELY, BLOGS FEATURING DAILY UPDATES IN THE FIELD OF PERSONAL RELATIONSHIPS AND/OR MARITAL ADVICE (U.S. CLS. 100, 101 AND 107).

FIRST USE 7-25-2008; IN COMMERCE 7-25-2008.

JOHN DWYER, EXAMINING ATTORNEY

SN 77-563,085. CITY OF AKRON, AKRON, OH. FILED 9-5-2008.

ROCK THE LOCK

THE MARK CONSISTS OF STANDARD CHARACTERS WITHOUT CLAIM TO ANY PARTICULAR FONT, STYLE, SIZE, OR COLOR.

FOR ENTERTAINMENT SERVICES IN THE NATURE OF MUSIC CONCERT SERIES FEATURING LIVE PERFORMANCES (U.S. CLS. 100, 101 AND 107).

FIRST USE 5-1-2005; IN COMMERCE 5-1-2005.

CAROL SPILS, EXAMINING ATTORNEY

CLASS 41—(Continued).

SN 77-563,204. CONSULTING SAFETY MANAGERS, INC., WAXHAW, NC. FILED 9-5-2008.

Safe • Task

NO CLAIM IS MADE TO THE EXCLUSIVE RIGHT TO USE "SAFE", APART FROM THE MARK AS SHOWN.
 THE MARK CONSISTS OF THE STYLIZED TEXT "SAFE TASK" WITH A CIRCLE IN BETWEEN.
 FOR EDUCATION SERVICES, NAMELY, PROVIDING SEMINARS, WORKSHOPS, AND COURSES IN THE FIELD OF OCCUPATIONAL SAFETY MANAGEMENT (U.S. CLS. 100, 101 AND 107).
 FIRST USE 10-1-2006; IN COMMERCE 1-2-2007.
 ROBIN CHOSID, EXAMINING ATTORNEY

SN 77-563,369. CSEHY SUMMER SCHOOL OF MUSIC, INC., LANGHORNE, PA. FILED 9-5-2008.

CSEHY

THE MARK CONSISTS OF STANDARD CHARACTERS WITHOUT CLAIM TO ANY PARTICULAR FONT, STYLE, SIZE, OR COLOR.
 FOR EDUCATION SERVICES, NAMELY, PROVIDING CLASSES, LESSONS AND INSTRUCTION IN THE FIELD OF MUSIC (U.S. CLS. 100, 101 AND 107).
 FIRST USE 9-1-1969; IN COMMERCE 9-1-1969.
 JAMES GRIFFIN, EXAMINING ATTORNEY

SN 77-563,593. GUIDEONE MUTUAL INSURANCE COMPANY, WEST DES MOINES, IA. FILED 9-5-2008.

EFFECT

THE MARK CONSISTS OF STANDARD CHARACTERS WITHOUT CLAIM TO ANY PARTICULAR FONT, STYLE, SIZE, OR COLOR.
 FOR EDUCATIONAL SERVICES, NAMELY, PROVIDING PROGRAMS TO IDENTIFY CHURCH LIABILITY RISKS, ALL FOR INSURANCE/RISK MANAGEMENT PURPOSES (U.S. CLS. 100, 101 AND 107).
 FIRST USE 4-24-2006; IN COMMERCE 4-24-2006.
 KEVON CHISOLM, EXAMINING ATTORNEY

CLASS 41—(Continued).

SN 77-563,635. RIGHTCHANGE.COM, INC., CONCORD, NC. FILED 9-5-2008.

RIGHT CHANGE

THE MARK CONSISTS OF STANDARD CHARACTERS WITHOUT CLAIM TO ANY PARTICULAR FONT, STYLE, SIZE, OR COLOR.
 FOR ORGANIZING, PLANNING, ARRANGING AND CONDUCTING EVENTS RELATING TO POLITICS, POLITICAL CAMPAIGNS, MEDIA RELATIONS, PUBLIC POLICY, LEADERSHIP, NETWORKING, AND THE LEGISLATIVE PROCESS; AND EDUCATIONAL SERVICES, NAMELY, CLASSES, COURSES, SEMINARS, CLINICS, WORKSHOPS, LECTURES, TUTORING, AND MENTORING IN THE FIELDS OF POLITICS, POLITICAL CAMPAIGNS, MEDIA RELATIONS, PUBLIC POLICY, LEADERSHIP, NETWORKING, AND THE LEGISLATIVE PROCESS (U.S. CLS. 100, 101 AND 107).
 TEJBIR SINGH, EXAMINING ATTORNEY

SN 77-564,193. THE TRUSTEES OF WESTMINSTER SCHOOL, INCORPORATED, SIMSBURY, CT. FILED 9-8-2008.

GRIT AND GRACE

THE MARK CONSISTS OF STANDARD CHARACTERS WITHOUT CLAIM TO ANY PARTICULAR FONT, STYLE, SIZE, OR COLOR.
 FOR ARRANGING AND CONDUCTING ATHLETIC COMPETITIONS; EDUCATIONAL SERVICES, NAMELY, CONDUCTING CLASSES IN THE FIELD OF SECONDARY EDUCATION AND DISTRIBUTION OF COURSE MATERIAL IN CONNECTION THEREWITH (U.S. CLS. 100, 101 AND 107).
 JACQUELINE A. LAVINE, EXAMINING ATTORNEY

SN 77-564,212. NATIONAL ACADEMY OF RECORDING ARTS & SCIENCES, INC., SANTA MONICA, CA. FILED 9-8-2008.

GRAMMY U

THE MARK CONSISTS OF STANDARD CHARACTERS WITHOUT CLAIM TO ANY PARTICULAR FONT, STYLE, SIZE, OR COLOR.
 OWNER OF U.S. REG. NOS. 887,642, 3,202,214 AND OTHERS.
 NO CLAIM IS MADE TO THE EXCLUSIVE RIGHT TO USE "U", APART FROM THE MARK AS SHOWN.
 FOR EDUCATION SERVICES, NAMELY, PROVIDING CLASSES, SEMINARS AND WORKSHOPS IN THE FIELD OF MUSIC (U.S. CLS. 100, 101 AND 107).
 COLLEEN DOMBROW, EXAMINING ATTORNEY

CLASS 41—(Continued).

SN 77-564,330. SIP ACADEMY USA, LLC, SALT LAKE CITY, UT. FILED 9-8-2008.

SIP

THE MARK CONSISTS OF STANDARD CHARACTERS WITHOUT CLAIM TO ANY PARTICULAR FONT, STYLE, SIZE, OR COLOR.

FOR EDUCATIONAL SERVICES, NAMELY, PROVIDING COURSES OF INSTRUCTION AT THE PRIMARY LEVEL IN THE SUBJECTS OF MATH, ART, LINGUISTICS AND PHONETICS, ABACUS SKILLS AND THE FIVE SENSES (U.S. CLS. 100, 101 AND 107).

DAVID TOOLEY, EXAMINING ATTORNEY

SN 77-564,395. HOME ENCOURAGEMENT, KATY, TX. FILED 9-8-2008.



home
encouragement

THE MARK CONSISTS OF THE WORDS "HOME ENCOURAGEMENT" WITH A SIMPLE IMAGE OF A ROOFTOP OVER THE WORD "HOME" AND A HORIZONTAL BAR UNDER "ENCOURAGEMENT".

FOR EDUCATION SERVICES, NAMELY, PROVIDING CLASSES, SEMINARS, AND WORKSHOPS IN THE FIELD OF MARRIAGE AND PARENTING (U.S. CLS. 100, 101 AND 107).

FIRST USE 3-1-2007; IN COMMERCE 5-1-2007.
APRIL HESIK, EXAMINING ATTORNEY

CLASS 41—(Continued).

SN 77-564,409. DIBELLO, RICK, DBA TORN CURTAIN, ERIE, PA. FILED 9-8-2008.

Torn Curtain

THE MARK CONSISTS OF STANDARD CHARACTERS WITHOUT CLAIM TO ANY PARTICULAR FONT, STYLE, SIZE, OR COLOR.

FOR ENTERTAINMENT IN THE NATURE OF VISUAL AND AUDIO PERFORMANCES, NAMELY, MUSICAL BAND, ROCK GROUP, GYMNASTIC, DANCE, AND BALLET PERFORMANCES; ENTERTAINMENT SERVICES IN THE NATURE OF LIVE MUSICAL PERFORMANCES; ENTERTAINMENT, NAMELY, LIVE MUSIC CONCERTS; ENTERTAINMENT, NAMELY, LIVE PERFORMANCES BY A MUSICAL BAND; ENTERTAINMENT, NAMELY, LIVE PERFORMANCES BY MUSICAL BANDS; PRODUCTION OF SOUND AND MUSIC VIDEO RECORDINGS (U.S. CLS. 100, 101 AND 107).

FIRST USE 11-29-1998; IN COMMERCE 12-11-1998.
CHERYL CLAYTON, EXAMINING ATTORNEY

SN 77-564,445. BORUTA III, VICTOR, EDISON, NJ. FILED 9-8-2008.

IRON EDITOR

THE MARK CONSISTS OF STANDARD CHARACTERS WITHOUT CLAIM TO ANY PARTICULAR FONT, STYLE, SIZE, OR COLOR.

FOR COMPETITION IN WHICH TWO OR MORE INDIVIDUALS COMPETE AGAINST EACH OTHER IN A CONTROLLED ENVIRONMENT FOR A SPECIFIC AMOUNT OF TIME, TO CREATE A MUSIC VIDEO USING PROVIDED VIDEO SOURCES (U.S. CLS. 100, 101 AND 107).

FIRST USE 5-13-2005; IN COMMERCE 5-13-2005.
ALICE SUE CARRUTHERS, EXAMINING ATTORNEY

SN 77-564,587. VOLUNTEER USA FOUNDATION, INC., TALLAHASSEE, FL. FILED 9-8-2008.

LOVE. READ. LEARN!

THE MARK CONSISTS OF STANDARD CHARACTERS WITHOUT CLAIM TO ANY PARTICULAR FONT, STYLE, SIZE, OR COLOR.

FOR EDUCATION SERVICES, NAMELY, PROVIDING WORKSHOPS RELATING TO SKILLS AND TECHNIQUES FOR TEACHING CHILDREN TO READ (U.S. CLS. 100, 101 AND 107).

FIRST USE 7-25-2008; IN COMMERCE 7-25-2008.
KATHLEEN LORENZO, EXAMINING ATTORNEY

CLASS 41—(Continued).

SN 77-564,725. CREATIVE ENERGY OPTIONS, INC., WHITE HAVEN, PA. FILED 9-8-2008.

PatternAware

THE MARK CONSISTS OF STANDARD CHARACTERS WITHOUT CLAIM TO ANY PARTICULAR FONT, STYLE, SIZE, OR COLOR.

FOR EDUCATIONAL SERVICES, NAMELY, CONDUCTING SEMINARS AND WORKSHOPS IN THE FIELD OF LEADERSHIP DEVELOPMENT AND DISTRIBUTION OF TRAINING MATERIAL IN CONNECTION THEREWITH (U.S. CLS. 100, 101 AND 107).

FIRST USE 9-8-2008; IN COMMERCE 9-8-2008.
WILLIAM P. SHANAHAN, EXAMINING ATTORNEY

CLASS 41—(Continued).

SN 77-564,983. TELEVISA, S.A. DE C.V., COLONIA ZEDEC SANTA FE, MEXICO, FILED 9-8-2008.

FUEGO EN LA SANGRE

THE MARK CONSISTS OF STANDARD CHARACTERS WITHOUT CLAIM TO ANY PARTICULAR FONT, STYLE, SIZE, OR COLOR.

THE FOREIGN WORDING IN THE MARK TRANSLATES INTO ENGLISH AS FIRE IN THE BLOOD.

FOR ENTERTAINMENT SERVICES IN THE NATURE OF AN ONGOING DRAMATIC TELEVISION PROGRAM (U.S. CLS. 100, 101 AND 107).

FIRST USE 1-21-2008; IN COMMERCE 4-28-2008.
MICHAEL WIENER, EXAMINING ATTORNEY

SN 77-564,756. FESTIVAL FUN PARKS, LLC, NEWPORT BEACH, CA. FILED 9-8-2008.

SCREAMIN DEMON

THE MARK CONSISTS OF STANDARD CHARACTERS WITHOUT CLAIM TO ANY PARTICULAR FONT, STYLE, SIZE, OR COLOR.

FOR ENTERTAINMENT SERVICES IN THE NATURE OF AMUSEMENT PARK RIDES (U.S. CLS. 100, 101 AND 107).

TOBY BULLOFF, EXAMINING ATTORNEY

SN 77-565,018. THE KINETIX LLC, LITTLETON, CO. FILED 9-8-2008.

KINETIX

THE MARK CONSISTS OF STANDARD CHARACTERS WITHOUT CLAIM TO ANY PARTICULAR FONT, STYLE, SIZE, OR COLOR.

FOR ENTERTAINMENT IN THE NATURE OF LIVE PERFORMANCES BY A MUSICAL BAND (U.S. CLS. 100, 101 AND 107).

FIRST USE 5-20-2004; IN COMMERCE 10-1-2004.
ANNE MADDEN, EXAMINING ATTORNEY

SN 77-564,763. FESTIVAL FUN PARKS, LLC, NEWPORT BEACH, CA. FILED 9-8-2008.



THE MARK CONSISTS OF THE WORDS "SCREAMIN DEMON" OVERLAPPING A PATTERN OF CURVED SHAPES AND LINES WITH A PAINT SPLATTER EFFECT.

FOR ENTERTAINMENT SERVICES IN THE NATURE OF AMUSEMENT PARK RIDES (U.S. CLS. 100, 101 AND 107).

TOBY BULLOFF, EXAMINING ATTORNEY

SN 77-565,025. SAN GREGORIO, ERIC, SACRAMENTO, CA. FILED 9-8-2008.

4TH DIMENSION ENTERTAINMENT

THE MARK CONSISTS OF STANDARD CHARACTERS WITHOUT CLAIM TO ANY PARTICULAR FONT, STYLE, SIZE, OR COLOR.

NO CLAIM IS MADE TO THE EXCLUSIVE RIGHT TO USE "ENTERTAINMENT", APART FROM THE MARK AS SHOWN.

FOR BOOK PUBLISHING (U.S. CLS. 100, 101 AND 107).
DAVID COLLIER, EXAMINING ATTORNEY

CLASS 41—(Continued).

SN 77-565,053. MELODIK PRODUCTIONS, LLC, SCOTTSDALE, AZ. FILED 9-8-2008.

ROCK BOOT CAMP

THE MARK CONSISTS OF STANDARD CHARACTERS WITHOUT CLAIM TO ANY PARTICULAR FONT, STYLE, SIZE, OR COLOR.

NO CLAIM IS MADE TO THE EXCLUSIVE RIGHT TO USE "ROCK", APART FROM THE MARK AS SHOWN.

FOR EDUCATION SERVICES, NAMELY, PROVIDING CLASSES, SEMINARS AND WORKSHOPS IN THE FIELD OF MUSIC, AUDIO RECORDING AND LIVE PERFORMANCE (U.S. CLS. 100, 101 AND 107).

REBECCA SMITH, EXAMINING ATTORNEY

CLASS 41—(Continued).

SN 77-565,147. SGRO, PETER, WESTMINSTER, CO. FILED 9-8-2008.

WRITE TO ACT

THE MARK CONSISTS OF STANDARD CHARACTERS WITHOUT CLAIM TO ANY PARTICULAR FONT, STYLE, SIZE, OR COLOR.

FOR EDUCATION SERVICES, NAMELY, PROVIDING LIVE AND ON-LINE CLASSES, SEMINARS, WORKSHOPS IN THE FIELD OF TEACHING ACTORS TO WRITE THEIR OWN PERFORMANCE VEHICLES TO LAUNCH THEIR CAREERS IN THE THEATRE, FILM AND TELEVISION INDUSTRIES (U.S. CLS. 100, 101 AND 107).

WILLIAM VERHOSEK, EXAMINING ATTORNEY

SN 77-565,096. JEFF COHEN, DBA JAZZY ENTERTAINMENT, LOS ANGELES, CA. FILED 9-8-2008.



THE COLOR(S) YELLOW, BLACK AND RED IS/ARE CLAIMED AS A FEATURE OF THE MARK.

THE MARK CONSISTS OF A BLACK AND YELLOW BEE WITH A RED STINGER AND A RED AUDIO SIGNAL BETWEEN ITS ANTENNAS.

FOR ENTERTAINMENT SERVICES, NAMELY, PROVIDING PRERECORDED MUSIC VIA A GLOBAL COMMUNICATIONS NETWORK AND PROVIDING PRERECORDED MUSIC ACCORDING TO CONSUMER PREFERENCES VIA A GLOBAL COMMUNICATIONS NETWORK (U.S. CLS. 100, 101 AND 107).

INGRID C. EULIN, EXAMINING ATTORNEY

SN 77-565,155. BINDRA, MIKE, ALFORD, MA. FILED 9-8-2008.



THE MARK CONSISTS OF THREE CONCENTRIC CIRCLES WITH "MADE" DISPLAYED IN THE CENTER CIRCLE. THE OUTER CIRCLE IS DARK SHADED, THE MIDDLE CIRCLE IS LIGHT SHADED, THE INNER CIRCLE IS DARK SHADED, AND "MADE" IS IN LIGHT SHADED LETTERING.

FOR ENTERTAINMENT, NAMELY, PRODUCTION OF CONCERTS, MUSIC FESTIVALS AND NIGHTCLUB EVENTS FEATURING LIVE DJs, BANDS AND/OR MUSICIANS (U.S. CLS. 100, 101 AND 107).

FIRST USE 11-21-2001; IN COMMERCE 11-21-2001.
IRA J. GOODSaid, EXAMINING ATTORNEY

CLASS 41—(Continued).

SN 77-565,316. FUNGOPLAY, LLC, WILMINGTON, DE. FILED 9-9-2008.

FUNGOPLAY

THE MARK CONSISTS OF STANDARD CHARACTERS WITHOUT CLAIM TO ANY PARTICULAR FONT, STYLE, SIZE, OR COLOR.

FOR ENTERTAINMENT SERVICES, NAMELY, PROVIDING ONLINE COMPUTER GAMES RELATING TO SPORTS FOR CHILDREN; ENTERTAINMENT AND EDUCATIONAL SERVICES, NAMELY, PROVIDING INFORMATION RELATING TO SPORTS FOR CHILDREN VIA ONLINE COMPUTER NETWORK (U.S. CLS. 100, 101 AND 107).

CARRIE GENOVESE, EXAMINING ATTORNEY

CLASS 41—(Continued).

SN 77-565,353. EMPOWERMENT HOLDINGS, LLC, SANTA BARBARA, CA. FILED 9-9-2008.

EMPOWERMENT HOLDINGS

THE MARK CONSISTS OF STANDARD CHARACTERS WITHOUT CLAIM TO ANY PARTICULAR FONT, STYLE, SIZE, OR COLOR.

NO CLAIM IS MADE TO THE EXCLUSIVE RIGHT TO USE "HOLDINGS", APART FROM THE MARK AS SHOWN.

FOR EDUCATIONAL SERVICES, NAMELY, CONDUCTING SEMINARS, WORKSHOPS AND CLASSES IN THE FIELD OF PERSONAL AND PROFESSIONAL DEVELOPMENT AND IMPROVEMENT, AND CONSULTATION SERVICES RELATED THERETO, AND PRINTED MATERIALS DISTRIBUTED IN CONNECTION THEREWITH (U.S. CLS. 100, 101 AND 107).

JAY FLOWERS, EXAMINING ATTORNEY

SN 77-565,372. THE LEADERSHIP FORUM INC. DBA EXECUTIVE FORUM, DENVER, CO. FILED 9-9-2008.

iLoveFeedback

THE MARK CONSISTS OF STANDARD CHARACTERS WITHOUT CLAIM TO ANY PARTICULAR FONT, STYLE, SIZE, OR COLOR.

FOR PROVIDING TRAINING AND SEMINARS IN THE FIELD OF RELATIONSHIP, PERFORMANCE AND PRODUCTIVITY IMPROVEMENT (U.S. CLS. 100, 101 AND 107).

FIRST USE 10-30-2007; IN COMMERCE 6-0-2008.
SUNG IN, EXAMINING ATTORNEY

SN 77-565,351. G&C ENTERPRISES, INC., BEAUMONT, TX. FILED 9-9-2008.

COACHING WOMEN 2 WIN

THE MARK CONSISTS OF STANDARD CHARACTERS WITHOUT CLAIM TO ANY PARTICULAR FONT, STYLE, SIZE, OR COLOR.

FOR EDUCATIONAL SERVICES, NAMELY, PROVIDING SEMINARS, WORKSHOPS, MOTIVATIONAL SPEAKING AND COACHING IN THE FIELDS OF PERSONAL AND PROFESSIONAL DEVELOPMENT, FINANCES, INVESTMENTS, SELF-IMPROVEMENT AND OTHER SELF-HELP TOPICS AND DISTRIBUTION OF COURSE MATERIAL IN CONNECTION THEREWITH; LIFE COACHING SERVICES IN THE FIELD OF PERSONAL AND PROFESSIONAL DEVELOPMENT, FINANCES, INVESTMENTS, SELF-IMPROVEMENT AND OTHER SELF-HELP TOPICS; PUBLISHING OF ELECTRONIC PUBLICATIONS (U.S. CLS. 100, 101 AND 107).

FIRST USE 11-26-2007; IN COMMERCE 11-26-2007.
MARIA-VICTORIA SUAREZ, EXAMINING ATTORNEY

SN 77-565,392. DIXIE STAMPEDE, LLC, PIGEON FORGE, TN. FILED 9-9-2008.

PIRATES LAGOON

THE MARK CONSISTS OF STANDARD CHARACTERS WITHOUT CLAIM TO ANY PARTICULAR FONT, STYLE, SIZE, OR COLOR.

FOR PIRATE THEMED DINNER THEATER SERVICES AND ENTERTAINMENT SERVICES IN THE NATURE OF PLAYS, SHOWS, AND PAGEANTS FEATURING PIRATE CHARACTERS (U.S. CLS. 100, 101 AND 107).

JILL PRATER, EXAMINING ATTORNEY

CLASS 41—(Continued).

SN 77-565,406. DIXIE STAMPEDE, LLC, PIGEON FORGE, TN. FILED 9-9-2008.

PIRATES' LAGOON

THE MARK CONSISTS OF STANDARD CHARACTERS WITHOUT CLAIM TO ANY PARTICULAR FONT, STYLE, SIZE, OR COLOR.

FOR PIRATE THEMED DINNER THEATER SERVICES AND ENTERTAINMENT SERVICES IN THE NATURE OF PLAYS, SHOWS, AND PAGEANTS FEATURING PIRATE CHARACTERS (U.S. CLS. 100, 101 AND 107).

JILL PRATER, EXAMINING ATTORNEY

SN 77-565,434. KEN TAMPLIN, COSTA MESA, CA. FILED 9-9-2008.

Ballroom Blitz

THE MARK CONSISTS OF STANDARD CHARACTERS WITHOUT CLAIM TO ANY PARTICULAR FONT, STYLE, SIZE, OR COLOR.

FOR MUSICAL ENTERTAINMENT SERVICES, NAMELY, LIVE PERFORMANCES BY A MUSICAL GROUP (U.S. CLS. 100, 101 AND 107).

FIRST USE 1-6-2008; IN COMMERCE 1-6-2008.

JULIE GUTTADAURO, EXAMINING ATTORNEY

SN 77-565,713. ESP FILMS LTD., BROOKLYN, NY. FILED 9-9-2008.

THRILLOGY

THE MARK CONSISTS OF STANDARD CHARACTERS WITHOUT CLAIM TO ANY PARTICULAR FONT, STYLE, SIZE, OR COLOR.

FOR ENTERTAINMENT SERVICES, NAMELY, A MULTIMEDIA PROGRAM SERIES FEATURING COMEDY, ACTION AND ADVENTURE DISTRIBUTED VIA VARIOUS PLATFORMS ACROSS MULTIPLE FORMS OF TRANSMISSION MEDIA (U.S. CLS. 100, 101 AND 107).

ZACHARY BELLO, EXAMINING ATTORNEY

CLASS 41—(Continued).

SN 77-565,727. ESP FILMS LTD., BROOKLYN, NY. FILED 9-9-2008.

CRIMSON MASK

THE MARK CONSISTS OF STANDARD CHARACTERS WITHOUT CLAIM TO ANY PARTICULAR FONT, STYLE, SIZE, OR COLOR.

FOR ENTERTAINMENT SERVICES, NAMELY, A MULTIMEDIA PROGRAM SERIES FEATURING COMEDY, ACTION AND ADVENTURE DISTRIBUTED VIA VARIOUS PLATFORMS ACROSS MULTIPLE FORMS OF TRANSMISSION MEDIA (U.S. CLS. 100, 101 AND 107).

ZACHARY BELLO, EXAMINING ATTORNEY

SN 77-565,802. YOUR STORY HERE LLC, MISSION VIEJO, CA. FILED 9-9-2008.

Your Story Here

THE MARK CONSISTS OF STANDARD CHARACTERS WITHOUT CLAIM TO ANY PARTICULAR FONT, STYLE, SIZE, OR COLOR.

FOR AUDIO AND VIDEO RECORDING SERVICES; FILM AND VIDEO FILM PRODUCTION; FILM AND VIDEO PRODUCTION; FILM AND VIDEO TAPE FILM PRODUCTION; MULTIMEDIA ENTERTAINMENT SERVICES IN THE NATURE OF RECORDING, PRODUCTION AND POST-PRODUCTION SERVICES IN THE FIELDS OF MUSIC, VIDEO, AND FILMS; PHOTOGRAPHIC AND VIDEO SERVICES, NAMELY, PHOTOGRAPHIC AND VIDEO CAPTURE; POST-PRODUCTION EDITING SERVICES IN THE FIELD OF MUSIC, VIDEOS AND FILMS; PRODUCTION OF VIDEO AND CREATION OF VISUAL EFFECTS FOR OTHERS FOR USE IN DVDS, TELEVISION PROGRAMS AND ON WEB SITES; PRODUCTION OF VIDEO DISCS FOR OTHERS; VIDEO EDITING; VIDEO MASTERING SERVICES; VIDEO RECORDING OF PERSONAL GENEALOGICAL DOCUMENTARIES; VIDEO RECORDING SERVICES; VIDEO TAPE RECORDING FOR OTHERS; VIDEOGRAPHY SERVICES (U.S. CLS. 100, 101 AND 107).

FIRST USE 3-16-2007; IN COMMERCE 3-16-2007.

ANN E. SAPPENFIELD, EXAMINING ATTORNEY

CLASS 41—(Continued).

SN 77-566,036. UNITED STATES ANTI-DOPING AGENCY, AKA USADA, COLORADO SPRINGS, CO. FILED 9-9-2008.



OWNER OF U.S. REG. NOS. 3,220,102 AND 3,239,326.
 THE MARK CONSISTS OF THE WORDS "MY VICTORY. I COMPETE CLEAN." IN STYLIZED LETTERS WITH THE "V" IN "VICTORY" EMPHASIZED IN A LARGER FONT AND A HORIZONTAL SLASH BENEATH THE STYLIZED MARK.
 FOR PROVIDING NEWS AND INFORMATION IN THE FIELDS OF SPORTS, ATHLETES, SPORTSMANSHIP, FAIR PLAY, SPORTS VALUES, SPORTS ETHICS AND PARTICIPATION IN SPORTS WITHOUT THE USE OF PERFORMANCE-ENHANCING DRUGS OR METHODS (U.S. CLS. 100, 101 AND 107).
 FIRST USE 4-24-2008; IN COMMERCE 4-24-2008.
 JILL C. ALT, EXAMINING ATTORNEY

SN 77-566,073. JOHN RALLO, BALTIMORE, MD. FILED 9-9-2008.

SHOGUN

THE MARK CONSISTS OF STANDARD CHARACTERS WITHOUT CLAIM TO ANY PARTICULAR FONT, STYLE, SIZE, OR COLOR.
 FOR ORGANIZING LIVE MIXED MARTIAL ARTS EVENTS AND COMPETITIONS; PRESENTATION OF MIXED MARTIAL ARTS (MMA) EVENTS (U.S. CLS. 100, 101 AND 107).
 STEVEN PEREZ, EXAMINING ATTORNEY

SN 77-566,110. BHONSLE, GAURI, DULUTH, GA. FILED 9-9-2008.

Mokksha

THE MARK CONSISTS OF STANDARD CHARACTERS WITHOUT CLAIM TO ANY PARTICULAR FONT, STYLE, SIZE, OR COLOR.
 THE ENGLISH TRANSLATION OF THE WORD "MOKKSHA" IN THE MARK IS "LIBERATION".
 FOR PROVIDING AN INTERNET WEBSITE PORTAL IN THE FIELD OF MUSIC (U.S. CLS. 100, 101 AND 107).
 APRIL HESIK, EXAMINING ATTORNEY

CLASS 41—(Continued).

SN 77-566,164. RUSS-TRENT, DR. LANA, OCALA, FL. FILED 9-9-2008.

Strategic Living

THE MARK CONSISTS OF STANDARD CHARACTERS WITHOUT CLAIM TO ANY PARTICULAR FONT, STYLE, SIZE, OR COLOR.
 FOR EDUCATION SERVICES, NAMELY, PROVIDING CLASSES, SEMINARS, WORKSHOPS IN THE FIELDS OF INTELLECTUAL PROPERTY, PHILOSOPHY, PSYCHOSOCIALPOLITICAL ANALYSIS, CONFLICT ANALYSIS MANAGEMENT AND RESOLUTION; TEACHING IN THE FIELD OF INTELLECTUAL PROPERTY, PHILOSOPHY, PSYCHOSOCIALPOLITICAL ANALYSIS, CONFLICT ANALYSIS MANAGEMENT AND RESOLUTION (U.S. CLS. 100, 101 AND 107).
 INGRID C. EULIN, EXAMINING ATTORNEY

SN 77-566,165. FICKEN CONSULTING, LLC, SAVAGE, MN. FILED 9-9-2008.

First5

THE MARK CONSISTS OF STANDARD CHARACTERS WITHOUT CLAIM TO ANY PARTICULAR FONT, STYLE, SIZE, OR COLOR.
 FOR TRAINING SERVICES IN THE FIELD OF EXECUTIVE DEVELOPMENT AND LEADERSHIP (U.S. CLS. 100, 101 AND 107).
 INGRID C. EULIN, EXAMINING ATTORNEY

SN 77-566,208. SANCHEZ, ANDREW E., APTOS, CA. FILED 9-10-2008.

THE TRAFFIC LACKEY

THE MARK CONSISTS OF STANDARD CHARACTERS WITHOUT CLAIM TO ANY PARTICULAR FONT, STYLE, SIZE, OR COLOR.
 FOR ENTERTAINMENT IN THE NATURE OF LIVE RADIO PERSONALITY PERFORMANCES (U.S. CLS. 100, 101 AND 107).
 FIRST USE 0-0-1996; IN COMMERCE 0-0-1996.
 ELISSA GARBER KON, EXAMINING ATTORNEY

CLASS 41—(Continued).

SN 77-566,216. FORESIGHT INSTITUTE INC., SEDONA, AZ. FILED 9-10-2008.

FORESIGHT EDUCATION

THE MARK CONSISTS OF STANDARD CHARACTERS WITHOUT CLAIM TO ANY PARTICULAR FONT, STYLE, SIZE, OR COLOR.

NO CLAIM IS MADE TO THE EXCLUSIVE RIGHT TO USE "EDUCATION", APART FROM THE MARK AS SHOWN.

FOR DEVELOPING EDUCATIONAL MANUALS FOR OTHERS IN THE FIELD OF EDUCATION AND CREATING CHANGE IN SOCIETY; EDUCATIONAL SERVICES, NAMELY, DEVELOPING CURRICULUM FOR EDUCATORS; EDUCATIONAL SERVICES, NAMELY, DEVELOPING CURRICULUM FOR OTHERS IN THE FIELD OF EDUCATION AND CREATING CHANGE IN SOCIETY; EDUCATIONAL SERVICES, NAMELY, DEVELOPING CURRICULUM FOR TEACHERS; EDUCATIONAL SERVICES, NAMELY, PROVIDING WORKSHOPS AND ONLINE COURSES IN THE FIELD OF EDUCATION; EDUCATIONAL SERVICES, NAMELY, PROVIDING WORKSHOPS AND ONLINE COURSES IN THE FIELD OF CREATING CHANGE IN SOCIETY BY STUDYING THE NEEDS OF THE FUTURE OF HUMANITY, STUDYING THE LIVES OF GREAT LEADERS PAST AND PRESENT, AND STUDYING PROBLEM-SOLVING METHODS, TECHNIQUES AND SOLUTIONS FOR CURRENT AND FUTURE COMMUNITY, NATIONAL, AND GLOBAL CHALLENGES (U.S. CLS. 100, 101 AND 107).

FIRST USE 0-0-2007; IN COMMERCE 0-0-2007.
ANGELA M. MICHELI, EXAMINING ATTORNEY

SN 77-566,433. HAN, PETER, CONROE, TX. AND FERNANDEZ, MARIA E., CONROE, TX. FILED 9-10-2008.

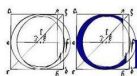

THE COLOR(S) DARK BLUE, BLACK IS/ARE CLAIMED AS A FEATURE OF THE MARK.

THE MARK CONSISTS OF A STYLIZED OUTLINE IN BLACK COLOR OF THE LETTER "C" IN UPPER CASE FONT IS THE LEFT MOST ELEMENT OF THIS MARK, FOLLOWED BY A STYLIZED OUTLINE IN BLACK COLOR OF THE LETTER "C" IN UPPER CASE FONT THAT IS FILLED IN WITH DARK BLUE COLOR TO FORM A CLEARLY VISIBLE LETTER "C" IN UPPER CASE FONT, FOLLOWED BY THE REMAINING LETTERS "HARAKTER WORKS" IN DARK BLUE FONT WITH THE LETTERS "C" AND "W" SIGNIFICANTLY LARGER IN SIZE THAN THE REMAINING LETTERS.

FOR EDUCATIONAL SERVICES, NAMELY, CONDUCTING CLASSES, SEMINARS, CONFERENCES, WORKSHOPS, MENTORING SESSIONS, TUTORING SESSIONS, COACHING SESSIONS IN THE FIELD OF CHARACTER DEVELOPMENT AND DISTRIBUTION OF COURSE MATERIAL IN CONNECTION THEREWITH (U.S. CLS. 100, 101 AND 107).

FIRST USE 5-7-2008; IN COMMERCE 5-7-2008.
JILL PRATER, EXAMINING ATTORNEY

CLASS 41—(Continued).

SN 77-566,497. ARTSTREAM, INC., BETHESDA, MD. FILED 9-10-2008.

**ARTSTREAM PERFORM YOUR ART
OUT**

THE MARK CONSISTS OF STANDARD CHARACTERS WITHOUT CLAIM TO ANY PARTICULAR FONT, STYLE, SIZE, OR COLOR.

FOR EDUCATION SERVICES, NAMELY, PROVIDING CLASSES, SEMINARS AND WORKSHOPS IN THE FIELDS OF DRAMA, MUSIC, DANCE AND VOCAL TECHNIQUES; ENTERTAINMENT IN THE NATURE OF THEATER PRODUCTIONS (U.S. CLS. 100, 101 AND 107).

FIRST USE 10-18-2006; IN COMMERCE 11-20-2006.
KAREN K. BUSH, EXAMINING ATTORNEY

SN 77-566,500. SHORN INDUSTRIES, LLC, PENNINGTON, NJ. FILED 9-10-2008.

ESCAPE THE CUBE

THE MARK CONSISTS OF STANDARD CHARACTERS WITHOUT CLAIM TO ANY PARTICULAR FONT, STYLE, SIZE, OR COLOR.

FOR PRODUCTION OF REALITY TELEVISION PROGRAMS; MULTIMEDIA ENTERTAINMENT SERVICES IN THE NATURE OF RECORDING, PRODUCTION AND POST-PRODUCTION SERVICES IN THE FIELDS OF VIDEO AND FILMS; ENTERTAINMENT IN THE NATURE OF ON-GOING REALITY SHOWS BROADCAST OVER TELEVISION, SATELLITE, AUDIO, RADIO, AND VIDEO MEDIA, THE INTERNET, AND MOBILE COMMUNICATIONS NETWORKS (U.S. CLS. 100, 101 AND 107).

KAREN K. BUSH, EXAMINING ATTORNEY

SN 77-566,550. PARTNERS IN MINISTRY INC., MIDDLETOWN, DE. FILED 9-10-2008.

**LOVE GOD. LOVE OTHERS.
CHANGE THE WORLD.**

THE MARK CONSISTS OF STANDARD CHARACTERS WITHOUT CLAIM TO ANY PARTICULAR FONT, STYLE, SIZE, OR COLOR.

FOR EDUCATION SERVICES, NAMELY, PROVIDING LIVE AND ON-LINE SEMINARS AND LECTURES IN THE FIELD OF MOTIVATION AND DISTRIBUTION OF COURSE MATERIAL AND ONLINE MATERIAL IN CONNECTION THEREWITH, ALSO ALL PRINTABLE MATERIALS DISTRIBUTED THEREWITH (U.S. CLS. 100, 101 AND 107).

NAKIA HENRY, EXAMINING ATTORNEY

CLASS 41—(Continued).

SN 77-566,743. PASTOR RADIO, INC., ALPHARETTA, GA. FILED 9-10-2008.

**Where Real Life and Faith
Come Together**

THE MARK CONSISTS OF STANDARD CHARACTERS WITHOUT CLAIM TO ANY PARTICULAR FONT, STYLE, SIZE, OR COLOR.

FOR EDUCATIONAL AND ENTERTAINMENT SERVICES, NAMELY, A CONTINUING PROGRAM ABOUT WHERE REAL LIFE ISSUES INTERSECT WITH FAITH ACCESSIBLE BY RADIO, TELEVISION, SATELLITE, AUDIO, VIDEO AND COMPUTER NETWORKS (U.S. CLS. 100, 101 AND 107).

FIRST USE 2-1-2005; IN COMMERCE 2-1-2005.
BILL DAWE, EXAMINING ATTORNEY



SN 77-566,814. ROCKET GAMING SYSTEMS, LLC, GROVE, OK. FILED 9-10-2008.

CHOCOLATE DELIGHT

THE MARK CONSISTS OF STANDARD CHARACTERS WITHOUT CLAIM TO ANY PARTICULAR FONT, STYLE, SIZE, OR COLOR.

FOR GAMBLING SERVICES (U.S. CLS. 100, 101 AND 107).

COLLEEN DOMBROW, EXAMINING ATTORNEY



SN 77-566,925. COWLEY CORPORATION, FORT WORTH, TX. FILED 9-10-2008.

RETURNS FOR LIVING

THE MARK CONSISTS OF STANDARD CHARACTERS WITHOUT CLAIM TO ANY PARTICULAR FONT, STYLE, SIZE, OR COLOR.

FOR ENTERTAINMENT AND EDUCATIONAL SERVICES IN THE NATURE OF AN ON-GOING RADIO AND WEBCAST PROGRAM CONCERNING FINANCIAL ISSUES (U.S. CLS. 100, 101 AND 107).

KATINA MISTER, EXAMINING ATTORNEY

CLASS 41—(Continued).

SN 77-566,978. VAIL MOUNTAIN SCHOOL, VAIL, CO. FILED 9-10-2008.

GORE RANGERS

THE MARK CONSISTS OF STANDARD CHARACTERS WITHOUT CLAIM TO ANY PARTICULAR FONT, STYLE, SIZE, OR COLOR.

FOR EDUCATIONAL SERVICES, NAMELY, PROVIDING COURSES OF INSTRUCTION AT THE PRE-SCHOOL, KINDERGARTEN, ELEMENTARY, MIDDLE SCHOOL AND HIGH SCHOOL LEVEL; EDUCATIONAL SERVICES, NAMELY, PROVIDING INSTRUCTION IN DISCIPLINES OF ALPINE SKIING, NORDIC SKIING, CROSS-COUNTRY SKIING, TELEMAR SKIING, SOCCER, VOLLEYBALL, TOY FLYING SAUCER GAMES, TENNIS, LACROSSE, BASKETBALL, YOGA, ROCK CLIMBING, SNOWBOARDING, TRACK AND FIELD, GOLF, THE VISUAL ARTS, MUSIC, CREATIVE WRITING, THEATER, CULINARY ARTS, AND THE USE OF COMPUTERS; DISTRIBUTING INSTRUCTIONAL MATERIALS RELATED THERETO (U.S. CLS. 100, 101 AND 107).

ROBERT STRUCK, EXAMINING ATTORNEY



SN 77-566,979. GOLDFISH SWIM SCHOOL FRANCHISING LLC, BIRMINGHAM, MI. FILED 9-10-2008.

GOLDFISH SWIM SCHOOL

THE MARK CONSISTS OF STANDARD CHARACTERS WITHOUT CLAIM TO ANY PARTICULAR FONT, STYLE, SIZE, OR COLOR.

OWNER OF U.S. REG. NO. 3,318,156.
NO CLAIM IS MADE TO THE EXCLUSIVE RIGHT TO USE "SWIM SCHOOL", APART FROM THE MARK AS SHOWN.

FOR SWIMMING INSTRUCTION (U.S. CLS. 100, 101 AND 107).

FIRST USE 4-6-2005; IN COMMERCE 4-29-2005.
STEVEN PEREZ, EXAMINING ATTORNEY

CLASS 41—(Continued).

SN 77-567,022. SPORTS IN PINK, INC., CASTLE ROCK, CO. FILED 9-10-2008.

Sports in Pink

THE MARK CONSISTS OF STANDARD CHARACTERS WITHOUT CLAIM TO ANY PARTICULAR FONT, STYLE, SIZE, OR COLOR.

NO CLAIM IS MADE TO THE EXCLUSIVE RIGHT TO USE "SPORTS", APART FROM THE MARK AS SHOWN.

FOR PROVIDING NEWS AND INFORMATION IN THE FIELD OF SPORTS VIA AN INTERACTIVE WEB PAGE ON THE GLOBAL COMPUTER NETWORK (U.S. CLS. 100, 101 AND 107).

FIRST USE 2-13-2008; IN COMMERCE 2-13-2008.
JEFFERY COWARD, EXAMINING ATTORNEY

CLASS 41—(Continued).

SN 77-567,092. SPORTS IN PINK, INC., CASTLE ROCK, CO. FILED 9-10-2008.



NO CLAIM IS MADE TO THE EXCLUSIVE RIGHT TO USE "SPORTS", APART FROM THE MARK AS SHOWN.

THE COLOR(S) GREY AND PINK IS/ARE CLAIMED AS A FEATURE OF THE MARK.

THE MARK CONSISTS OF THE WORD "SPORTS" IN ALL GRAY CAPITAL LETTERS, CHAMPION FONT, UNDER WHICH ARE THE PINK WORDS "IN PINK", IN DOMESTIC TYPYER FONT, IN PINK PARENTHESES; THE WORDS "(IN PINK)" ARE INDENTED SUCH THAT THEY BEGIN UNDER THE LETTER "T" IN "SPORTS".

FOR PROVIDING NEWS AND INFORMATION IN THE FIELD OF SPORTS VIA AN INTERACTIVE WEB PAGE ON THE GLOBAL COMPUTER NETWORK (U.S. CLS. 100, 101 AND 107).

FIRST USE 2-13-2008; IN COMMERCE 2-13-2008.
JEFFERY COWARD, EXAMINING ATTORNEY

SN 77-567,065. ROCKY MOUNTAIN SUSTAINABLE LIVING ASSOCIATION, INC., BELLVUE, CO. FILED 9-10-2008.



THE COLOR(S) BLUE, YELLOW AND BLACK IS/ARE CLAIMED AS A FEATURE OF THE MARK.

THE MARK CONSISTS OF A COG DIVIDED IN TWO, ONE HALF OF WHICH IS YELLOW OUTLINED IN BLACK AND THE OTHER HALF OF WHICH IS BLUE OUTLINED IN BLACK.

FOR EDUCATION SERVICES, NAMELY, PROVIDING COURSES, CLASSES, WORKSHOPS, SEMINARS, PROGRAMS, LECTURES, CONFERENCES, FAIRS AND INSTRUCTOR TRAININGS IN THE FIELD OF SUSTAINABLE LIVING PRACTICES, RENEWABLE ENERGY, ENVIRONMENTAL AND SOCIAL RESPONSIBILITY, NATURAL HEALTH, GREEN BUILDING, ALTERNATIVE VEHICLES, ORGANIC AGRICULTURE AND LOCAL ECONOMIES (U.S. CLS. 100, 101 AND 107).

FIRST USE 5-1-2003; IN COMMERCE 5-1-2003.
LINDA POWELL, EXAMINING ATTORNEY

SN 77-567,118. FITNESS ANYWHERE, INC., SAN FRANCISCO, CA. FILED 9-10-2008.

FITNESS ANYWHERE

THE MARK CONSISTS OF STANDARD CHARACTERS WITHOUT CLAIM TO ANY PARTICULAR FONT, STYLE, SIZE, OR COLOR.

OWNER OF U.S. REG. NO. 2,975,844.

NO CLAIM IS MADE TO THE EXCLUSIVE RIGHT TO USE "FITNESS", APART FROM THE MARK AS SHOWN.

FOR COUNSELING SERVICES IN THE FIELD OF PHYSICAL FITNESS; EDUCATIONAL SERVICES, NAMELY, CONDUCTING CLASSES, SEMINARS, CONFERENCES, WORKSHOPS IN THE FIELD OF PHYSICAL FITNESS AND DISTRIBUTION OF COURSE MATERIAL IN CONNECTION THEREWITH; EDUCATIONAL SERVICES, NAMELY, DEVELOPING, ARRANGING, AND CONDUCTING EDUCATIONAL CONFERENCES AND PROGRAMS AND PROVIDING COURSES OF INSTRUCTION IN THE FIELD OF PHYSICAL FITNESS; PHYSICAL EDUCATION; PHYSICAL EDUCATION SERVICES; PHYSICAL FITNESS CONDITIONING CLASSES; PHYSICAL FITNESS CONSULTATION; PHYSICAL FITNESS INSTRUCTION (U.S. CLS. 100, 101 AND 107).

FIRST USE 12-1-2005; IN COMMERCE 12-1-2005.
MATTHEW EINSTEIN, EXAMINING ATTORNEY

CLASS 41—(Continued).

SN 77-567,128. WALLER, REGGIE, DBA PRIVATE PAPA-RAZZI, SAN DIEGO, CA. FILED 9-10-2008.



THE MARK CONSISTS OF THE WORDS "PRIVATE PAPA RAZZI" IN ALL CAPITAL LETTERS IN A STYLIZED FONT WITH SHADING INCREASING FROM TOP TO BOTTOM OF EACH LETTER. THE WORDS PARTIALLY OVERLAY A RIBBON OF FILM. EACH END INCLUDES A GROUP OF THREE PHOTOGRAPHERS ALSO OVERLAYING THE RIBBON OF FILM. THE BACKGROUND IS BLACK.

FOR PHOTOGRAPHIC SERVICES, NAMELY, PHOTOGRAPHIC CAPTURE AT SPECIAL OCCASIONS (U.S. CLS. 100, 101 AND 107).

FIRST USE 2-12-2007; IN COMMERCE 2-12-2007.
SCOTT BIBB, EXAMINING ATTORNEY

CLASS 41—(Continued).

SN 77-567,478. BOGDANOS, PETER BASIL, NORTH BERGEN, NJ. AND REUTER, ALDA, NORTH BERGEN, NJ. FILED 9-11-2008.

MEXICO BEYOND MARIACHI

THE MARK CONSISTS OF STANDARD CHARACTERS WITHOUT CLAIM TO ANY PARTICULAR FONT, STYLE, SIZE, OR COLOR.

FOR EDUCATING AT SENIOR HIGH SCHOOLS; EDUCATION SERVICES, NAMELY, PROVIDING WORKSHOPS IN THE FIELD OF MUSIC; EDUCATIONAL SERVICES, NAMELY, CONDUCTING SEMINARS IN THE FIELD OF MUSIC AND DISTRIBUTION OF COURSE MATERIAL IN CONNECTION THEREWITH; EDUCATIONAL SERVICES, NAMELY, DEVELOPING, ARRANGING, AND CONDUCTING EDUCATIONAL CONFERENCES AND PROGRAMS AND PROVIDING COURSES OF INSTRUCTION IN THE FIELD OF MUSIC; ENTERTAINMENT IN THE NATURE OF DANCE PERFORMANCES; ENTERTAINMENT IN THE NATURE OF LIVE PERFORMANCES BY A MUSICAL GROUP; ENTERTAINMENT IN THE NATURE OF VISUAL AND AUDIO PERFORMANCES, NAMELY, MUSICAL BAND, ROCK GROUP, GYMNAS-TIC, DANCE, AND BALLET PERFORMANCES; ENTERTAINMENT IN THE NATURE OF A MUSICAL GROUP; ENTERTAINMENT SERVICES IN THE NATURE OF LIVE MUSICAL PERFORMANCES; ENTERTAINMENT SERVICES, NAMELY PROVIDING A WEB SITE FEATURING PHOTOGRAPHIC, AUDIO, VIDEO AND PROSE PRESENTATIONS FEATURING A MUSICAL GROUP; ENTERTAINMENT, NAMELY, LIVE MUSIC CON-CERTS; ENTERTAINMENT, NAMELY, LIVE PERFORMANCES BY A MUSICAL BAND; ENTERTAINMENT, NAMELY, LIVE PERFORMANCES BY MUSICAL BANDS; ORGANISATION OF EXHIBITIONS FOR CULTURAL OR EDUCATIONAL PURPOSES; ORGANIZING LIVE EXHIBITIONS AND CONFERENCES IN THE FIELDS OF EDUCATION, CULTURE, SPORTS AND ENTERTAINMENT FOR NON-BUSINESS AND NON-COMMERCIAL PURPOSES (U.S. CLS. 100, 101 AND 107).

FIRST USE 9-7-2005; IN COMMERCE 9-7-2005.
TOBY BULLOFF, EXAMINING ATTORNEY

SN 77-567,145. SPORTS IN PINK, INC., CASTLE ROCK, CO. FILED 9-10-2008.

We've come to play.

THE MARK CONSISTS OF STANDARD CHARACTERS WITHOUT CLAIM TO ANY PARTICULAR FONT, STYLE, SIZE, OR COLOR.

FOR PROVIDING NEWS AND INFORMATION IN THE FIELD OF SPORTS VIA AN INTERACTIVE WEB PAGE ON THE GLOBAL COMPUTER NETWORK (U.S. CLS. 100, 101 AND 107).

FIRST USE 2-13-2008; IN COMMERCE 2-13-2008.
JEFFERY COWARD, EXAMINING ATTORNEY

SN 77-567,385. NATIONAL ASSOCIATION FOR STOCK CAR AUTO RACING, INC., DAYTONA BEACH, FL. FILED 9-11-2008.

WHERE THE BEST PROVE IT.

THE MARK CONSISTS OF STANDARD CHARACTERS WITHOUT CLAIM TO ANY PARTICULAR FONT, STYLE, SIZE, OR COLOR.

FOR ENTERTAINMENT SERVICES, NAMELY, CONDUCTING MOTORSPORTS RACING EVENTS; REGULATING, GOVERNING, AND SANCTIONING MOTORSPORTS RACING EVENTS (U.S. CLS. 100, 101 AND 107).

FIRST USE 9-11-2008; IN COMMERCE 9-11-2008.
SANJEEV VOHRA, EXAMINING ATTORNEY

SN 77-567,479. SYRACUSE UNIVERSITY, SYRACUSE, NY. FILED 9-11-2008.

WISE WOMEN IGNITING THE SPIRIT OF ENTREPRENEURSHIP

THE MARK CONSISTS OF STANDARD CHARACTERS WITHOUT CLAIM TO ANY PARTICULAR FONT, STYLE, SIZE, OR COLOR.

OWNER OF U.S. REG. NO. 3,376,557.
FOR EDUCATIONAL SERVICES, NAMELY, CONDUCTING SEMINARS, CLASSES, AND WORKSHOPS IN THE FIELD OF ENTREPRENEURSHIP (U.S. CLS. 100, 101 AND 107).

FIRST USE 6-1-2002; IN COMMERCE 6-1-2002.
DAVID MILLER, EXAMINING ATTORNEY

CLASS 41—(Continued).

SN 77-567,609. SQUARE AND LEVEL MEDIA PRODUCTIONS, INC., GLENVIEW, IL. FILED 9-11-2008.

JOE BUILDER

THE MARK CONSISTS OF STANDARD CHARACTERS WITHOUT CLAIM TO ANY PARTICULAR FONT, STYLE, SIZE, OR COLOR.

NO CLAIM IS MADE TO THE EXCLUSIVE RIGHT TO USE "BUILDER", APART FROM THE MARK AS SHOWN.

FOR ENTERTAINMENT SERVICES, NAMELY, PROVIDING AN ON-GOING RADIO PROGRAM IN THE FIELD OF HOME REPAIR AND HOME IMPROVEMENT (U.S. CLS. 100, 101 AND 107).

NANCY CLARKE, EXAMINING ATTORNEY

SN 77-567,616. SQUARE AND LEVEL MEDIA PRODUCTIONS, INC., GLENVIEW, IL. FILED 9-11-2008.

KEEP IT SQUARE AND LEVEL

THE MARK CONSISTS OF STANDARD CHARACTERS WITHOUT CLAIM TO ANY PARTICULAR FONT, STYLE, SIZE, OR COLOR.

FOR ENTERTAINMENT SERVICES, NAMELY, PROVIDING AN ON-GOING RADIO PROGRAM IN THE FIELD OF HOME REPAIR AND HOME IMPROVEMENT (U.S. CLS. 100, 101 AND 107).

NANCY CLARKE, EXAMINING ATTORNEY

SN 77-567,692. MUNDEY, LYNETTE J, UPPER MARLBORO, MD. FILED 9-11-2008.

READING WHILE RIDING

THE MARK CONSISTS OF STANDARD CHARACTERS WITHOUT CLAIM TO ANY PARTICULAR FONT, STYLE, SIZE, OR COLOR.

FOR INFORMATION ON EDUCATION (U.S. CLS. 100, 101 AND 107).

DAVID TAYLOR, EXAMINING ATTORNEY

CLASS 41—(Continued).

SN 77-567,718. GOLFLAND ENTERTAINMENT CENTERS, INC., MESA, AZ. FILED 9-11-2008.

NIGHT SPLASH

THE MARK CONSISTS OF STANDARD CHARACTERS WITHOUT CLAIM TO ANY PARTICULAR FONT, STYLE, SIZE, OR COLOR.

FOR ENTERTAINMENT SERVICES, NAMELY, WATER AMUSEMENT PARK RIDES AND ATTRACTIONS (U.S. CLS. 100, 101 AND 107).

FIRST USE 4-1-2007; IN COMMERCE 6-1-2007.

ARETHA SOMERVILLE, EXAMINING ATTORNEY

SN 77-567,806. INSTITUTE FOR SCHOOL INNOVATION, TALLAHASSEE, FL. FILED 9-11-2008.



THE COLOR(S) BLUE, WHITE, GOLD IS/ARE CLAIMED AS A FEATURE OF THE MARK.

THE MARK CONSISTS OF BLUE RECTANGULAR BACKGROUND WITH WHITE "ISI" IN WHITE CAPITAL LETTERS. THE FIRST "I" IS TOPPED WITH A GOLD STAR AND HAS A GOLD STREAK COMING OUT FROM IT.

FOR EDUCATIONAL SERVICES, NAMELY, CONDUCTING WORKSHOPS, CONFERENCES, SEMINARS, AND CLASSROOM COACHING IN THE FIELD OF INNOVATIVE TEACHING PRACTICES, AND DISTRIBUTION OF COURSE MATERIAL IN CONNECTION THEREWITH (U.S. CLS. 100, 101 AND 107).

FIRST USE 8-28-1995; IN COMMERCE 8-28-1995.

ARETHA SOMERVILLE, EXAMINING ATTORNEY

CLASS 41—(Continued).

SN 77-568,105. BILLY, DUREL, PUYALLUP, WA. AND NORRIS, RASHAD, PUYALLUP, WA. FILED 9-11-2008.

LOVE LIFE OVER VIOLENCE IS
EVOLUTIONARY

THE MARK CONSISTS OF STANDARD CHARACTERS WITHOUT CLAIM TO ANY PARTICULAR FONT, STYLE, SIZE, OR COLOR.

FOR EDUCATION SERVICES, NAMELY, PROVIDING CLASSES, SEMINARS AND WORKSHOPS IN THE FIELD OF CONFLICT RESOLUTION AND CAREER COUNSELING; EDUCATIONAL SERVICES, NAMELY, PROVIDING MOTIVATIONAL SPEAKING SERVICES IN THE FIELD OF SELF-HELP, SELF-IMPROVEMENT AND DEVELOPING MOTIVATIONAL SKILLS (U.S. CLS. 100, 101 AND 107).

AMY C. KEAN, EXAMINING ATTORNEY



SN 77-568,216. NICKERSON, TIMOTHY, MANSFIELD, MA. FILED 9-11-2008.

FLYSWITCH

THE MARK CONSISTS OF STANDARD CHARACTERS WITHOUT CLAIM TO ANY PARTICULAR FONT, STYLE, SIZE, OR COLOR.

FOR ENTERTAINMENT IN THE NATURE OF LIVE PERFORMANCES BY A MUSICAL BAND (U.S. CLS. 100, 101 AND 107).

FIRST USE 4-21-2006; IN COMMERCE 4-21-2006.
LAURIE MAYES, EXAMINING ATTORNEY



SN 77-568,283. THE JONESES, HUNTINGTON BEACH, CA. FILED 9-11-2008.

THE JONESES

THE MARK CONSISTS OF STANDARD CHARACTERS WITHOUT CLAIM TO ANY PARTICULAR FONT, STYLE, SIZE, OR COLOR.

FOR ENTERTAINMENT, NAMELY, LIVE PERFORMANCES BY A MUSICAL BAND (U.S. CLS. 100, 101 AND 107).

FIRST USE 8-3-2008; IN COMMERCE 8-4-2008.
TRACY FLETCHER, EXAMINING ATTORNEY

CLASS 41—(Continued).

SN 77-570,351. MEMPHIS IN MAY INTERNATIONAL FESTIVAL, INC., MEMPHIS, TN. FILED 9-15-2008.

BEALE STREET MUSIC FESTIVAL

THE MARK CONSISTS OF STANDARD CHARACTERS WITHOUT CLAIM TO ANY PARTICULAR FONT, STYLE, SIZE, OR COLOR.

NO CLAIM IS MADE TO THE EXCLUSIVE RIGHT TO USE "MUSIC FESTIVAL", APART FROM THE MARK AS SHOWN.

SEC. 2(F).
FOR ENTERTAINMENT SERVICES, NAMELY, LIVE MUSICAL PERFORMANCES (U.S. CLS. 100, 101 AND 107).

FIRST USE 1-31-1988; IN COMMERCE 1-31-1988.
BRIAN NEVILLE, EXAMINING ATTORNEY



SN 77-570,354. SBE LICENSING, LOS ANGELES, CA. FILED 9-15-2008.



OWNER OF U.S. REG. NO. 3,525,909.
THE MARK CONSISTS OF DESIGN OF THREE OVERLAPPING FACES ABOVE THE WORD "AREA" FOR NIGHT CLUBS (U.S. CLS. 100, 101 AND 107).
FIRST USE 9-0-2006; IN COMMERCE 9-0-2006.
DAVID COLLIER, EXAMINING ATTORNEY



SN 77-570,939. MEMPHIS IN MAY INTERNATIONAL FESTIVAL, INC., MEMPHIS, TN. FILED 9-16-2008.

WORLD CHAMPIONSHIP
BARBECUE COOKING CONTEST

THE MARK CONSISTS OF STANDARD CHARACTERS WITHOUT CLAIM TO ANY PARTICULAR FONT, STYLE, SIZE, OR COLOR.

NO CLAIM IS MADE TO THE EXCLUSIVE RIGHT TO USE "BARBECUE" AND "CONTEST", APART FROM THE MARK AS SHOWN.

SEC. 2(F).
FOR ENTERTAINMENT SERVICES, NAMELY, ORGANIZING AND CONDUCTING BARBECUE COOKING CONTESTS, COSTUME COMPETITIONS, T-SHIRT COMPETITION AND BOOTH CONTESTS (U.S. CLS. 100, 101 AND 107).

FIRST USE 1-31-1988; IN COMMERCE 1-31-1988.
BRIAN NEVILLE, EXAMINING ATTORNEY

CLASS 41—(Continued).

SN 77-571,046. SUSTAINABLE HARVEST, INC., PORTLAND, OR. FILED 9-16-2008.



NO CLAIM IS MADE TO THE EXCLUSIVE RIGHT TO USE "COFFEE", APART FROM THE MARK AS SHOWN. THE MARK CONSISTS OF THE WORDS "LET'S TALK COFFEE" INSIDE A SPEECH BALLOON DESIGN.

FOR EDUCATIONAL SERVICES, NAMELY, SEMINARS AND TRAINING PROGRAMS THAT ADDRESS BUSINESS ISSUES, MARKET STRATEGIES, AND QUALITY CONTROL IN THE FIELD OF COFFEE PRODUCTION (U.S. CLS. 100, 101 AND 107).

FIRST USE 8-0-2008; IN COMMERCE 8-0-2008.
DANIEL BRODY, EXAMINING ATTORNEY

SN 77-571,511. SCHWARTZ-HEBRON, REUT, SAN DIEGO, CO. FILED 9-16-2008.

KINDEXCELLENCE

THE MARK CONSISTS OF STANDARD CHARACTERS WITHOUT CLAIM TO ANY PARTICULAR FONT, STYLE, SIZE, OR COLOR.

FOR TRAINING SERVICES IN THE FIELD OF ORGANIZATIONAL CONSULTING, INCLUDING PERSONAL DEVELOPMENT, ORGANIZATIONAL EFFICIENCY, LEADERSHIP, CHANGE MANAGEMENT, AND EFFECTIVE MANAGEMENT SKILLS (U.S. CLS. 100, 101 AND 107).

FIRST USE 6-15-2006; IN COMMERCE 12-1-2006.
SUSAN RICHARDS, EXAMINING ATTORNEY

SN 77-571,992. BLAYCHON PRODUCTS, LLC, FORT COLLINS, CO. FILED 9-17-2008.

Dittoland

THE MARK CONSISTS OF STANDARD CHARACTERS WITHOUT CLAIM TO ANY PARTICULAR FONT, STYLE, SIZE, OR COLOR.

FOR ENTERTAINMENT SERVICES, NAMELY, PROVIDING ON-LINE COMPUTER GAMES (U.S. CLS. 100, 101 AND 107).

FIRST USE 6-18-2008; IN COMMERCE 7-1-2008.
SUSAN STIGLITZ, EXAMINING ATTORNEY

CLASS 41—(Continued).

SN 77-582,816. NEWBOY FZCO, DUBAI, UNITED ARAB EMIR., FILED 10-1-2008.

Kidrix كيدريكس

OWNER OF UNITED ARAB EMIR. REG. NO. 88068, DATED 4-23-2008, EXPIRES 1-22-2017.

THE MARK CONSISTS OF THE WORD "KIDRIX" AND ITS ARABIC EQUIVALENT.

THE NON-LATIN CHARACTERS IN THE MARK TRANSLITERATE TO "KIDRIX" AND THIS HAS NO MEANING IN ENGLISH.

FOR EDUCATIONAL SERVICES, NAMELY, DEVELOPING AND CONDUCTING TRAINING COURSES AND DISTRIBUTION OF TRAINING MATERIALS IN CONNECTION THEREWITH FOR SUBJECT MATTERS AS REQUESTED BY CUSTOMERS; ENCOURAGING AMATEUR SPORTS AND PHYSICAL EDUCATION BY ORGANIZING, SANCTIONING, CONDUCTING, REGULATING AND GOVERNING AMATEUR ATHLETIC PROGRAMS AND ACTIVITIES; ENTERTAINMENT AND EDUCATION SERVICES IN THE NATURE OF A SERIES OF SHORT SHOWS FEATURING AN ACTION CHARACTER DISTRIBUTED TO MOBILE HANDSETS, WHICH MAY INCLUDE VIDEO, TEXT, PHOTOS, ILLUSTRATIONS OR HYPERTEXT; ENTERTAINMENT AND EDUCATIONAL SERVICES, NAMELY, PROVIDING ADVICE AND INFORMATION FOR MUSIC, VIDEO AND FILM CONCEPT AND SCRIPT DEVELOPMENT; ENTERTAINMENT SERVICES IN THE NATURE OF AN AMUSEMENT PARK SHOW; ENTERTAINMENT SERVICES, NAMELY, LIVE, TELEVISED AND MOVIE APPEARANCES BY A PROFESSIONAL ENTERTAINER; ENTERTAINMENT SERVICES, NAMELY, BODY PAINTING SERVICES HELD AT SPECIAL EVENTS; ENTERTAINMENT SERVICES, NAMELY, MEAD TASTINGS; ENTERTAINMENT SERVICES, NAMELY, PROVIDING PODCASTS IN THE FIELD OF ADVENTURES OF AN ACTION CHARACTER; ENTERTAINMENT SERVICES, NAMELY, PRODUCTION OF SPECIAL EFFECTS INCLUDING MODEL-MAKING SERVICES, COMPUTER-GENERATED IMAGERY AND COMPUTER-GENERATED GRAPHICS FOR THE PRODUCTION OF MOTION PICTURES, VIDEOS, AND MOVIE TRAILERS; ENTERTAINMENT, NAMELY, LIGHTING PRODUCTION; FAN CLUBS; FIGURE SALONS; FILM AND VIDEO FILM PRODUCTION; FILM AND VIDEO PRODUCTION; FILM DISTRIBUTION; FILM EDITING; MARTIAL ARTS IN-

CLASS 41—(Continued).

STRUCTION; MASTER OF CEREMONY SERVICES FOR PARTIES AND SPECIAL EVENTS; MODELING FOR ARTISTS; MOVIE THEATERS; MULTIMEDIA ENTERTAINMENT SOFTWARE PRODUCTION SERVICES; ORGANIZING AND CONDUCTING A RUNNING EVENT THE PROCEEDS OF WHICH ARE DONATED TO CHARITY; PRESENTATION OF MUSICAL PERFORMANCE; PRODUCING ONGOING TELEVISION PROGRAMS ON BLACKJACK CARD TOURNAMENTS; PRODUCTION AND DISTRIBUTION OF MOTION PICTURES; PRODUCTION OF CABLE TELEVISION PROGRAMS; PRODUCTION OF DVDS, VIDEOTAPES AND TELEVISION PROGRAMS FEATURING AN ACTION CHARACTER; PRODUCTION OF TELEVISION PROGRAMS; PRODUCTION OF VIDEO DISCS FOR OTHERS; PRODUCTION OF VIDEO CASSETTES; PRODUCTION OF VIDEO AND CREATION OF VISUAL EFFECTS FOR OTHERS FOR USE IN DVDS, TELEVISION PROGRAMS AND ON WEB SITES; PRODUCTION OF VIDEO DISCS AND TAPES; VIDEO RECORDING OF PERSONAL GENEALOGICAL DOCUMENTARIES (U.S. CLS. 100, 101 AND 107).

KARANENDRA S. CHHINA, EXAMINING ATTORNEY

SN 77-586,883. AUTOLIV DEVELOPMENT AB, VARGARDA, SWEDEN, FILED 10-7-2008.

LEAN PRACTICE IN ACTION

THE MARK CONSISTS OF STANDARD CHARACTERS WITHOUT CLAIM TO ANY PARTICULAR FONT, STYLE, SIZE, OR COLOR.

FOR EDUCATION SERVICES, NAMELY, PROVIDING WORKSHOPS IN THE FIELDS OF LEAN MANUFACTURING, PRODUCTIVITY, AND PERFORMANCE AND PROCESS IMPROVEMENT (U.S. CLS. 100, 101 AND 107).
PAUL E. FAHRENKOPF, EXAMINING ATTORNEY

SN 77-590,652. AGT CRUNCH ACQUISITION LLC, NEW YORK, NY. FILED 10-10-2008.

GUNS

THE MARK CONSISTS OF STANDARD CHARACTERS WITHOUT CLAIM TO ANY PARTICULAR FONT, STYLE, SIZE, OR COLOR.

FOR PHYSICAL FITNESS CONDITIONING CLASSES (U.S. CLS. 100, 101 AND 107).
BERYL GARDNER, EXAMINING ATTORNEY

CLASS 41—(Continued).

SN 77-593,064. INTEGRATED SERVICES, INC., DALLAS, TX. FILED 10-15-2008.

Luncheonar

THE MARK CONSISTS OF STANDARD CHARACTERS WITHOUT CLAIM TO ANY PARTICULAR FONT, STYLE, SIZE, OR COLOR.

FOR CONDUCTING LIVE OR ON-LINE WORKSHOPS, MEETINGS, AND SEMINARS DURING THE LUNCH HOUR AND/OR OVER THE COURSE OF LUNCH IN THE FIELDS OF INFORMATION TECHNOLOGY AND DATA MANAGEMENT (U.S. CLS. 100, 101 AND 107).

FIRST USE 10-1-2003; IN COMMERCE 10-1-2003.
FRED MANDIR, EXAMINING ATTORNEY

SN 78-681,702. UNIVERSITY OF NORTH CAROLINA AT CHAPEL HILL, CHAPEL HILL, NC. FILED 7-29-2005.

THE KNOWLEDGE TRUST

THE MARK CONSISTS OF STANDARD CHARACTERS WITHOUT CLAIM TO ANY PARTICULAR FONT, STYLE, SIZE, OR COLOR.

NO CLAIM IS MADE TO THE EXCLUSIVE RIGHT TO USE "KNOWLEDGE", APART FROM THE MARK AS SHOWN.

FOR EDUCATIONAL SERVICES, NAMELY, PROVIDING CLASSES, WORKSHOPS, SYMPOSIUMS, SEMINARS, CONFERENCES AND WORKSHOPS FEATURING INFORMATION ABOUT THE ORGANIZATION, MANAGEMENT, ACCESS TO AND DISSEMINATION OF RECORDED KNOWLEDGE (U.S. CLS. 100, 101 AND 107).

JOHN KELLY, EXAMINING ATTORNEY

SN 78-827,634. ASSOCIATION OF WALDORF SCHOOLS OF NORTH AMERICA, MINNEAPOLIS, MN. FILED 3-2-2006.

RUDOLF STEINER

THE MARK CONSISTS OF STANDARD CHARACTERS WITHOUT CLAIM TO ANY PARTICULAR FONT, STYLE, SIZE, OR COLOR.

THE NAME SHOWN IN THE MARK DOES NOT IDENTIFY A PARTICULAR LIVING INDIVIDUAL.

SEC. 2(F).

FOR EDUCATIONAL SERVICES, NAMELY, PROVIDING COURSES OF INSTRUCTION AT THE PRIMARY AND SECONDARY LEVEL, AND TEACHER TRAINING AND TEACHER EDUCATION AT THE POST-SECONDARY LEVEL, ALL FOLLOWING THE INDICATIONS OF THE FOUNDER OF THE ANTHROPOPHICAL MOVEMENT (U.S. CLS. 100, 101 AND 107).

FIRST USE 1-1-1928; IN COMMERCE 1-1-1928.
COLLEEN KEARNEY, EXAMINING ATTORNEY

CLASS 41—(Continued).

SN 79-048,568. THE UNIVERSITY OF MELBOURNE, AUSTRALIA, FILED 8-30-2007.



OWNER OF INTERNATIONAL REGISTRATION 0949719 DATED 8-30-2007, EXPIRES 8-30-2017.

THE ENGLISH TRANSLATION OF THE WORD "POSTERA CRESCAM LAUDE" IN THE MARK IS "EVER NEW MY FAME SHALL GROW".

FOR PROVIDING FACILITIES OR SERVICES FOR STUDY, EDUCATION, TEACHING AND TRAINING, NAMELY, ARRANGING AND CONDUCTING OF COURSES OF INSTRUCTION, EDUCATIONAL COLLOQUIUMS, CONFERENCES, CONGRESSES, SEMINARS AND SYMPOSIUMS AT THE UNDERGRADUATE, GRADUATE AND POST GRADUATE LEVEL; PRODUCTION OF AUDIOVISUAL EDUCATIONAL AIDS, NAMELY, VIDEOTAPES, VIDEO DISCS, AND AUDIO VISUAL RECORDINGS; CONDUCTING DISTANCE LEARNING INSTRUCTION AT THE COLLEGE AND GRADUATE LEVELS; LIBRARIES; ONLINE ACADEMIC LIBRARY SERVICES; ENTERTAINMENT IN THE NATURE OF, ORGANIZING INTERCOLLEGIATE AND INTRAMURAL SPORTING EVENTS AND CLUBS, NAMELY, ORGANIZING BASEBALL, BASKETBALL, CRICKET, CYCLING, DANCE, FENCING, FOOTBALL, HOCKEY, CREW, GYMNASTICS, FENCING, LACROSSE, MARTIAL ARTS, MOUNTAINEERING, SOCCER, ROWING, RUGBY, SOFTBALL, SKATING, SQUASH, SWIMMING, TABLE TENNIS, VOLLEYBALL, WATER POLO, WEIGHTLIFTING, WRESTLING AND TRACK AND FIELD EVENTS; ORGANIZING CULTURAL, DRAMATIC, MUSICAL AND ARTISTIC EVENTS, NAMELY, PRESENTATION OF LIVE SHOW PERFORMANCES, ARRANGING AND CONDUCTING CONCERTS AND ART EXHIBITIONS; PUBLICATION OF BOOKS AND TEXTS (U.S. CLS. 100, 101 AND 107).

ROBERT STRUCK, EXAMINING ATTORNEY

CLASS 42—SCIENTIFIC AND COMPUTER SERVICES

SN 76-690,104. HOBSONS, INC., CINCINNATI, OH. FILED 5-29-2008.

CONNECT

THE MARK CONSISTS OF STANDARD CHARACTERS WITHOUT CLAIM TO ANY PARTICULAR FONT, STYLE, SIZE, OR COLOR.

OWNER OF U.S. REG. NO. 3,214,171.
SEC. 2(F).

FOR HOSTING THE WEB SITES OF OTHERS ON A COMPUTER SERVER FOR A GLOBAL COMPUTER NETWORK, NAMELY, FOR COLLEGES AND UNIVERSITIES, AND FOR COLLEGE STUDENTS AND STUDENT PROSPECTS; COMPUTER-BASED SERVICES, NAMELY, COMPUTER PROGRAMMING, DEVELOPING, IMPLEMENTING, AND PROVIDING A NON-DOWNLOADABLE WEB-BASED APPLICATION PROGRAM FOR OTHERS FOR AUTOMATING COLLEGE ADMISSIONS OFFICES AND FOR COMMUNICATING WITH PROSPECTIVE STUDENTS OVER A WORLD WIDE NETWORK OF COMPUTERS; COMPUTER-BASED SERVICES, NAMELY, COMPUTER PROGRAMMING, DEVELOPING, IMPLEMENTING, AND PROVIDING A NON-DOWNLOADABLE WEB-BASED APPLICATION PROGRAM FOR OTHERS FOR GENERATING REPORTS, CREATING INDIVIDUALLY-TAILORED STUDENT INTEREST FORMS AND EVENT RESPONSE FORMS, IMPORTING STUDENT PROSPECT DATA FROM STUDENT INFORMATION SYSTEMS, TESTING SERVICES, AND OTHER SOURCES, SCHEDULING AND TRACKING TARGETED MAILINGS AND EMAIL CAMPAIGNS, CONDUCTING SURVEYS THAT MEASURE COMMUNICATION EFFECTIVENESS, AND GENERATING REPORTS AND FREQUENCY TABULATIONS FROM THE SURVEY DATA; COMPUTER-BASED SERVICES, NAMELY, COMPUTER PROGRAMMING, DEVELOPING, IMPLEMENTING, AND PROVIDING A NON-DOWNLOADABLE WEB-BASED APPLICATION PROGRAM FOR OTHERS FOR PROVIDING INFORMATION AND ADVICE TO STUDENTS AND THEIR PARENTS REGARDING THE COLLEGE ADMISSIONS PROCESS (U.S. CLS. 100 AND 101).

FIRST USE 10-1-2002; IN COMMERCE 10-1-2002.
INGA ERVIN, EXAMINING ATTORNEY

SN 77-000,231. ENDURAQUEST, LLC, SAN ANSELMO, CA.
FILED 9-15-2006.

EnduraQuest

THE COLOR(S) BLUE AND ORANGE IS/ARE CLAIMED AS A FEATURE OF THE MARK.

THE MARK CONSISTS OF FIRST HALF OF MARK "ENDURA" IN BLUE AND SECOND HALF "QUEST" IN ORANGE.

FOR PROVIDING ON-LINE NON-DOWNLOADABLE SOFTWARE FOR SPORTS COACHES AND ATHLETES IN THE NATURE OF A CALENDAR THAT SCHEDULES TRAINING AND PRESCRIBES EXERCISE (U.S. CLS. 100 AND 101).

KIM SAITO, EXAMINING ATTORNEY

CLASS 42—(Continued).

SN 77-004,878. URBAN MAPPING, INC., SAN FRANCISCO, VA. FILED 9-21-2006.

URBANWARE

THE MARK CONSISTS OF STANDARD CHARACTERS WITHOUT CLAIM TO ANY PARTICULAR FONT, STYLE, SIZE, OR COLOR.

FOR PROVIDING DATABASES FEATURING MAPS, SCIENTIFIC MAP DATA AND GEOSPATIAL INFORMATION (U.S. CLS. 100 AND 101).

FIRST USE 9-0-2005; IN COMMERCE 10-15-2005.
LEIGH LOWRY, EXAMINING ATTORNEY

CLASS 42—(Continued).

SN 77-378,603. SLIDE, INC., SAN FRANCISCO, CA. FILED 1-23-2008.

Throw a Sheep

THE MARK CONSISTS OF STANDARD CHARACTERS WITHOUT CLAIM TO ANY PARTICULAR FONT, STYLE, SIZE, OR COLOR.

FOR PROVIDING ON-LINE NON-DOWNLOADABLE SOFTWARE FOR THE ENHANCEMENT OF THE EXPERIENCE OF ONLINE BROWSING OF PRODUCTS AND SERVICES AND SHOPPING BY ALLOWING USERS TO DELIVER AND RECEIVE RECOMMENDATIONS, REVIEWS AND ADVICE ON SOCIAL NETWORKING SITES, AND PROVIDING ON-LINE NON-DOWNLOADABLE COMPUTER PROGRAMS FOR SENDING, CREATING, RECEIVING, CUSTOMIZING AND PERSONALIZING DIGITAL IMAGES, COMPUTER GRAPHICS, TEXT, METADATA, VIDEO AND PHOTOGRAPHS, AND HYPERLINKS AND HYPERLINKED FILES, VIA A COMPUTER AND COMMUNICATIONS NETWORK (U.S. CLS. 100 AND 101).

SIMON TENG, EXAMINING ATTORNEY

SN 77-381,230. RECIPE RX, INC., DBA RECIPE RX, INC., SANTA BARBARA, CA. FILED 1-25-2008.

RECIPE RX

THE MARK CONSISTS OF STANDARD CHARACTERS WITHOUT CLAIM TO ANY PARTICULAR FONT, STYLE, SIZE, OR COLOR.

NO CLAIM IS MADE TO THE EXCLUSIVE RIGHT TO USE "RECIPE", APART FROM THE MARK AS SHOWN.

FOR SCIENTIFIC RESEARCH AND DEVELOPMENT IN THE FIELD OF DIET, HEALTH, HEALING, DISEASE, FOOD, RECIPES, FOOD PREPARATION, INGREDIENTS, MENUS, AND FOOD SHOPPING; DESIGN AND DEVELOPMENT OF COMPUTER SOFTWARE AND DATABASES TO DELIVER AND MAKE AVAILABLE RESULTS OF RESEARCH IN THE ABOVE CATEGORIES (U.S. CLS. 100 AND 101).

FIRST USE 9-27-2007; IN COMMERCE 9-27-2007.
GRETTA YAO, EXAMINING ATTORNEY

SN 77-344,176. AE&E CORP., LIVONIA, MI. FILED 12-4-2007.

I NEED SECURITY

THE MARK CONSISTS OF STANDARD CHARACTERS WITHOUT CLAIM TO ANY PARTICULAR FONT, STYLE, SIZE, OR COLOR.

NO CLAIM IS MADE TO THE EXCLUSIVE RIGHT TO USE "SECURITY", APART FROM THE MARK AS SHOWN.

FOR CONSULTING SERVICES IN THE FIELD OF COMPUTERS, SOFTWARE AND COMPUTER NETWORKS FOR OTHERS; COMPUTER AND DATA PROTECTION SERVICES, NAMELY, VIRUS PROTECTION, DATA BACK UP AND RECOVERY SERVICES; COMPUTER AND DATA SECURITY SERVICES, NAMELY, RESTRICTING ACCESS TO COMPUTER NETWORKS, WEB SITES AND INDIVIDUALS; AND MAINTAINING AND DESIGNING WEB SITES FOR OTHERS (U.S. CLS. 100 AND 101).

FIRST USE 5-30-2003; IN COMMERCE 5-30-2003.
GINA FINK, EXAMINING ATTORNEY

SN 77-390,914. STOLEN BASES, LLC, NEW YORK, NY. FILED 2-7-2008.

WISH YOU WERE HERE

THE MARK CONSISTS OF STANDARD CHARACTERS WITHOUT CLAIM TO ANY PARTICULAR FONT, STYLE, SIZE, OR COLOR.

FOR CUSTOM CREATION OF POSTCARDS (U.S. CLS. 100 AND 101).

MICHAEL WIENER, EXAMINING ATTORNEY

CLASS 42—(Continued).

SN 77-390,930. STOLEN BASES, LLC, NEW YORK, NY. FILED 2-7-2008.

WYWH

THE MARK CONSISTS OF STANDARD CHARACTERS WITHOUT CLAIM TO ANY PARTICULAR FONT, STYLE, SIZE, OR COLOR.

FOR CUSTOM CREATION OF POSTCARDS (U.S. CLS. 100 AND 101).

MICHAEL WIENER, EXAMINING ATTORNEY

SN 77-400,072. IE DISCOVERY, INC., AUSTIN, TX. FILED 2-19-2008.

REVIEWDOX

THE MARK CONSISTS OF STANDARD CHARACTERS WITHOUT CLAIM TO ANY PARTICULAR FONT, STYLE, SIZE, OR COLOR.

FOR COMPUTER SERVICES, NAMELY, PROVIDING TECHNOLOGY PLATFORM INTEGRATING HARDWARE AND SOFTWARE FOR MANAGING THE PROCESS OF LEGAL DOCUMENT REVIEW, ENABLING SECURE ON-LINE REVIEW OF IMAGES, TEXT, ELECTRONIC FILES, AND OTHER RELATED DATA, AND TRACKING AND REPORTING WORKFLOW TO ASSIST IN MANAGEMENT OF REVIEW PROCESS (U.S. CLS. 100 AND 101).

FIRST USE 10-13-2003; IN COMMERCE 10-13-2003.

DARRYL SPRUILL, EXAMINING ATTORNEY

SN 77-400,881. THE PRODUCTION NETWORK, INC., SEATTLE, WA. FILED 2-19-2008.

THE PRODUCTION NETWORK

THE MARK CONSISTS OF STANDARD CHARACTERS WITHOUT CLAIM TO ANY PARTICULAR FONT, STYLE, SIZE, OR COLOR.

SEC. 2(F).

FOR DESIGNING THEME GRAPHICS AND MULTIMEDIA SHOWS FOR CONVENTIONS, PRODUCT LAUNCHES, TRADE SHOWS, KEY NOTE ADDRESSES AND AWARD CEREMONIES FOR OTHERS (U.S. CLS. 100 AND 101).

FIRST USE 10-12-1989; IN COMMERCE 10-12-1989.

WILLIAM BRECKENFELD, EXAMINING ATTORNEY

CLASS 42—(Continued).

SN 77-401,716. THOMSON REUTERS (TAX & ACCOUNTING) INC., CARROLLTON, TX. FILED 2-20-2008.

WEB BUILDER CS

THE MARK CONSISTS OF STANDARD CHARACTERS WITHOUT CLAIM TO ANY PARTICULAR FONT, STYLE, SIZE, OR COLOR.

NO CLAIM IS MADE TO THE EXCLUSIVE RIGHT TO USE "WEB BUILDER", APART FROM THE MARK AS SHOWN.

FOR PROVIDING ASSISTANCE TO ACCOUNTING FIRMS WITH WEBSITE BUILDING, NAMELY, WEBSITE DESIGN AND HOSTING OF WEBSITES (U.S. CLS. 100 AND 101).

FIRST USE 4-30-2005; IN COMMERCE 4-30-2005.

SANI KHOURI, EXAMINING ATTORNEY

SN 77-402,182. MEGICA CORPORATION, HSINCHU, TAIWAN, FILED 2-20-2008.

Freeway

THE MARK CONSISTS OF STANDARD CHARACTERS WITHOUT CLAIM TO ANY PARTICULAR FONT, STYLE, SIZE, OR COLOR.

OWNER OF U.S. REG. NO. 2,666,614.

SEC. 2(F).

FOR DESIGN FOR OTHERS OF INTEGRATED CIRCUITS AND INTEGRATED CIRCUIT CORES FOR USE IN WIRELESS COMMUNICATIONS AND WIRELESS COMMUNICATION EQUIPMENT AND APPARATI AND DIGITAL SIGNAL PROCESSORS (DSP); DESIGN OF COMPUTER HARDWARE, INTEGRATED CIRCUITS, COMMUNICATIONS HARDWARE AND SOFTWARE AND COMPUTER NETWORKS FOR OTHERS (U.S. CLS. 100 AND 101).

FIRST USE 12-13-2001; IN COMMERCE 12-24-2002.

BARBARA BROWN, EXAMINING ATTORNEY

SN 77-403,774. PAIR NETWORKS, INC., PITTSBURGH, PA. FILED 2-22-2008.

REDHOSTING

THE MARK CONSISTS OF STANDARD CHARACTERS WITHOUT CLAIM TO ANY PARTICULAR FONT, STYLE, SIZE, OR COLOR.

FOR HOSTING THE WEB SITES OF OTHERS ON A COMPUTER SERVER FOR A GLOBAL COMPUTER NETWORK (U.S. CLS. 100 AND 101).

PAUL E. FAHRENKOPF, EXAMINING ATTORNEY

CLASS 42—(Continued).

SN 77-407,305. OMNICOMM SYSTEMS, INC., FORT LAUDERDALE, FL. FILED 2-27-2008.

OMNIVAL

THE MARK CONSISTS OF STANDARD CHARACTERS WITHOUT CLAIM TO ANY PARTICULAR FONT, STYLE, SIZE, OR COLOR.

FOR LABORATORY RESEARCH IN THE FIELD OF CLINICAL TRIALS DATA, NAMELY, VALIDATION OF CLINICAL LAB TEST RESULTS OBTAINED IN CONJUNCTION WITH THE USE OF LICENSED SOFTWARE; MEDICAL AND SCIENTIFIC RESEARCH IN THE FIELD OF CLINICAL AND MEDICAL THERAPIES, NAMELY, VALIDATION OF CLINICAL LAB TEST RESULTS OBTAINED IN CONJUNCTION WITH THE USE OF LICENSED SOFTWARE (U.S. CLS. 100 AND 101).

JOHN DALIER, EXAMINING ATTORNEY

SN 77-407,347. OMNICOMM SYSTEMS, INC., FORT LAUDERDALE, FL. FILED 2-27-2008.

OMNIHOST

THE MARK CONSISTS OF STANDARD CHARACTERS WITHOUT CLAIM TO ANY PARTICULAR FONT, STYLE, SIZE, OR COLOR.

FOR APPLICATION SERVICE PROVIDER, NAMELY, HOSTING COMPUTER SOFTWARE APPLICATIONS OF OTHERS (U.S. CLS. 100 AND 101).

JOHN DALIER, EXAMINING ATTORNEY

SN 77-411,987. DOCTATIONS, INC., GARDEN CITY, NY. FILED 3-3-2008.

PHYSICIAN COCKPIT

THE MARK CONSISTS OF STANDARD CHARACTERS WITHOUT CLAIM TO ANY PARTICULAR FONT, STYLE, SIZE, OR COLOR.

NO CLAIM IS MADE TO THE EXCLUSIVE RIGHT TO USE "PHYSICIAN", APART FROM THE MARK AS SHOWN.

FOR PROVIDING ON-LINE NON-DOWNLOADABLE SOFTWARE FOR COMMUNICATING WITH AND MANAGING THE PATIENT POPULATION FOR WHICH A DOCTOR IS RESPONSIBLE; APPLICATION SERVICE PROVIDER (ASP) FEATURING SOFTWARE FOR USE IN COMMUNICATING WITH AND MANAGING THE PATIENT POPULATION FOR WHICH A DOCTOR IS RESPONSIBLE; PROVIDING TEMPORARY USE OF ON-LINE NON-DOWNLOADABLE SOFTWARE FOR COMMUNICATING WITH AND MANAGING THE PATIENT POPULATION FOR WHICH A DOCTOR IS RESPONSIBLE (U.S. CLS. 100 AND 101).

ZACHARY BELLO, EXAMINING ATTORNEY

CLASS 42—(Continued).

SN 77-412,006. DOCTATIONS, INC., GARDEN CITY, NY. FILED 3-3-2008.

WIHCC WEB INTEGRATED HEALTH CARE COMMUNITY

THE MARK CONSISTS OF STANDARD CHARACTERS WITHOUT CLAIM TO ANY PARTICULAR FONT, STYLE, SIZE, OR COLOR.

NO CLAIM IS MADE TO THE EXCLUSIVE RIGHT TO USE "WEB INTEGRATED HEALTH CARE COMMUNITY", APART FROM THE MARK AS SHOWN.

FOR PROVIDING ON-LINE NON-DOWNLOADABLE SOFTWARE FOR EFFICIENTLY GENERATING, MANAGING AND EXCHANGING MEDICAL INFORMATION AND DOCUMENTS, COMMUNICATING SYNCHRONOUSLY AND ASYNCHRONOUSLY AND CONNECTING PHYSICIANS AND THEIR PATIENTS REGARDLESS OF MEDICAL ORGANIZATION OR GEOGRAPHIC LOCATION; APPLICATION SERVICE PROVIDER (ASP) FEATURING SOFTWARE FOR USE IN EFFICIENTLY GENERATING, MANAGING AND EXCHANGING MEDICAL INFORMATION AND DOCUMENTS, COMMUNICATING SYNCHRONOUSLY AND ASYNCHRONOUSLY AND CONNECTING PHYSICIANS AND THEIR PATIENTS REGARDLESS OF MEDICAL ORGANIZATION OR GEOGRAPHIC LOCATION; PROVIDING TEMPORARY USE OF ON-LINE NON-DOWNLOADABLE SOFTWARE FOR EFFICIENTLY GENERATING, MANAGING AND EXCHANGING MEDICAL INFORMATION AND DOCUMENTS, COMMUNICATING SYNCHRONOUSLY AND ASYNCHRONOUSLY AND CONNECTING PHYSICIANS AND THEIR PATIENTS REGARDLESS OF MEDICAL ORGANIZATION OR GEOGRAPHIC LOCATION; PROVIDING A WEBSITE FOR USE BY PHYSICIANS TO GENERATE, MANAGE AND EXCHANGE MEDICAL INFORMATION AND DOCUMENTS REGARDLESS OF MEDICAL ORGANIZATION OR GEOGRAPHIC LOCATION (U.S. CLS. 100 AND 101).

ZACHARY BELLO, EXAMINING ATTORNEY

SN 77-415,886. ARIXMEDIA, LLC, BRENTWOOD, TN. FILED 3-7-2008.



NO CLAIM IS MADE TO THE EXCLUSIVE RIGHT TO USE "FREE CSS TEMPLATES.ORG", APART FROM THE MARK AS SHOWN.

THE MARK CONSISTS OF THE STYLIZED WORDING "FREECSSTEMPLATES.ORG" HAVING THE DESIGN OF AN OUTLINE OF A THREE DIMENSIONAL PIECE OF PAPER WITH A CURVED CORNER BEHIND THE LETTERS "CSS".

FOR COMPUTER GRAPHICS SERVICES AND GRAPHIC DESIGN SERVICES, NAMELY, PROVIDING READY-TO-USE WEB SITE TEMPLATES AND WEB GRAPHICS VIA THE INTERNET (U.S. CLS. 100 AND 101).

FIRST USE 3-6-2008; IN COMMERCE 3-6-2008. JAY BESCH, EXAMINING ATTORNEY

CLASS 42—(Continued).

SN 77-419,402. HCC CORPORATION, AUSTIN, TX. FILED 3-11-2008.

Create A Remarkable Experience

THE MARK CONSISTS OF STANDARD CHARACTERS WITHOUT CLAIM TO ANY PARTICULAR FONT, STYLE, SIZE, OR COLOR.

FOR APPLICATION SERVICE PROVIDER (ASP) FEATURING TECHNOLOGY THAT ENABLES COMPANIES AND ORGANIZATIONS TO ADMINISTER AND MANAGE EMPLOYEE INCENTIVE AWARD PROGRAMS AND TO PROMOTE EMPLOYEE PRODUCTIVITY, PERFORMANCE, RECOGNITION AND MORALE (U.S. CLS. 100 AND 101).

FIRST USE 12-1-2005; IN COMMERCE 1-4-2006.
ZACHARY BELLO, EXAMINING ATTORNEY

SN 77-426,074. AKF ENGINEERS, LLP, NEW YORK, NY. FILED 3-19-2008.

AKF GROUP

THE MARK CONSISTS OF STANDARD CHARACTERS WITHOUT CLAIM TO ANY PARTICULAR FONT, STYLE, SIZE, OR COLOR.

OWNER OF U.S. REG. NO. 2,894,621.

NO CLAIM IS MADE TO THE EXCLUSIVE RIGHT TO USE "GROUP", APART FROM THE MARK AS SHOWN.

FOR CONSULTING ENGINEERING, NAMELY, TECHNICAL CONSULTING IN THE FIELD OF ENGINEERING (U.S. CLS. 100 AND 101).

BARBARA BROWN, EXAMINING ATTORNEY

SN 77-426,213. AKF ENGINEERS, LLP, NEW YORK, NY. FILED 3-19-2008.

OWNER OF U.S. REG. NO. 2,894,621.
FOR CONSULTING ENGINEERING, NAMELY, TECHNICAL CONSULTING IN THE FIELD OF ENGINEERING (U.S. CLS. 100 AND 101).

FIRST USE 2-4-2008; IN COMMERCE 2-4-2008.
BARBARA BROWN, EXAMINING ATTORNEY

CLASS 42—(Continued).

SN 77-431,439. JUSTICE, EDWARD R., JR., DBA EDWARD JUSTICE, JR. ENTERPRISES, DUARTE, CA. FILED 3-25-2008.

THE MARK CONSISTS OF THE LETTERS "EJJE" WITH THE SECOND "JE" TURNED BACKWARD TO CREATE A MIRROR EFFECT.

FOR GRAPHIC DESIGN SERVICES (U.S. CLS. 100 AND 101).

FIRST USE 1-1-1982; IN COMMERCE 1-1-1982.
GISELLE AGOSTO, EXAMINING ATTORNEY

SN 77-440,304. AKF ENGINEERS, LLP, NEW YORK, NY. FILED 4-4-2008.

ATKINSON KOVEN FEINBERG
ENGINEERS

THE MARK CONSISTS OF STANDARD CHARACTERS WITHOUT CLAIM TO ANY PARTICULAR FONT, STYLE, SIZE, OR COLOR.

NO CLAIM IS MADE TO THE EXCLUSIVE RIGHT TO USE "ENGINEERS", APART FROM THE MARK AS SHOWN.

FOR CONSULTING ENGINEERING, NAMELY, TECHNICAL CONSULTING IN THE FIELD OF ENGINEERING (U.S. CLS. 100 AND 101).

FIRST USE 1-0-1989; IN COMMERCE 1-0-1989.
BARBARA BROWN, EXAMINING ATTORNEY

CLASS 42—(Continued).

SN 77-442,480. DEUTSCHE TELEKOM, BONN, FED REP GERMANY, FILED 4-8-2008.

web'n'walk Stick

THE MARK CONSISTS OF STANDARD CHARACTERS WITHOUT CLAIM TO ANY PARTICULAR FONT, STYLE, SIZE, OR COLOR.

OWNER OF FED REP GERMANY REG. NO. 30758553, DATED 2-6-2008, EXPIRES 9-30-2017.

OWNER OF U.S. REG. NOS. 3,250,718, 3,257,839 AND OTHERS.

NO CLAIM IS MADE TO THE EXCLUSIVE RIGHT TO USE "STICK", APART FROM THE MARK AS SHOWN.

FOR COMPUTER PROGRAMMING SERVICES FOR OTHERS, NAMELY, DATA PROCESSING PROGRAMS FOR OTHERS; CONSULTING IN THE FIELD OF TELECOMMUNICATIONS TECHNOLOGY; RENTAL OF COMPUTER SOFTWARE AND HARDWARE FOR ON-LINE ACCESS; RENTAL OF DATA PROCESSING EQUIPMENT; DEVELOPING AND CREATING DATA PROCESSING PROGRAMS BY ORDER OF THIRD PARTIES; PROFESSIONAL CONSULTANCY IN THE FIELD OF DATA PROCESSING SOFTWARE; WEB PAGE HOSTING SERVICES; OPERATING ELECTRONIC INFORMATION TECHNOLOGY NETWORKS; CUSTOM DESIGN SERVICES OF TELEPHONE SYSTEMS AND GLOBAL TELECOMMUNICATIONS NETWORKS; CONSULTING SERVICES IN THE FIELD OF COMPUTER SOFTWARE PROGRAMMING AND DESIGN; INSTALLATION, MAINTENANCE AND REPAIR OF COMPUTER SOFTWARE (U.S. CLS. 100 AND 101).

PAUL F. GAST, EXAMINING ATTORNEY

SN 77-470,020. MICHAEL WILLIAM SHAPIRO, IRVINE, CA. FILED 5-9-2008.

MYBIZZBOOK.COM

THE MARK CONSISTS OF STANDARD CHARACTERS WITHOUT CLAIM TO ANY PARTICULAR FONT, STYLE, SIZE, OR COLOR.

FOR PROVIDING A WEB SITE THAT GIVES COMPUTER USERS THE ABILITY TO UPLOAD AND SHARE USER-GENERATED VIDEOS, ESSAYS AND ARTICLES ON A WIDE VARIETY OF TOPICS AND SUBJECTS; AND HOSTING AN ON-LINE COMMUNITY WEB SITE FEATURING USER-DEFINED INFORMATION, BUSINESS INFORMATION AND PERSONAL PROFILES FOR FACILITATING BUSINESS-TO-BUSINESS, BUSINESS-TO-PERSON, AND PERSON-TO-PERSON NETWORKING AND INTERACTION, WITH LINKS BETWEEN USER-CUSTOMIZED WEB PAGES, AS WELL AS THE WEB-SITES OF OTHERS (U.S. CLS. 100 AND 101).

MARGARET POWER, EXAMINING ATTORNEY

CLASS 42—(Continued).

SN 77-507,210. FITSKIING, INC., DURHAM, NC. FILED 6-24-2008.

MY SKI COACH

THE MARK CONSISTS OF STANDARD CHARACTERS WITHOUT CLAIM TO ANY PARTICULAR FONT, STYLE, SIZE, OR COLOR.

NO CLAIM IS MADE TO THE EXCLUSIVE RIGHT TO USE "SKI COACH", APART FROM THE MARK AS SHOWN.

FOR PROVIDING TEMPORARY USE OF NON-DOWNLOADABLE SOFTWARE FOR USE IN FITNESS TRAINING (U.S. CLS. 100 AND 101).

FIRST USE 7-25-2007; IN COMMERCE 4-28-2008.

MARTHA SANTOMARTINO, EXAMINING ATTORNEY

SN 77-518,376. VISIBLE MEASURES CORP., BOSTON, MA. FILED 7-9-2008.

VIRAL REACH DATABASE

THE MARK CONSISTS OF STANDARD CHARACTERS WITHOUT CLAIM TO ANY PARTICULAR FONT, STYLE, SIZE, OR COLOR.

NO CLAIM IS MADE TO THE EXCLUSIVE RIGHT TO USE "VIRAL" AND "DATABASE", APART FROM THE MARK AS SHOWN.

FOR PROVIDING ON-LINE NON-DOWNLOADABLE SOFTWARE FOR ENABLING USERS TO QUANTIFY AND ANALYZE AUDIENCE ENGAGEMENT AND EXPERIENCE WITH INTERNET VIDEO AND INTERACTIVE ADVERTISING (U.S. CLS. 100 AND 101).

SETH A. RAPPAPORT, EXAMINING ATTORNEY

CLASS 42—(Continued).

SN 77-519,281. STEWART M AUTEN, ASHEVILLE, NC. FILED 7-10-2008.



NO CLAIM IS MADE TO THE EXCLUSIVE RIGHT TO USE "GOING GREEN", APART FROM THE MARK AS SHOWN.

THE COLOR(S) GREEN AND WHITE IS/ARE CLAIMED AS A FEATURE OF THE MARK.

THE MARK CONSISTS OF CONCENTRIC CIRCLES WITH A TREE ENCLOSED IN THE INNER CIRCLES, WITH THE WORDING "PLANET EARTH GOING GREEN" AROUND THE OUTER CIRCLE. THE CIRCLES AND TREE TOP ARE GREEN ON WHITE BACKGROUND, AND THE WORDS AND TREE TRUNK ARE WHITE.

FOR TESTING, ANALYSIS AND EVALUATION OF THE GOODS AND SERVICES OF OTHERS FOR THE PURPOSE OF CERTIFICATION (U.S. CLS. 100 AND 101). FIRST USE 6-28-2008; IN COMMERCE 6-28-2008.

WILLIAM P. SHANAHAN, EXAMINING ATTORNEY

SN 77-525,341. QWEST COMMUNICATIONS INTERNATIONAL INC., DENVER, CO. FILED 7-17-2008.

TECHZILLA BY QWEST

THE MARK CONSISTS OF STANDARD CHARACTERS WITHOUT CLAIM TO ANY PARTICULAR FONT, STYLE, SIZE, OR COLOR.

FOR TECHNICAL SUPPORT SERVICES, NAMELY TROUBLESHOOTING OF COMPUTER HARDWARE AND SOFTWARE PROBLEMS; DESIGN OF COMPUTER NETWORKS FOR OTHERS; COMPUTER SOFTWARE INSTALLATION SERVICES; DETECTING, QUARANTINING AND ELIMINATING VIRUSES AND OTHER UNAUTHORIZED DATA AND PROGRAMS ON COMPUTERS (U.S. CLS. 100 AND 101).

JENNIFER VASQUEZ, EXAMINING ATTORNEY

CLASS 42—(Continued).

SN 77-526,356. NEWSOME INFORMATION SERVICES INC., HOUSTON, TX. FILED 7-18-2008.

Netsotros

THE MARK CONSISTS OF STANDARD CHARACTERS WITHOUT CLAIM TO ANY PARTICULAR FONT, STYLE, SIZE, OR COLOR.

FOR COMPUTER SOFTWARE CONSULTING SERVICES (U.S. CLS. 100 AND 101).

FIRST USE 5-1-2003; IN COMMERCE 6-1-2003.

AMY C. KEAN, EXAMINING ATTORNEY

SN 77-528,599. WEB ASSOCIATES INC., SAN LUIS OBISPO, CA. FILED 7-22-2008.



NO CLAIM IS MADE TO THE EXCLUSIVE RIGHT TO USE "STUDIOS", APART FROM THE MARK AS SHOWN.

THE MARK CONSISTS OF THE STYLIZED WORDING "LVL LEVEL STUDIOS", WITH THE LETTERS "LVL" FEATURED ABOVE THE WORDING "LEVEL STUDIOS", AND WITH THE LAST "L" IN "LVL" FEATURED IN A BACKWARDS POSITION.

FOR COMPUTER SOFTWARE DESIGN; DESIGN, CREATION, HOSTING, MAINTENANCE OF WEB SITES FOR OTHERS; WEB SITE HOSTING SERVICES (U.S. CLS. 100 AND 101).

CYNTHIA TRIPI, EXAMINING ATTORNEY

SN 77-532,897. FREEDOM FINANCE CORPORATION, DBA ADJUSTIMATE.COM, THE WOODLANDS, TX. FILED 7-28-2008.

ESTIMATIX

"An Evolutionary Method of Training That Accelerates An Adjuster Through The Learning Curve"

THE COLOR(S) RED, WHITE, AND BLUE IS/ARE CLAIMED AS A FEATURE OF THE MARK.

THE MARK CONSISTS OF THE FIRST LINE WITH THE WORD "ESTIMATIX", IN RED AND BLUE. THE FIRST 4 LETTERS IN "ESTIMATIX" ARE LISTED IN RED, AND THE LAST 5 LETTERS ARE LISTED IN BLUE. THE SECOND LINE CONSISTS OF THE WORDS "AN EVOLUTIONARY METHOD OF TRAINING THAT ACCELERATES AN ADJUSTER THROUGH THE LEARNING CURVE" IN BLUE. ALL ARE LISTED AGAINST A WHITE BACKGROUND.

FOR RESEARCH AND DEVELOPMENT OF ADVANCED LEARNING TECHNOLOGIES AND TEACHING METHODS (U.S. CLS. 100 AND 101).

FIRST USE 7-28-2008; IN COMMERCE 7-28-2008.

MARK T. MULLEN, EXAMINING ATTORNEY

CLASS 42—(Continued).

SN 77-536,844. SCHIFRIN ABBIJANE, NEW YORK, NY. FILED 8-1-2008.

ABBIJANE

THE MARK CONSISTS OF STANDARD CHARACTERS WITHOUT CLAIM TO ANY PARTICULAR FONT, STYLE, SIZE, OR COLOR.

FOR DRESS DESIGN (U.S. CLS. 100 AND 101). FIRST USE 1-1-1978; IN COMMERCE 1-1-1978. GINA HAYES, EXAMINING ATTORNEY

SN 77-540,970. WAND CORPORATION, EDEN PRAIRIE, MN. FILED 8-6-2008.

CLASS 42—(Continued).

SN 77-540,971. WAND CORPORATION, EDEN PRAIRIE, MN. FILED 8-6-2008.

QSR PRO

THE MARK CONSISTS OF STANDARD CHARACTERS WITHOUT CLAIM TO ANY PARTICULAR FONT, STYLE, SIZE, OR COLOR.

OWNER OF U.S. REG. NO. 3,471,763. NO CLAIM IS MADE TO THE EXCLUSIVE RIGHT TO USE "QSR", APART FROM THE MARK AS SHOWN.

FOR DESIGN FOR OTHERS IN THE FIELD OF COMPUTER SOFTWARE, HARDWARE, ENGINEERING, AND NETWORKS IN CONNECTION WITH COLLECTING AND STORING TRANSACTION DATA, CHANGING MENUS AND PRICES FOR FOOD, TRACKING EMPLOYEE PRODUCTIVITY, GENERATING REPORTS AND ANALYSIS OF REVENUE AND PROFITS, AND IMPROVING RESTAURANT EFFICIENCY THROUGH INTERNAL AND EXTERNAL COMPUTER NETWORKS (U.S. CLS. 100 AND 101).

MYRIAH HABEEB, EXAMINING ATTORNEY

SN 77-543,181. GONZALEZ, ADA C., DBA ADA'S INTERIOR DESIGN, INC., NEW ROCHELLE, NY. FILED 8-9-2008.

Dream Design Kit



THE MARK CONSISTS OF STANDARD CHARACTERS WITHOUT CLAIM TO ANY PARTICULAR FONT, STYLE, SIZE, OR COLOR.

NO CLAIM IS MADE TO THE EXCLUSIVE RIGHT TO USE "DESIGN KIT", APART FROM THE MARK AS SHOWN.

FOR INTERIOR DECORATING (U.S. CLS. 100 AND 101).

FIRST USE 1-15-2008; IN COMMERCE 1-15-2008. ANDREA SAUNDERS, EXAMINING ATTORNEY

OWNER OF U.S. REG. NO. 3,471,763. NO CLAIM IS MADE TO THE EXCLUSIVE RIGHT TO USE "QSR", APART FROM THE MARK AS SHOWN.

THE COLOR(S) BLUE, WHITE AND BLACK IS/ARE CLAIMED AS A FEATURE OF THE MARK.

THE MARK CONSISTS OF A GEOMETRIC SHAPES WHICH RESEMBLE THE LETTER "Q", SIMILAR TO THE DESIGN OF A BULL'S EYE, COMPRISED OF THREE CONCENTRIC CIRCLES WITH A DIAGONAL BAND AS A BREAK IN THE OUTERMOST CIRCLE REPRESENTING THE TAIL OF THE LETTER "Q". THE COLOR BLACK APPEARS IN THE PHRASE "QSR PRO"; THE COLOR WHITE APPEARS IN THE MIDDLE CONCENTRIC CIRCLE AND THE TAIL OF THE "Q"; THE COLOR BLUE APPEARS IN THE OUTERMOST CONCENTRIC CIRCLE AND THE COMPLETELY SHADED CENTER CONCENTRIC CIRCLE.

FOR DESIGN FOR OTHERS IN THE FIELD OF COMPUTER SOFTWARE, HARDWARE, NETWORKS AND ENGINEERING USED IN CONNECTION WITH COLLECTING AND STORING TRANSACTION DATA, CHANGING MENUS AND PRICES FOR FOOD, TRACKING EMPLOYEE PRODUCTIVITY, GENERATING REPORTS AND ANALYSIS OF REVENUE AND PROFITS, AND IMPROVING RESTAURANT EFFICIENCY THROUGH INTERNAL AND EXTERNAL COMPUTER NETWORKS (U.S. CLS. 100 AND 101).

MYRIAH HABEEB, EXAMINING ATTORNEY

SN 77-543,995. GIMIGO INC., MINNEAPOLIS, MN. FILED 8-11-2008.

GIMIGO

THE MARK CONSISTS OF STANDARD CHARACTERS WITHOUT CLAIM TO ANY PARTICULAR FONT, STYLE, SIZE, OR COLOR.

FOR DATA AUTOMATION AND COLLECTION SERVICES USING SOFTWARE TO COLLECT AND MANAGE PERSONAL INFORMATION (U.S. CLS. 100 AND 101).

FIRST USE 10-31-2006; IN COMMERCE 10-31-2006. KAELIE KUNG, EXAMINING ATTORNEY

CLASS 42—(Continued).

SN 77-546,885. SKENAZY, LENORE V., NEW YORK, NY.
FILED 8-14-2008.

CLASS 42—(Continued).

SN 77-549,344. NEXX LEVEL GROUP, INC., VALLEY
STREAM, NY. FILED 8-18-2008.

FREE RANGE KIDS

THE MARK CONSISTS OF STANDARD CHARACTERS WITHOUT CLAIM TO ANY PARTICULAR FONT, STYLE, SIZE, OR COLOR.

NO CLAIM IS MADE TO THE EXCLUSIVE RIGHT TO USE "KIDS", APART FROM THE MARK AS SHOWN.

FOR HOSTING AN ONLINE WEBSITE FEATURING INFORMATION ON CHILDREARING (U.S. CLS. 100 AND 101).

FIRST USE 4-7-2008; IN COMMERCE 4-7-2008.

PAUL E. FAHRENKOPF, EXAMINING ATTORNEY

NEXX LEVEL

SN 77-546,891. LINCOLN GLOBAL, INC., CITY OF INDUSTRY, CA. FILED 8-14-2008.

VE-ASSIST

THE MARK CONSISTS OF STANDARD CHARACTERS WITHOUT CLAIM TO ANY PARTICULAR FONT, STYLE, SIZE, OR COLOR.

FOR TECHNICAL SUPPORT, NAMELY, MONITORING OF NETWORK SYSTEMS FOR PIPE CUTTING EQUIPMENT FEATURING COMPUTER SOFTWARE AND COMPUTER HARDWARE FOR LIVE REMOTE ASSISTANCE AND COMMUNICATION LINK BETWEEN SERVICE CENTER AND REMOTE LOCATION, AND PIPE CUTTING MACHINES (U.S. CLS. 100 AND 101).

FIRST USE 5-5-2006; IN COMMERCE 5-5-2006.

CAROL SPILS, EXAMINING ATTORNEY

THE MARK CONSISTS OF STANDARD CHARACTERS WITHOUT CLAIM TO ANY PARTICULAR FONT, STYLE, SIZE, OR COLOR.

FOR HOSTING AN ON-LINE COMMUNITY WEB SITE FEATURING UNSIGNED MUSICAL ARTISTS AND THEIR MUSIC, AND ALLOWING USERS TO UPLOAD, DOWNLOAD, AND VOTE FOR ARTISTS' MUSIC; HOSTING AN ONLINE WEBSITE FEATURING A COMMUNITY OF UNSIGNED MUSICAL ARTISTS AND THEIR MUSIC, AND ALLOWING USERS TO UPLOAD, DOWNLOAD, AND VOTE FOR ARTISTS' MUSIC; PROVIDING A WEBSITE ALLOWING USERS TO UPLOAD AND DOWNLOAD MUSIC; PROVIDING A WEBSITE THAT GIVES USERS THE ABILITY TO CREATE CUSTOMIZED WEB PAGES FEATURING USER-DEFINED INFORMATION; PROVIDING A WEBSITE THAT GIVES USERS THE ABILITY TO CREATE CUSTOMIZED WEB PAGES FEATURING USER-DEFINED PROFILES; PROVIDING A WEBSITE THAT GIVES USERS THE ABILITY TO PURCHASE DOWNLOADABLE MUSIC; PROVIDING A WEBSITE THAT GIVES USERS THE ABILITY TO VOTE FOR THEIR FAVORITE MUSICAL ARTISTS (U.S. CLS. 100 AND 101).

ARETHA SOMERVILLE, EXAMINING ATTORNEY

CLASS 42—(Continued).

SN 77-549,439. VIRTUATRADER, LLC, ROYERSFORD, PA. FILED 8-18-2008.

Virtuatrader

THE MARK CONSISTS OF STANDARD CHARACTERS WITHOUT CLAIM TO ANY PARTICULAR FONT, STYLE, SIZE, OR COLOR.

FOR COMPUTER SOFTWARE DESIGN FOR OTHERS AND COMPUTER SERVICES, NAMELY, DESIGNING, CONSULTING, DEVELOPING, INSTALLING AND IMPLEMENTING COMPUTER SOFTWARE AND SOFTWARE APPLICATIONS TO ENABLE INTEGRATION OF ADVANCED COMMERCE, ASSET MANAGEMENT, AND ANALYTICS INTO ONLINE GAMES, VIRTUAL WORLDS, SOCIAL NETWORKS, AND WEBSITES; COMPUTER SERVICES IN THE NATURE OF CREATING AND TROUBLESHOOTING ONLINE NON-DOWNLOADABLE SOFTWARE FOR ACCESS, MANAGEMENT, BUYING, SELLING, TRADING, TRANSFER, ASSIGNMENT, AND AUCTIONING OF VIRTUAL AND REAL-WORLD ITEMS AND ASSETS, INCLUDING CURRENCIES; COMPUTER SERVICES IN THE NATURE OF CREATING AND TROUBLESHOOTING ONLINE NON-DOWNLOADABLE SOFTWARE TO ENABLE THE MANAGEMENT AND ADMINISTRATION OF ONLINE ASSET INVENTORY SYSTEMS, INCLUDING ASSET LIFECYCLE MANAGEMENT, REPORTING AND ANALYTICS, CUSTOMER PROFILING, DECISION SUPPORT, AND ORGANIZATION; COMPUTER SERVICES IN THE NATURE OF PROVIDING TEMPORARY USE OF NON-DOWNLOADABLE COMPUTER SOFTWARE FOR THE MANAGEMENT, TRANSMISSION, STORAGE, AND SHARING OF ELECTRONICALLY STORED INFORMATION ACROSS COMPUTER NETWORKS; COMPUTER SERVICES IN THE NATURE OF CREATING AN ONLINE COMMUNITY FOR USERS TO FORM VIRTUAL COMMUNITIES AND ENGAGE IN SOCIAL NETWORKING (U.S. CLS. 100 AND 101).

DAVID MILLER, EXAMINING ATTORNEY

CLASS 42—(Continued).

SN 77-549,459. VIRTUATRADER, LLC, ROYERSFORD, PA. FILED 8-18-2008.



THE COLOR(S) LIGHT GREEN, DARK GREEN, BLACK, AND WHITE IS/ARE CLAIMED AS A FEATURE OF THE MARK.

THE MARK CONSISTS OF THE WORD "VIRTUATRADER" BOUNDED IN A FLATTENED OVAL BORDER. THE LETTERING IS ALL WHITE, THOUGH THE LETTER "V" IS SHADOWED WITH DARK GREEN. THE RIGHT LEG OF THE "V" RUNS FROM THE BOTTOM OF THE OVAL TO THE TOP, SPLITTING THE OVAL. TO THE LEFT OF THE SPLIT, THE OVAL BOUNDARY IS LIGHT GREEN. TO THE RIGHT OF THE SPLIT, THE OVAL BOUNDARY IS BLACK.

FOR COMPUTER SOFTWARE DESIGN FOR OTHERS AND COMPUTER SERVICES, NAMELY, DESIGNING, CONSULTING, DEVELOPING, INSTALLING AND IMPLEMENTING COMPUTER SOFTWARE AND SOFTWARE APPLICATIONS TO ENABLE INTEGRATION OF ADVANCED COMMERCE, ASSET MANAGEMENT, AND ANALYTICS INTO ONLINE GAMES, VIRTUAL WORLDS, SOCIAL NETWORKS, AND WEBSITES; COMPUTER SERVICES IN THE NATURE OF CREATING AND TROUBLESHOOTING ONLINE NON-DOWNLOADABLE SOFTWARE FOR ACCESS, MANAGEMENT, BUYING, SELLING, TRADING, TRANSFER, ASSIGNMENT, AND AUCTIONING OF VIRTUAL AND REAL-WORLD ITEMS AND ASSETS, INCLUDING CURRENCIES; COMPUTER SERVICES IN THE NATURE OF CREATING AND TROUBLESHOOTING ONLINE NON-DOWNLOADABLE SOFTWARE TO ENABLE THE MANAGEMENT AND ADMINISTRATION OF ONLINE ASSET INVENTORY SYSTEMS, INCLUDING ASSET LIFECYCLE MANAGEMENT, REPORTING AND ANALYTICS, CUSTOMER PROFILING, DECISION SUPPORT, AND ORGANIZATION; COMPUTER SERVICES IN THE NATURE OF PROVIDING TEMPORARY USE OF NON-DOWNLOADABLE COMPUTER SOFTWARE FOR THE MANAGEMENT, TRANSMISSION, STORAGE, AND SHARING OF ELECTRONICALLY STORED INFORMATION ACROSS COMPUTER NETWORKS; COMPUTER SERVICES IN THE NATURE OF CREATING AN ONLINE COMMUNITY FOR USERS TO FORM VIRTUAL COMMUNITIES AND ENGAGE IN SOCIAL NETWORKING (U.S. CLS. 100 AND 101).

DAVID MILLER, EXAMINING ATTORNEY

SN 77-549,863. PEOPLE SEARCH MEDIA, LLC, PALO ALTO, CA. FILED 8-18-2008.



NO CLAIM IS MADE TO THE EXCLUSIVE RIGHT TO USE "PUBLIC RECORDS", APART FROM THE MARK AS SHOWN.

THE COLOR(S) PURPLE, GRAY, ORANGE AND WHITE IS/ARE CLAIMED AS A FEATURE OF THE MARK.

THE MARK CONSISTS OF THE WORDS "PUBLIC RECORDS" IN PURPLE DIVIDED BY A GRAPHIC ELEMENT IN DEPICTING A MAGNIFYING GLASS WHERE THE CIRCULAR PART IS IN GRAY AND THE HANDLE IS IN PURPLE. UNDERLINING THE WORDS "PUBLIC RECORDS" IS A GRAY BAR. THE BAR TURNS INTO FOUR ARROWS POINTING RIGHT UNDERNEATH THE "E" IN "RECORDS". TO THE RIGHT OF THE FOUR ARROWS IS AN ORANGE BAR THAT CONTAINS THE WORD "PRO" IN WHITE.

FOR SEARCHING AND RETRIEVING INFORMATION, SITES, AND OTHER RESOURCES AVAILABLE ON COMPUTER NETWORKS FOR OTHERS (U.S. CLS. 100 AND 101).

FIRST USE 6-27-2008; IN COMMERCE 6-27-2008.

WILLIAM BRECKENFELD, EXAMINING ATTORNEY

CLASS 42—(Continued).

SN 77-549,878. PEOPLE SEARCH MEDIA, LLC, PALO ALTO, CA. FILED 8-18-2008.

Public Records Pro

THE MARK CONSISTS OF STANDARD CHARACTERS WITHOUT CLAIM TO ANY PARTICULAR FONT, STYLE, SIZE, OR COLOR.

NO CLAIM IS MADE TO THE EXCLUSIVE RIGHT TO USE "PUBLIC RECORDS", APART FROM THE MARK AS SHOWN.

FOR SEARCHING AND RETRIEVING INFORMATION, SITES, AND OTHER RESOURCES AVAILABLE ON COMPUTER NETWORKS FOR OTHERS (U.S. CLS. 100 AND 101).

FIRST USE 6-27-2008; IN COMMERCE 6-27-2008.
WILLIAM BRECKENFELD, EXAMINING ATTORNEY

SN 77-549,912. PEOPLE SEARCH MEDIA, LLC, PALO ALTO, CA. FILED 8-18-2008.

Reverse Email Detective

THE MARK CONSISTS OF STANDARD CHARACTERS WITHOUT CLAIM TO ANY PARTICULAR FONT, STYLE, SIZE, OR COLOR.

OWNER OF U.S. REG. NOS. 3,425,057 AND 3,425,058.
NO CLAIM IS MADE TO THE EXCLUSIVE RIGHT TO USE "REVERSE EMAIL", APART FROM THE MARK AS SHOWN.

FOR SEARCHING AND RETRIEVING INFORMATION, SITES, AND OTHER RESOURCES AVAILABLE ON COMPUTER NETWORKS FOR OTHERS (U.S. CLS. 100 AND 101).

FIRST USE 5-17-2008; IN COMMERCE 5-17-2008.
WILLIAM BRECKENFELD, EXAMINING ATTORNEY

CLASS 42—(Continued).

SN 77-549,919. PEOPLE SEARCH MEDIA, LLC, PALO ALTO, CA. FILED 8-18-2008.



OWNER OF U.S. REG. NO. 3,425,057.

NO CLAIM IS MADE TO THE EXCLUSIVE RIGHT TO USE "REVERSE EMAIL", APART FROM THE MARK AS SHOWN.

THE COLOR(S) GRAY, ORANGE AND BLUE IS/ARE CLAIMED AS A FEATURE OF THE MARK.

THE MARK CONSISTS OF THE WORDS "REVERSE" (IN GRAY) "EMAIL" (IN ORANGE) "DETECTIVE" (IN BLUE) AND A GRAPHIC ELEMENT DEPICTING AN ENVELOPE OUTLINED IN ORANGE WITH AN ORANGE GRADIENT. UNDERLINING THE WORD "DETECTIVE" IS A GRAY GRADIENT BAR WITH TWO GRAY ARROWS FACING TO THE LEFT, THE ENVELOPE MENTIONED ABOVE, AND THEN TWO BOLD ARROWS (ALSO IN GRAY) FACING LEFT.

FOR SEARCHING AND RETRIEVING INFORMATION, SITES, AND OTHER RESOURCES AVAILABLE ON COMPUTER NETWORKS FOR OTHERS (U.S. CLS. 100 AND 101).

FIRST USE 5-17-2008; IN COMMERCE 5-17-2008.
WILLIAM BRECKENFELD, EXAMINING ATTORNEY

SN 77-551,291. PERMISSIONTV, INC., WALTHAM, MA. FILED 8-20-2008.

PERMISSIONTV

THE MARK CONSISTS OF STANDARD CHARACTERS WITHOUT CLAIM TO ANY PARTICULAR FONT, STYLE, SIZE, OR COLOR.

OWNER OF U.S. REG. NO. 3,532,489.
FOR PROVIDING TEMPORARY USE OF NON-DOWNLOADABLE COMPUTER SOFTWARE TO ENABLE VIDEO DISTRIBUTION OVER THE INTERNET (U.S. CLS. 100 AND 101).

FIRST USE 5-0-2006; IN COMMERCE 5-0-2006.
DOMINIC J. FERRAIUOLO, EXAMINING ATTORNEY

CLASS 42—(Continued).

SN 77-552,664. HORAK, MARK, NEW YORK, NY. FILED 8-21-2008.



THE MARK CONSISTS OF THE WORD "WOWSBURG" APPEARS BELOW A GRAPHIC REPRESENTATION OF A HOUSE WITH DOUBLE ELLIPTICAL SHAPES BEHIND THE HOUSE REPRESENTING THE SKY - ALL LETTERS IN "WOWSBURG" ARE SHOWN IN LOWER CASE.

FOR PROVIDING A WEB SITE THAT GIVES COMPUTER USERS THE ABILITY TO UPLOAD, EXCHANGE AND SHARE REAL ESTATE PHOTOS AND VIDEOS VIA THE INTERNET; COMPUTER SERVICES, NAMELY, HOSTING AN INTERACTIVE WEBSITE FOR ON DEMAND REAL ESTATE LISTINGS (U.S. CLS. 100 AND 101).

KIM SAITO, EXAMINING ATTORNEY

SN 77-553,479. OLD REPUBLIC NATIONAL TITLE INSURANCE COMPANY, MINNEAPOLIS, MN. FILED 8-22-2008.

OP2

THE MARK CONSISTS OF STANDARD CHARACTERS WITHOUT CLAIM TO ANY PARTICULAR FONT, STYLE, SIZE, OR COLOR.

FOR APPLICATION SERVICE PROVIDER, NAMELY, PROVIDING, HOSTING, MANAGING, DEVELOPING, AND MAINTAINING APPLICATIONS, SOFTWARE, WEB SITES, AND DATABASES IN THE FIELDS OF UNDERWRITING AND ADMINISTERING TITLE INSURANCE, REAL ESTATE CLOSINGS, EMAIL, ELECTRONIC FAXING, CALENDARING, INFORMATION TECHNOLOGY SUPPORT, DOMAIN NAME MANAGEMENT, FIREWALL MANAGEMENT, NETWORK MANAGEMENT AND PC SUPPORT (U.S. CLS. 100 AND 101).

FIRST USE 6-27-2008; IN COMMERCE 6-27-2008.
AMY KERTGATE, EXAMINING ATTORNEY

CLASS 42—(Continued).

SN 77-554,180. HOLLY, OBI, MARC, WASHINGTON, DC. FILED 8-23-2008.



THE COLOR(S) WHITE, GRAY, BLACK AND RED IS/ ARE CLAIMED AS A FEATURE OF THE MARK.

THE MARK CONSISTS OF THE WORD "I" THE DESIGN OF A HEART, AND THE NUMBER "2012" ALL ON A GRAPHICAL DISPLAY OF A T-SHIRT. THE COLOR BLACK APPEARING IN WORD "I" AND THE NUMBER "2012", THE COLOR RED APPEARING IN THE DESIGN OF A HEART, AND THE COLORS WHITE AND GRAY APPEARING IN THE GRAPHICAL DISPLAY OF A T-SHIRT.

FOR GRAPHIC ART DESIGN; GRAPHIC DESIGN (U.S. CLS. 100 AND 101).

RONALD AIKENS, EXAMINING ATTORNEY

SN 77-555,241. HOTWELL GMBH, KLINGENBACH, AUSTRIA, FILED 8-25-2008.



THE MARK CONSISTS OF IMAGE OF THE MARK "HOTWELL" WITH SOUND WAVE LINES SHOWING THE MARK AS USED IN COMMERCE.

FOR WELL LOGGING AND CONSULTING SERVICES IN THE FIELD OF GEOSCIENCES (U.S. CLS. 100 AND 101).

FIRST USE 4-3-2007; IN COMMERCE 4-3-2007.
SHANNON TWOHIG, EXAMINING ATTORNEY

CLASS 42—(Continued).

SN 77-555,758. LIME BROKERAGE LLC, NEW YORK, NY. FILED 8-26-2008.

LIME

THE MARK CONSISTS OF STANDARD CHARACTERS WITHOUT CLAIM TO ANY PARTICULAR FONT, STYLE, SIZE, OR COLOR.

FOR APPLICATION SERVICE PROVIDER FEATURING SOFTWARE FOR USE VIA COMPUTER INTERFACE OR VIA THE INTERNET TO SUPPORT ELECTRONIC SECURITIES TRADING SERVICES (U.S. CLS. 100 AND 101).

FIRST USE 11-12-2001; IN COMMERCE 11-12-2001.
NELSON SNYDER, EXAMINING ATTORNEY

SN 77-555,831. EMMIS INTERACTIVE, INC., INDIANAPOLIS, IN. FILED 8-26-2008.

GEOSTATION

THE MARK CONSISTS OF STANDARD CHARACTERS WITHOUT CLAIM TO ANY PARTICULAR FONT, STYLE, SIZE, OR COLOR.

FOR PROVISION OF ONLINE ACCESS TO NON-DOWNLOADABLE SOFTWARE FOR USE IN THE PROVISION OF CUSTOMER RELATIONSHIP MANAGEMENT SERVICES, NAMELY, GLOBAL COMPUTER NETWORK-BASED SOFTWARE ARCHITECTURE THAT PROVIDES AN ONLINE DATABASE MINING APPLICATION TO TRACK CONSUMER INTERACTION, TO TRACK BEHAVIORAL DATA WITHIN A WEBSITE, TO TRACK ACTIVITY ON A VARIETY OF WEB APPLICATIONS, TO TRACK AND MANAGE ONLINE AND MOBILE MARKETING CAMPAIGNS, TO PROVIDE DEMOGRAPHIC AND PSYCHOGRAPHIC PROFILING OF WEBSITE USERS, TO PROVIDE GEO-CODING AND GEO-MAPPING OF CUSTOMER DATA FOR PURPOSES OF CONSUMER SEGMENTATION, AND TO PROVIDE DATA SETS FOR ONLINE AND OFFLINE GEO-TARGETED MARKETING (U.S. CLS. 100 AND 101).

MARY BOAGNI, EXAMINING ATTORNEY

CLASS 42—(Continued).

SN 77-557,183. LLOYD, BRENDON H. DBA MEGALITH COMPUTERS, LOS ANGELES, CA. FILED 8-27-2008.

Megalith Computers

THE MARK CONSISTS OF STANDARD CHARACTERS WITHOUT CLAIM TO ANY PARTICULAR FONT, STYLE, SIZE, OR COLOR.

NO CLAIM IS MADE TO THE EXCLUSIVE RIGHT TO USE "COMPUTERS", APART FROM THE MARK AS SHOWN.

FOR COMPUTER CONSULTATION (U.S. CLS. 100 AND 101).

SIMON TENG, EXAMINING ATTORNEY

SN 77-558,131. DORIA, AGNES, BETHEL, CT. FILED 8-28-2008.

BabyBell

THE MARK CONSISTS OF STANDARD CHARACTERS WITHOUT CLAIM TO ANY PARTICULAR FONT, STYLE, SIZE, OR COLOR.

FOR GRAPHIC ARTS SERVICES, NAMELY, DIGITALLY MANIPULATING THE PHOTOGRAPHS OF OTHERS TO GIVE THEM A CARTOON EFFECT AND INSERTING CAPTIONS SO AS TO USE THE EDITED IMAGES TO TELL A STORY (U.S. CLS. 100 AND 101).

FIRST USE 5-15-2008; IN COMMERCE 8-15-2008.
PRISCILLA MILTON, EXAMINING ATTORNEY

SN 77-559,317. DUCHARME, MCMILLEN & ASSOCIATES, INC., FORT WAYNE, IN. FILED 8-29-2008.

TAXAUTOMATION

THE MARK CONSISTS OF STANDARD CHARACTERS WITHOUT CLAIM TO ANY PARTICULAR FONT, STYLE, SIZE, OR COLOR.

FOR COMPUTER SOFTWARE CONSULTING SERVICES (U.S. CLS. 100 AND 101).

FIRST USE 1-29-2001; IN COMMERCE 8-15-2001.

MARIA-VICTORIA SUAREZ, EXAMINING ATTORNEY

CLASS 42—(Continued).

SN 77-559,609. BLAINE, JAMES DAVID, SAN DIEGO, CA. FILED 8-31-2008.

Cost, Schedule, and Quality: Measured. Balanced. Delivered.

THE MARK CONSISTS OF STANDARD CHARACTERS WITHOUT CLAIM TO ANY PARTICULAR FONT, STYLE, SIZE, OR COLOR.

FOR COMPUTER CONSULTATION; COMPUTER HARDWARE AND SOFTWARE CONSULTING SERVICES; COMPUTER NETWORK DESIGN AND COMPUTER SOFTWARE DESIGN FOR THE SOFTWARE PRODUCT DEVELOPMENT INDUSTRY; COMPUTER PROJECT MANAGEMENT SERVICES; COMPUTER SERVICES, NAMELY, DESIGNING AND IMPLEMENTING WEB SITES FOR OTHERS; COMPUTER SOFTWARE CONSULTANCY; COMPUTER SOFTWARE CONSULTATION; CONSTRUCTION DRAFTING; CREATION AND MAINTENANCE OF WEB SITES FOR OTHERS; MEASUREMENT EVALUATIONS IN THE FIELD OF SOFTWARE PROJECT MANAGEMENT; PROVIDING QUALITY ASSURANCE SERVICES IN THE FIELD OF SOFTWARE PRODUCT DEVELOPMENT; QUALITY CONTROL FOR OTHERS; RESEARCH AND DEVELOPMENT OF NEW PRODUCTS; RESEARCH AND DEVELOPMENT OF TECHNOLOGY IN THE FIELD OF SOFTWARE PROCESS IMPROVEMENT; TECHNICAL WRITING FOR OTHERS (U.S. CLS. 100 AND 101).

FIRST USE 8-11-2008; IN COMMERCE 8-11-2008.
SKYE YOUNG, EXAMINING ATTORNEY

SN 77-561,796. ASCEND INTERACTIVE, INC., CLAREMONT, CA. FILED 9-3-2008.

GOALFORIT!

THE MARK CONSISTS OF STANDARD CHARACTERS WITHOUT CLAIM TO ANY PARTICULAR FONT, STYLE, SIZE, OR COLOR.

FOR COMPUTER SERVICES, NAMELY, HOSTING ONLINE WEB FACILITIES FOR OTHERS FOR ORGANIZING AND CONDUCTING ONLINE MEETINGS, GATHERINGS, AND INTERACTIVE DISCUSSIONS; AND COMPUTER SERVICES IN THE NATURE OF CUSTOMIZED WEB PAGES FEATURING USER-DEFINED INFORMATION, PERSONAL PROFILES AND INFORMATION (U.S. CLS. 100 AND 101).

FIRST USE 8-25-2008; IN COMMERCE 8-25-2008.
JOHN DWYER, EXAMINING ATTORNEY

CLASS 42—(Continued).

SN 77-561,854. BLASTATS, LLC, ROCKVILLE, MD. FILED 9-3-2008.



THE MARK CONSISTS OF A FOOTBALL DIVIDED BY A LIGHTNING BOLT. THE STYLIZED TEXT "BLASTATS" APPEARS BELOW.

FOR PROVIDING NON-DOWNLOADABLE SOFTWARE FOR USE IN TRACKING OF FANTASY FOOTBALL STATISTICS VIA THE INTERNET AND CELL PHONES (U.S. CLS. 100 AND 101).

FIRST USE 8-20-2008; IN COMMERCE 8-20-2008.
FRANK LATTUCA, EXAMINING ATTORNEY

SN 77-562,002. TANDUS US INC., DALTON, GA. FILED 9-4-2008.

INUNISON

THE MARK CONSISTS OF STANDARD CHARACTERS WITHOUT CLAIM TO ANY PARTICULAR FONT, STYLE, SIZE, OR COLOR.

FOR CONSULTING SERVICES IN THE FIELD OF DESIGN, SELECTION, IMPLEMENTATION AND USE OF FLOORING AND FLOOR COVERINGS; CONSULTING SERVICES, NAMELY, PROVIDING MATCHING COMBINATIONS OF FLOORING AND FLOOR COVERING FOR INTERIOR DECORATION AND DESIGN PURPOSES (U.S. CLS. 100 AND 101).

PAULA MAHONEY, EXAMINING ATTORNEY

SN 77-562,199. FULLER, GARY, DBA WHOLE EARTH SOLAR, SAN BRUNO, CA. FILED 9-4-2008.



THE COLOR(S) BLACK, WHITE, GRAY, YELLOW, LIGHT GREEN, DARK GREEN, VIOLET, DARK BLUE AND LIGHT BLUE IS/ARE CLAIMED AS A FEATURE OF THE MARK.

THE MARK CONSISTS OF THE WORDING "GRAB A

CLASS 42—(Continued).

FEW RAYS" COMBINED WITH AN IMAGE OF A STYLIZED SUN SHINING ON A SOLAR PANEL CONNECTED BY A WIRE TO A SMALLER IMAGE OF A GLOWING LIGHT BULB OVER A NIGHTTIME SKYLINE. THE COLORS CONSIST OF DARK GREEN IN THE BORDER AREA, AND A SLIGHTLY LIGHTER SHADE OF DARK GREEN IN THE SHADOW OF THE SOLAR PANEL, THE COLOR BLACK IN THE SUNGLASSES, THE MOUTH OUTLINE, THE ELECTRICAL CORD, AND THE SKYLINE, THE COLOR WHITE IN THE WORDING "GRAB A FEW RAYS", THE SKYLINE BUILDING WINDOWS AND THE CENTER OF THE LIGHT BULB, THE COLOR GRAY IN THE FRAME AND PARTITIONS OF THE SOLAR PANELS, THE COLOR YELLOW IN THE SUN, SUNRAYS AND THE MAIN PART OF THE LIGHT BULB, THE COLOR LIGHT GREEN IN THE GRASS, THE COLOR VIOLET IN THE AURA AROUND THE LIGHT BULB, THE COLOR DARK BLUE IN THE SOLAR PANELS AND THE NIGHT SKY AND THE COLOR LIGHT BLUE IN THE DAY SKY.

FOR DESIGN OF SOLAR PHOTOVOLTAIC SYSTEMS (U.S. CLS. 100 AND 101).

FIRST USE 1-27-2007; IN COMMERCE 6-12-2008.
STEVEN PEREZ, EXAMINING ATTORNEY

SN 77-562,491. UNIVERSITY OF SOUTH CAROLINA, COLUMBIA, SC. FILED 9-4-2008.

SMARTWHEELS TECHNOLOGIES

THE MARK CONSISTS OF STANDARD CHARACTERS WITHOUT CLAIM TO ANY PARTICULAR FONT, STYLE, SIZE, OR COLOR.

NO CLAIM IS MADE TO THE EXCLUSIVE RIGHT TO USE "TECHNOLOGIES", APART FROM THE MARK AS SHOWN.

FOR RESEARCH AND DEVELOPMENT OF PRODUCTS THAT ENABLE SENIOR CITIZENS TO MAINTAIN PHYSICAL MOBILITY OUTSIDE THE HOME IN ORDER TO FACILITATE INDEPENDENT LIVING (U.S. CLS. 100 AND 101).

ALLISON SCHRODY, EXAMINING ATTORNEY

SN 77-562,511. UNIVERSITY OF SOUTH CAROLINA, COLUMBIA, SC. FILED 9-4-2008.

SHARPBRAIN TECHNOLOGIES

THE MARK CONSISTS OF STANDARD CHARACTERS WITHOUT CLAIM TO ANY PARTICULAR FONT, STYLE, SIZE, OR COLOR.

NO CLAIM IS MADE TO THE EXCLUSIVE RIGHT TO USE "TECHNOLOGIES", APART FROM THE MARK AS SHOWN.

FOR RESEARCH AND DEVELOPMENT OF PRODUCTS THAT ENABLE SENIOR CITIZENS TO MAINTAIN INTELLECTUAL ACTIVITY, BRAIN HEALTH, AND MEMORY IN ORDER TO FACILITATE INDEPENDENT LIVING (U.S. CLS. 100 AND 101).

ALLISON SCHRODY, EXAMINING ATTORNEY

CLASS 42—(Continued).

SN 77-562,734. GASSERT, CHASE, RAMONA, CA. FILED 9-4-2008.

CHASE MOBILE

THE MARK CONSISTS OF STANDARD CHARACTERS WITHOUT CLAIM TO ANY PARTICULAR FONT, STYLE, SIZE, OR COLOR.

NO CLAIM IS MADE TO THE EXCLUSIVE RIGHT TO USE "MOBILE", APART FROM THE MARK AS SHOWN.

FOR COMPUTER SERVICES; NAMELY, CREATING AND MAINTAINING WEBSITES FOR OTHERS, HOSTING AND MAINTAINING ON-LINE WEBSITES FOR OTHERS, COMPUTER HARDWARE AND SOFTWARE CONSULTING SERVICES (U.S. CLS. 100 AND 101).

FIRST USE 1-7-2008; IN COMMERCE 1-7-2008.

MARK T. MULLEN, EXAMINING ATTORNEY

SN 77-562,796. ALLIANCE FOR SUSTAINABLE ENERGY, LLC, GOLDEN, CO. FILED 9-4-2008.

ALLIANCE

THE MARK CONSISTS OF STANDARD CHARACTERS WITHOUT CLAIM TO ANY PARTICULAR FONT, STYLE, SIZE, OR COLOR.

FOR NONPROFIT RESEARCH AND CONSULTATION IN THE FIELD OF RENEWABLE ENERGY, WHICH INCLUDES THE PHYSICAL SCIENCES, BIOLOGICAL SCIENCES, MATHEMATICS, ENGINEERING SCIENCES, ECONOMICS, MANAGEMENT SCIENCES; AND, IN PARTICULAR IN RENEWABLE ENERGY SCIENCES INCLUDING RENEWABLE ELECTRICITY AND END USE SYSTEMS, PHOTOVOLTAICS, ELECTRICITY, RESOURCES, BUILDING SYSTEMS INTEGRATION, WIND TECHNOLOGY, RENEWABLE FUELS AND VEHICLES SYSTEMS, BIOENERGY, HYDROGEN TECHNOLOGY, TRANSPORTATION TECHNOLOGIES AND SYSTEMS, ENERGY SCIENCES, CHEMICAL AND BIOSCIENCES MATERIALS AND COMPUTATIONAL SCIENCE (U.S. CLS. 100 AND 101).

FIRST USE 10-1-2008; IN COMMERCE 10-1-2008.

SUSAN RICHARDS, EXAMINING ATTORNEY

CLASS 42—(Continued).

SN 77-563,506. BOND STREET LLC, PLANO, TX. FILED 9-5-2008.

ECODOC

THE MARK CONSISTS OF STANDARD CHARACTERS WITHOUT CLAIM TO ANY PARTICULAR FONT, STYLE, SIZE, OR COLOR.

FOR ON-LINE WEB SITE THAT ENABLES THE MANAGEMENT OF PRINT SYSTEMS OF OTHERS BY PROVIDING TECHNICAL MAINTENANCE AND PERFORMANCE REPORTS BASED ON DATA PROVIDED BY USERS; PRINT MANAGEMENT SERVICES, NAMELY, REMOTE MONITORING OF PRINTERS FOR OTHERS (U.S. CLS. 100 AND 101).

MAYUR VAGHANI, EXAMINING ATTORNEY

SN 77-563,646. ODDIE, ERIKA NICOLE, CHINO HILLS, CA. FILED 9-5-2008.

Mixed Minded

THE MARK CONSISTS OF STANDARD CHARACTERS WITHOUT CLAIM TO ANY PARTICULAR FONT, STYLE, SIZE, OR COLOR.

FOR COMPUTER SERVICES, NAMELY, CREATING AN ON-LINE COMMUNITY FOR REGISTERED USERS TO PARTICIPATE IN COMPETITIONS, SHOWCASE THEIR SKILLS, GET FEEDBACK FROM THEIR PEERS, FORM VIRTUAL COMMUNITIES, ENGAGE IN SOCIAL NETWORKING AND IMPROVE THEIR TALENT; COMPUTER SERVICES, NAMELY, CREATING AN ON-LINE COMMUNITY FOR REGISTERED USERS TO PARTICIPATE IN DISCUSSIONS, GET FEEDBACK FROM THEIR PEERS, FORM VIRTUAL COMMUNITIES, AND ENGAGE IN SOCIAL NETWORKING; PROVIDING A WEBSITE THAT GIVES USERS THE ABILITY TO CREATE CUSTOMIZED WEB PAGES FEATURING USER-DEFINED PROFILES (U.S. CLS. 100 AND 101).

MARK SHINER, EXAMINING ATTORNEY

SN 77-563,795. INARCH, LLC, NEW YORK, NY. FILED 9-5-2008.

INARCH

THE MARK CONSISTS OF STANDARD CHARACTERS WITHOUT CLAIM TO ANY PARTICULAR FONT, STYLE, SIZE, OR COLOR.

FOR ARCHITECTURAL CONSULTING SERVICES; ARCHITECTURAL DESIGN SERVICES; INTERIOR DESIGN CONSULTING SERVICES; INTERIOR DESIGN SERVICES (U.S. CLS. 100 AND 101).

FIRST USE 8-0-1997; IN COMMERCE 8-0-1997.
LAKEISHA LEWIS, EXAMINING ATTORNEY

CLASS 42—(Continued).

SN 77-564,054. COMSETRA LLC, JAY, OK. FILED 9-7-2008.

COMSETRA

THE MARK CONSISTS OF STANDARD CHARACTERS WITHOUT CLAIM TO ANY PARTICULAR FONT, STYLE, SIZE, OR COLOR.

FOR COMPUTER NETWORK DESIGN FOR OTHERS; COMPUTER SECURITY SERVICE, NAMELY, RESTRICTING ACCESS TO AND BY COMPUTER NETWORKS TO AND OF UNDESIREED WEB SITES, MEDIA AND INDIVIDUALS AND FACILITIES; COMPUTER SOFTWARE INSTALLATION AND MAINTENANCE; COMPUTER SYSTEMS ANALYSIS; COMPUTER SYSTEMS INTEGRATION SERVICES; COMPUTER TECHNOLOGY SUPPORT SERVICES, NAMELY, HELP DESK SERVICES; CONDUCTING ENGINEERING SURVEYS; CONDUCTING OF FEASIBILITY STUDIES; CONSULTING IN THE FIELD OF INFORMATION TECHNOLOGY; CONSULTING IN THE FIELD OF TELECOMMUNICATIONS TECHNOLOGY; DESIGN FOR OTHERS OF INTEGRATED CIRCUITS AND INTEGRATED CIRCUIT CORES FOR USE IN WIRELESS COMMUNICATIONS AND WIRELESS COMMUNICATION EQUIPMENT AND APPARATI AND DIGITAL SIGNAL PROCESSORS (DSP); DESIGN OF UNIFIED COMMUNICATIONS SERVICES; DESIGN, DEPLOYMENT AND MANAGEMENT OF WIRELESS NETWORKS FOR OTHERS; INSTALLATION, REPAIR AND MAINTENANCE OF COMPUTER SOFTWARE; INTEGRATION OF COMPUTER SYSTEMS AND NETWORKS; RESEARCH IN THE FIELD OF INTELLIGENCE AND SECURITY; RESEARCH SERVICES IN THE FIELD OF INFORMATION AND TELECOMMUNICATIONS TECHNOLOGY; TECHNICAL CONSULTING AND ASSISTANCE WITH COMPUTER-BASED INFORMATION SYSTEMS AND COMPONENTS; TECHNICAL SUPPORT SERVICES, NAMELY, TROUBLESHOOTING OF COMPUTER HARDWARE AND SOFTWARE PROBLEMS (U.S. CLS. 100 AND 101).

EDWARD NELSON, EXAMINING ATTORNEY

SN 77-564,477. ALIGNED SOFTWARE, LLC, DBA ALIGNED GLOBAL, MIAMI BEACH, FL. FILED 9-8-2008.

ALIGNED GLOBAL

THE MARK CONSISTS OF STANDARD CHARACTERS WITHOUT CLAIM TO ANY PARTICULAR FONT, STYLE, SIZE, OR COLOR.

NO CLAIM IS MADE TO THE EXCLUSIVE RIGHT TO USE "GLOBAL", APART FROM THE MARK AS SHOWN. FOR CONSULTANCY IN THE FIELD OF SOFTWARE DESIGN (U.S. CLS. 100 AND 101).

FIRST USE 5-27-2008; IN COMMERCE 5-27-2008.
DANNEAN HETZEL, EXAMINING ATTORNEY

CLASS 42—(Continued).

SN 77-564,492. KAISER, KIM, SHEPHERD, MI. FILED 9-8-2008.

DOWGIRL

THE MARK CONSISTS OF STANDARD CHARACTERS WITHOUT CLAIM TO ANY PARTICULAR FONT, STYLE, SIZE, OR COLOR.

FOR CONSULTATION SERVICES IN THE FIELDS OF INFORMATION TECHNOLOGY SYSTEMS, INTERNET SEARCH ENGINE OPTIMIZATION AND WEB SITE DESIGN (U.S. CLS. 100 AND 101).

FIRST USE 8-1-1997; IN COMMERCE 8-1-1997.

TRACY WHITTAKER-BROWN, EXAMINING ATTORNEY

SN 77-564,810. TUITIVE, LLC, INDIANAPOLIS, IN. FILED 9-8-2008.

TUITIVE

THE MARK CONSISTS OF STANDARD CHARACTERS WITHOUT CLAIM TO ANY PARTICULAR FONT, STYLE, SIZE, OR COLOR.

FOR COMPUTER SERVICES, NAMELY, RESEARCH, DESIGN AND TESTING OF USER INTERFACES FOR SOFTWARE AND OTHER TECHNOLOGIES AND DESIGN, CREATION, HOSTING AND MAINTENANCE OF WEB SITES FOR OTHERS; ADVISORY SERVICES IN THE FIELD OF PRODUCT DEVELOPMENT AND QUALITY IMPROVEMENT OF SOFTWARE; INDUSTRIAL DESIGN SERVICES (U.S. CLS. 100 AND 101).

FIRST USE 5-5-2008; IN COMMERCE 5-7-2008.

WARREN L. OLANDRIA, EXAMINING ATTORNEY

SN 77-564,900. PRACTICING SAFE TECHS, DENVER, CO. FILED 9-8-2008.

Practicing Safe Techs

THE MARK CONSISTS OF STANDARD CHARACTERS WITHOUT CLAIM TO ANY PARTICULAR FONT, STYLE, SIZE, OR COLOR.

NO CLAIM IS MADE TO THE EXCLUSIVE RIGHT TO USE "TECHS", APART FROM THE MARK AS SHOWN.

FOR DESIGN, DEVELOPMENT AND IMPLEMENTATION OF SOFTWARE (U.S. CLS. 100 AND 101).

JOHN WILKE, EXAMINING ATTORNEY

CLASS 42—(Continued).

SN 77-564,939. FAIRNESS.COM LLC, CHARLOTTESVILLE, VA. FILED 9-8-2008.

CRITWEAK

THE MARK CONSISTS OF STANDARD CHARACTERS WITHOUT CLAIM TO ANY PARTICULAR FONT, STYLE, SIZE, OR COLOR.

FOR COMPUTER SERVICES, NAMELY, HOSTING ON-LINE WEB FACILITIES FOR OTHERS FOR ORGANIZING AND CONDUCTING ONLINE MEETINGS, GATHERINGS, AND INTERACTIVE DISCUSSIONS (U.S. CLS. 100 AND 101).

FIRST USE 9-8-2008; IN COMMERCE 9-8-2008.

KATHLEEN M. VANSTON, EXAMINING ATTORNEY

SN 77-564,977. CLIENTSHOW, INC., SAN JOSE, CA. FILED 9-8-2008.

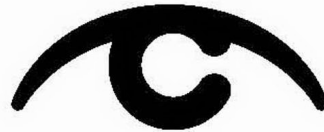

THE MARK CONSISTS OF A STYLIZED EYE DESIGN THAT CONSISTS OF AN ARC ABOVE A STYLIZED LETTER "C".

FOR APPLICATION SERVICE PROVIDER (ASP) FEATURING SOFTWARE FOR USE FOR BUSINESS INFORMATION, COLLABORATION, AND COMMUNICATION (U.S. CLS. 100 AND 101).

LINDA MICKLEBURGH, EXAMINING ATTORNEY

SN 77-565,058. WALZMAN, MICHAEL, SANTA MONICA, CA. FILED 9-8-2008.

ZMIVE

THE MARK CONSISTS OF STANDARD CHARACTERS WITHOUT CLAIM TO ANY PARTICULAR FONT, STYLE, SIZE, OR COLOR.

FOR PROVIDING A WEBSITE THAT GIVES USERS THE ABILITY TO CREATE CUSTOMIZED WEB PAGES FEATURING USER-DEFINED INFORMATION; PROVIDING A WEBSITE THAT GIVES USERS THE ABILITY TO CREATE CUSTOMIZED WEB PAGES FEATURING USER-DEFINED PROFILES; COMPUTER SERVICES, NAMELY, CREATING AN ON-LINE COMMUNITY FOR REGISTERED USERS TO PARTICIPATE IN DISCUSSIONS, GET FEEDBACK FROM THEIR PEERS, FORM VIRTUAL COMMUNITIES, AND ENGAGE IN SOCIAL NETWORKING (U.S. CLS. 100 AND 101).

LAURA KOVALSKY, EXAMINING ATTORNEY

CLASS 42—(Continued).

SN 77-565,163. DFD ARCHITECTURE, INC., TEMPE, AZ. FILED 9-8-2008.



THE MARK CONSISTS OF THE WORD "DAVIS" IN CAPITOL LETTERS WITH THE DOT OVER THE "I" AS A LINE THAT FADES AS IT MOVES UPWARD, ALL INSIDE A SQUARE.

FOR ARCHITECTURAL DESIGN SERVICES FOR OTHERS (U.S. CLS. 100 AND 101).
FIRST USE 11-30-2007; IN COMMERCE 11-30-2007.
ANDREW LEASER, EXAMINING ATTORNEY

SN 77-565,179. GBS ENTERPRISES, L.C., BONITA SPRINGS, FL. FILED 9-8-2008.

Bleeding Edge

THE MARK CONSISTS OF STANDARD CHARACTERS WITHOUT CLAIM TO ANY PARTICULAR FONT, STYLE, SIZE, OR COLOR.

FOR COMPUTER SERVICES, NAMELY, CONSULTING IN THE FIELD OF COMPUTER HARDWARE AND SOFTWARE, INTEGRATION OF COMPUTER SYSTEMS, NETWORK MANAGEMENT, INFORMATION TECHNOLOGY CONSULTATION, AND MAINTENANCE OF COMPUTER SOFTWARE FOR OTHERS, DESIGNING AND IMPLEMENTING WEB SITES FOR OTHERS, HOSTING WEB SITES FOR OTHERS, GRAPHIC DESIGN AND ANIMATION FOR OTHERS, INTERACTIVE MULTIMEDIA DESIGN, COMPUTER GRAPHICS SERVICES FEATURING 3D MODELING, AND COMPUTER SOFTWARE PROGRAMMING; DESIGN FOR NEW PRODUCT DEVELOPMENT, INDUSTRIAL DESIGN AND MEDIA DESIGN, NAMELY IMAGES, TEXTS, AUDIO AND VIDEO DATA (U.S. CLS. 100 AND 101).

FIRST USE 9-5-2008; IN COMMERCE 9-6-2008.
AISHA SALEM, EXAMINING ATTORNEY

CLASS 42—(Continued).

SN 77-565,199. CLINTON GRAHAM, MILTON, MA. FILED 9-8-2008.



NO CLAIM IS MADE TO THE EXCLUSIVE RIGHT TO USE "FITNESS", APART FROM THE MARK AS SHOWN.
THE COLOR(S) BLUE, LIGHT-BLUE AND WHITE IS/ARE CLAIMED AS A FEATURE OF THE MARK.

THE MARK CONSISTS OF THE WORDING "SNITTS THE FUTURE OF FITNESS" IN A STYLIZED FONT WITH "SNITTS" IMMEDIATELY ABOVE "THE FUTURE OF FITNESS" AND APPEARING IN THE COLOR LIGHT BLUE AND GRADUALLY CHANGING TO DARK BLUE FROM TOP TO BOTTOM. A SQUARE-SHAPED DESIGN WITH A SHINY SURFACE APPEARS TO THE LEFT OF THE WORDING AND IS COMPRISED OF TWO CONNECTED CIRCLES APPEARING BETWEEN TWO CIRCLES IN THE COLORS WHITE, LIGHT BLUE AND DARK BLUE.

FOR HOSTING AN ONLINE WEBSITE FEATURING HEALTH AND FITNESS; PROVIDING A WEBSITE THAT GIVES USERS THE ABILITY TO CREATE CUSTOMIZED WEB PAGES FEATURING USER-DEFINED PROFILES (U.S. CLS. 100 AND 101).

FIRST USE 2-26-2007; IN COMMERCE 3-21-2007.
RENEE MCCRAY, EXAMINING ATTORNEY

SN 77-565,215. HELP EACH OTHER, CORPORATION, SAN RAFAEL, CA. FILED 9-9-2008.



THE COLOR(S) BLUE, ORANGE AND WHITE IS/ARE CLAIMED AS A FEATURE OF THE MARK.

THE COLOR WHITE APPEARS ON THE WORDING "HELP" AS WELL AS HIGHLIGHTING ON THE CHAT BUBBLE SURROUNDING THE TERM "HELP"; THE COLOR BLUE APPEARS IN THE WORDING "EACH OTHER"; THE COLOR ORANGE APPEARS IN THE DEPICTION OF CHAT BUBBLE SURROUNDING THE TERM "HELP".

FOR COMPUTER SERVICES, NAMELY, CREATING AN ON-LINE COMMUNITY FOR REGISTERED USERS TO PARTICIPATE IN DISCUSSIONS, GET FEEDBACK FROM THEIR PEERS, FORM VIRTUAL COMMUNITIES, AND ENGAGE IN SOCIAL NETWORKING (U.S. CLS. 100 AND 101).

MICHAEL TANNER, EXAMINING ATTORNEY

CLASS 42—(Continued).

SN 77-565,336. COMPUTER DESIGN, INC., WHITE HOUSE, TN. FILED 9-9-2008.

Striker Systems

THE MARK CONSISTS OF STANDARD CHARACTERS WITHOUT CLAIM TO ANY PARTICULAR FONT, STYLE, SIZE, OR COLOR.

NO CLAIM IS MADE TO THE EXCLUSIVE RIGHT TO USE "SYSTEMS", APART FROM THE MARK AS SHOWN.

FOR DEVELOPMENT OF COMPUTER PROGRAMS RECORDED ON DATA MEDIA (SOFTWARE) DESIGNED FOR USE IN CONSTRUCTION AND AUTOMATED MANUFACTURING (CAD/CAM) (U.S. CLS. 100 AND 101).

FIRST USE 0-0-1989; IN COMMERCE 0-0-1989.

CHARLOTTE CORWIN, EXAMINING ATTORNEY

SN 77-565,367. SOLUTIONS MANAGEMENT GROUP, INC., BETTENDORF, IA. FILED 9-9-2008.



NO CLAIM IS MADE TO THE EXCLUSIVE RIGHT TO USE "SOLUTIONS MANAGEMENT GROUP", APART FROM THE MARK AS SHOWN.

THE COLOR(S) BLACK AND YELLOW IS/ARE CLAIMED AS A FEATURE OF THE MARK.

THE MARK CONSISTS OF A RING WITH ALTERNATING SECTIONS IN THE COLORS BLACK AND YELLOW ABOVE THE LETTERS "SMG" IN THE COLOR YELLOW OUTLINED IN THE COLOR BLACK ABOVE THE WORDS "SOLUTIONS MANAGEMENT GROUP" IN THE COLOR BLACK.

FOR COMPUTER SERVICES, NAMELY, REMOTE MANAGEMENT OF COMPUTER APPLICATIONS FOR OTHERS; CONSULTATION SERVICES IN THE FIELDS OF SELECTION, IMPLEMENTATION AND USE OF COMPUTER HARDWARE AND SOFTWARE SYSTEMS FOR OTHERS; CONSULTING SERVICES IN THE FIELD OF DESIGN, SELECTION, IMPLEMENTATION AND USE OF COMPUTER HARDWARE AND SOFTWARE SYSTEMS FOR OTHERS; PRINT MANAGEMENT SERVICES, NAMELY, REMOTE MONITORING OF PRINTERS FOR OTHERS (U.S. CLS. 100 AND 101).

FIRST USE 1-29-2003; IN COMMERCE 1-29-2003.

MICHAEL SOUDERS, EXAMINING ATTORNEY

CLASS 42—(Continued).

SN 77-565,513. PIRVUL, MATTHEW G, OCEANSIDE, CA. FILED 9-9-2008.

rEVolution

THE MARK CONSISTS OF STANDARD CHARACTERS WITHOUT CLAIM TO ANY PARTICULAR FONT, STYLE, SIZE, OR COLOR.

FOR DEVELOPMENT OF TECHNOLOGIES FOR THE FABRICATION OF CIRCUITS FOR WIRELESS COMMUNICATION, ELECTRONIC DATA PROCESSING, CONSUMER ELECTRONIC, AUTOMOTIVE ELECTRONICS (U.S. CLS. 100 AND 101).

FIRST USE 11-6-2007; IN COMMERCE 6-18-2008.

JACQUELINE A. LAVINE, EXAMINING ATTORNEY

SN 77-565,677. BERGER/ABAM ENGINEERS INC., FEDERAL WAY, WA. FILED 9-9-2008.



THE COLOR(S) LIGHT BLUE, DARK BLUE, BLACK, WHITE IS/ARE CLAIMED AS A FEATURE OF THE MARK.

THE MARK CONSISTS OF A CAPITAL "C" WITH SUPERSCRIPT "3" AND THE CAPITAL LETTER "T". THE COLOR IS DARK BLUE ON THE LETTERS "C" AND "T". LIGHT BLUE IS USED ON THE NUMBER "3" AND AS THE OUTLINE OF THE LETTERS. THE MARK IS MADE TO LOOK "3-D" WITH THE USE OF BLACK, WHITE, LIGHT BLUE, AND DARK BLUE SHADOW ON AND/OR UNDER ALL THREE CHARACTERS.

FOR CIVIL ENGINEERING FOR THE DESIGN OF LIQUID NATURAL GAS STORAGE STRUCTURE (U.S. CLS. 100 AND 101).

FIRST USE 9-20-2006; IN COMMERCE 9-20-2006.

JORDAN BAKER, EXAMINING ATTORNEY

SN 77-566,099. VIRTUAL SOUND + MOTION, INC (AKA VSM.NET), MARCO ISLAND, FL. FILED 9-9-2008.

GET YOURSELF OUT OF THE IT BUSINESS

THE MARK CONSISTS OF STANDARD CHARACTERS WITHOUT CLAIM TO ANY PARTICULAR FONT, STYLE, SIZE, OR COLOR.

FOR CREATING, DESIGNING, HOSTING, AND MAINTAINING WEB SITES FOR OTHERS; INFORMATION TECHNOLOGY CONSULTING SERVICES (U.S. CLS. 100 AND 101).

FIRST USE 2-7-2007; IN COMMERCE 10-8-2007.

ANGELA GAW, EXAMINING ATTORNEY

CLASS 42—(Continued).

SN 77-566,570. APPLIED SYSTEMS, INC., UNIVERSITY PARK, IL. FILED 9-10-2008.

EpicOnline

THE MARK CONSISTS OF STANDARD CHARACTERS WITHOUT CLAIM TO ANY PARTICULAR FONT, STYLE, SIZE, OR COLOR.

FOR APPLICATION SERVICE PROVIDER (ASP) SERVICES FEATURING SOFTWARE FOR INSURANCE AND FINANCIAL INDUSTRIES THAT AUTOMATES ACCOUNTING, POLICY ISSUANCE, RATE CALCULATION AND COMPARISON, CLAIMS MANAGEMENT, FORM GENERATION, ELECTRONIC INTERFACE, MARKETING ACTIVITIES, INTEGRATED FAXING AND IMAGING, AND OTHER OFFICE MANAGEMENT FUNCTIONS (U.S. CLS. 100 AND 101).

BARBARA A. GOLD, EXAMINING ATTORNEY

CLASS 42—(Continued).

SN 77-567,482. NEW STEALTH CO, INC., PORTLAND, OR. FILED 9-11-2008.

CC:SYNC

THE MARK CONSISTS OF STANDARD CHARACTERS WITHOUT CLAIM TO ANY PARTICULAR FONT, STYLE, SIZE, OR COLOR.

FOR COMPUTER SERVICE, NAMELY, ACTING AS AN APPLICATION SERVICE PROVIDER IN THE FIELD OF PRODUCTIVITY MANAGEMENT TO HOST COMPUTER APPLICATION SOFTWARE FOR THE COLLECTION, EDITING, ORGANIZING, MODIFYING, COORDINATION, TRANSMISSION, STORAGE AND SHARING OF DATA AND INFORMATION (U.S. CLS. 100 AND 101).

ELLEN B. AWRICH, EXAMINING ATTORNEY

SN 77-567,134. SOAPBOX.COM, INCORPORATED, LA JOLLA, CA. FILED 9-10-2008.

BettyIt

THE MARK CONSISTS OF STANDARD CHARACTERS WITHOUT CLAIM TO ANY PARTICULAR FONT, STYLE, SIZE, OR COLOR.

FOR PROVIDING A WEB SITE THAT GIVES COMPUTER USERS THE ABILITY TO UPLOAD AND SHARE USER-GENERATED VIDEOS, ESSAYS AND ARTICLES ON A WIDE VARIETY OF TOPICS AND SUBJECTS; PROVIDING A WEB SITE THAT GIVES COMPUTER USERS THE ABILITY TO UPLOAD, EXCHANGE AND SHARE PHOTOS, VIDEOS AND VIDEO LOGS; PROVIDING A WEBSITE ALLOWING USERS TO UPLOAD AND DOWNLOAD MUSIC (U.S. CLS. 100 AND 101).

WILLIAM ROSSMAN, EXAMINING ATTORNEY

SN 77-567,383. HUMAN ENGINEERING SOLUTIONS, SIOUX FALLS, SD. FILED 9-11-2008.

HES

THE MARK CONSISTS OF STANDARD CHARACTERS WITHOUT CLAIM TO ANY PARTICULAR FONT, STYLE, SIZE, OR COLOR.

FOR CONSULTATION IN THE FIELD OF ERGONOMICS, NAMELY, DESIGNING WORKPLACE FACILITIES AND EQUIPMENT TO OPTIMIZE EFFICIENCY AND SAFETY (U.S. CLS. 100 AND 101).

FIRST USE 12-10-2007; IN COMMERCE 12-10-2007.
MIDGE BUTLER, EXAMINING ATTORNEY

SN 77-568,253. PLAVEB CORPORATION, BURBANK, CA. FILED 9-11-2008.

 **PLAVEB**

THE STIPPLING IS FOR SHADING PURPOSES ONLY.

THE MARK CONSISTS OF ICON IN LEFT SIDE WITH 3 CREATIVE SKETCHES OF STANDING HUMANS, PLACED ON A 3 DIMENSIONAL SQUARE PLANE. ON THE RIGHT SIDE THERE IS THE STYLIZED TEXT "PLAVEB".

FOR COMPUTER CONSULTATION; CREATING, DESIGNING AND MAINTAINING WEB SITES (U.S. CLS. 100 AND 101).

ARETHA SOMERVILLE, EXAMINING ATTORNEY

SN 77-568,330. FRONTLINE ENVIRONMENTAL TECHNOLOGIES GROUP INC, DBA FRONTLINE TECHNOLOGIES, BENICIA, CA. FILED 9-11-2008.

FBT Solutions

THE MARK CONSISTS OF STANDARD CHARACTERS WITHOUT CLAIM TO ANY PARTICULAR FONT, STYLE, SIZE, OR COLOR.

FOR ENGINEERING SERVICES FOR BUILDING AND PROPERTY CONDITION ASSESSMENT, FACILITY MANAGEMENT, REPAIR AND RESTORATION, BUILDING INSTRUMENTATION AND MONITORING, AND ENVIRONMENTAL CONSULTING (U.S. CLS. 100 AND 101).

FIRST USE 8-9-2007; IN COMMERCE 8-9-2007.
KELLY MCCOY, EXAMINING ATTORNEY

CLASS 42—(Continued).

SN 77-568,331. QC INC, LINCOLN, NE. FILED 9-11-2008.

Help! My PC Won't Work!

THE MARK CONSISTS OF STANDARD CHARACTERS WITHOUT CLAIM TO ANY PARTICULAR FONT, STYLE, SIZE, OR COLOR.

FOR COMPUTER CONSULTATION; COMPUTER NETWORK DESIGN FOR OTHERS; COMPUTER SERVICES, NAMELY, MONITORING AND REPORTING ON THE PERFORMANCE, AVAILABILITY, AND ERRORS OF WEB SITES OF OTHERS; COMPUTER SERVICES, NAMELY, CREATING AND MAINTAINING WEB SITES FOR OTHERS; COMPUTER SERVICES, NAMELY, DESIGNING AND IMPLEMENTING NETWORK WEB PAGES FOR OTHERS; COMPUTER SERVICES, NAMELY, DESIGNING AND IMPLEMENTING WEB SITES FOR OTHERS; COMPUTER SERVICES, NAMELY, HOSTING OF INSPECTION, TESTING, AND QUALITY CONTROL SERVICES' DIGITAL CONTENT OF OTHERS; COMPUTER SERVICES, NAMELY, MANAGING WEB SITES FOR OTHERS; COMPUTER SERVICES, NAMELY, MONITORING THE WEB SITES OF OTHERS TO IMPROVE SCALABILITY AND PERFORMANCE OF WEB SITES OF OTHERS; COMPUTER SERVICES, NAMELY, MONITORING, TESTING, ANALYZING, AND REPORTING ON THE INTERNET TRAFFIC CONTROL AND CONTENT CONTROL OF THE WEB SITES OF OTHERS; COMPUTER TECHNOLOGY SUPPORT SERVICES, NAMELY, HELP DESK SERVICES; CONSULTATION SERVICES IN THE FIELDS OF SELECTION, IMPLEMENTATION AND USE OF COMPUTER HARDWARE AND SOFTWARE SYSTEMS FOR OTHERS; CONSULTING SERVICES IN THE FIELD OF DESIGN, SELECTION, IMPLEMENTATION AND USE OF COMPUTER HARDWARE AND SOFTWARE SYSTEMS FOR OTHERS; CREATING OR MAINTAINING WEB SITES FOR OTHERS; CREATING, DESIGNING AND MAINTAINING WEB SITES; CREATION AND MAINTENANCE OF WEB SITES FOR OTHERS; DESIGN AND DEVELOPMENT OF NETWORKS; DESIGN AND DEVELOPMENT OF WIRELESS COMPUTER NETWORKS; DESIGN, CREATION, HOSTING, MAINTENANCE OF WEB SITES FOR OTHERS; HOSTING THE WEB SITES OF OTHERS ON A COMPUTER SERVER FOR A GLOBAL COMPUTER NETWORK; INSTALLATION, MAINTENANCE AND REPAIR OF COMPUTER SOFTWARE; INTEGRATION OF COMPUTER SYSTEMS AND NETWORKS; IT CONSULTING SERVICES; IT INTEGRATION SERVICES; MAINTENANCE OF COMPUTER SOFTWARE; PLANNING, DEVELOPMENT AND TECHNICAL SUPPORT OF ELECTRONIC COMMUNICATIONS NETWORKS; PROVIDING PLANNING AND ENGINEERING SERVICES IN THE FIELD OF INFORMATION AND COMMUNICATIONS NETWORKS; REPAIR OF COMPUTER SOFTWARE; REPAIR OF DAMAGED COMPUTER PROGRAMS; TECHNICAL SUPPORT SERVICES, NAMELY, TROUBLESHOOTING OF COMPUTER HARDWARE AND SOFTWARE PROBLEMS; TECHNICAL SUPPORT SERVICES, NAMELY, TROUBLESHOOTING OF COMPUTER SOFTWARE PROBLEMS; TECHNICAL SUPPORT, NAMELY, MONITORING OF NETWORK SYSTEMS; WEB SITE DESIGN; WEB SITE DEVELOPMENT FOR OTHERS; WEB SITE HOSTING SERVICES (U.S. CLS. 100 AND 101).

FIRST USE 1-31-1996; IN COMMERCE 1-31-1996.
SONYA STEPHENS, EXAMINING ATTORNEY

CLASS 42—(Continued).

SN 77-585,129. NETRINO, LLC, ELKRIDGE, MD. FILED 10-3-2008.

Zero Bugs...Period

THE MARK CONSISTS OF STANDARD CHARACTERS WITHOUT CLAIM TO ANY PARTICULAR FONT, STYLE, SIZE, OR COLOR.

FOR DESIGN OF COMPUTER HARDWARE, INTEGRATED CIRCUITS, COMMUNICATIONS HARDWARE AND SOFTWARE AND COMPUTER NETWORKS FOR OTHERS (U.S. CLS. 100 AND 101).

FIRST USE 9-28-2008; IN COMMERCE 9-28-2008.
MARGERY A. TIERNEY, EXAMINING ATTORNEY

SN 77-597,796. SENUSION INC., SAN JOSE, CA. FILED 10-22-2008.



THE MARK CONSISTS OF THE STYLIZED TEXT "SENUSSION" WITH A DOT PLACED ABOVE THE LEFT SIDE OF THE LETTER "U" AND A "SWOOSH" PLACED ABOVE THE LETTERS "SENU", BEGINNING AT THE LETTER "S" AND ENDING ABOVE THE DOT.

FOR COMPUTER SOFTWARE DEVELOPMENT (U.S. CLS. 100 AND 101).

FIRST USE 10-15-2007; IN COMMERCE 12-11-2007.
H. M. FISHER, EXAMINING ATTORNEY

SN 77-609,131. UNIVERSITY OF SOUTH CAROLINA, COLUMBIA, SC. FILED 11-6-2008.

ENGENCORE

THE MARK CONSISTS OF STANDARD CHARACTERS WITHOUT CLAIM TO ANY PARTICULAR FONT, STYLE, SIZE, OR COLOR.

FOR CONSULTATION AND RESEARCH SERVICES IN THE FIELD OF GENETIC ANALYSIS, NAMELY, GENE SEQUENCING (U.S. CLS. 100 AND 101).

ALLISON SCHRODY, EXAMINING ATTORNEY

CLASS 42—(Continued).

SN 77-976,293. QWEST COMMUNICATIONS INTERNATIONAL INC., DENVER, CO. FILED 7-17-2008.

TECHZILLA BY QWEST

THE MARK CONSISTS OF STANDARD CHARACTERS WITHOUT CLAIM TO ANY PARTICULAR FONT, STYLE, SIZE, OR COLOR.

FOR DATA BACK-UP SERVICES FOR COMPUTER HARD DRIVE DATA (U.S. CLS. 100 AND 101).
JENNIFER VASQUEZ, EXAMINING ATTORNEY

CLASS 42—(Continued).

SN 79-049,635. AEPODIA S.A., BELGIUM, FILED 9-17-2007.



OWNER OF INTERNATIONAL REGISTRATION 0952702 DATED 9-17-2007, EXPIRES 9-17-2017.

THE COLOR(S) GREEN AND WHITE IS/ARE CLAIMED AS A FEATURE OF THE MARK.

THE MARK CONSISTS OF THE COLOR GREEN APPEARS IN THE WORDING "AEPODIA PARTNER IN EARLY PHASE". THE CIRCLE BEHIND THE LETTERS "AE" AND THE OUTLINES OF THE INTERLOCKING CIRCLES AND THE COLOR WHITE APPEARS IN THE RECTANGULAR BACKGROUND, THE LETTERS "AE" IN THE CIRCLE, AND INSIDE THE INTERLOCKING CIRCLE.

FOR SCIENTIFIC INVESTIGATIONS FOR MEDICAL PURPOSES AND MEDICAL RESEARCH; MEDICAL AND SCIENTIFIC RESEARCH, NAMELY, SCIENTIFIC, THERAPEUTIC AND CLINICAL PROJECT STUDIES IN THE FIELD OF PHARMACEUTICALS, BIOTECHNOLOGY, METABONOMICS, PROTEONOMICS AND GENOMICS; MEDICAL AND SCIENTIFIC RESEARCH, NAMELY, CONDUCTING CLINICAL TRIALS; DEVELOPMENT OF NEW MOLECULES IN THE FIELD OF PHARMACEUTICALS, BIOTECHNOLOGY, METABONOMICS, PROTEONOMICS AND GENOMICS (U.S. CLS. 100 AND 101).
KRISTINA MORRIS, EXAMINING ATTORNEY

SN 78-885,825. DIVERGENCE, INC., ST. LOUIS, MO. FILED 5-17-2006.

STEM

THE MARK CONSISTS OF STANDARD CHARACTERS WITHOUT CLAIM TO ANY PARTICULAR FONT, STYLE, SIZE, OR COLOR.

THE WORDING "STEM" IN THE MARK HAS NO MEANING IN A FOREIGN LANGUAGE.

FOR RESEARCH AND DEVELOPMENT SERVICES IN THE FIELD OF BROAD PROTEIN SCAFFOLD TECHNOLOGY FOR SELECTION OF BIOACTIVE MOLECULES (U.S. CLS. 100 AND 101).
MATTHEW MCDOWELL, EXAMINING ATTORNEY

SN 79-051,861. SHENZHEN XUNLEI NETWORKING TECHNOLOGIES LTD., SHENZHEN; GUANGDONG, CHINA, FILED 3-20-2008.



OWNER OF INTERNATIONAL REGISTRATION 0958645 DATED 3-20-2008, EXPIRES 3-20-2018.

THE MARK CONSISTS OF A WING OF BIRD.

FOR COMPUTER PROGRAMMING; COMPUTER SOFTWARE DESIGN; DATA CONVERSION OF COMPUTER PROGRAMS AND DATA, NOT PHYSICAL CONVERSION; COMPUTER SYSTEMS ANALYSIS; RENTAL OF COMPUTER SOFTWARE; CONVERSION OF DATA OR DOCUMENTS FROM PHYSICAL TO ELECTRONIC MEDIA (U.S. CLS. 100 AND 101).
NICHOLAS COLEMAN, EXAMINING ATTORNEY

CLASS 42—(Continued).

SN 79-058,047. PROWIND GMBH, FED REP GERMANY,
FILED 7-23-2008.

Prowind

THE MARK CONSISTS OF STANDARD CHARACTERS WITHOUT CLAIM TO ANY PARTICULAR FONT, STYLE, SIZE, OR COLOR.

PRIORITY DATE OF 2-1-2008 IS CLAIMED.

OWNER OF INTERNATIONAL REGISTRATION 0975180 DATED 7-23-2008, EXPIRES 7-23-2018.

FOR SCIENTIFIC AND TECHNOLOGICAL SERVICES, NAMELY, PROVIDING PLANNING AND DESIGN SERVICES AND DRAFTING OF CONSTRUCTION PLANS IN THE FIELD OF ENVIRONMENTALLY-SYMPATHETIC WIND-POWERED ELECTRICITY GENERATING TURBINES; TECHNOLOGICAL CONSULTATION IN THE TECHNOLOGY FIELD OF ENVIRONMENTALLY-SYMPATHETIC WIND-POWERED ELECTRICITY GENERATING TURBINES; SCIENTIFIC RESEARCH; ENGINEERING SERVICES (U.S. CLS. 100 AND 101).
KAREN SEVERSON, EXAMINING ATTORNEY

SN 79-058,048. PROWIND GMBH, FED REP GERMANY,
FILED 7-23-2008.



PRIORITY DATE OF 2-1-2008 IS CLAIMED.
OWNER OF INTERNATIONAL REGISTRATION 0975181 DATED 7-23-2008, EXPIRES 7-23-2018.

THE MARK CONSISTS OF THE WORDING "PROWIND" WITH THE LETTER "I" EXTENDED TO FORM A WINDMILL WITH AN INCOMPLETE CIRCLE AROUND THE BLADES OF THE WINDMILL.

FOR SCIENTIFIC AND TECHNOLOGICAL SERVICES, NAMELY, PROVIDING PLANNING AND DESIGN SERVICES AND DRAFTING OF CONSTRUCTION PLANS IN THE FIELD OF ENVIRONMENTALLY-SYMPATHETIC WIND-POWERED ELECTRICITY GENERATING TURBINES; TECHNOLOGICAL CONSULTATION IN THE TECHNOLOGY FIELD OF ENVIRONMENTALLY-SYMPATHETIC WIND-POWERED ELECTRICITY GENERATING TURBINES; SCIENTIFIC RESEARCH; ENGINEERING SERVICES (U.S. CLS. 100 AND 101).
KAREN SEVERSON, EXAMINING ATTORNEY

CLASS 43—HOTEL AND RESTAURANT SERVICES

SN 76-677,522. WEISS, CRAIG, NEW YORK, NY. FILED 5-29-2007.

the otherroom

FOR WINE AND BEER BAR (U.S. CLS. 100 AND 101).
FIRST USE 5-23-1997; IN COMMERCE 5-23-1997.
CARYN GLASSER, EXAMINING ATTORNEY

SN 76-684,794. KESSINGER, GEORGE, PALM SPRINGS, CA.
FILED 12-11-2007.

GEORGIE'S ALIBI

THE MARK CONSISTS OF STANDARD CHARACTERS WITHOUT CLAIM TO ANY PARTICULAR FONT, STYLE, SIZE, OR COLOR.

FOR RESTAURANT SERVICES (U.S. CLS. 100 AND 101).

FIRST USE 4-3-1997; IN COMMERCE 4-3-1997.

BENJAMIN OKEKE, EXAMINING ATTORNEY

SN 76-692,418. EAST PUB, INC., NEW YORK, NY. FILED 8-27-2008.

PHEBE'S

FOR RESTAURANT SERVICES (U.S. CLS. 100 AND 101).

FIRST USE 0-0-1968; IN COMMERCE 0-0-1968.

SHARON MEIER, EXAMINING ATTORNEY

SN 76-692,645. KELLY, CHARLES, LOS ANGELES, CA.
FILED 9-9-2008.

ALLSTON YACHT CLUB

THE MARK CONSISTS OF STANDARD CHARACTERS WITHOUT CLAIM TO ANY PARTICULAR FONT, STYLE, SIZE, OR COLOR.

FOR RESTAURANT, SERVING FOOD AND BEVERAGES (U.S. CLS. 100 AND 101).

KRISTIN DAHLING, EXAMINING ATTORNEY

CLASS 43—(Continued).

SN 76-692,690. FISHMARKET, LLC, ST. HELENA, CA. FILED 9-9-2008.



THE LINING AND STIPPLING IS A FEATURE OF THE MARK AND DOES NOT INDICATE COLOR.
THE MARK CONSISTS OF THE DESIGN OF A FISH WALKING UPRIGHT ALONG THE SEASHORE, WEARING A HAT AND CARRYING AN UMBRELLA.
FOR RESTAURANT AND CATERING SERVICES (U.S. CLS. 100 AND 101).
FIRST USE 6-2-2006; IN COMMERCE 6-2-2006.
BARBARA A. GOLD, EXAMINING ATTORNEY

SN 77-000,061. L & L FRANCHISE, INC., HONOLULU, HI. FILED 9-15-2006.

The 1st Hawaiian Barbecue

THE MARK CONSISTS OF STANDARD CHARACTERS WITHOUT CLAIM TO ANY PARTICULAR FONT, STYLE, SIZE, OR COLOR.
OWNER OF U.S. REG. NOS. 2,371,282, 2,953,874 AND OTHERS.
NO CLAIM IS MADE TO THE EXCLUSIVE RIGHT TO USE "BARBECUE", APART FROM THE MARK AS SHOWN.
SEC. 2(F) "HAWAIIAN" HAS BECOME DISTINCTIVE OF THE GOODS/SERVICES THROUGH THE APPLICANT'S SUBSTANTIALLY EXCLUSIVE AND CONTINUOUS USE IN COMMERCE FOR AT LEAST THE FIVE YEARS IMMEDIATELY BEFORE THE DATE OF THIS STATEMENT.
FOR FAST FOOD RESTAURANT (U.S. CLS. 100 AND 101).
SUSAN LESLIE DUBOIS, EXAMINING ATTORNEY

CLASS 43—(Continued).

SN 77-000,063. L & L FRANCHISE, INC., HONOLULU, HI. FILED 9-15-2006.

The No. 1 Hawaiian Barbecue

THE MARK CONSISTS OF STANDARD CHARACTERS WITHOUT CLAIM TO ANY PARTICULAR FONT, STYLE, SIZE, OR COLOR.
OWNER OF U.S. REG. NOS. 2,371,282, 2,953,874 AND OTHERS.
NO CLAIM IS MADE TO THE EXCLUSIVE RIGHT TO USE "BARBECUE", APART FROM THE MARK AS SHOWN.
SEC. 2(F) "HAWAIIAN" HAS BECOME DISTINCTIVE OF THE GOODS/SERVICES THROUGH THE APPLICANT'S SUBSTANTIALLY EXCLUSIVE AND CONTINUOUS USE IN COMMERCE FOR AT LEAST THE FIVE IMMEDIATELY BEFORE THE DATE OF THIS STATEMENT.
FOR FAST FOOD RESTAURANT (U.S. CLS. 100 AND 101).
SUSAN LESLIE DUBOIS, EXAMINING ATTORNEY

SN 77-086,377. ALE.MENT, INC., KNOXVILLE, TN. FILED 1-19-2007.

nama

THE FOREIGN WORDING IN THE MARK TRANSLATES INTO ENGLISH AS "RAW" OR "FRESH"
FOR RESTAURANT AND BAR SERVICES (U.S. CLS. 100 AND 101).
FIRST USE 7-12-2004; IN COMMERCE 7-12-2004.
SETH A. RAPPAPORT, EXAMINING ATTORNEY

SN 77-219,225. DIPPIN' DOTS, INC., PADUCAH, KY. FILED 6-29-2007.

PACKY

THE MARK CONSISTS OF STANDARD CHARACTERS WITHOUT CLAIM TO ANY PARTICULAR FONT, STYLE, SIZE, OR COLOR.
FOR RESTAURANT SERVICES (U.S. CLS. 100 AND 101).
CAROLYN GRAY, EXAMINING ATTORNEY

CLASS 43—(Continued).

SN 77-274,157. EVO, INC., YOUNTVILLE, CA. FILED 9-7-2007.

CLASS 43—(Continued).

SN 77-322,375. NOLBOO CO., LTD., SEOUL, REPUBLIC OF KOREA, FILED 11-6-2007.

ROAST LAND

THE MARK CONSISTS OF STANDARD CHARACTERS WITHOUT CLAIM TO ANY PARTICULAR FONT, STYLE, SIZE, OR COLOR.

NO CLAIM IS MADE TO THE EXCLUSIVE RIGHT TO USE "ROAST", APART FROM THE MARK AS SHOWN.

FOR RESTAURANT AND BAR SERVICES; CATERING (U.S. CLS. 100 AND 101).

NELSON SNYDER, EXAMINING ATTORNEY

NOLBU

SN 77-300,344. RRII, LLC, PHOENIX, AZ. FILED 10-10-2007.



THE MARK CONSISTS OF THE WORD "EAT" IN A DISC DESIGN WITH AN UPPER RIGHT PORTION REMOVED AND THE WORDING "ON A ROLL" CURVED ALONG THE OUTER LOWER LEFT SIDE OF THE DISC.

FOR RESTAURANT SERVICES (U.S. CLS. 100 AND 101).

SALLY SHIH, EXAMINING ATTORNEY

THE MARK CONSISTS OF STANDARD CHARACTERS WITHOUT CLAIM TO ANY PARTICULAR FONT, STYLE, SIZE, OR COLOR.

PRIORITY CLAIMED UNDER SEC. 44(D) ON REPUBLIC OF KOREA APPLICATION NO. 2007-0027648, FILED 10-22-2007, REG. NO. 0172751, DATED 8-19-2008, EXPIRES 8-19-2018.

OWNER OF U.S. REG. NOS. 2,871,951 AND 2,989,956.

FOR RESTAURANTS; RESTAURANTS FEATURING KOREAN FOOD; SELF-SERVICE RESTAURANTS; SNACK-BARS; BUFFET-STYLE RESTAURANTS; CATERING SERVICES; CAFES; CAFETERIAS; CANTEENS; COCKTAIL LOUNGE SERVICES (U.S. CLS. 100 AND 101).

JAY FLOWERS, EXAMINING ATTORNEY

CLASS 43—(Continued).

SN 77-355,323. BEIJING HUANGJIHUANG TECHNOLOGY DEVELOPMENT CO., LTD., BEIJING, CHINA, FILED 12-19-2007.



黄记煌三汁焖锅

OWNER OF CHINA REG. NO. 3568532, DATED 5-14-2006, EXPIRES 5-14-2016.

NO CLAIM IS MADE TO THE EXCLUSIVE RIGHT TO USE THE NON-LATIN CHARACTERS THAT MEAN "STEW WITH THREE JUICES", APART FROM THE MARK AS SHOWN.

THE NAME "HUANG JI HUANG" DOES NOT IDENTIFY A LIVING INDIVIDUAL.

THE MARK CONSISTS OF THE DESIGN OF A CIRCLE WITHIN A SQUARE. INSIDE THE CIRCLE ARE THE CHINESE CHARACTERS THAT TRANSLITERATE TO "HUANG," "JI," "HUANG" AND MEAN "YELLOW," "MARK," AND "BRILLIANT," RESPECTIVELY, IN ENGLISH. ALL ABOVE THE STYLIZED WORDING "H&H." BELOW THE SQUARE ARE THE CHINESE CHARACTERS THAT TRANSLITERATE TO "SAN ZHI MEN GUO" AND MEAN "STEW WITH THREE JUICES" IN ENGLISH.

THE NON-LATIN CHARACTERS IN THE MARK THAT TRANSLITERATE TO "HUANG," "JI," "HUANG" MEAN "YELLOW," "MARK," AND "BRILLIANT," RESPECTIVELY, IN ENGLISH. THE NON-LATIN CHARACTERS IN THE MARK WHICH TRANSLITERATE TO "SAN ZHI MEN GUO" MEAN "STEW WITH THREE JUICES" IN ENGLISH.

THE NON-LATIN CHARACTERS IN THE MARK TRANSLITERATE TO "HUANG," "JI," "HUANG" AND TO "SAN ZHI MEN GUO," RESPECTIVELY.

FOR CAFETERIAS; HOTEL, BAR AND RESTAURANT SERVICES; SELF SERVICE RESTAURANTS; MOBILE CAFE SERVICES FOR PROVIDING FOOD AND DRINK; TEA ROOMS; CAFES; SNACK BAR AND CANTEEN SERVICES (U.S. CLS. 100 AND 101).

MAUREEN DALL, EXAMINING ATTORNEY

CLASS 43—(Continued).

SN 77-392,674. ADVANTAGE OFFICE SUITES, LLC, PHOENIX, AZ. FILED 2-8-2008.



NO CLAIM IS MADE TO THE EXCLUSIVE RIGHT TO USE "OFFICE SUITES", APART FROM THE MARK AS SHOWN.

THE MARK CONSISTS OF THE WORDS "ADVANTAGE OFFICE SUITES", WITH THE SECOND "A" IN "ADVANTAGE" BEING STYLIZED, AND A CONTEMPORARY DESIGN DEPICTING TWO BUILDINGS.

FOR PROVIDING CONFERENCE ROOMS (U.S. CLS. 100 AND 101).

FIRST USE 10-24-2006; IN COMMERCE 10-24-2006.

HOWARD B. LEVINE, EXAMINING ATTORNEY

SN 77-399,230. SANCHEZ, DAVID M., SAN JOSE, CA. FILED 2-17-2008.

The Wine Pimp

THE MARK CONSISTS OF STANDARD CHARACTERS WITHOUT CLAIM TO ANY PARTICULAR FONT, STYLE, SIZE, OR COLOR.

NO CLAIM IS MADE TO THE EXCLUSIVE RIGHT TO USE "WINE", APART FROM THE MARK AS SHOWN.

FOR CONSULTING SERVICES IN THE FIELD OF HOSPITALITY (U.S. CLS. 100 AND 101).

FIRST USE 1-13-2006; IN COMMERCE 7-13-2006.

MATTHEW PAPPAS, EXAMINING ATTORNEY

SN 77-408,508. FONTAINEBLEAU RESORT PROPERTIES II, LLC, LAS VEGAS, NV. FILED 2-28-2008.

INEXEN

THE MARK CONSISTS OF STANDARD CHARACTERS WITHOUT CLAIM TO ANY PARTICULAR FONT, STYLE, SIZE, OR COLOR.

THE MARK "INEXEN" HAS NO MEANING IN A FOREIGN LANGUAGE.

FOR HOTELS, HOTEL SERVICES, BAR AND RESTAURANT SERVICES, COCKTAIL LOUNGE SERVICES; RESERVATION SERVICES FOR HOTEL ACCOMMODATIONS AND PROVISION OF FACILITIES FOR MEETINGS, CONFERENCES AND EXHIBITIONS (U.S. CLS. 100 AND 101).

SUE LAWRENCE, EXAMINING ATTORNEY

CLASS 43—(Continued).

SN 77-410,353. TEAPOD, LLC, SAN ANSELMO, CA. FILED 2-29-2008.



NO CLAIM IS MADE TO THE EXCLUSIVE RIGHT TO USE "ORGANIC TEA BAR", APART FROM THE MARK AS SHOWN.
FOR TEA BARS (U.S. CLS. 100 AND 101).
KATHERINE CHANG, EXAMINING ATTORNEY

SN 77-417,293. 112TT, LLC, WESTON, MA. FILED 3-10-2008.



NO CLAIM IS MADE TO THE EXCLUSIVE RIGHT TO USE "HOTEL", APART FROM THE MARK AS SHOWN.
THE MARK CONSISTS OF THE WORDING "WYVERN HOTEL" SEPARATED BY A DOUBLE UNDERLINE AND THE DESIGN OF TWO OPPOSING DRAGONS ABOVE THE WORDING.
FOR HOTEL, RESTAURANT AND BAR SERVICES (U.S. CLS. 100 AND 101).
TIMOTHY FINNEGAN, EXAMINING ATTORNEY

SN 77-427,275. ACAPULCO RESTAURANTS, INC., CY-PRESS, CA. FILED 3-20-2008.

MUCHO MACHO PLATTERS

THE MARK CONSISTS OF STANDARD CHARACTERS WITHOUT CLAIM TO ANY PARTICULAR FONT, STYLE, SIZE, OR COLOR.
NO CLAIM IS MADE TO THE EXCLUSIVE RIGHT TO USE "PLATTERS", APART FROM THE MARK AS SHOWN.
THE FOREIGN WORDING IN THE MARK TRANSLATES INTO ENGLISH AS "MUCH MALE".
FOR RESTAURANT SERVICES (U.S. CLS. 100 AND 101).
MARGERY A. TIERNEY, EXAMINING ATTORNEY

CLASS 43—(Continued).

SN 77-432,353. RRB HOLDINGS, INC., LIBIS, QUEZON CITY, PHILIPPINES, FILED 3-26-2008.



OWNER OF U.S. REG. NO. 1,856,055.
THE MARK CONSISTS OF A RIBBON WITH THE WORDS "RED RIBBON" INSIDE IN STYLIZED LETTERS.
FOR RESTAURANT AND CANTEEN SERVICES AND SELF-SERVICE RESTAURANT SERVICES (U.S. CLS. 100 AND 101).
SUNG IN, EXAMINING ATTORNEY

SN 77-432,389. RRB HOLDINGS, INC., LIBIS, QUEZON CITY, PHILIPPINES, FILED 3-26-2008.



OWNER OF U.S. REG. NO. 1,856,055.
NO CLAIM IS MADE TO THE EXCLUSIVE RIGHT TO USE "BAKESHOP", APART FROM THE MARK AS SHOWN.
THE MARK CONSISTS OF THE WORDS "RED RIBBON BAKESHOP" IN STYLIZED LETTERS WITH CURLED RIBBON DESIGNS BEFORE AND AFTER.
FOR RESTAURANT AND CANTEEN SERVICES AND SELF-SERVICE RESTAURANT SERVICES (U.S. CLS. 100 AND 101).
SUNG IN, EXAMINING ATTORNEY

SN 77-432,947. RRB HOLDINGS, INC., LIBIS, QUEZON CITY, PHILIPPINES, FILED 3-27-2008.

**WHATEVER THE CELEBRATION,
IT'S MORE BEAUTIFUL WITH A
RED RIBBON**

THE MARK CONSISTS OF STANDARD CHARACTERS WITHOUT CLAIM TO ANY PARTICULAR FONT, STYLE, SIZE, OR COLOR.
OWNER OF U.S. REG. NO. 1,856,055.
FOR RESTAURANT AND CANTEEN SERVICES AND SELF-SERVICE RESTAURANT SERVICES (U.S. CLS. 100 AND 101).
SUNG IN, EXAMINING ATTORNEY

CLASS 43—(Continued).

SN 77-449,606. SOUTHWEST RESTAURANT SYSTEMS, INC., SCOTTSDALE, AZ. FILED 4-16-2008.

PINNACLE PEAK PATIO

THE MARK CONSISTS OF STANDARD CHARACTERS WITHOUT CLAIM TO ANY PARTICULAR FONT, STYLE, SIZE, OR COLOR.

APPLICANT SEEKS REGISTRATION OF THE MARK PINNACLE PEAK PATIO FOR RESTAURANT SERVICES FOR THE AREA COMPRISING THE STATES OF ARIZONA (EXCEPT PIMA, SANTA CRUZ, YUMA, AND COCHISE COUNTIES), COLORADO, ILLINOIS, INDIANA, IOWA, KANSAS, KENTUCKY, MARYLAND, MICHIGAN, MINNESOTA, MISSOURI, NEBRASKA, NEW MEXICO, NEW YORK, OHIO, OKLAHOMA, PENNSYLVANIA, TENNESSEE, TEXAS (NORTH OF 31 DEGREES LATITUDE) UTAH, VIRGINIA, WEST VIRGINIA AND WISCONSIN. CONCURRENT USE PROCEEDING NUMBER 855 WITH REGISTRATION NO. 871466; CONCURRENT USE WITH AGRO INTERNATIONAL, INC., SUITE 800, 4400 EAST BROADWAY, TUCSON, ARIZONA 85711.

NO CLAIM IS MADE TO THE EXCLUSIVE RIGHT TO USE "PATIO", APART FROM THE MARK AS SHOWN.

FOR RESTAURANT SERVICES (U.S. CLS. 100 AND 101).

FIRST USE 8-0-1957; IN COMMERCE 8-0-1957.
LYDIA BELZER, EXAMINING ATTORNEY

SN 77-455,391. STONEWOOD HOLDINGS, LLC, ORMOND BEACH, FL. FILED 4-23-2008.



NO CLAIM IS MADE TO THE EXCLUSIVE RIGHT TO USE "NEIGHBORHOOD ITALIAN CAFE", APART FROM THE MARK AS SHOWN.

THE COLOR(S) BLACK, YELLOW, ORANGE, GREEN, RED AND PURPLE IS/ARE CLAIMED AS A FEATURE OF THE MARK.

THE MARK CONSISTS OF THE WORDING "CERCHIO NEIGHBORHOOD ITALIAN CAFE" WITHIN STYLIZED LETTERING IN COMBINATION WITH A QUADRANGULAR DESIGN. THE QUADRANGULAR DESIGN ITSELF CONTAINS SEVERAL LINES, CIRCLES AND OTHER GEOMETRIC DESIGNS. THE WORDS "CERCHIO NEIGHBORHOOD ITALIAN CAFE" ARE BLACK. THE LINE BELOW THE WORDING "CERCHIO" IS YELLOW. THE QUADRANGULAR DESIGN IS BLACK. THE GEOMETRIC DESIGNS WITHIN THE QUADRANGLE ARE PURPLE, ORANGE, GREEN AND RED.

THE FOREIGN WORDING IN THE MARK TRANSLATES INTO ENGLISH AS CIRCLE.

FOR RESTAURANT SERVICES; AND CARRY-OUT RESTAURANT SERVICES (U.S. CLS. 100 AND 101).
CARYN GLASSER, EXAMINING ATTORNEY

CLASS 43—(Continued).

SN 77-467,944. KOOL BEANZ, INC., IDAHO FALLS, ID. FILED 5-7-2008.

Juice Jungle

THE MARK CONSISTS OF STANDARD CHARACTERS WITHOUT CLAIM TO ANY PARTICULAR FONT, STYLE, SIZE, OR COLOR.

NO CLAIM IS MADE TO THE EXCLUSIVE RIGHT TO USE "JUICE", APART FROM THE MARK AS SHOWN.

FOR RESTAURANT AND TAKE-OUT RESTAURANT SERVICES FEATURING FRUIT AND VEGETABLE JUICES, DRINKS AND SMOOTHIES, COFFEE, COFFEE-BASED DRINKS, SOFT DRINKS, HOT DRINKS, PASTRIES AND OTHER BAKED GOODS, AND CANDIES (U.S. CLS. 100 AND 101).

LESLEY LAMOTHE, EXAMINING ATTORNEY

SN 77-473,713. OH, QUE BUENO! INC., SAN JOSE, CA. FILED 5-13-2008.

LA FAMILIA POLLON

THE MARK CONSISTS OF STANDARD CHARACTERS WITHOUT CLAIM TO ANY PARTICULAR FONT, STYLE, SIZE, OR COLOR.

THE FOREIGN WORDING IN THE MARK TRANSLATES INTO ENGLISH AS THE BIG CHICKEN FAMILY.

FOR RESTAURANT, CAFE, BAR, COCKTAIL LOUNGE, AND CATERING SERVICES; RESTAURANTS; RESTAURANTS AND RESTAURANT SERVICES IN HOTELS AND MOTELS FOR GUESTS (U.S. CLS. 100 AND 101).

DAVID ELTON, EXAMINING ATTORNEY

SN 77-492,004. FU'S TOKYO, INC., SIMPSONVILLE, SC. FILED 6-5-2008.

FU OF KYOTO

THE MARK CONSISTS OF STANDARD CHARACTERS WITHOUT CLAIM TO ANY PARTICULAR FONT, STYLE, SIZE, OR COLOR.

NO CLAIM IS MADE TO THE EXCLUSIVE RIGHT TO USE "KYOTO", APART FROM THE MARK AS SHOWN.

FOR RESTAURANT AND BAR SERVICES; RESTAURANT SERVICES, INCLUDING SIT-DOWN SERVICE OF FOOD AND TAKE-OUT RESTAURANT SERVICES (U.S. CLS. 100 AND 101).

FIRST USE 4-1-2008; IN COMMERCE 4-1-2008.
LINDA ORNDORFF, EXAMINING ATTORNEY

CLASS 43—(Continued).

SN 77-492,094. KIDSTOWN DROP-IN CHILD CARE CENTER, INC., PARKER, CO. FILED 6-5-2008.



NO CLAIM IS MADE TO THE EXCLUSIVE RIGHT TO USE "KIDS" AND "DROP-IN CHILD CARE CENTERS", APART FROM THE MARK AS SHOWN.

THE MARK CONSISTS OF FIVE CHILDREN STANDING WITH THE WORDS KIDSTOWN BELOW THEM AND THE WORDS DROP-IN CHILD CARE CENTERS ACROSS THE BOTTOM.

FOR CHILD CARE (U.S. CLS. 100 AND 101).
FIRST USE 9-30-2004; IN COMMERCE 9-30-2004.
SAIMA MAKHDOOM, EXAMINING ATTORNEY

SN 77-499,675. CSX IA, INC., JACKSONVILLE, FL. FILED 6-16-2008.

THE GREENBRIER

OWNER OF U.S. REG. NOS. 1,482,046, 1,776,855 AND 2,940,022.

THE MARK CONSISTS OF A LINE TO THE LEFT OF THE WORD "THE" WITH A LINE TO THE RIGHT, THEN THE WORD "GREENBRIER" WITH A LINE UNDER IT..

FOR RESORT HOTEL SERVICES (U.S. CLS. 100 AND 101).
MICHELE SWAIN, EXAMINING ATTORNEY

SN 77-541,663. SILVER DINER, INC., ROCKVILLE, MD. FILED 8-7-2008.

METRO SILVER DINER

THE MARK CONSISTS OF STANDARD CHARACTERS WITHOUT CLAIM TO ANY PARTICULAR FONT, STYLE, SIZE, OR COLOR.

OWNER OF U.S. REG. NOS. 1,563,416, 1,563,964 AND 3,081,818.

NO CLAIM IS MADE TO THE EXCLUSIVE RIGHT TO USE "DINER", APART FROM THE MARK AS SHOWN.

FOR RESTAURANT SERVICES (U.S. CLS. 100 AND 101).

REBECCA EISINGER, EXAMINING ATTORNEY

CLASS 43—(Continued).

SN 77-551,411. LARKSPUR HOTELS, LLC, LARKSPUR, CA. FILED 8-20-2008.

HOTEL ABRI

THE MARK CONSISTS OF STANDARD CHARACTERS WITHOUT CLAIM TO ANY PARTICULAR FONT, STYLE, SIZE, OR COLOR.

NO CLAIM IS MADE TO THE EXCLUSIVE RIGHT TO USE "HOTEL", APART FROM THE MARK AS SHOWN.

THE ENGLISH TRANSLATION OF THE WORD "ABRI" IN THE MARK IS "SHELTER".

FOR HOTEL SERVICES (U.S. CLS. 100 AND 101).
PAUL E. FAHRENKOPF, EXAMINING ATTORNEY

SN 77-554,992. 360 VENTURES, LLC, AUSTIN, TX. FILED 8-25-2008.

Fast Food for the 21st Century

THE MARK CONSISTS OF STANDARD CHARACTERS WITHOUT CLAIM TO ANY PARTICULAR FONT, STYLE, SIZE, OR COLOR.

NO CLAIM IS MADE TO THE EXCLUSIVE RIGHT TO USE "FAST FOOD", APART FROM THE MARK AS SHOWN.

FOR RESTAURANT SERVICES (U.S. CLS. 100 AND 101).

KEVON CHISOLM, EXAMINING ATTORNEY

SN 77-555,664. OS ASSET, INC., TAMPA, FL. FILED 8-26-2008.

Bloomin' Birthday

THE MARK CONSISTS OF STANDARD CHARACTERS WITHOUT CLAIM TO ANY PARTICULAR FONT, STYLE, SIZE, OR COLOR.

OWNER OF U.S. REG. NOS. 1,532,205 AND 2,552,055.

NO CLAIM IS MADE TO THE EXCLUSIVE RIGHT TO USE "BIRTHDAY", APART FROM THE MARK AS SHOWN.

FOR BAR AND RESTAURANT SERVICES; CARRY-OUT RESTAURANTS (U.S. CLS. 100 AND 101).

FIRST USE 3-30-2008; IN COMMERCE 3-30-2008.
MARK SPACINO, EXAMINING ATTORNEY

CLASS 43—(Continued).

SN 77-556,387. CRANE, TERRY LYNNE, TALBOTTON, GA. FILED 8-26-2008.

TARLETON OAKS

THE MARK CONSISTS OF STANDARD CHARACTERS WITHOUT CLAIM TO ANY PARTICULAR FONT, STYLE, SIZE, OR COLOR.
FOR BED AND BREAKFAST INN SERVICES (U.S. CLS. 100 AND 101).
JULIE GUTTADAURO, EXAMINING ATTORNEY

SN 77-561,142. SKINS, INC., ANDERSON, SC. FILED 9-3-2008.

SKIN THRASHER'S

THE MARK CONSISTS OF STANDARD CHARACTERS WITHOUT CLAIM TO ANY PARTICULAR FONT, STYLE, SIZE, OR COLOR.
OWNER OF U.S. REG. NOS. 1,451,535 AND 2,769,011.
FOR RESTAURANT SERVICES, NAMELY, THE SERVING OF HOT DOGS AND CONDIMENT ITEMS (U.S. CLS. 100 AND 101).
FIRST USE 1-1-1946; IN COMMERCE 1-1-1946.
MICHAEL WEBSTER, EXAMINING ATTORNEY

SN 77-561,548. OLE MOLE, LLC, WESTPORT, CT. FILED 9-3-2008.

Olé Molé

THE MARK CONSISTS OF STANDARD CHARACTERS WITHOUT CLAIM TO ANY PARTICULAR FONT, STYLE, SIZE, OR COLOR.
FOR RESTAURANT SERVICES, NAMELY, SERVICES FOR PROVIDING MEXICAN CUISINE (U.S. CLS. 100 AND 101).
FIRST USE 11-24-1994; IN COMMERCE 11-24-1994.
SAMUEL E. SHARPER JR., EXAMINING ATTORNEY

CLASS 43—(Continued).

SN 77-562,011. DRC INVESTMENTS, LLC, PHILADELPHIA, PA. FILED 9-4-2008.

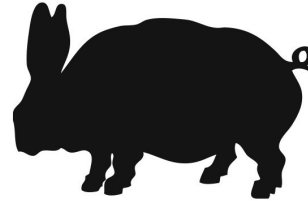

PUB & KITCHEN

NO CLAIM IS MADE TO THE EXCLUSIVE RIGHT TO USE "PUB & KITCHEN", APART FROM THE MARK AS SHOWN.
THE MARK CONSISTS OF SILHOUETTE OF A PIG SHAPE WITH A RABBIT HEAD AND THE WORDS "PUB & KITCHEN".
FOR BAR AND RESTAURANT SERVICES (U.S. CLS. 100 AND 101).
MARC LEIPZIG, EXAMINING ATTORNEY

SN 77-562,394. TWO RIVERS HOSPITALITY GROUP LLC, SEA BRIGHT, NJ. FILED 9-4-2008.

JERSEY FREEZE

THE MARK CONSISTS OF STANDARD CHARACTERS WITHOUT CLAIM TO ANY PARTICULAR FONT, STYLE, SIZE, OR COLOR.
NO CLAIM IS MADE TO THE EXCLUSIVE RIGHT TO USE "JERSEY", APART FROM THE MARK AS SHOWN.
FOR RESTAURANT SERVICES; TAKEOUT RESTAURANT SERVICES (U.S. CLS. 100 AND 101).
ANGELA M. MICHELI, EXAMINING ATTORNEY

SN 77-562,715. HJG DWARF HOUSE, INC., ATLANTA, GA. FILED 9-4-2008.

UPSCALE PIZZA

THE MARK CONSISTS OF STANDARD CHARACTERS WITHOUT CLAIM TO ANY PARTICULAR FONT, STYLE, SIZE, OR COLOR.
NO CLAIM IS MADE TO THE EXCLUSIVE RIGHT TO USE "PIZZA", APART FROM THE MARK AS SHOWN.
FOR RESTAURANT SERVICES (U.S. CLS. 100 AND 101).
FIRST USE 4-1-2008; IN COMMERCE 5-1-2008.
SUE LAWRENCE, EXAMINING ATTORNEY

CLASS 43—(Continued).

SN 77-562,760. HJG DWARF HOUSE, INC., ATLANTA, GA. FILED 9-4-2008.



NO CLAIM IS MADE TO THE EXCLUSIVE RIGHT TO USE "PIZZA HOT DOGS - HOT WINGS - SOUPS - SANDWICHES - SALADS - SHAKES", APART FROM THE MARK AS SHOWN.

THE MARK CONSISTS OF THE WORDS UPSCALE PIZZA HOT DOGS. HOT WINGS. SOUPS. SANDWICHES. SALADS. SHAKES AND THE DESIGN OF AN ARROW WITHIN A CIRCLE.

FOR RESTAURANT SERVICES (U.S. CLS. 100 AND 101).

FIRST USE 4-1-2008; IN COMMERCE 5-1-2008.
SUE LAWRENCE, EXAMINING ATTORNEY

SN 77-563,486. GARRAMONE, GARTH J., SAQUOIT, NY. FILED 9-5-2008.

GARTH'S GARAGE

THE MARK CONSISTS OF STANDARD CHARACTERS WITHOUT CLAIM TO ANY PARTICULAR FONT, STYLE, SIZE, OR COLOR.

FOR RESTAURANT SERVICES (U.S. CLS. 100 AND 101).

ALLISON SCHRODY, EXAMINING ATTORNEY

SN 77-564,062. FRONT BURNER PRODUCTIONS, INC., MIAMI BEACH, FL. FILED 9-7-2008.

SNAFOOD

THE MARK CONSISTS OF STANDARD CHARACTERS WITHOUT CLAIM TO ANY PARTICULAR FONT, STYLE, SIZE, OR COLOR.

FOR PROVIDING AN INTERACTIVE WEBSITE DEDICATED TO PROVIDING FOOD AND DRINK RECIPES (U.S. CLS. 100 AND 101).

GIANCARLO CASTRO, EXAMINING ATTORNEY

CLASS 43—(Continued).

SN 77-564,095. GREEN DOG VENTURES, LLC, ATLANTA, GA. FILED 9-7-2008.



THE COLOR(S) GREEN, WHITE, BLACK, RED, YELLOW, DARK GREEN AND LIGHT GREEN IS/ARE CLAIMED AS A FEATURE OF THE MARK.

THE MARK CONSISTS OF A GREEN DOG WITH WHITE MARKINGS AND BLACK NOSE WITH WHITE SHADING WEARING A RED COLLAR WITH WHITE DOTS WITH A YELLOW TAG AND STANDING ON TOP OF A DARK GREEN AND LIGHT GREEN WORLD WITH THE WORD "GREEN" APPEARING IN DARK GREEN AND THE WORD "DOG" APPEARING IN LIGHT GREEN.

FOR BOARDING FOR ANIMALS; KENNEL SERVICES, NAMELY, BOARDING FOR PETS; PET BOARDING SERVICES; PET DAY CARE SERVICES (U.S. CLS. 100 AND 101).

SKYE YOUNG, EXAMINING ATTORNEY

SN 77-564,202. CHEN INVESTMENT GROUP, INC., CHARLOTTE, NC. FILED 9-8-2008.

Room 112

THE MARK CONSISTS OF STANDARD CHARACTERS WITHOUT CLAIM TO ANY PARTICULAR FONT, STYLE, SIZE, OR COLOR.

FOR BAR AND RESTAURANT SERVICES (U.S. CLS. 100 AND 101).

MICHAEL KEATING, EXAMINING ATTORNEY

SN 77-564,581. GLYNN, KEITH, LAS VEGAS, NV. FILED 9-8-2008.

NachoDaddy

THE MARK CONSISTS OF STANDARD CHARACTERS WITHOUT CLAIM TO ANY PARTICULAR FONT, STYLE, SIZE, OR COLOR.

FOR RESTAURANT AND BAR SERVICES (U.S. CLS. 100 AND 101).

MARK RADEMACHER, EXAMINING ATTORNEY

CLASS 43—(Continued).

SN 77-565,014. CALAMOS PROPERTY HOLDINGS LLC, NAPERVILLE, IL. FILED 9-8-2008.

SUGARTOAD

THE MARK CONSISTS OF STANDARD CHARACTERS WITHOUT CLAIM TO ANY PARTICULAR FONT, STYLE, SIZE, OR COLOR.
FOR HOTEL, BAR AND RESTAURANT SERVICES (U.S. CLS. 100 AND 101).
DAVID COLLIER, EXAMINING ATTORNEY

CLASS 43—(Continued).

SN 77-566,457. LARRY HARMON PICTURES CORPORATION, HOLLYWOOD, CA. FILED 9-10-2008.

OZOB'S

THE MARK CONSISTS OF STANDARD CHARACTERS WITHOUT CLAIM TO ANY PARTICULAR FONT, STYLE, SIZE, OR COLOR.
FOR RESTAURANT AND SNACK BAR SERVICES (U.S. CLS. 100 AND 101).
ANGELA M. MICHELI, EXAMINING ATTORNEY

SN 77-565,026. CALAMOS PROPERTY HOLDINGS LLC, NAPERVILLE, IL. FILED 9-8-2008.



THE MARK CONSISTS OF THE WORD "SUGARTOAD" IN A STYLIZED FONT, ABOVE A DESIGN OF A TOAD DEPICTED BY A CURVE WITH TWO DOTS.
FOR HOTEL, BAR AND RESTAURANT SERVICES (U.S. CLS. 100 AND 101).
DAVID COLLIER, EXAMINING ATTORNEY

SN 77-566,502. THE PLAYHOUSE CAFE LLC, LEMOYNE, PA. FILED 9-10-2008.

THE PLAYHOUSE CAFE

THE MARK CONSISTS OF STANDARD CHARACTERS WITHOUT CLAIM TO ANY PARTICULAR FONT, STYLE, SIZE, OR COLOR.
NO CLAIM IS MADE TO THE EXCLUSIVE RIGHT TO USE 'CAFE', APART FROM THE MARK AS SHOWN.
FOR CAFE (U.S. CLS. 100 AND 101).
KAREN K. BUSH, EXAMINING ATTORNEY

SN 77-565,546. HELLER, RICHARD, LOS ANGELES, CA. FILED 9-9-2008.

DemBones.com

THE MARK CONSISTS OF STANDARD CHARACTERS WITHOUT CLAIM TO ANY PARTICULAR FONT, STYLE, SIZE, OR COLOR.
FOR RESTAURANT; RESTAURANT SERVICES, INCLUDING SIT-DOWN SERVICE OF FOOD AND TAKE-OUT RESTAURANT SERVICES (U.S. CLS. 100 AND 101).
KATHERINE M. DUBRAY, EXAMINING ATTORNEY

SN 77-566,962. AKHENATON INDUSTRIES S.A., SAN JOSÉ, COSTA RICA, FILED 9-10-2008.

NIKKLAS

THE MARK CONSISTS OF STANDARD CHARACTERS WITHOUT CLAIM TO ANY PARTICULAR FONT, STYLE, SIZE, OR COLOR.
FOR RESTAURANT SERVING INTERNATIONAL FOOD (U.S. CLS. 100 AND 101).
CARRIE GENOVESE, EXAMINING ATTORNEY

CLASS 43—(Continued).

SN 77-567,410. POT LIKKER CREATIONS, LLC, ATLANTA, GA. FILED 9-11-2008.

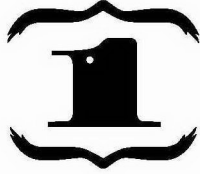
**ONE FLEW SOUTH**

THE MARK CONSISTS OF A STYLIZED NUMBER "1" WITHIN HORIZONTAL CURLY BRACKETS WITH "ONE FLEW SOUTH" WRITTEN UNDERNEATH.

FOR FULL SERVICE RESTAURANT SERVICES (U.S. CLS. 100 AND 101).

REBECCA SMITH, EXAMINING ATTORNEY

CLASS 43—(Continued).

SN 77-567,515. ICON GROUP SJT LLC, NEW YORK, NY. FILED 9-11-2008.



THE COLOR(S) BLUE IS/ARE CLAIMED AS A FEATURE OF THE MARK.

THE MARK CONSISTS OF THE WORDS "LA CONDESA" IN BLUE AND WHITE BLOCK LETTERS.

THE FOREIGN WORDING IN THE MARK TRANSLATES INTO ENGLISH AS THE COUNTESS.

FOR BAR AND RESTAURANT SERVICES (U.S. CLS. 100 AND 101).

FIRST USE 2-9-2008; IN COMMERCE 2-9-2008.

PATRICIA EVANKO, EXAMINING ATTORNEY

SN 77-567,418. CHIPOTLE MEXICAN GRILL, INC., DENVER, CO. FILED 9-11-2008.



OWNER OF U.S. REG. NOS. 2,202,863 AND 2,949,842. THE MARK CONSISTS OF THE STYLIZED DESIGN OF A PEPPER ON A SQUARE BACKGROUND.

FOR RESTAURANT SERVICES; TAKE-OUT RESTAURANT SERVICES (U.S. CLS. 100 AND 101).

FIRST USE 8-28-2008; IN COMMERCE 8-28-2008.

DAVID TAYLOR, EXAMINING ATTORNEY

SN 77-568,113. SOUTH PHILLY, INC., ELIZABETH, CO. FILED 9-11-2008.

JEET?

THE MARK CONSISTS OF STANDARD CHARACTERS WITHOUT CLAIM TO ANY PARTICULAR FONT, STYLE, SIZE, OR COLOR.

FOR RESTAURANT SERVICES (U.S. CLS. 100 AND 101).

FIRST USE 1-1-2004; IN COMMERCE 1-1-2004.

KATHERINE M. DUBRAY, EXAMINING ATTORNEY

SN 77-569,966. DISNEY ENTERPRISES, INC., BURBANK, CA. FILED 9-15-2008.

DISNEY VACATION CONNECTION

THE MARK CONSISTS OF STANDARD CHARACTERS WITHOUT CLAIM TO ANY PARTICULAR FONT, STYLE, SIZE, OR COLOR.

NO CLAIM IS MADE TO THE EXCLUSIVE RIGHT TO USE "VACATION", APART FROM THE MARK AS SHOWN.

FOR PROVIDING PERSONALIZED INFORMATION ABOUT HOTELS AND TEMPORARY ACCOMMODATIONS FOR TRAVEL VIA THE INTERNET; PROVIDING TRAVEL LODGING INFORMATION SERVICES AND TRAVEL LODGING BOOKING AGENCY SERVICES FOR TRAVELERS; TRAVEL AGENCY SERVICES, NAMELY, MAKING RESERVATIONS AND BOOKING FOR TEMPORARY LODGING, RESTAURANTS, AND MEALS (U.S. CLS. 100 AND 101).

ALLISON HALL, EXAMINING ATTORNEY

SN 77-567,481. POT LIKKER CREATIONS, LLC, ATLANTA, GA. FILED 9-11-2008.

POT LIKKER CREATIONS

THE MARK CONSISTS OF STANDARD CHARACTERS WITHOUT CLAIM TO ANY PARTICULAR FONT, STYLE, SIZE, OR COLOR.

FOR FULL SERVICE RESTAURANT SERVICES (U.S. CLS. 100 AND 101).

REBECCA SMITH, EXAMINING ATTORNEY

CLASS 43—(Continued).

SN 77-573,703. FIRST RESPONSE STRUCTURES CORPORATION, DBA READY CORPORATION, INDIANAPOLIS, IN. FILED 9-18-2008.



NO CLAIM IS MADE TO THE EXCLUSIVE RIGHT TO USE "CORPORATION", APART FROM THE MARK AS SHOWN.

THE COLOR(S) GREEN IS/ARE CLAIMED AS A FEATURE OF THE MARK.

THE MARK CONSISTS OF A GREEN SQUARE WITH A LINE CUT OUT OF THE UPPER PORTION OF THE SQUARE AS WELL AS THE WORDS "READY CORPORATION" CUT OUT IN CAPITAL LETTERS.

FOR EMERGENCY SHELTER SERVICES, NAMELY, PROVIDING TEMPORARY HOUSING (U.S. CLS. 100 AND 101).

JESSICA A. POWERS, EXAMINING ATTORNEY

SN 79-056,204. ALILA; INTERNATIONAL SERVICES CORPORATION, SINGAPORE, FILED 6-2-2008.



OWNER OF INTERNATIONAL REGISTRATION 0970531 DATED 6-2-2008, EXPIRES 6-2-2018.

THE MARK CONSISTS OF THE WORD "ALILA" IN STYLIZED FONT WITHIN A RECTANGULAR BACKGROUND.

FOR PROVIDING TEMPORARY ACCOMMODATION; MAKING RESERVATIONS FOR TEMPORARY ACCOMMODATIONS; HOLIDAY RESORT CAMP LODGING SERVICES; FOOD AND DRINK CATERING; HOTEL RESERVATION SERVICES; HOTELS; RENTAL OF CHAIRS, TABLES, TABLE LINEN, GLASSWARE FOR USE IN TEMPORARY HOUSING ACCOMMODATIONS, FOR SPECIAL OCCASIONS, FOR RECREATIONAL USE, FOR MEETING ROOMS; PROVIDING MEETING ROOMS; MAKING RESERVATIONS FOR MEETING ROOMS (U.S. CLS. 100 AND 101).

CARYN GLASSER, EXAMINING ATTORNEY

CLASS 44—MEDICAL, BEAUTY AND AGRICULTURAL SERVICES

SN 76-685,040. BOSS, WILLIAM K., JR., HACKENSACK, NJ. FILED 12-18-2007.

COOL LIFT

THE MARK CONSISTS OF STANDARD CHARACTERS WITHOUT CLAIM TO ANY PARTICULAR FONT, STYLE, SIZE, OR COLOR.

NO CLAIM IS MADE TO THE EXCLUSIVE RIGHT TO USE "LIFT", APART FROM THE MARK AS SHOWN.

FOR FACIAL PLASTIC SURGERY PROCEDURES (U.S. CLS. 100 AND 101).

REGINA DRUMMOND, EXAMINING ATTORNEY

SN 76-687,460. KIERNAN, JAMES E., ROCKAWAY PARK, NY. FILED 3-7-2008.

THE TWIST

THE MARK CONSISTS OF STANDARD CHARACTERS WITHOUT CLAIM TO ANY PARTICULAR FONT, STYLE, SIZE, OR COLOR.

FOR MEDICAL ANALYSIS AND SERVICES FOR HUMAN OR ANIMAL RELATED TO THE TREATMENT OF STRESS INDUCED PAIN AND AFFLICTIONS IN DIFFERENT PARTS OF THE BODY (U.S. CLS. 100 AND 101).

FIRST USE 9-12-2006; IN COMMERCE 9-12-2006.

DAVID TOOLEY, EXAMINING ATTORNEY

SN 76-687,528. SINGLETON EYE, INC., MYRTLE BEACH, SC. FILED 3-10-2008.

MedEyes

THE MARK CONSISTS OF STANDARD CHARACTERS WITHOUT CLAIM TO ANY PARTICULAR FONT, STYLE, SIZE, OR COLOR.

FOR OPTOMETRIC EYE CARE SERVICES, NAMELY, PROVIDING EYE EXAMS AND PRE- AND POST-OPERATIVE SURGICAL CARE; PROVIDING OPTICAL SERVICES, NAMELY, FITTING OF OPTICAL LENSES AND EYEGLASS FITTING (U.S. CLS. 100 AND 101).

FIRST USE 1-1-2008; IN COMMERCE 1-1-2008.

PAM WILLIS, EXAMINING ATTORNEY

CLASS 44—(Continued).

SN 77-274,597. GENECARE MEDICAL GENETICS CENTER, CHAPEL HILL, NC. FILED 9-7-2007.

QUICK FISH

THE MARK CONSISTS OF STANDARD CHARACTERS WITHOUT CLAIM TO ANY PARTICULAR FONT, STYLE, SIZE, OR COLOR.

NO CLAIM IS MADE TO THE EXCLUSIVE RIGHT TO USE "FISH", APART FROM THE MARK AS SHOWN.

FOR PRENATAL GENETIC TESTING FOR MEDICAL PURPOSES AND RELATED COUNSELING (U.S. CLS. 100 AND 101).

FIRST USE 2-21-2002; IN COMMERCE 2-21-2002.
CHRIS WELLS, EXAMINING ATTORNEY

SN 77-358,424. ARNETT, JEAN, BURNABY, CANADA, FILED 12-21-2007.

AVYONCE COSMEDI SPA

THE MARK CONSISTS OF STANDARD CHARACTERS WITHOUT CLAIM TO ANY PARTICULAR FONT, STYLE, SIZE, OR COLOR.

PRIORITY CLAIMED UNDER SEC. 44(D) ON CANADA APPLICATION NO. 1354191, FILED 7-3-2007, REG. NO. TMA714031, DATED 5-9-2008, EXPIRES 5-9-2023.

NO CLAIM IS MADE TO THE EXCLUSIVE RIGHT TO USE "COSMETIC SPA", APART FROM THE MARK AS SHOWN.

FOR DAY SPA SERVICES, NAMELY, NAIL CARE, MANICURES AND PEDICURES; HEALTH SPA SERVICES, NAMELY, COSMETIC BODY CARE SERVICES; HEALTH SPA SERVICES FOR HEALTH AND WELLNESS OF THE MIND, BODY AND SPRIT; FACIAL TREATMENT SERVICES, NAMELY, COSMETIC PEELS; SKIN CARE SALONS; COSMETIC VEIN TREATMENT AND THERAPIES; PROVIDING SKIN REJUVENATION, FACIALS, EXFOLIATIONS, SKIN PEELS, MOISTURIZING MASQUES, AND MICRODERMABRASION; HAIR REMOVAL TREATMENT; COSMETIC FACE AND BODY SCULPTING AND CONTOURING; SKIN TREATMENT, NAMELY, THE INJECTION OF DERMAL FILLERS AND FACIAL FILLERS TO REDUCE THE APPEARANCE OF FACIAL FINE LINES; PROVIDING CELLULITE REDUCTION TREATMENT; MASSAGE THERAPY; MANICURES AND PEDICURES; ANTI-AGING SKIN THERAPIES; COUNSELING SERVICES IN THE FIELD OF LIFESTYLE WELLNESS; PHYSICAL THERAPY FOR PAIN MANAGEMENT (U.S. CLS. 100 AND 101).

TRACY CROSS, EXAMINING ATTORNEY

CLASS 44—(Continued).

SN 77-372,500. ASSURED HEALTHCARE, LLC, GURNEE, IL. FILED 1-15-2008.

ASSURED HEALTHCARE

THE MARK CONSISTS OF STANDARD CHARACTERS WITHOUT CLAIM TO ANY PARTICULAR FONT, STYLE, SIZE, OR COLOR.

NO CLAIM IS MADE TO THE EXCLUSIVE RIGHT TO USE "HEALTHCARE", APART FROM THE MARK AS SHOWN.

FOR MEDICAL SERVICES, NAMELY, TREATING PATIENTS IN NURSING HOMES, HOSPITALS AND MEDICAL CENTERS PROVIDED BY REGISTERED NURSES, LPNS, CNAS, MEDICAL OFFICE STAFF, PHLEBOTOMISTS, PHARMACISTS, PHARMACY TECHS, PARAMEDICS, EMTS, PHYSICAL, OCCUPATIONAL AND SPEECH THERAPISTS, " IN CLASS 44 (U.S. CLS. 100 AND 101).

SUSAN STIGLITZ, EXAMINING ATTORNEY

SN 77-381,626. COX, TONY, GREENBRAE, CA. FILED 1-28-2008.

TONIX

THE MARK CONSISTS OF STANDARD CHARACTERS WITHOUT CLAIM TO ANY PARTICULAR FONT, STYLE, SIZE, OR COLOR.

FOR HAIR SALON SERVICES, NAMELY, HAIR CUTTING, STYLING AND COLORING SERVICES, MANICURE SERVICES, PEDICURE SERVICES (U.S. CLS. 100 AND 101).

THOMAS MANOR, EXAMINING ATTORNEY

CLASS 44—(Continued).

SN 77-385,465. BEYOND THE IMAGE MEDSPA, LLC, DBA KHARA SPA, CARMEL, IN. FILED 1-31-2008.



NO CLAIM IS MADE TO THE EXCLUSIVE RIGHT TO USE "SPA, APART FROM THE MARK AS SHOWN.
 THE MARK CONSISTS OF A SILHOUETTE OF A PERSON TO THE LEFT OF THE WORDS "KHARA SPA STRIKE A BALANCE."
 THE ENGLISH TRANSLATION OF THE WORD "KHARA" IN THE MARK IS "TO STRIKE A BALANCE".
 FOR HEALTH SPA SERVICES, NAMELY, COSMETIC BODY CARE SERVICES; MEDICAL SERVICES, NAMELY, COSMETIC SURGERY (U.S. CLS. 100 AND 101).
 FIRST USE 9-0-2006; IN COMMERCE 9-0-2006.
 ANGELA GAW, EXAMINING ATTORNEY

CLASS 44—(Continued).

SN 77-402,633. MICHIGAN ORTHOPAEDICS AND SPORTS MEDICINE, PC, GRAND RAPIDS, MI. FILED 2-21-2008.

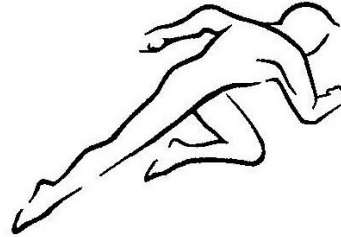

THE MARK CONSISTS OF A RUNNING ATHLETE.
 FOR PHYSICIAN SERVICES; MEDICAL SERVICES IN THE FIELDS OF ORTHOPAEDICS AND SPORTS MEDICINE (U.S. CLS. 100 AND 101).
 FIRST USE 8-20-2001; IN COMMERCE 8-20-2001.
 AMOS T. MATTHEWS, JR., EXAMINING ATTORNEY

SN 77-401,416. PHYSICIANS HEALTH PLAN OF MID-MICHIGAN, LANSING, MI. FILED 2-20-2008.



THE MARK CONSISTS OF A BUTTERFLY WITH A HEART IN THE CENTER AND THE OUTSIDE OF EACH WING REPRESENTING A HUMAN SILHOUETTE.
 FOR COMPREHENSIVE HEALTHCARE SERVICES (U.S. CLS. 100 AND 101).
 FIRST USE 0-0-1985; IN COMMERCE 0-0-1985.
 KAREN K. BUSH, EXAMINING ATTORNEY

SN 77-413,439. REDMONT HEALTH SERVICES, INC., BIRMINGHAM, AL. FILED 3-5-2008.



NO CLAIM IS MADE TO THE EXCLUSIVE RIGHT TO USE "HEALTH SERVICES", APART FROM THE MARK AS SHOWN.
 THE MARK CONSISTS OF A RECTANGLE WITH AN ARTISTIC RENDERING OF MOUNTAIN RANGES WITH THE WORDS "REDMONT HEALTH SERVICES" BELOW.
 FOR REHABILITATION OF ALCOHOL AND DRUG ADDICTED PERSONS (U.S. CLS. 100 AND 101).
 TIMOTHY FINNEGAN, EXAMINING ATTORNEY

CLASS 44—(Continued).

SN 77-422,193. VIENNA PEDIATRIC DENTISTRY, P.C.,
VIENNA, VA. FILED 3-14-2008.



THE COLOR(S) WHITE, BLUE, GREEN, BROWN, PEACH, ORANGE, PINK, TEAL, BLACK, GRAY AND PURPLE IS/ ARE CLAIMED AS A FEATURE OF THE MARK.

THE MARK CONSISTS OF A DESIGN OF TWO KIDS SITTING ON A TOOTHBRUSH WITH THEIR HANDS UP IN THE AIR. THE COLORS WHITE, BLUE, GREEN, BROWN, PEACH, ORANGE, PINK, TEAL, BLACK, GRAY, AND PURPLE ARE CLAIMED WITH THE COLOR WHITE APPEARING IN THE TOOTHBRUSH BRISTLES, IN THE CHILDREN'S EYES AND MOUTHS, AND IN THE GIRL'S DRESS, THE COLOR BLUE APPEARS IN THE BRISTLE OF THE TOOTHBRUSH AND IN THE BOY'S SHORTS, THE COLOR GREEN APPEARS IN THE TOOTHBRUSH HANDLE, THE COLOR BROWN APPEARS IN THE CHILDREN'S HAIR, EYES, AND EYEBROWS, AND IN THE BOY'S LIPS, THE COLOR PEACH APPEARS AS THE CHILDREN'S SKIN COLOR, AND ON THE BOY'S SHOES, THE COLOR ORANGE APPEARS ON THE CHILDREN'S SKIN, ON THE CHILDREN'S SOCKS, ON THE GIRL'S LIPS, HAIR BOW AND SHIRT, THE COLOR PINK APPEARS ON THE BOY'S SUSPENDERS AND CHILDREN'S SOCKS, THE COLOR TEAL APPEARS IN THE BOY'S SHIRT AND THE GIRL'S SUSPENDERS, THE COLOR BLACK APPEARS IN THE CHILDREN'S PUPILS, THE COLOR GRAY APPEARS AS AN OUTLINE OF THE TOOTHBRUSH BRISTLES AND CHILDREN'S BODIES, AND THE COLOR PURPLE APPEARS ON THE GIRL'S SHOES.

FOR DENTIST SERVICES TO INFANTS, CHILDREN, ADOLESCENTS AND PATIENTS WITH SPECIAL NEEDS (U.S. CLS. 100 AND 101).

FIRST USE 9-10-2007; IN COMMERCE 10-0-2007.
LANA PHAM, EXAMINING ATTORNEY

SN 77-428,568. FALL CREEK FARM AND NURSERY, INC.,
LOWELL, OR. FILED 3-21-2008.

FALL CREEK

THE MARK CONSISTS OF STANDARD CHARACTERS WITHOUT CLAIM TO ANY PARTICULAR FONT, STYLE, SIZE, OR COLOR.

FOR PLANT NURSERY SERVICES (U.S. CLS. 100 AND 101).

FIRST USE 0-0-1997; IN COMMERCE 0-0-1997.
STEVEN JACKSON, EXAMINING ATTORNEY

CLASS 44—(Continued).

SN 77-428,667. FALL CREEK FARM AND NURSERY, INC.,
LOWELL, OR. FILED 3-21-2008.

FALL CREEK FARM & NURSERY,
INC.

THE MARK CONSISTS OF STANDARD CHARACTERS WITHOUT CLAIM TO ANY PARTICULAR FONT, STYLE, SIZE, OR COLOR.

NO CLAIM IS MADE TO THE EXCLUSIVE RIGHT TO USE "FARM & NURSERY, INC.", APART FROM THE MARK AS SHOWN.

FOR PLANT NURSERY SERVICES (U.S. CLS. 100 AND 101).

FIRST USE 0-0-1986; IN COMMERCE 0-0-1986.
STEVEN JACKSON, EXAMINING ATTORNEY

SN 77-434,768. FALL CREEK FARM AND NURSERY, INC.,
LOWELL, OR. FILED 3-28-2008.



NO CLAIM IS MADE TO THE EXCLUSIVE RIGHT TO USE "FARM & NURSERY, INC.", APART FROM THE MARK AS SHOWN.

THE MARK CONSISTS OF THE WORDS "FALL CREEK" WITH THE STEM OF A BLUEBERRY PLANT EXTENDING THROUGH THE LETTER "C" IN THE WORD "CREEK". THERE ARE FOUR BLUEBERRIES AND FOUR LEAVES ON THE BLUEBERRY PLANT. THE WORDS "FALL CREEK" ARE UNDERLINED AND BENEATH THE UNDERLINE ARE THE WORDS "FARM & NURSERY, INC." FOR PLANT NURSERY SERVICES (U.S. CLS. 100 AND 101).

FIRST USE 8-0-2007; IN COMMERCE 8-0-2007.
STEVEN JACKSON, EXAMINING ATTORNEY

SN 77-434,824. FALL CREEK FARM AND NURSERY, INC.,
LOWELL, OR. FILED 3-28-2008.



NO CLAIM IS MADE TO THE EXCLUSIVE RIGHT TO USE "FARM & NURSERY, INC.", APART FROM THE MARK AS SHOWN.

THE MARK CONSISTS OF THE WORDS "FALL CREEK" WITH A BLUEBERRY PLANT EXTENDING BETWEEN THE WORDS "FALL" AND "CREEK". THERE ARE FOUR BLUEBERRIES AND FOUR LEAVES ON THE BLUEBERRY PLANT. THE WORDS "FARM & NURSERY, INC." ARE BENEATH THE WORDS "FALL CREEK", AND THE STEM OF THE BLUEBERRY PLANT EXTENDS BETWEEN THE LETTERS "U" AND "R" IN THE WORD "NURSERY". FOR PLANT NURSERY SERVICES (U.S. CLS. 100 AND 101).

FIRST USE 8-0-2007; IN COMMERCE 8-0-2007.
STEVEN JACKSON, EXAMINING ATTORNEY

CLASS 44—(Continued).

SN 77-452,851. SURF CUT STYLE LLC, MANHATTAN BEACH, CA. FILED 4-20-2008.

Surf Cuts

THE MARK CONSISTS OF STANDARD CHARACTERS WITHOUT CLAIM TO ANY PARTICULAR FONT, STYLE, SIZE, OR COLOR.

NO CLAIM IS MADE TO THE EXCLUSIVE RIGHT TO USE "CUTS", APART FROM THE MARK AS SHOWN.

FOR HAIR SALON SERVICES, NAMELY, HAIR CUTTING, STYLING, COLORING, AND HAIR EXTENSION SERVICES (U.S. CLS. 100 AND 101).

FIRST USE 2-4-2008; IN COMMERCE 2-4-2008.
JANICE L. MCMORROW, EXAMINING ATTORNEY

CLASS 44—(Continued).

SN 77-498,994. PASSPORT TO INDEPENDENCE, LLC, NAMPA, ID. FILED 6-13-2008.

PASSPORT TO INDEPENDENCE

THE MARK CONSISTS OF STANDARD CHARACTERS WITHOUT CLAIM TO ANY PARTICULAR FONT, STYLE, SIZE, OR COLOR.

FOR OCCUPATIONAL THERAPY SERVICES (U.S. CLS. 100 AND 101).

STEPHANIE ALI, EXAMINING ATTORNEY

SN 77-458,277. JOHNSON, IAN PAUL, RICHMOND, VA. FILED 4-25-2008.



NO CLAIM IS MADE TO THE EXCLUSIVE RIGHT TO USE "LANDSCAPES", APART FROM THE MARK AS SHOWN.

THE COLOR(S) GREEN IS/ARE CLAIMED AS A FEATURE OF THE MARK.

THE MARK CONSISTS OF THE WORDING "GREENER LANDSCAPES" IN STYLIZED TEXT

FOR ENVIRONMENTALLY FRIENDLY LANDSCAPE DESIGN AND GARDENING (U.S. CLS. 100 AND 101).

REBECCA EISINGER, EXAMINING ATTORNEY

SN 77-510,992. MARTIN, GAYLE, LOS ANGELES, CA. FILED 6-30-2008.

California Landscapes

THE MARK CONSISTS OF STANDARD CHARACTERS WITHOUT CLAIM TO ANY PARTICULAR FONT, STYLE, SIZE, OR COLOR.

NO CLAIM IS MADE TO THE EXCLUSIVE RIGHT TO USE "LANDSCAPES", APART FROM THE MARK AS SHOWN.

SEC. 2(F).

FOR LANDSCAPE DESIGN (U.S. CLS. 100 AND 101).

FIRST USE 8-24-1992; IN COMMERCE 8-24-1992.

MAYUR VAGHANI, EXAMINING ATTORNEY

SN 77-475,677. STARR COMMONWEALTH, ALBION, MI. FILED 5-15-2008.

MONTCALM HOMESTRETCH

THE MARK CONSISTS OF STANDARD CHARACTERS WITHOUT CLAIM TO ANY PARTICULAR FONT, STYLE, SIZE, OR COLOR.

FOR MEDICAL, PSYCHOLOGICAL, AND THERAPEUTIC EVALUATION SERVICES FOR ADOLESCENT MALES AND FEMALES, NAMELY, FUNCTIONAL ASSESSMENT PROGRAMS FOR ADOLESCENTS RECEIVING MEDICAL AND PSYCHOLOGICAL THERAPEUTIC REHABILITATION SERVICES FOR PURPOSES OF GUIDING TREATMENT AND ASSESSING PROGRAM EFFECTIVENESS AND PLANNING FOR FUTURE TREATMENTS; THERAPEUTIC SERVICES FOR AT-RISK ADOLESCENTS AND THEIR FAMILIES, PRIMARILY IN A COMMUNITY SETTING (U.S. CLS. 100 AND 101).

GINA FINK, EXAMINING ATTORNEY

SN 77-520,080. DEAN, MICHELLE RAE, DBA BARBERELLA BEAUTY LOUNGE, BERKELEY, CA. FILED 7-11-2008.



NO CLAIM IS MADE TO THE EXCLUSIVE RIGHT TO USE "BEAUTY LOUNGE", APART FROM THE MARK AS SHOWN.

THE MARK CONSISTS OF THE WORDS "BARBERELLA BEAUTY LOUNGE" IN STYLIZED WRITING, FRAMED BY LINES.

FOR BEAUTY SALONS; BODY WAXING SERVICES; FACIAL TREATMENT SERVICES, NAMELY, COSMETIC PEELS; HAIR SALON SERVICES; HAIR SALON SERVICES, NAMELY, HAIR CUTTING, STYLING, COLORING, AND HAIR EXTENSION SERVICES (U.S. CLS. 100 AND 101).

FIRST USE 6-18-2002; IN COMMERCE 6-18-2002.

JULIE VEPPUMTHARA, EXAMINING ATTORNEY

CLASS 44—(Continued).

SN 77-525,622. MOOLJI, BEEZER, MAYWOOD, IL. FILED 7-18-2008.

First Peek Ultrasound

THE MARK CONSISTS OF STANDARD CHARACTERS WITHOUT CLAIM TO ANY PARTICULAR FONT, STYLE, SIZE, OR COLOR.

NO CLAIM IS MADE TO THE EXCLUSIVE RIGHT TO USE "ULTRASOUND", APART FROM THE MARK AS SHOWN.

FOR MEDICAL IMAGING SERVICES (U.S. CLS. 100 AND 101).

DANIEL CAPSHAW, EXAMINING ATTORNEY

SN 77-525,643. RENOWN HEALTH, RENO, NV. FILED 7-18-2008.

Renown Institute for Heart & Vascular Health

THE MARK CONSISTS OF STANDARD CHARACTERS WITHOUT CLAIM TO ANY PARTICULAR FONT, STYLE, SIZE, OR COLOR.

OWNER OF U.S. REG. NOS. 3,482,505 AND 3,486,524.

NO CLAIM IS MADE TO THE EXCLUSIVE RIGHT TO USE "INSTITUTE FOR HEART & VASCULAR HEALTH", APART FROM THE MARK AS SHOWN.

FOR INPATIENT AND OUTPATIENT MEDICAL SERVICES, CARDIAC CATHETERIZATION LAB SERVICES, MEDICAL NON-INVASIVE DIAGNOSTIC SERVICES, SPECIALIZED NURSING SERVICES, MEDICAL TELEMETRY SERVICES, CARDIAC INTENSIVE CARE UNIT SERVICES, CARDIOPULMONARY REHABILITATION, HEART HEALTH AND WELLNESS PROGRAMS (U.S. CLS. 100 AND 101).

FIRST USE 6-17-2008; IN COMMERCE 6-17-2008.

JOHN WILKE, EXAMINING ATTORNEY

SN 77-526,708. XASE XETECHE CORPORATION, DBA XASE XETECHE CORPORATION, LEAGUE CITY, TX. FILED 7-20-2008.



Flawless Features

NO CLAIM IS MADE TO THE EXCLUSIVE RIGHT TO USE "FEATURES", APART FROM THE MARK AS SHOWN. THE MARK CONSISTS OF THE LETTERS "F", "F", "M" INSIDE A CIRCLE AND THE WORDING "FLAWLESS FEATURES" APPEARING TO THE RIGHT OF THE CIRCLE.

FOR CONSULTATION SERVICES IN THE FIELD OF MAKEUP, NAMELY, ON-LINE MAKEUP CONSULTATION SERVICES AND IN-PERSON MAKEUP CONSULTATION AND APPLICATION SERVICES (U.S. CLS. 100 AND 101).

ELIZABETH KAJUBI, EXAMINING ATTORNEY

CLASS 44—(Continued).

SN 77-528,393. THE TRUSTEES OF THE UNIVERSITY OF PENNSYLVANIA, PHILADELPHIA, PA. FILED 7-22-2008.



OWNER OF U.S. REG. NOS. 1,915,677, 3,052,721 AND 3,179,143.

NO CLAIM IS MADE TO THE EXCLUSIVE RIGHT TO USE "SURVIVORSHIP CARE PLAN", APART FROM THE MARK AS SHOWN.

THE MARK CONSISTS OF THE COLOR YELLOW IN THE LETTER "O"; THE COLOR BROWN IN THE TRUNK AND BRANCHES OF THE TREE; THE COLOR GREEN IN THE LEAVES; THE COLOR PURPLE IN THE STETHOSCOPE WRAPPED AROUND THE LETTER "O" AND IN THE WORDING "SURVIVORSHIP CARE PLAN"; AND THE COLOR BLACK APPEARS IN THE LETTERING "ONCO-LIFE".

FOR PROVIDING AN ON-LINE, PATIENT-INITIATED MEDICAL SERVICE DESIGNED TO PROVIDE CANCER SURVIVORS WITH AN INDIVIDUALIZED CARE PLAN (U.S. CLS. 100 AND 101).

FIRST USE 5-15-2007; IN COMMERCE 5-15-2007.

CAROL SPILS, EXAMINING ATTORNEY

SN 77-534,521. PERFORMANCE HEALTH CENTER, LLC, NATICK, MA. FILED 7-30-2008.

PERFORMANCE HEALTH CENTER

THE MARK CONSISTS OF STANDARD CHARACTERS WITHOUT CLAIM TO ANY PARTICULAR FONT, STYLE, SIZE, OR COLOR.

NO CLAIM IS MADE TO THE EXCLUSIVE RIGHT TO USE "HEALTH CENTER", APART FROM THE MARK AS SHOWN.

FOR CHIROPRACTICS, MASSAGE, NUTRITION COUNSELING (U.S. CLS. 100 AND 101).

FIRST USE 3-0-2007; IN COMMERCE 3-0-2007.

ROBIN CHOSID, EXAMINING ATTORNEY

CLASS 44—(Continued).

SN 77-544,252. PETINAUD, JENNIFER, DBA NULL, CLAREMONT, CA. AND JACKSON, MARVA, CLAREMONT, CA. FILED 8-11-2008.



NO CLAIM IS MADE TO THE EXCLUSIVE RIGHT TO USE "PERSONAL WELLNESS", APART FROM THE MARK AS SHOWN.

THE MARK CONSISTS OF THE DRAWING OF A MAN AND WOMAN, BOTH KNEELING, FACING EACH OTHER WITH THEIR ARMS EXTENDED AND THEIR PALMS OPEN AND TOUCHING, OVER THE STYLIZED WORDING "KEEP U WELL" WHICH IS UNDERLINED AND SITTING ABOVE THE STYLIZED WORDING "PERSONAL WELLNESS", WHICH FORMS AN UPSIDE-DOWN ARC, AND "A NATURAL APPROACH TO GOOD HEALTH", WHICH IS STRAIGHT ALONG THE BOTTOM OF THE MARK.

FOR WELLNESS SERVICES, NAMELY, FACIALS, MASSAGES AND MAKEUP (U.S. CLS. 100 AND 101). KEVON CHISOLM, EXAMINING ATTORNEY

CLASS 44—(Continued).

SN 77-557,833. HEALTH FUTURE, LLC, MEDFORD, OR. FILED 8-28-2008.

Motivate Me

THE MARK CONSISTS OF STANDARD CHARACTERS WITHOUT CLAIM TO ANY PARTICULAR FONT, STYLE, SIZE, OR COLOR.

FOR HEALTH CARE SERVICES, NAMELY, WELLNESS PROGRAMS; PROVIDING A WEB SITE FEATURING INFORMATION IN THE FIELD OF MENTAL HEALTH AND WELLNESS; PROVIDING ASSISTANCE, FITNESS EVALUATION AND CONSULTATION TO CORPORATE CLIENTS TO HELP THEIR EMPLOYEES MAKE HEALTH, WELLNESS AND NUTRITIONAL CHANGES IN THEIR DAILY LIVING TO IMPROVE HEALTH; PROVIDING ASSISTANCE, FITNESS EVALUATION AND CONSULTATION TO INDIVIDUALS TO HELP THEM MAKE HEALTH, WELLNESS AND NUTRITIONAL CHANGES IN THEIR DAILY LIVING TO IMPROVE HEALTH; PROVIDING WELLNESS SERVICES, NAMELY, PERSONAL ASSESSMENTS, PERSONALIZED ROUTINES, MAINTENANCE SCHEDULES, AND COUNSELING (U.S. CLS. 100 AND 101). REBECCA POVARCHUK, EXAMINING ATTORNEY

SN 77-559,248. DENTAL INNOVATIONS, INC., IRVINE, CA. FILED 8-29-2008.



NO CLAIM IS MADE TO THE EXCLUSIVE RIGHT TO USE "IMPLANT OUTREACH", APART FROM THE MARK AS SHOWN.

THE COLOR(S) BLACK, GREEN, BLUE AND WHITE IS/ARE CLAIMED AS A FEATURE OF THE MARK.

THE MARK CONSISTS OF A WHITE MEDICAL IMPLANT INSIDE A BLUE AND WHITE MEDICAL SCREW WHICH REPRESENTS THE LETTER "I". SURROUNDING THE SCREW IS A WHITE OCTAGON SHAPE. THE IMPLANT, SCREW AND OCTAGON ARE SURROUNDED BY A GREEN AND WHITE CIRCLE, WHICH IS DISPLAYED INSIDE THREE CONCENTRIC CIRCLES, IN WHITE, BLACK AND WHITE. A BLACK POLYGON IS DISPLAYED OUTSIDE THE CIRCLES AND SURROUNDS THE BASE OF THE SCREW. THE WORD "IMPLANT" IS DISPLAYED AT THE BOTTOM OF THE DESIGN IN WHITE LETTERS. THE WORD "OUTREACH" IS DISPLAYED AT THE BOTTOM OF THE DESIGN TO THE RIGHT OF "IMPLANT" IN BLACK LETTERS.

FOR DENTISTRY (U.S. CLS. 100 AND 101). RENEE SERVANCE, EXAMINING ATTORNEY

SN 77-552,862. WORKSITE WELLNESS LLC, KIRKLAND, WA. FILED 8-21-2008.

WELLMETRICS

THE MARK CONSISTS OF STANDARD CHARACTERS WITHOUT CLAIM TO ANY PARTICULAR FONT, STYLE, SIZE, OR COLOR.

FOR MEDICAL TESTING (U.S. CLS. 100 AND 101). FIRST USE 8-1-2008; IN COMMERCE 8-1-2008. SONYA STEPHENS, EXAMINING ATTORNEY

CLASS 44—(Continued).

SN 77-559,286. BARK CHICAGO, INC., CHICAGO, IL. FILED 8-29-2008.

SPABARK!, INC.

THE MARK CONSISTS OF STANDARD CHARACTERS WITHOUT CLAIM TO ANY PARTICULAR FONT, STYLE, SIZE, OR COLOR.

NO CLAIM IS MADE TO THE EXCLUSIVE RIGHT TO USE "INC.", APART FROM THE MARK AS SHOWN. FOR ANIMAL GROOMING (U.S. CLS. 100 AND 101). FIRST USE 7-25-2006; IN COMMERCE 7-25-2006. SUNG IN, EXAMINING ATTORNEY

SN 77-559,557. BODY BALANCE AND BEYOND INC., SAN MATEO, CA. FILED 8-30-2008.



THE MARK CONSISTS OF THE STYLIZED TEXT "BODY BALANCE AND BEYOND". THERE ARE CURVED LINES, BANDS AND DOTS INSIDE A CIRCLE REPRESENTING A PERSON IN A STRETCH POSITION.

FOR BODYWORK THERAPY; MASSAGE THERAPY SERVICES; PHYSICAL REHABILITATION; PHYSICAL THERAPY (U.S. CLS. 100 AND 101). FIRST USE 8-19-2003; IN COMMERCE 8-19-2003. CHRISTINE COOPER, EXAMINING ATTORNEY

CLASS 44—(Continued).

SN 77-559,934. BEYOND BELEAF, LLC, MANSFIELD, TX. FILED 9-2-2008.



NO CLAIM IS MADE TO THE EXCLUSIVE RIGHT TO USE "LAWN CARE & DESIGN SERVICES", APART FROM THE MARK AS SHOWN.

THE COLOR(S) BROWN, PEA GREEN, LIGHT GREEN AND DARK GREEN IS/ARE CLAIMED AS A FEATURE OF THE MARK.

THE MARK CONSISTS OF THE WORD "BEYOND" IN BROWN SITUATED OVER THE WORD "BELEAF" IN WHICH THE LETTERS "BEL" AND "AF" ARE IN PEA GREEN, AND THE SECOND LETTER "E" IS IN LIGHT GREEN. THE WORDING "LAWN CARE & DESIGN SERVICES" IN PEA GREEN, IS SITUATED IN A SMALLER FONT UNDER THE WORD "BELEAF". THE WORD "BELEAF" HAS AN IMAGE OF A LEAF SPROUTING FROM THE SECOND "E". THE LEAVES ARE DARK GREEN AND THE STEM OF THE LEAF IS LIGHT GREEN.

FOR PROVIDING LAWN CARE AND LANDSCAPE DESIGN SERVICES (U.S. CLS. 100 AND 101). ANDREA K. NADELMAN, EXAMINING ATTORNEY

SN 77-561,801. GUIDE DOGS FOR THE BLIND, INC., SAN RAFAEL, CA. FILED 9-3-2008.



NO CLAIM IS MADE TO THE EXCLUSIVE RIGHT TO USE "GUIDE DOGS FOR THE BLIND", APART FROM THE MARK AS SHOWN.

THE MARK CONSISTS OF BLIND PERSON WALKING WITH GUIDE DOG.

FOR CHARITABLE SERVICES, NAMELY, LENDING TRAINED GUIDE DOGS TO BLIND PEOPLE (U.S. CLS. 100 AND 101).

KATHERINE E. HALMEN, EXAMINING ATTORNEY

CLASS 44—(Continued).

SN 77-561,903. ENHOUSE AMERICA INC., BOERNE, TX. FILED 9-4-2008.



NO CLAIM IS MADE TO THE EXCLUSIVE RIGHT TO USE "LAB WORK", APART FROM THE MARK AS SHOWN. THE MARK CONSISTS OF THE IMAGE OF A HAND HOLDING A TEST TUBE, LOCATED IN BETWEEN THE WORDS "LABWORK" AND "NOW".

FOR CONDUCTING MEDICAL PHYSICAL EVALUATIONS; DRUG TESTING FOR SUBSTANCE ABUSE; DRUG USE SCREENING SERVICES; DRUG USE TESTING SERVICES; MEDICAL DIAGNOSTIC TESTING, MONITORING AND REPORTING SERVICES; MEDICAL INFORMATION, NAMELY, CONSUMER-AUTHORIZED CLINICAL LABORATORY TESTING SERVICES THAT REPORT RESULTS DIRECTLY TO THE PATIENT; MEDICAL TESTING; MEDICAL TESTING OF URINE, BLOOD, HAIR FOLLICLES AND BREATH; MEDICAL TESTING SERVICES, NAMELY, FITNESS EVALUATION (U.S. CLS. 100 AND 101).

FIRST USE 9-3-2008; IN COMMERCE 9-3-2008. ALYSSA STEEL, EXAMINING ATTORNEY

SN 77-562,256. UKW HOLDING COMPANY, NORTH MIAMI, FL. FILED 9-4-2008.

ALL WE DO IS WAX

THE MARK CONSISTS OF STANDARD CHARACTERS WITHOUT CLAIM TO ANY PARTICULAR FONT, STYLE, SIZE, OR COLOR.

FOR PERSONAL BODY AND FACIAL HAIR REMOVAL SERVICES FOR MEN, WOMEN, AND CHILDREN (U.S. CLS. 100 AND 101).

STEVEN JACKSON, EXAMINING ATTORNEY

SN 77-562,349. VICTOR J. GRASSO, JR., NAPLES, FL. FILED 9-4-2008.

ARTHRODONTICS

THE MARK CONSISTS OF STANDARD CHARACTERS WITHOUT CLAIM TO ANY PARTICULAR FONT, STYLE, SIZE, OR COLOR.

FOR DENTAL SERVICES; DENTAL SERVICES IN THE FIELD OF TEMPOROMANDIBULAR JOINT FUNCTION (U.S. CLS. 100 AND 101).

SHAILA SETTLES, EXAMINING ATTORNEY

CLASS 44—(Continued).

SN 77-562,370. H.L. GREENBERG, LAS VEGAS, NV. FILED 9-4-2008.



NO CLAIM IS MADE TO THE EXCLUSIVE RIGHT TO USE "LAS VEGAS DERMATOLOGY", APART FROM THE MARK AS SHOWN.

THE STIPLING IS A FEATURE OF THE MARK AND DOES NOT INDICATE COLOR.

THE COLOR(S) BLUE, YELLOW, WHITE IS/ARE CLAIMED AS A FEATURE OF THE MARK.

THE MARK CONSISTS OF TWO BLUE AND YELLOW FACES IN PROFILE WITH BLUE AND YELLOW FLOWERS WITH BLUE STEMS EXTENDING FROM THE PROFILE FACES. THE WORDS "LAS VEGAS DERMATOLOGY" ARE IN BLUE. THE RECTANGULAR BORDER IS IN BLUE.

FOR COSMETIC AND PLASTIC SURGERY; COSMETIC ELECTROLYSIS; FACIAL TREATMENT SERVICES, NAMELY, COSMETIC PEELS; NON-INVASIVE COSMETIC MEDICAL PROCEDURES; SURGERY (U.S. CLS. 100 AND 101).

FIRST USE 7-31-2007; IN COMMERCE 7-31-2007. JOHN E. MICHOS, EXAMINING ATTORNEY

SN 77-564,553. MEHTA, ASHOK, FULLERTON, CA. FILED 9-8-2008.

Spread The Smile!

THE MARK CONSISTS OF STANDARD CHARACTERS WITHOUT CLAIM TO ANY PARTICULAR FONT, STYLE, SIZE, OR COLOR.

FOR DENTISTRY, PROVIDING PREVENTIVE DENTAL INFORMATION AND CARE FOR UNDER PRIVILEGED CHILDREN (U.S. CLS. 100 AND 101).

KIMBERLY PERRY, EXAMINING ATTORNEY

SN 77-564,649. PROVISTA LIFE SCIENCES, LLC, PHOENIX, AZ. FILED 9-8-2008.

LymPro Score

THE MARK CONSISTS OF STANDARD CHARACTERS WITHOUT CLAIM TO ANY PARTICULAR FONT, STYLE, SIZE, OR COLOR.

NO CLAIM IS MADE TO THE EXCLUSIVE RIGHT TO USE "SCORE", APART FROM THE MARK AS SHOWN.

FOR MEDICAL TESTING SERVICES, NAMELY, CONDUCTING CLINICAL DIAGNOSTIC TESTING TO ALZHEIMER'S (U.S. CLS. 100 AND 101).

SUSAN STIGLITZ, EXAMINING ATTORNEY

CLASS 44—(Continued).

SN 77-564,759. THE MINISTRY OF THE HIGH WATCH INCORPORATED, KENT, CT. FILED 9-8-2008.



NO CLAIM IS MADE TO THE EXCLUSIVE RIGHT TO USE "RECOVERY CENTER", APART FROM THE MARK AS SHOWN.

THE MARK CONSISTS OF A HOUSE ON LAND ABOVE A WATER WAVE WITH THE WORDS "HIGH WATCH RECOVERY CENTER" UNDER THE WATER WAVE.

FOR DRUG AND ALCOHOL ABUSE AND ADDICTION TREATMENT SERVICES (U.S. CLS. 100 AND 101). FIRST USE 9-4-2008; IN COMMERCE 9-4-2008. JAMES STEIN, EXAMINING ATTORNEY

SN 77-564,823. INTERTRADE CAPITAL CORPORATION, INC., NEW YORK, NY. FILED 9-8-2008.

One Healing

THE MARK CONSISTS OF STANDARD CHARACTERS WITHOUT CLAIM TO ANY PARTICULAR FONT, STYLE, SIZE, OR COLOR.

NO CLAIM IS MADE TO THE EXCLUSIVE RIGHT TO USE "HEALING", APART FROM THE MARK AS SHOWN.

FOR MEDICAL, HYGIENIC AND BEAUTY CARE (U.S. CLS. 100 AND 101). CHRISTINA SOBRAL, EXAMINING ATTORNEY

SN 77-564,874. ASSOCIATED REHABILITATION SERVICES, INC., ST. LOUIS, MO. FILED 9-8-2008.

ASSOCIATED REHABILITATION SERVICES

THE MARK CONSISTS OF STANDARD CHARACTERS WITHOUT CLAIM TO ANY PARTICULAR FONT, STYLE, SIZE, OR COLOR.

NO CLAIM IS MADE TO THE EXCLUSIVE RIGHT TO USE "REHABILITATION SERVICES", APART FROM THE MARK AS SHOWN.

FOR PHYSICAL THERAPY SERVICES; OCCUPATIONAL THERAPY SERVICES; SPEECH THERAPY SERVICES; PHYSICAL REHABILITATION SERVICES; HEALTH CARE SERVICES, NAMELY, WELLNESS PROGRAMS (U.S. CLS. 100 AND 101).

FIRST USE 0-0-1983; IN COMMERCE 0-0-1983. PAUL E. FAHRENKOPF, EXAMINING ATTORNEY

CLASS 44—(Continued).

SN 77-565,107. THE HARTE OF CHIROPRACTIC, PROF. CORP., CORTE MADERA, CA. FILED 9-8-2008.

"WHERE CHIROPRACTIC LIVES,
SO YOU LIVE BETTER!"

THE MARK CONSISTS OF STANDARD CHARACTERS WITHOUT CLAIM TO ANY PARTICULAR FONT, STYLE, SIZE, OR COLOR.
FOR CHIROPRACTICS (U.S. CLS. 100 AND 101). DAVID MURRAY, EXAMINING ATTORNEY

SN 77-565,393. RTW, INC., BLOOMINGTON, MN. FILED 9-9-2008.

RTW EPIC

THE MARK CONSISTS OF STANDARD CHARACTERS WITHOUT CLAIM TO ANY PARTICULAR FONT, STYLE, SIZE, OR COLOR.

FOR MEDICAL SERVICES, NAMELY, CONDUCTING MEDICAL PHYSICAL EVALUATIONS FOR THE PURPOSE OF IDENTIFICATION OF INDIVIDUALS AT RISK FOR DEVELOPMENT OF CHRONIC PAIN AND FOR THE PURPOSE OF LATER ENROLLMENT IN MEDICAL TREATMENT PROGRAM FOR TREATMENT OF CHRONIC PAIN, AND MEDICAL TREATMENT IN OCCUPATIONAL CLINICS FOR CHRONIC PAIN (U.S. CLS. 100 AND 101).

KATHY DE JONGE, EXAMINING ATTORNEY

SN 77-565,400. RTW, INC., MINNEAPOLIS, MN. FILED 9-9-2008.

CHRONIC PAIN IS OF AN EPIC PROPORTION AND RTW IS THE SOLUTION

THE MARK CONSISTS OF STANDARD CHARACTERS WITHOUT CLAIM TO ANY PARTICULAR FONT, STYLE, SIZE, OR COLOR.

FOR MEDICAL SERVICES, NAMELY, CONDUCTING MEDICAL PHYSICAL EVALUATIONS FOR THE PURPOSE OF IDENTIFICATION OF INDIVIDUALS AT RISK FOR DEVELOPMENT OF CHRONIC PAIN AND FOR THE PURPOSE OF LATER ENROLLMENT IN MEDICAL TREATMENT PROGRAM FOR TREATMENT OF CHRONIC PAIN, AND MEDICAL TREATMENT IN OCCUPATIONAL CLINICS FOR CHRONIC PAIN (U.S. CLS. 100 AND 101).

KATHY DE JONGE, EXAMINING ATTORNEY

CLASS 44—(Continued).

SN 77-565,575. DOHENY EYE INSTITUTE, LOS ANGELES, CA. FILED 9-9-2008.

OCTANE

THE MARK CONSISTS OF STANDARD CHARACTERS WITHOUT CLAIM TO ANY PARTICULAR FONT, STYLE, SIZE, OR COLOR.

FOR PROVIDING MEDICAL INFORMATION VIA AN ONLINE SERVICE TO FACILITATE MEDICAL DIAGNOSIS AND TREATMENT IN THE FIELDS OF EYE DISEASES AND OPHTHALMOLOGY; AND PROVIDING MEDICAL INFORMATION VIA AN OUT-PATIENT SERVICE TO FACILITATE MEDICAL DIAGNOSIS AND TREATMENT IN THE FIELDS OF EYE DISEASES AND OPHTHALMOLOGY (U.S. CLS. 100 AND 101).

ODESSA BIBBINS, EXAMINING ATTORNEY

SN 77-565,718. CLINTON MEMORIAL HOSPITAL FOUNDATION, WILMINGTON, OH. FILED 9-9-2008.



THE MARK CONSISTS OF A STYLIZED CIRCLE DESIGN WITH MULTIPLE CURVED BANDS THAT CRISS-CROSS THE CIRCLE.

FOR HEALTH CARE AND MEDICAL SERVICES (U.S. CLS. 100 AND 101).

FIRST USE 2-0-2007; IN COMMERCE 2-0-2007.
ELLEN B. AWRICH, EXAMINING ATTORNEY

SN 77-565,719. CLINTON MEMORIAL HOSPITAL FOUNDATION, WILMINGTON, OH. FILED 9-9-2008.

THE COMPASSION TO COMFORT. THE TECHNOLOGY TO HEAL

THE MARK CONSISTS OF STANDARD CHARACTERS WITHOUT CLAIM TO ANY PARTICULAR FONT, STYLE, SIZE, OR COLOR.

FOR HEALTH CARE AND MEDICAL SERVICES (U.S. CLS. 100 AND 101).

FIRST USE 2-0-2007; IN COMMERCE 2-0-2007.
ELLEN B. AWRICH, EXAMINING ATTORNEY

CLASS 44—(Continued).

SN 77-565,767. CINCINNATI TAN COMPANY, INC., CINCINNATI, OH. FILED 9-9-2008.

STAND OUT

THE MARK CONSISTS OF STANDARD CHARACTERS WITHOUT CLAIM TO ANY PARTICULAR FONT, STYLE, SIZE, OR COLOR.

FOR TANNING SALONS (U.S. CLS. 100 AND 101).
FIRST USE 4-0-2006; IN COMMERCE 4-0-2006.
DAVID I. EXAMINING ATTORNEY

SN 77-565,770. PREVAIL HEALTH SOLUTIONS, AKA PREVAIL, CHICAGO, IL. FILED 9-9-2008.

Prevail

THE MARK CONSISTS OF STANDARD CHARACTERS WITHOUT CLAIM TO ANY PARTICULAR FONT, STYLE, SIZE, OR COLOR.

FOR CONSULTING SERVICES IN THE FIELD OF MENTAL HEALTH AND WELLNESS; HEALTH CARE SERVICES, NAMELY, PROVIDING A DATABASE IN THE FIELD OF MENTAL HEALTH INFORMATION AND FEATURING INPUTTING AND COLLECTION OF DATA AND INFORMATION ALL FOR TREATMENT AND DIAGNOSTIC PURPOSES; MAINTAINING FILES AND RECORDS CONCERNING THE MEDICAL CONDITION OF INDIVIDUALS; MENTAL HEALTH SERVICES; PROVIDING HEALTH CARE INFORMATION BY TELEPHONE AND THE INTERNET; PROVIDING ON-LINE MEDICAL RECORD ANALYSIS SERVICES DESIGNED TO PROVIDE PATIENTS WITH CUSTOM TAILORED INFORMATION ABOUT THE RANGE OF POSSIBLE DIAGNOSES AND THERAPIES ASSOCIATED WITH A DEFINED SET OF SYMPTOMS; PROVIDING WELLNESS SERVICES, NAMELY, PERSONAL ASSESSMENTS, PERSONALIZED ROUTINES, MAINTENANCE SCHEDULES, AND COUNSELING; PSYCHOLOGICAL ASSESSMENT SERVICES (U.S. CLS. 100 AND 101).

KARANENDRA S. CHHINA, EXAMINING ATTORNEY

CLASS 44—(Continued).

SN 77-566,003. HEALTHCAPABLE, INC., CHICAGO, IL. FILED 9-9-2008.

HEALTHCARD NETWORK

THE MARK CONSISTS OF STANDARD CHARACTERS WITHOUT CLAIM TO ANY PARTICULAR FONT, STYLE, SIZE, OR COLOR.

OWNER OF U.S. REG. NO. 3,281,178.

NO CLAIM IS MADE TO THE EXCLUSIVE RIGHT TO USE "NETWORK", APART FROM THE MARK AS SHOWN. FOR PROVIDING PERSONAL HEALTH CARE INFORMATION BY TELEPHONE AND INTERNET (U.S. CLS. 100 AND 101).

FIRST USE 3-26-2007; IN COMMERCE 3-26-2007.
SANDRA MANIOS, EXAMINING ATTORNEY

SN 77-566,297. REX HOSPITAL, INC., DBA REX HEALTHCARE, RALEIGH, NC. FILED 9-10-2008.

CHOSEN FOR EXCELLENCE

THE MARK CONSISTS OF STANDARD CHARACTERS WITHOUT CLAIM TO ANY PARTICULAR FONT, STYLE, SIZE, OR COLOR.

FOR HEALTHCARE; HOSPITALS (U.S. CLS. 100 AND 101).

FIRST USE 9-15-2007; IN COMMERCE 9-15-2007.
JULIE GUTTADAURO, EXAMINING ATTORNEY

SN 77-567,416. CC FRANCHISING, INDIANAPOLIS, IN. FILED 9-11-2008.

**Discover How Much Fun A
Haircut Can Be!**

THE MARK CONSISTS OF STANDARD CHARACTERS WITHOUT CLAIM TO ANY PARTICULAR FONT, STYLE, SIZE, OR COLOR.

FOR HAIR SALON SERVICES (U.S. CLS. 100 AND 101).
FIRST USE 7-25-1994; IN COMMERCE 7-25-1994.
ANDREA HACK, EXAMINING ATTORNEY

CLASS 44—(Continued).

SN 77-571,768. PREVAIL HEALTH SOLUTIONS, AKA PREVAIL, CHICAGO, IL. FILED 9-17-2008.

My Resilience

THE MARK CONSISTS OF STANDARD CHARACTERS WITHOUT CLAIM TO ANY PARTICULAR FONT, STYLE, SIZE, OR COLOR.

FOR CONSULTING SERVICES IN THE FIELD OF MENTAL HEALTH AND WELLNESS; HEALTH CARE SERVICES, NAMELY, PROVIDING A DATABASE IN THE FIELD OF MENTAL HEALTH INFORMATION AND FEATURING INPUTTING AND COLLECTION OF DATA AND INFORMATION ALL FOR TREATMENT AND DIAGNOSTIC PURPOSES; MAINTAINING FILES AND RECORDS CONCERNING THE MEDICAL CONDITION OF INDIVIDUALS; MENTAL HEALTH SERVICES; PROVIDING A WEB SITE FEATURING INFORMATION IN THE FIELD OF MENTAL HEALTH AND WELLNESS; PROVIDING HEALTH CARE INFORMATION BY TELEPHONE AND THE INTERNET; PROVIDING WELLNESS SERVICES, NAMELY, PERSONAL ASSESSMENTS, PERSONALIZED ROUTINES, MAINTENANCE SCHEDULES, AND COUNSELING; PSYCHOLOGICAL ASSESSMENT SERVICES (U.S. CLS. 100 AND 101).

KARANENDRA S. CHHINA, EXAMINING ATTORNEY

SN 77-580,793. PROVISTA LIFE SCIENCES, LLC, PHOENIX, AZ. FILED 9-29-2008.

BT SCORE

THE MARK CONSISTS OF STANDARD CHARACTERS WITHOUT CLAIM TO ANY PARTICULAR FONT, STYLE, SIZE, OR COLOR.

NO CLAIM IS MADE TO THE EXCLUSIVE RIGHT TO USE "SCORE", APART FROM THE MARK AS SHOWN. FOR MEDICAL TESTING SERVICES, NAMELY, CONDUCTING CLINICAL DIAGNOSTIC TESTING TO ALZHEIMER'S (U.S. CLS. 100 AND 101).

FIRST USE 11-19-2007; IN COMMERCE 2-13-2008.
SUSAN STIGLITZ, EXAMINING ATTORNEY

CLASS 44—(Continued).

SN 77-585,054. REX HOSPITAL, INC., DBA REX HEALTHCARE, RALEIGH, NC. FILED 10-3-2008.

REX HEALTHCARE

THE MARK CONSISTS OF STANDARD CHARACTERS WITHOUT CLAIM TO ANY PARTICULAR FONT, STYLE, SIZE, OR COLOR.

NO CLAIM IS MADE TO THE EXCLUSIVE RIGHT TO USE "HEALTHCARE", APART FROM THE MARK AS SHOWN.

FOR HEALTHCARE; HOSPITALS (U.S. CLS. 100 AND 101).

FIRST USE 3-26-1995; IN COMMERCE 3-26-1995.
JULIE GUTTADAURO, EXAMINING ATTORNEY

SN 77-596,113. AMGEN INC., THOUSAND OAKS, CA. FILED 10-20-2008.

T-BREAK

THE MARK CONSISTS OF STANDARD CHARACTERS WITHOUT CLAIM TO ANY PARTICULAR FONT, STYLE, SIZE, OR COLOR.

FOR PROVIDING MEDICAL INFORMATION (U.S. CLS. 100 AND 101).

FRED CARL, EXAMINING ATTORNEY

SN 78-250,365. JAFER LIMITED, HAMILTON, HM12, BERMUDA, FILED 5-15-2003.



OWNER OF PERU REG. NO. 00031146, DATED 12-2-2002, EXPIRES 12-2-2012.

OWNER OF U.S. REG. NO. 1,241,758.

THE COLOR(S) ORANGE, RED, AND WHITE IS/ARE CLAIMED AS A FEATURE OF THE MARK.

THE MARK CONSISTS OF THE WORD "YANBAL" IN WHITE LETTERING WITH A RED SLASH FORMING PART OF THE LETTER "Y". THE WORD "YANBAL" IS CONTAINED WITHIN AN ORANGE RECTANGLE.

FOR HOUSE MARK FOR USE IN CONNECTION WITH THE FOLLOWING SERVICES; BEAUTY SALONS OFFERING PERSONAL HYGIENIC AND BEAUTY CARE SERVICES (U.S. CLS. 100 AND 101).

WILLIAM BRECKENFELD, EXAMINING ATTORNEY

CLASS 44—(Continued).

SN 78-898,762. PULNIK, HELENE, PORTLAND, CT. FILED 6-2-2006.

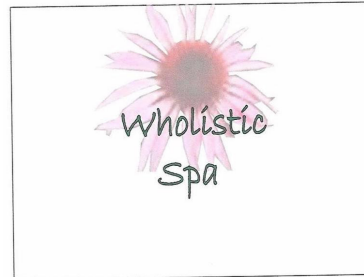

NO CLAIM IS MADE TO THE EXCLUSIVE RIGHT TO USE "HOLISTIC SPA", APART FROM THE MARK AS SHOWN.

THE COLOR(S) PINK, DARK RED, BLACK AND GREEN IS/ARE CLAIMED AS A FEATURE OF THE MARK.

THE MARK CONSISTS OF AN ECHINACEA FLOWER WITH PINK PEDALS AND THE CENTER FLOWER BEING DARK RED AND BLACK, AND OVERWRITTEN WITH THE GREEN TEXT "WHOLISTIC SPA" IN THE BRADLEY HAND ITC FONT.

FOR HEALTH SPA SERVICES, NAMELY, COSMETIC BODY CARE SERVICES (U.S. CLS. 100 AND 101).

FIRST USE 8-1-2005; IN COMMERCE 8-1-2005.
BERNICE MIDDLETON, EXAMINING ATTORNEY

CLASS 45—PERSONAL AND LEGAL SERVICES

SN 76-690,002. PAW IN HAND MATCH, INC., WINTER PARK, FL. FILED 5-27-2008.



NO CLAIM IS MADE TO THE EXCLUSIVE RIGHT TO USE "MATCH, INC.", APART FROM THE MARK AS SHOWN.

THE COLOR(S) BROWN, GREEN AND BLACK IS/ARE CLAIMED AS A FEATURE OF THE MARK.

THE MARK CONSISTS OF THE COLOR BROWN IN THE SILHOUETTE OF THE DOG, BOY AND CAT AND THE LINES BENEATH THEM, THE COLOR GREEN IN THE WORDS "PAW IN HAND MATCH, INC.", AND THE COLOR

CLASS 45—(Continued).

BLACK AS THE OUTLINE OF THE BANNER ON WHICH "PAW IN HAND" APPEARS. THE MARK CONSISTS OF A SILHOUETTE OF A BOY, A DOG AND A CAT. THE BOY WITH A CAT ON HIS BACK, EXTENDING HIS HAND TO A LARGE DOG WHICH IS EXTENDING ITS PAW TO THE BOY, BOTH STANDING ON HORIZONTAL LINES, ABOVE THE WORDS "PAW IN HAND" WHICH ARE WITHIN A BANNER HAVING A FOLD BETWEEN "PAW" AND "IN", ABOVE THE WORDS "MATCH, INC.", IN WHICH ALL WORDING IS SHOWN IN STYLIZED FONT.

FOR ADOPTION SERVICES FOR DOMESTIC ANIMALS; PLACEMENT SERVICES FOR PETS WHEN THERE IS NO ONE TO CARE FOR THE PET (U.S. CLS. 100 AND 101).

ESTHER BELENKER, EXAMINING ATTORNEY

SN 77-024,044. BABY BEACH RENTAL, PENSACOLA, FL. FILED 10-18-2006.



NO CLAIM IS MADE TO THE EXCLUSIVE RIGHT TO USE "RENTALS", APART FROM THE MARK AS SHOWN.

THE COLOR(S) MAGENTA, PINK, BLUE, AND WHITE IS/ARE CLAIMED AS A FEATURE OF THE MARK.

THE MARK CONSISTS OF THE COLOR MAGENTA APPEARING IN THE DESIGN OF THE ALTERNATING PANELS ON THE UMBRELLA AND BEACH BALL, THE UMBRELLA POLE, AND THE SPOTS ON THE BEACH BUCKET; THE COLOR PINK APPEARING ON THE SUNGLASSES; THE COLOR BLUE APPEARING IN THE WORDING "BABY BEACH RENTALS" AND IN THE DESIGN OF THE BATHING SUIT, THE TOP AND OUTLINE OF THE BEACH BALL AND THE OUTLINE OF THE BABY, BEACH BUCKET, SHOVEL, SAND AND WAVES; AND, THE COLOR WHITE APPEARING IN THE DESIGN OF THE ALTERNATING PANELS ON THE UMBRELLA AND BEACH BALL AND THE OVERALL BACKGROUND OF THE MARK INCLUDING THE BABY, BUCKET, SHOVEL, SAND AND WAVES.

SEC. 2(F).

FOR RENTAL OF BABY CRIBS AND HIGH CHAIRS (U.S. CLS. 100 AND 101).

FIRST USE 2-20-2002; IN COMMERCE 2-20-2002.

JOHN SCHUYLER YARD, EXAMINING ATTORNEY

SN 77-248,343. MOHAMMAD A. MAZED, YORBA LINDA, CA. FILED 8-6-2007.

LIFEPICASSO

THE MARK CONSISTS OF STANDARD CHARACTERS WITHOUT CLAIM TO ANY PARTICULAR FONT, STYLE, SIZE, OR COLOR.

FOR INTERNET-BASED SOCIAL NETWORKING SERVICES (U.S. CLS. 100 AND 101).

DAVID TOOLEY, EXAMINING ATTORNEY

CLASS 45—(Continued).

SN 77-336,757. ACK VENTURES HOLDINGS, LLC, WESTPORT, CT. FILED 11-26-2007.

KARGO

THE MARK CONSISTS OF STANDARD CHARACTERS WITHOUT CLAIM TO ANY PARTICULAR FONT, STYLE, SIZE, OR COLOR.

OWNER OF U.S. REG. NO. 2,756,549.

FOR SOCIAL NETWORKING SERVICES PROVIDED BY WIRED AND WIRELESS COMMUNICATIONS NETWORKS (U.S. CLS. 100 AND 101).

PAUL F. GAST, EXAMINING ATTORNEY

SN 77-506,192. NATIONAL BENEVOLENT ASSOCIATION OF THE CHRISTIAN CHURCH, MARYLAND HEIGHTS, MO. FILED 6-24-2008.



THE MARK CONSISTS OF A CHALICE WITH A STYLIZED CROSS AND A DOVE AGAINST A BACKGROUND OF A SUNBURST.

FOR SOCIAL SERVICE, NAMELY, COMPANIONSHIP SERVICES FOR SENIORS, AT-RISK CHILDREN AND PERSONS WITH DEVELOPMENTAL DISABILITIES; PROVIDING SPIRITUAL COUNSELING FOR SENIORS, AT-RISK CHILDREN AND PERSONS WITH DEVELOPMENTAL DISABILITIES (U.S. CLS. 100 AND 101).

ANGELA GAW, EXAMINING ATTORNEY

SN 77-531,682. SUSAN OLDEN ASSOCIATES LLC, NEW YORK, NY. FILED 7-25-2008.

SERVICE IS THE NEW LUXURY

THE MARK CONSISTS OF STANDARD CHARACTERS WITHOUT CLAIM TO ANY PARTICULAR FONT, STYLE, SIZE, OR COLOR.

FOR CONSULTING IN THE FIELD OF PERSONAL SHOPPING FOR OTHERS (U.S. CLS. 100 AND 101).

TARA PATE, EXAMINING ATTORNEY

CLASS 45—(Continued).

SN 77-553,559. DIANA COBBE, DBA OUTER BARCOO. WHAT'S CALLING YOU?, NEVADA CITY, CA. FILED 8-22-2008.

success.it's personal

THE MARK CONSISTS OF STANDARD CHARACTERS WITHOUT CLAIM TO ANY PARTICULAR FONT, STYLE, SIZE, OR COLOR.

FOR COUNSELING IN THE FIELD OF PERSONAL DEVELOPMENT, NAMELY, SELF-IMPROVEMENT, SELF-FULFILLMENT, AND INTERPERSONAL COMMUNICATION (U.S. CLS. 100 AND 101).

TARA PATE, EXAMINING ATTORNEY

CLASS 45—(Continued).

SN 77-555,470. VIDOOP LLC, PORTLAND, OR. FILED 8-26-2008.

Picture your Password

THE MARK CONSISTS OF STANDARD CHARACTERS WITHOUT CLAIM TO ANY PARTICULAR FONT, STYLE, SIZE, OR COLOR.

FOR AUTHENTICATION, ISSUANCE AND VALIDATION OF DIGITAL CERTIFICATES; IDENTIFICATION VERIFICATION SERVICES, NAMELY, PROVIDING AUTHENTICATION OF PERSONAL IDENTIFICATION INFORMATION; IDENTIFICATION VERIFICATION SERVICES, NAMELY, PROVIDING AUTHENTICATION OF PERSONAL IDENTIFICATION INFORMATION VIA SECURE STORAGE AND TRANSMITTING SUCH INFORMATION VIA THE INTERNET; PROVIDING USER AUTHENTICATION OF ELECTRONIC FUNDS TRANSFER, CREDIT AND DEBIT CARD AND ELECTRONIC CHECK TRANSACTIONS VIA A GLOBAL COMPUTER NETWORK; PROVIDING USER AUTHENTICATION SERVICES IN E-COMMERCE TRANSACTIONS (U.S. CLS. 100 AND 101).

BRIAN NEVILLE, EXAMINING ATTORNEY

SN 77-556,388. WEST, MARK, IRVINE, CA. FILED 8-26-2008.

HOMOGENIUS

THE MARK CONSISTS OF STANDARD CHARACTERS WITHOUT CLAIM TO ANY PARTICULAR FONT, STYLE, SIZE, OR COLOR.

FOR INTERNET-BASED DATING, SOCIAL INTRODUCTION AND SOCIAL NETWORKING SERVICES (U.S. CLS. 100 AND 101).

FIRST USE 8-29-2004; IN COMMERCE 8-29-2004.

SONYA STEPHENS, EXAMINING ATTORNEY

SN 77-554,536. SUBREPTION LLC, DBA SUBREPTION LLC, CHEYENNE, WY. FILED S.R. 8-25-2008; AM. P.R. 12-8-2008.



THE COLOR(S) DARK BLUE, LIGHT CORNFLOWER BLUE, WHITE IS/ARE CLAIMED AS A FEATURE OF THE MARK.

THE MARK CONSISTS OF A COMPANY "SUBREPTION" LETTERING AND THE MAIN LOGO SYMBOL, CONSISTING OF A DARK CIRCLE SHAPE WITH AN "S"-SHAPE IN WHITE, SPLITTING IT IN TWO SIMILAR PARTS, WITH TWO LIGHT CORNFLOWER BLUE "SPARKS" SURROUNDING THE CENTRAL SHAPE.

FOR SECURITY SERVICES, NAMELY, THREAT SIMULATION VULNERABILITY ANALYSIS AND MITIGATION AND EMERGENCY AND CRISIS RESPONSE (U.S. CLS. 100 AND 101).

FIRST USE 12-20-2007; IN COMMERCE 2-3-2008.

CHRIS WELLS, EXAMINING ATTORNEY

SN 77-556,979. WINES, CATHY A., DBA LIVE, LAUGH & LEARN-A WOMAN'S NETWORK, PLAINFIELD, IN. FILED 8-27-2008.

Live, Laugh & Learn -- A
Woman's Network

THE MARK CONSISTS OF STANDARD CHARACTERS WITHOUT CLAIM TO ANY PARTICULAR FONT, STYLE, SIZE, OR COLOR.

FOR COUNSELING IN THE FIELD OF PERSONAL DEVELOPMENT, NAMELY, SELF-IMPROVEMENT, SELF-FULFILLMENT, AND INTERPERSONAL COMMUNICATION; ORGANIZING AND CONDUCTING SUPPORT GROUPS IN THE FIELD OF EMPOWERING WOMEN (U.S. CLS. 100 AND 101).

MARGERY A. TIERNEY, EXAMINING ATTORNEY

CLASS 45—(Continued).

SN 77-558,265. DIVORCE DASH, LLC, WOODSTOCK, GA.
FILED 8-28-2008.

DIVORCE DASH

THE MARK CONSISTS OF STANDARD CHARACTERS WITHOUT CLAIM TO ANY PARTICULAR FONT, STYLE, SIZE, OR COLOR.

NO CLAIM IS MADE TO THE EXCLUSIVE RIGHT TO USE "DIVORCE", APART FROM THE MARK AS SHOWN.

FOR PROVIDING A WEBSITE FEATURING SELF-HELP AND PERSONAL EMPOWERMENT INFORMATION TO SUPPORT DIVORCED MEN (U.S. CLS. 100 AND 101).

FIRST USE 8-28-2008; IN COMMERCE 8-28-2008.
LAURIE KAUFMAN, EXAMINING ATTORNEY

SN 77-558,274. DIVORCE DASH, LLC, WOODSTOCK, GA.
FILED 8-28-2008.



NO CLAIM IS MADE TO THE EXCLUSIVE RIGHT TO USE "DIVORCE", APART FROM THE MARK AS SHOWN.

THE MARK CONSISTS OF A STYLIZED DEPICTION OF THE WORD "DIVORCE" ABOVE A STYLIZED DEPICTION OF THE WORD "DASH" ABOVE A STYLIZED DEPICTION OF THE WORDS "WHAT ARE YOU GOING TO DO WITH YOURS?". THE "I" IN "DIVORCE" IS REPRESENTED BY A DRAWING OF A PERSON. A DRAWING OF A PERSON RUNNING APPEARS AT THE END OF THE WORD "DASH". A HEART APPEARS IN THE MIDDLE OF THE PERSON. ALL OF THESE ELEMENTS APPEAR INSIDE AN OVAL. THE OVAL IS INSIDE A RECTANGULAR BOX.

FOR PROVIDING A WEBSITE FEATURING SELF-HELP AND PERSONAL EMPOWERMENT INFORMATION TO SUPPORT DIVORCED MEN (U.S. CLS. 100 AND 101).

FIRST USE 8-28-2008; IN COMMERCE 8-28-2008.
LAURIE KAUFMAN, EXAMINING ATTORNEY

SN 77-558,542. REUNION.COM, INC., LOS ANGELES, CA.
FILED 8-29-2008.

MYLIFE.COM

THE MARK CONSISTS OF STANDARD CHARACTERS WITHOUT CLAIM TO ANY PARTICULAR FONT, STYLE, SIZE, OR COLOR.

FOR INTERNET BASED SOCIAL NETWORKING, INTRODUCTION, AND DATING SERVICES (U.S. CLS. 100 AND 101).

PAULA MAHONEY, EXAMINING ATTORNEY

CLASS 45—(Continued).

SN 77-560,099. PLEASANT, THOMAS, FAYETTEVILLE, NC.
FILED 9-2-2008.



NO CLAIM IS MADE TO THE EXCLUSIVE RIGHT TO USE "THE LAW OFFICES OF", APART FROM THE MARK AS SHOWN.

THE MARK CONSISTS OF A BOXED LOGO WITH AN ARCHED BOTTOM, WITH THE LOWERCASE INITIALS "TWP" AND "THE LAW OFFICES OF THOMAS WAITT PLEASANT" TO THE RIGHT SIDE.

FOR LEGAL SERVICES (U.S. CLS. 100 AND 101).
FIRST USE 8-11-2008; IN COMMERCE 8-11-2008.
ELLEN PERKINS, EXAMINING ATTORNEY

SN 77-561,140. FELLOWSHIP OF CHRISTIAN ATHLETES,
KANSAS CITY, MO. FILED 9-3-2008.

AXIOM

THE MARK CONSISTS OF STANDARD CHARACTERS WITHOUT CLAIM TO ANY PARTICULAR FONT, STYLE, SIZE, OR COLOR.

FOR PROVIDING CHRISTIAN EVANGELISTIC AND MINISTERIAL SERVICES DIRECTED TOWARDS ATHLETES, ATHLETIC COACHES AND THOSE WHOM THEY INFLUENCE, IN THE SPORT OF SKATEBOARDING (U.S. CLS. 100 AND 101).

MICHAEL WEBSTER, EXAMINING ATTORNEY

CLASS 45—(Continued).

SN 77-561,150. HURD, BRIGITTA, FALLBROOK, CA. FILED 9-3-2008.



THE MARK CONSISTS OF THE STYLIZED TEXT "PEACE GANG EMPOWERING PARENTS & TEENS" ENCLOSED IN A HALF SHADED CIRCLE.

FOR PROVIDING INFORMATION IN THE FIELD OF PERSONAL DEVELOPMENT, NAMELY, SELF-IMPROVEMENT, SELF-FULFILLMENT, AND INTERPERSONAL COMMUNICATION; PROVIDING INFORMATION IN THE FIELD OF SELF-IMPROVEMENT (U.S. CLS. 100 AND 101).

MICHAEL WEBSTER, EXAMINING ATTORNEY

SN 77-562,800. YOUR NET WORKS, INC., SAN FRANCISCO, CA. FILED 9-4-2008.

KROOGI

THE MARK CONSISTS OF STANDARD CHARACTERS WITHOUT CLAIM TO ANY PARTICULAR FONT, STYLE, SIZE, OR COLOR.

FOR ON-LINE SOCIAL NETWORKING SERVICES (U.S. CLS. 100 AND 101).

FIRST USE 3-14-2008; IN COMMERCE 4-10-2008.

SUSAN RICHARDS, EXAMINING ATTORNEY

SN 77-563,250. DEUTCH, RONI LYNN, NORTH HIGHLANDS, CA. FILED 9-5-2008.

Tax Lady

THE MARK CONSISTS OF STANDARD CHARACTERS WITHOUT CLAIM TO ANY PARTICULAR FONT, STYLE, SIZE, OR COLOR.

OWNER OF U.S. REG. NO. 3,528,361.

NO CLAIM IS MADE TO THE EXCLUSIVE RIGHT TO USE "TAX", APART FROM THE MARK AS SHOWN.

FOR LEGAL SERVICES (U.S. CLS. 100 AND 101).

FIRST USE 1-1-2003; IN COMMERCE 1-1-2003.

BARBARA RUTLAND, EXAMINING ATTORNEY

CLASS 45—(Continued).

SN 77-563,656. WILLIAMS, HARRY M., PEORIA, IL. FILED 9-5-2008.

LEGAL BEAT WHERE THE LAW LIVES

THE MARK CONSISTS OF STANDARD CHARACTERS WITHOUT CLAIM TO ANY PARTICULAR FONT, STYLE, SIZE, OR COLOR.

FOR LEGAL SERVICES (U.S. CLS. 100 AND 101).

FIRST USE 6-0-2008; IN COMMERCE 6-0-2008.

GISELLE AGOSTO, EXAMINING ATTORNEY

SN 77-564,034. FINDING RESOLUTION LLC, ARLINGTON, VA. FILED 9-7-2008.

Finding Resolution

THE MARK CONSISTS OF STANDARD CHARACTERS WITHOUT CLAIM TO ANY PARTICULAR FONT, STYLE, SIZE, OR COLOR.

NO CLAIM IS MADE TO THE EXCLUSIVE RIGHT TO USE "RESOLUTION", APART FROM THE MARK AS SHOWN.

FOR LEGAL SERVICES, NAMELY, MEDIATION AND ALTERNATIVE DISPUTE RESOLUTION (U.S. CLS. 100 AND 101).

FIRST USE 5-25-2008; IN COMMERCE 8-28-2008.

PAUL F. GAST, EXAMINING ATTORNEY

SN 77-564,139. CONTIGO SYSTEMS INC., VANCOUVER, CANADA, FILED 9-7-2008.

EYES ON PRINCIPAL

THE MARK CONSISTS OF STANDARD CHARACTERS WITHOUT CLAIM TO ANY PARTICULAR FONT, STYLE, SIZE, OR COLOR.

FOR SECURITY SERVICES, NAMELY, PROVIDING EXECUTIVE PROTECTION FEATURING TRACKING, LOCATING AND MONITORING DEVICES USING WIRELESS COMMUNICATIONS DEVICES VIA A GLOBAL COMPUTER NETWORK (U.S. CLS. 100 AND 101).

FIRST USE 8-6-2008; IN COMMERCE 9-7-2008.

TRACY FLETCHER, EXAMINING ATTORNEY

CLASS 45—(Continued).

SN 77-564,141. CONTIGO SYSTEMS INC., VANCOUVER, CANADA, FILED 9-7-2008.

EYES ON SUSPECT

THE MARK CONSISTS OF STANDARD CHARACTERS WITHOUT CLAIM TO ANY PARTICULAR FONT, STYLE, SIZE, OR COLOR.

FOR SECURITY SERVICES, NAMELY, CONDUCTING THREAT ASSESSMENT AND RECOVERY OPERATIONS FOR THE RECOVERY OF PROPERTY FEATURING TRACKING, LOCATING AND MONITORING OF PROPERTY USING WIRELESS COMMUNICATIONS DEVICES VIA A GLOBAL COMPUTER NETWORK (U.S. CLS. 100 AND 101).

FIRST USE 8-6-2008; IN COMMERCE 9-7-2008.
TRACY FLETCHER, EXAMINING ATTORNEY

CLASS 45—(Continued).

SN 77-565,095. GENENTECH, SOUTH SAN FRANCISCO, CA, FILED 9-8-2008.

ANTICIPATED ACCESS

THE MARK CONSISTS OF STANDARD CHARACTERS WITHOUT CLAIM TO ANY PARTICULAR FONT, STYLE, SIZE, OR COLOR.

FOR INVESTIGATION SERVICES RELATED TO INSURANCE CLAIMS (U.S. CLS. 100 AND 101).
INGRID C. EULIN, EXAMINING ATTORNEY

SN 77-564,774. J. LYNN INC., NEW YORK, NY. FILED 9-8-2008.

Chickmeet

THE MARK CONSISTS OF STANDARD CHARACTERS WITHOUT CLAIM TO ANY PARTICULAR FONT, STYLE, SIZE, OR COLOR.

FOR SOCIAL NETWORKING WEBSITE THAT ALLOWS WOMEN TO SEARCH FOR AND CONNECT WITH WOMEN WHO HAVE SIMILAR INTERESTS AND LIFESTYLES TO THEIR OWN, ON A FRIENDSHIP/PLATONIC BASIS, WITH THE FUTURE INTENTIONED PURPOSE OF MEETING OFFLINE (U.S. CLS. 100 AND 101).

MARCIE MILONE, EXAMINING ATTORNEY

SN 77-564,781. J. LYNN INC., NEW YORK, NY. FILED 9-8-2008.

Chickmate

THE MARK CONSISTS OF STANDARD CHARACTERS WITHOUT CLAIM TO ANY PARTICULAR FONT, STYLE, SIZE, OR COLOR.

FOR SOCIAL NETWORKING WEBSITE THAT ALLOWS WOMEN TO SEARCH FOR AND CONNECT WITH WOMEN WHO HAVE SIMILAR INTERESTS AND LIFESTYLES TO THEIR OWN, ON A FRIENDSHIP/PLATONIC BASIS, WITH THE FUTURE INTENTIONED PURPOSE OF MEETING OFFLINE (U.S. CLS. 100 AND 101).

MARCIE MILONE, EXAMINING ATTORNEY

SN 77-566,042. NETWORK LEARNING INC., DBA CCBOOT-CAMP, HENDERSON, NV. FILED 9-9-2008.

Saving the world one network at a time

THE MARK CONSISTS OF STANDARD CHARACTERS WITHOUT CLAIM TO ANY PARTICULAR FONT, STYLE, SIZE, OR COLOR.

FOR LICENSING OF ADVERTISING SLOGANS AND CARTOON CHARACTERS (U.S. CLS. 100 AND 101).
JAMES GRIFFIN, EXAMINING ATTORNEY

SN 77-566,057. NETWORK LEARNING INC., DBA CCBOOT-CAMP, HENDERSON, NV. FILED 9-9-2008.

Embrace your future

THE MARK CONSISTS OF STANDARD CHARACTERS WITHOUT CLAIM TO ANY PARTICULAR FONT, STYLE, SIZE, OR COLOR.

FOR LICENSING OF ADVERTISING SLOGANS AND CARTOON CHARACTERS (U.S. CLS. 100 AND 101).

JAMES GRIFFIN, EXAMINING ATTORNEY

CLASS 45—(Continued).

SN 77-567,124. SERDAR, CHERYL, SPRING, TX. FILED 9-10-2008.

DOLLIE

THE MARK CONSISTS OF STANDARD CHARACTERS WITHOUT CLAIM TO ANY PARTICULAR FONT, STYLE, SIZE, OR COLOR.

FOR PERSONAL IMAGE CONSULTING SERVICES (U.S. CLS. 100 AND 101).

MICHAEL WEBSTER, EXAMINING ATTORNEY



SN 77-567,298. DAWSON, ERIC J., PORTLAND, ME. FILED 9-11-2008.

EARTHJOCK

THE MARK CONSISTS OF STANDARD CHARACTERS WITHOUT CLAIM TO ANY PARTICULAR FONT, STYLE, SIZE, OR COLOR.

FOR ON-LINE SOCIAL NETWORKING SERVICES; ONLINE SOCIAL NETWORKING SERVICES PROVIDED THROUGH A SPORTS COMMUNITY WEBSITE.; PROVIDING A SOCIAL NETWORKING WEBSITE FOR ENTERTAINMENT PURPOSES (U.S. CLS. 100 AND 101).

SANJEEV VOHRA, EXAMINING ATTORNEY



SN 77-567,455. CHERYL-LEE LORIENT, TA AU REVOIR THE OFFICIAL BREAK-UP SERVICE, BROOKLYN, NY. FILED 9-11-2008.

**Au Revoir The Official
Break-up Service**

THE MARK CONSISTS OF STANDARD CHARACTERS WITHOUT CLAIM TO ANY PARTICULAR FONT, STYLE, SIZE, OR COLOR.

NO CLAIM IS MADE TO THE EXCLUSIVE RIGHT TO USE "OFFICIAL BREAK-UP SERVICE", APART FROM THE MARK AS SHOWN.

FOR PROVIDING A WEB SITE FEATURING INFORMATION ON LOVE, ROMANCE AND INTERPERSONAL RELATIONSHIPS (U.S. CLS. 100 AND 101).

ANNE E. GUSTASON, EXAMINING ATTORNEY

CLASS 45—(Continued).

SN 77-569,307. FINDING RESOLUTION LLC, ARLINGTON, VA. FILED 9-12-2008.



NO CLAIM IS MADE TO THE EXCLUSIVE RIGHT TO USE "RESOLUTION", APART FROM THE MARK AS SHOWN.

THE MARK CONSISTS OF A THICK, NARROWING LINE THAT LOOKS LIKE AN ABSTRACT ROAD RUNNING THROUGH A CIRCLE AND THE WORD "FINDING" IN LARGE PRINT ON THE TOP ROW, THE WORD "RESOLUTION" IN LARGE PRINT ON THE SECOND ROW, AND THE PHRASE "COURAGE. COMMUNICATION. CHANGE." ON THE THIRD AND FINAL ROW OF THE DESIGN.

FOR LEGAL SERVICES, NAMELY, MEDIATION AND ALTERNATIVE DISPUTE RESOLUTION (U.S. CLS. 100 AND 101).

FIRST USE 5-25-2008; IN COMMERCE 8-28-2008.

PAUL F. GAST, EXAMINING ATTORNEY



SN 77-576,765. FRASE, ANDREA, PEPPERELL, MA. FILED 9-23-2008.

SACRED BRIDGING

THE MARK CONSISTS OF STANDARD CHARACTERS WITHOUT CLAIM TO ANY PARTICULAR FONT, STYLE, SIZE, OR COLOR.

FOR PROVIDING SPIRITUAL REHABILITATION SERVICES; AND SPIRITUAL COUNSELING SERVICES (U.S. CLS. 100 AND 101).

FIRST USE 3-31-2006; IN COMMERCE 3-31-2007.

ROBIN CHOSID, EXAMINING ATTORNEY



SN 77-587,080. BUILD-A-BEAR RETAIL MANAGEMENT, INC., ST. LOUIS, MO. FILED 10-7-2008.

MOOSE TRANSLATOR

THE MARK CONSISTS OF STANDARD CHARACTERS WITHOUT CLAIM TO ANY PARTICULAR FONT, STYLE, SIZE, OR COLOR.

NO CLAIM IS MADE TO THE EXCLUSIVE RIGHT TO USE "TRANSLATOR", APART FROM THE MARK AS SHOWN.

FOR PROVIDING A SELECTION OF ON-LINE ELECTRONIC GREETING CARDS (U.S. CLS. 100 AND 101).

KEVON CHISOLM, EXAMINING ATTORNEY

CLASS 45—(Continued).

SN 78-631,019. CITY OF CHICAGO, CHICAGO, IL. FILED 5-16-2005.

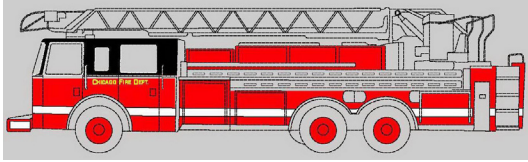

NO CLAIM IS MADE TO THE EXCLUSIVE RIGHT TO USE "FIRE DEPT.", THE COLOR RED AND THE WHITE STRIPE, APART FROM THE MARK AS SHOWN.

THE COLOR(S) RED, BLACK AND WHITE IS/ARE CLAIMED AS A FEATURE OF THE MARK.

THE MARK CONSISTS OF THE COLORS RED, BLACK, AND WHITE ON THE FIRE TRUCK VEHICLE AS WELL AS THE WORD "CHICAGO FIRE DEPT.", ALL DEPICTED ON FIRE TRUCK VEHICLES. THE COLOR BLACK APPEARS ON THE TOP PORTION OF THE CAB OF THE VEHICLE. THE COLOR RED APPEARS ON THE BOTTOM PORTION OF THE CAB AND THE ENTIRE BODY OF THE VEHICLE. THE COLOR WHITE APPEARS ON A SINGLE STRIPE. THE MATTER DEPICTED IN BROKEN LINES IS NOT A PART OF THE MARK.

SEC. 2(F).

FOR MUNICIPAL SERVICES, NAMELY, FIRE PREVENTION SERVICES, FIRE FIGHTING SERVICES, AND CIVIL PROTECTION (U.S. CLS. 100 AND 101).

FIRST USE 1-1-1939; IN COMMERCE 1-1-1939.

JOHN SCHUYLER YARD, EXAMINING ATTORNEY

CLASS 45—(Continued).

SN 79-060,544. ANGLO DESIGN HOLDINGS PLC, UNITED KINGDOM, FILED 9-5-2008.

REMGUARD

THE MARK CONSISTS OF STANDARD CHARACTERS WITHOUT CLAIM TO ANY PARTICULAR FONT, STYLE, SIZE, OR COLOR.

OWNER OF INTERNATIONAL REGISTRATION 0981231 DATED 9-5-2008, EXPIRES 9-5-2018.

FOR REMOTE SECURITY SURVEILLANCE MONITORING SERVICES (U.S. CLS. 100 AND 101).

WENDY JUN, EXAMINING ATTORNEY

* * * * *

SECTION 4.—PRIOR UNITED STATES CLASSIFICATION

APPLICATION IN ONE CLASS

COLLECTIVE MEMBERSHIP MARKS

CLASS 200—COLLECTIVE MEMBERSHIP
SN 76-692,438. NORTH AMERICAN TRUFFLE GROWERS
ASSOCIATION, HILLSBOROUGH, NC. FILED 8-28-2008.

NATGA

THE MARK CONSISTS OF STANDARD CHARACTERS
WITHOUT CLAIM TO ANY PARTICULAR FONT, STYLE,
SIZE, OR COLOR.
FOR INDICATING MEMBERSHIP IN A TRUFFLE
GROWERS ASSOCIATION.
DAYNA BROWNE, EXAMINING ATTORNEY

SN 77-535,484. THE INTERNATIONAL GUILD OF WIRE
JEWELRY ARTISTS, INC., PALM BEACH GARDENS,
FL. FILED 7-31-2008.



NO CLAIM IS MADE TO THE EXCLUSIVE RIGHT TO
USE "INTERNATIONAL GUILD OF WIRE JEWELRY
ARTISTS EST. 2004 MEMBER", APART FROM THE MARK
AS SHOWN.

THE MARK CONSISTS OF THE WORD "INTERNA-
TIONAL" ABOVE THE WORDS "GUILD OF"; WHICH ARE
ABOVE THE VERTICALLY ARRANGED WORDS "WIRE
JEWELRY ARTISTS", WHICH IS ABOVE THE WORD
"MEMBER"; WITH A PAIR OF PLIERS MANIPULATING
A COIL OF WIRE TO THE RIGHT OF THE WORDING,
WITH THE WORDING "EST." ABOVE THE NUMBER "2004"
WITHIN THE HANDLES OF THE PLIERS; AND WITH THE
COIL OF WIRE EXTENDING TO FORM THE UPPER, LEFT,
AND LOWER BORDER OF THE MARK AND TOUCHING
THE BOTTOM OF THE PLIERS IN THE LOWER RIGHT
CORNER OF THE MARK.

FOR INDICATING MEMBERSHIP IN A(N) NON-
PROFIT BUSINESS LEAGUE WHICH PROMOTES THE
INTERESTS OF WIRE JEWELRY ARTISTS.

FIRST USE 9-1-2004; IN COMMERCE 9-1-2004.

STEPHEN AQUILA, EXAMINING ATTORNEY

SN 77-578,739. AMERICAN ACADEMY OF OPHTHALMOL-
OGY, INC., SAN FRANCISCO, CA. FILED 9-25-2008.

**AMERICAN ACADEMY OF
OPHTHALMIC EXECUTIVES**

THE MARK CONSISTS OF STANDARD CHARACTERS
WITHOUT CLAIM TO ANY PARTICULAR FONT, STYLE,
SIZE, OR COLOR.
OWNER OF U.S. REG. NOS. 2,780,893 AND 2,787,717.
SEC. 2(F).
FOR INDICATING MEMBERSHIP IN A PROFES-
SIONAL MEDICAL ORGANIZATION.
FIRST USE 10-20-2002; IN COMMERCE 10-20-2002.
DAWN FELDMAN, EXAMINING ATTORNEY

CERTIFICATION MARKS

CLASS B—SERVICES

SN 77-383,888. NATIONAL CERTIFICATION BOARD FOR
DIABETES EDUCATORS, ARLINGTON HEIGHTS, IL.
FILED 1-30-2008.

CERTIFIED DIABETES EDUCATOR

THE MARK CONSISTS OF STANDARD CHARACTERS
WITHOUT CLAIM TO ANY PARTICULAR FONT, STYLE,
SIZE, OR COLOR.

OWNER OF U.S. REG. NO. 2,176,011.

NO CLAIM IS MADE TO THE EXCLUSIVE RIGHT TO
USE "CERTIFIED", APART FROM THE MARK AS SHOWN.

THE CERTIFICATION MARK, AS USED BY AUTHORIZED
PERSONS, CERTIFIES THAT SUCH PERSONS MEET
THE CERTIFIER'S STANDARDS AS TO PROFESSIONAL
EDUCATION, EXPERIENCE AND COMPETENCE AS RE-
FLECTED BY THE SUCCESSFUL COMPLETION OF WRIT-
TEN EXAMINATIONS.

SEC. 2(F).

FOR DIABETES EDUCATION SERVICES.

FIRST USE 0-0-1988; IN COMMERCE 0-0-1988.

MICHAEL GAAFAR, EXAMINING ATTORNEY

SN 77-533,280. ICE QIK, LLC, MYRTLE BEACH, SC. FILED
7-29-2008.

**CERTIFIED ICE QIK VENDING
PROFESSIONAL**

THE MARK CONSISTS OF STANDARD CHARACTERS WITHOUT CLAIM TO ANY PARTICULAR FONT, STYLE, SIZE, OR COLOR.

NO CLAIM IS MADE TO THE EXCLUSIVE RIGHT TO USE "CERTIFIED ICE AND VENDING PROFESSIONAL", APART FROM THE MARK AS SHOWN.

THE CERTIFICATION MARK, AS USED BY AUTHORIZED PERSONS, CERTIFIES THAT THE LABOR WAS PERFORMED BY A PARTICULAR GROUP, NAMELY THOSE INDIVIDUALS AND/OR ENTITIES THAT HAVE BEEN TRAINED BY AND CERTIFIED BY THE OWNER OF THE MARK.

FOR ICE DISPENSING MACHINE MAINTENANCE AND DISTRIBUTION SERVICES.

FIRST USE 7-7-2008; IN COMMERCE 7-7-2008.

ANN E. SAPPENFIELD, EXAMINING ATTORNEY

SN 77-533,283. ICE QIK, LLC, MYRTLE BEACH, SC. FILED
7-29-2008.

**AUTHORIZED ICE QIK VENDING
OPERATOR**

THE MARK CONSISTS OF STANDARD CHARACTERS WITHOUT CLAIM TO ANY PARTICULAR FONT, STYLE, SIZE, OR COLOR.

NO CLAIM IS MADE TO THE EXCLUSIVE RIGHT TO USE "AUTHORIZED ICE AND VENDING OPERATOR", APART FROM THE MARK AS SHOWN.

THE CERTIFICATION MARK, AS USED BY AUTHORIZED PERSONS, CERTIFIES THAT THE LABOR WAS PERFORMED BY A PARTICULAR GROUP, NAMELY THOSE INDIVIDUALS AND/OR ENTITIES THAT HAVE BEEN TRAINED BY AND CERTIFIED BY THE OWNER OF THE MARK.

FOR ICE DISPENSING MACHINE MAINTENANCE AND DISTRIBUTION SERVICES.

FIRST USE 7-7-2008; IN COMMERCE 7-7-2008.

ANN E. SAPPENFIELD, EXAMINING ATTORNEY

SN 77-564,325. HOWLETT CONSULTING GROUP LLC,
NEW ALBANY, IN. FILED 9-8-2008.

CFB

THE MARK CONSISTS OF STANDARD CHARACTERS WITHOUT CLAIM TO ANY PARTICULAR FONT, STYLE, SIZE, OR COLOR.

THE CERTIFICATION MARK, AS INTENDED TO BE

USED BY AUTHORIZED PERSONS, IS INTENDED TO CERTIFY THAT THE PERSON DISPLAYING THE MARK HAS COMPLETED EDUCATION COURSE WORK REQUIREMENTS AND WORK EXPERIENCE REQUIREMENTS OF THE CERTIFIER, HAS COMPLETED EXAMINATIONS ADMINISTERED BY THE CERTIFIER IN SATISFACTORY MANNER, AND HAS AGREED TO ADHERE TO THE CERTIFIER'S STANDARDS FOR PROFESSIONAL RESPONSIBILITY, CONTINUING EDUCATION AND OTHER POST-CERTIFICATION REQUIREMENTS.

FOR BANKING SERVICES AND FINANCIAL ADVICE.

JORDAN BAKER, EXAMINING ATTORNEY

SN 77-564,359. HOWLETT CONSULTING GROUP LLC,
NEW ALBANY, IN. FILED 9-8-2008.

CPB

THE MARK CONSISTS OF STANDARD CHARACTERS WITHOUT CLAIM TO ANY PARTICULAR FONT, STYLE, SIZE, OR COLOR.

THE CERTIFICATION MARK, AS INTENDED TO BE USED BY AUTHORIZED PERSONS, IS INTENDED TO CERTIFY THAT THE PERSON DISPLAYING THE MARK HAS COMPLETED EDUCATION COURSE WORK REQUIREMENTS AND WORK EXPERIENCE REQUIREMENTS OF THE CERTIFIER, HAS COMPLETED EXAMINATIONS ADMINISTERED BY THE CERTIFIER IN SATISFACTORY MANNER, AND HAS AGREED TO ADHERE TO THE CERTIFIER'S STANDARDS FOR PROFESSIONAL RESPONSIBILITY, CONTINUING EDUCATION AND OTHER POST-CERTIFICATION REQUIREMENTS.

FOR BANKING SERVICES AND FINANCIAL ADVICE FOR INDIVIDUALS.

JORDAN BAKER, EXAMINING ATTORNEY

SN 77-564,394. HOWLETT CONSULTING GROUP LLC,
NEW ALBANY, IN. FILED 9-8-2008.

CCB

THE MARK CONSISTS OF STANDARD CHARACTERS WITHOUT CLAIM TO ANY PARTICULAR FONT, STYLE, SIZE, OR COLOR.

THE CERTIFICATION MARK, AS INTENDED TO BE USED BY AUTHORIZED PERSONS, IS INTENDED TO CERTIFY THAT THE PERSON DISPLAYING THE MARK HAS COMPLETED EDUCATION COURSE WORK REQUIREMENTS AND WORK EXPERIENCE REQUIREMENTS OF THE CERTIFIER, HAS COMPLETED EXAMINATIONS ADMINISTERED BY THE CERTIFIER IN SATISFACTORY MANNER, AND HAS AGREED TO ADHERE TO THE CERTIFIER'S STANDARDS FOR PROFESSIONAL RESPONSIBILITY, CONTINUING EDUCATION AND OTHER POST-CERTIFICATION REQUIREMENTS.

FOR BANKING SERVICES AND FINANCIAL ADVICE FOR INDIVIDUALS.

JORDAN BAKER, EXAMINING ATTORNEY

JANUARY 27, 2009

U.S. PATENT AND TRADEMARK OFFICE

TM 855

SN 77-564,412. HOWLETT CONSULTING GROUP LLC,
NEW ALBANY, IN. FILED 9-8-2008.

CRB

THE MARK CONSISTS OF STANDARD CHARACTERS
WITHOUT CLAIM TO ANY PARTICULAR FONT, STYLE,
SIZE, OR COLOR.

THE CERTIFICATION MARK, AS INTENDED TO BE
USED BY AUTHORIZED PERSONS, IS INTENDED TO
CERTIFY THAT THE PERSON DISPLAYING THE MARK
HAS COMPLETED EDUCATION COURSE WORK RE-
QUIREMENTS AND WORK EXPERIENCE REQUIRE-
MENTS OF THE CERTIFIER, HAS COMPLETED
EXAMINATIONS ADMINISTERED BY THE CERTIFIER
IN SATISFACTORY MANNER, AND HAS AGREED TO
ADHERE TO THE CERTIFIER'S STANDARDS FOR PRO-
FESSIONAL RESPONSIBILITY, CONTINUING EDUCA-
TION AND OTHER POST-CERTIFICATION
REQUIREMENTS.

FOR BANKING SERVICES AND FINANCIAL ADVICE
FOR INDIVIDUALS AND OWNER-MANAGED BUSI-
NESSES.

JORDAN BAKER, EXAMINING ATTORNEY

* * * * *

TRADEMARK REGISTRATIONS ISSUED

PRINCIPAL REGISTER

SECTION 1.— INTERNATIONAL CLASSIFICATION

The short titles associated below with the international class numbers are terms designed merely for quick identification and are not an official part of the international classification. The full names of international classes are given in section 6.1 of the trademark rules of practice.

The designation "U.S. Cl." appearing in this section refers to the U.S. class in effect prior to Sep. 1, 1973 rather than the international class which applies to applications filed on or after that date. For adoption of international classification see notice in the OFFICIAL GAZETTE of Jun. 26, 1973 (911 O.G. TM 210).

CLASS 1—CHEMICALS

- 3,566,279. **ICEM (BLOCK FORM)**. HERAEUS KULZER GMBH, MULTIPLE CLASS, (INT. CLS. 1, 5, 9 AND 10), (U.S. CLS. 1, 5, 6, 10, 18, 21, 23, 26, 36, 38, 39, 44, 46, 51 AND 52). SN 76-676,374. PUB. 9-9-2008. FILED 5-3-2007.
- 3,566,434. **LABCOAT AND DESIGN**. LABCOAT LIMITED, MULTIPLE CLASS, (INT. CLS. 1, 5, 10, 42 AND 44), (U.S. CLS. 1, 5, 6, 10, 18, 26, 39, 44, 46, 51, 52, 100 AND 101). SN 77-128,848. PUB. 11-11-2008. FILED 3-12-2007.
- 3,566,452. **RUTLAND AND DESIGN**. RUTLAND PLASTIC TECHNOLOGIES, INC., MULTIPLE CLASS, (INT. CLS. 1 AND 2), (U.S. CLS. 1, 5, 6, 10, 11, 16, 26 AND 46). SN 77-156,374. PUB. 11-11-2008. FILED 4-13-2007.
- 3,566,465. **CHIMERX (BLOCK FORM)**. MOLECULAR BIOLOGY RESOURCES INC., MULTIPLE CLASS, (INT. CLS. 1, 5 AND 42), (U.S. CLS. 1, 5, 6, 10, 18, 26, 44, 46, 51, 52, 100 AND 101). SN 77-183,972. PUB. 11-11-2008. FILED 5-17-2007.
- 3,566,491. **MICROBIAL JUMPSTART (BLOCK FORM)**. GIBSON LABORATORIES, INC., (U.S. CLS. 1, 5, 6, 10, 26 AND 46). SN 77-215,345. PUB. 11-11-2008. FILED 6-26-2007.
- 3,566,508. **C C COVIDIEN (STYLIZED)**. COVIDIEN AG, MULTIPLE CLASS, (INT. CLS. 1, 5, 9, 10, 16 AND 41), (U.S. CLS. 1, 2, 5, 6, 10, 18, 21, 22, 23, 26, 29, 36, 37, 38, 39, 44, 46, 50, 51, 52, 100, 101 AND 107). SN 77-235,145. PUB. 11-11-2008. FILED 7-20-2007.
- 3,566,518. **OPTI-DRILL (BLOCK FORM)**. RAINBOW CHEMICALS, INC., (U.S. CLS. 1, 5, 6, 10, 26 AND 46). SN 77-249,635. PUB. 11-11-2008. FILED 8-8-2007.
- 3,566,539. **TECTROYAL (BLOCK FORM)**. ERBEL AG, (U.S. CLS. 1, 5, 6, 10, 26 AND 46). SN 77-272,142. PUB. 11-11-2008. FILED 9-5-2007.
- 3,566,637. **CHEMICAL DIVERSITY (BLOCK FORM)**. CHEMDIV, INC., DBA CHEMICAL DIVERSITY, MULTIPLE CLASS, (INT. CLS. 1 AND 42), (U.S. CLS. 1, 5, 6, 10, 26, 46, 100 AND 101). SN 77-337,814. PUB. 11-11-2008. FILED 11-27-2007.
- 3,566,736. **ACTIVE MINERALS INTERNATIONAL, LLC (BLOCK FORM)**. ACTIVE MINERALS INTERNATIONAL, LLC, (U.S. CLS. 1, 5, 6, 10, 26 AND 46). SN 77-364,942. PUB. 11-11-2008. FILED 1-5-2008.
- 3,566,746. **ULTRAGRADE (BLOCK FORM)**. ULTRA SCIENTIFIC, INCORPORATED, (U.S. CLS. 1, 5, 6, 10, 26 AND 46). SN 77-368,225. PUB. 11-11-2008. FILED 1-10-2008.
- 3,566,758. **UNIDYNE TG-DRY (BLOCK FORM)**. DAIKIN INDUSTRIES, LTD., (U.S. CLS. 1, 5, 6, 10, 26 AND 46). SN 77-376,480. PUB. 11-11-2008. FILED 1-21-2008.
- 3,566,865. **POROCEL (STYLIZED)**. POROCEL INTERNATIONAL LLC, DBA THE ALUCHEM GROUP LLC, MULTIPLE CLASS, (INT. CLS. 1 AND 40), (U.S. CLS. 1, 5, 6, 10, 26, 46, 100, 103 AND 106). SN 77-445,855. PUB. 11-11-2008. FILED 4-11-2008.
- 3,566,888. **OREBIND (BLOCK FORM)**. NALCO COMPANY, (U.S. CLS. 1, 5, 6, 10, 26 AND 46). SN 77-455,960. PUB. 11-11-2008. FILED 4-23-2008.
- 3,566,941. **INFINYMER AND DESIGN**. PLASTINUM POLYMER TECHNOLOGIES CORP., (U.S. CLS. 1, 5, 6, 10, 26 AND 46). SN 77-475,460. PUB. 11-11-2008. FILED 5-15-2008.
- 3,566,968. **SILSPEC (BLOCK FORM)**. SILICONE SPECIALITIES, INC., MULTIPLE CLASS, (INT. CLS. 1 AND 19), (U.S. CLS. 1, 5, 6, 10, 12, 26, 33, 46 AND 50). SN 77-482,507. PUB. 11-11-2008. FILED 5-23-2008.
- 3,566,978. **SLAGSTOP (BLOCK FORM)**. AMSTAR SURFACE TECHNOLOGY, LTD., (U.S. CLS. 1, 5, 6, 10, 26 AND 46). SN 77-483,399. PUB. 11-11-2008. FILED 5-26-2008.
- 3,567,137. **DTX (BLOCK FORM)**. IKONICS CORPORATION, (U.S. CLS. 1, 5, 6, 10, 26 AND 46). SN 77-497,093. PUB. 11-11-2008. FILED 6-12-2008.
- 3,567,243. **TACS (BLOCK FORM)**. TREVIGEN, INC., (U.S. CLS. 1, 5, 6, 10, 26 AND 46). SN 77-500,517. PUB. 11-11-2008. FILED 6-17-2008.
- 3,567,246. **COMETASSAY (BLOCK FORM)**. TREVIGEN, INC., (U.S. CLS. 1, 5, 6, 10, 26 AND 46). SN 77-500,534. PUB. 11-11-2008. FILED 6-17-2008.
- 3,567,284. **MAGNA TERRA (BLOCK FORM)**. SUPER ABSORBENT COMPANY, (U.S. CLS. 1, 5, 6, 10, 26 AND 46). SN 77-501,104. PUB. 11-11-2008. FILED 6-17-2008.
- 3,567,355. **POLYDRY (BLOCK FORM)**. POLIKOR BOYA SANAYI VE TICARET ANONIM SIRKETI, (U.S. CLS. 1, 5, 6, 10, 26 AND 46). SN 77-502,099. PUB. 11-11-2008. FILED 6-18-2008.
- 3,567,471. **NUTRASOFT (BLOCK FORM)**. ASC MINERAL PROCESSING CO. INC., AND MINERAL PROCESSING CO, (U.S. CLS. 1, 5, 6, 10, 26 AND 46). SN 77-504,256. PUB. 11-11-2008. FILED 6-20-2008.
- 3,567,473. **NUTRALIME (BLOCK FORM)**. ASC MINERAL PROCESSING CO INC, AND MINERAL PROCESSING CO, (U.S. CLS. 1, 5, 6, 10, 26 AND 46). SN 77-504,292. PUB. 11-11-2008. FILED 6-20-2008.
- 3,567,512. **PERCOLL (BLOCK FORM)**. GE HEALTHCARE BIO-SCIENCES AB, (U.S. CLS. 1, 5, 6, 10, 26 AND 46). SN 77-505,197. PUB. 11-11-2008. FILED 6-23-2008.
- 3,567,539. **PERFECT (BLOCK FORM)**. MOLECULAR BIOLOGY RESOURCES, INC, DBA CHIMERX, (U.S. CLS. 1, 5, 6, 10, 26 AND 46). SN 77-505,685. PUB. 11-11-2008. FILED 6-23-2008.
- 3,567,735. **AVANT (BLOCK FORM)**. BASELL N.V., (U.S. CLS. 1, 5, 6, 10, 26 AND 46). SN 78-466,507. PUB. 11-11-2008. FILED 8-12-2004.
- 3,567,763. **ENIGMA (BLOCK FORM)**. ENIGMA DIAGNOSTICS LIMITED, MULTIPLE CLASS, (INT. CLS. 1, 5, 9 AND 10), (U.S. CLS. 1, 5, 6, 10, 18, 21, 23, 26, 36, 38, 39, 44, 46, 51 AND 52). SN 78-825,595. PUB. 11-11-2008. FILED 2-28-2006.
- 3,567,797. **EASYXPRESS (BLOCK FORM)**. QIAGEN GMBH, MULTIPLE CLASS, (INT. CLS. 1, 5 AND 9), (U.S. CLS. 1, 5, 6, 10, 18, 21, 23, 26, 36, 38, 44, 46, 51 AND 52). SN 79-003,301. PUB. 9-20-2005. FILED 12-16-2003.
- 3,567,802. **ATRAVERDA (BLOCK FORM)**. ATRAVERDA LIMITED, MULTIPLE CLASS, (INT. CLS. 1 AND 9), (U.S. CLS. 1, 5, 6, 10, 21, 23, 26, 36, 38 AND 46). SN 79-023,497. PUB. 11-11-2008. FILED 10-27-2005.
- 3,567,814. **MISCELLANEOUS DESIGN**. COSMO BIO CO., LTD., MULTIPLE CLASS, (INT. CLS. 1, 5, 9, 10, 35, 41 AND 42), (U.S. CLS. 1, 5, 6, 10, 18, 21, 23, 26, 36, 38, 39, 44, 46, 51, 52, 100, 101, 102 AND 107). SN 79-032,690. PUB. 11-11-2008. FILED 2-4-2005.
- 3,567,828. **DN-AGE (BLOCK FORM)**. BEIERSDORF AG, (U.S. CLS. 1, 5, 6, 10, 26 AND 46). SN 79-037,925. PUB. 11-11-2008. FILED 3-16-2007.

- 3,567,855. **SACHTOTEC (BLOCK FORM)**. SACHTLEBEN CHEMIE GMBH, MULTIPLE CLASS, (INT. CLS. 1, 2 AND 5), (U.S. CLS. 1, 5, 6, 10, 11, 16, 18, 26, 44, 46, 51 AND 52). SN 79-045,463. PUB. 11-11-2008. FILED 9-21-2007.
- 3,567,874. **BORPEX (STYLIZED)**. BOREALIS AG, MULTIPLE CLASS, (INT. CLS. 1, 17 AND 19), (U.S. CLS. 1, 5, 6, 10, 12, 13, 26, 33, 35, 46 AND 50). SN 79-047,256. PUB. 11-11-2008. FILED 11-23-2007.
- 3,567,877. **STICKY SIRNA (BLOCK FORM)**. POLYPLUS-TRANSFECTION; (SOCIÉTÉ ANONYME), MULTIPLE CLASS, (INT. CLS. 1 AND 42), (U.S. CLS. 1, 5, 6, 10, 26, 46, 100 AND 101). SN 79-047,473. PUB. 11-11-2008. FILED 11-16-2007.
- 3,567,931. **SINTERMASK (STYLIZED)**. SINTERMASK TECHNOLOGIES AKTIEBOLAG, MULTIPLE CLASS, (INT. CLS. 1, 9, 11 AND 40), (U.S. CLS. 1, 5, 6, 10, 13, 21, 23, 26, 31, 34, 36, 38, 46, 100, 103 AND 106). SN 79-051,084. PUB. 11-11-2008. FILED 1-9-2008.
- 3,567,933. **LOUIS DREYFUS COMMODITIES AND DESIGN**. LOUIS DREYFUS TRADEMARKS B.V., MULTIPLE CLASS, (INT. CLS. 1, 3, 4, 6, 7, 12, 19, 22, 23, 24, 29, 30, 31, 32, 35, 36, 37, 38, 39, 40 AND 42), (U.S. CLS. 1, 2, 4, 5, 6, 7, 10, 12, 13, 14, 15, 19, 21, 22, 23, 25, 26, 31, 33, 34, 35, 42, 43, 44, 45, 46, 48, 50, 51, 52, 100, 101, 102, 103, 104, 105 AND 106). SN 79-051,307. PUB. 11-11-2008. FILED 1-29-2008.
- 3,567,934. **LOUIS DREYFUS COTTON INTERNATIONAL NV AND DESIGN**. LOUIS DREYFUS TRADEMARKS B.V., MULTIPLE CLASS, (INT. CLS. 1, 3, 4, 6, 7, 12, 19, 22, 23, 24, 29, 30, 31, 32, 35, 36, 37, 38, 39, 40 AND 42), (U.S. CLS. 1, 2, 4, 5, 6, 7, 10, 12, 13, 14, 15, 19, 21, 22, 23, 25, 26, 31, 33, 34, 35, 42, 43, 44, 45, 46, 48, 50, 51, 52, 100, 101, 102, 103, 104, 105 AND 106). SN 79-051,308. PUB. 11-11-2008. FILED 1-29-2008.
- 3,567,935. **LOUIS DREYFUS (BLOCK FORM)**. LOUIS DREYFUS TRADEMARKS B.V., MULTIPLE CLASS, (INT. CLS. 1, 3, 4, 6, 7, 12, 19, 22, 23, 24, 29, 30, 31, 32, 35, 36, 37, 38, 39, 40 AND 42), (U.S. CLS. 1, 2, 4, 5, 6, 7, 10, 12, 13, 14, 15, 19, 21, 22, 23, 25, 26, 31, 33, 34, 35, 42, 43, 44, 45, 46, 48, 50, 51, 52, 100, 101, 102, 103, 104, 105 AND 106). SN 79-051,368. PUB. 11-11-2008. FILED 1-29-2008.
- 3,567,936. **LOUIS DREYFUS AND DESIGN**. LOUIS DREYFUS TRADEMARKS B.V., MULTIPLE CLASS, (INT. CLS. 1, 3, 4, 6, 7, 12, 19, 22, 23, 24, 29, 30, 31, 32, 35, 36, 37, 38, 39, 40 AND 42), (U.S. CLS. 1, 2, 4, 5, 6, 7, 10, 12, 13, 14, 15, 19, 21, 22, 23, 25, 26, 31, 33, 34, 35, 42, 43, 44, 45, 46, 48, 50, 51, 52, 100, 101, 102, 103, 104, 105 AND 106). SN 79-051,369. PUB. 11-11-2008. FILED 1-29-2008.
- 3,567,961. **INCROSLIP (BLOCK FORM)**. CRODA INTERNATIONAL PLC, (U.S. CLS. 1, 5, 6, 10, 26 AND 46). SN 79-054,428. PUB. 11-11-2008. FILED 4-17-2008.
- 3,567,962. **CRODAMIDE (BLOCK FORM)**. CRODA INTERNATIONAL PLC, (U.S. CLS. 1, 5, 6, 10, 26 AND 46). SN 79-054,430. PUB. 11-11-2008. FILED 4-17-2008.
- 3,567,975. **EUKALIN (STYLIZED)**. EUKALIN SPEZIALKLEBSTOFF FABRIK GMBH, MULTIPLE CLASS, (INT. CLS. 1 AND 16), (U.S. CLS. 1, 2, 5, 6, 10, 22, 23, 26, 29, 37, 38, 46 AND 50). SN 79-055,610. PUB. 11-11-2008. FILED 2-27-2008.

CLASS 2—PAINTS

- 3,566,438. **VOLVO AND DESIGN**. VOLVO TRADEMARK HOLDING AB, MULTIPLE CLASS, (INT. CLS. 2 AND 9), (U.S. CLS. 6, 11, 16, 21, 23, 26, 36 AND 38). SN 77-138,807. PUB. 11-11-2008. FILED 3-23-2007.
- 3,566,452 (*See Class 1 for this trademark*).
- 3,566,741. **B BOSNY BOSNY AND DESIGN**. R.J. LONDON CHEMICALS INDUSTRIES CO., LTD., (U.S. CLS. 6, 11 AND 16). SN 77-367,008. PUB. 11-11-2008. FILED 1-8-2008.
- 3,567,169. **DURA-POXY (BLOCK FORM)**. KELLY-MOORE PAINT COMPANY, INC., (U.S. CLS. 6, 11 AND 16). SN 77-498,501. PUB. 11-11-2008. FILED 6-13-2008.
- 3,567,749. **CREMIEUX AND DESIGN**. CREMIEUX, STÉPHANE, MULTIPLE CLASS, (INT. CLS. 2, 3, 4, 8, 9, 14, 16, 18, 20, 21, 24, 25, 26, 27 AND 44), (U.S. CLS. 1, 2, 3, 4, 5, 6, 11, 13, 15, 16, 19, 20, 21, 22, 23, 25, 26, 27, 28, 29, 30, 32, 33, 36, 37, 38, 39, 40, 41, 42, 44, 50, 51, 52, 100 AND 101). SN 78-

- 728,597. PUB. 3-25-2008. FILED 10-7-2005.
- 3,567,778. **GALVARUST (BLOCK FORM)**. ENDZRUST TECHNOLOGIES INC., (U.S. CLS. 6, 11 AND 16). SN 78-941,249. PUB. 11-11-2008. FILED 7-31-2006.
- 3,567,779. **SILENT RUNNING AND DESIGN**. CURRENT INC., (U.S. CLS. 6, 11 AND 16). SN 78-941,878. PUB. 9-25-2007. FILED 8-1-2006.
- 3,567,785. **FACE INKS AND DESIGN**. 3'S COMPANY, LLC, (U.S. CLS. 6, 11 AND 16). SN 78-959,595. PUB. 11-11-2008. FILED 8-24-2006.
- 3,567,855 (*See Class 1 for this trademark*).

CLASS 3—COSMETICS AND CLEANING PREPARATIONS

- 3,566,273. **BERLANTI OF CALIFORNIA AND DESIGN**. AZ-HAK, HUSSAM, (U.S. CLS. 1, 4, 6, 50, 51 AND 52). SN 76-669,777. PUB. 11-11-2008. FILED 12-1-2006.
- 3,566,288. **HOTBOX AND DESIGN**. BANGHAM, DAVID, (U.S. CLS. 1, 4, 6, 50, 51 AND 52). SN 76-681,135. PUB. 11-11-2008. FILED 8-24-2007.
- 3,566,291. **BHB BRING IT HOME BEAUTY AND DESIGN**. HARRIS, REBECCA D., AND HARRIS, ANGELA M., MULTIPLE CLASS, (INT. CLS. 3 AND 9), (U.S. CLS. 1, 4, 6, 21, 23, 26, 36, 38, 50, 51 AND 52). SN 76-683,255. PUB. 11-11-2008. FILED 10-24-2007.
- 3,566,297. **BEDTIME (BLOCK FORM)**. JOHNSON & JOHNSON, (U.S. CLS. 1, 4, 6, 50, 51 AND 52). SN 76-684,152. PUB. 11-11-2008. FILED 11-19-2007.
- 3,566,303. **REDI+ WASH (BLOCK FORM)**. DONOVAN INDUSTRIES, INC., (U.S. CLS. 1, 4, 6, 50, 51 AND 52). SN 76-685,093. PUB. 11-11-2008. FILED 12-19-2007.
- 3,566,330. **PET BOTANICS (STYLIZED)**. CARDINAL LABORATORIES, INC., MULTIPLE CLASS, (INT. CLS. 3 AND 18), (U.S. CLS. 1, 2, 3, 4, 6, 22, 41, 50, 51 AND 52). SN 76-689,042. PUB. 11-11-2008. FILED 4-28-2008.
- 3,566,338. **O-PLEX TECHNOLOGY (BLOCK FORM)**. TWI FRANCHISING, INC., (U.S. CLS. 1, 4, 6, 50, 51 AND 52). SN 76-690,196. PUB. 11-11-2008. FILED 6-2-2008.
- 3,566,374. **SASS & SILK (BLOCK FORM)**. RAGLIN, TERRY R., (U.S. CLS. 1, 4, 6, 50, 51 AND 52). SN 77-021,476. PUB. 11-11-2008. FILED 10-15-2006.
- 3,566,382. **SIDERLINK (STYLIZED)**. GLORIA MED PHARMA S.R.L., MULTIPLE CLASS, (INT. CLS. 3 AND 5), (U.S. CLS. 1, 4, 6, 18, 44, 46, 50, 51 AND 52). SN 77-045,418. PUB. 8-12-2008. FILED 11-16-2006.
- 3,566,419. **BLANC BY IU (BLOCK FORM)**. IU COSMETICS S.A. DE C.V., MULTIPLE CLASS, (INT. CLS. 3 AND 16), (U.S. CLS. 1, 2, 4, 5, 6, 22, 23, 29, 37, 38, 50, 51 AND 52). SN 77-096,198. PUB. 11-11-2008. FILED 1-31-2007.
- 3,566,436. **HANDS ON (BLOCK FORM)**. GUINOT, (U.S. CLS. 1, 4, 6, 50, 51 AND 52). SN 77-133,423. PUB. 11-11-2008. FILED 3-16-2007.
- 3,566,483. **MINTY TOES AND DESIGN**. ZEN SPA ENTERTAINMENT, INC., (U.S. CLS. 1, 4, 6, 50, 51 AND 52). SN 77-207,438. PUB. 11-11-2008. FILED 6-15-2007.
- 3,566,513. **THINGS FROM HOME INC. AND DESIGN**. MICKY DYE-ISHIKAWA, DBA THINGS FROM HOME INC., MULTIPLE CLASS, (INT. CLS. 3 AND 45), (U.S. CLS. 1, 4, 6, 50, 51, 52, 100 AND 101). SN 77-241,288. PUB. 11-11-2008. FILED 7-27-2007.
- 3,566,516. **SIMPLE GREEN PAINT PREP & CLEAN-UP AND DESIGN**. SUNSHINE MAKERS, INC., (U.S. CLS. 1, 4, 6, 50, 51 AND 52). SN 77-242,599. PUB. 11-11-2008. FILED 7-30-2007.
- 3,566,815. **YAKULT (BLOCK FORM)**. KABUSHIKI KAISHA YAKULT HONSHA, (U.S. CLS. 1, 4, 6, 50, 51 AND 52). SN 77-417,461. PUB. 9-9-2008. FILED 3-10-2008.
- 3,566,859. **SWISS ORGANIC AND DESIGN**. PFISTER, ROLAND C., (U.S. CLS. 1, 4, 6, 50, 51 AND 52). SN 77-444,077. PUB. 11-11-2008. FILED 4-9-2008.
- 3,566,908. **C AND DESIGN**. THE FORMULAAH, LLC, (U.S. CLS. 1, 4, 6, 50, 51 AND 52). SN 77-464,229. PUB. 11-11-2008. FILED 5-2-2008.
- 3,566,909. **THE FORMULAAH (BLOCK FORM)**. THE FORMULAAH, LLC, (U.S. CLS. 1, 4, 6, 50, 51 AND 52). SN 77-

- 464,280. PUB. 11-11-2008. FILED 5-2-2008.
- 3,566,918. **NANO FADE DEFENSE (BLOCK FORM)**. PHARMAGEL INTERNATIONAL, INC., (U.S. CLS. 1, 4, 6, 50, 51 AND 52). SN 77-468,240. PUB. 11-11-2008. FILED 5-7-2008.
- 3,566,951. **MAXIMIZER DT PRO (BLOCK FORM)**. STATE-WIDE SUPPLY, INC., (U.S. CLS. 1, 4, 6, 50, 51 AND 52). SN 77-478,064. PUB. 11-11-2008. FILED 5-19-2008.
- 3,567,053. **KATE'S MAGIK AND DESIGN**. KATE BECKER, DBA KATE'S MAGIK, (U.S. CLS. 1, 4, 6, 50, 51 AND 52). SN 77-491,929. PUB. 11-11-2008. FILED 6-5-2008.
- 3,567,142. **ORIKI (BLOCK FORM)**. ORIKI COSMETICS, INC., (U.S. CLS. 1, 4, 6, 50, 51 AND 52). SN 77-497,383. PUB. 11-11-2008. FILED 6-12-2008.
- 3,567,379. **N8B AND DESIGN**. NATE B, LLC, (U.S. CLS. 1, 4, 6, 50, 51 AND 52). SN 77-502,466. PUB. 11-11-2008. FILED 6-18-2008.
- 3,567,392. **ORGANODERM (BLOCK FORM)**. EDWARD DOMANSKIS, (U.S. CLS. 1, 4, 6, 50, 51 AND 52). SN 77-502,675. PUB. 11-11-2008. FILED 6-19-2008.
- 3,567,393. **HELLOMELLOW (BLOCK FORM)**. FELDSTEIN, TRACY, (U.S. CLS. 1, 4, 6, 50, 51 AND 52). SN 77-502,679. PUB. 11-11-2008. FILED 6-19-2008.
- 3,567,532. **ULTIMATE INSTINCT (BLOCK FORM)**. FRENCH, DONNA C., DBA ULTIMATE OIL PRESENTS, (U.S. CLS. 1, 4, 6, 50, 51 AND 52). SN 77-505,437. PUB. 11-11-2008. FILED 6-23-2008.
- 3,567,551. **DEA BELLA (BLOCK FORM)**. LEE, ANNE, DBA AMBER & LINLEY, (U.S. CLS. 1, 4, 6, 50, 51 AND 52). SN 77-505,877. PUB. 11-11-2008. FILED 6-23-2008.
- 3,567,560. **MOUNT BLESSING (BLOCK FORM)**. JACOB'S LIVING WATER, INC., DBA JACOB'S SPRING, INC., (U.S. CLS. 1, 4, 6, 50, 51 AND 52). SN 77-506,133. PUB. 11-11-2008. FILED 6-24-2008.
- 3,567,561. **TRIFUSION TECHNOLOGY (BLOCK FORM)**. L'OREAL USA CREATIVE, INC., (U.S. CLS. 1, 4, 6, 50, 51 AND 52). SN 77-506,185. PUB. 11-11-2008. FILED 6-24-2008.
- 3,567,577. **AQUAMER INSTITUTE SWISS (BLOCK FORM)**. GUEST SUPPLY, LLC, (U.S. CLS. 1, 4, 6, 50, 51 AND 52). SN 77-506,713. PUB. 11-11-2008. FILED 6-24-2008.
- 3,567,579. **SK-II WHITENING SOURCE SKIN BRIGHTENER (BLOCK FORM)**. THE PROCTER & GAMBLE COMPANY, (U.S. CLS. 1, 4, 6, 50, 51 AND 52). SN 77-506,723. PUB. 11-11-2008. FILED 6-24-2008.
- 3,567,626. **BRONZEUPHORIA (BLOCK FORM)**. DESIGNER SKIN, LLC, (U.S. CLS. 1, 4, 6, 50, 51 AND 52). SN 77-509,989. PUB. 11-11-2008. FILED 6-27-2008.
- 3,567,627. **HEMPTATION (BLOCK FORM)**. DESIGNER SKIN, LLC, (U.S. CLS. 1, 4, 6, 50, 51 AND 52). SN 77-510,155. PUB. 11-11-2008. FILED 6-27-2008.
- 3,567,633. **SOFT & EVEN (BLOCK FORM)**. JOHNSON & JOHNSON, (U.S. CLS. 1, 4, 6, 50, 51 AND 52). SN 77-510,838. PUB. 11-11-2008. FILED 6-30-2008.
- 3,567,674. **MUCH LOVE BATH COLLECTION GIVING YOURSELF THE LOVE YOU DESERVE AND DESIGN**. TUCKER-JOHNSON, BRENDA, (U.S. CLS. 1, 4, 6, 50, 51 AND 52). SN 77-523,068. PUB. 11-11-2008. FILED 7-15-2008.
- 3,567,697. **OLIVAMINE (BLOCK FORM)**. MCCORD RESEARCH, INC., MULTIPLE CLASS, (INT. CLS. 3 AND 5), (U.S. CLS. 1, 4, 6, 18, 44, 46, 50, 51 AND 52). SN 77-534,039. PUB. 11-11-2008. FILED 7-29-2008.
- 3,567,726. **KISSABLY BABY SOFT**. JOHNSON & JOHNSON, (U.S. CLS. 1, 4, 6, 50, 51 AND 52). SN 78-164,712. PUB. 12-16-2003. FILED 9-17-2002.
- 3,567,727. **MYLA (STYLIZED)**. LILESTONE, PLC, (U.S. CLS. 1, 4, 6, 50, 51 AND 52). SN 78-170,946. PUB. 9-19-2006. FILED 10-4-2002.
- 3,567,749 (See Class 2 for this trademark).
- 3,567,762. **SENTIVA MATT (BLOCK FORM)**. JAFER LIMITED, (U.S. CLS. 1, 4, 6, 50, 51 AND 52). SN 78-808,079. PUB. 11-11-2008. FILED 2-6-2006.
- 3,567,784. **NOVA AND DESIGN**. KERTZ, MALCOLM GLEN, MULTIPLE CLASS, (INT. CLS. 3 AND 21), (U.S. CLS. 1, 2, 4, 6, 13, 23, 29, 30, 33, 40, 50, 51 AND 52). SN 78-959,382. PUB. 11-11-2008. FILED 8-24-2006.
- 3,567,786. **PURIFY AND DESIGN**. KERTZ, MALCOLM GLEN, (U.S. CLS. 1, 4, 6, 50, 51 AND 52). SN 78-959,640. PUB. 11-11-2008. FILED 8-24-2006.
- 3,567,787. **REVEAL AND DESIGN**. KERTZ, MALCOLM GLEN, (U.S. CLS. 1, 4, 6, 50, 51 AND 52). SN 78-959,677. PUB. 11-11-2008. FILED 8-24-2006.
- 3,567,788. **QUENCH AND DESIGN**. KERTZ, MALCOLM GLEN, (U.S. CLS. 1, 4, 6, 50, 51 AND 52). SN 78-959,690. PUB. 11-11-2008. FILED 8-24-2006.
- 3,567,819. **BIOSELECT AND DESIGN**. "I. XARMANI-X. KRISTOULAKIS O.E."; CRETA LAND OF PLENTY, (U.S. CLS. 1, 4, 6, 50, 51 AND 52). SN 79-034,378. PUB. 11-11-2008. FILED 10-11-2006.
- 3,567,831. **ÅÅÖ (BLOCK FORM)**. ÅÅÖ NORDIC AB, MULTIPLE CLASS, (INT. CLS. 3, 16, 18 AND 28), (U.S. CLS. 1, 2, 3, 4, 5, 6, 22, 23, 29, 37, 38, 41, 50, 51 AND 52). SN 79-039,178. PUB. 11-11-2008. FILED 3-28-2007.
- 3,567,871. **7:15 AM IN BALI (STYLIZED)**. KENZO S.A., (U.S. CLS. 1, 4, 6, 50, 51 AND 52). SN 79-046,906. PUB. 11-11-2008. FILED 11-9-2007.
- 3,567,912. **GALEANDE PARIS (STYLIZED)**. PATRICK EINHORN, MULTIPLE CLASS, (INT. CLS. 3, 9, 14, 18, 24 AND 25), (U.S. CLS. 1, 2, 3, 4, 6, 21, 22, 23, 26, 27, 28, 36, 38, 39, 41, 42, 50, 51 AND 52). SN 79-049,851. PUB. 11-11-2008. FILED 11-30-2007.
- 3,567,927. **FARMAPOSTA IL BENESSERE IN UN CLICK! AND DESIGN**. FARMAPOSTA HEALTHCARE LTD, MULTIPLE CLASS, (INT. CLS. 3 AND 5), (U.S. CLS. 1, 4, 6, 18, 44, 46, 50, 51 AND 52). SN 79-050,471. PUB. 11-11-2008. FILED 7-20-2007.
- 3,567,933 (See Class 1 for this trademark).
- 3,567,934 (See Class 1 for this trademark).
- 3,567,935 (See Class 1 for this trademark).
- 3,567,936 (See Class 1 for this trademark).
- 3,567,948. **MISCELLANEOUS DESIGN**. OBCHTCHESTVO S OGRANITCHENNOI; OTVETSTVENNOSTIOU; "SIBIRSKOE ZDOROVIE K", (U.S. CLS. 1, 4, 6, 50, 51 AND 52). SN 79-052,269. PUB. 11-11-2008. FILED 5-14-2007.
- 3,567,954. **JASMIN NOIR (BLOCK FORM)**. BULGARI S.P.A., (U.S. CLS. 1, 4, 6, 50, 51 AND 52). SN 79-053,147. PUB. 11-11-2008. FILED 3-20-2008.
- 3,567,966. **BIOBLAS (BLOCK FORM)**. BIOTA BITKISEL KOZMETIK; LABORATUARLARI; TICARET LIMITED SIRKETI, (U.S. CLS. 1, 4, 6, 50, 51 AND 52). SN 79-054,769. PUB. 11-11-2008. FILED 4-3-2008.
- 3,567,970. **LEGEND & SOUL (STYLIZED)**. ZIBI JACQUY, MULTIPLE CLASS, (INT. CLS. 3, 14, 18 AND 25), (U.S. CLS. 1, 2, 3, 4, 6, 22, 27, 28, 39, 41, 50, 51 AND 52). SN 79-055,165. PUB. 11-11-2008. FILED 12-3-2007.
- 3,567,989. **NECTALYS (BLOCK FORM)**. PIERRE FABRE DERMO-COSMETIQUE, (U.S. CLS. 1, 4, 6, 50, 51 AND 52). SN 79-057,802. PUB. 11-11-2008. FILED 8-1-2008.

CLASS 4—LUBRICANTS AND FUELS

- 3,566,328. **EVEROIL AND DESIGN**. DEMSONS, LLC, (U.S. CLS. 1, 6 AND 15). SN 76-688,867. PUB. 11-11-2008. FILED 4-22-2008.
- 3,566,482. **SUGAR RAY CANE AND DESIGN**. COTTON, STANLEY S., (U.S. CLS. 1, 6 AND 15). SN 77-207,116. PUB. 11-11-2008. FILED 6-15-2007.
- 3,567,371. **MOTION LOTION (BLOCK FORM)**. BAILEY'S INC., (U.S. CLS. 1, 6 AND 15). SN 77-502,381. PUB. 11-11-2008. FILED 6-18-2008.
- 3,567,749 (See Class 2 for this trademark).
- 3,567,774. **COMPERJ (BLOCK FORM)**. PETROLEO BRASILEIRO S.A.- PETROBRAS, (U.S. CLS. 1, 6 AND 15). SN 78-903,543. PUB. 11-11-2008. FILED 6-8-2006.
- 3,567,850. **GEOCYCLE (BLOCK FORM)**. HOLCIM IP LTD, MULTIPLE CLASS, (INT. CLS. 4, 39, 40 AND 42), (U.S. CLS. 1, 6, 15, 100, 101, 103, 105 AND 106). SN 79-043,246. PUB. 11-11-2008. FILED 12-15-2006.
- 3,567,863. **MERCURIA (BLOCK FORM)**. MERCURIA ENERGY TRADING S.A., MULTIPLE CLASS, (INT. CLS. 4, 35, 39 AND 40), (U.S. CLS. 1, 6, 15, 100, 101, 102, 103, 105 AND 106). SN 79-046,003. PUB. 11-11-2008. FILED 10-10-2007.
- 3,567,864. **MERCURIA AND DESIGN**. MERCURIA ENERGY TRADING S.A., MULTIPLE CLASS, (INT. CLS. 4, 35, 39 AND 40), (U.S. CLS. 1, 6, 15, 100, 101, 102, 103, 105 AND 106).

SN 79-046,004. PUB. 11-11-2008. FILED 10-10-2007.
 3,567,933 (*See Class 1 for this trademark*).
 3,567,934 (*See Class 1 for this trademark*).
 3,567,935 (*See Class 1 for this trademark*).
 3,567,936 (*See Class 1 for this trademark*).

CLASS 5—PHARMACEUTICALS

3,566,279 (*See Class 1 for this trademark*).
 3,566,376. **MISCELLANEOUS DESIGN**. SA SA OVERSEAS LIMITED, MULTIPLE CLASS, (INT. CLS. 5 AND 18), (U.S. CLS. 1, 2, 3, 6, 18, 22, 41, 44, 46, 51 AND 52). SN 77-025,892. PUB. 11-11-2008. FILED 10-20-2006.
 3,566,382 (*See Class 3 for this trademark*).
 3,566,424. **SONLEVA (BLOCK FORM)**. SOLVAY PHARMACEUTICALS B.V., (U.S. CLS. 6, 18, 44, 46, 51 AND 52). SN 77-114,669. PUB. 11-11-2008. FILED 2-23-2007.
 3,566,425. **STEBLIZ (BLOCK FORM)**. SOLVAY PHARMACEUTICALS B.V., (U.S. CLS. 6, 18, 44, 46, 51 AND 52). SN 77-114,689. PUB. 11-11-2008. FILED 2-23-2007.
 3,566,426. **BALNEURA (BLOCK FORM)**. SOLVAY PHARMACEUTICALS B.V., (U.S. CLS. 6, 18, 44, 46, 51 AND 52). SN 77-114,757. PUB. 11-11-2008. FILED 2-23-2007.
 3,566,427. **ANCHRA (BLOCK FORM)**. SOLVAY PHARMACEUTICALS B.V., (U.S. CLS. 6, 18, 44, 46, 51 AND 52). SN 77-114,835. PUB. 11-11-2008. FILED 2-23-2007.
 3,566,428. **UCHEVE (BLOCK FORM)**. SOLVAY PHARMACEUTICALS B.V., (U.S. CLS. 6, 18, 44, 46, 51 AND 52). SN 77-114,950. PUB. 11-11-2008. FILED 2-23-2007.
 3,566,434 (*See Class 1 for this trademark*).
 3,566,454. **SPAND-GEL (BLOCK FORM)**. MEDI-TECH INTERNATIONAL CORPORATION, (U.S. CLS. 6, 18, 44, 46, 51 AND 52). SN 77-159,587. PUB. 11-11-2008. FILED 4-18-2007.
 3,566,465 (*See Class 1 for this trademark*).
 3,566,508 (*See Class 1 for this trademark*).
 3,566,656. **FIBER BALANCE (BLOCK FORM)**. NOBLESTAR, INCORPORATED, DBA INTEGRATED SUPPLEMENTS, (U.S. CLS. 6, 18, 44, 46, 51 AND 52). SN 77-342,630. PUB. 11-11-2008. FILED 12-3-2007.
 3,566,707. **CHERRY AIR AND DESIGN**. CLENAIR MANUFACTURING, INC., (U.S. CLS. 6, 18, 44, 46, 51 AND 52). SN 77-355,487. PUB. 11-11-2008. FILED 12-19-2007.
 3,566,755. **ANTIDE (BLOCK FORM)**. ARES TRADING S.A., (U.S. CLS. 6, 18, 44, 46, 51 AND 52). SN 77-374,205. PUB. 11-11-2008. FILED 1-17-2008.
 3,566,783. **DOCTORS #1 ITCH MEDICINE RECOMMEND AND DESIGN**. SIGNAL INVESTMENT & MANAGEMENT CO., (U.S. CLS. 6, 18, 44, 46, 51 AND 52). SN 77-394,576. PUB. 11-11-2008. FILED 2-12-2008.
 3,566,914. **VERAMYST (STYLIZED)**. GLAXO GROUP LIMITED, (U.S. CLS. 6, 18, 44, 46, 51 AND 52). SN 77-466,545. PUB. 11-11-2008. FILED 5-6-2008.
 3,566,994. **OPTIMAL HEALTH SCIENCE (BLOCK FORM)**. OPTIMAL HEALTH SCIENCE, LLC, (U.S. CLS. 6, 18, 44, 46, 51 AND 52). SN 77-486,077. PUB. 11-11-2008. FILED 5-29-2008.
 3,567,065. **LORESKA (BLOCK FORM)**. ARENA PHARMACEUTICALS GMBH, (U.S. CLS. 6, 18, 44, 46, 51 AND 52). SN 77-493,027. PUB. 11-11-2008. FILED 6-6-2008.
 3,567,177. **HAIRGENESIS (BLOCK FORM)**. ADVANCED RESTORATION TECHNOLOGIES INC., DBA HAIRGENESIS, (U.S. CLS. 6, 18, 44, 46, 51 AND 52). SN 77-499,141. PUB. 11-11-2008. FILED 6-14-2008.
 3,567,276. **BLUEVAC (BLOCK FORM)**. CZ VETERINARIA, S.A., (U.S. CLS. 6, 18, 44, 46, 51 AND 52). SN 77-500,980. PUB. 11-11-2008. FILED 6-17-2008.
 3,567,285. **YEFENSE (BLOCK FORM)**. TAWANNA L. MYLES, DBA LADY MYLES ENTERPRISE, (U.S. CLS. 6, 18, 44, 46, 51 AND 52). SN 77-501,114. PUB. 11-11-2008. FILED 6-17-2008.
 3,567,324. **CACTUS SLIM (BLOCK FORM)**. FEDERAL LABORATORIES CHEMICAL CORPORATION, DBA JEFFREY TAUB, (U.S. CLS. 6, 18, 44, 46, 51 AND 52). SN 77-501,688. PUB. 11-11-2008. FILED 6-18-2008.
 3,567,363. **CST BOOST (BLOCK FORM)**. LIFEBURST, INC.,

(U.S. CLS. 6, 18, 44, 46, 51 AND 52). SN 77-502,237. PUB. 11-11-2008. FILED 6-18-2008.
 3,567,420. **M8 (BLOCK FORM)**. THE WINNING COMBINATION INC., (U.S. CLS. 6, 18, 44, 46, 51 AND 52). SN 77-503,059. PUB. 11-11-2008. FILED 6-19-2008.
 3,567,421. **ROCK HARD ALL NIGHT LONG (BLOCK FORM)**. THE WINNING COMBINATION INC., (U.S. CLS. 6, 18, 44, 46, 51 AND 52). SN 77-503,117. PUB. 11-11-2008. FILED 6-19-2008.
 3,567,465. **DON'T WORRY, SLEEP HAPPY (BLOCK FORM)**. DREAMERZ FOODS, INC., (U.S. CLS. 6, 18, 44, 46, 51 AND 52). SN 77-504,121. PUB. 11-11-2008. FILED 6-20-2008.
 3,567,558. **TRI-MATRIX (BLOCK FORM)**. BRUEL, SAMUEL, (U.S. CLS. 6, 18, 44, 46, 51 AND 52). SN 77-506,101. PUB. 11-11-2008. FILED 6-24-2008.
 3,567,615. **ZOMIG-ZMT (BLOCK FORM)**. IPR PHARMACEUTICALS, INC., (U.S. CLS. 6, 18, 44, 46, 51 AND 52). SN 77-507,516. PUB. 11-11-2008. FILED 6-25-2008.
 3,567,634. **EVITHROM (BLOCK FORM)**. JOHNSON & JOHNSON, (U.S. CLS. 6, 18, 44, 46, 51 AND 52). SN 77-510,839. PUB. 11-11-2008. FILED 6-30-2008.
 3,567,697 (*See Class 3 for this trademark*).
 3,567,724. **GTC NUTRITION (BLOCK FORM)**. CPINGREDIENTS, LLC, TA GTC NUTRITION, (U.S. CLS. 6, 18, 44, 46, 51 AND 52). SN 78-151,293. PUB. 11-13-2007. FILED 8-6-2002.
 3,567,729. **AULIN**. HELSINN HEALTHCARE SA, (U.S. CLS. 6, 18, 44, 46, 51 AND 52). SN 78-308,420. PUB. 10-11-2005. FILED 10-2-2003.
 3,567,759. **EXCEL NUTRITIONAL AND DESIGN**. HEALTH SYSTEMS INTERNATIONAL, INC., (U.S. CLS. 6, 18, 44, 46, 51 AND 52). SN 78-778,749. PUB. 11-11-2008. FILED 12-21-2005.
 3,567,763 (*See Class 1 for this trademark*).
 3,567,766. **DUBZ (BLOCK FORM)**. KOONICHI INCORPORATED, (U.S. CLS. 6, 18, 44, 46, 51 AND 52). SN 78-843,896. PUB. 11-11-2008. FILED 3-22-2006.
 3,567,797 (*See Class 1 for this trademark*).
 3,567,814 (*See Class 1 for this trademark*).
 3,567,827. **T2CURE (STYLIZED)**. T2CURE GMBH, MULTIPLE CLASS, (INT. CLS. 5 AND 42), (U.S. CLS. 6, 18, 44, 46, 51, 52, 100 AND 101). SN 79-037,818. PUB. 11-11-2008. FILED 3-6-2007.
 3,567,843. **NANOREPRO (BLOCK FORM)**. NANOREPRO GMBH, MULTIPLE CLASS, (INT. CLS. 5 AND 42), (U.S. CLS. 6, 18, 44, 46, 51, 52, 100 AND 101). SN 79-041,559. PUB. 11-11-2008. FILED 5-10-2007.
 3,567,855 (*See Class 1 for this trademark*).
 3,567,927 (*See Class 3 for this trademark*).
 3,567,928. **REPTILE ONE (STYLIZED)**. KONG'S (AUST) PTY LIMITED, MULTIPLE CLASS, (INT. CLS. 5, 9, 11, 16, 19, 20, 21 AND 31), (U.S. CLS. 1, 2, 5, 6, 12, 13, 18, 21, 22, 23, 25, 26, 29, 30, 31, 32, 33, 34, 36, 37, 38, 40, 44, 46, 50, 51 AND 52). SN 79-050,647. PUB. 11-11-2008. FILED 4-5-2007.
 3,567,944. **OSMOHALE (BLOCK FORM)**. PHARMAXIS LTD, (U.S. CLS. 6, 18, 44, 46, 51 AND 52). SN 79-051,981. PUB. 11-11-2008. FILED 3-5-2008.
 3,567,949. **MISCELLANEOUS DESIGN**. ZHEJIANG FOREST BAMBOO CHARCOAL CO., LTD., MULTIPLE CLASS, (INT. CLS. 5, 20 AND 21), (U.S. CLS. 2, 6, 13, 18, 22, 23, 25, 29, 30, 32, 33, 40, 44, 46, 50, 51 AND 52). SN 79-052,470. PUB. 11-11-2008. FILED 3-11-2008.
 3,567,952. **TENDER FIBER (BLOCK FORM)**. MICERIUM SPA, (U.S. CLS. 6, 18, 44, 46, 51 AND 52). SN 79-053,029. PUB. 11-11-2008. FILED 2-27-2008.
 3,567,976. **HUNTER IMMUNOLOGY AND DESIGN**. HUNTER IMMUNOLOGY LTD, (U.S. CLS. 6, 18, 44, 46, 51 AND 52). SN 79-055,759. PUB. 11-11-2008. FILED 5-7-2008.

CLASS 6—METAL GOODS

3,566,403. **VICENZA (STYLIZED)**. SEA PACIFIC INVESTMENTS, LLC, MULTIPLE CLASS, (INT. CLS. 6, 9 AND 21), (U.S. CLS. 2, 12, 13, 14, 21, 23, 25, 26, 29, 30, 33, 36, 38, 40 AND 50). SN 77-077,352. PUB. 4-8-2008. FILED 1-5-2007.
 3,566,431. **RETURN ON GENEROSITY (BLOCK FORM)**. GIVEMEANING PRODUCTS INC., MULTIPLE CLASS,

- (INT. CLS. 6, 16, 20, 35 AND 36), (U.S. CLS. 2, 5, 12, 13, 14, 22, 23, 25, 29, 32, 37, 38, 50, 100, 101 AND 102). SN 77-126,410. PUB. 11-11-2008. FILED 3-9-2007.
- 3,566,432. **\$5 PHILANTHROPIST (BLOCK FORM)**. GIVE-MEANING PRODUCTS INC., MULTIPLE CLASS, (INT. CLS. 6, 16, 20, 35 AND 36), (U.S. CLS. 2, 5, 12, 13, 14, 22, 23, 25, 29, 32, 37, 38, 50, 100, 101 AND 102). SN 77-126,423. PUB. 11-11-2008. FILED 3-9-2007.
- 3,566,459. **CAL (STYLIZED)**. THE REGENTS OF THE UNIVERSITY OF CALIFORNIA, MULTIPLE CLASS, (INT. CLS. 6, 12, 16 AND 41), (U.S. CLS. 2, 5, 12, 13, 14, 19, 21, 22, 23, 25, 29, 31, 35, 37, 38, 44, 50, 100, 101 AND 107). SN 77-176,554. PUB. 11-11-2008. FILED 5-9-2007.
- 3,566,494. **ROYAL (BLOCK FORM)**. ROYAL ALUMINUM & STEEL, INC., (U.S. CLS. 2, 12, 13, 14, 23, 25 AND 50). SN 77-221,147. PUB. 11-11-2008. FILED 7-3-2007.
- 3,566,668. **MISCELLANEOUS DESIGN**. HABERSHAM METAL PRODUCTS COMPANY, MULTIPLE CLASS, (INT. CLS. 6, 11 AND 20), (U.S. CLS. 2, 12, 13, 14, 21, 22, 23, 25, 31, 32, 34 AND 50). SN 77-346,408. PUB. 11-11-2008. FILED 12-7-2007.
- 3,566,861. **PERFECT MOUNT (BLOCK FORM)**. PEERLESS INDUSTRIES, INC., (U.S. CLS. 2, 12, 13, 14, 23, 25 AND 50). SN 77-445,332. PUB. 11-11-2008. FILED 4-10-2008.
- 3,566,977. **ALLOY 888 (BLOCK FORM)**. AMSTAR SURFACE TECHNOLOGY, LTD., (U.S. CLS. 2, 12, 13, 14, 23, 25 AND 50). SN 77-483,392. PUB. 11-11-2008. FILED 5-26-2008.
- 3,566,992. **TRI-BUSTER (BLOCK FORM)**. TRAFFIX DEVICES, INC., (U.S. CLS. 2, 12, 13, 14, 23, 25 AND 50). SN 77-485,586. PUB. 11-11-2008. FILED 5-28-2008.
- 3,567,108. **JOCKY BOX (BLOCK FORM)**. AIRWAY MACHINE COMPANY, INC., (U.S. CLS. 2, 12, 13, 14, 23, 25 AND 50). SN 77-496,219. PUB. 11-11-2008. FILED 6-11-2008.
- 3,567,144. **CONXTECH SPACE FRAME SYSTEMS AND DESIGN**. CONXTECH, INC., MULTIPLE CLASS, (INT. CLS. 6, 37 AND 40), (U.S. CLS. 2, 12, 13, 14, 23, 25, 50, 100, 103 AND 106). SN 77-497,416. PUB. 11-11-2008. FILED 6-12-2008.
- 3,567,635. **ORSOGRIL AND DESIGN**. ORSOGRIL S.P.A., (U.S. CLS. 2, 12, 13, 14, 23, 25 AND 50). SN 77-511,133. PUB. 11-11-2008. FILED 6-30-2008.
- 3,567,754. **CUSMART AND DESIGN**. HALCOR METAL WORKS S.A., (U.S. CLS. 2, 12, 13, 14, 23, 25 AND 50). SN 78-772,596. PUB. 4-3-2007. FILED 12-13-2005.
- 3,567,809. **TRM AND DESIGN**. TIROLER RÖHREN- UND METALLWERKE; AKTIENGESELLSCHAFT, MULTIPLE CLASS, (INT. CLS. 6 AND 7), (U.S. CLS. 2, 12, 13, 14, 19, 21, 23, 25, 31, 34, 35 AND 50). SN 79-030,257. PUB. 11-11-2008. FILED 9-18-2006.
- 3,567,820. **AUTEFA (STYLIZED)**. AUTEFA AUTOMATION GMBH, MULTIPLE CLASS, (INT. CLS. 6, 7 AND 42), (U.S. CLS. 2, 12, 13, 14, 19, 21, 23, 25, 31, 34, 35, 50, 100 AND 101). SN 79-035,022. PUB. 11-11-2008. FILED 1-31-2007.
- 3,567,851. **ILLUXO (BLOCK FORM)**. MEPLA-WERKE LAUTENSCHLÄGER GMBH & CO. KG, MULTIPLE CLASS, (INT. CLS. 6, 11 AND 20), (U.S. CLS. 2, 12, 13, 14, 21, 22, 23, 25, 31, 32, 34 AND 50). SN 79-043,664. PUB. 11-11-2008. FILED 4-27-2007.
- 3,567,854. **GOLDENISO (STYLIZED)**. MANULI RUBBER INDUSTRIES S.P.A., MULTIPLE CLASS, (INT. CLS. 6 AND 17), (U.S. CLS. 1, 2, 5, 12, 13, 14, 23, 25, 35 AND 50). SN 79-045,377. PUB. 11-11-2008. FILED 8-27-2007.
- 3,567,859. **GOLDENBLAST (STYLIZED)**. MANULI RUBBER INDUSTRIES S.P.A., MULTIPLE CLASS, (INT. CLS. 6 AND 17), (U.S. CLS. 1, 2, 5, 12, 13, 14, 23, 25, 35 AND 50). SN 79-045,642. PUB. 11-11-2008. FILED 9-26-2007.
- 3,567,861. **ECOAT M ENVIRONMENT FRIENDLY AND DESIGN**. MANULI RUBBER INDUSTRIES S.P.A., MULTIPLE CLASS, (INT. CLS. 6 AND 17), (U.S. CLS. 1, 2, 5, 12, 13, 14, 23, 25, 35 AND 50). SN 79-045,851. PUB. 11-11-2008. FILED 9-26-2007.
- 3,567,914. **B&M-TIGHT (BLOCK FORM)**. BAIER & MICHELS GMBH & CO. KG, MULTIPLE CLASS, (INT. CLS. 6 AND 20), (U.S. CLS. 2, 12, 13, 14, 22, 23, 25, 32 AND 50). SN 79-049,982. PUB. 11-11-2008. FILED 10-24-2007.
- 3,567,933 (See Class 1 for this trademark).
- 3,567,934 (See Class 1 for this trademark).
- 3,567,935 (See Class 1 for this trademark).
- 3,567,936 (See Class 1 for this trademark).

CLASS 7—MACHINERY

- 3,566,258. **ALLIANCE AND DESIGN**. DAIMLER TRUCKS NORTH AMERICA LLC, (U.S. CLS. 13, 19, 21, 23, 31, 34 AND 35). SN 76-430,525. PUB. 11-11-2008. FILED 7-15-2002.
- 3,566,276. **4B (BLOCK FORM)**. 4B ELEVATOR COMPONENTS, LTD., MULTIPLE CLASS, (INT. CLS. 7 AND 9), (U.S. CLS. 13, 19, 21, 23, 26, 31, 34, 35, 36 AND 38). SN 76-675,571. PUB. 11-11-2008. FILED 4-16-2007.
- 3,566,325. **CARPET MAX DH409 AND DESIGN**. KLUCZNIK, JOHN H., DBA BONNET PRO, (U.S. CLS. 13, 19, 21, 23, 31, 34 AND 35). SN 76-688,249. PUB. 11-11-2008. FILED 3-31-2008.
- 3,566,351. **ORANGE IRON (BLOCK FORM)**. SAFETY PRODUCTS ENGINEERING GROUP, INC., (U.S. CLS. 13, 19, 21, 23, 31, 34 AND 35). SN 76-690,672. PUB. 11-11-2008. FILED 6-19-2008.
- 3,566,400. **ST ANDREWS LINKS (BLOCK FORM)**. ST ANDREWS LINKS LIMITED, MULTIPLE CLASS, (INT. CLS. 7, 37, 42 AND 44), (U.S. CLS. 13, 19, 21, 23, 31, 34, 35, 100, 101, 103 AND 106). SN 77-073,801. PUB. 11-11-2008. FILED 12-30-2006.
- 3,566,421. **AMAZOY POWER AUGER (BLOCK FORM)**. THE SHELburne COMPANY, (U.S. CLS. 13, 19, 21, 23, 31, 34 AND 35). SN 77-102,910. PUB. 11-11-2008. FILED 2-8-2007.
- 3,566,435. **UPLIFTING EXPERIENCE (BLOCK FORM)**. TURBOMECA, MULTIPLE CLASS, (INT. CLS. 7, 12, 37 AND 42), (U.S. CLS. 13, 19, 21, 23, 31, 34, 35, 44, 100, 101, 103 AND 106). SN 77-132,909. PUB. 8-5-2008. FILED 3-16-2007.
- 3,566,451. **HAMMEROCK (BLOCK FORM)**. HAMMEROCK EQUIPMENT INC., (U.S. CLS. 13, 19, 21, 23, 31, 34 AND 35). SN 77-155,537. PUB. 11-11-2008. FILED 4-12-2007.
- 3,566,497. **QD (BLOCK FORM)**. DIETRICH DAVID WAYNE, (U.S. CLS. 13, 19, 21, 23, 31, 34 AND 35). SN 77-222,282. PUB. 9-9-2008. FILED 7-5-2007.
- 3,566,506. **AIR-EZE (BLOCK FORM)**. AIR-EZE LTD., (U.S. CLS. 13, 19, 21, 23, 31, 34 AND 35). SN 77-228,288. PUB. 11-11-2008. FILED 7-12-2007.
- 3,566,536. **PENTEK (BLOCK FORM)**. PENTAIR PUMP GROUP, INC., MULTIPLE CLASS, (INT. CLS. 7 AND 9), (U.S. CLS. 13, 19, 21, 23, 26, 31, 34, 35, 36 AND 38). SN 77-267,341. PUB. 11-11-2008. FILED 8-29-2007.
- 3,566,569. **WIND MONKEY (BLOCK FORM)**. KOMODO ENTERPRISES, INC., MULTIPLE CLASS, (INT. CLS. 7, 11, 37 AND 42), (U.S. CLS. 13, 19, 21, 23, 31, 34, 35, 100, 101, 103 AND 106). SN 77-306,526. PUB. 11-11-2008. FILED 10-17-2007.
- 3,566,588. **EUROCUTTER (STYLIZED)**. MZE MASCHINENBAU GMBH & CO. KG, (U.S. CLS. 13, 19, 21, 23, 31, 34 AND 35). SN 77-319,656. PUB. 11-11-2008. FILED 11-2-2007.
- 3,566,599. **CLEARANCE MASTER (BLOCK FORM)**. AMERICAN HANDLING SYSTEMS, INC., DBA POSITECH CORPORATION, (U.S. CLS. 13, 19, 21, 23, 31, 34 AND 35). SN 77-324,940. PUB. 11-11-2008. FILED 11-8-2007.
- 3,566,601. **WORLD MANIPULATOR (BLOCK FORM)**. AMERICAN HANDLING SYSTEMS, INC., DBA POSITECH CORPORATION, (U.S. CLS. 13, 19, 21, 23, 31, 34 AND 35). SN 77-325,134. PUB. 11-11-2008. FILED 11-8-2007.
- 3,566,608. **VACUP (BLOCK FORM)**. AMERICAN HANDLING SYSTEMS, INC., DBA POSITECH CORPORATION, (U.S. CLS. 13, 19, 21, 23, 31, 34 AND 35). SN 77-326,032. PUB. 11-11-2008. FILED 11-9-2007.
- 3,566,642. **POODLE BRUSH (BLOCK FORM)**. SONNY'S ENTERPRISES, INC., (U.S. CLS. 13, 19, 21, 23, 31, 34 AND 35). SN 77-338,840. PUB. 11-11-2008. FILED 11-28-2007.
- 3,566,751. **BLUE BRILLIANT AND DESIGN**. BSH BOSCH UND SIEMENS HAUSGERÄTE GMBH, (U.S. CLS. 13, 19, 21, 23, 31, 34 AND 35). SN 77-372,154. PUB. 11-11-2008. FILED 1-15-2008.
- 3,566,795. **FLEXISPIRAL (BLOCK FORM)**. GUILLE TOOLS & ENGINEERING CO., INC., (U.S. CLS. 13, 19, 21, 23, 31, 34 AND 35). SN 77-405,231. PUB. 11-11-2008. FILED S.R. 2-25-2008; AM. P.R. 6-11-2008.
- 3,566,829. **WHATEVER IT TAKES (BLOCK FORM)**. D & F EQUIPMENT SALES, INC., (U.S. CLS. 13, 19, 21, 23, 31, 34 AND 35). SN 77-426,578. PUB. 11-11-2008. FILED 3-19-2008.
- 3,566,984. **TYNNAN INDUSTRIAL (BLOCK FORM)**. D.R. INTELLECTUAL PROPERTIES, INC., (U.S. CLS. 13, 19, 21, 23, 31, 34 AND 35). SN 77-484,687. PUB. 11-11-2008.

FILED 5-28-2008.
 3,566,995. **QUICK ADJUST (BLOCK FORM)**. CLOYES GEAR AND PRODUCTS, INC., (U.S. CLS. 13, 19, 21, 23, 31, 34 AND 35). SN 77-486,252. PUB. 11-11-2008. FILED 5-29-2008.
 3,567,005. **490 PLUS (BLOCK FORM)**. EXCELSIOR BELTING-EQUIPMENT CO., INC., (U.S. CLS. 13, 19, 21, 23, 31, 34 AND 35). SN 77-487,302. PUB. 11-11-2008. FILED 5-30-2008.
 3,567,026. **C4 TECHNOLOGY (STYLIZED)**. SHINDAIWA, INC., (U.S. CLS. 13, 19, 21, 23, 31, 34 AND 35). SN 77-489,045. PUB. 11-11-2008. FILED 6-2-2008.
 3,567,028. **DOOR DEMON AND DESIGN**. THE ARNOLD COMPANY I, (U.S. CLS. 13, 19, 21, 23, 31, 34 AND 35). SN 77-489,468. PUB. 11-11-2008. FILED 6-3-2008.
 3,567,150. **SEA-LIFT (BLOCK FORM)**. KRAUSE MANUFACTURING, INC., (U.S. CLS. 13, 19, 21, 23, 31, 34 AND 35). SN 77-497,655. PUB. 11-11-2008. FILED 6-12-2008.
 3,567,194. **ULTIPACK (BLOCK FORM)**. B+ EQUIPMENT, (U.S. CLS. 13, 19, 21, 23, 31, 34 AND 35). SN 77-499,616. PUB. 11-11-2008. FILED 6-16-2008.
 3,567,339. **ECOBOT (BLOCK FORM)**. AQUATRON INC., (U.S. CLS. 13, 19, 21, 23, 31, 34 AND 35). SN 77-501,902. PUB. 11-11-2008. FILED 6-18-2008.
 3,567,464. **FLEXPALLETIZER (BLOCK FORM)**. CIM SYSTEMS INC., (U.S. CLS. 13, 19, 21, 23, 31, 34 AND 35). SN 77-504,111. PUB. 11-11-2008. FILED 6-20-2008.
 3,567,528. **PEMSERTER AND DESIGN**. PEM MANAGEMENT, INC., (U.S. CLS. 13, 19, 21, 23, 31, 34 AND 35). SN 77-505,432. PUB. 11-11-2008. FILED 6-23-2008.
 3,567,770. **MXT (BLOCK FORM)**. UNEX CORPORATION, (U.S. CLS. 13, 19, 21, 23, 31, 34 AND 35). SN 78-872,564. PUB. 11-11-2008. FILED 4-28-2006.
 3,567,807. **IMPACT INNOVATIVE MELT PRESSURE ACCURATE TRANSDUCER AND DESIGN**. GEFRAN S.P.A., MULTIPLE CLASS, (INT. CLS. 7, 9 AND 42), (U.S. CLS. 13, 19, 21, 23, 26, 31, 34, 35, 36, 38, 100 AND 101). SN 79-027,337. PUB. 11-11-2008. FILED 6-12-2006.
 3,567,809 (*See Class 6 for this trademark*).
 3,567,810. **CFS AQUARIUS LIFECYCLE PERFORMANCE AND DESIGN**. CFS HOLDINGS B.V., MULTIPLE CLASS, (INT. CLS. 7, 11, 16 AND 42), (U.S. CLS. 2, 5, 13, 19, 21, 22, 23, 29, 31, 34, 35, 37, 38, 50, 100 AND 101). SN 79-030,423. PUB. 11-11-2008. FILED 9-12-2006.
 3,567,820 (*See Class 6 for this trademark*).
 3,567,839. **CONVERTEAM THE POWER CONVERSION COMPANY AND DESIGN**. CONVERTEAM GROUP, MULTIPLE CLASS, (INT. CLS. 7, 9, 37 AND 42), (U.S. CLS. 13, 19, 21, 23, 26, 31, 34, 35, 36, 38, 100, 101, 103 AND 106). SN 79-040,965. PUB. 11-11-2008. FILED 12-1-2006.
 3,567,891. **KEYBOARD CHEMISTRY (BLOCK FORM)**. YMC CO., LTD., MULTIPLE CLASS, (INT. CLS. 7 AND 40), (U.S. CLS. 13, 19, 21, 23, 31, 34, 35, 100, 103 AND 106). SN 79-048,827. PUB. 11-11-2008. FILED 11-16-2007.
 3,567,911. **SIMU AND DESIGN**. SIMU, MULTIPLE CLASS, (INT. CLS. 7 AND 9), (U.S. CLS. 13, 19, 21, 23, 26, 31, 34, 35, 36 AND 38). SN 79-049,834. PUB. 11-11-2008. FILED 10-8-2007.
 3,567,925. **AITOS (BLOCK FORM)**. OYO ELECTRIC CO., LTD., MULTIPLE CLASS, (INT. CLS. 7 AND 9), (U.S. CLS. 13, 19, 21, 23, 26, 31, 34, 35, 36 AND 38). SN 79-050,414. PUB. 11-11-2008. FILED 1-31-2008.
 3,567,926. **MICROBAR (STYLIZED)**. METSO PAPER INC., MULTIPLE CLASS, (INT. CLS. 7 AND 37), (U.S. CLS. 13, 19, 21, 23, 31, 34, 35, 100, 103 AND 106). SN 79-050,450. PUB. 11-11-2008. FILED 12-20-2007.
 3,567,933 (*See Class 1 for this trademark*).
 3,567,934 (*See Class 1 for this trademark*).
 3,567,935 (*See Class 1 for this trademark*).
 3,567,936 (*See Class 1 for this trademark*).
 3,567,951. **VISTAFLEX (BLOCK FORM)**. WINDMÖLLER & HÖLSCHER, (U.S. CLS. 13, 19, 21, 23, 31, 34 AND 35). SN 79-053,026. PUB. 11-11-2008. FILED 3-14-2008.
 3,567,958. **HALLDE AND DESIGN**. AB HÄLLDE MASKINER, (U.S. CLS. 13, 19, 21, 23, 31, 34 AND 35). SN 79-053,523. PUB. 11-11-2008. FILED 12-21-2007.
 3,567,963. **RVS (BLOCK FORM)**. CHERVON (CHINA) TRADING CO., LTD., (U.S. CLS. 13, 19, 21, 23, 31, 34 AND 35). SN 79-054,576. PUB. 11-11-2008. FILED 4-24-2008.
 3,567,991. **DENSIGEAR (BLOCK FORM)**. M.G. MINI GEARS

S.P.A., MULTIPLE CLASS, (INT. CLS. 7 AND 12), (U.S. CLS. 13, 19, 21, 23, 31, 34, 35 AND 44). SN 79-058,019. PUB. 11-11-2008. FILED 10-29-2007.

CLASS 8—HAND TOOLS

3,566,423. **KÜSTER (BLOCK FORM)**. KUSTER LIMITED, MULTIPLE CLASS, (INT. CLS. 8, 10, 11 AND 20), (U.S. CLS. 2, 13, 21, 22, 23, 25, 26, 28, 31, 32, 34, 39, 44 AND 50). SN 77-114,623. PUB. 11-11-2008. FILED 2-23-2007.
 3,566,546. **LISTO (BLOCK FORM)**. LISTO PENCIL CORPORATION, MULTIPLE CLASS, (INT. CLS. 8 AND 16), (U.S. CLS. 2, 5, 22, 23, 28, 29, 37, 38, 44 AND 50). SN 77-281,702. PUB. 11-11-2008. FILED 9-17-2007.
 3,566,582. **HAIRWHISPER (BLOCK FORM)**. HAIRWHISPER INC., (U.S. CLS. 23, 28 AND 44). SN 77-316,503. PUB. 11-11-2008. FILED 10-30-2007.
 3,566,847. **MARCADY AND DESIGN**. MARCADY, INC., MULTIPLE CLASS, (INT. CLS. 8 AND 21), (U.S. CLS. 2, 13, 23, 28, 29, 30, 33, 40, 44 AND 50). SN 77-439,553. PUB. 11-11-2008. FILED 4-3-2008.
 3,566,903. **SNAPBAGGER (BLOCK FORM)**. SHE-EDISON, LLC, (U.S. CLS. 23, 28 AND 44). SN 77-462,777. PUB. 11-11-2008. FILED 5-1-2008.
 3,567,388. **SPEEDY EDGE (BLOCK FORM)**. ARTHUR LANSKY LEVINE & ASSOCIATES, INC., DBA LANSKY SHARPENERS, (U.S. CLS. 23, 28 AND 44). SN 77-502,634. PUB. 11-11-2008. FILED 6-19-2008.
 3,567,412. **MINI DOG BONE (BLOCK FORM)**. ARTHUR LANSKY LEVINE & ASSOCIATES, INC., DBA LANSKY SHARPENERS, (U.S. CLS. 23, 28 AND 44). SN 77-502,984. PUB. 11-11-2008. FILED 6-19-2008.
 3,567,415. **QUICK EDGE (BLOCK FORM)**. ARTHUR LANSKY LEVINE & ASSOCIATES, INC., DBA LANSKY SHARPENERS, (U.S. CLS. 23, 28 AND 44). SN 77-503,020. PUB. 11-11-2008. FILED 6-19-2008.
 3,567,418. **QUICK FIX (BLOCK FORM)**. ARTHUR LANSKY LEVINE & ASSOCIATES, INC., DBA LANSKY SHARPENERS, (U.S. CLS. 23, 28 AND 44). SN 77-503,041. PUB. 11-11-2008. FILED 6-19-2008.
 3,567,652. **THE PUCK (BLOCK FORM)**. ARTHUR LANSKY LEVINE & ASSOCIATES, INC., DBA LANSKY SHARPENERS, (U.S. CLS. 23, 28 AND 44). SN 77-516,915. PUB. 11-11-2008. FILED 7-8-2008.
 3,567,709. **EZ PULLER (BLOCK FORM)**. ANCRA INTERNATIONAL, LLC., (U.S. CLS. 23, 28 AND 44). SN 77-539,830. PUB. 11-11-2008. FILED 8-5-2008.
 3,567,710. **EZ PULLER II (BLOCK FORM)**. ANCRA INTERNATIONAL, LLC., (U.S. CLS. 23, 28 AND 44). SN 77-539,860. PUB. 11-11-2008. FILED 8-5-2008.
 3,567,749 (*See Class 2 for this trademark*).

CLASS 9—ELECTRICAL AND SCIENTIFIC APPARATUS

3,566,264. **ACCESS TO PEACE OF MIND (BLOCK FORM)**. MODERN ACCESS SYSTEMS INC., MULTIPLE CLASS, (INT. CLS. 9, 37, 40 AND 42), (U.S. CLS. 21, 23, 26, 36, 38, 100, 101, 103 AND 106). SN 76-595,030. PUB. 11-11-2008. FILED 6-2-2004.
 3,566,267. **BANDAI NAMCO AND DESIGN**. KABUSHIKI KAISHA BANDAI NAMCO HOLDINGS, TA NAMCO BANDAI HOLDINGS, INC., MULTIPLE CLASS, (INT. CLS. 9, 10, 11, 12, 16, 20, 21, 25, 28, 35, 41 AND 42), (U.S. CLS. 2, 5, 13, 19, 21, 22, 23, 25, 26, 29, 30, 31, 32, 33, 34, 35, 36, 37, 38, 39, 40, 44, 50, 100, 101, 102 AND 107). SN 76-652,320. PUB. 10-2-2007. FILED 12-22-2005.
 3,566,268. **NAMCOBANDAI (BLOCK FORM)**. KABUSHIKI KAISHA BANDAI NAMCO HOLDINGS, TA NAMCO BANDAI HOLDINGS, INC., MULTIPLE CLASS, (INT. CLS. 9, 10, 11, 12, 16, 20, 21, 25, 28, 35, 41 AND 42), (U.S. CLS. 2, 5, 13, 19, 21, 22, 23, 25, 26, 29, 30, 31, 32, 33, 34, 35, 36, 37, 38, 39, 40, 44, 50, 100, 101, 102 AND 107). SN 76-652,321.

- PUB. 10-2-2007. FILED 12-22-2005.
- 3,566,271. **FOOTSEE (BLOCK FORM)**. QINETIQ LIMITED, MULTIPLE CLASS, (INT. CLS. 9, 40 AND 44), (U.S. CLS. 21, 23, 26, 36, 38, 100, 101, 103 AND 106). SN 76-667,719. PUB. 11-11-2008. FILED 10-18-2006.
- 3,566,275. **MISCELLANEOUS DESIGN**. BOBCAD-CAM INCORPORATED, (U.S. CLS. 21, 23, 26, 36 AND 38). SN 76-674,961. PUB. 11-11-2008. FILED 4-3-2007.
- 3,566,276 (*See Class 7 for this trademark*).
- 3,566,279 (*See Class 1 for this trademark*).
- 3,566,291 (*See Class 3 for this trademark*).
- 3,566,298. **GTT AND DESIGN**. GLOBAL TRAFFIC TECHNOLOGIES, LLC, (U.S. CLS. 21, 23, 26, 36 AND 38). SN 76-684,211. PUB. 11-11-2008. FILED 11-19-2007.
- 3,566,306. **TP-CHECKER (STYLIZED)**. ORANGE ELECTRONIC CO., LTD., (U.S. CLS. 21, 23, 26, 36 AND 38). SN 76-685,461. PUB. 11-11-2008. FILED 1-2-2008.
- 3,566,308. **HIRAGINO (BLOCK FORM)**. DAINIPPON SCREEN MFG. CO., LTD., (U.S. CLS. 21, 23, 26, 36 AND 38). SN 76-685,829. PUB. 11-11-2008. FILED 1-16-2008.
- 3,566,334. **BITOS (BLOCK FORM)**. ZENE INC., (U.S. CLS. 21, 23, 26, 36 AND 38). SN 76-689,921. PUB. 11-11-2008. FILED 5-23-2008.
- 3,566,345. **SHOWER COACH (BLOCK FORM)**. NIAGARA CONSERVATION CORPORATION, (U.S. CLS. 21, 23, 26, 36 AND 38). SN 76-690,354. PUB. 11-11-2008. FILED 6-6-2008.
- 3,566,354. **ATL AND DESIGN**. AMPEREX TECHNOLOGY LIMITED CORPORATION, (U.S. CLS. 21, 23, 26, 36 AND 38). SN 76-690,699. PUB. 11-11-2008. FILED 6-20-2008.
- 3,566,357. **E.DEK (BLOCK FORM)**. SORENSON BIOSCIENCE, INC., (U.S. CLS. 21, 23, 26, 36 AND 38). SN 76-690,749. PUB. 11-11-2008. FILED 6-23-2008.
- 3,566,368. **RUSKINN (BLOCK FORM)**. RUSKINN LIFE SCIENCES LIMITED, MULTIPLE CLASS, (INT. CLS. 9, 10 AND 44), (U.S. CLS. 21, 23, 26, 36, 38, 39, 44, 100 AND 101). SN 77-005,667. PUB. 4-1-2008. FILED 9-22-2006.
- 3,566,371. **COBB (BLOCK FORM)**. COBB TUNING PRODUCTS, LLC, MULTIPLE CLASS, (INT. CLS. 9, 37, 40 AND 42), (U.S. CLS. 21, 23, 26, 36, 38, 100, 101, 103 AND 106). SN 77-017,114. PUB. 11-11-2008. FILED 10-9-2006.
- 3,566,384. **DRAGON MAGIC (BLOCK FORM)**. ARISTOCRAT TECHNOLOGIES AUSTRALIA PTY LTD, (U.S. CLS. 21, 23, 26, 36 AND 38). SN 77-046,899. PUB. 9-2-2008. FILED 11-17-2006.
- 3,566,388. **TEAM MAGNETICS AND DESIGN**. WECO WESTER EBBINGHAUS GMBH & CO. KG, (U.S. CLS. 21, 23, 26, 36 AND 38). SN 77-053,028. PUB. 8-12-2008. FILED 11-29-2006.
- 3,566,396. **DATALAB (BLOCK FORM)**. DETICA LIMITED, MULTIPLE CLASS, (INT. CLS. 9, 35, 37, 41 AND 42), (U.S. CLS. 21, 23, 26, 36, 38, 100, 101, 102, 103, 106 AND 107). SN 77-068,434. PUB. 7-22-2008. FILED 12-20-2006.
- 3,566,397. **DATALAB ACADEMY (BLOCK FORM)**. DETICA LIMITED, MULTIPLE CLASS, (INT. CLS. 9, 16 AND 41), (U.S. CLS. 2, 5, 21, 22, 23, 26, 29, 36, 37, 38, 50, 100, 101 AND 107). SN 77-068,453. PUB. 7-22-2008. FILED 12-20-2006.
- 3,566,401. **TMA AND DESIGN**. CAMBRIDGE DISPLAY TECHNOLOGY LIMITED, (U.S. CLS. 21, 23, 26, 36 AND 38). SN 77-075,244. PUB. 6-3-2008. FILED 1-3-2007.
- 3,566,402. **TMA (BLOCK FORM)**. CAMBRIDGE DISPLAY TECHNOLOGY LIMITED, (U.S. CLS. 21, 23, 26, 36 AND 38). SN 77-075,246. PUB. 6-3-2008. FILED 1-3-2007.
- 3,566,403 (*See Class 6 for this trademark*).
- 3,566,404. **FAILURE IS NOT AN OPTION (BLOCK FORM)**. TACTRONICS GROUP INTERNATIONAL, LLC, (U.S. CLS. 21, 23, 26, 36 AND 38). SN 77-078,930. PUB. 11-11-2008. FILED 1-9-2007.
- 3,566,406. **VIKING RICHES (BLOCK FORM)**. ARISTOCRAT TECHNOLOGIES AUSTRALIA PTY LTD, (U.S. CLS. 21, 23, 26, 36 AND 38). SN 77-080,380. PUB. 9-2-2008. FILED 1-10-2007.
- 3,566,408. **WCCTV (BLOCK FORM)**. CELLHIRE PLC, MULTIPLE CLASS, (INT. CLS. 9, 38 AND 41), (U.S. CLS. 21, 23, 26, 36, 38, 100, 101, 104 AND 107). SN 77-083,270. PUB. 11-11-2008. FILED 1-15-2007.
- 3,566,415. **RAYSPAN AND DESIGN**. RAYSPAN CORPORATION, (U.S. CLS. 21, 23, 26, 36 AND 38). SN 77-094,539. PUB. 11-11-2008. FILED 1-30-2007.
- 3,566,422. **RAPIDFORM AND DESIGN**. INUS TECHNOLOGY, INC., (U.S. CLS. 21, 23, 26, 36 AND 38). SN 77-109,516. PUB. 11-11-2008. FILED 2-16-2007.
- 3,566,438 (*See Class 2 for this trademark*).
- 3,566,439. **COMPUMAX AND DESIGN**. NAVAS, MAURICIO, (U.S. CLS. 21, 23, 26, 36 AND 38). SN 77-140,073. PUB. 11-11-2008. FILED 3-26-2007.
- 3,566,455. **MEMSCAP (BLOCK FORM)**. MEMSCAP, MULTIPLE CLASS, (INT. CLS. 9, 10, 41 AND 42), (U.S. CLS. 21, 23, 26, 36, 38, 39, 44, 100, 101 AND 107). SN 77-163,858. PUB. 11-11-2008. FILED 4-24-2007.
- 3,566,464. **FRANK & LOYAL (BLOCK FORM)**. CASSARA, FRANK, (U.S. CLS. 21, 23, 26, 36 AND 38). SN 77-183,566. PUB. 11-11-2008. FILED 5-17-2007.
- 3,566,466. **MARKETMESA (BLOCK FORM)**. ROSENDORF, CHARLES H., (U.S. CLS. 21, 23, 26, 36 AND 38). SN 77-184,806. PUB. 11-11-2008. FILED 5-18-2007.
- 3,566,500. **MEETING PEOPLE WHERE THEY ARE, HELPING THEM TAKE THE NEXT STEP (BLOCK FORM)**. WORLDWIDE DISCIPLESHIP ASSOCIATION, MULTIPLE CLASS, (INT. CLS. 9 AND 41), (U.S. CLS. 21, 23, 26, 36, 38, 100, 101 AND 107). SN 77-224,448. PUB. 11-11-2008. FILED 7-9-2007.
- 3,566,508 (*See Class 1 for this trademark*).
- 3,566,509. **ANCESTRY.COM AND DESIGN**. THE GENERATIONS NETWORK, INC., MULTIPLE CLASS, (INT. CLS. 9, 35 AND 42), (U.S. CLS. 21, 23, 26, 36, 38, 100, 101 AND 102). SN 77-235,261. PUB. 11-11-2008. FILED 7-20-2007.
- 3,566,514. **BTI SCAN (BLOCK FORM)**. BIOTECHNOLOGY INSTITUTE, S.L., (U.S. CLS. 21, 23, 26, 36 AND 38). SN 77-241,864. PUB. 11-11-2008. FILED 7-30-2007.
- 3,566,527. **GLASS-TRAC (BLOCK FORM)**. QUEST-TEC SOLUTIONS, INC., (U.S. CLS. 21, 23, 26, 36 AND 38). SN 77-261,669. PUB. 11-11-2008. FILED 8-22-2007.
- 3,566,528. **STEAM-TRAC (BLOCK FORM)**. QUEST-TEC SOLUTIONS, INC., (U.S. CLS. 21, 23, 26, 36 AND 38). SN 77-261,736. PUB. 11-11-2008. FILED 8-22-2007.
- 3,566,536 (*See Class 7 for this trademark*).
- 3,566,537. **MAGNE-TRAC (BLOCK FORM)**. QUEST-TEC SOLUTIONS, INC., (U.S. CLS. 21, 23, 26, 36 AND 38). SN 77-268,478. PUB. 11-11-2008. FILED 8-30-2007.
- 3,566,541. **SMARTALLY (BLOCK FORM)**. MICROWEST DESIGN LTD., (U.S. CLS. 21, 23, 26, 36 AND 38). SN 77-273,631. PUB. 8-5-2008. FILED 9-6-2007.
- 3,566,552. **WATCH SCALE (BLOCK FORM)**. JOSHUA KESSELMAN, (U.S. CLS. 21, 23, 26, 36 AND 38). SN 77-286,567. PUB. 11-11-2008. FILED 9-23-2007.
- 3,566,566. **CEE-LO (BLOCK FORM)**. CALLAWAY, THOMAS, MULTIPLE CLASS, (INT. CLS. 9 AND 41), (U.S. CLS. 21, 23, 26, 36, 38, 100, 101 AND 107). SN 77-302,877. PUB. 11-11-2008. FILED 10-12-2007.
- 3,566,600. **EXAMSAVER (BLOCK FORM)**. INTERACTIVE STUDY SYSTEMS, INC., MULTIPLE CLASS, (INT. CLS. 9 AND 41), (U.S. CLS. 21, 23, 26, 36, 38, 100, 101 AND 107). SN 77-324,955. PUB. 11-11-2008. FILED 11-8-2007.
- 3,566,617. **HEALTHZONE (BLOCK FORM)**. VIRGIN HEALTHMILES, INC., (U.S. CLS. 21, 23, 26, 36 AND 38). SN 77-328,622. PUB. 11-11-2008. FILED 11-13-2007.
- 3,566,623. **MASTERPLUS (STYLIZED)**. DYNAVET, MULTIPLE CLASS, (INT. CLS. 9 AND 18), (U.S. CLS. 1, 2, 3, 21, 22, 23, 26, 36, 38 AND 41). SN 77-331,720. PUB. 11-11-2008. FILED 11-16-2007.
- 3,566,639. **UNIVERSAL WELL SITE SOLUTIONS AND DESIGN**. UNIVERSAL CONSULTING & TECHNOLOGY INC., (U.S. CLS. 21, 23, 26, 36 AND 38). SN 77-338,616. PUB. 11-11-2008. FILED 11-28-2007.
- 3,566,643. **GINTECH (STYLIZED)**. GINTECH ENERGY CORPORATION, (U.S. CLS. 21, 23, 26, 36 AND 38). SN 77-338,916. PUB. 11-11-2008. FILED 11-28-2007.
- 3,566,655. **COLNAGO (BLOCK FORM)**. ARABESQUE S.R.L., MULTIPLE CLASS, (INT. CLS. 9, 12 AND 25), (U.S. CLS. 19, 21, 22, 23, 26, 31, 35, 36, 38, 39 AND 44). SN 77-342,516. PUB. 11-11-2008. FILED 12-3-2007.
- 3,566,690. **ANYBAND (BLOCK FORM)**. JANG, MAN JOON, (U.S. CLS. 21, 23, 26, 36 AND 38). SN 77-351,032. PUB. 11-11-2008. FILED 12-13-2007.
- 3,566,695. **T G I TRIANGLE GLOBAL INDUSTRIES AND DESIGN**. TRIANGLE GLOBAL INDUSTRIES, INC., (U.S. CLS. 21, 23, 26, 36 AND 38). SN 77-352,088. PUB. 11-11-2008.

- FILED 12-14-2007.
 3,566,709. **NO, BUT, IF (BLOCK FORM)**. EJ4 LLC, (U.S. CLS. 21, 23, 26, 36 AND 38). SN 77-356,140. PUB. 11-11-2008. FILED 12-19-2007.
- 3,566,719. **LINKYO (BLOCK FORM)**. LINKYO CORP., (U.S. CLS. 21, 23, 26, 36 AND 38). SN 77-359,504. PUB. 11-11-2008. FILED 12-26-2007.
- 3,566,727. **LIFELITE (BLOCK FORM)**. THWEATT, BARBARA ELLEN, DBA LIFELITE PRODUCTIONS, (U.S. CLS. 21, 23, 26, 36 AND 38). SN 77-362,160. PUB. 11-11-2008. FILED 12-31-2007.
- 3,566,734. **MISCELLANEOUS DESIGN**. LINKYO CORP., (U.S. CLS. 21, 23, 26, 36 AND 38). SN 77-363,834. PUB. 11-11-2008. FILED 1-3-2008.
- 3,566,749. **AVAIRA (BLOCK FORM)**. COOPERVISION, INC., (U.S. CLS. 21, 23, 26, 36 AND 38). SN 77-371,241. PUB. 11-11-2008. FILED 1-14-2008.
- 3,566,759. **ERMETMAX (BLOCK FORM)**. ERNI ELECTRONICS GMBH, MULTIPLE CLASS, (INT. CLS. 9 AND 17), (U.S. CLS. 1, 5, 12, 13, 21, 23, 26, 35, 36, 38 AND 50). SN 77-377,310. PUB. 9-16-2008. FILED 1-22-2008.
- 3,566,760. **B2BITS (BLOCK FORM)**. B2B ITS CORP., MULTIPLE CLASS, (INT. CLS. 9 AND 42), (U.S. CLS. 21, 23, 26, 36, 38, 100 AND 101). SN 77-378,664. PUB. 11-11-2008. FILED 1-23-2008.
- 3,566,773. **TAC COM (BLOCK FORM)**. THOMPSON, GEORGE J. PH.D. AND VERBAL JUDO INSTITUTE, INC., MULTIPLE CLASS, (INT. CLS. 9 AND 41), (U.S. CLS. 21, 23, 26, 36, 38, 100, 101 AND 107). SN 77-388,664. PUB. 11-11-2008. FILED 2-5-2008.
- 3,566,780. **A ALPHAVIEW LCD AND DESIGN**. QUEST INTERNATIONAL, INC., (U.S. CLS. 21, 23, 26, 36 AND 38). SN 77-394,237. PUB. 11-11-2008. FILED 2-11-2008.
- 3,566,791. **POWER DYNAMICS (BLOCK FORM)**. ST. CAMILLE, MARC, MULTIPLE CLASS, (INT. CLS. 9, 41, 44 AND 45), (U.S. CLS. 21, 23, 26, 36, 38, 100, 101 AND 107). SN 77-399,772. PUB. 11-11-2008. FILED 2-18-2008.
- 3,566,797. **SOUNDVIEW (BLOCK FORM)**. STARKEY LABORATORIES, INC., (U.S. CLS. 21, 23, 26, 36 AND 38). SN 77-407,005. PUB. 11-11-2008. FILED 2-27-2008.
- 3,566,806. **REAL-MENTOR (BLOCK FORM)**. REAL ESTATE BUSINESS SERVICES, INC., (U.S. CLS. 21, 23, 26, 36 AND 38). SN 77-410,521. PUB. 11-11-2008. FILED 3-1-2008.
- 3,566,814. **GRYPHON (BLOCK FORM)**. QUANTUM LEAP RESEARCH, INC., (U.S. CLS. 21, 23, 26, 36 AND 38). SN 77-416,540. PUB. 11-11-2008. FILED 3-7-2008.
- 3,566,838. **ENTERPRISEAXIS AND DESIGN**. STAFFME.NET, LLC., (U.S. CLS. 21, 23, 26, 36 AND 38). SN 77-432,096. PUB. 11-11-2008. FILED 3-26-2008.
- 3,566,849. **TIMBER GUIDE (BLOCK FORM)**. GENESIS INDUSTRIES, LLC, (U.S. CLS. 21, 23, 26, 36 AND 38). SN 77-439,924. PUB. 11-11-2008. FILED 4-4-2008.
- 3,566,853. **3E TECHNOLOGIES INTERNATIONAL (STYLIZED)**. 3E TECHNOLOGIES INTERNATIONAL, INC., (U.S. CLS. 21, 23, 26, 36 AND 38). SN 77-441,408. PUB. 11-11-2008. FILED 4-7-2008.
- 3,566,858. **AIRTRAFFIC CONTROL (BLOCK FORM)**. LANGSETH, KENT BRUCE, DBA JEVERSI SOFTWARE, (U.S. CLS. 21, 23, 26, 36 AND 38). SN 77-444,060. PUB. 11-11-2008. FILED 4-9-2008.
- 3,566,863. **SONGTIP (BLOCK FORM)**. MY SMART HOME, INC., (U.S. CLS. 21, 23, 26, 36 AND 38). SN 77-445,671. PUB. 11-11-2008. FILED 4-11-2008.
- 3,566,868. **SPIDER (BLOCK FORM)**. LINE 6, INC., (U.S. CLS. 21, 23, 26, 36 AND 38). SN 77-447,447. PUB. 11-11-2008. FILED 4-14-2008.
- 3,566,883. **SENSOR (BLOCK FORM)**. COATS ENGINEERING, INC., (U.S. CLS. 21, 23, 26, 36 AND 38). SN 77-452,901. PUB. 11-11-2008. FILED 4-20-2008.
- 3,566,887. **SWITCHEROO (BLOCK FORM)**. BOGGEAR LLC, (U.S. CLS. 21, 23, 26, 36 AND 38). SN 77-455,800. PUB. 11-11-2008. FILED 4-23-2008.
- 3,566,889. **COMPASS (BLOCK FORM)**. SCHWEITZER ENGINEERING LABORATORIES, INC., (U.S. CLS. 21, 23, 26, 36 AND 38). SN 77-456,321. PUB. 11-11-2008. FILED 4-23-2008.
- 3,566,891. **THE SYMPHONETTE SOCIETY LIVING SOUND AND DESIGN**. UNIDISC MUSIC INC., (U.S. CLS. 21, 23, 26, 36 AND 38). SN 77-456,797. PUB. 11-11-2008. FILED 4-24-2008.
- 3,566,920. **TPR TRAFFIC SOLUTIONS AND DESIGN**. TRENCH PLATE RENTAL CO., MULTIPLE CLASS, (INT. CLS. 9 AND 39), (U.S. CLS. 21, 23, 26, 36, 38, 100 AND 105). SN 77-469,244. PUB. 11-11-2008. FILED 5-8-2008.
- 3,566,930. **BLINC (BLOCK FORM)**. V-CAN SPORTS, INC., MULTIPLE CLASS, (INT. CLS. 9 AND 38), (U.S. CLS. 21, 23, 26, 36, 38, 100, 101 AND 104). SN 77-471,540. PUB. 11-11-2008. FILED 5-12-2008.
- 3,566,935. **MOBIMANAGE AND DESIGN**. MOBIMANAGE, LLC, MULTIPLE CLASS, (INT. CLS. 9 AND 42), (U.S. CLS. 21, 23, 26, 36, 38, 100 AND 101). SN 77-474,266. PUB. 11-11-2008. FILED 5-14-2008.
- 3,566,947. **ENSEMBLE VIDEO (BLOCK FORM)**. SYMPHONY VIDEO, INC., (U.S. CLS. 21, 23, 26, 36 AND 38). SN 77-476,977. PUB. 11-11-2008. FILED 5-16-2008.
- 3,566,969. **LOT CONNECT (BLOCK FORM)**. GEM-CAP, INC., DBA DBS HAYES SOFTWARE SYSTEMS, (U.S. CLS. 21, 23, 26, 36 AND 38). SN 77-482,742. PUB. 11-11-2008. FILED 5-23-2008.
- 3,566,973. **BALD EAGLE (BLOCK FORM)**. NARDY, JUSTIN, MULTIPLE CLASS, (INT. CLS. 9 AND 41), (U.S. CLS. 21, 23, 26, 36, 38, 100, 101 AND 107). SN 77-483,232. PUB. 11-11-2008. FILED 5-25-2008.
- 3,566,985. **R:BASE (BLOCK FORM)**. R:BASE TECHNOLOGIES, INC., (U.S. CLS. 21, 23, 26, 36 AND 38). SN 77-484,934. PUB. 11-11-2008. FILED 5-28-2008.
- 3,566,986. **PUZZLE PIRATES (BLOCK FORM)**. THREE RINGS DESIGN, INC., (U.S. CLS. 21, 23, 26, 36 AND 38). SN 77-485,043. PUB. 11-11-2008. FILED 5-28-2008.
- 3,567,001. **DEMIURGE STUDIOS AND DESIGN**. DEMIURGE STUDIOS, INC., MULTIPLE CLASS, (INT. CLS. 9 AND 41), (U.S. CLS. 21, 23, 26, 36, 38, 100, 101 AND 107). SN 77-486,764. PUB. 11-11-2008. FILED 5-29-2008.
- 3,567,007. **YOU'VE GOT THE TIME (BLOCK FORM)**. HOSANNA, MULTIPLE CLASS, (INT. CLS. 9 AND 41), (U.S. CLS. 21, 23, 26, 36, 38, 100, 101 AND 107). SN 77-487,398. PUB. 11-11-2008. FILED 5-30-2008.
- 3,567,009. **TECHNOLOGY FOR HIGH PERFORMANCE PEOPLE (BLOCK FORM)**. FALCON TECHNOLOGY SYSTEMS LTD, DBA WINDRIDER TECHNOLOGY, INC., (U.S. CLS. 21, 23, 26, 36 AND 38). SN 77-487,454. PUB. 11-11-2008. FILED 5-30-2008.
- 3,567,011. **CTD AND DESIGN**. CDT AUDIO, INC., (U.S. CLS. 21, 23, 26, 36 AND 38). SN 77-487,679. PUB. 11-11-2008. FILED 5-30-2008.
- 3,567,012. **PHONEGUYS (BLOCK FORM)**. PHONEGUYS VOICE & DATA SYSTEMS, INC., DBA PHONE GUYS, (U.S. CLS. 21, 23, 26, 36 AND 38). SN 77-487,855. PUB. 11-11-2008. FILED 5-30-2008.
- 3,567,029. **OTERRO (BLOCK FORM)**. R:BASE TECHNOLOGIES, INC., (U.S. CLS. 21, 23, 26, 36 AND 38). SN 77-489,863. PUB. 11-11-2008. FILED 6-3-2008.
- 3,567,066. **TECHIE TRENDS (BLOCK FORM)**. TECHIE TRENDS, LLC, (U.S. CLS. 21, 23, 26, 36 AND 38). SN 77-493,036. PUB. 11-11-2008. FILED 6-6-2008.
- 3,567,089. **SAT (BLOCK FORM)**. COLLEGE ENTRANCE EXAMINATION BOARD, DBA THE COLLEGE BOARD, MULTIPLE CLASS, (INT. CLS. 9 AND 41), (U.S. CLS. 21, 23, 26, 36, 38, 100, 101 AND 107). SN 77-494,564. PUB. 11-11-2008. FILED 6-9-2008.
- 3,567,101. **RECONINSIGHT™BI (BLOCK FORM)**. RECONINSIGHT, LTD, (U.S. CLS. 21, 23, 26, 36 AND 38). SN 77-495,250. PUB. 11-11-2008. FILED 6-10-2008.
- 3,567,102. **SECURED BY MAC (BLOCK FORM)**. MODULAR SECURITY SYSTEMS, INC., (U.S. CLS. 21, 23, 26, 36 AND 38). SN 77-495,378. PUB. 11-11-2008. FILED 6-10-2008.
- 3,567,125. **YELLOWSTAR TECHNOLOGIES (BLOCK FORM)**. YELLOWSTAR TECHNOLOGY, LLC, (U.S. CLS. 21, 23, 26, 36 AND 38). SN 77-496,708. PUB. 11-11-2008. FILED 6-11-2008.
- 3,567,152. **SMARTMOTION (BLOCK FORM)**. PROTECH THEATRICAL SERVICES, (U.S. CLS. 21, 23, 26, 36 AND 38). SN 77-497,854. PUB. 11-11-2008. FILED 6-12-2008.
- 3,567,154. **THE KINGS OF CAZ (BLOCK FORM)**. THE KINGS OF CAZ, (U.S. CLS. 21, 23, 26, 36 AND 38). SN 77-497,962. PUB. 11-11-2008. FILED 6-12-2008.

- 3,567,172. **RED BRICK (BLOCK FORM)**. RED.COM, INC., (U.S. CLS. 21, 23, 26, 36 AND 38). SN 77-498,605. PUB. 11-11-2008. FILED 6-13-2008.
- 3,567,206. **CIELO Y TIERRA (BLOCK FORM)**. EARTHSKY COMMUNICATIONS, INC., DBA BYRD AND BLOCK COMMUNICATIONS, INC., MULTIPLE CLASS, (INT. CLS. 9 AND 41), (U.S. CLS. 21, 23, 26, 36, 38, 100, 101 AND 107). SN 77-499,835. PUB. 11-11-2008. FILED 6-16-2008.
- 3,567,216. **TIME GYM (BLOCK FORM)**. CRENSHAW, DAVID M., MULTIPLE CLASS, (INT. CLS. 9, 35 AND 41), (U.S. CLS. 21, 23, 26, 36, 38, 100, 101, 102 AND 107). SN 77-499,951. PUB. 11-11-2008. FILED 6-16-2008.
- 3,567,233. **HELDO (BLOCK FORM)**. MICREL, INCORPORATED, (U.S. CLS. 21, 23, 26, 36 AND 38). SN 77-500,332. PUB. 11-11-2008. FILED 6-16-2008.
- 3,567,249. **ASTERISK (BLOCK FORM)**. DIGIUM, INC., MULTIPLE CLASS, (INT. CLS. 9 AND 42), (U.S. CLS. 21, 23, 26, 36, 38, 100 AND 101). SN 77-500,656. PUB. 11-11-2008. FILED 6-17-2008.
- 3,567,251. **KALO (BLOCK FORM)**. MAGNETICS USA, INC., (U.S. CLS. 21, 23, 26, 36 AND 38). SN 77-500,670. PUB. 11-11-2008. FILED 6-17-2008.
- 3,567,256. **MGANTT (BLOCK FORM)**. MÉTIER, LTD., (U.S. CLS. 21, 23, 26, 36 AND 38). SN 77-500,737. PUB. 11-11-2008. FILED 6-17-2008.
- 3,567,266. **DYNAMIC TMN (BLOCK FORM)**. MONFOX LLC, (U.S. CLS. 21, 23, 26, 36 AND 38). SN 77-500,840. PUB. 11-11-2008. FILED 6-17-2008.
- 3,567,273. **PORTACAST (BLOCK FORM)**. MOBILE STUDIOS, INC., (U.S. CLS. 21, 23, 26, 36 AND 38). SN 77-500,931. PUB. 11-11-2008. FILED 6-17-2008.
- 3,567,289. **NEXGEN AND DESIGN**. AZTECH SOFTWARE, INC., (U.S. CLS. 21, 23, 26, 36 AND 38). SN 77-501,221. PUB. 11-11-2008. FILED 6-17-2008.
- 3,567,293. **TVM AND DESIGN**. TAIWAN VIDEO & MONITOR CORP., (U.S. CLS. 21, 23, 26, 36 AND 38). SN 77-501,273. PUB. 11-11-2008. FILED 6-17-2008.
- 3,567,296. **BRAVE NEW GIRLS (BLOCK FORM)**. BRAVE NEW GIRLS LIMITED, LLC, (U.S. CLS. 21, 23, 26, 36 AND 38). SN 77-501,280. PUB. 11-11-2008. FILED 6-17-2008.
- 3,567,307. **CLERICUS AND DESIGN**. FACC SERVICES GROUP, LLC, (U.S. CLS. 21, 23, 26, 36 AND 38). SN 77-501,417. PUB. 11-11-2008. FILED 6-18-2008.
- 3,567,334. **MY MOBILE WATCHDOG (BLOCK FORM)**. E-AGENCY, INC., MULTIPLE CLASS, (INT. CLS. 9 AND 45), (U.S. CLS. 21, 23, 26, 36, 38, 100 AND 101). SN 77-501,857. PUB. 11-11-2008. FILED 6-18-2008.
- 3,567,338. **TESTPOWER (BLOCK FORM)**. RALLY! EDUCATION, MULTIPLE CLASS, (INT. CLS. 9, 16 AND 41), (U.S. CLS. 2, 5, 21, 22, 23, 26, 29, 36, 37, 38, 50, 100, 101 AND 107). SN 77-501,893. PUB. 11-11-2008. FILED 6-18-2008.
- 3,567,356. **TRUNGUARD (BLOCK FORM)**. MOORE INDUSTRIES-INTERNATIONAL, INC., (U.S. CLS. 21, 23, 26, 36 AND 38). SN 77-502,132. PUB. 11-11-2008. FILED 6-18-2008.
- 3,567,359. **TRUNKSAFE (BLOCK FORM)**. MOORE INDUSTRIES-INTERNATIONAL, INC., (U.S. CLS. 21, 23, 26, 36 AND 38). SN 77-502,158. PUB. 11-11-2008. FILED 6-18-2008.
- 3,567,360. **MAKO (BLOCK FORM)**. KYOCERA WIRELESS CORP., (U.S. CLS. 21, 23, 26, 36 AND 38). SN 77-502,191. PUB. 11-11-2008. FILED 6-18-2008.
- 3,567,376. **LIL' ROMEO (BLOCK FORM)**. MILLER, PERCY, (U.S. CLS. 21, 23, 26, 36 AND 38). SN 77-502,428. PUB. 11-11-2008. FILED 6-18-2008.
- 3,567,377. **ROMEO (BLOCK FORM)**. MILLER, PERCY, (U.S. CLS. 21, 23, 26, 36 AND 38). SN 77-502,430. PUB. 11-11-2008. FILED 6-18-2008.
- 3,567,386. **ALLTANK AND DESIGN**. MID-TOWN PETROLEUM INC., (U.S. CLS. 21, 23, 26, 36 AND 38). SN 77-502,613. PUB. 11-11-2008. FILED 6-19-2008.
- 3,567,409. **PORT CITY (BLOCK FORM)**. PORT CITY AMPLIFICATION, (U.S. CLS. 21, 23, 26, 36 AND 38). SN 77-502,970. PUB. 11-11-2008. FILED 6-19-2008.
- 3,567,411. **MISCELLANEOUS DESIGN**. PORT CITY AMPLIFICATION, (U.S. CLS. 21, 23, 26, 36 AND 38). SN 77-502,972. PUB. 11-11-2008. FILED 6-19-2008.
- 3,567,419. **SNTRYML (STYLIZED)**. QSTAR TECHNOLOGIES, INC., (U.S. CLS. 21, 23, 26, 36 AND 38). SN 77-503,052. PUB. 11-11-2008. FILED 6-19-2008.
- 3,567,430. **ICAST (BLOCK FORM)**. KSC INDUSTRIES INCORPORATED, (U.S. CLS. 21, 23, 26, 36 AND 38). SN 77-503,356. PUB. 11-11-2008. FILED 6-19-2008.
- 3,567,432. **SOUNDCAST (BLOCK FORM)**. KSC INDUSTRIES INCORPORATED, (U.S. CLS. 21, 23, 26, 36 AND 38). SN 77-503,371. PUB. 11-11-2008. FILED 6-19-2008.
- 3,567,441. **CENTERPAD (BLOCK FORM)**. DISPLAYWARE LLC, (U.S. CLS. 21, 23, 26, 36 AND 38). SN 77-503,521. PUB. 11-11-2008. FILED 6-19-2008.
- 3,567,442. **PREVIEWPAD (BLOCK FORM)**. DISPLAYWARE LLC, (U.S. CLS. 21, 23, 26, 36 AND 38). SN 77-503,523. PUB. 11-11-2008. FILED 6-19-2008.
- 3,567,448. **M AND DESIGN**. SOLI MIZRAHI, AND ELI MIZRAHI, (U.S. CLS. 21, 23, 26, 36 AND 38). SN 77-503,647. PUB. 11-11-2008. FILED 6-19-2008.
- 3,567,472. **EXCHANGE FOR CHANGE (BLOCK FORM)**. RISKE, MARTIN J. DBA MJR HOLDINGS, LLLP, (U.S. CLS. 21, 23, 26, 36 AND 38). SN 77-504,274. PUB. 11-11-2008. FILED 6-20-2008.
- 3,567,493. **CYCLOPS (BLOCK FORM)**. SJOMAN BJORN CORPORATION, (U.S. CLS. 21, 23, 26, 36 AND 38). SN 77-504,804. PUB. 11-11-2008. FILED 6-21-2008.
- 3,567,496. **WEINTEK AND DESIGN**. WEINTEK LABS., INC., (U.S. CLS. 21, 23, 26, 36 AND 38). SN 77-504,835. PUB. 11-11-2008. FILED 6-21-2008.
- 3,567,503. **IKLAP (BLOCK FORM)**. ARCOSOFT INC., (U.S. CLS. 21, 23, 26, 36 AND 38). SN 77-504,892. PUB. 11-11-2008. FILED 6-21-2008.
- 3,567,516. **BREAST SCULPTOR (BLOCK FORM)**. CANFIELD SCIENTIFIC, INC., (U.S. CLS. 21, 23, 26, 36 AND 38). SN 77-505,283. PUB. 11-11-2008. FILED 6-23-2008.
- 3,567,517. **MAPTRAX (BLOCK FORM)**. UNIDEN AMERICA CORPORATION, (U.S. CLS. 21, 23, 26, 36 AND 38). SN 77-505,291. PUB. 11-11-2008. FILED 6-23-2008.
- 3,567,537. **COOLPAM (BLOCK FORM)**. AVAGO TECHNOLOGIES GENERAL IP (SINGAPORE) PTE. LTD., (U.S. CLS. 21, 23, 26, 36 AND 38). SN 77-505,649. PUB. 11-11-2008. FILED 6-23-2008.
- 3,567,552. **OUT IN FRONT (BLOCK FORM)**. SIGNCO, MULTIPLE CLASS, (INT. CLS. 9, 19 AND 40), (U.S. CLS. 1, 12, 21, 23, 26, 33, 36, 38, 50, 100, 103 AND 106). SN 77-505,905. PUB. 11-11-2008. FILED 6-23-2008.
- 3,567,553. **NANNY CADDY (BLOCK FORM)**. NANNY CADDY LLC, (U.S. CLS. 21, 23, 26, 36 AND 38). SN 77-505,941. PUB. 11-11-2008. FILED 6-23-2008.
- 3,567,559. **PLASEC (BLOCK FORM)**. PLASEC, INC., (U.S. CLS. 21, 23, 26, 36 AND 38). SN 77-506,120. PUB. 11-11-2008. FILED 6-24-2008.
- 3,567,578. **SHARE IN THE MAGIC OF STORYTIME (BLOCK FORM)**. OMNISCENT CORP., (U.S. CLS. 21, 23, 26, 36 AND 38). SN 77-506,715. PUB. 11-11-2008. FILED 6-24-2008.
- 3,567,610. **STIXSERVER (BLOCK FORM)**. POSTSENTRY, LLC., (U.S. CLS. 21, 23, 26, 36 AND 38). SN 77-507,258. PUB. 11-11-2008. FILED 6-24-2008.
- 3,567,614. **ANXO A AND DESIGN**. URBAN BODY ARMOR, CORP., (U.S. CLS. 21, 23, 26, 36 AND 38). SN 77-507,370. PUB. 11-11-2008. FILED 6-25-2008.
- 3,567,639. **DYNASTY WARRIORS (BLOCK FORM)**. KOEI CO., LTD., (U.S. CLS. 21, 23, 26, 36 AND 38). SN 77-511,614. PUB. 11-11-2008. FILED 6-30-2008.
- 3,567,648. **NEXPAK (BLOCK FORM)**. NEXPAK CORPORATION, (U.S. CLS. 21, 23, 26, 36 AND 38). SN 77-514,857. PUB. 11-11-2008. FILED 7-3-2008.
- 3,567,657. **ZDOTS! (BLOCK FORM)**. ZILOG, INC., (U.S. CLS. 21, 23, 26, 36 AND 38). SN 77-518,553. PUB. 11-11-2008. FILED 7-10-2008.
- 3,567,667. **AOPA'S AIRPORT WATCH AND DESIGN**. AIRCRAFT OWNERS AND PILOTS ASSOCIATION, MULTIPLE CLASS, (INT. CLS. 9 AND 16), (U.S. CLS. 2, 5, 21, 22, 23, 26, 29, 36, 37, 38 AND 50). SN 77-520,047. PUB. 11-11-2008. FILED 7-11-2008.
- 3,567,668. **AIRPORT WATCH (BLOCK FORM)**. AIRCRAFT OWNERS AND PILOTS ASSOCIATION, MULTIPLE CLASS, (INT. CLS. 9 AND 16), (U.S. CLS. 2, 5, 21, 22, 23, 26, 29, 36, 37, 38 AND 50). SN 77-520,058. PUB. 11-11-2008. FILED 7-11-2008.
- 3,567,672. **SOOTHE-GUARD AIR (BLOCK FORM)**. DENTSPPLY INTERNATIONAL INC., (U.S. CLS. 21, 23, 26, 36 AND

- 38). SN 77-522,131. PUB. 11-11-2008. FILED 7-15-2008.
- 3,567,673. **AIRPORT WATCH (STYLIZED)**. AIRCRAFT OWNERS AND PILOTS ASSOCIATION, (U.S. CLS. 21, 23, 26, 36 AND 38). SN 77-522,420. PUB. 11-11-2008. FILED 7-15-2008.
- 3,567,682. **SNTRYVTL AND DESIGN**. QSTAR TECHNOLOGIES, INC., (U.S. CLS. 21, 23, 26, 36 AND 38). SN 77-524,946. PUB. 11-11-2008. FILED 7-17-2008.
- 3,567,700. **SPACEWALK (BLOCK FORM)**. RED HAT, INC., (U.S. CLS. 21, 23, 26, 36 AND 38). SN 77-536,708. PUB. 11-11-2008. FILED 8-1-2008.
- 3,567,707. **LA CLARA VOZ DE LA CIENCIA (BLOCK FORM)**. EARTHSKY COMMUNICATIONS, INC., DBA BYRD AND BLOCK COMMUNICATIONS, INC., MULTIPLE CLASS, (INT. CLS. 9 AND 41), (U.S. CLS. 21, 23, 26, 36, 38, 100, 101 AND 107). SN 77-539,329. PUB. 11-11-2008. FILED 8-5-2008.
- 3,567,725. **CAE LITHOS**. CAE INC., MULTIPLE CLASS, (INT. CLS. 9 AND 42), (U.S. CLS. 21, 23, 26, 36, 38, 100 AND 101). SN 78-156,963. PUB. 11-11-2008. FILED 8-22-2002.
- 3,567,730. **MACRONIX NBIT (BLOCK FORM)**. MACRONIX INTERNATIONAL CO., LTD., MULTIPLE CLASS, (INT. CLS. 9, 40 AND 42), (U.S. CLS. 21, 23, 26, 36, 38, 100, 101, 103 AND 106). SN 78-407,365. PUB. 11-11-2008. FILED 4-23-2004.
- 3,567,733. **PURELAUNCH BY ZELOCITY AND DESIGN**. INNOVATIVE GOLF CORPORATION, (U.S. CLS. 21, 23, 26, 36 AND 38). SN 78-461,733. PUB. 11-11-2008. FILED 8-4-2004.
- 3,567,734. **PUREFLIGHT BY ZELOCITY AND DESIGN**. INNOVATIVE GOLF CORPORATION, (U.S. CLS. 21, 23, 26, 36 AND 38). SN 78-461,745. PUB. 11-11-2008. FILED 8-4-2004.
- 3,567,737. **HOTSPOT (BLOCK FORM)**. ISO CLAIMS SERVICES, INC., (U.S. CLS. 21, 23, 26, 36 AND 38). SN 78-515,769. PUB. 11-11-2008. FILED 11-12-2004.
- 3,567,742. **DME (STYLIZED)**. ETIIP HOLDINGS INC., MULTIPLE CLASS, (INT. CLS. 9, 38 AND 42), (U.S. CLS. 21, 23, 26, 36, 38, 100, 101 AND 104). SN 78-613,253. PUB. 11-11-2008. FILED 4-20-2005.
- 3,567,745. **TELCEL AND DESIGN**. ADMINISTRADORA DE MARCAS RD, S. DE R.L. DE C.V., MULTIPLE CLASS, (INT. CLS. 9, 16, 25, 35, 38 AND 41), (U.S. CLS. 2, 5, 21, 22, 23, 26, 29, 36, 37, 38, 39, 50, 100, 101, 102, 104 AND 107). SN 78-648,374. PUB. 11-11-2008. FILED 6-10-2005.
- 3,567,749 (*See Class 2 for this trademark*).
- 3,567,760. **ONE SCM (BLOCK FORM)**. TAKE SOLUTIONS, INC., (U.S. CLS. 21, 23, 26, 36 AND 38). SN 78-781,294. PUB. 12-4-2007. FILED 12-27-2005.
- 3,567,763 (*See Class 1 for this trademark*).
- 3,567,769. **OUT OF SIGHT FENCING (BLOCK FORM)**. SUNWARD ELECTRONICS, INC., (U.S. CLS. 21, 23, 26, 36 AND 38). SN 78-867,834. PUB. 11-11-2008. FILED 4-24-2006.
- 3,567,771. **VEO (BLOCK FORM)**. PRONEXUS INC., (U.S. CLS. 21, 23, 26, 36 AND 38). SN 78-876,827. PUB. 4-15-2008. FILED 5-4-2006.
- 3,567,793. **VERTERA (BLOCK FORM)**. DE LA RUE SYSTEMS GMBH, (U.S. CLS. 21, 23, 26, 36 AND 38). SN 78-972,756. PUB. 4-8-2008. FILED 9-12-2006.
- 3,567,796. **PUNKYFISH (BLOCK FORM)**. DEVILS AND ANGELS LIMITED, MULTIPLE CLASS, (INT. CLS. 9 AND 14), (U.S. CLS. 2, 21, 23, 26, 27, 28, 36, 38 AND 50). SN 78-980,753. PUB. 3-11-2008. FILED 6-17-2005.
- 3,567,797 (*See Class 1 for this trademark*).
- 3,567,802 (*See Class 1 for this trademark*).
- 3,567,806. **WATSGET AND DESIGN**. HOLLARD HERVE, MULTIPLE CLASS, (INT. CLS. 9 AND 25), (U.S. CLS. 21, 22, 23, 26, 36, 38 AND 39). SN 79-026,552. PUB. 11-11-2008. FILED 6-13-2006.
- 3,567,807 (*See Class 7 for this trademark*).
- 3,567,812. **AXBO (STYLIZED)**. INFACTORY INNOVATIONS & TRADE GMBH, MULTIPLE CLASS, (INT. CLS. 9 AND 14), (U.S. CLS. 2, 21, 23, 26, 27, 28, 36, 38 AND 50). SN 79-030,615. PUB. 11-11-2008. FILED 8-17-2006.
- 3,567,814 (*See Class 1 for this trademark*).
- 3,567,815. **MONIKKER (BLOCK FORM)**. MONIKKER PTY LTD, MULTIPLE CLASS, (INT. CLS. 9, 38 AND 41), (U.S. CLS. 21, 23, 26, 36, 38, 100, 101, 104 AND 107). SN 79-033,015. PUB. 11-11-2008. FILED 10-3-2006.
- 3,567,816. **PLEIADES (BLOCK FORM)**. CENTRE NATIONAL D'ÉTUDES SPATIALES, MULTIPLE CLASS, (INT. CLS. 9, 12, 38 AND 42), (U.S. CLS. 19, 21, 23, 26, 31, 35, 36, 38, 44, 100, 101 AND 104). SN 79-033,676. PUB. 11-11-2008. FILED 8-3-2006.
- 3,567,818. **VERTIGUARD (BLOCK FORM)**. PROF. ARNEBORG ERNST, MULTIPLE CLASS, (INT. CLS. 9, 10 AND 44), (U.S. CLS. 21, 23, 26, 36, 38, 39, 44, 100 AND 101). SN 79-034,308. PUB. 11-11-2008. FILED 6-28-2006.
- 3,567,822. **DOKUSTAR CAPTURE SUITE (BLOCK FORM)**. OCÉ DOCUMENT TECHNOLOGIES GMBH, (U.S. CLS. 21, 23, 26, 36 AND 38). SN 79-035,420. PUB. 11-11-2008. FILED 1-17-2007.
- 3,567,823. **NXP AND DESIGN**. NXP B.V., (U.S. CLS. 21, 23, 26, 36 AND 38). SN 79-036,900. PUB. 11-11-2008. FILED 2-19-2007.
- 3,567,826. **VCT-MOTION (BLOCK FORM)**. MICRONAS GMBH, MULTIPLE CLASS, (INT. CLS. 9, 38 AND 42), (U.S. CLS. 21, 23, 26, 36, 38, 100, 101 AND 104). SN 79-037,698. PUB. 11-11-2008. FILED 1-10-2007.
- 3,567,829. **ICR (BLOCK FORM)**. IPIAIGHT PTY LTD, MULTIPLE CLASS, (INT. CLS. 9, 16, 35 AND 41), (U.S. CLS. 2, 5, 21, 22, 23, 26, 29, 36, 37, 38, 50, 100, 101, 102 AND 107). SN 79-038,512. PUB. 11-11-2008. FILED 12-21-2006.
- 3,567,830. **RADARLUX (BLOCK FORM)**. RADARLUX RADAR SYSTEMS GMBH, MULTIPLE CLASS, (INT. CLS. 9 AND 11), (U.S. CLS. 13, 21, 23, 26, 31, 34, 36 AND 38). SN 79-038,566. PUB. 11-11-2008. FILED 4-19-2007.
- 3,567,839 (*See Class 7 for this trademark*).
- 3,567,846. **MVADVANCED (STYLIZED)**. YOKOGAWA ELECTRIC CORPORATION, (U.S. CLS. 21, 23, 26, 36 AND 38). SN 79-042,203. PUB. 11-11-2008. FILED 7-3-2007.
- 3,567,847. **GOLDEN CUT BY LTB CULT PIECE ONLY FOR HAPPY FEW AND DESIGN**. ÇAK TEXTILE B.V., MULTIPLE CLASS, (INT. CLS. 9, 14, 18 AND 25), (U.S. CLS. 1, 2, 3, 21, 22, 23, 26, 27, 28, 36, 38, 39, 41 AND 50). SN 79-042,225. PUB. 11-11-2008. FILED 7-26-2007.
- 3,567,848. **CYBLE (BLOCK FORM)**. ACTARIS SAS, MULTIPLE CLASS, (INT. CLS. 9, 35 AND 38), (U.S. CLS. 21, 23, 26, 36, 38, 100, 101, 102 AND 104). SN 79-042,857. PUB. 11-11-2008. FILED 1-23-2007.
- 3,567,860. **YULONG AND DESIGN**. YULONG COMPUTER TELECOMMUNICATION; SCIENTIFIC (SHENZHEN) CO., LTD, (U.S. CLS. 21, 23, 26, 36 AND 38). SN 79-045,846. PUB. 11-11-2008. FILED 4-24-2007.
- 3,567,868. **FCT CONNECTING IS OUR BUSINESS (STYLIZED)**. FCT ELECTRONIC GMBH, MULTIPLE CLASS, (INT. CLS. 9, 37, 40 AND 42), (U.S. CLS. 21, 23, 26, 36, 38, 100, 101, 103 AND 106). SN 79-046,578. PUB. 11-11-2008. FILED 3-22-2007.
- 3,567,870. **SOFON (STYLIZED)**. SOFON B.V., MULTIPLE CLASS, (INT. CLS. 9, 35 AND 42), (U.S. CLS. 21, 23, 26, 36, 38, 100, 101 AND 102). SN 79-046,864. PUB. 11-11-2008. FILED 8-30-2007.
- 3,567,872. **VAVAA (BLOCK FORM)**. YUANTIAN ZHANG, MULTIPLE CLASS, (INT. CLS. 9, 38 AND 42), (U.S. CLS. 21, 23, 26, 36, 38, 100, 101 AND 104). SN 79-046,999. PUB. 11-11-2008. FILED 10-24-2007.
- 3,567,878. **SOST AND DESIGN**. QUANZHOU SOUTHEAST PHOTOELECTRIC CO., LTD., (U.S. CLS. 21, 23, 26, 36 AND 38). SN 79-047,584. PUB. 11-11-2008. FILED 11-15-2007.
- 3,567,879. **SCHALLER (STYLIZED)**. SCHALLER ELECTRONIC GMBH, MULTIPLE CLASS, (INT. CLS. 9 AND 15), (U.S. CLS. 2, 21, 23, 26, 36 AND 38). SN 79-047,908. PUB. 11-11-2008. FILED 11-27-2007.
- 3,567,880. **PONS AND DESIGN**. ERNST KLETT SPRACHEN GMBH, MULTIPLE CLASS, (INT. CLS. 9, 16, 38, 41 AND 42), (U.S. CLS. 2, 5, 21, 22, 23, 26, 29, 36, 37, 38, 50, 100, 101, 104 AND 107). SN 79-047,994. PUB. 11-11-2008. FILED 7-20-2007.
- 3,567,883. **EMONECTION (BLOCK FORM)**. SAMSUNG ELECTRONICS CO., LTD., (U.S. CLS. 21, 23, 26, 36 AND 38). SN 79-048,237. PUB. 11-11-2008. FILED 11-13-2007.
- 3,567,884. **EMOSEARCH (BLOCK FORM)**. SAMSUNG ELECTRONICS CO., LTD., (U.S. CLS. 21, 23, 26, 36 AND 38). SN 79-048,238. PUB. 11-11-2008. FILED 11-13-2007.
- 3,567,892. **MINDFOOD (BLOCK FORM)**. MICHAEL PETER MCHUGH, MULTIPLE CLASS, (INT. CLS. 9, 16 AND 41), (U.S. CLS. 2, 5, 21, 22, 23, 26, 29, 36, 37, 38, 50, 100, 101 AND 107). SN 79-048,836. PUB. 11-11-2008. FILED 12-20-2007.

- 3,567,894. **MAQUET FLOW-I (STYLIZED)**. MAQUET CRITICAL CARE AB, MULTIPLE CLASS, (INT. CLS. 9 AND 10), (U.S. CLS. 21, 23, 26, 36, 38, 39 AND 44). SN 79-048,969. PUB. 11-11-2008. FILED 11-27-2007.
- 3,567,895. **FRWD (STYLIZED)**. ELISA OYJ, (U.S. CLS. 21, 23, 26, 36 AND 38). SN 79-049,017. PUB. 11-11-2008. FILED 12-31-2007.
- 3,567,896. **FRWD (STYLIZED)**. ELISA OYJ, (U.S. CLS. 21, 23, 26, 36 AND 38). SN 79-049,018. PUB. 11-11-2008. FILED 12-31-2007.
- 3,567,899. **GLACIAL POWER AND DESIGN**. GLACIALTECH, INC., (U.S. CLS. 21, 23, 26, 36 AND 38). SN 79-049,214. PUB. 11-11-2008. FILED 12-24-2007.
- 3,567,900. **TRAVLETS (BLOCK FORM)**. BCD TRAVEL GERMANY HOLDING GMBH, MULTIPLE CLASS, (INT. CLS. 9, 38 AND 42), (U.S. CLS. 21, 23, 26, 36, 38, 100, 101 AND 104). SN 79-049,218. PUB. 11-11-2008. FILED 12-5-2007.
- 3,567,904. **SUGAR & BABE AND DESIGN**. CROWN CREATIVE CO., LTD., MULTIPLE CLASS, (INT. CLS. 9, 14, 16, 18, 24, 25 AND 28), (U.S. CLS. 1, 2, 3, 5, 21, 22, 23, 26, 27, 28, 29, 36, 37, 38, 39, 41, 42 AND 50). SN 79-049,514. PUB. 11-11-2008. FILED 7-13-2007.
- 3,567,906. **JRC REFLEX (BLOCK FORM)**. JRC REFLEX, MULTIPLE CLASS, (INT. CLS. 9, 10, 17, 24 AND 26), (U.S. CLS. 1, 5, 12, 13, 21, 23, 26, 35, 36, 37, 38, 39, 40, 42, 44 AND 50). SN 79-049,572. PUB. 11-11-2008. FILED 12-5-2007.
- 3,567,911 (*See Class 7 for this trademark*).
- 3,567,912 (*See Class 3 for this trademark*).
- 3,567,916. **XCHAR (BLOCK FORM)**. KARO INTERNET GMBH, MULTIPLE CLASS, (INT. CLS. 9, 35, 38, 41, 42 AND 45), (U.S. CLS. 21, 23, 26, 36, 38, 100, 101, 102, 104 AND 107). SN 79-050,080. PUB. 11-11-2008. FILED 11-8-2007.
- 3,567,917. **EXAUDIO (BLOCK FORM)**. EXAUDIO AB, MULTIPLE CLASS, (INT. CLS. 9 AND 42), (U.S. CLS. 21, 23, 26, 36, 38, 100 AND 101). SN 79-050,100. PUB. 11-11-2008. FILED 12-27-2007.
- 3,567,919. **SCHOTT POLY (BLOCK FORM)**. SCHOTT AKTIENGESELLSCHAFT, (U.S. CLS. 21, 23, 26, 36 AND 38). SN 79-050,131. PUB. 11-11-2008. FILED 1-21-2008.
- 3,567,921. **SCHOTT INDAX (BLOCK FORM)**. SCHOTT AKTIENGESELLSCHAFT, (U.S. CLS. 21, 23, 26, 36 AND 38). SN 79-050,260. PUB. 11-11-2008. FILED 1-21-2008.
- 3,567,922. **SCHOTT MONO (BLOCK FORM)**. SCHOTT AKTIENGESELLSCHAFT, (U.S. CLS. 21, 23, 26, 36 AND 38). SN 79-050,261. PUB. 11-11-2008. FILED 1-21-2008.
- 3,567,923. **SCHOTT ASI (BLOCK FORM)**. SCHOTT AKTIENGESELLSCHAFT, (U.S. CLS. 21, 23, 26, 36 AND 38). SN 79-050,262. PUB. 11-11-2008. FILED 1-21-2008.
- 3,567,925 (*See Class 7 for this trademark*).
- 3,567,928 (*See Class 5 for this trademark*).
- 3,567,931 (*See Class 1 for this trademark*).
- 3,567,941. **SKOBLER AND DESIGN**. NAVIGON AG, MULTIPLE CLASS, (INT. CLS. 9, 12, 35, 38, 39 AND 42), (U.S. CLS. 19, 21, 23, 26, 31, 35, 36, 38, 44, 100, 101, 102, 104 AND 105). SN 79-051,617. PUB. 11-11-2008. FILED 11-12-2007.
- 3,567,942. **CXS AND DESIGN**. CHANGXING CHANGSHENG BATTERY CO., LTD., (U.S. CLS. 21, 23, 26, 36 AND 38). SN 79-051,688. PUB. 11-11-2008. FILED 1-21-2008.
- 3,567,945. **SIXTON PEAK AND DESIGN**. MASPICA SRL, MULTIPLE CLASS, (INT. CLS. 9 AND 25), (U.S. CLS. 21, 22, 23, 26, 36, 38 AND 39). SN 79-052,035. PUB. 11-11-2008. FILED 1-8-2008.
- 3,567,956. **BAXTERBEAR AND DESIGN**. BAXTERBEAR LIMITED, MULTIPLE CLASS, (INT. CLS. 9, 16, 24, 25 AND 28), (U.S. CLS. 2, 5, 21, 22, 23, 26, 29, 36, 37, 38, 39, 42 AND 50). SN 79-053,284. PUB. 11-11-2008. FILED 12-17-2007.
- 3,567,964. **BATTER (BLOCK FORM)**. N.V. NEDERLANDSCHE APPARATENFABRIEK NEDAP, (U.S. CLS. 21, 23, 26, 36 AND 38). SN 79-054,666. PUB. 11-11-2008. FILED 6-10-2008.
- 3,567,969. **O.T.S. OJMAR TRANSPONDER SYSTEM (STYLIZED)**. OJMAR, S.A., (U.S. CLS. 21, 23, 26, 36 AND 38). SN 79-054,850. PUB. 11-11-2008. FILED 4-4-2008.
- 3,567,972. **ERWEKA (BLOCK FORM)**. ERWEKA GMBH, (U.S. CLS. 21, 23, 26, 36 AND 38). SN 79-055,271. PUB. 11-11-2008. FILED 4-24-2008.
- 3,567,974. **EX2 (STYLIZED)**. IFEELU INC., (U.S. CLS. 21, 23, 26, 36 AND 38). SN 79-055,475. PUB. 11-11-2008. FILED 6-12-2008.
- 3,567,978. **QUANTMASTER (BLOCK FORM)**. KONINKLIJKE PHILIPS ELECTRONICS N.V., MULTIPLE CLASS, (INT. CLS. 9 AND 10), (U.S. CLS. 21, 23, 26, 36, 38, 39 AND 44). SN 79-056,024. PUB. 11-11-2008. FILED 7-3-2008.
- 3,567,985. **TEOPAD (BLOCK FORM)**. THALES COMMUNICATIONS SA, (U.S. CLS. 21, 23, 26, 36 AND 38). SN 79-057,357. PUB. 11-11-2008. FILED 7-25-2008.
- 3,567,988. **TANKEBLUE AND DESIGN**. TANKEBLUE SEMICONDUCTOR CO., LTD., (U.S. CLS. 21, 23, 26, 36 AND 38). SN 79-057,781. PUB. 11-11-2008. FILED 6-19-2008.

CLASS 10—MEDICAL APPARATUS

- 3,566,265. **CAS EXPRESS (BLOCK FORM)**. CAS MEDICAL SYSTEMS, INC., (U.S. CLS. 26, 39 AND 44). SN 76-608,879. PUB. 11-11-2008. FILED 8-20-2004.
- 3,566,267 (*See Class 9 for this trademark*).
- 3,566,268 (*See Class 9 for this trademark*).
- 3,566,279 (*See Class 1 for this trademark*).
- 3,566,368 (*See Class 9 for this trademark*).
- 3,566,381. **FREEZOLAR (BLOCK FORM)**. FREEZOLAR TECHNOLOGIES GMBH, MULTIPLE CLASS, (INT. CLS. 10, 11 AND 21), (U.S. CLS. 2, 13, 21, 23, 26, 29, 30, 31, 33, 34, 39, 40, 44 AND 50). SN 77-045,114. PUB. 11-11-2008. FILED 11-15-2006.
- 3,566,423 (*See Class 8 for this trademark*).
- 3,566,434 (*See Class 1 for this trademark*).
- 3,566,441. **UUM (BLOCK FORM)**. OSIM INTERNATIONAL LTD., MULTIPLE CLASS, (INT. CLS. 10, 25 AND 35), (U.S. CLS. 22, 26, 39, 44, 100, 101 AND 102). SN 77-142,584. PUB. 11-11-2008. FILED 3-28-2007.
- 3,566,442. **CUREFLO (BLOCK FORM)**. ASAHI KASEI KURARAY MEDICAL CO., LTD., (U.S. CLS. 26, 39 AND 44). SN 77-142,659. PUB. 11-11-2008. FILED 3-28-2007.
- 3,566,455 (*See Class 9 for this trademark*).
- 3,566,508 (*See Class 1 for this trademark*).
- 3,566,678. **AERODAWG AND DESIGN**. TRUDELL MEDICAL INTERNATIONAL, (U.S. CLS. 26, 39 AND 44). SN 77-349,068. PUB. 11-11-2008. FILED 12-11-2007.
- 3,567,008. **INSPIRE AND DESIGN**. K2 HEALTH PRODUCTS, LLC, MULTIPLE CLASS, (INT. CLS. 10, 16 AND 25), (U.S. CLS. 2, 5, 22, 23, 26, 29, 37, 38, 39, 44 AND 50). SN 77-487,448. PUB. 11-11-2008. FILED 5-30-2008.
- 3,567,041. **BOO BOO BAGS (BLOCK FORM)**. LOLA B, L.L.C., (U.S. CLS. 26, 39 AND 44). SN 77-490,795. PUB. 11-11-2008. FILED 6-4-2008.
- 3,567,239. **WALKER FANCY (BLOCK FORM)**. WALKER FANCY, INC., (U.S. CLS. 26, 39 AND 44). SN 77-500,465. PUB. 11-11-2008. FILED 6-17-2008.
- 3,567,264. **SUNNY HEALTH & FITNESS (BLOCK FORM)**. SUNNY DISTRIBUTOR, INC., MULTIPLE CLASS, (INT. CLS. 10 AND 28), (U.S. CLS. 22, 23, 26, 38, 39, 44 AND 50). SN 77-500,830. PUB. 11-11-2008. FILED 6-17-2008.
- 3,567,407. **MISCELLANEOUS DESIGN**. X-BACK BRACING SERVICES, INC., (U.S. CLS. 26, 39 AND 44). SN 77-502,915. PUB. 11-11-2008. FILED 6-19-2008.
- 3,567,428. **XTRAC (BLOCK FORM)**. PHOTOMEDEX, INC., (U.S. CLS. 26, 39 AND 44). SN 77-503,314. PUB. 11-11-2008. FILED 6-19-2008.
- 3,567,467. **INTENSA (BLOCK FORM)**. ELECTRA-LIGHT MANUFACTURING, INC., (U.S. CLS. 26, 39 AND 44). SN 77-504,241. PUB. 11-11-2008. FILED 6-20-2008.
- 3,567,476. **GXCB-500 (BLOCK FORM)**. GENDEX CORP., (U.S. CLS. 26, 39 AND 44). SN 77-504,368. PUB. 11-11-2008. FILED 6-20-2008.
- 3,567,477. **PRECISION (BLOCK FORM)**. HAVEL'S INCORPORATED, (U.S. CLS. 26, 39 AND 44). SN 77-504,409. PUB. 11-11-2008. FILED 6-20-2008.
- 3,567,548. **VTRAC (BLOCK FORM)**. PHOTOMEDEX, INC., (U.S. CLS. 26, 39 AND 44). SN 77-505,837. PUB. 11-11-2008. FILED 6-23-2008.
- 3,567,567. **VLIF AND DESIGN**. HARES DE MEXICO, S.A. DE C.V., (U.S. CLS. 26, 39 AND 44). SN 77-506,355. PUB. 11-11-2008. FILED 6-24-2008.
- 3,567,596. **BODYGUARD (BLOCK FORM)**. CME AMERICA,

- LLC, (U.S. CLS. 26, 39 AND 44). SN 77-506,925. PUB. 11-11-2008. FILED 6-24-2008.
- 3,567,599. **BODYSET (BLOCK FORM)**. CME AMERICA, LLC, (U.S. CLS. 26, 39 AND 44). SN 77-507,043. PUB. 11-11-2008. FILED 6-24-2008.
- 3,567,620. **NEUROWORKS (BLOCK FORM)**. NATUS MEDICAL INCORPORATED, (U.S. CLS. 26, 39 AND 44). SN 77-508,401. PUB. 11-11-2008. FILED 6-25-2008.
- 3,567,665. **BLISS BULLET (BLOCK FORM)**. CALIFORNIA EXOTIC NOVELTIES LLC, (U.S. CLS. 26, 39 AND 44). SN 77-519,747. PUB. 11-11-2008. FILED 7-11-2008.
- 3,567,698. **POWER SURFER (BLOCK FORM)**. CALIFORNIA EXOTIC NOVELTIES LLC, (U.S. CLS. 26, 39 AND 44). SN 77-534,985. PUB. 11-11-2008. FILED 7-30-2008.
- 3,567,699. **PURE STUD (BLOCK FORM)**. CALIFORNIA EXOTIC NOVELTIES LLC, (U.S. CLS. 26, 39 AND 44). SN 77-536,181. PUB. 11-11-2008. FILED 7-31-2008.
- 3,567,763 (*See Class 1 for this trademark*).
- 3,567,767. **VISCOPE (BLOCK FORM)**. HD MEDICAL GROUP, LIMITED, (U.S. CLS. 26, 39 AND 44). SN 78-852,882. PUB. 11-11-2008. FILED 4-3-2006.
- 3,567,805. **AMO OPTIBLUE (BLOCK FORM)**. ADVANCED MEDICAL OPTICS, INC, (U.S. CLS. 26, 39 AND 44). SN 79-026,267. PUB. 11-11-2008. FILED 5-31-2006.
- 3,567,814 (*See Class 1 for this trademark*).
- 3,567,818 (*See Class 9 for this trademark*).
- 3,567,821. **REMODELING FACE (BLOCK FORM)**. ETOILE DISTRIBUTION, (U.S. CLS. 26, 39 AND 44). SN 79-035,134. PUB. 11-11-2008. FILED 12-27-2006.
- 3,567,845. **BAGUERA (BLOCK FORM)**. SPINEART S.A., (U.S. CLS. 26, 39 AND 44). SN 79-041,753. PUB. 11-11-2008. FILED 7-20-2007.
- 3,567,894 (*See Class 9 for this trademark*).
- 3,567,897. **FOUR LADS: AND DESIGN**. ZERO TO SEVEN INC., MULTIPLE CLASS, (INT. CLS. 10 AND 11), (U.S. CLS. 13, 21, 23, 26, 31, 34, 39 AND 44). SN 79-049,091. PUB. 11-11-2008. FILED 4-6-2007.
- 3,567,906 (*See Class 9 for this trademark*).
- 3,567,959. **STILLE VISI (BLOCK FORM)**. STILLE SURGICAL AKTIEBOLAG, (U.S. CLS. 26, 39 AND 44). SN 79-053,863. PUB. 11-11-2008. FILED 4-24-2008.
- 3,567,967. **BELTONE IDENTITY (BLOCK FORM)**. GN RESOUND A/S, (U.S. CLS. 26, 39 AND 44). SN 79-054,771. PUB. 11-11-2008. FILED 5-22-2008.
- 3,567,968. **RESOUND MATCH (BLOCK FORM)**. GN RESOUND A/S, (U.S. CLS. 26, 39 AND 44). SN 79-054,792. PUB. 11-11-2008. FILED 4-24-2008.
- 3,567,977. **PIRANHA (BLOCK FORM)**. RICHARD WOLF GMBH, (U.S. CLS. 26, 39 AND 44). SN 79-055,948. PUB. 11-11-2008. FILED 6-10-2008.
- 3,567,978 (*See Class 9 for this trademark*).
- 3,567,981. **EPEN (BLOCK FORM)**. SIEMENS AUDIOLOGISCHE TECHNIK GMBH, (U.S. CLS. 26, 39 AND 44). SN 79-056,391. PUB. 11-11-2008. FILED 6-30-2008.
- 3,567,986. **PERFORMA EXPERT (BLOCK FORM)**. ROCHE DIAGNOSTICS GMBH, (U.S. CLS. 26, 39 AND 44). SN 79-057,459. PUB. 11-11-2008. FILED 6-27-2008.
- 3,567,987. **PERFORMA COMBO (BLOCK FORM)**. ROCHE DIAGNOSTICS GMBH, (U.S. CLS. 26, 39 AND 44). SN 79-057,460. PUB. 11-11-2008. FILED 6-27-2008.
- ING, INC., AND BEL AIR LIGHTING, INC., (U.S. CLS. 13, 21, 23, 31 AND 34). SN 77-314,305. PUB. 11-11-2008. FILED 10-26-2007.
- 3,566,641. **CHALLENGER XL (BLOCK FORM)**. ITW FOOD EQUIPMENT GROUP LLC, (U.S. CLS. 13, 21, 23, 31 AND 34). SN 77-338,834. PUB. 11-11-2008. FILED 11-28-2007.
- 3,566,657. **IWS (BLOCK FORM)**. AIR-CURE DYNAMICS, INC., DBA CEILCOTE AIR POLLUTION CONTROL, (U.S. CLS. 13, 21, 23, 31 AND 34). SN 77-342,694. PUB. 11-11-2008. FILED 12-3-2007.
- 3,566,668 (*See Class 6 for this trademark*).
- 3,566,766. **SACRAMENTO SEARCHLIGHTS AND DESIGN**. HILL, JEFF A, (U.S. CLS. 13, 21, 23, 31 AND 34). SN 77-382,040. PUB. 11-11-2008. FILED 1-28-2008.
- 3,566,804. **DOFINY (STYLIZED)**. TANGSHAN AYERS BATH EQUIPMENT CO., LTD., (U.S. CLS. 13, 21, 23, 31 AND 34). SN 77-408,015. PUB. 11-11-2008. FILED 2-27-2008.
- 3,566,979. **SEAL MATIC AND DESIGN**. D.R. INTELLECTUAL PROPERTIES, INC., (U.S. CLS. 13, 21, 23, 31 AND 34). SN 77-483,687. PUB. 11-11-2008. FILED 5-27-2008.
- 3,567,113. **MINI MELT (STYLIZED)**. INDUCTOTHERM CORP., (U.S. CLS. 13, 21, 23, 31 AND 34). SN 77-496,483. PUB. 11-11-2008. FILED 6-11-2008.
- 3,567,123. **PUKA TOASTER (BLOCK FORM)**. SCHMANSKI, DONALD W., (U.S. CLS. 13, 21, 23, 31 AND 34). SN 77-496,622. PUB. 11-11-2008. FILED 6-11-2008.
- 3,567,223. **FIREFLY MAGIC (BLOCK FORM)**. STEPHEN J. TAYLOR, (U.S. CLS. 13, 21, 23, 31 AND 34). SN 77-500,065. PUB. 11-11-2008. FILED 6-16-2008.
- 3,567,297. **LUMENCRAFT (BLOCK FORM)**. LUMENCRAFT INC., (U.S. CLS. 13, 21, 23, 31 AND 34). SN 77-501,296. PUB. 11-11-2008. FILED 6-17-2008.
- 3,567,312. **TOP AND DESIGN**. TOP WERBEMITTEL GMBH, (U.S. CLS. 13, 21, 23, 31 AND 34). SN 77-501,476. PUB. 11-11-2008. FILED 6-18-2008.
- 3,567,452. **ICE Q'B (BLOCK FORM)**. ICE QIK, LLC, (U.S. CLS. 13, 21, 23, 31 AND 34). SN 77-503,705. PUB. 11-11-2008. FILED 6-20-2008.
- 3,567,641. **MISCELLANEOUS DESIGN**. MAGTEC ENERGY, LLC, (U.S. CLS. 13, 21, 23, 31 AND 34). SN 77-512,396. PUB. 11-11-2008. FILED 7-1-2008.
- 3,567,810 (*See Class 7 for this trademark*).
- 3,567,825. **BOONO (BLOCK FORM)**. NARA MACHINERY CO., LTD., (U.S. CLS. 13, 21, 23, 31 AND 34). SN 79-037,309. PUB. 11-11-2008. FILED 4-9-2007.
- 3,567,830 (*See Class 9 for this trademark*).
- 3,567,838. **LADDOMAT (BLOCK FORM)**. TERMOVENTILER I ULRICEHAMN AB, (U.S. CLS. 13, 21, 23, 31 AND 34). SN 79-040,954. PUB. 11-11-2008. FILED 3-1-2007.
- 3,567,851 (*See Class 6 for this trademark*).
- 3,567,856. **MIS EN DEMEURE (BLOCK FORM)**. DARAUX ANGELA, MULTIPLE CLASS, (INT. CLS. 11, 20 AND 21), (U.S. CLS. 2, 13, 21, 22, 23, 25, 29, 30, 31, 32, 33, 34, 40 AND 50). SN 79-045,625. PUB. 11-11-2008. FILED 10-11-2007.
- 3,567,897 (*See Class 10 for this trademark*).
- 3,567,905. **AIR TOP EVO (BLOCK FORM)**. WEBASTO AG, (U.S. CLS. 13, 21, 23, 31 AND 34). SN 79-049,542. PUB. 11-11-2008. FILED 12-20-2007.
- 3,567,928 (*See Class 5 for this trademark*).
- 3,567,931 (*See Class 1 for this trademark*).
- 3,567,938. **YINGQI (STYLIZED)**. NINGBO YINGQI; ELECTRICAL INDUSTRY CO., LTD., (U.S. CLS. 13, 21, 23, 31 AND 34). SN 79-051,400. PUB. 11-11-2008. FILED 3-17-2008.
- 3,567,957. **INTRA LIGHTING AND DESIGN**. INTRA LIGHTING.; PROIZVODNJA SVETIL IN; OPREMA OBJEKTOV D.O.O., (U.S. CLS. 13, 21, 23, 31 AND 34). SN 79-053,386. PUB. 11-11-2008. FILED 4-9-2008.

CLASS 11—ENVIRONMENTAL CONTROL APPARATUS

- 3,566,267 (*See Class 9 for this trademark*).
- 3,566,268 (*See Class 9 for this trademark*).
- 3,566,381 (*See Class 10 for this trademark*).
- 3,566,423 (*See Class 8 for this trademark*).
- 3,566,562. **REVENT (BLOCK FORM)**. REVENT INTERNATIONAL AB, (U.S. CLS. 13, 21, 23, 31 AND 34). SN 77-296,261. PUB. 11-11-2008. FILED 10-4-2007.
- 3,566,567. **MISCELLANEOUS DESIGN**. HUBBARDTON FORGE, LLC, (U.S. CLS. 13, 21, 23, 31 AND 34). SN 77-305,045. PUB. 11-11-2008. FILED 10-16-2007.
- 3,566,569 (*See Class 7 for this trademark*).
- 3,566,577. **TRANS GLOBE AND DESIGN**. BEL AIR LIGHT-

CLASS 12—VEHICLES

- 3,566,254. **NAUTIQUES AND DESIGN**. CORRECT CRAFT, INC., MULTIPLE CLASS, (INT. CLS. 12, 18 AND 25), (U.S. CLS. 1, 2, 3, 19, 21, 22, 23, 31, 35, 39, 41 AND 44). SN 76-045,314. PUB. 8-6-2002. FILED 5-10-2000.
- 3,566,255. **NAUTIQUES**. CORRECT CRAFT, INC., MULTIPLE CLASS, (INT. CLS. 12, 18 AND 25), (U.S. CLS. 1, 2, 3, 19,

21, 22, 23, 31, 35, 39, 41 AND 44). SN 76-045,320. PUB. 1-22-2002. FILED 5-10-2000.

3,566,267 (*See Class 9 for this trademark*).

3,566,268 (*See Class 9 for this trademark*).

3,566,327. **GORILLA GUARD (BLOCK FORM)**. AMCOR INDUSTRIES, INC., (U.S. CLS. 19, 21, 23, 31, 35 AND 44). SN 76-688,747. PUB. 11-11-2008. FILED 4-18-2008.

3,566,335. **BITOS (BLOCK FORM)**. ZENE INC., (U.S. CLS. 19, 21, 23, 31, 35 AND 44). SN 76-689,922. PUB. 11-11-2008. FILED 5-23-2008.

3,566,367. **ROVER (BLOCK FORM)**. LAND ROVER, MULTIPLE CLASS, (INT. CLS. 12, 27 AND 28), (U.S. CLS. 19, 20, 21, 22, 23, 31, 35, 37, 38, 42, 44 AND 50). SN 77-001,370. PUB. 11-11-2008. FILED 9-18-2006.

3,566,435 (*See Class 7 for this trademark*).

3,566,459 (*See Class 6 for this trademark*).

3,566,479. **HODAKA H PABATCO AND DESIGN**. STRICTLY HODAKA, LLC, (U.S. CLS. 19, 21, 23, 31, 35 AND 44). SN 77-202,197. PUB. 11-11-2008. FILED 6-10-2007.

3,566,488. **SAVINI FORGED (BLOCK FORM)**. KIM, GUN WOO, (U.S. CLS. 19, 21, 23, 31, 35 AND 44). SN 77-213,614. PUB. 11-11-2008. FILED 6-22-2007.

3,566,489. **AVARUS (BLOCK FORM)**. KIM, GUN WOO, (U.S. CLS. 19, 21, 23, 31, 35 AND 44). SN 77-213,634. PUB. 11-11-2008. FILED 6-22-2007.

3,566,655 (*See Class 9 for this trademark*).

3,566,701. **MISCELLANEOUS DESIGN**. MACK TRUCKS, INC., (U.S. CLS. 19, 21, 23, 31, 35 AND 44). SN 77-353,435. PUB. 11-11-2008. FILED 12-17-2007.

3,566,839. **RIVERA PRIMO AND DESIGN**. RIVERA PRIMO, INC. DBA RIVERA ENGINEERING, (U.S. CLS. 19, 21, 23, 31, 35 AND 44). SN 77-432,306. PUB. 11-11-2008. FILED 3-26-2008.

3,567,004. **KÓLBS (STYLIZED)**. K2 HEALTH PRODUCTS, MULTIPLE CLASS, (INT. CLS. 12 AND 20), (U.S. CLS. 2, 13, 19, 21, 22, 23, 25, 31, 32, 35, 44 AND 50). SN 77-487,079. PUB. 11-11-2008. FILED 5-30-2008.

3,567,373. **BULLSEYE AND DESIGN**. JACKSON, STEVEN, (U.S. CLS. 19, 21, 23, 31, 35 AND 44). SN 77-502,402. PUB. 11-11-2008. FILED 6-18-2008.

3,567,604. **MRMIKES (BLOCK FORM)**. BRUYERE, MICHAEL A. DBA MRMIKES, (U.S. CLS. 19, 21, 23, 31, 35 AND 44). SN 77-507,199. PUB. 11-11-2008. FILED 6-24-2008.

3,567,637. **FEATHER WWW.FEATHERBRAKES.COM AND DESIGN**. BARNETT, ROBERT L., (U.S. CLS. 19, 21, 23, 31, 35 AND 44). SN 77-511,416. PUB. 11-11-2008. FILED 6-30-2008.

3,567,722. **U-DUMP (BLOCK FORM)**. U-DUMP TRAILERS, INC., (U.S. CLS. 19, 21, 23, 31, 35 AND 44). SN 77-572,253. PUB. 11-11-2008. FILED 9-17-2008.

3,567,765. **RENEGADE (BLOCK FORM)**. BOMBARDIER RECREATIONAL PRODUCTS INC., (U.S. CLS. 19, 21, 23, 31, 35 AND 44). SN 78-837,369. PUB. 11-11-2008. FILED 3-15-2006.

3,567,816 (*See Class 9 for this trademark*).

3,567,849. **MEC PLASTICS AND DESIGN**. MECPLAST S.R.L., (U.S. CLS. 19, 21, 23, 31, 35 AND 44). SN 79-043,174. PUB. 11-11-2008. FILED 4-5-2007.

3,567,881. **X-YACHTS (BLOCK FORM)**. EJENDOMSSKABET 2000 APS, MULTIPLE CLASS, (INT. CLS. 12, 25 AND 39), (U.S. CLS. 19, 21, 22, 23, 31, 35, 39, 44, 100 AND 105). SN 79-048,056. PUB. 11-11-2008. FILED 12-13-2007.

3,567,882. **ELOF (BLOCK FORM)**. ELOF AB, (U.S. CLS. 19, 21, 23, 31, 35 AND 44). SN 79-048,178. PUB. 11-11-2008. FILED 11-16-2007.

3,567,887. **OCEANSTYLE (BLOCK FORM)**. OCEANSTYLE YACHTING LIMITED, MULTIPLE CLASS, (INT. CLS. 12, 35, 36 AND 39), (U.S. CLS. 19, 21, 23, 31, 35, 44, 100, 101, 102 AND 105). SN 79-048,432. PUB. 11-11-2008. FILED 12-12-2007.

3,567,932. **GLOBAL SCALING AND DESIGN**. STEINBACH GERHARD, MULTIPLE CLASS, (INT. CLS. 12, 36 AND 45), (U.S. CLS. 19, 21, 23, 31, 35, 44, 100, 101 AND 102). SN 79-051,280. PUB. 11-11-2008. FILED 12-12-2007.

3,567,933 (*See Class 1 for this trademark*).

3,567,934 (*See Class 1 for this trademark*).

3,567,935 (*See Class 1 for this trademark*).

3,567,936 (*See Class 1 for this trademark*).

3,567,941 (*See Class 9 for this trademark*).

3,567,991 (*See Class 7 for this trademark*).

CLASS 13—FIREARMS

3,566,710. **RWS AND DESIGN**. RUAG AMMOTEC GMBH, (U.S. CLS. 2 AND 9). SN 77-356,879. PUB. 11-11-2008. FILED 12-20-2007.

3,567,791. **R8 (BLOCK FORM)**. SAN SWISS ARMS TECHNOLOGY AG, MULTIPLE CLASS, (INT. CLS. 13 AND 28), (U.S. CLS. 2, 9, 22, 23, 38 AND 50). SN 78-969,683. PUB. 3-25-2008. FILED 9-8-2006.

CLASS 14—JEWELRY

3,566,257. **CIRCA 1900 AND DESIGN**. MEL BERNIE AND COMPANY, INC., (U.S. CLS. 2, 27, 28 AND 50). SN 76-363,256. PUB. 11-11-2008. FILED 1-26-2002.

3,566,286. **MISCELLANEOUS DESIGN**. VSA DESIGNS, INC., MULTIPLE CLASS, (INT. CLS. 14, 18 AND 25), (U.S. CLS. 1, 2, 3, 22, 27, 28, 39, 41 AND 50). SN 76-680,019. PUB. 11-11-2008. FILED 7-30-2007.

3,566,301. **ROLL-ON (BLOCK FORM)**. AID THROUGH TRADE, INC., (U.S. CLS. 2, 27, 28 AND 50). SN 76-684,750. PUB. 11-11-2008. FILED 12-10-2007.

3,566,375. **KAVITA (BLOCK FORM)**. DIACENTRE, INC., (U.S. CLS. 2, 27, 28 AND 50). SN 77-021,846. PUB. 11-11-2008. FILED 10-16-2006.

3,566,390. **X-FACTOR (BLOCK FORM)**. WHITEFLASH.COM, INC., (U.S. CLS. 2, 27, 28 AND 50). SN 77-055,390. PUB. 11-11-2008. FILED 12-1-2006.

3,566,589. **MISCELLANEOUS DESIGN**. GUCCI AMERICA, INC., (U.S. CLS. 2, 27, 28 AND 50). SN 77-319,934. PUB. 11-11-2008. FILED 11-2-2007.

3,566,803. **FASHION DILEMMA SOLVED! (BLOCK FORM)**. HELFMAN, JANIS, (U.S. CLS. 2, 27, 28 AND 50). SN 77-407,788. PUB. 11-11-2008. FILED 2-27-2008.

3,567,047. **BUFKOR (BLOCK FORM)**. BUFKOR, INCORPORATED, MULTIPLE CLASS, (INT. CLS. 14, 16 AND 20), (U.S. CLS. 2, 5, 13, 22, 23, 25, 27, 28, 29, 32, 37, 38 AND 50). SN 77-491,234. PUB. 11-11-2008. FILED 6-4-2008.

3,567,263. **GILVER (BLOCK FORM)**. MUSE IMPORTS LTD., (U.S. CLS. 2, 27, 28 AND 50). SN 77-500,821. PUB. 11-11-2008. FILED 6-17-2008.

3,567,351. **L.A. STEIN (BLOCK FORM)**. COVET 18K, INC., (U.S. CLS. 2, 27, 28 AND 50). SN 77-502,053. PUB. 11-11-2008. FILED 6-18-2008.

3,567,414. **ALL AUBURN ALL ORANGE (BLOCK FORM)**. AUBURN UNIVERSITY, MULTIPLE CLASS, (INT. CLS. 14 AND 25), (U.S. CLS. 2, 22, 27, 28, 39 AND 50). SN 77-503,005. PUB. 11-11-2008. FILED 6-19-2008.

3,567,429. **BITTYBE'S (BLOCK FORM)**. BE INSPIRED JEWELRY, LLC, (U.S. CLS. 2, 27, 28 AND 50). SN 77-503,325. PUB. 11-11-2008. FILED 6-19-2008.

3,567,449. **NOCTURNAL NOSTALGIA (BLOCK FORM)**. GOMEZ, ROSA E., MULTIPLE CLASS, (INT. CLS. 14 AND 25), (U.S. CLS. 2, 22, 27, 28, 39 AND 50). SN 77-503,653. PUB. 11-11-2008. FILED 6-19-2008.

3,567,564. **DT45 (STYLIZED)**. GLENN MILLER ASSOCIATES, (U.S. CLS. 2, 27, 28 AND 50). SN 77-506,263. PUB. 11-11-2008. FILED 6-24-2008.

3,567,749 (*See Class 2 for this trademark*).

3,567,796 (*See Class 9 for this trademark*).

3,567,808. **STEFF (BLOCK FORM)**. MARGARETE STEIFF GMBH, MULTIPLE CLASS, (INT. CLS. 14, 16, 18, 21 AND 25), (U.S. CLS. 1, 2, 3, 5, 13, 22, 23, 27, 28, 29, 30, 33, 37, 38, 39, 40, 41 AND 50). SN 79-027,397. PUB. 6-10-2008. FILED 1-11-2006.

3,567,812 (*See Class 9 for this trademark*).

3,567,847 (*See Class 9 for this trademark*).

3,567,866. **DELFINA DELETTREZ (BLOCK FORM)**. DELETTREZ S.R.L., MULTIPLE CLASS, (INT. CLS. 14, 18 AND 25), (U.S. CLS. 1, 2, 3, 22, 27, 28, 39, 41 AND 50). SN 79-

046,447. PUB. 11-11-2008. FILED 10-11-2007.
 3,567,904 (*See Class 9 for this trademark*).
 3,567,912 (*See Class 3 for this trademark*).
 3,567,918. **NAT-2 (BLOCK FORM)**. K & T; HANDELS- UND
 UNTERNEHMENSBERATUNG GMBH, MULTIPLE
 CLASS, (INT. CLS. 14, 18 AND 25), (U.S. CLS. 1, 2, 3, 22,
 27, 28, 39, 41 AND 50). SN 79-050,103. PUB. 11-11-2008.
 FILED 12-17-2007.
 3,567,920. **LASAKURA AND DESIGN**. MATSUO SANGYO
 CO., LTD., MULTIPLE CLASS, (INT. CLS. 14, 18, 21, 25
 AND 26), (U.S. CLS. 1, 2, 3, 13, 22, 23, 27, 28, 29, 30, 33, 37, 39,
 40, 41, 42 AND 50). SN 79-050,222. PUB. 11-11-2008. FILED 5-
 18-2007.
 3,567,937. **PARLAMORE AND DESIGN**. MARIANNE VAN
 ESSEN; H.O.D.N. MARIAN VAN ESSEN; ATELIER VOOR
 KUNST EN ONTWERP, (U.S. CLS. 2, 27, 28 AND 50). SN 79-
 051,388. PUB. 11-11-2008. FILED 2-28-2008.
 3,567,947. **MARA CAROL (BLOCK FORM)**. MARA CAROL
 S.R.L., MULTIPLE CLASS, (INT. CLS. 14, 18 AND 25), (U.S.
 CLS. 1, 2, 3, 22, 27, 28, 39, 41 AND 50). SN 79-052,255. PUB.
 11-11-2008. FILED 2-11-2008.
 3,567,953. **ISWATCH (STYLIZED)**. SWATCH AG (SWATCH
 SA) (SWATCH LTD), MULTIPLE CLASS, (INT. CLS. 14, 35
 AND 37), (U.S. CLS. 2, 27, 28, 50, 100, 101, 102, 103 AND 106).
 SN 79-053,142. PUB. 11-11-2008. FILED 4-7-2008.
 3,567,970 (*See Class 3 for this trademark*).

CLASS 15—MUSICAL INSTRUMENTS

3,566,269. **ALLEGRO (BLOCK FORM)**. YAMAHA CORPORA-
 TION, (U.S. CLS. 2, 21 AND 36). SN 76-663,528. PUB. 11-11-
 2008. FILED 7-24-2006.
 3,567,265. **RESOMAX (BLOCK FORM)**. DUNWOODIE, DA-
 VID, (U.S. CLS. 2, 21 AND 36). SN 77-500,836. PUB. 11-11-
 2008. FILED 6-17-2008.
 3,567,879 (*See Class 9 for this trademark*).
 3,567,903. **GUITARRAS ALMANS AND DESIGN**. MANU-
 FACTURAS ALHAMBRA, S.L., (U.S. CLS. 2, 21 AND 36).
 SN 79-049,286. PUB. 11-11-2008. FILED 10-3-2007.

CLASS 16—PAPER GOODS AND PRINTED MATTER

3,566,267 (*See Class 9 for this trademark*).
 3,566,268 (*See Class 9 for this trademark*).
 3,566,280. **APA DICTIONARY OF PSYCHOLOGY (BLOCK
 FORM)**. AMERICAN PSYCHOLOGICAL ASSOCIATION,
 (U.S. CLS. 2, 5, 22, 23, 29, 37, 38 AND 50). SN 76-677,009.
 PUB. 11-11-2008. FILED 5-17-2007.
 3,566,302. **3 2 AND DESIGN**. AMERICAN PSYCHOLOGICAL
 ASSOCIATION, (U.S. CLS. 2, 5, 22, 23, 29, 37, 38 AND 50).
 SN 76-684,847. PUB. 11-11-2008. FILED 12-11-2007.
 3,566,331. **BEAUTY IS OUR SCIENCE (BLOCK FORM)**. LIPO
 CHEMICALS, INC, (U.S. CLS. 2, 5, 22, 23, 29, 37, 38 AND 50).
 SN 76-689,098. PUB. 11-11-2008. FILED 4-28-2008.
 3,566,332. **AT LIPO, WE CALL THEM SCIENTISTS (BLOCK
 FORM)**. LIPO CHEMICALS, INC, (U.S. CLS. 2, 5, 22, 23, 29,
 37, 38 AND 50). SN 76-689,099. PUB. 11-11-2008. FILED 4-28-
 2008.
 3,566,341. **SALES REALITY (BLOCK FORM)**. BUSINESS
 METHODOLOGIES INTERNATIONAL, LTD., (U.S. CLS.
 2, 5, 22, 23, 29, 37, 38 AND 50). SN 76-690,329. PUB. 11-11-
 2008. FILED 6-6-2008.
 3,566,342. **CASH FLOW (BLOCK FORM)**. BUSINESS METH-
 ODOLOGIES INTERNATIONAL, LTD., (U.S. CLS. 2, 5, 22,
 23, 29, 37, 38 AND 50). SN 76-690,344. PUB. 11-11-2008.
 FILED 6-6-2008.
 3,566,359. **YA ES HORA ¡CIUDADANIA! (BLOCK FORM)**.
 UNIVISION COMMUNICATIONS INC., (U.S. CLS. 2, 5, 22,
 23, 29, 37, 38 AND 50). SN 76-690,807. PUB. 11-11-2008.
 FILED 6-23-2008.
 3,566,364. **HAVING A BABY CHANGES EVERYTHING
 (BLOCK FORM)**. JOHNSON & JOHNSON, MULTIPLE

CLASS, (INT. CLS. 16 AND 44), (U.S. CLS. 2, 5, 22, 23, 29,
 37, 38, 50, 100 AND 101). SN 76-692,379. PUB. 11-11-2008.
 FILED 8-26-2008.
 3,566,377. **WEALTHY LIVING (BLOCK FORM)**. IPME, LLLP,
 (U.S. CLS. 2, 5, 22, 23, 29, 37, 38 AND 50). SN 77-028,258.
 PUB. 11-11-2008. FILED 10-24-2006.
 3,566,397 (*See Class 9 for this trademark*).
 3,566,398. **IMAGE TO INTERIOR (BLOCK FORM)**. IMAGE
 TO INTERIOR INC., MULTIPLE CLASS, (INT. CLS. 16
 AND 42), (U.S. CLS. 2, 5, 22, 23, 29, 37, 38, 50, 100 AND 101).
 SN 77-068,733. PUB. 11-11-2008. FILED 12-20-2006.
 3,566,407. **CHANNELPRO (BLOCK FORM)**. CHANNEL EN-
 ABLEERS USA, LLC, (U.S. CLS. 2, 5, 22, 23, 29, 37, 38 AND
 50). SN 77-081,476. PUB. 11-11-2008. FILED 1-11-2007.
 3,566,411. **RAMTEX (BLOCK FORM)**. SAN SWISS ARMS AG,
 MULTIPLE CLASS, (INT. CLS. 16, 18 AND 25), (U.S. CLS. 1,
 2, 3, 5, 22, 23, 29, 37, 38, 39, 41 AND 50). SN 77-091,850. PUB.
 5-27-2008. FILED 1-26-2007.
 3,566,419 (*See Class 3 for this trademark*).
 3,566,431 (*See Class 6 for this trademark*).
 3,566,432 (*See Class 6 for this trademark*).
 3,566,445. **BUYPBL (BLOCK FORM)**. LEE, SHUYEN, MULTI-
 PLE CLASS, (INT. CLS. 16, 25, 28 AND 35), (U.S. CLS. 2, 5,
 22, 23, 29, 37, 38, 39, 50, 100, 101 AND 102). SN 77-149,504.
 PUB. 6-3-2008. FILED 4-5-2007.
 3,566,459 (*See Class 6 for this trademark*).
 3,566,462. **TRUST NO ONE (BLOCK FORM)**. SODINI, JIM,
 DBA TNO ENTERPRISES, MULTIPLE CLASS, (INT. CLS.
 16 AND 25), (U.S. CLS. 2, 5, 22, 23, 29, 37, 38, 39 AND 50). SN
 77-180,783. PUB. 7-29-2008. FILED 5-14-2007.
 3,566,470. **ACCELERATE (BLOCK FORM)**. ADVANCED MI-
 CRO DEVICES, INC., MULTIPLE CLASS, (INT. CLS. 16
 AND 41), (U.S. CLS. 2, 5, 22, 23, 29, 37, 38, 50, 100, 101 AND
 107). SN 77-189,354. PUB. 11-11-2008. FILED 5-24-2007.
 3,566,504. **ANNE WEYBURN (BLOCK FORM)**. REDCATS,
 MULTIPLE CLASS, (INT. CLS. 16 AND 25), (U.S. CLS. 2, 5,
 22, 23, 29, 37, 38, 39 AND 50). SN 77-226,246. PUB. 4-22-2008.
 FILED 7-10-2007.
 3,566,508 (*See Class 1 for this trademark*).
 3,566,511. **WEB 'N' WALK EXPRESS CARD (BLOCK FORM)**.
 DEUTSCHE TELEKOM AG, (U.S. CLS. 2, 5, 22, 23, 29, 37, 38
 AND 50). SN 77-237,838. PUB. 7-8-2008. FILED 7-24-2007.
 3,566,517. **WEB 'N' WALK BOX (BLOCK FORM)**. DEUTSCHE
 TELEKOM AG, (U.S. CLS. 2, 5, 22, 23, 29, 37, 38 AND 50). SN
 77-243,652. PUB. 3-4-2008. FILED 7-31-2007.
 3,566,543. **PASSAGEWORKS INSTITUTE (BLOCK FORM)**.
 PASSAGEWAYS INSTITUTE, INC., DBA PASSAGE-
 WORKS INSTITUTE, INC., (U.S. CLS. 2, 5, 22, 23, 29, 37,
 38 AND 50). SN 77-276,621. PUB. 11-11-2008. FILED 9-11-
 2007.
 3,566,546 (*See Class 8 for this trademark*).
 3,566,547. **IMAGES ON ICE (BLOCK FORM)**. HOCKEY HALL
 OF FAME AND MUSEUM, MULTIPLE CLASS, (INT. CLS.
 16 AND 41), (U.S. CLS. 2, 5, 22, 23, 29, 37, 38, 50, 100, 101
 AND 107). SN 77-282,341. PUB. 9-9-2008. FILED 9-18-2007.
 3,566,548. **PATRIX AND DESIGN**. EDMUNDS, GREGORY,
 DBA PRINCE YACONIAH, (U.S. CLS. 2, 5, 22, 23, 29, 37, 38
 AND 50). SN 77-282,928. PUB. 11-11-2008. FILED 9-18-2007.
 3,566,556. **WEB'N'WALK SURFER (BLOCK FORM)**.
 DEUTSCHE TELEKOM AG, (U.S. CLS. 2, 5, 22, 23, 29, 37,
 38 AND 50). SN 77-289,497. PUB. 6-10-2008. FILED 9-26-2007.
 3,566,557. **WEB'N'WALK STARTER (BLOCK FORM)**.
 DEUTSCHE TELEKOM AG, (U.S. CLS. 2, 5, 22, 23, 29, 37,
 38 AND 50). SN 77-290,618. PUB. 3-4-2008. FILED 9-27-2007.
 3,566,570. **JAZZWISE (BLOCK FORM)**. JAZZWISE PUBLICA-
 TIONS LIMITED, (U.S. CLS. 2, 5, 22, 23, 29, 37, 38 AND 50).
 SN 77-306,956. PUB. 11-11-2008. FILED 10-18-2007.
 3,566,591. **THE OLD FASHIONED BABY AND DESIGN**.
 BAUMEISTER, JEANNIE DOWNS, MULTIPLE CLASS,
 (INT. CLS. 16 AND 25), (U.S. CLS. 2, 5, 22, 23, 29, 37, 38, 39
 AND 50). SN 77-321,727. PUB. 11-11-2008. FILED 11-5-2007.
 3,566,631. **CANVAS HOME BASICS QUALITY. STYLE AND
 DESIGN**. CANVAS CORP LLC, MULTIPLE CLASS, (INT.
 CLS. 16 AND 18), (U.S. CLS. 1, 2, 3, 5, 22, 23, 29, 37, 38, 41
 AND 50). SN 77-334,192. PUB. 11-11-2008. FILED 11-20-2007.
 3,566,653. **THE URBAN MAN (BLOCK FORM)**. PORTER-
 ZASADA, MARC, MULTIPLE CLASS, (INT. CLS. 16 AND
 41), (U.S. CLS. 2, 5, 22, 23, 29, 37, 38, 50, 100, 101 AND 107).

- SN 77-342,276. PUB. 11-11-2008. FILED 12-3-2007.
- 3,566,699. **JUST PLAIN LOVE (BLOCK FORM)**. ATWATER, BARBARA BRENT, (U.S. CLS. 2, 5, 22, 23, 29, 37, 38 AND 50). SN 77-353,264. PUB. 11-11-2008. FILED 12-16-2007.
- 3,566,732. **THE PLAYGROUND GUIDE AND DESIGN**. AMY LAMPERTI, DBA THE PLAYGROUND GUIDE, (U.S. CLS. 2, 5, 22, 23, 29, 37, 38 AND 50). SN 77-363,277. PUB. 11-11-2008. FILED 1-3-2008.
- 3,566,747. **PRESCRIPTION PETS (BLOCK FORM)**. POLIAK-OFF, GARY A., (U.S. CLS. 2, 5, 22, 23, 29, 37, 38 AND 50). SN 77-368,555. PUB. 11-11-2008. FILED 1-10-2008.
- 3,566,756. **O AND DESIGN**. JEAN DODDS, (U.S. CLS. 2, 5, 22, 23, 29, 37, 38 AND 50). SN 77-374,211. PUB. 11-11-2008. FILED 1-17-2008.
- 3,566,761. **MEREDITH AVENGING ANGELS (BLOCK FORM)**. MEREDITH COLLEGE, (U.S. CLS. 2, 5, 22, 23, 29, 37, 38 AND 50). SN 77-379,583. PUB. 11-11-2008. FILED 1-24-2008.
- 3,566,778. **SHAKESPEARE IN BLOOD (BLOCK FORM)**. MCDONOUGH, BRIAN W., (U.S. CLS. 2, 5, 22, 23, 29, 37, 38 AND 50). SN 77-393,025. PUB. 11-11-2008. FILED 2-9-2008.
- 3,566,787. **THE VACATION DIET (BLOCK FORM)**. DANIEL LUX, (U.S. CLS. 2, 5, 22, 23, 29, 37, 38 AND 50). SN 77-396,343. PUB. 11-11-2008. FILED 2-13-2008.
- 3,566,840. **EXCEPTIONAL LIVING (BLOCK FORM)**. UBS CLEAN CARE, INC., (U.S. CLS. 2, 5, 22, 23, 29, 37, 38 AND 50). SN 77-434,459. PUB. 11-11-2008. FILED 3-28-2008.
- 3,566,851. **THE ART OF MICHAEL PARKES (BLOCK FORM)**. SWAN KING EDITIONS, LLC, (U.S. CLS. 2, 5, 22, 23, 29, 37, 38 AND 50). SN 77-440,629. PUB. 11-11-2008. FILED 4-4-2008.
- 3,566,854. **CLINICAL SIGNS (BLOCK FORM)**. ALCON RESEARCH, LTD., (U.S. CLS. 2, 5, 22, 23, 29, 37, 38 AND 50). SN 77-441,548. PUB. 11-11-2008. FILED 4-7-2008.
- 3,566,871. **TWISTED TAKES (BLOCK FORM)**. SORESENSEN, JEFFREY DEAN, (U.S. CLS. 2, 5, 22, 23, 29, 37, 38 AND 50). SN 77-448,641. PUB. 11-11-2008. FILED 4-15-2008.
- 3,566,890. **SHANAHEA (BLOCK FORM)**. BARTL-SCHÖLL, ANDREA, MULTIPLE CLASS, (INT. CLS. 16 AND 44), (U.S. CLS. 2, 5, 22, 23, 29, 37, 38, 50, 100 AND 101). SN 77-456,577. PUB. 11-11-2008. FILED 4-24-2008.
- 3,566,905. **YOUR MIDWEST DESTINATION MOINES (BLOCK FORM)**. CITY OF WEST DES MOINES, (U.S. CLS. 2, 5, 22, 23, 29, 37, 38 AND 50). SN 77-463,402. PUB. 11-11-2008. FILED 5-1-2008.
- 3,566,915. **EASYSPIPES (BLOCK FORM)**. ACCO BRANDS CORPORATION, (U.S. CLS. 2, 5, 22, 23, 29, 37, 38 AND 50). SN 77-467,247. PUB. 11-11-2008. FILED 5-6-2008.
- 3,566,916. **EASYSPIKE (BLOCK FORM)**. ACCO BRANDS CORPORATION, (U.S. CLS. 2, 5, 22, 23, 29, 37, 38 AND 50). SN 77-467,257. PUB. 11-11-2008. FILED 5-6-2008.
- 3,566,928. **THE FLUSHABLE BAG (BLOCK FORM)**. HOWELL KDS L.L.C., (U.S. CLS. 2, 5, 22, 23, 29, 37, 38 AND 50). SN 77-471,147. PUB. 11-11-2008. FILED 5-10-2008.
- 3,567,008 (*See Class 10 for this trademark*).
- 3,567,031. **ELECTRIC PINOY (BLOCK FORM)**. HAWAII GLOBAL EXCHANGE, INC., DBA PACIFIC TELECARD & WIRELESS, (U.S. CLS. 2, 5, 22, 23, 29, 37, 38 AND 50). SN 77-490,032. PUB. 11-11-2008. FILED 6-3-2008.
- 3,567,047 (*See Class 14 for this trademark*).
- 3,567,186. **SANDY SPRINGS GEORGIA AND DESIGN**. CITY OF SANDY SPRINGS, GEORGIA, MULTIPLE CLASS, (INT. CLS. 16, 35, 37, 41, 42 AND 45), (U.S. CLS. 2, 5, 22, 23, 29, 37, 38, 50, 100, 101, 102, 103, 106 AND 107). SN 77-499,485. PUB. 11-11-2008. FILED 6-16-2008.
- 3,567,200. **X-RAY BABIES AND DESIGN**. RHEA, MATTHEW, (U.S. CLS. 2, 5, 22, 23, 29, 37, 38 AND 50). SN 77-499,744. PUB. 11-11-2008. FILED 6-16-2008.
- 3,567,204. **OUTFIT YOUR MIND (BLOCK FORM)**. MORRIS BOOK PUBLISHING, LLC, (U.S. CLS. 2, 5, 22, 23, 29, 37, 38 AND 50). SN 77-499,793. PUB. 11-11-2008. FILED 6-16-2008.
- 3,567,218. **PILGRIM IMPORTS (BLOCK FORM)**. PILGRIM IMPORTS, INC., MULTIPLE CLASS, (INT. CLS. 16 AND 28), (U.S. CLS. 2, 5, 22, 23, 29, 37, 38 AND 50). SN 77-499,959. PUB. 11-11-2008. FILED 6-16-2008.
- 3,567,259. **CHILDREN'S BOOKS THAT ENGAGE, DELIGHT AND ENTERTAIN! (BLOCK FORM)**. SUMMERFIELD MEDIA GROUP LLC, DBA PLEASANT ST. PRESS, (U.S. CLS. 2, 5, 22, 23, 29, 37, 38 AND 50). SN 77-500,768. PUB. 11-11-2008. FILED 6-17-2008.
- 3,567,294. **BRAVE NEW GIRLS (BLOCK FORM)**. BRAVE NEW GIRLS LIMITED, LLC, (U.S. CLS. 2, 5, 22, 23, 29, 37, 38 AND 50). SN 77-501,276. PUB. 11-11-2008. FILED 6-17-2008.
- 3,567,338 (*See Class 9 for this trademark*).
- 3,567,340. **CONTRACT BLUE (BLOCK FORM)**. COLLEEN PALLADINI, (U.S. CLS. 2, 5, 22, 23, 29, 37, 38 AND 50). SN 77-501,904. PUB. 11-11-2008. FILED 6-18-2008.
- 3,567,358. **FOCUS ON THE FAMILY CLUBHOUSE JR. (BLOCK FORM)**. FOCUS ON THE FAMILY, (U.S. CLS. 2, 5, 22, 23, 29, 37, 38 AND 50). SN 77-502,145. PUB. 11-11-2008. FILED 6-18-2008.
- 3,567,395. **OWM (BLOCK FORM)**. HMP COMMUNICATIONS, LLC, (U.S. CLS. 2, 5, 22, 23, 29, 37, 38 AND 50). SN 77-502,750. PUB. 11-11-2008. FILED 6-19-2008.
- 3,567,408. **APPLICATOR (BLOCK FORM)**. SEALANT, WATERPROOFING & RESTORATION INSTITUTE, (U.S. CLS. 2, 5, 22, 23, 29, 37, 38 AND 50). SN 77-502,937. PUB. 11-11-2008. FILED 6-19-2008.
- 3,567,468. **THINK READING (BLOCK FORM)**. RALLY! EDUCATION, (U.S. CLS. 2, 5, 22, 23, 29, 37, 38 AND 50). SN 77-504,245. PUB. 11-11-2008. FILED 6-20-2008.
- 3,567,508. **CATCH HIS VIBES AND DESIGN**. MARTIN, BROOKS B., MULTIPLE CLASS, (INT. CLS. 16 AND 25), (U.S. CLS. 2, 5, 22, 23, 29, 37, 38, 39 AND 50). SN 77-505,127. PUB. 11-11-2008. FILED 6-23-2008.
- 3,567,509. **ACHIEVE YOUR READING GOAL (BLOCK FORM)**. RALLY! EDUCATION, MULTIPLE CLASS, (INT. CLS. 16 AND 41), (U.S. CLS. 2, 5, 22, 23, 29, 37, 38, 50, 100, 101 AND 107). SN 77-505,138. PUB. 11-11-2008. FILED 6-23-2008.
- 3,567,510. **LOGICRULES (BLOCK FORM)**. LOGICRULES, (U.S. CLS. 2, 5, 22, 23, 29, 37, 38 AND 50). SN 77-505,156. PUB. 11-11-2008. FILED 6-23-2008.
- 3,567,520. **THE SISTERHOOD OF QUILTERS (BLOCK FORM)**. JODY HOUGHTON DESIGNS, INC., (U.S. CLS. 2, 5, 22, 23, 29, 37, 38 AND 50). SN 77-505,317. PUB. 11-11-2008. FILED 6-23-2008.
- 3,567,523. **SCRAPBLOCK (BLOCK FORM)**. CORNISH HERITAGE FARMS LLC, DBA CORNISH HERITAGE FARMS, (U.S. CLS. 2, 5, 22, 23, 29, 37, 38 AND 50). SN 77-505,367. PUB. 11-11-2008. FILED 6-23-2008.
- 3,567,549. **SPELL-A-CADABRA (BLOCK FORM)**. KASPER, LESLIE, (U.S. CLS. 2, 5, 22, 23, 29, 37, 38 AND 50). SN 77-505,847. PUB. 11-11-2008. FILED 6-23-2008.
- 3,567,571. **INDIEBOUND (BLOCK FORM)**. AMERICAN BOOKSELLERS ASSOCIATION, INC., (U.S. CLS. 2, 5, 22, 23, 29, 37, 38 AND 50). SN 77-506,520. PUB. 11-11-2008. FILED 6-24-2008.
- 3,567,625. **FROM THE HEART (BLOCK FORM)**. MEREDITH CORPORATION, (U.S. CLS. 2, 5, 22, 23, 29, 37, 38 AND 50). SN 77-509,135. PUB. 11-11-2008. FILED 6-26-2008.
- 3,567,631. **MISCELLANEOUS DESIGN**. BROOKHAVEN RETREAT, LLC, (U.S. CLS. 2, 5, 22, 23, 29, 37, 38 AND 50). SN 77-510,621. PUB. 11-11-2008. FILED 6-28-2008.
- 3,567,666. **CNN (STYLIZED)**. CABLE NEWS NETWORK, INC., (U.S. CLS. 2, 5, 22, 23, 29, 37, 38 AND 50). SN 77-519,827. PUB. 11-11-2008. FILED 7-11-2008.
- 3,567,667 (*See Class 9 for this trademark*).
- 3,567,668 (*See Class 9 for this trademark*).
- 3,567,687. **KIDSBORO (BLOCK FORM)**. FOCUS ON THE FAMILY, (U.S. CLS. 2, 5, 22, 23, 29, 37, 38 AND 50). SN 77-526,117. PUB. 11-11-2008. FILED 7-18-2008.
- 3,567,689. **KNACK MAKE IT EASY AND DESIGN**. MORRIS BOOK PUBLISHING, LLC, (U.S. CLS. 2, 5, 22, 23, 29, 37, 38 AND 50). SN 77-527,871. PUB. 11-11-2008. FILED 7-22-2008.
- 3,567,745 (*See Class 9 for this trademark*).
- 3,567,749 (*See Class 2 for this trademark*).
- 3,567,752. **AMCB (BLOCK FORM)**. AMERICAN MIDWIFERY CERTIFICATION BOARD, MULTIPLE CLASS, (INT. CLS. 16, 35 AND 41), (U.S. CLS. 2, 5, 22, 23, 29, 37, 38, 50, 100, 101, 102 AND 107). SN 78-750,464. PUB. 11-11-2008. FILED 11-9-2005.
- 3,567,764. **G THE GREENBRIER MAGAZINE (BLOCK FORM)**. CSX 1A, INC., (U.S. CLS. 2, 5, 22, 23, 29, 37, 38 AND 50). SN 78-834,891. PUB. 11-11-2008. FILED 3-10-2006.
- 3,567,789. **DEAR (BLOCK FORM)**. VEER CORPORATION, (U.S. CLS. 2, 5, 22, 23, 29, 37, 38 AND 50). SN 78-961,700. PUB. 7-1-2008. FILED 8-28-2006.

3,567,808 (*See Class 14 for this trademark.*)
 3,567,810 (*See Class 7 for this trademark.*)
 3,567,829 (*See Class 9 for this trademark.*)
 3,567,831 (*See Class 3 for this trademark.*)
 3,567,833. **NAVITAS (BLOCK FORM)**. IBT EDUCATION LIMITED, MULTIPLE CLASS, (INT. CLS. 16, 35 AND 41), (U.S. CLS. 2, 5, 22, 23, 29, 37, 38, 50, 100, 101, 102 AND 107). SN 79-039,699. PUB. 11-11-2008. FILED 4-23-2007.
 3,567,880 (*See Class 9 for this trademark.*)
 3,567,892 (*See Class 9 for this trademark.*)
 3,567,904 (*See Class 9 for this trademark.*)
 3,567,928 (*See Class 5 for this trademark.*)
 3,567,943. **GO GREEN WITH ENVI AND DESIGN**. PAPER AUSTRALIA PTY LTD., (U.S. CLS. 2, 5, 22, 23, 29, 37, 38 AND 50). SN 79-051,774. PUB. 11-11-2008. FILED 1-22-2008.
 3,567,956 (*See Class 9 for this trademark.*)
 3,567,965. **BIOTAK AND DESIGN**. BERKSHIRE LABELS LTD., (U.S. CLS. 2, 5, 22, 23, 29, 37, 38 AND 50). SN 79-054,721. PUB. 11-11-2008. FILED 4-14-2008.
 3,567,975 (*See Class 1 for this trademark.*)

CLASS 17—RUBBER GOODS

3,566,440. **INFINITE OPTIKS DREAMS ON GLASS AND DESIGN**. THE FILM CREW, INC., (U.S. CLS. 1, 5, 12, 13, 35 AND 50). SN 77-142,397. PUB. 11-11-2008. FILED 3-28-2007.
 3,566,478. **ORANGE GUARD (BLOCK FORM)**. POLY-AMERICA, L.P., (U.S. CLS. 1, 5, 12, 13, 35 AND 50). SN 77-201,218. PUB. 11-11-2008. FILED 6-8-2007.
 3,566,670. **RUBAROC (BLOCK FORM)**. MEAKINGS, BARRY, MULTIPLE CLASS, (INT. CLS. 17 AND 37), (U.S. CLS. 1, 5, 12, 13, 35, 50, 100, 103 AND 106). SN 77-346,980. PUB. 11-11-2008. FILED 12-7-2007.
 3,566,689. **COBRA (BLOCK FORM)**. FUTURE PIPE INDUSTRIES, INC., MULTIPLE CLASS, (INT. CLS. 17 AND 19), (U.S. CLS. 1, 5, 12, 13, 33, 35 AND 50). SN 77-351,008. PUB. 11-11-2008. FILED 12-13-2007.
 3,566,691. **PYTHON (BLOCK FORM)**. FUTURE PIPE INDUSTRIES, INC., MULTIPLE CLASS, (INT. CLS. 17 AND 19), (U.S. CLS. 1, 5, 12, 13, 33, 35 AND 50). SN 77-351,115. PUB. 11-11-2008. FILED 12-13-2007.
 3,566,759 (*See Class 9 for this trademark.*)
 3,567,114. **INTEGRA FOAM (BLOCK FORM)**. INSULATION DISTRIBUTORS, INC., (U.S. CLS. 1, 5, 12, 13, 35 AND 50). SN 77-496,504. PUB. 11-11-2008. FILED 6-11-2008.
 3,567,117. **INTEGRA SEAL CW (BLOCK FORM)**. INSULATION DISTRIBUTORS, INC., (U.S. CLS. 1, 5, 12, 13, 35 AND 50). SN 77-496,522. PUB. 11-11-2008. FILED 6-11-2008.
 3,567,119. **INTEGRA SEAL (BLOCK FORM)**. INSULATION DISTRIBUTORS, INC., (U.S. CLS. 1, 5, 12, 13, 35 AND 50). SN 77-496,568. PUB. 11-11-2008. FILED 6-11-2008.
 3,567,122. **INTEGRA FILL (BLOCK FORM)**. INSULATION DISTRIBUTORS, INC., (U.S. CLS. 1, 5, 12, 13, 35 AND 50). SN 77-496,584. PUB. 11-11-2008. FILED 6-11-2008.
 3,567,199. **SOLAMATRIX (BLOCK FORM)**. SOLAMATRIX, INC., (U.S. CLS. 1, 5, 12, 13, 35 AND 50). SN 77-499,730. PUB. 11-11-2008. FILED 6-16-2008.
 3,567,664. **EVER BRIGHT (BLOCK FORM)**. HENKEL CORPORATION, (U.S. CLS. 1, 5, 12, 13, 35 AND 50). SN 77-519,740. PUB. 11-11-2008. FILED 7-11-2008.
 3,567,835. **KONTANGO AND DESIGN**. ODESA GELISTIRILMIS POLIMER; YATIRIMLARI VE DIS TICARET A.S., MULTIPLE CLASS, (INT. CLS. 17, 19, 20 AND 35), (U.S. CLS. 1, 2, 5, 12, 13, 22, 25, 32, 33, 35, 50, 100, 101 AND 102). SN 79-039,945. PUB. 11-11-2008. FILED 3-1-2006.
 3,567,854 (*See Class 6 for this trademark.*)
 3,567,857. **EQUATOR (STYLIZED)**. MANULI RUBBER INDUSTRIES S.P.A., (U.S. CLS. 1, 5, 12, 13, 35 AND 50). SN 79-045,635. PUB. 11-11-2008. FILED 9-26-2007.
 3,567,859 (*See Class 6 for this trademark.*)
 3,567,861 (*See Class 6 for this trademark.*)
 3,567,862. **DIAMOND SPIR AND DESIGN**. MANULI RUBBER INDUSTRIES S.P.A., (U.S. CLS. 1, 5, 12, 13, 35 AND 50). SN 79-045,854. PUB. 11-11-2008. FILED 10-8-2007.
 3,567,874 (*See Class 1 for this trademark.*)

3,567,906 (*See Class 9 for this trademark.*)
 3,567,915. **TUBETEX (BLOCK FORM)**. NORDITUBE TECHNOLOGIES SE, MULTIPLE CLASS, (INT. CLS. 17, 35 AND 37), (U.S. CLS. 1, 5, 12, 13, 35, 50, 100, 101, 102, 103 AND 106). SN 79-049,984. PUB. 11-11-2008. FILED 11-5-2007.

CLASS 18—LEATHER GOODS

3,566,254 (*See Class 12 for this trademark.*)
 3,566,255 (*See Class 12 for this trademark.*)
 3,566,262. **LOOP**. TRI-COASTAL DESIGN GROUP, INC., (U.S. CLS. 1, 2, 3, 22 AND 41). SN 76-519,651. PUB. 7-29-2008. FILED 5-20-2003.
 3,566,286 (*See Class 14 for this trademark.*)
 3,566,287. **ECO-FRIENDLY AND DESIGN**. DOSKOCIL MANUFACTURING COMPANY, INC., MULTIPLE CLASS, (INT. CLS. 18, 20 AND 21), (U.S. CLS. 1, 2, 3, 13, 22, 23, 25, 29, 30, 32, 33, 40, 41 AND 50). SN 76-680,971. PUB. 11-11-2008. FILED 8-21-2007.
 3,566,330 (*See Class 3 for this trademark.*)
 3,566,366. **SYNERJECTION (BLOCK FORM)**. ASOLO S.P.A., MULTIPLE CLASS, (INT. CLS. 18 AND 25), (U.S. CLS. 1, 2, 3, 22, 39 AND 41). SN 77-000,123. PUB. 4-15-2008. FILED 9-15-2006.
 3,566,376 (*See Class 5 for this trademark.*)
 3,566,411 (*See Class 16 for this trademark.*)
 3,566,444. **LOUIS VERSA U.S.A. AND DESIGN**. LOUIS DESIGNS USA LIMITED, (U.S. CLS. 1, 2, 3, 22 AND 41). SN 77-145,711. PUB. 11-11-2008. FILED 4-1-2007.
 3,566,456. **MEZON (BLOCK FORM)**. MEZON, INC., (U.S. CLS. 1, 2, 3, 22 AND 41). SN 77-164,626. PUB. 10-30-2007. FILED 4-24-2007.
 3,566,498. **ORTHO-WEDGE (BLOCK FORM)**. WESTERN LEGACY SALES, LLC, (U.S. CLS. 1, 2, 3, 22 AND 41). SN 77-222,932. PUB. 11-11-2008. FILED S.R. 7-5-2007; AM. P.R. 9-15-2008.
 3,566,575. **LA DIVA ITALIAN DESIGN (BLOCK FORM)**. PAPIILLON INTERNATIONAL INC., (U.S. CLS. 1, 2, 3, 22 AND 41). SN 77-312,463. PUB. 11-11-2008. FILED 10-24-2007.
 3,566,619. **HBF TEXTILES (BLOCK FORM)**. HICKORY BUSINESS FURNITURE LLC, MULTIPLE CLASS, (INT. CLS. 18 AND 24), (U.S. CLS. 1, 2, 3, 22, 41, 42 AND 50). SN 77-330,131. PUB. 11-11-2008. FILED 11-15-2007.
 3,566,620. **HBF TEXTILES AND DESIGN**. HICKORY BUSINESS FURNITURE LLC, MULTIPLE CLASS, (INT. CLS. 18 AND 24), (U.S. CLS. 1, 2, 3, 22, 41, 42 AND 50). SN 77-330,134. PUB. 11-11-2008. FILED 11-15-2007.
 3,566,623 (*See Class 9 for this trademark.*)
 3,566,631 (*See Class 16 for this trademark.*)
 3,566,638. **CG AND DESIGN**. CHEN, QIU, (U.S. CLS. 1, 2, 3, 22 AND 41). SN 77-338,357. PUB. 11-11-2008. FILED 11-27-2007.
 3,566,855. **ALEXANDRE BIRMAN (BLOCK FORM)**. SAP SCHUTZ ADVENTURE PRODUCTS INDUSTRIA E COMERCIO LTDA., MULTIPLE CLASS, (INT. CLS. 18, 25 AND 35), (U.S. CLS. 1, 2, 3, 22, 39, 41, 100, 101 AND 102). SN 77-442,355. PUB. 11-11-2008. FILED 4-8-2008.
 3,567,182. **MISCELLANEOUS DESIGN**. BARBERI, ELIZABETH H., (U.S. CLS. 1, 2, 3, 22 AND 41). SN 77-499,437. PUB. 11-11-2008. FILED 6-16-2008.
 3,567,247. **KNITIFORTHEROAD.COM KNIT-SHARE-GO! AND DESIGN**. NOCK, MARGARET, (U.S. CLS. 1, 2, 3, 22 AND 41). SN 77-500,547. PUB. 11-11-2008. FILED 6-17-2008.
 3,567,278. **MN (STYLIZED)**. MARY NICHOLS LLC, (U.S. CLS. 1, 2, 3, 22 AND 41). SN 77-501,014. PUB. 11-11-2008. FILED 6-17-2008.
 3,567,343. **ROOM.IT.UP (BLOCK FORM)**. PRIME SOURCE ACCESSORIES, LTD., MULTIPLE CLASS, (INT. CLS. 18 AND 21), (U.S. CLS. 1, 2, 3, 13, 22, 23, 29, 30, 33, 40, 41 AND 50). SN 77-501,954. PUB. 11-11-2008. FILED 6-18-2008.
 3,567,364. **EPASSPORT (BLOCK FORM)**. KENA KAI, INC., (U.S. CLS. 1, 2, 3, 22 AND 41). SN 77-502,246. PUB. 11-11-2008. FILED 6-18-2008.
 3,567,378. **ANDRE GARCIA (BLOCK FORM)**. ASH & BURN LLC, MULTIPLE CLASS, (INT. CLS. 18 AND 34), (U.S. CLS. 1, 2, 3, 8, 9, 17, 22 AND 41). SN 77-502,451. PUB. 11-11-2008. FILED 6-18-2008.

3,567,536. **NEW SKETE (BLOCK FORM)**. THE MONKS OF NEW SKETE, INC., MULTIPLE CLASS, (INT. CLS. 18 AND 25), (U.S. CLS. 1, 2, 3, 22, 39 AND 41). SN 77-505,603. PUB. 11-11-2008. FILED 6-23-2008.

3,567,675. **CM (STYLIZED)**. CLS, INC., (U.S. CLS. 1, 2, 3, 22 AND 41). SN 77-523,675. PUB. 11-11-2008. FILED 7-16-2008.

3,567,720. **TEAM 2008 (BLOCK FORM)**. UNITED STATES OLYMPIC COMMITTEE, MULTIPLE CLASS, (INT. CLS. 18 AND 25), (U.S. CLS. 1, 2, 3, 22, 39 AND 41). SN 77-569,788. PUB. 11-11-2008. FILED 9-15-2008.

3,567,749 (*See Class 2 for this trademark*).

3,567,798. **D310 PRODUCE BY DESCENTE (STYLIZED)**. DESCENTE, LTD., MULTIPLE CLASS, (INT. CLS. 18 AND 25), (U.S. CLS. 1, 2, 3, 22, 39 AND 41). SN 79-003,573. PUB. 10-21-2008. FILED 2-19-2004.

3,567,808 (*See Class 14 for this trademark*).

3,567,811. **BLUE POLLACK PETER BROWN YACHTING AND DESIGN**. RPB S.P.A., MULTIPLE CLASS, (INT. CLS. 18 AND 25), (U.S. CLS. 1, 2, 3, 22, 39 AND 41). SN 79-030,455. PUB. 11-11-2008. FILED 9-21-2006.

3,567,831 (*See Class 3 for this trademark*).

3,567,847 (*See Class 9 for this trademark*).

3,567,866 (*See Class 14 for this trademark*).

3,567,893. **DES PETITS HAUTS AND DESIGN**. SARL DES PETITS HAUTS, MULTIPLE CLASS, (INT. CLS. 18, 24 AND 25), (U.S. CLS. 1, 2, 3, 22, 39, 41, 42 AND 50). SN 79-048,914. PUB. 11-11-2008. FILED 11-13-2007.

3,567,904 (*See Class 9 for this trademark*).

3,567,912 (*See Class 3 for this trademark*).

3,567,918 (*See Class 14 for this trademark*).

3,567,920 (*See Class 14 for this trademark*).

3,567,940. **KELLY FLAT (BLOCK FORM)**. HERMES INTERNATIONAL, (U.S. CLS. 1, 2, 3, 22 AND 41). SN 79-051,575. PUB. 11-11-2008. FILED 8-24-2007.

3,567,947 (*See Class 14 for this trademark*).

3,567,970 (*See Class 3 for this trademark*).

CLASS 19—NON-METALLIC BUILDING MATERIALS

3,566,363. **FINISH WHITE (BLOCK FORM)**. BASEMENT TECHNOLOGIES, INC., (U.S. CLS. 1, 12, 33 AND 50). SN 76-691,640. PUB. 11-11-2008. FILED 7-28-2008.

3,566,689 (*See Class 17 for this trademark*).

3,566,691 (*See Class 17 for this trademark*).

3,566,898. **FLO-GRID (BLOCK FORM)**. ASTRAL PROPERTY PTY LIMITED, (U.S. CLS. 1, 12, 33 AND 50). SN 77-460,207. PUB. 11-11-2008. FILED 4-29-2008.

3,566,966. **WWW.GROUNDTOPPER.COM (BLOCK FORM)**. GRASS ACT, INC., (U.S. CLS. 1, 12, 33 AND 50). SN 77-482,386. PUB. 11-11-2008. FILED 5-23-2008.

3,566,968 (*See Class 1 for this trademark*).

3,567,018. **TUFFY CO'S SQUARZ IT [LEADING THE WAY AROUND] AND DESIGN**. TUFFY COMPANY, (U.S. CLS. 1, 12, 33 AND 50). SN 77-488,223. PUB. 11-11-2008. FILED 6-1-2008.

3,567,173. **THE LOOK OF LUXURY (BLOCK FORM)**. THE MURANO GROUP, INC., (U.S. CLS. 1, 12, 33 AND 50). SN 77-498,769. PUB. 11-11-2008. FILED 6-13-2008.

3,567,190. **WALPOLE WOODWORKERS (BLOCK FORM)**. WALPOLE WOODWORKERS, INC., MULTIPLE CLASS, (INT. CLS. 19, 20, 21, 35 AND 37), (U.S. CLS. 1, 2, 12, 13, 22, 23, 25, 29, 30, 32, 33, 40, 50, 100, 101, 102, 103 AND 106). SN 77-499,580. PUB. 11-11-2008. FILED 6-16-2008.

3,567,192. **WALPOLE WOODWORKERS (BLOCK FORM)**. WALPOLE WOODWORKERS, INC., (U.S. CLS. 1, 12, 33 AND 50). SN 77-499,583. PUB. 11-11-2008. FILED 6-16-2008.

3,567,327. **MAGSOL (BLOCK FORM)**. MAGNESITAS NAVARRAS S.A., (U.S. CLS. 1, 12, 33 AND 50). SN 77-501,757. PUB. 11-11-2008. FILED 6-18-2008.

3,567,330. **AGLUMAG (BLOCK FORM)**. MAGNESITAS NAVARRAS S.A., (U.S. CLS. 1, 12, 33 AND 50). SN 77-501,774. PUB. 11-11-2008. FILED 6-18-2008.

3,567,332. **IMPACT (BLOCK FORM)**. MAGNESITAS NAVARRAS S.A., (U.S. CLS. 1, 12, 33 AND 50). SN 77-501,789. PUB. 11-11-2008. FILED 6-18-2008.

3,567,337. **DYNAPRINT (BLOCK FORM)**. R.I. LAMPUS COMPANY, (U.S. CLS. 1, 12, 33 AND 50). SN 77-501,884. PUB. 11-11-2008. FILED 6-18-2008.

3,567,552 (*See Class 9 for this trademark*).

3,567,563. **TRU-CORE (BLOCK FORM)**. KOP-COAT, INC., (U.S. CLS. 1, 12, 33 AND 50). SN 77-506,243. PUB. 11-11-2008. FILED 6-24-2008.

3,567,813. **R RHEINGOLD TREPPENSTUFENELEMENTE (STYLIZED)**. KLAUS D. ZENKNER, (U.S. CLS. 1, 12, 33 AND 50). SN 79-032,503. PUB. 11-11-2008. FILED 6-23-2006.

3,567,817. **YF AND DESIGN**. NANPING YANFA BAMBOO & WOODEN; PRODUCTS LTD, (U.S. CLS. 1, 12, 33 AND 50). SN 79-034,283. PUB. 11-11-2008. FILED 12-29-2006.

3,567,835 (*See Class 17 for this trademark*).

3,567,874 (*See Class 1 for this trademark*).

3,567,928 (*See Class 5 for this trademark*).

3,567,933 (*See Class 1 for this trademark*).

3,567,934 (*See Class 1 for this trademark*).

3,567,935 (*See Class 1 for this trademark*).

3,567,936 (*See Class 1 for this trademark*).

CLASS 20—FURNITURE AND ARTICLES NOT OTHERWISE CLASSIFIED

3,566,267 (*See Class 9 for this trademark*).

3,566,268 (*See Class 9 for this trademark*).

3,566,287 (*See Class 18 for this trademark*).

3,566,373. **THE BIG ONE (BLOCK FORM)**. KOHL'S ILLINOIS, INC., (U.S. CLS. 2, 13, 22, 25, 32 AND 50). SN 77-020,014. PUB. 11-11-2008. FILED 10-12-2006.

3,566,423 (*See Class 8 for this trademark*).

3,566,431 (*See Class 6 for this trademark*).

3,566,432 (*See Class 6 for this trademark*).

3,566,493. **KONSTANT (BLOCK FORM)**. THE ECONO-RACK GROUP INC., (U.S. CLS. 2, 13, 22, 25, 32 AND 50). SN 77-219,155. PUB. 4-29-2008. FILED 6-29-2007.

3,566,540. **JUICE PACK (BLOCK FORM)**. JUICE TYME, INC., (U.S. CLS. 2, 13, 22, 25, 32 AND 50). SN 77-272,285. PUB. 11-11-2008. FILED 9-5-2007.

3,566,660. **AFTON SCIENTIFIC (BLOCK FORM)**. AFTON SCIENTIFIC CORPORATION, MULTIPLE CLASS, (INT. CLS. 20, 40 AND 42), (U.S. CLS. 2, 13, 22, 25, 32, 50, 100, 101, 103 AND 106). SN 77-343,253. PUB. 11-11-2008. FILED 12-4-2007.

3,566,668 (*See Class 6 for this trademark*).

3,566,769. **DESIGN RECIPES (STYLIZED)**. APHEREA, INC., MULTIPLE CLASS, (INT. CLS. 20 AND 24), (U.S. CLS. 2, 13, 22, 25, 32, 42 AND 50). SN 77-385,364. PUB. 11-11-2008. FILED 1-31-2008.

3,566,811. **JESSICA MCCLINTOCK HOME (BLOCK FORM)**. JESSICA MCCLINTOCK, INC., MULTIPLE CLASS, (INT. CLS. 20 AND 21), (U.S. CLS. 2, 13, 22, 23, 25, 29, 30, 32, 33, 40 AND 50). SN 77-413,013. PUB. 11-11-2008. FILED 3-4-2008.

3,567,004 (*See Class 12 for this trademark*).

3,567,046. **WHEN THE GOING GETS TOUGH, THE TOUGH PUT A LID ON IT (BLOCK FORM)**. HEAVY COVER, INC., (U.S. CLS. 2, 13, 22, 25, 32 AND 50). SN 77-491,204. PUB. 11-11-2008. FILED 6-4-2008.

3,567,047 (*See Class 14 for this trademark*).

3,567,050. **MILLION DOLLAR BABY EXCLUSIVELY YOURS AND DESIGN**. BEXCO ENTERPRISES, INC., (U.S. CLS. 2, 13, 22, 25, 32 AND 50). SN 77-491,731. PUB. 11-11-2008. FILED 6-5-2008.

3,567,058. **K9ASTLE (BLOCK FORM)**. THE BARN YARD, (U.S. CLS. 2, 13, 22, 25, 32 AND 50). SN 77-492,518. PUB. 11-11-2008. FILED 6-6-2008.

3,567,081. **POLYBRITE (BLOCK FORM)**. PALMER SNYDER FURNITURE COMPANY, (U.S. CLS. 2, 13, 22, 25, 32 AND 50). SN 77-494,268. PUB. 11-11-2008. FILED 6-9-2008.

3,567,097. **TRU-TRAC (BLOCK FORM)**. KNAPE & VOGT MANUFACTURING COMPANY, (U.S. CLS. 2, 13, 22, 25, 32 AND 50). SN 77-494,942. PUB. 11-11-2008. FILED 6-10-2008.

3,567,190 (*See Class 19 for this trademark*).

3,567,207. **PREMIERCOMFORT (BLOCK FORM)**. PALMER SNYDER FURNITURE COMPANY, (U.S. CLS. 2, 13, 22, 25, 32 AND 50). SN 77-499,846. PUB. 11-11-2008. FILED 6-16-

2008.
 3,567,316. **MACRAE (BLOCK FORM)**. MACRAE DESIGNS, INC., (U.S. CLS. 2, 13, 22, 25, 32 AND 50). SN 77-501,495. PUB. 11-11-2008. FILED 6-18-2008.
 3,567,372. **E-Z CREASE (BLOCK FORM)**. HLP CLEAR PACKAGING PRODUCTS (USA), INC., (U.S. CLS. 2, 13, 22, 25, 32 AND 50). SN 77-502,382. PUB. 11-11-2008. FILED 6-18-2008.
 3,567,403. **FITZYOURPET (BLOCK FORM)**. ASA ENTERPRISES, LLC, (U.S. CLS. 2, 13, 22, 25, 32 AND 50). SN 77-502,853. PUB. 11-11-2008. FILED 6-19-2008.
 3,567,434. **HL P AND DESIGN**. HLP CLEAR PACKAGING PRODUCTS (U.S.A.), INC., (U.S. CLS. 2, 13, 22, 25, 32 AND 50). SN 77-503,419. PUB. 11-11-2008. FILED 6-19-2008.
 3,567,499. **MISCELLANEOUS DESIGN**. JENKINS, JIM, (U.S. CLS. 2, 13, 22, 25, 32 AND 50). SN 77-504,842. PUB. 11-11-2008. FILED 6-21-2008.
 3,567,572. **MISCELLANEOUS DESIGN**. ERGOMOTION, INC., (U.S. CLS. 2, 13, 22, 25, 32 AND 50). SN 77-506,544. PUB. 11-11-2008. FILED 6-24-2008.
 3,567,703. **THE COMFORTPILLOW BY TEMPUR-PEDIC (BLOCK FORM)**. DAN-FOAM APS, (U.S. CLS. 2, 13, 22, 25, 32 AND 50). SN 77-538,966. PUB. 11-11-2008. FILED 8-5-2008.
 3,567,704. **THE GRANDBED BY TEMPUR-PEDIC (BLOCK FORM)**. DAN-FOAM APS, (U.S. CLS. 2, 13, 22, 25, 32 AND 50). SN 77-538,967. PUB. 11-11-2008. FILED 8-5-2008.
 3,567,705. **THE GRANDPILLOW BY TEMPUR-PEDIC (BLOCK FORM)**. DAN-FOAM APS, (U.S. CLS. 2, 13, 22, 25, 32 AND 50). SN 77-538,973. PUB. 11-11-2008. FILED 8-5-2008.
 3,567,706. **THE RHAPSODYPILLOW BY TEMPUR-PEDIC (BLOCK FORM)**. DAN-FOAM APS, (U.S. CLS. 2, 13, 22, 25, 32 AND 50). SN 77-538,976. PUB. 11-11-2008. FILED 8-5-2008.
 3,567,749 (*See Class 2 for this trademark*).
 3,567,835 (*See Class 17 for this trademark*).
 3,567,851 (*See Class 6 for this trademark*).
 3,567,856 (*See Class 11 for this trademark*).
 3,567,890. **T5 AND DESIGN**. TONNELLERIE TARANSAUD & CIE, (U.S. CLS. 2, 13, 22, 25, 32 AND 50). SN 79-048,781. PUB. 11-11-2008. FILED 11-23-2007.
 3,567,901. **DOODLE (BLOCK FORM)**. SILVER CROSS HOLDINGS LIMITED, (U.S. CLS. 2, 13, 22, 25, 32 AND 50). SN 79-049,267. PUB. 11-11-2008. FILED 11-29-2007.
 3,567,914 (*See Class 6 for this trademark*).
 3,567,928 (*See Class 5 for this trademark*).
 3,567,949 (*See Class 5 for this trademark*).
 3,567,984. **MISCELLANEOUS DESIGN**. ANJI LIANFENG FURNITURE CO., LTD., (U.S. CLS. 2, 13, 22, 25, 32 AND 50). SN 79-057,058. PUB. 11-11-2008. FILED 6-10-2008.

CLASS 21—HOUSEWARES AND GLASS

3,566,267 (*See Class 9 for this trademark*).
 3,566,268 (*See Class 9 for this trademark*).
 3,566,287 (*See Class 18 for this trademark*).
 3,566,381 (*See Class 10 for this trademark*).
 3,566,403 (*See Class 6 for this trademark*).
 3,566,521. **EARTH (BLOCK FORM)**. EARTH CHEMICAL COMPANY LIMITED, (U.S. CLS. 2, 13, 23, 29, 30, 33, 40 AND 50). SN 77-254,019. PUB. 4-8-2008. FILED 8-13-2007.
 3,566,784. **ULTIMAX THE ULTIMATE FEEDER AND DESIGN**. PITTENGER, LARRY, AND PITTENGER, KELLY, (U.S. CLS. 2, 13, 23, 29, 30, 33, 40 AND 50). SN 77-395,719. PUB. 11-11-2008. FILED 2-13-2008.
 3,566,807. **WEANING TO TRAINING (BLOCK FORM)**. BROTHER MAX LIMITED, (U.S. CLS. 2, 13, 23, 29, 30, 33, 40 AND 50). SN 77-410,960. PUB. 11-11-2008. FILED 3-3-2008.
 3,566,811 (*See Class 20 for this trademark*).
 3,566,843. **EARRINGMASTER (BLOCK FORM)**. EARRINGMASTER, INC., (U.S. CLS. 2, 13, 23, 29, 30, 33, 40 AND 50). SN 77-437,448. PUB. 11-11-2008. FILED 4-2-2008.
 3,566,847 (*See Class 8 for this trademark*).
 3,567,039. **BROADWAY COFFEE & TEA COMPANY (STYLIZED)**. BARNIE'S II, INC., (U.S. CLS. 2, 13, 23, 29, 30, 33, 40

AND 50). SN 77-490,678. PUB. 11-11-2008. FILED 6-4-2008.
 3,567,072. **PUP-HEAD (BLOCK FORM)**. PUPGEAR CORPORATION, (U.S. CLS. 2, 13, 23, 29, 30, 33, 40 AND 50). SN 77-493,340. PUB. 11-11-2008. FILED 6-6-2008.
 3,567,190 (*See Class 19 for this trademark*).
 3,567,272. **WINE ROC (BLOCK FORM)**. FAR BEYOND WOODWORKING, INC., (U.S. CLS. 2, 13, 23, 29, 30, 33, 40 AND 50). SN 77-500,892. PUB. 11-11-2008. FILED 6-17-2008.
 3,567,343 (*See Class 18 for this trademark*).
 3,567,354. **NEWARE AND DESIGN**. NEWELL IMPORT CORP., (U.S. CLS. 2, 13, 23, 29, 30, 33, 40 AND 50). SN 77-502,089. PUB. 11-11-2008. FILED 6-18-2008.
 3,567,427. **ECOUSABLE (BLOCK FORM)**. ECOUSABLE, INC., (U.S. CLS. 2, 13, 23, 29, 30, 33, 40 AND 50). SN 77-503,313. PUB. 11-11-2008. FILED 6-19-2008.
 3,567,621. **AJ'S BEETLE EATER (BLOCK FORM)**. KENNEDY, ANTHONY JOSEPH, (U.S. CLS. 2, 13, 23, 29, 30, 33, 40 AND 50). SN 77-508,487. PUB. 11-11-2008. FILED 6-26-2008.
 3,567,695. **CREATE MY OWN AND DESIGN**. PLAYTEX PRODUCTS, INC., (U.S. CLS. 2, 13, 23, 29, 30, 33, 40 AND 50). SN 77-532,847. PUB. 11-11-2008. FILED 7-28-2008.
 3,567,715. **KYOTO ENVIRONMENTAL ECO SAVVY MADE FROM PLANTS (BLOCK FORM)**. OSIRIS INC., (U.S. CLS. 2, 13, 23, 29, 30, 33, 40 AND 50). SN 77-546,014. PUB. 11-11-2008. FILED 8-13-2008.
 3,567,749 (*See Class 2 for this trademark*).
 3,567,784 (*See Class 3 for this trademark*).
 3,567,808 (*See Class 14 for this trademark*).
 3,567,856 (*See Class 11 for this trademark*).
 3,567,920 (*See Class 14 for this trademark*).
 3,567,928 (*See Class 5 for this trademark*).
 3,567,949 (*See Class 5 for this trademark*).

CLASS 22—CORDAGE AND FIBERS

3,567,458. **WILD HORSE (BLOCK FORM)**. COHEN, DONALD M., (U.S. CLS. 1, 2, 7, 19, 22, 42 AND 50). SN 77-503,855. PUB. 11-11-2008. FILED 6-20-2008.
 3,567,792. **SELECT (BLOCK FORM)**. SHAW INDUSTRIES GROUP, INC., (U.S. CLS. 1, 2, 7, 19, 22, 42 AND 50). SN 78-972,448. PUB. 11-11-2008. FILED 9-12-2006.
 3,567,933 (*See Class 1 for this trademark*).
 3,567,934 (*See Class 1 for this trademark*).
 3,567,935 (*See Class 1 for this trademark*).
 3,567,936 (*See Class 1 for this trademark*).

CLASS 23—YARNS AND THREADS

3,567,628. **SIERRA (BLOCK FORM)**. CASCADE YARNS, INC., (U.S. CL. 43). SN 77-510,220. PUB. 11-11-2008. FILED 6-27-2008.
 3,567,933 (*See Class 1 for this trademark*).
 3,567,934 (*See Class 1 for this trademark*).
 3,567,935 (*See Class 1 for this trademark*).
 3,567,936 (*See Class 1 for this trademark*).
 3,567,973. **MISCELLANEOUS DESIGN**. J. & P. COATS, LIMITED, (U.S. CL. 43). SN 79-055,393. PUB. 11-11-2008. FILED 6-7-2008.

CLASS 24—FABRICS

3,566,350. **HOMESTUFFINGS (BLOCK FORM)**. QUAKER LORRAINE HOLDINGS, LLC, (U.S. CLS. 42 AND 50). SN 76-690,616. PUB. 11-11-2008. FILED 6-17-2008.
 3,566,502. **BERANGERE (BLOCK FORM)**. REDCATS, MULTIPLE CLASS, (INT. CLS. 24 AND 25), (U.S. CLS. 22, 39, 42 AND 50). SN 77-226,233. PUB. 4-22-2008. FILED 7-10-2007.
 3,566,619 (*See Class 18 for this trademark*).
 3,566,620 (*See Class 18 for this trademark*).
 3,566,651. **PET SENSE (BLOCK FORM)**. EQUINE VENTURES, L.L.C., (U.S. CLS. 42 AND 50). SN 77-341,495.

PUB. 11-11-2008. FILED 11-30-2007.
 3,566,769 (*See Class 20 for this trademark*).
 3,566,934. **COSY COMFORT (BLOCK FORM)**. YOGO IM-
 PORTS LTD., (U.S. CLS. 42 AND 50). SN 77-473,690. PUB.
 11-11-2008. FILED 5-13-2008.
 3,567,055. **SUPERTEC (BLOCK FORM)**. NORTHPOINT
 TRADING, INC., (U.S. CLS. 42 AND 50). SN 77-492,240.
 PUB. 11-11-2008. FILED 6-5-2008.
 3,567,074. **MANGO HOME (BLOCK FORM)**. MANGO IM-
 PORTS, INC., (U.S. CLS. 42 AND 50). SN 77-493,379. PUB.
 11-11-2008. FILED 6-6-2008.
 3,567,319. **PREDATOR CAMOUFLAGE (BLOCK FORM)**.
 WFJM ENTERPRISES, INC., MULTIPLE CLASS, (INT.
 CLS. 24 AND 25), (U.S. CLS. 22, 39, 42 AND 50). SN 77-
 501,573. PUB. 11-11-2008. FILED 6-18-2008.
 3,567,749 (*See Class 2 for this trademark*).
 3,567,885. **NEO-CONCEPT (STYLIZED)**. NEO-CONCEPT
 (HOLDINGS) CO. LTD, MULTIPLE CLASS, (INT. CLS.
 24, 25 AND 42), (U.S. CLS. 22, 39, 42, 50, 100 AND 101). SN
 79-048,266. PUB. 11-11-2008. FILED 12-6-2007.
 3,567,893 (*See Class 18 for this trademark*).
 3,567,904 (*See Class 9 for this trademark*).
 3,567,906 (*See Class 9 for this trademark*).
 3,567,912 (*See Class 3 for this trademark*).
 3,567,933 (*See Class 1 for this trademark*).
 3,567,934 (*See Class 1 for this trademark*).
 3,567,935 (*See Class 1 for this trademark*).
 3,567,936 (*See Class 1 for this trademark*).
 3,567,956 (*See Class 9 for this trademark*).

CLASS 25—CLOTHING

3,566,254 (*See Class 12 for this trademark*).
 3,566,255 (*See Class 12 for this trademark*).
 3,566,266. **MOCEAN (BLOCK FORM)**. CROSSPORT MO-
 CEAN, (U.S. CLS. 22 AND 39). SN 76-616,462. PUB. 11-11-
 2008. FILED 10-13-2004.
 3,566,267 (*See Class 9 for this trademark*).
 3,566,268 (*See Class 9 for this trademark*).
 3,566,284. **MISCELLANEOUS DESIGN**. RODERICK,
 BRANDE, MULTIPLE CLASS, (INT. CLS. 25 AND 35),
 (U.S. CLS. 22, 39, 100, 101 AND 102). SN 76-678,893. PUB. 11-
 11-2008. FILED 6-29-2007.
 3,566,286 (*See Class 14 for this trademark*).
 3,566,307. **MISCELLANEOUS DESIGN**. FRUMTHA, INC.,
 (U.S. CLS. 22 AND 39). SN 76-685,571. PUB. 11-11-2008.
 FILED 1-7-2008.
 3,566,311. **CLAY. (BLOCK FORM)**. CLAY, WILLIE, (U.S. CLS.
 22 AND 39). SN 76-686,602. PUB. 11-11-2008. FILED 2-7-2008.
 3,566,356. **MISCELLANEOUS DESIGN**. PUR PREMIUM
 DENIM, INC., (U.S. CLS. 22 AND 39). SN 76-690,745. PUB.
 11-11-2008. FILED 6-23-2008.
 3,566,366 (*See Class 18 for this trademark*).
 3,566,385. **LILLIE & COHOE (BLOCK FORM)**. COHOE, LIZ,
 (U.S. CLS. 22 AND 39). SN 77-048,995. PUB. 11-11-2008.
 FILED 11-21-2006.
 3,566,386. **LILLIE & COHOE AND DESIGN**. COHOE, LIZ,
 (U.S. CLS. 22 AND 39). SN 77-049,050. PUB. 11-11-2008.
 FILED 11-21-2006.
 3,566,411 (*See Class 16 for this trademark*).
 3,566,416. **BURNETIE (STYLIZED)**. WEN FEN, CHIANG,
 (U.S. CLS. 22 AND 39). SN 77-096,141. PUB. 11-11-2008.
 FILED 1-31-2007.
 3,566,417. **MISCELLANEOUS DESIGN**. WEN FEN, CHIANG,
 (U.S. CLS. 22 AND 39). SN 77-096,142. PUB. 11-11-2008.
 FILED 1-31-2007.
 3,566,418. **BURNETIE (BLOCK FORM)**. WEN FEN, CHIANG,
 (U.S. CLS. 22 AND 39). SN 77-096,147. PUB. 11-11-2008.
 FILED 1-31-2007.
 3,566,441 (*See Class 10 for this trademark*).
 3,566,445 (*See Class 16 for this trademark*).
 3,566,447. **NEW GLARUS BREWING CO. UFF-DA AND
 DESIGN**. NEW GLARUS BREWING COMPANY, MULTI-
 PLE CLASS, (INT. CLS. 25 AND 32), (U.S. CLS. 22, 39, 45, 46
 AND 48). SN 77-149,629. PUB. 11-11-2008. FILED 4-5-2007.
 3,566,448. **NEW YORK INCORPORATORS (BLOCK FORM)**.

BLACK FIVES, INC., (U.S. CLS. 22 AND 39). SN 77-151,379.
 PUB. 11-11-2008. FILED 4-8-2007.
 3,566,462 (*See Class 16 for this trademark*).
 3,566,467. **COLLEGE DROPOUT (BLOCK FORM)**. COLLEGE
 DROPOUT, (U.S. CLS. 22 AND 39). SN 77-186,545. PUB. 11-
 11-2008. FILED 5-21-2007.
 3,566,485. **MAGAS STRESSFREE C.N.M.I. COMPANY AND
 DESIGN**. CABRERA, FRANCISCO DLG, (U.S. CLS. 22
 AND 39). SN 77-210,306. PUB. 11-11-2008. FILED 6-20-2007.
 3,566,502 (*See Class 24 for this trademark*).
 3,566,503. **TRIBOTONIC (BLOCK FORM)**. REDCATS, (U.S.
 CLS. 22 AND 39). SN 77-226,240. PUB. 4-22-2008. FILED 7-
 10-2007.
 3,566,504 (*See Class 16 for this trademark*).
 3,566,553. **RAIL RAT (BLOCK FORM)**. WATSON, JR. JAMES
 H., (U.S. CLS. 22 AND 39). SN 77-286,954. PUB. 3-11-2008.
 FILED 9-24-2007.
 3,566,576. **L.L. COLLEZIONI ITALIA (BLOCK FORM)**. S.
 ROTHSCHILD & CO., INC., (U.S. CLS. 22 AND 39). SN 77-
 313,260. PUB. 11-11-2008. FILED 10-25-2007.
 3,566,583. **S AND DESIGN**. STRADA SHOE LIMITADA, (U.S.
 CLS. 22 AND 39). SN 77-316,749. PUB. 11-11-2008. FILED 10-
 30-2007.
 3,566,591 (*See Class 16 for this trademark*).
 3,566,624. **PF AND DESIGN**. PFIP, LLC, MULTIPLE CLASS,
 (INT. CLS. 25 AND 41), (U.S. CLS. 22, 39, 100, 101 AND 107).
 SN 77-331,757. PUB. 11-11-2008. FILED 11-16-2007.
 3,566,625. **PF PLANET FITNESS AND DESIGN**. PFIP, LLC,
 MULTIPLE CLASS, (INT. CLS. 25 AND 41), (U.S. CLS. 22,
 39, 100, 101 AND 107). SN 77-331,789. PUB. 11-11-2008.
 FILED 11-16-2007.
 3,566,626. **PF PLANET FITNESS AND DESIGN**. PFIP, LLC,
 MULTIPLE CLASS, (INT. CLS. 25 AND 41), (U.S. CLS. 22,
 39, 100, 101 AND 107). SN 77-331,824. PUB. 11-11-2008.
 FILED 11-16-2007.
 3,566,630. **JERSERÛT (STYLIZED)**. ELIZABETH BRADBER-
 RY, LLC, DBA JERSERUT GAMEDAY CHIC, (U.S. CLS. 22
 AND 39). SN 77-333,867. PUB. 11-11-2008. FILED 11-20-2007.
 3,566,655 (*See Class 9 for this trademark*).
 3,566,659. **COMPETITION PROVEN CP (STYLIZED)**. HOL-
 MAN & MOODY, INC., MULTIPLE CLASS, (INT. CLS. 25
 AND 28), (U.S. CLS. 22, 23, 38, 39 AND 50). SN 77-343,180.
 PUB. 11-11-2008. FILED 12-4-2007.
 3,566,662. **ROBEEZ (BLOCK FORM)**. STRIDE RITE CANADA
 LIMITED, (U.S. CLS. 22 AND 39). SN 77-344,759. PUB. 11-
 11-2008. FILED 12-5-2007.
 3,566,672. **CASIEN (BLOCK FORM)**. CASIMIR A. SWINGER,
 M.D., (U.S. CLS. 22 AND 39). SN 77-347,466. PUB. 11-11-
 2008. FILED 12-8-2007.
 3,566,673. **[2 ONE 5] AND DESIGN**. ZONE5 LLC, (U.S. CLS. 22
 AND 39). SN 77-347,581. PUB. 11-11-2008. FILED 12-9-2007.
 3,566,696. **SOUTH POINT (BLOCK FORM)**. JANTZEN APPA-
 REL, LLC, (U.S. CLS. 22 AND 39). SN 77-352,309. PUB. 11-
 11-2008. FILED 12-14-2007.
 3,566,737. **RULED BY SPEED (BLOCK FORM)**. TYE SAUN-
 DERS, (U.S. CLS. 22 AND 39). SN 77-365,529. PUB. 11-11-
 2008. FILED 1-7-2008.
 3,566,740. **MEREDITH AVENGING ANGELS (BLOCK FORM)**.
 MEREDITH COLLEGE, (U.S. CLS. 22 AND 39). SN 77-
 366,825. PUB. 11-11-2008. FILED 1-8-2008.
 3,566,744. **3:16 AND DESIGN**. GIFFIN, PHILIP G., (U.S. CLS.
 22 AND 39). SN 77-367,149. PUB. 11-11-2008. FILED 1-9-2008.
 3,566,762. **MEREDITH COLLEGE (BLOCK FORM)**. MERE-
 DITH COLLEGE, (U.S. CLS. 22 AND 39). SN 77-379,586.
 PUB. 11-11-2008. FILED 1-24-2008.
 3,566,772. **SHOW NO L VE AND DESIGN**. KAPLAN, LINDA
 A., (U.S. CLS. 22 AND 39). SN 77-387,397. PUB. 11-11-2008.
 FILED 2-4-2008.
 3,566,774. **RAJESH PRATAP SINGH (STYLIZED)**. SINGH,
 RAJESH PRATAP, (U.S. CLS. 22 AND 39). SN 77-388,802.
 PUB. 11-11-2008. FILED 2-5-2008.
 3,566,782. **DEEPLY ROOTED (BLOCK FORM)**. DEEPLY
 ROOTED, LLC, (U.S. CLS. 22 AND 39). SN 77-394,294.
 PUB. 11-11-2008. FILED 2-11-2008.
 3,566,793. **PAIGE (STYLIZED)**. PREMIUM DENIM, LLC,
 (U.S. CLS. 22 AND 39). SN 77-401,849. PUB. 11-11-2008.
 FILED 2-20-2008.
 3,566,808. **SPHERIX (BLOCK FORM)**. BOULDER APPAREL

- LIMITED, (U.S. CLS. 22 AND 39), SN 77-412,525. PUB. 11-11-2008. FILED 3-4-2008.
- 3,566,812. **STACY ADAMS (BLOCK FORM)**. WEYCO GROUP, INC., (U.S. CLS. 22 AND 39). SN 77-413,795. PUB. 11-11-2008. FILED 3-5-2008.
- 3,566,826. **SHINING SHAKTI TREE-HUGGING FABULOUS AND DESIGN**. SHINING SHAKTI, (U.S. CLS. 22 AND 39). SN 77-424,361. PUB. 11-11-2008. FILED 3-17-2008.
- 3,566,827. **IS LIFE. (BLOCK FORM)**. COLLEGEWARE, U.S.A., INC., (U.S. CLS. 22 AND 39). SN 77-424,749. PUB. 11-11-2008. FILED 3-18-2008.
- 3,566,828. **DAM (BLOCK FORM)**. DAM SPORT, LLC, (U.S. CLS. 22 AND 39). SN 77-424,847. PUB. 11-11-2008. FILED 3-18-2008.
- 3,566,830. **UA BASE (STYLIZED)**. UNDER ARMOUR, INC., (U.S. CLS. 22 AND 39). SN 77-428,099. PUB. 11-11-2008. FILED 3-21-2008.
- 3,566,850. **STINKWEAR (BLOCK FORM)**. MCALLISTER, DONNA C., DBA STINKWEAR, (U.S. CLS. 22 AND 39). SN 77-440,586. PUB. 11-11-2008. FILED 4-4-2008.
- 3,566,855 (*See Class 18 for this trademark*).
- 3,566,870. **UMSTEIGEN (BLOCK FORM)**. SCHUBERT, SUSANNE F., DBA UMSTEIGEN, (U.S. CLS. 22 AND 39). SN 77-447,579. PUB. 11-11-2008. FILED 4-14-2008.
- 3,566,886. **BLINDSIGHT AND DESIGN**. BLINDSIGHT CLOTHING, (U.S. CLS. 22 AND 39). SN 77-455,253. PUB. 11-11-2008. FILED 4-22-2008.
- 3,566,893. **VOSGES (BLOCK FORM)**. VOSGES, LTD., MULTIPLE CLASS, (INT. CLS. 25, 30 AND 41), (U.S. CLS. 22, 39, 46, 100, 101 AND 107). SN 77-457,696. PUB. 11-11-2008. FILED 4-25-2008.
- 3,566,936. **DISCUSS DESIGN DELIVER AND DESIGN**. A & M CONSULTING SERVICES, INC., DBA SOX IN A BOX, (U.S. CLS. 22 AND 39). SN 77-474,498. PUB. 11-11-2008. FILED 5-14-2008.
- 3,566,937. **ISOCOMFY (STYLIZED)**. KRAUTNER, MARIA, DBA KRAUTNER CREATIONS, (U.S. CLS. 22 AND 39). SN 77-475,342. PUB. 11-11-2008. FILED 5-15-2008.
- 3,566,974. **PROUD WORKING MOMMY (BLOCK FORM)**. HORNBY, AMY, (U.S. CLS. 22 AND 39). SN 77-483,281. PUB. 11-11-2008. FILED 5-25-2008.
- 3,566,980. **MISCELLANEOUS DESIGN**. PEORIA CHIEFS COMMUNITY BASEBALL CLUB LLC, (U.S. CLS. 22 AND 39). SN 77-483,842. PUB. 11-11-2008. FILED 5-27-2008.
- 3,566,991. **MISCELLANEOUS DESIGN**. JEANS AND A TEE, LLC, (U.S. CLS. 22 AND 39). SN 77-485,498. PUB. 11-11-2008. FILED 5-28-2008.
- 3,566,996. **PH PLANET HOLLYWOOD AND DESIGN**. PLANET HOLLYWOOD (REGION IV), INC., MULTIPLE CLASS, (INT. CLS. 25, 41 AND 43), (U.S. CLS. 22, 39, 100, 101 AND 107). SN 77-486,355. PUB. 11-11-2008. FILED 5-29-2008.
- 3,567,008 (*See Class 10 for this trademark*).
- 3,567,035. **MARIA JUANA (BLOCK FORM)**. COY JR., ARTHUR, (U.S. CLS. 22 AND 39). SN 77-490,509. PUB. 11-11-2008. FILED 6-4-2008.
- 3,567,052. **RAMAIR (BLOCK FORM)**. KADENA INDUSTRIES, LTD., (U.S. CLS. 22 AND 39). SN 77-491,863. PUB. 11-11-2008. FILED 6-5-2008.
- 3,567,064. **HAPPY ELEPHANT (BLOCK FORM)**. TAKES 2 ENTERPRISES, INC., DBA HAPPY ELEPHANT THAI CUISINE, MULTIPLE CLASS, (INT. CLS. 25 AND 43), (U.S. CLS. 22, 39, 100 AND 101). SN 77-493,007. PUB. 11-11-2008. FILED 6-6-2008.
- 3,567,069. **HAPPY ELEPHANT THAI CUISINE AND DESIGN**. TAKES 2 ENTERPRISES, INC., DBA HAPPY ELEPHANT THAI CUISINE, MULTIPLE CLASS, (INT. CLS. 25 AND 43), (U.S. CLS. 22, 39, 100 AND 101). SN 77-493,181. PUB. 11-11-2008. FILED 6-6-2008.
- 3,567,129. **JOLIKAT (BLOCK FORM)**. BONNIE FOLEY DBA VIZCAYA, (U.S. CLS. 22 AND 39). SN 77-496,762. PUB. 11-11-2008. FILED 6-11-2008.
- 3,567,147. **D COLLECTION AND DESIGN**. D.E.S. STUDIO INC., (U.S. CLS. 22 AND 39). SN 77-497,540. PUB. 11-11-2008. FILED 6-12-2008.
- 3,567,155. **STANDARD SUPPLY (BLOCK FORM)**. BRAD RAMBO & ASSOCIATES, INC., (U.S. CLS. 22 AND 39). SN 77-498,025. PUB. 11-11-2008. FILED 6-12-2008.
- 3,567,156. **F AND DESIGN**. FONETIC DESIGN, (U.S. CLS. 22 AND 39). SN 77-498,051. PUB. 11-11-2008. FILED 6-13-2008.
- 3,567,174. **EAST LION (BLOCK FORM)**. EAST LION CORPORATION, (U.S. CLS. 22 AND 39). SN 77-498,934. PUB. 11-11-2008. FILED 6-13-2008.
- 3,567,175. **LIVE TO STAND UP PADDLE SURF (BLOCK FORM)**. PHIL MUSUMECI AND BARNEY LANGNER, JR., (U.S. CLS. 22 AND 39). SN 77-499,029. PUB. 11-11-2008. FILED 6-13-2008.
- 3,567,178. **UNIQUELY SQUEAKY AND DESIGN**. WILSON, DINA, (U.S. CLS. 22 AND 39). SN 77-499,211. PUB. 11-11-2008. FILED 6-14-2008.
- 3,567,202. **SLIMPERFECT (BLOCK FORM)**. CASEY KURUTZ, (U.S. CLS. 22 AND 39). SN 77-499,764. PUB. 11-11-2008. FILED 6-16-2008.
- 3,567,203. **S P AND DESIGN**. CASEY KURUTZ, (U.S. CLS. 22 AND 39). SN 77-499,786. PUB. 11-11-2008. FILED 6-16-2008.
- 3,567,230. **L VINGER AND DESIGN**. WIN CHOICE AMERICA, INC., (U.S. CLS. 22 AND 39). SN 77-500,294. PUB. 11-11-2008. FILED 6-16-2008.
- 3,567,268. **YPRETTY (STYLIZED)**. WIN CHOICE AMERICA, INC., (U.S. CLS. 22 AND 39). SN 77-500,852. PUB. 11-11-2008. FILED 6-17-2008.
- 3,567,277. **CLOOCHIE (STYLIZED)**. COLLINS, PAMELA, (U.S. CLS. 22 AND 39). SN 77-501,009. PUB. 11-11-2008. FILED 6-17-2008.
- 3,567,281. **TRY CHANGE AND DESIGN**. TRY CHANGE LLC, (U.S. CLS. 22 AND 39). SN 77-501,048. PUB. 11-11-2008. FILED 6-17-2008.
- 3,567,295. **BRAVE NEW GIRLS (BLOCK FORM)**. BRAVE NEW GIRLS LIMITED, LLC, (U.S. CLS. 22 AND 39). SN 77-501,279. PUB. 11-11-2008. FILED 6-17-2008.
- 3,567,299. **PROPER ETIQUETTE (BLOCK FORM)**. ROBIN REED TABANA, (U.S. CLS. 22 AND 39). SN 77-501,300. PUB. 11-11-2008. FILED 6-17-2008.
- 3,567,304. **KB (STYLIZED)**. ROBINSON, RHASIAH J., (U.S. CLS. 22 AND 39). SN 77-501,361. PUB. 11-11-2008. FILED 6-18-2008.
- 3,567,319 (*See Class 24 for this trademark*).
- 3,567,328. **FULL TILT (BLOCK FORM)**. WORLD OF JEANS & TOPS, INC., (U.S. CLS. 22 AND 39). SN 77-501,760. PUB. 11-11-2008. FILED 6-18-2008.
- 3,567,353. **DECEPTION CAMOUFLAGE (BLOCK FORM)**. WFJM ENTERPRISES, INC., (U.S. CLS. 22 AND 39). SN 77-502,064. PUB. 11-11-2008. FILED 6-18-2008.
- 3,567,357. **THIRD DAY (BLOCK FORM)**. THIRD DAY, INC., (U.S. CLS. 22 AND 39). SN 77-502,144. PUB. 11-11-2008. FILED 6-18-2008.
- 3,567,365. **PIASAA (BLOCK FORM)**. PIASAA USA LLC., (U.S. CLS. 22 AND 39). SN 77-502,247. PUB. 11-11-2008. FILED 6-18-2008.
- 3,567,397. **DAYLA BAY (BLOCK FORM)**. HARDMAN, DAVID, (U.S. CLS. 22 AND 39). SN 77-502,788. PUB. 11-11-2008. FILED 6-19-2008.
- 3,567,402. **LERARIO BEATRIZ (BLOCK FORM)**. L.B. CONFECIONES E COMERCIO DE ROUPAS LTDA, (U.S. CLS. 22 AND 39). SN 77-502,850. PUB. 11-11-2008. FILED 6-19-2008.
- 3,567,414 (*See Class 14 for this trademark*).
- 3,567,422. **FLEET BOUTIQUE (BLOCK FORM)**. FLEET WHOLESALE SUPPLY CO., INC., (U.S. CLS. 22 AND 39). SN 77-503,118. PUB. 11-11-2008. FILED 6-19-2008.
- 3,567,433. **GINDY LAURA (BLOCK FORM)**. VITAL MILLENNIUM, CORP., (U.S. CLS. 22 AND 39). SN 77-503,372. PUB. 11-11-2008. FILED 6-19-2008.
- 3,567,446. **CONTROVERSYSELLS (BLOCK FORM)**. CONTROVERSY SELLS INC., (U.S. CLS. 22 AND 39). SN 77-503,556. PUB. 11-11-2008. FILED 6-19-2008.
- 3,567,449 (*See Class 14 for this trademark*).
- 3,567,487. **TT (STYLIZED)**. TIFFANY SAIDNIA, (U.S. CLS. 22 AND 39). SN 77-504,669. PUB. 11-11-2008. FILED 6-20-2008.
- 3,567,489. **MISCELLANEOUS DESIGN**. KIANOSH, MIRKIA, (U.S. CLS. 22 AND 39). SN 77-504,730. PUB. 11-11-2008. FILED 6-20-2008.
- 3,567,490. **LIVE TO GOLF GOLF TO LIVE (BLOCK FORM)**. PHIL MUSUMECI AND BARRY LANGNER JR., (U.S. CLS. 22 AND 39). SN 77-504,756. PUB. 11-11-2008. FILED 6-21-2008.

3,567,491. **LIVE TO KAYAK KAYAK TO LIVE (BLOCK FORM)**. PHIL MUSUMECI AND BARNEY LANGNER, JR., (U.S. CLS. 22 AND 39). SN 77-504,764. PUB. 11-11-2008. FILED 6-21-2008.

3,567,494. **LIVE TO KICK KICK TO LIVE (BLOCK FORM)**. PHIL MUSUMECI AND BARNEY LANGNER, JR., (U.S. CLS. 22 AND 39). SN 77-504,805. PUB. 11-11-2008. FILED 6-21-2008.

3,567,505. **TRIGIRL (BLOCK FORM)**. GRANDISON BURN-SIDE, (U.S. CLS. 22 AND 39). SN 77-504,994. PUB. 11-11-2008. FILED 6-22-2008.

3,567,508 (*See Class 16 for this trademark*).

3,567,511. **HOTSEXYFIT (BLOCK FORM)**. HOTSEXYFIT, (U.S. CLS. 22 AND 39). SN 77-505,166. PUB. 11-11-2008. FILED 6-23-2008.

3,567,515. **POLKALOCA (BLOCK FORM)**. POLKALOCA, INC., (U.S. CLS. 22 AND 39). SN 77-505,239. PUB. 11-11-2008. FILED 6-23-2008.

3,567,518. **ATTACK YOUR PASSION (BLOCK FORM)**. BULLSEYE BRANDING, LLC, (U.S. CLS. 22 AND 39). SN 77-505,296. PUB. 11-11-2008. FILED 6-23-2008.

3,567,525. **VH2 (STYLIZED)**. HUANG, HUA. (U.S. CLS. 22 AND 39). SN 77-505,392. PUB. 11-11-2008. FILED 6-23-2008.

3,567,536 (*See Class 18 for this trademark*).

3,567,542. **MISCELLANEOUS DESIGN**. INTEGRITY PRODUCTS OF SARASOTA, INC., (U.S. CLS. 22 AND 39). SN 77-505,691. PUB. 11-11-2008. FILED 6-23-2008.

3,567,565. **INDIEBOUND (BLOCK FORM)**. AMERICAN BOOKSELLERS ASSOCIATION, INC., (U.S. CLS. 22 AND 39). SN 77-506,348. PUB. 11-11-2008. FILED 6-24-2008.

3,567,580. **ONE PEOPLE PROJECT (STYLIZED)**. ONE PEOPLE PROJECT, LLC, (U.S. CLS. 22 AND 39). SN 77-506,728. PUB. 11-11-2008. FILED 6-24-2008.

3,567,642. **GRETTA AND DESIGN**. GRETTA ENTERPRISES, LLC, (U.S. CLS. 22 AND 39). SN 77-512,421. PUB. 11-11-2008. FILED 7-1-2008.

3,567,654. **LIVE TO SWIM SWIM TO LIVE (BLOCK FORM)**. PHIL MUSUMECI AND BARNEY LANGNER, JR., (U.S. CLS. 22 AND 39). SN 77-517,565. PUB. 11-11-2008. FILED 7-9-2008.

3,567,655. **LIVE TO RACE RACE TO LIVE (BLOCK FORM)**. PHIL MUSUMECI AND BARNEY LANGNER, JR., (U.S. CLS. 22 AND 39). SN 77-518,400. PUB. 11-11-2008. FILED 7-9-2008.

3,567,656. **LIVE TO SKI SKI TO LIVE (BLOCK FORM)**. PHIL MUSUMECI AND BARRY LANGNER, JR., (U.S. CLS. 22 AND 39). SN 77-518,449. PUB. 11-11-2008. FILED 7-9-2008.

3,567,658. **WAR ON HUNGER AND DESIGN**. AUBURN UNIVERSITY, MULTIPLE CLASS, (INT. CLS. 25, 30, 35 AND 41), (U.S. CLS. 22, 39, 46, 100, 101, 102 AND 107). SN 77-518,626. PUB. 11-11-2008. FILED 7-10-2008.

3,567,680. **ART IN THE AGE OF MECHANICAL REPRODUCTION (BLOCK FORM)**. GYRO ADVERTISING, INC., MULTIPLE CLASS, (INT. CLS. 25 AND 35), (U.S. CLS. 22, 39, 100, 101 AND 102). SN 77-524,708. PUB. 11-11-2008. FILED 7-17-2008.

3,567,688. **LIVE TO FIGHT FIGHT TO LIVE (BLOCK FORM)**. PHIL MUSUMECI AND BARNEY LANGNER JR., (U.S. CLS. 22 AND 39). SN 77-526,398. PUB. 11-11-2008. FILED 7-18-2008.

3,567,691. **FAMOUS FACES (BLOCK FORM)**. RUBIE'S COSTUME CO., INC., (U.S. CLS. 22 AND 39). SN 77-529,508. PUB. 11-11-2008. FILED 7-23-2008.

3,567,720 (*See Class 18 for this trademark*).

3,567,745 (*See Class 9 for this trademark*).

3,567,749 (*See Class 2 for this trademark*).

3,567,761. **DEEP DYE (BLOCK FORM)**. PEI LICENSING, INC., (U.S. CLS. 22 AND 39). SN 78-806,806. PUB. 11-11-2008. FILED 2-3-2006.

3,567,783. **MIRRACO (BLOCK FORM)**. MIRRACO L.L.C., (U.S. CLS. 22 AND 39). SN 78-958,306. PUB. 11-11-2008. FILED 8-23-2006.

3,567,790. **SKINNY DIP SWIMWEAR AND DESIGN**. CAMM T, INC., DBA SKINNY DIP, (U.S. CLS. 22 AND 39). SN 78-969,477. PUB. 11-11-2008. FILED 9-7-2006.

3,567,798 (*See Class 18 for this trademark*).

3,567,806 (*See Class 9 for this trademark*).

3,567,808 (*See Class 14 for this trademark*).

3,567,811 (*See Class 18 for this trademark*).

3,567,847 (*See Class 9 for this trademark*).

3,567,853. **EMILIO PUCCI FIRENZE AND DESIGN**. EMILIO PUCCI INTERNATIONAL BV, (U.S. CLS. 22 AND 39). SN 79-044,868. PUB. 11-11-2008. FILED 8-20-2007.

3,567,865. **KIKS TYO AND DESIGN**. KIKS JAPAN CO., LTD, (U.S. CLS. 22 AND 39). SN 79-046,276. PUB. 11-11-2008. FILED 11-2-2007.

3,567,866 (*See Class 14 for this trademark*).

3,567,881 (*See Class 12 for this trademark*).

3,567,885 (*See Class 24 for this trademark*).

3,567,886. **NOIR KENNEDY (BLOCK FORM)**. NOIR KENNEDY, AND NOIR KENNEDY, (U.S. CLS. 22 AND 39). SN 79-048,359. PUB. 11-11-2008. FILED 12-12-2007.

3,567,888. **CAMPIONISSIMO (BLOCK FORM)**. MAIER, ANTON, (U.S. CLS. 22 AND 39). SN 79-048,665. PUB. 11-11-2008. FILED 11-27-2007.

3,567,893 (*See Class 18 for this trademark*).

3,567,904 (*See Class 9 for this trademark*).

3,567,912 (*See Class 3 for this trademark*).

3,567,918 (*See Class 14 for this trademark*).

3,567,920 (*See Class 14 for this trademark*).

3,567,945 (*See Class 9 for this trademark*).

3,567,947 (*See Class 14 for this trademark*).

3,567,956 (*See Class 9 for this trademark*).

3,567,960. **SMART QUILL (BLOCK FORM)**. PUMA AKTIENGESELLSCHAFT; RUDOLF DASSLER SPORT, (U.S. CLS. 22 AND 39). SN 79-054,091. PUB. 11-11-2008. FILED 9-20-2007.

3,567,970 (*See Class 3 for this trademark*).

3,567,971. **DEAD SERIOUS (BLOCK FORM)**. STEVEN J CAUCHI, (U.S. CLS. 22 AND 39). SN 79-055,228. PUB. 11-11-2008. FILED 4-23-2008.

CLASS 26—FANCY GOODS

3,566,993. **ONE STEP AND DESIGN**. THE HAIR SHOP INC., (U.S. CLS. 37, 39, 40, 42 AND 50). SN 77-485,622. PUB. 11-11-2008. FILED 5-28-2008.

3,567,179. **JL (BLOCK FORM)**. ALLSTATE FLORAL & CRAFT, INC., (U.S. CLS. 37, 39, 40, 42 AND 50). SN 77-499,226. PUB. 11-11-2008. FILED 6-14-2008.

3,567,749 (*See Class 2 for this trademark*).

3,567,906 (*See Class 9 for this trademark*).

3,567,920 (*See Class 14 for this trademark*).

CLASS 27—FLOOR COVERINGS

3,566,272. **THUHR 2-4 4 2 RAK'AH'S FAJR 2 2 RAK'AH'S ISHA 2 4 1 RAK'AH'S MAGRIB 3 2 RAK'AH'S ASR 2 4 RAK'AH'S AND DESIGN**. SHAHEED, ABDUL A., (U.S. CLS. 19, 20, 37, 42 AND 50). SN 76-668,150. PUB. 11-11-2008. FILED 10-26-2006.

3,566,367 (*See Class 12 for this trademark*).

3,566,967. **UNITED MAT (BLOCK FORM)**. CONSOLIDATED PLASTICS COMPANY, INC., (U.S. CLS. 19, 20, 37, 42 AND 50). SN 77-482,500. PUB. 11-11-2008. FILED 5-23-2008.

3,567,020. **NUTEK FLOORING (BLOCK FORM)**. GREATMATS.COM, (U.S. CLS. 19, 20, 37, 42 AND 50). SN 77-488,366. PUB. 11-11-2008. FILED 6-2-2008.

3,567,405. **ENVIROMAT (BLOCK FORM)**. INTERNATIONAL ENVIROGUARD SYSTEMS, INC., (U.S. CLS. 19, 20, 37, 42 AND 50). SN 77-502,874. PUB. 11-11-2008. FILED 6-19-2008.

3,567,749 (*See Class 2 for this trademark*).

3,567,837. **A ALTRO AND DESIGN**. ALTRO LIMITED, (U.S. CLS. 19, 20, 37, 42 AND 50). SN 79-040,165. PUB. 11-11-2008. FILED 12-22-2006.

CLASS 28—TOYS AND SPORTING GOODS

3,566,256. **ZANY ZOOMERS**. ROSS ACQUISITIONS, INC.,

- DBA THE JELLY BEAN FACTORY, (U.S. CLS. 22, 23, 38 AND 50). SN 76-216,602. PUB. 11-11-2008. FILED 2-27-2001. 3,566,267 (*See Class 9 for this trademark*).
- 3,566,268 (*See Class 9 for this trademark*).
- 3,566,290. **GRAMMIE'S GOOFS (BLOCK FORM)**, KINDRED HANDS, LLC, (U.S. CLS. 22, 23, 38 AND 50). SN 76-683,186. PUB. 11-11-2008. FILED 10-22-2007.
- 3,566,294. **GEESE II MOTION (BLOCK FORM)**, DECOY MOTION MASTERS, (U.S. CLS. 22, 23, 38 AND 50). SN 76-683,808. PUB. 11-11-2008. FILED 11-8-2007.
- 3,566,367 (*See Class 12 for this trademark*).
- 3,566,445 (*See Class 16 for this trademark*).
- 3,566,476. **HURRICANE KATRINA THE GAME THE GOVERNMENT PLAYED (BLOCK FORM)**, LYONS, WENDY K., AND LYONS, CURTIS B., (U.S. CLS. 22, 23, 38 AND 50). SN 77-199,714. PUB. 11-11-2008. FILED 6-6-2007.
- 3,566,499. **BREAK THE CURSE (BLOCK FORM)**, BREAK THE CURSE KIT, INC., (U.S. CLS. 22, 23, 38 AND 50). SN 77-223,828. PUB. 3-25-2008. FILED 7-6-2007.
- 3,566,659 (*See Class 25 for this trademark*).
- 3,566,674. **DOUBLE BULL (BLOCK FORM)**, PRIMOS, INC., (U.S. CLS. 22, 23, 38 AND 50). SN 77-347,988. PUB. 11-11-2008. FILED 12-10-2007.
- 3,566,676. **TWIRLING TANYA (BLOCK FORM)**, MATTEL, INC., (U.S. CLS. 22, 23, 38 AND 50). SN 77-348,385. PUB. 11-11-2008. FILED 12-10-2007.
- 3,566,860. **BIG Z SPORTS (BLOCK FORM)**, BIG Z SPORTS, LLC, (U.S. CLS. 22, 23, 38 AND 50). SN 77-445,120. PUB. 11-11-2008. FILED 4-10-2008.
- 3,566,902. **MISCELLANEOUS DESIGN**, THE TRIZM PUZZLE COMPANY, LLC, MULTIPLE CLASS, (INT. CLS. 28 AND 41), (U.S. CLS. 22, 23, 38, 50, 100, 101 AND 107). SN 77-462,667. PUB. 11-11-2008. FILED 5-1-2008.
- 3,566,922. **KARIBBEAN KIDS (BLOCK FORM)**, GEORGE, MARY, (U.S. CLS. 22, 23, 38 AND 50). SN 77-469,789. PUB. 11-11-2008. FILED 5-8-2008.
- 3,566,931. **ICE CUBE (BLOCK FORM)**, WES MICKLE, (U.S. CLS. 22, 23, 38 AND 50). SN 77-471,692. PUB. 11-11-2008. FILED 5-12-2008.
- 3,566,997. **ADORABLE GIRL (BLOCK FORM)**, ADORABLE ORIGINALS, INC., (U.S. CLS. 22, 23, 38 AND 50). SN 77-486,407. PUB. 11-11-2008. FILED 5-29-2008.
- 3,567,000. **QT QUIKTRAX AND DESIGN**, QUIK TRAX, LLC, (U.S. CLS. 22, 23, 38 AND 50). SN 77-486,504. PUB. 11-11-2008. FILED 5-29-2008.
- 3,567,138. **SPEEDSAC AND DESIGN**, ALL SPORTS CONDITIONING, INC., (U.S. CLS. 22, 23, 38 AND 50). SN 77-497,121. PUB. 11-11-2008. FILED 6-12-2008.
- 3,567,168. **EZTEC (BLOCK FORM)**, SCIENTIFIC TOYS, LTD., (U.S. CLS. 22, 23, 38 AND 50). SN 77-498,466. PUB. 11-11-2008. FILED 6-13-2008.
- 3,567,218 (*See Class 16 for this trademark*).
- 3,567,264 (*See Class 10 for this trademark*).
- 3,567,310. **CHIPS (BLOCK FORM)**, JAX, LTD., INC., (U.S. CLS. 22, 23, 38 AND 50). SN 77-501,465. PUB. 11-11-2008. FILED 6-18-2008.
- 3,567,381. **THE PARTICLE ZOO (BLOCK FORM)**, PEASLEY, JULIE R., (U.S. CLS. 22, 23, 38 AND 50). SN 77-502,498. PUB. 11-11-2008. FILED 6-19-2008.
- 3,567,575. **A YO I AND DESIGN**, KIM, FRANCESCO, (U.S. CLS. 22, 23, 38 AND 50). SN 77-506,675. PUB. 11-11-2008. FILED 6-24-2008.
- 3,567,602. **MISCELLANEOUS DESIGN**, VISIONWORKS, L.L.C., (U.S. CLS. 22, 23, 38 AND 50). SN 77-507,162. PUB. 11-11-2008. FILED 6-24-2008.
- 3,567,603. **FF AND DESIGN**, VISIONWORKS, L.L.C., (U.S. CLS. 22, 23, 38 AND 50). SN 77-507,188. PUB. 11-11-2008. FILED 6-24-2008.
- 3,567,605. **MISCELLANEOUS DESIGN**, VISIONWORKS, L.L.C., (U.S. CLS. 22, 23, 38 AND 50). SN 77-507,201. PUB. 11-11-2008. FILED 6-24-2008.
- 3,567,608. **MISCELLANEOUS DESIGN**, VISIONWORKS, L.L.C., (U.S. CLS. 22, 23, 38 AND 50). SN 77-507,253. PUB. 11-11-2008. FILED 6-24-2008.
- 3,567,609. **MISCELLANEOUS DESIGN**, VISIONWORKS, L.L.C., (U.S. CLS. 22, 23, 38 AND 50). SN 77-507,256. PUB. 11-11-2008. FILED 6-24-2008.
- 3,567,611. **MISCELLANEOUS DESIGN**, VISIONWORKS, L.L.C., (U.S. CLS. 22, 23, 38 AND 50). SN 77-507,263. PUB. 11-11-2008. FILED 6-25-2008.
- 3,567,612. **MISCELLANEOUS DESIGN**, VISIONWORKS, L.L.C., (U.S. CLS. 22, 23, 38 AND 50). SN 77-507,265. PUB. 11-11-2008. FILED 6-25-2008.
- 3,567,663. **AMERICA'S FIRST BASEBALL COMPANY (BLOCK FORM)**, RUSSELL CORPORATION, (U.S. CLS. 22, 23, 38 AND 50). SN 77-519,337. PUB. 11-11-2008. FILED 7-10-2008.
- 3,567,670. **TGOL (BLOCK FORM)**, JOHNSON, MELISSA, (U.S. CLS. 22, 23, 38 AND 50). SN 77-520,833. PUB. 11-11-2008. FILED 7-12-2008.
- 3,567,671. **MJ (BLOCK FORM)**, JOHNSON, MELISSA, (U.S. CLS. 22, 23, 38 AND 50). SN 77-520,873. PUB. 11-11-2008. FILED 7-13-2008.
- 3,567,694. **SPALDING ROOKIE GEAR RG (STYLIZED)**, RUSSELL CORPORATION, (U.S. CLS. 22, 23, 38 AND 50). SN 77-531,866. PUB. 11-11-2008. FILED 7-25-2008.
- 3,567,716. **POWERMAX (BLOCK FORM)**, DICK'S SPORTING GOODS, INC., (U.S. CLS. 22, 23, 38 AND 50). SN 77-546,864. PUB. 11-11-2008. FILED 8-14-2008.
- 3,567,719. **ZABEAR (BLOCK FORM)**, ZABAR'S & CO., INC., (U.S. CLS. 22, 23, 38 AND 50). SN 77-552,775. PUB. 11-11-2008. FILED 8-21-2008.
- 3,567,780. **EVOLUTION (BLOCK FORM)**, WILSON SPORTING GOODS CO., (U.S. CLS. 22, 23, 38 AND 50). SN 78-947,317. PUB. 11-11-2008. FILED 8-8-2006.
- 3,567,781. **I-GAMI (BLOCK FORM)**, HOLSCOE PRECISION TOOLING INC., (U.S. CLS. 22, 23, 38 AND 50). SN 78-952,618. PUB. 2-19-2008. FILED 8-15-2006.
- 3,567,791 (*See Class 13 for this trademark*).
- 3,567,801. **DOMINO 4 AND DESIGN**, MONNET GILLES, (U.S. CLS. 22, 23, 38 AND 50). SN 79-020,155. PUB. 11-11-2008. FILED 12-2-2005.
- 3,567,831 (*See Class 3 for this trademark*).
- 3,567,904 (*See Class 9 for this trademark*).
- 3,567,956 (*See Class 9 for this trademark*).

CLASS 29—MEATS AND PROCESSED FOODS

- 3,566,346. **GARNI (BLOCK FORM)**, KRADJIAN IMPORTING CO., INC., (U.S. CL. 46). SN 76-690,365. PUB. 11-11-2008. FILED 6-9-2008.
- 3,566,471. **PRIMESELECTIONS (BLOCK FORM)**, F.W. BRYCE, INC., (U.S. CL. 46). SN 77-192,911. PUB. 11-11-2008. FILED 5-30-2007.
- 3,566,490. **BONNO AND DESIGN**, FRIESLAND BRANDS BV, (U.S. CL. 46). SN 77-214,660. PUB. 11-11-2008. FILED 6-25-2007.
- 3,566,533. **LEE IACOCCA'S (BLOCK FORM)**, IACOCCA, LEE, (U.S. CL. 46). SN 77-265,573. PUB. 11-11-2008. FILED 8-27-2007.
- 3,566,581. **SOVRANO (BLOCK FORM)**, MAUER S.A.S. DI FABIO POZZALI & C., (U.S. CL. 46). SN 77-316,120. PUB. 11-11-2008. FILED 10-29-2007.
- 3,566,584. **GRASKAAS (BLOCK FORM)**, COÖPERATIEVE ZUIVELONDERNEMING CONO B.A., (U.S. CL. 46). SN 77-316,986. PUB. 11-11-2008. FILED 10-30-2007.
- 3,566,675. **SUNDAY HOMESTYLE CHICKEN (BLOCK FORM)**, CBOCS PROPERTIES, INC., MULTIPLE CLASS, (INT. CLS. 29 AND 43), (U.S. CLS. 46, 100 AND 101). SN 77-348,059. PUB. 11-11-2008. FILED 12-10-2007.
- 3,566,738. **LINCET DIDIER LINCET AND DESIGN**, FROMAGERIE LINCET, (U.S. CL. 46). SN 77-366,693. PUB. 11-11-2008. FILED 1-8-2008.
- 3,566,739. **BRILLAT-SAVARIN LINCET DIDIER LINCET AND DESIGN**, FROMAGERIE LINCET, (U.S. CL. 46). SN 77-366,776. PUB. 11-11-2008. FILED 1-8-2008.
- 3,566,810. **THE GOOD COW COMPANY (BLOCK FORM)**, THE GOOD COW COMPANY, (U.S. CL. 46). SN 77-412,897. PUB. 11-11-2008. FILED 3-4-2008.
- 3,566,832. **KERN MEAT CO EST. 1948 AND DESIGN**, KERN MEAT COMPANY, INC., (U.S. CL. 46). SN 77-429,571. PUB. 11-11-2008. FILED 3-24-2008.
- 3,566,866. **RASM (BLOCK FORM)**, TASTE L. FINE FOOD PVT. LTD., MULTIPLE CLASS, (INT. CLS. 29 AND 30),

- (U.S. CL. 46). SN 77-446,297. PUB. 11-11-2008. FILED 4-11-2008.
- 3,566,929. **BUFFALO CLAWS AND DESIGN**. UNCLE EDIE'S, (U.S. CL. 46). SN 77-471,399. PUB. 11-11-2008. FILED 5-12-2008.
- 3,566,944. **FESTIVE FAVORITES (BLOCK FORM)**. VARSITY GOLD, INC., MULTIPLE CLASS, (INT. CLS. 29, 30 AND 36), (U.S. CLS. 46, 100, 101 AND 102). SN 77-476,227. PUB. 11-11-2008. FILED 5-16-2008.
- 3,567,082. **AÇAI EXPRESS AND DESIGN**. ARLOTTA, ALEX-ANDRE, (U.S. CL. 46). SN 77-494,277. PUB. 11-11-2008. FILED 6-9-2008.
- 3,567,326. **TARENDAISE AND DESIGN**. JOHN L. PUTNAM, (U.S. CL. 46). SN 77-501,742. PUB. 11-11-2008. FILED 6-18-2008.
- 3,567,501. **MOUNTAIN DELIGHT AND DESIGN**. DINAS CORP., (U.S. CL. 46). SN 77-504,847. PUB. 11-11-2008. FILED 6-21-2008.
- 3,567,521. **ZABAR'S (BLOCK FORM)**. ZABAR'S & CO., INC., MULTIPLE CLASS, (INT. CLS. 29, 30 AND 32), (U.S. CLS. 45, 46 AND 48). SN 77-505,339. PUB. 11-11-2008. FILED 6-23-2008.
- 3,567,533. **LARVETS (BLOCK FORM)**. HOTLIX, INC., (U.S. CL. 46). SN 77-505,466. PUB. 11-11-2008. FILED 6-23-2008.
- 3,567,645. **GALIN (BLOCK FORM)**. YUMMY FOOD PRODUCTS, INC., (U.S. CL. 46). SN 77-513,001. PUB. 11-11-2008. FILED 7-1-2008.
- 3,567,721. **CHOCOLATE CITRUS BLOSSOM (BLOCK FORM)**. EDIBLE ARRANGEMENTS, LLC, MULTIPLE CLASS, (INT. CLS. 29 AND 30), (U.S. CL. 46). SN 77-570,394. PUB. 11-11-2008. FILED 9-15-2008.
- 3,567,747. **NUTRI-V (BLOCK FORM)**. HG HOLDINGS (INTERNATIONAL) CORP., MULTIPLE CLASS, (INT. CLS. 29 AND 30), (U.S. CL. 46). SN 78-681,874. PUB. 4-8-2008. FILED 7-29-2005.
- 3,567,832. **LINDA MCCARTNEY GOOD FOOD, GOOD TASTE AND DESIGN**. LINDA ENTERPRISES LIMITED, MULTIPLE CLASS, (INT. CLS. 29 AND 30), (U.S. CL. 46). SN 79-039,245. PUB. 11-11-2008. FILED 3-27-2007.
- 3,567,869. **KAMPFMEYER (BLOCK FORM)**. KAMPFMEYER MÜHLEN GMBH, MULTIPLE CLASS, (INT. CLS. 29, 30 AND 31), (U.S. CLS. 1 AND 46). SN 79-046,687. PUB. 11-11-2008. FILED 11-20-2007.
- 3,567,902. **U KAN (BLOCK FORM)**. SOREMARTEC S.A., MULTIPLE CLASS, (INT. CLS. 29, 30, 32 AND 33), (U.S. CLS. 45, 46, 47, 48 AND 49). SN 79-049,280. PUB. 11-11-2008. FILED 12-26-2007.
- 3,567,910. **OLIVITAL (BLOCK FORM)**. F.LLI RUATA S.P.A., (U.S. CL. 46). SN 79-049,822. PUB. 11-11-2008. FILED 12-14-2007.
- 3,567,933 (*See Class 1 for this trademark*).
- 3,567,934 (*See Class 1 for this trademark*).
- 3,567,935 (*See Class 1 for this trademark*).
- 3,567,936 (*See Class 1 for this trademark*).
- 3,567,979. **PICANDINE (BLOCK FORM)**. SA PICANDINE, (U.S. CL. 46). SN 79-056,071. PUB. 11-11-2008. FILED 6-17-2008.
-
- CLASS 30—STAPLE FOODS**
- 3,566,412. **SONG FANG AND DESIGN**. SAMSON, FLORENCE MARYLENE, (U.S. CL. 46). SN 77-093,441. PUB. 8-26-2008. FILED 1-29-2007.
- 3,566,420. **KEOPU MAUKA LANI PLANTATION AND DESIGN**. FARROW, SUZANNE J., (U.S. CL. 46). SN 77-097,465. PUB. 11-11-2008. FILED 2-2-2007.
- 3,566,477. **VIVEL (BLOCK FORM)**. MOHAMMAD-BAGHERZADEH, NARGES, MULTIPLE CLASS, (INT. CLS. 30 AND 35), (U.S. CLS. 46, 100, 101 AND 102). SN 77-201,134. PUB. 9-9-2008. FILED 6-8-2007.
- 3,566,568. **PAN DI STELLE (STYLIZED)**. BARILLA G. E. R. FRATELLI - SOCIETÀ PER AZIONI, (U.S. CL. 46). SN 77-306,386. PUB. 8-19-2008. FILED 10-17-2007.
- 3,566,573. **ORGANIC A GO GO (BLOCK FORM)**. 52ND STREET CHOCOLATE CO., LLC, (U.S. CL. 46). SN 77-310,581. PUB. 11-11-2008. FILED 10-23-2007.
- 3,566,602. **KAHE (BLOCK FORM)**. THE COCA-COLA COMPANY, (U.S. CL. 46). SN 77-325,183. PUB. 11-11-2008. FILED 11-8-2007.
- 3,566,604. **MARK ETO (BLOCK FORM)**. ORION CORPORATION, (U.S. CL. 46). SN 77-325,495. PUB. 11-11-2008. FILED 11-9-2007.
- 3,566,682. **GLAZEDMANIA (BLOCK FORM)**. CORPORACIÓN CHURRO MANIA C.A., (U.S. CL. 46). SN 77-349,565. PUB. 11-11-2008. FILED 12-11-2007.
- 3,566,683. **TWISTMANIA (BLOCK FORM)**. CORPORACIÓN CHURRO MANIA C.A., (U.S. CL. 46). SN 77-349,575. PUB. 11-11-2008. FILED 12-11-2007.
- 3,566,684. **CRISPYMANIA (BLOCK FORM)**. CORPORACIÓN CHURRO MANIA C.A., (U.S. CL. 46). SN 77-349,584. PUB. 11-11-2008. FILED 12-11-2007.
- 3,566,779. **THE COOKIE CORNER (BLOCK FORM)**. THE COOKIE CORNER, (U.S. CL. 46). SN 77-394,072. PUB. 11-11-2008. FILED 2-11-2008.
- 3,566,798. **EUROCLASSIC PASTRIES AND DESIGN**. WYHE'S CHOICE, INC., DBA DUTCHLAND FROZEN FOODS, (U.S. CL. 46). SN 77-407,012. PUB. 11-11-2008. FILED 2-27-2008.
- 3,566,799. **EUROCLASSIC PASTRIES (BLOCK FORM)**. WYHE'S CHOICE, INC., DBA DUTCHLAND FROZEN FOODS, (U.S. CL. 46). SN 77-407,024. PUB. 11-11-2008. FILED 2-27-2008.
- 3,566,866 (*See Class 29 for this trademark*).
- 3,566,893 (*See Class 25 for this trademark*).
- 3,566,944 (*See Class 29 for this trademark*).
- 3,566,950. **S SUSHI ON THE ROLL AND DESIGN**. SOTR, LLC, (U.S. CL. 46). SN 77-478,010. PUB. 11-11-2008. FILED 5-19-2008.
- 3,566,953. **BIG AZ (BLOCK FORM)**. PIERRE FOODS, INC., (U.S. CL. 46). SN 77-479,079. PUB. 11-11-2008. FILED 5-20-2008.
- 3,567,010. **OPEN COUNTRY (BLOCK FORM)**. THE METAL WARE CORPORATION, (U.S. CL. 46). SN 77-487,614. PUB. 11-11-2008. FILED 5-30-2008.
- 3,567,017. **WHERE GELATO BEGINS (BLOCK FORM)**. FIRENZE, ANGELO P., (U.S. CL. 46). SN 77-488,014. PUB. 11-11-2008. FILED 5-31-2008.
- 3,567,040. **BROADWAY COFFEE & TEA COMPANY (STYLIZED)**. BARNIE'S II, INC., (U.S. CL. 46). SN 77-490,749. PUB. 11-11-2008. FILED 6-4-2008.
- 3,567,059. **RED'S DONUT SHOP (BLOCK FORM)**. RED'S DONUT SHOP, (U.S. CL. 46). SN 77-492,572. PUB. 11-11-2008. FILED 6-6-2008.
- 3,567,145. **DAMY (BLOCK FORM)**. MONTES Y CIA., S.A. DE C.V., (U.S. CL. 46). SN 77-497,516. PUB. 11-11-2008. FILED 6-12-2008.
- 3,567,159. **MISCELLANEOUS DESIGN**. DAPHNE CONTRAROS RIOUX, (U.S. CL. 46). SN 77-498,197. PUB. 11-11-2008. FILED 6-13-2008.
- 3,567,160. **R ROYAL CREST AND DESIGN**. CONSOLIDATED BISCUIT CO., (U.S. CL. 46). SN 77-498,199. PUB. 11-11-2008. FILED 6-13-2008.
- 3,567,161. **ROYAL CREST AND DESIGN**. CONSOLIDATED BISCUIT CO., (U.S. CL. 46). SN 77-498,240. PUB. 11-11-2008. FILED 6-13-2008.
- 3,567,196. **DO A LITTLE GOOD WITH EVERY CUP OF COFFEE (BLOCK FORM)**. S&D COFFEE, INC., (U.S. CL. 46). SN 77-499,645. PUB. 11-11-2008. FILED 6-16-2008.
- 3,567,197. **ABC (BLOCK FORM)**. INTERBAKE FOODS, INC., (U.S. CL. 46). SN 77-499,686. PUB. 11-11-2008. FILED 6-16-2008.
- 3,567,221. **VINAGRE DE FAMILIA AND DESIGN**. ALVARO DOMEQ, S.L., (U.S. CL. 46). SN 77-500,007. PUB. 11-11-2008. FILED 6-16-2008.
- 3,567,227. **FLAN KING (BLOCK FORM)**. SARBEK INC, MULTIPLE CLASS, (INT. CLS. 30 AND 35), (U.S. CLS. 46, 100, 101 AND 102). SN 77-500,245. PUB. 11-11-2008. FILED 6-16-2008.
- 3,567,236. **HAPPY BOAT AND DESIGN**. EASY & BUSY LTD, (U.S. CL. 46). SN 77-500,383. PUB. 11-11-2008. FILED 6-17-2008.
- 3,567,261. **FLAMINGO SNO (BLOCK FORM)**. CORINNE MACPARTLAND, (U.S. CL. 46). SN 77-500,798. PUB. 11-11-2008. FILED 6-17-2008.

3,567,313. **TLC (BLOCK FORM)**, KASHI COMPANY, (U.S. CL. 46). SN 77-501,482. PUB. 11-11-2008. FILED 6-18-2008.

3,567,315. **GRABURRITO (BLOCK FORM)**, FLYING STAR CAFE, (U.S. CL. 46). SN 77-501,488. PUB. 11-11-2008. FILED 6-18-2008.

3,567,323. **WIDE-AWAKES (BLOCK FORM)**, NEWFRESHCO FOODS, LLC, (U.S. CL. 46). SN 77-501,665. PUB. 11-11-2008. FILED 6-18-2008.

3,567,344. **SWEET TREASURES (BLOCK FORM)**, THE SWISS COLONY, INC., (U.S. CL. 46). SN 77-501,960. PUB. 11-11-2008. FILED 6-18-2008.

3,567,349. **LEMONDAIRY (BLOCK FORM)**, MICHAEL A. TATE, (U.S. CL. 46). SN 77-502,042. PUB. 11-11-2008. FILED 6-18-2008.

3,567,394. **FOLGERS DAILY BLEND (BLOCK FORM)**, THE PROCTER & GAMBLE COMPANY, (U.S. CL. 46). SN 77-502,681. PUB. 11-11-2008. FILED 6-19-2008.

3,567,404. **CAROLINA COTTON CANDY (BLOCK FORM)**, CAROLINA COTTON CANDY, LTD., (U.S. CL. 46). SN 77-502,866. PUB. 11-11-2008. FILED 6-19-2008.

3,567,413. **APPETITES (BLOCK FORM)**, ATHENS FOODS, INC., (U.S. CL. 46). SN 77-502,994. PUB. 11-11-2008. FILED 6-19-2008.

3,567,417. **WEE WILLY'S (BLOCK FORM)**, WEE WILLY'S INC., (U.S. CL. 46). SN 77-503,035. PUB. 11-11-2008. FILED 6-19-2008.

3,567,469. **WHEATENA TOASTED WHEAT CEREAL AND DESIGN**, HOMESTAT FARM, LTD., (U.S. CL. 46). SN 77-504,247. PUB. 11-11-2008. FILED 6-20-2008.

3,567,521 (*See Class 29 for this trademark*).

3,567,527. **YOU GO! SPORTY GIRL (BLOCK FORM)**, HERSHEY CHOCOLATE & CONFECTIONERY CORPORATION, (U.S. CL. 46). SN 77-505,430. PUB. 11-11-2008. FILED 6-23-2008.

3,567,529. **YOU GO! FASHION GIRL (BLOCK FORM)**, HERSHEY CHOCOLATE & CONFECTIONERY CORPORATION, (U.S. CL. 46). SN 77-505,433. PUB. 11-11-2008. FILED 6-23-2008.

3,567,531. **YOU GO! DRAMA GIRL (BLOCK FORM)**, HERSHEY CHOCOLATE & CONFECTIONERY CORPORATION, (U.S. CL. 46). SN 77-505,436. PUB. 11-11-2008. FILED 6-23-2008.

3,567,556. **VESUVIO (BLOCK FORM)**, VIAVANTI, LLC, (U.S. CL. 46). SN 77-506,041. PUB. 11-11-2008. FILED 6-24-2008.

3,567,618. **BITE-LETTES (BLOCK FORM)**, TRICE, LAURA, (U.S. CL. 46). SN 77-508,302. PUB. 11-11-2008. FILED 6-25-2008.

3,567,658 (*See Class 25 for this trademark*).

3,567,662. **I AM THE TEA LADY WWW.LINENANDTEA.COM AND DESIGN**, LINE, BONNIE, (U.S. CL. 46). SN 77-519,329. PUB. 11-11-2008. FILED 7-10-2008.

3,567,701. **GROUNDED TRADITIONS (BLOCK FORM)**, FAMILY DOLLAR STORES OF MICHIGAN, INC., (U.S. CL. 46). SN 77-536,734. PUB. 11-11-2008. FILED 8-1-2008.

3,567,713. **TEA SPA (BLOCK FORM)**, SOUTHERN SUN TEAS (PRIVATE) LIMITED, (U.S. CL. 46). SN 77-544,383. PUB. 11-11-2008. FILED 8-12-2008.

3,567,721 (*See Class 29 for this trademark*).

3,567,747 (*See Class 29 for this trademark*).

3,567,755. **LE GRAND COUSIN (BLOCK FORM)**, CANADA BREAD FROZEN BAKERY LTD., (U.S. CL. 46). SN 78-774,598. PUB. 11-11-2008. FILED 12-15-2005.

3,567,756. **LE GRAND COUSIN FRANCAIS (BLOCK FORM)**, CANADA BREAD FROZEN BAKERY LTD., (U.S. CL. 46). SN 78-774,628. PUB. 11-11-2008. FILED 12-15-2005.

3,567,832 (*See Class 29 for this trademark*).

3,567,858. **BAULI (BLOCK FORM)**, RUGGERO BAULI S.P.A., (U.S. CL. 46). SN 79-045,641. PUB. 11-11-2008. FILED 5-25-2007.

3,567,869 (*See Class 29 for this trademark*).

3,567,898. **MISCELLANEOUS DESIGN**, FERRERO S.P.A., (U.S. CL. 46). SN 79-049,154. PUB. 11-11-2008. FILED 12-7-2007.

3,567,902 (*See Class 29 for this trademark*).

3,567,913. **ZHONGBA AND DESIGN**, SICHUAN QINGXIANGYUAN FLAVORING; CORPORATION, (U.S. CL. 46). SN 79-049,904. PUB. 11-11-2008. FILED 10-10-2007.

3,567,929. **BASIC (BLOCK FORM)**, ZOTTER HOLDING

GMBH, (U.S. CL. 46). SN 79-050,821. PUB. 11-11-2008. FILED 8-28-2007.

3,567,933 (*See Class 1 for this trademark*).

3,567,934 (*See Class 1 for this trademark*).

3,567,935 (*See Class 1 for this trademark*).

3,567,936 (*See Class 1 for this trademark*).

CLASS 31—NATURAL AGRICULTURAL PRODUCTS

3,566,379. **MPI FRESH (BLOCK FORM)**, MALENA PRODUCE, INC., (U.S. CLS. 1 AND 46). SN 77-030,407. PUB. 11-11-2008. FILED 10-26-2006.

3,566,383. **PAW NATURAW DISTINCT BY INSTINCT AND DESIGN**, NATURALLY RAW LLC, (U.S. CLS. 1 AND 46). SN 77-045,528. PUB. 7-17-2007. FILED 11-16-2006.

3,566,501. **CALIFORNIA FRUIT COMPANY - ORCHARD TO OFFICE DELIVERY - AND DESIGN**, CALIFORNIA FRUIT COMPANY, (U.S. CLS. 1 AND 46). SN 77-225,990. PUB. 11-11-2008. FILED 7-10-2007.

3,566,622. **SWEETLAND FARMS (BLOCK FORM)**, GEORGIA AGRI-SALES, INC., (U.S. CLS. 1 AND 46). SN 77-331,666. PUB. 11-11-2008. FILED 11-16-2007.

3,566,628. **CLAUSE VEGETABLE SEEDS AND DESIGN**, CLAUSE TEZIER, (U.S. CLS. 1 AND 46). SN 77-332,766. PUB. 9-9-2008. FILED 11-19-2007.

3,566,802. **TERRIFIC TRIO (BLOCK FORM)**, THE LITTLE POTATO COMPANY LTD., (U.S. CLS. 1 AND 46). SN 77-407,498. PUB. 11-11-2008. FILED 2-27-2008.

3,566,869. **REIGNING PETS NORTHWEST AND DESIGN**, REIGNING CATS AND DOGS, LLC, MULTIPLE CLASS, (INT. CLS. 31, 35, 39, 44 AND 45), (U.S. CLS. 1, 46, 100, 101, 102 AND 105). SN 77-447,481. PUB. 11-11-2008. FILED 4-14-2008.

3,566,910. **PACIFIC FRESH AND DESIGN**, PACIFIC FRESH PRODUCE, INC., (U.S. CLS. 1 AND 46). SN 77-464,281. PUB. 11-11-2008. FILED 5-2-2008.

3,566,911. **COASTAL FRESH AND DESIGN**, PACIFIC FRESH PRODUCE, INC., (U.S. CLS. 1 AND 46). SN 77-464,302. PUB. 11-11-2008. FILED 5-2-2008.

3,567,252. **WORKMAN (BLOCK FORM)**, WORKMAN FARMS, INC., (U.S. CLS. 1 AND 46). SN 77-500,687. PUB. 11-11-2008. FILED 6-17-2008.

3,567,869 (*See Class 29 for this trademark*).

3,567,876. **SUPREME AND DESIGN**, KIER BAKER HOLDINGS LIMITED, (U.S. CLS. 1 AND 46). SN 79-047,461. PUB. 11-11-2008. FILED 11-2-2007.

3,567,928 (*See Class 5 for this trademark*).

3,567,933 (*See Class 1 for this trademark*).

3,567,934 (*See Class 1 for this trademark*).

3,567,935 (*See Class 1 for this trademark*).

3,567,936 (*See Class 1 for this trademark*).

3,567,983. **PRETTY EASY (BLOCK FORM)**, JUNGPFANZEN GRÜNEWALD GMBH, (U.S. CLS. 1 AND 46). SN 79-056,822. PUB. 11-11-2008. FILED 6-4-2008.

CLASS 32—LIGHT BEVERAGES

3,566,380. **UFF-DA (BLOCK FORM)**, NEW GLARUS BREWING COMPANY, (U.S. CLS. 45, 46 AND 48). SN 77-034,339. PUB. 11-11-2008. FILED 11-1-2006.

3,566,447 (*See Class 25 for this trademark*).

3,566,473. **E AND DESIGN**, EVONIK INDUSTRIES AG, (U.S. CLS. 45, 46 AND 48). SN 77-195,951. PUB. 11-11-2008. FILED 6-1-2007.

3,566,512. **MARG MIKE-ARITA AND DESIGN**, MARK ANTHONY INTERNATIONAL SRL, MULTIPLE CLASS, (INT. CLS. 32 AND 33), (U.S. CLS. 45, 46, 47, 48 AND 49). SN 77-239,917. PUB. 5-6-2008. FILED 7-26-2007.

3,566,542. **TROEGENATOR DOUBLEBOCK BEER AND DESIGN**, TROEGS BREWING CO, (U.S. CLS. 45, 46 AND 48). SN 77-274,459. PUB. 11-11-2008. FILED 9-7-2007.

3,566,767. **DUNDEE (BLOCK FORM)**, HIGH FALLS BREW-

ING COMPANY, LLC, (U.S. CLS. 45, 46 AND 48). SN 77-382,816. PUB. 11-11-2008. FILED 1-29-2008.

3,567,209. **NEGRA MODELO AND DESIGN**. CERVECERIA MODELO, S.A. DE C.V., (U.S. CLS. 45, 46 AND 48). SN 77-499,866. PUB. 11-11-2008. FILED 6-16-2008.

3,567,521 (*See Class 29 for this trademark*).

3,567,597. **BELLYWASHERS (BLOCK FORM)**. IN ZONE BRANDS, INC., (U.S. CLS. 45, 46 AND 48). SN 77-506,995. PUB. 11-11-2008. FILED 6-24-2008.

3,567,613. **AQUAFINA (BLOCK FORM)**. PEPSICO, INC., (U.S. CLS. 45, 46 AND 48). SN 77-507,319. PUB. 11-11-2008. FILED 6-25-2008.

3,567,717. **GHOST RIVER BREWING AND DESIGN**. ROMA POMODORI, INC., (U.S. CLS. 45, 46 AND 48). SN 77-547,789. PUB. 11-11-2008. FILED 8-15-2008.

3,567,728. **CUZCATLAN**. CONTOS, GEORGE, AND PRYOR, NEIL, (U.S. CLS. 45, 46 AND 48). SN 78-271,564. PUB. 11-11-2008. FILED 7-8-2003.

3,567,776. **SOUL FRUIT (BLOCK FORM)**. D'ANGELO BRANDS LTD., (U.S. CLS. 45, 46 AND 48). SN 78-904,855. PUB. 5-13-2008. FILED 6-9-2006.

3,567,852. **WEIHENSTEPHANER VITUS AND DESIGN**. BAYERISCHE STAATSBRAUEREI; WEIHENSTEPHAN, (U.S. CLS. 45, 46 AND 48). SN 79-044,623. PUB. 11-11-2008. FILED 8-28-2007.

3,567,902 (*See Class 29 for this trademark*).

3,567,933 (*See Class 1 for this trademark*).

3,567,934 (*See Class 1 for this trademark*).

3,567,935 (*See Class 1 for this trademark*).

3,567,936 (*See Class 1 for this trademark*).

CLASS 33—WINES AND SPIRITS

3,566,333. **RON VEGA (BLOCK FORM)**. EAST-WEST DISTRIBUTING CO., (U.S. CLS. 47 AND 49). SN 76-689,259. PUB. 11-11-2008. FILED 5-5-2008.

3,566,450. **VM AND DESIGN**. ARBOR VINEYARDS, INC., DBA METTLER FAMILY VINEYARDS, (U.S. CLS. 47 AND 49). SN 77-154,479. PUB. 11-11-2008. FILED 4-11-2007.

3,566,463. **ARTISTIC LICENSE (BLOCK FORM)**. PRESIDIO WINES, INC., (U.S. CLS. 47 AND 49). SN 77-181,225. PUB. 11-11-2008. FILED 5-15-2007.

3,566,505. **LENNARD'S CROSSING (BLOCK FORM)**. AUSTRALIAN VINTAGE LTD., (U.S. CLS. 47 AND 49). SN 77-226,724. PUB. 11-11-2008. FILED 7-11-2007.

3,566,512 (*See Class 32 for this trademark*).

3,566,711. **PAUL GIRAUD (BLOCK FORM)**. COGNAC PAUL GIRAUD ET FILS SARL, (U.S. CLS. 47 AND 49). SN 77-356,926. PUB. 11-11-2008. FILED 12-20-2007.

3,566,763. **MYSTERY CASE (BLOCK FORM)**. J.J. BUCKLEY, LLC, (U.S. CLS. 47 AND 49). SN 77-380,145. PUB. 11-11-2008. FILED 1-24-2008.

3,566,764. **RHONING STONES (BLOCK FORM)**. STRANGER & STRANGER LIMITED, (U.S. CLS. 47 AND 49). SN 77-380,486. PUB. 11-11-2008. FILED 1-25-2008.

3,566,768. **TUMBAO (BLOCK FORM)**. ENOFORUM - COMERCIO E EXPORTACAO DE VINHOS, S.A., (U.S. CLS. 47 AND 49). SN 77-383,348. PUB. 11-11-2008. FILED 1-29-2008.

3,566,775. **GREEN RABBIT (BLOCK FORM)**. LA FAMILLE DES GRANDS VINS ET SPIRITUEUX (FGVS), (U.S. CLS. 47 AND 49). SN 77-389,723. PUB. 11-11-2008. FILED 2-6-2008.

3,566,848. **CYRK (BLOCK FORM)**. DAVID RAVANDI, (U.S. CLS. 47 AND 49). SN 77-439,850. PUB. 11-11-2008. FILED 4-4-2008.

3,566,857. **WANOKAWA (BLOCK FORM)**. SAKEONE CORPORATION, (U.S. CLS. 47 AND 49). SN 77-443,003. PUB. 11-11-2008. FILED 4-8-2008.

3,566,923. **MORITZ (BLOCK FORM)**. ROMAN BRATASIUK, (U.S. CLS. 47 AND 49). SN 77-469,952. PUB. 11-11-2008. FILED 5-9-2008.

3,566,949. **FINCA LA ESTACADA AND DESIGN**. BODEGAS FINCA LA ESTACADA, S.L., (U.S. CLS. 47 AND 49). SN 77-477,218. PUB. 11-11-2008. FILED 5-16-2008.

3,567,032. **THE VERDICT SHINAS ESTATE (BLOCK FORM)**. SHINAS, GEORGE, (U.S. CLS. 47 AND 49). SN 77-490,306. PUB. 11-11-2008. FILED 6-4-2008.

3,567,111. **ENROUTE AND DESIGN**. NICKEL & NICKEL VINEYARDS, LLC, (U.S. CLS. 47 AND 49). SN 77-496,386. PUB. 11-11-2008. FILED 6-11-2008.

3,567,165. **SERENO (BLOCK FORM)**. LA MADRILEÑA, S.A. DE C.V., (U.S. CLS. 47 AND 49). SN 77-498,328. PUB. 11-11-2008. FILED 6-13-2008.

3,567,166. **XERENO (BLOCK FORM)**. LA MADRILEÑA, S.A. DE C.V., (U.S. CLS. 47 AND 49). SN 77-498,398. PUB. 11-11-2008. FILED 6-13-2008.

3,567,234. **BRIGITTE (BLOCK FORM)**. BRIDGET RAYMOND, (U.S. CLS. 47 AND 49). SN 77-500,346. PUB. 11-11-2008. FILED 6-16-2008.

3,567,400. **SCHMIDT RANCH (BLOCK FORM)**. SWANSON VINEYARDS AND WINERY, (U.S. CLS. 47 AND 49). SN 77-502,823. PUB. 11-11-2008. FILED 6-19-2008.

3,567,488. **FAME (BLOCK FORM)**. AMERIVINE, INC., (U.S. CLS. 47 AND 49). SN 77-504,724. PUB. 11-11-2008. FILED 6-20-2008.

3,567,554. **COCAVIN (BLOCK FORM)**. COCAVIN RIDGE, MULTIPLE CLASS, (INT. CLS. 33 AND 44), (U.S. CLS. 47, 49, 100 AND 101). SN 77-505,954. PUB. 11-11-2008. FILED 6-23-2008.

3,567,686. **MACMURRAY (BLOCK FORM)**. E. & J. GALLO WINERY, (U.S. CLS. 47 AND 49). SN 77-525,917. PUB. 11-11-2008. FILED 7-18-2008.

3,567,732. **TEQUILA CAZADORES REPOSADO AND DESIGN**. BACARDI & COMPANY LIMITED, (U.S. CLS. 47 AND 49). SN 78-429,077. PUB. 8-2-2005. FILED 6-2-2004.

3,567,777. **MOUNT MONSTER (BLOCK FORM)**. BRYSON, ANDREW F, AND BRYSON, CLIVE, AND BRYSON, ELIZABETH M, AND BRYSON, PAUL W, (U.S. CLS. 47 AND 49). SN 78-913,963. PUB. 11-11-2008. FILED 6-22-2006.

3,567,800. **UKRAINIAN BIRCH SPECIAL NEMIROFF AND DESIGN**. NEMIROFF INTELLECTUAL PROPERTY ESTABLISHMENT, (U.S. CLS. 47 AND 49). SN 79-018,698. PUB. 11-11-2008. FILED 11-8-2005.

3,567,834. **WILDBERRY ESTATE (BLOCK FORM)**. FLYING FISH COVE PTY LTD, (U.S. CLS. 47 AND 49). SN 79-039,769. PUB. 11-11-2008. FILED 5-17-2007.

3,567,873. **VODKA NEMIROVSKAYA NEMIROFF N DISILLED AND BOTTLED BY NEMIROFF IMPORTED PRODUCT OF UKRAINE 40% VOL. AND 700ML AND DESIGN**. NEMIROFF; INTELLECTUAL PROPERTY ESTABLISHMENT, (U.S. CLS. 47 AND 49). SN 79-047,106. PUB. 11-11-2008. FILED 10-18-2007.

3,567,902 (*See Class 29 for this trademark*).

3,567,907. **FACUNDO BACARDI SMOOTH & DRY 1862 BACARDI SUPERIOR ORIGINAL PREMIUM RUM BACARDI PUERTO RICAN RUM EST. 1862 40% ALC BY VOL AND DESIGN**. BACARDI & COMPANY LIMITED, (U.S. CLS. 47 AND 49). SN 79-049,614. PUB. 11-11-2008. FILED 9-18-2007.

3,567,990. **VICTORINO (STYLIZED)**. DOMINIO DE EGUREN, S.L., (U.S. CLS. 47 AND 49). SN 79-057,824. PUB. 11-11-2008. FILED 5-5-2008.

CLASS 34—SMOKERS' ARTICLES

3,566,550. **RESERVA DE LA FÁBRICA CABINET SELECCIÓN AND DESIGN**. SUPERIOR CIGARS USA INC., (U.S. CLS. 2, 8, 9 AND 17). SN 77-284,948. PUB. 11-11-2008. FILED 9-20-2007.

3,567,378 (*See Class 18 for this trademark*).

3,567,693. **10 20'S AND DESIGN**. DHANRAJ IMPORTS, INC, (U.S. CLS. 2, 8, 9 AND 17). SN 77-531,660. PUB. 11-11-2008. FILED 7-25-2008.

3,567,867. **MITSUBA AND DESIGN**. GUANGZHOU ZHAOYING; HARDWARE CO., LTD, (U.S. CLS. 2, 8, 9 AND 17). SN 79-046,467. PUB. 11-11-2008. FILED 11-16-2007.

SERVICE MARKS

CLASS 35—ADVERTISING AND BUSINESS

- 3,566,260. **THE SALT LAKE TRIBUNE**. KEARNS-TRIBUNE, LLC, MULTIPLE CLASS, (INT. CLS. 35 AND 41), (U.S. CLS. 100, 101, 102 AND 107). SN 76-482,676. PUB. 11-11-2008. FILED 1-16-2003.
- 3,566,267 (*See Class 9 for this trademark*).
- 3,566,268 (*See Class 9 for this trademark*).
- 3,566,270. **HEAR ATLAST (BLOCK FORM)**. ATLAST GROUP CIE, (U.S. CLS. 100, 101 AND 102). SN 76-666,411. PUB. 11-11-2008. FILED 9-20-2006.
- 3,566,277. **CC'S COMMUNITY COFFEE HOUSE (BLOCK FORM)**. COMMUNITY COFFEE COMPANY OF TEXAS, INC., MULTIPLE CLASS, (INT. CLS. 35 AND 43), (U.S. CLS. 100, 101 AND 102). SN 76-675,589. PUB. 11-11-2008. FILED 4-17-2007.
- 3,566,281. **HOT ROD EXPRESS MAIDEN NC AND DESIGN**. RESTORATION LLC, (U.S. CLS. 100, 101 AND 102). SN 76-677,274. PUB. 4-29-2008. FILED 5-22-2007.
- 3,566,282. **HOT ROD EXPRESS (BLOCK FORM)**. RESTORATION, LLC, (U.S. CLS. 100, 101 AND 102). SN 76-677,276. PUB. 4-29-2008. FILED 5-22-2007.
- 3,566,284 (*See Class 25 for this trademark*).
- 3,566,292. **SUSTAINABLE BREAKTHROUGH ENTERPRISE (BLOCK FORM)**. GAP INTERNATIONAL, INC., (U.S. CLS. 100, 101 AND 102). SN 76-683,436. PUB. 11-11-2008. FILED 10-29-2007.
- 3,566,293. **ECONORTHWEST (BLOCK FORM)**. ECONOMICS CONSULTANTS OREGON, LTD., MULTIPLE CLASS, (INT. CLS. 35, 39, 42 AND 45), (U.S. CLS. 100, 101, 102 AND 105). SN 76-683,642. PUB. 11-11-2008. FILED 11-5-2007.
- 3,566,295. **CELLULAR SWAP.COM AND DESIGN**. CELLULARSWAP, L.L.C., (U.S. CLS. 100, 101 AND 102). SN 76-683,977. PUB. 11-11-2008. FILED 11-13-2007.
- 3,566,296. **HOUSE OF KNOBS (BLOCK FORM)**. MYKNOBS.-COM, INC., (U.S. CLS. 100, 101 AND 102). SN 76-684,079. PUB. 11-11-2008. FILED 11-16-2007.
- 3,566,304. **MISCELLANEOUS DESIGN**. SOURCE ONE DISTRIBUTORS, INC., (U.S. CLS. 100, 101 AND 102). SN 76-685,255. PUB. 11-11-2008. FILED 12-26-2007.
- 3,566,309. **SOURCE ONE TACTICAL (BLOCK FORM)**. SOURCE ONE DISTRIBUTORS, INC., (U.S. CLS. 100, 101 AND 102). SN 76-685,881. PUB. 11-11-2008. FILED 1-17-2008.
- 3,566,310. **VOIP SUPPLY AND DESIGN**. VOIP SUPPLY LLC, (U.S. CLS. 100, 101 AND 102). SN 76-685,987. PUB. 11-11-2008. FILED 1-22-2008.
- 3,566,312. **COMFORT AUDIO (BLOCK FORM)**. COMFORT AUDIO, INC., (U.S. CLS. 100, 101 AND 102). SN 76-686,869. PUB. 11-11-2008. FILED 2-15-2008.
- 3,566,336. **CUAUTOBUZZ (BLOCK FORM)**. DELANO MOTOR CENTER, INC., (U.S. CLS. 100, 101 AND 102). SN 76-690,019. PUB. 11-11-2008. FILED 5-27-2008.
- 3,566,349. **FIREBOX AND DESIGN**. FIREBOX RESEARCH & STRATEGY LLC, (U.S. CLS. 100, 101 AND 102). SN 76-690,422. PUB. 11-11-2008. FILED 6-10-2008.
- 3,566,353. **FLAT WORLD MEDIA (BLOCK FORM)**. FLAT WORLD MEDIA, (U.S. CLS. 100, 101 AND 102). SN 76-690,682. PUB. 11-11-2008. FILED 6-19-2008.
- 3,566,362. **LINWOOD HOMES (BLOCK FORM)**. LINWOOD HOMES, LTD., MULTIPLE CLASS, (INT. CLS. 35, 37, 41 AND 42), (U.S. CLS. 100, 101, 102, 103, 106 AND 107). SN 76-691,306. PUB. 11-11-2008. FILED 7-7-2008.
- 3,566,372. **EXPERIENCE. REDEFINED. (BLOCK FORM)**. HURON CONSULTING GROUP INC., MULTIPLE CLASS, (INT. CLS. 35, 36 AND 45), (U.S. CLS. 100, 101 AND 102). SN 77-019,741. PUB. 11-11-2008. FILED 10-12-2006.
- 3,566,396 (*See Class 9 for this trademark*).
- 3,566,409. **Y&CO. (STYLIZED)**. BYONG-JIN, JOO, (U.S. CLS. 100, 101 AND 102). SN 77-084,432. PUB. 11-11-2008. FILED 1-17-2007.
- 3,566,410. **MYLLC.COM (BLOCK FORM)**. MYLLC.COM, INC., (U.S. CLS. 100, 101 AND 102). SN 77-084,550. PUB. 11-11-2008. FILED 1-17-2007.
- 3,566,414. **ANGIE'S LIST (BLOCK FORM)**. BROWNSTONE PUBLISHING, LLC, (U.S. CLS. 100, 101 AND 102). SN 77-094,534. PUB. 11-11-2008. FILED 1-30-2007.
- 3,566,430. **QUICK TRACK AND DESIGN**. MARTIN EAGLE OIL COMPANY, INC., (U.S. CLS. 100, 101 AND 102). SN 77-124,564. PUB. 11-11-2008. FILED 3-7-2007.
- 3,566,431 (*See Class 6 for this trademark*).
- 3,566,432 (*See Class 6 for this trademark*).
- 3,566,433. **CRAWFORD CONTRACTOR CONNECTION (BLOCK FORM)**. CRAWFORD AND COMPANY, MULTIPLE CLASS, (INT. CLS. 35, 37 AND 42), (U.S. CLS. 100, 101, 102, 103 AND 106). SN 77-126,642. PUB. 11-11-2008. FILED 3-9-2007.
- 3,566,441 (*See Class 10 for this trademark*).
- 3,566,445 (*See Class 16 for this trademark*).
- 3,566,446. **CORNER CUPBOARD (BLOCK FORM)**. BOB EVANS RESTAURANTS OF MICHIGAN, INC., (U.S. CLS. 100, 101 AND 102). SN 77-149,577. PUB. 4-1-2008. FILED 4-5-2007.
- 3,566,449. **SENSATIONAL PLANS. SENSIBLE PRICING. (BLOCK FORM)**. RENAISSANCE HOLDING COMPANY, MULTIPLE CLASS, (INT. CLS. 35 AND 36), (U.S. CLS. 100, 101 AND 102). SN 77-152,945. PUB. 11-11-2008. FILED 4-10-2007.
- 3,566,457. **CEOS AGAINST CANCER (BLOCK FORM)**. AMERICAN CANCER SOCIETY, INC., (U.S. CLS. 100, 101 AND 102). SN 77-175,226. PUB. 11-11-2008. FILED 5-8-2007.
- 3,566,458. **CEOS AGAINST CANCER AMERICAN CANCER SOCIETY PREVENTION THROUGH PARTNERSHIP AND DESIGN**. AMERICAN CANCER SOCIETY, INC., (U.S. CLS. 100, 101 AND 102). SN 77-175,718. PUB. 11-11-2008. FILED 5-8-2007.
- 3,566,460. **CLICKINSIGHT (BLOCK FORM)**. CLICKINSIGHT CORPORATION, (U.S. CLS. 100, 101 AND 102). SN 77-179,785. PUB. 11-11-2008. FILED 5-14-2007.
- 3,566,461. **THE CRYSTAL PAVILION (BLOCK FORM)**. WATERFORD WEDGWOOD PLC, MULTIPLE CLASS, (INT. CLS. 35, 39, 41, 43 AND 45), (U.S. CLS. 100, 101, 102, 105 AND 107). SN 77-179,916. PUB. 11-11-2008. FILED 5-14-2007.
- 3,566,468. **CHARMING SHOPPES, INC. (BLOCK FORM)**. C.S.F. CORP., MULTIPLE CLASS, (INT. CLS. 35 AND 36), (U.S. CLS. 100, 101 AND 102). SN 77-187,442. PUB. 11-11-2008. FILED 5-22-2007.
- 3,566,474. **NWAF SOLUTIONS DEPOT (BLOCK FORM)**. NORTHWEST AREA FOUNDATION, (U.S. CLS. 100, 101 AND 102). SN 77-196,678. PUB. 11-11-2008. FILED 6-4-2007.
- 3,566,475. **POWERMARKETEUR (STYLIZED)**. THE FOURNAISE MARKETING GROUP PTE LTD, (U.S. CLS. 100, 101 AND 102). SN 77-198,547. PUB. 11-11-2008. FILED 6-5-2007.
- 3,566,477 (*See Class 30 for this trademark*).
- 3,566,480. **CURBSTREAM (BLOCK FORM)**. IMAGESPAN, INC., MULTIPLE CLASS, (INT. CLS. 35, 38 AND 42), (U.S. CLS. 100, 101, 102 AND 104). SN 77-204,614. PUB. 11-11-2008. FILED 6-13-2007.
- 3,566,481. **AVANT HEALTHCARE MARKETING, A DIVISION OF DEBORAH WOOD ASSOCIATES (BLOCK FORM)**. DEBORAH WOOD ASSOCIATES, INC., (U.S. CLS. 100, 101 AND 102). SN 77-206,958. PUB. 11-11-2008. FILED 6-15-2007.
- 3,566,509 (*See Class 9 for this trademark*).
- 3,566,519. **KPA (BLOCK FORM)**. KIP PRAHL ASSOCIATES LLC, (U.S. CLS. 100, 101 AND 102). SN 77-252,119. PUB. 11-11-2008. FILED 8-10-2007.
- 3,566,522. **YAMAMAY AND DESIGN**. INTICOM S.P.A., (U.S. CLS. 100, 101 AND 102). SN 77-254,882. PUB. 11-11-2008. FILED 8-14-2007.
- 3,566,531. **ME MANAGEMENT EXPERTS, INC AND DESIGN**. MANAGEMENT EXPERTS, INC, (U.S. CLS. 100, 101 AND 102). SN 77-262,809. PUB. 11-11-2008. FILED 8-23-2007.
- 3,566,545. **E EXPEDIA PARTNER SERVICES GROUP (STYLIZED)**. EXPEDIA, INC., (U.S. CLS. 100, 101 AND 102). SN 77-279,918. PUB. 11-11-2008. FILED 9-14-2007.
- 3,566,555. **SOCIAL CHANGE STARTS HERE (BLOCK FORM)**. ECHOING GREEN FOUNDATION, MULTIPLE CLASS, (INT. CLS. 35 AND 41), (U.S. CLS. 100, 101, 102 AND 107). SN 77-288,205. PUB. 11-11-2008. FILED 9-25-2007.
- 3,566,559. **BOARDROOM COMMUNICATIONS (BLOCK FORM)**. BOARDROOM COMMUNICATIONS, INC., (U.S. CLS. 100, 101 AND 102). SN 77-293,566. PUB. 11-11-2008.

- FILED 10-2-2007.
- 3,566,563. **IHFC (BLOCK FORM)**. IHFC PROPERTIES, LLC, (U.S. CLS. 100, 101 AND 102). SN 77-298,511. PUB. 11-11-2008. FILED 10-8-2007.
- 3,566,564. **IHFC AND DESIGN**. IHFC PROPERTIES, LLC, (U.S. CLS. 100, 101 AND 102). SN 77-298,515. PUB. 11-11-2008. FILED 10-8-2007.
- 3,566,571. **GREEN IS CLEAN (BLOCK FORM)**. ROBERT D. BOTELHO JR., (U.S. CLS. 100, 101 AND 102). SN 77-307,309. PUB. 11-11-2008. FILED 10-18-2007.
- 3,566,572. **MISCELLANEOUS DESIGN**. ROBERT D. BOTELHO JR., (U.S. CLS. 100, 101 AND 102). SN 77-307,477. PUB. 11-11-2008. FILED 10-18-2007.
- 3,566,574. **COAST TO COAST MOTORS (BLOCK FORM)**. HASHIMI, KAMAL S., (U.S. CLS. 100, 101 AND 102). SN 77-311,681. PUB. 11-11-2008. FILED 10-23-2007.
- 3,566,578. **NUTRA NUTRA.COM THE NUTRITIONAL INDUSTRY MARKET PLACE AND DESIGN**. DELALLA, PAUL V. JR., (U.S. CLS. 100, 101 AND 102). SN 77-315,526. PUB. 11-11-2008. FILED 10-29-2007.
- 3,566,579. **GEARWORKS (BLOCK FORM)**. GEARWORKS, INC., MULTIPLE CLASS, (INT. CLS. 35 AND 42), (U.S. CLS. 100, 101 AND 102). SN 77-315,747. PUB. 11-11-2008. FILED 10-29-2007.
- 3,566,592. **YEONAY (BLOCK FORM)**. PATEL, RUPEN BIPIN, (U.S. CLS. 100, 101 AND 102). SN 77-322,208. PUB. 11-11-2008. FILED S.R. 11-6-2007; AM. P.R. 10-6-2008.
- 3,566,593. **RENOVO ENERGY (BLOCK FORM)**. RENOV ENERGY LLC, (U.S. CLS. 100, 101 AND 102). SN 77-322,360. PUB. 11-11-2008. FILED 11-6-2007.
- 3,566,594. **FLUID INNOVATION AND DESIGN**. FLUID INNOVATION GROUP, INC., MULTIPLE CLASS, (INT. CLS. 35, 42 AND 45), (U.S. CLS. 100, 101 AND 102). SN 77-323,068. PUB. 11-11-2008. FILED 11-6-2007.
- 3,566,595. **PROVENTUS (BLOCK FORM)**. PROVENTUS AKTIEBOG, (U.S. CLS. 100, 101 AND 102). SN 77-323,149. PUB. 11-11-2008. FILED 11-6-2007.
- 3,566,598. **PAPELEO INC (BLOCK FORM)**. KRUEGER, JEFFREY W, DBA PAPELEO INC, (U.S. CLS. 100, 101 AND 102). SN 77-324,870. PUB. 11-11-2008. FILED 11-8-2007.
- 3,566,605. **ADVOC (BLOCK FORM)**. ADVOC LIMITED, MULTIPLE CLASS, (INT. CLS. 35 AND 45), (U.S. CLS. 100, 101 AND 102). SN 77-325,695. PUB. 11-11-2008. FILED 11-9-2007.
- 3,566,607. **ADVOC AND DESIGN**. ADVOC LIMITED, MULTIPLE CLASS, (INT. CLS. 35 AND 45), (U.S. CLS. 100, 101 AND 102). SN 77-325,990. PUB. 11-11-2008. FILED 11-9-2007.
- 3,566,610. **WESTERN DAIRY ASSOCIATION (BLOCK FORM)**. WESTERN DAIRY ASSOCIATION, MULTIPLE CLASS, (INT. CLS. 35 AND 41), (U.S. CLS. 100, 101, 102 AND 107). SN 77-326,797. PUB. 11-11-2008. FILED 11-12-2007.
- 3,566,614. **GET ACTIVE. GET REWARDS. (BLOCK FORM)**. VIRGIN HEALTHMILES, INC., MULTIPLE CLASS, (INT. CLS. 35 AND 41), (U.S. CLS. 100, 101, 102 AND 107). SN 77-328,411. PUB. 11-11-2008. FILED 11-13-2007.
- 3,566,615. **LIVE LIFE LIVELY (BLOCK FORM)**. VIRGIN HEALTHMILES, INC., MULTIPLE CLASS, (INT. CLS. 35 AND 41), (U.S. CLS. 100, 101, 102 AND 107). SN 77-328,568. PUB. 11-11-2008. FILED 11-13-2007.
- 3,566,618. **TECHOUSE (BLOCK FORM)**. TACTICAL SOLUTION PARTNERS, INC., DBA PELICAN MOBILE COMPUTERS, INC., (U.S. CLS. 100, 101 AND 102). SN 77-329,223. PUB. 11-11-2008. FILED 11-14-2007.
- 3,566,621. **CLICK2FIND.ORG (STYLIZED)**. SYSTEM 48 PLUS, INC., MULTIPLE CLASS, (INT. CLS. 35 AND 42), (U.S. CLS. 100, 101 AND 102). SN 77-331,626. PUB. 11-11-2008. FILED 11-16-2007.
- 3,566,633. **1-800-WE-INSURE (BLOCK FORM)**. 800 MARKETING SOLUTIONS, INC., MULTIPLE CLASS, (INT. CLS. 35 AND 36), (U.S. CLS. 100, 101 AND 102). SN 77-334,964. PUB. 11-11-2008. FILED 11-21-2007.
- 3,566,636. **PONOKO (BLOCK FORM)**. PONOKO LIMITED, MULTIPLE CLASS, (INT. CLS. 35, 40 AND 42), (U.S. CLS. 100, 101, 102, 103 AND 106). SN 77-337,046. PUB. 11-11-2008. FILED 11-26-2007.
- 3,566,640. **DEATHIVERSARY (BLOCK FORM)**. A&E TELEVISION NETWORKS, MULTIPLE CLASS, (INT. CLS. 35 AND 41), (U.S. CLS. 100, 101, 102 AND 107). SN 77-338,675. PUB. 11-11-2008. FILED 11-28-2007.
- 3,566,644. **FILELATE (STYLIZED)**. FAMKE HOLDINGS CORPORATION, (U.S. CLS. 100, 101 AND 102). SN 77-339,402. PUB. 11-11-2008. FILED 11-28-2007.
- 3,566,646. **RCP (BLOCK FORM)**. RCP, INC., (U.S. CLS. 100, 101 AND 102). SN 77-339,752. PUB. 11-11-2008. FILED 11-29-2007.
- 3,566,666. **KIQZOO (BLOCK FORM)**. UNITED GENERAL TRADING, INC., (U.S. CLS. 100, 101 AND 102). SN 77-345,956. PUB. 11-11-2008. FILED 12-6-2007.
- 3,566,667. **PREQUENCE REAL ESTATE INFO THROUGH YOUR CELL PHONE ... INSTANTLY! AND DESIGN**. RODIN, MOSES, MULTIPLE CLASS, (INT. CLS. 35 AND 36), (U.S. CLS. 100, 101 AND 102). SN 77-346,370. PUB. 11-11-2008. FILED 12-7-2007.
- 3,566,669. **WORLD'S GREATEST BOAT SHOW.COM (BLOCK FORM)**. BOATTEST.COM, LLC, (U.S. CLS. 100, 101 AND 102). SN 77-346,924. PUB. 11-11-2008. FILED 12-7-2007.
- 3,566,679. **XSCAPES (STYLIZED)**. POWERS, MATTHEW A., AND XSCAPES, LLC, (U.S. CLS. 100, 101 AND 102). SN 77-349,135. PUB. 11-11-2008. FILED 12-11-2007.
- 3,566,680. **EVERY PRODUCT COMBINES (BLOCK FORM)**. MORGAN CHANEY LLC, (U.S. CLS. 100, 101 AND 102). SN 77-349,323. PUB. 11-11-2008. FILED 12-11-2007.
- 3,566,686. **SIGMA SOLUTION ELECTRONIC END TO END PROCESS AND DESIGN**. ALPHA REVIEW CORPORATION, (U.S. CLS. 100, 101 AND 102). SN 77-349,928. PUB. 11-11-2008. FILED 12-12-2007.
- 3,566,688. **DARKSTRAND (BLOCK FORM)**. DARKSTRAND, INC., MULTIPLE CLASS, (INT. CLS. 35 AND 42), (U.S. CLS. 100, 101 AND 102). SN 77-350,623. PUB. 11-11-2008. FILED 12-12-2007.
- 3,566,692. **YOUR TRIP BEGINS AT MICHIGAN.ORG (BLOCK FORM)**. MICHIGAN ECONOMIC DEVELOPMENT CORPORATION, (U.S. CLS. 100, 101 AND 102). SN 77-351,465. PUB. 11-11-2008. FILED 12-13-2007.
- 3,566,700. **STRATEGIC GUARDRAILS (BLOCK FORM)**. TRIAL EXHIBITS, INC., DBA PENNEBAKER, (U.S. CLS. 100, 101 AND 102). SN 77-353,415. PUB. 11-11-2008. FILED 12-17-2007.
- 3,566,703. **MISCELLANEOUS DESIGN**. COOCUU, INC., (U.S. CLS. 100, 101 AND 102). SN 77-354,219. PUB. 11-11-2008. FILED 12-17-2007.
- 3,566,705. **STUDY CIRCLES RESOURCE CENTER (BLOCK FORM)**. THE PAUL J. AICHER FOUNDATION, INC., MULTIPLE CLASS, (INT. CLS. 35 AND 41), (U.S. CLS. 100, 101, 102 AND 107). SN 77-354,396. PUB. 11-11-2008. FILED 12-18-2007.
- 3,566,708. **FORSALEFLIX (BLOCK FORM)**. SUNSHINE GLOBAL MEDIA GROUP, LLC, (U.S. CLS. 100, 101 AND 102). SN 77-355,759. PUB. 11-11-2008. FILED 12-19-2007.
- 3,566,713. **WOODFINDER (BLOCK FORM)**. VALENTINE, ELLIS, (U.S. CLS. 100, 101 AND 102). SN 77-357,076. PUB. 11-11-2008. FILED 12-20-2007.
- 3,566,714. **UNION SPORTSMEN'S ALLIANCE USA AND DESIGN**. THEODORE ROOSEVELT CONSERVATION PARTNERSHIP, (U.S. CLS. 100, 101 AND 102). SN 77-357,466. PUB. 11-11-2008. FILED 12-20-2007.
- 3,566,715. **NO PANIC COMPUTING (BLOCK FORM)**. KEATING TECHNOLOGIES INC., MULTIPLE CLASS, (INT. CLS. 35, 37 AND 42), (U.S. CLS. 100, 101, 102, 103 AND 106). SN 77-358,561. PUB. 11-11-2008. FILED 12-21-2007.
- 3,566,721. **IMMERZIONS AND DESIGN**. NATURAL MARKETING INSTITUTE, (U.S. CLS. 100, 101 AND 102). SN 77-360,171. PUB. 11-11-2008. FILED 12-27-2007.
- 3,566,722. **FOOD ACTIVES (BLOCK FORM)**. NATURAL MARKETING INSTITUTE, (U.S. CLS. 100, 101 AND 102). SN 77-360,347. PUB. 11-11-2008. FILED 12-27-2007.
- 3,566,723. **MASADA LEATHER & OUTDOOR (BLOCK FORM)**. MASADA LEATHER COMPANY, INC., (U.S. CLS. 100, 101 AND 102). SN 77-360,908. PUB. 11-11-2008. FILED 12-28-2007.
- 3,566,725. **GIVINGWORKS (BLOCK FORM)**. GIVINGWORKS INC., (U.S. CLS. 100, 101 AND 102). SN 77-361,906. PUB. 11-11-2008. FILED 12-31-2007.
- 3,566,728. **PERFECT MATCH (BLOCK FORM)**. PUGET SOUND BLOOD CENTER AND PROGRAM, (U.S. CLS.

- 100, 101 AND 102). SN 77-362,532. PUB. 11-11-2008. FILED 1-2-2008.
- 3,566,731. **ANTHOLOGYBUILDER (BLOCK FORM)**. FULDA, NANCY E., (U.S. CLS. 100, 101 AND 102). SN 77-363,040. PUB. 11-11-2008. FILED 1-3-2008.
- 3,566,742. **KILPATRICK (BLOCK FORM)**. THE KILPATRICK COMPANY, INC., (U.S. CLS. 100, 101 AND 102). SN 77-367,012. PUB. 11-11-2008. FILED 1-8-2008.
- 3,566,743. **SHOPPING CONFESSIONS (BLOCK FORM)**. MODASOLUTIONS CORPORATION, (U.S. CLS. 100, 101 AND 102). SN 77-367,041. PUB. 11-11-2008. FILED 1-8-2008.
- 3,566,748. **SECURPLACE (BLOCK FORM)**. HUFFMASTER COMPANIES, MULTIPLE CLASS, (INT. CLS. 35, 36 AND 45), (U.S. CLS. 100, 101 AND 102). SN 77-370,977. PUB. 11-11-2008. FILED 1-14-2008.
- 3,566,752. **DOVETAIL SOLUTIONS REVOLUTIONIZING THE RELATIONSHIP BETWEEN BUSINESS & COMMUNITY AND DESIGN**. DOVETAIL SOLUTIONS INC., (U.S. CLS. 100, 101 AND 102). SN 77-372,251. PUB. 11-11-2008. FILED 1-15-2008.
- 3,566,753. **CLUBSPACES (BLOCK FORM)**. CLUBSPACES, INC., MULTIPLE CLASS, (INT. CLS. 35, 38 AND 42), (U.S. CLS. 100, 101, 102 AND 104). SN 77-372,556. PUB. 11-11-2008. FILED 1-15-2008.
- 3,566,765. **RELATIONSHIP - CENTERED LEADERSHIP (BLOCK FORM)**. THE RENEWAL GROUP INC., AND WOJICK, THOMAS J., (U.S. CLS. 100, 101 AND 102). SN 77-380,684. PUB. 11-11-2008. FILED 1-25-2008.
- 3,566,770. **GO AHEAD. SEE THE POSSIBILITIES. (BLOCK FORM)**. FOREMOST CORPORATION OF AMERICA, MULTIPLE CLASS, (INT. CLS. 35 AND 36), (U.S. CLS. 100, 101 AND 102). SN 77-386,261. PUB. 11-11-2008. FILED 2-1-2008.
- 3,566,776. **INTERNATIONAL ASSOCIATION OF STRUCTURAL INTEGRATORS (BLOCK FORM)**. INTERNATIONAL ASSOCIATION OF STRUCTURAL INTEGRATORS, (U.S. CLS. 100, 101 AND 102). SN 77-390,357. PUB. 11-11-2008. FILED 2-6-2008.
- 3,566,777. **LIMETREE (BLOCK FORM)**. LIMETREE, INC., (U.S. CLS. 100, 101 AND 102). SN 77-392,443. PUB. 11-11-2008. FILED 2-8-2008.
- 3,566,786. **CARPET ONE FLOOR & HOME (BLOCK FORM)**. CCA GLOBAL PARTNERS, INC., (U.S. CLS. 100, 101 AND 102). SN 77-396,255. PUB. 11-11-2008. FILED 2-13-2008.
- 3,566,792. **C.A.R.E.S. (BLOCK FORM)**. LIBERTY MUTUAL INSURANCE COMPANY, MULTIPLE CLASS, (INT. CLS. 35 AND 36), (U.S. CLS. 100, 101 AND 102). SN 77-401,734. PUB. 11-11-2008. FILED 2-20-2008.
- 3,566,794. **PAR 100 (BLOCK FORM)**. LIBERTY MUTUAL INSURANCE COMPANY, MULTIPLE CLASS, (INT. CLS. 35 AND 36), (U.S. CLS. 100, 101 AND 102). SN 77-402,434. PUB. 11-11-2008. FILED 2-21-2008.
- 3,566,796. **DIAMOND FINANCIAL AND DESIGN**. DIAMOND FINANCIAL SERVICES, INC., MULTIPLE CLASS, (INT. CLS. 35 AND 36), (U.S. CLS. 100, 101 AND 102). SN 77-406,400. PUB. 11-11-2008. FILED 2-26-2008.
- 3,566,809. **SHOP + MINGLE (BLOCK FORM)**. VALERIE IDEHEN, (U.S. CLS. 100, 101 AND 102). SN 77-412,561. PUB. 11-11-2008. FILED 3-4-2008.
- 3,566,813. **ASI GLOBAL (BLOCK FORM)**. ASI GLOBAL, L.L.C., MULTIPLE CLASS, (INT. CLS. 35, 41, 44 AND 45), (U.S. CLS. 100, 101, 102 AND 107). SN 77-416,475. PUB. 11-11-2008. FILED 3-7-2008.
- 3,566,816. **LITTLEYE (BLOCK FORM)**. LITTLEYE LLC, (U.S. CLS. 100, 101 AND 102). SN 77-417,627. PUB. 11-11-2008. FILED S.R. 3-10-2008; AM. P.R. 7-8-2008.
- 3,566,819. **MISCELLANEOUS DESIGN**. DEUTSCHE TELEKOM, (U.S. CLS. 100, 101 AND 102). SN 77-420,844. PUB. 9-2-2008. FILED 3-13-2008.
- 3,566,821. **NATIONAL SOCIETY OF PROFESSIONAL ENGINEERS (BLOCK FORM)**. NATIONAL SOCIETY OF PROFESSIONAL ENGINEERS, (U.S. CLS. 100, 101 AND 102). SN 77-422,204. PUB. 11-11-2008. FILED 3-14-2008.
- 3,566,822. **PE NATIONAL SOCIETY OF PROFESSIONAL ENGINEERS AND DESIGN**. NATIONAL SOCIETY OF PROFESSIONAL ENGINEERS, (U.S. CLS. 100, 101 AND 102). SN 77-422,275. PUB. 11-11-2008. FILED 3-14-2008.
- 3,566,845. **HLC AND DESIGN**. HEALTHY LIFESTYLE CHOICES, (U.S. CLS. 100, 101 AND 102). SN 77-439,418. PUB. 11-11-2008. FILED 4-3-2008.
- 3,566,855 (*See Class 18 for this trademark*).
- 3,566,856. **E ELOTEK SYSTEMS, INC. AND DESIGN**. MICHAEL ELOVITZ, (U.S. CLS. 100, 101 AND 102). SN 77-442,859. PUB. 11-11-2008. FILED 4-8-2008.
- 3,566,862. **COMMUNICATIONS, INK MARKETING INSIGHT, PROVEN EXPERIENCE (STYLIZED)**. HUTCHINS, CARA, (U.S. CLS. 100, 101 AND 102). SN 77-445,559. PUB. 11-11-2008. FILED 4-10-2008.
- 3,566,869 (*See Class 31 for this trademark*).
- 3,566,873. **K KOTT KOATINGS AND DESIGN**. KOTT KOATINGS, INC., MULTIPLE CLASS, (INT. CLS. 35 AND 37), (U.S. CLS. 100, 101, 102, 103 AND 106). SN 77-449,234. PUB. 11-11-2008. FILED 4-16-2008.
- 3,566,874. **MISCELLANEOUS DESIGN**. KOTT KOATINGS, INC., MULTIPLE CLASS, (INT. CLS. 35 AND 37), (U.S. CLS. 100, 101, 102, 103 AND 106). SN 77-449,241. PUB. 11-11-2008. FILED 4-16-2008.
- 3,566,878. **AUER AGENCY (BLOCK FORM)**. AUER AGENCY LLC, (U.S. CLS. 100, 101 AND 102). SN 77-451,006. PUB. 11-11-2008. FILED 4-17-2008.
- 3,566,901. **MISCELLANEOUS DESIGN**. ALESSIO-WAY, JEANETTE, MULTIPLE CLASS, (INT. CLS. 35 AND 41), (U.S. CLS. 100, 101, 102 AND 107). SN 77-462,064. PUB. 11-11-2008. FILED 4-30-2008.
- 3,566,907. **TRANSVERSE (BLOCK FORM)**. TRANSVERSE LLC, MULTIPLE CLASS, (INT. CLS. 35 AND 42), (U.S. CLS. 100, 101 AND 102). SN 77-463,695. PUB. 11-11-2008. FILED 5-1-2008.
- 3,566,926. **THE LEADERSHIP EDGE E AND DESIGN**. THE LEADERSHIP EDGE, INC., MULTIPLE CLASS, (INT. CLS. 35, 41 AND 45), (U.S. CLS. 100, 101, 102 AND 107). SN 77-470,399. PUB. 11-11-2008. FILED 5-9-2008.
- 3,566,927. **S SUSQUEHANNA RIVER VALLEY EVERY TURN A TREASURE AND DESIGN**. SUSQUEHANNA VALLEY VISITORS BUREAU, (U.S. CLS. 100, 101 AND 102). SN 77-470,572. PUB. 11-11-2008. FILED 5-9-2008.
- 3,566,945. **ZEN CLOSETS AND DESIGN**. THREE E FARMS, LLC., (U.S. CLS. 100, 101 AND 102). SN 77-476,327. PUB. 11-11-2008. FILED 5-16-2008.
- 3,566,955. **REALTIME DESIGN (BLOCK FORM)**. COOL SCHOOL INCENTIVES, INC., (U.S. CLS. 100, 101 AND 102). SN 77-479,354. PUB. 11-11-2008. FILED 5-20-2008.
- 3,566,957. **CC COALITION CRAWLERS AND DESIGN**. BROWN, DANIEL R., DBA COALITION CRAWLERS, AND SHERMAN, SAGE, (U.S. CLS. 100, 101 AND 102). SN 77-479,678. PUB. 11-11-2008. FILED 5-20-2008.
- 3,566,970. **APAWS ASSOCIATION OF PROFESSIONAL ANIMAL WASTE SPECIALISTS (BLOCK FORM)**. ASSOCIATION OF PROFESSIONAL ANIMAL WASTE SPECIALISTES, INC., (U.S. CLS. 100, 101 AND 102). SN 77-482,773. PUB. 11-11-2008. FILED 5-23-2008.
- 3,566,990. **AESTHETIC METEORITES (BLOCK FORM)**. BIRDELL, JOHN A., AND BIRDELL, DAWN, (U.S. CLS. 100, 101 AND 102). SN 77-485,385. PUB. 11-11-2008. FILED 5-28-2008.
- 3,566,998. **MIA DIMORA (BLOCK FORM)**. BROWN STREET INTERIORS, LLC, (U.S. CLS. 100, 101 AND 102). SN 77-486,478. PUB. 11-11-2008. FILED 5-29-2008.
- 3,567,003. **NASHVILLE IS TALKING (BLOCK FORM)**. YOUNG BROADCASTING OF NASHVILLE LLC, MULTIPLE CLASS, (INT. CLS. 35 AND 41), (U.S. CLS. 100, 101, 102 AND 107). SN 77-487,071. PUB. 11-11-2008. FILED 5-30-2008.
- 3,567,023. **YOUR TOWN, YOUR LIFE, YOUR WAY! (BLOCK FORM)**. EGGZACK.COM, LLC, (U.S. CLS. 100, 101 AND 102). SN 77-488,643. PUB. 11-11-2008. FILED 6-2-2008.
- 3,567,030. **THE LEADER IN LOCUM TENENS STAFFING (BLOCK FORM)**. AMN HEALTHCARE, INC., (U.S. CLS. 100, 101 AND 102). SN 77-490,013. PUB. 11-11-2008. FILED 6-3-2008.
- 3,567,033. **ECOTROTTERS AND DESIGN**. ALIWALK INTERNATIONAL S.A., MULTIPLE CLASS, (INT. CLS. 35 AND 43), (U.S. CLS. 100, 101 AND 102). SN 77-490,352. PUB. 11-11-2008. FILED 6-4-2008.
- 3,567,036. **EVERGREEN AND DESIGN**. EVERGREEN COMMUNITY ASSOCIATION, (U.S. CLS. 100, 101 AND 102). SN 77-490,510. PUB. 11-11-2008. FILED 6-4-2008.

- 3,567,049. **AVC DISTRIBUTOR AND DESIGN**. AVC DISTRIBUTOR, LLC, (U.S. CLS. 100, 101 AND 102). SN 77-491,572. PUB. 11-11-2008. FILED 6-5-2008.
- 3,567,068. **MAMABARGAINS (BLOCK FORM)**. SINGER, JESSICA M., AND SINGER, STANFORD A., (U.S. CLS. 100, 101 AND 102). SN 77-493,174. PUB. 11-11-2008. FILED 6-6-2008.
- 3,567,076. **A MIGHTY RIVER.COM THE BLACK PROFESSIONAL NETWORKING COMMUNITY AND DESIGN**. IHISPANO.COM, LLC, MULTIPLE CLASS, (INT. CLS. 35 AND 41), (U.S. CLS. 100, 101, 102 AND 107). SN 77-493,700. PUB. 11-11-2008. FILED 6-8-2008.
- 3,567,078. **HEALTH MASON (BLOCK FORM)**. NOVIN, SALADIN, (U.S. CLS. 100, 101 AND 102). SN 77-494,162. PUB. 11-11-2008. FILED 6-9-2008.
- 3,567,079. **STREETWISE SKATE SHOP SF AND DESIGN**. PLEMONS, JOHN DOUGLAS, (U.S. CLS. 100, 101 AND 102). SN 77-494,204. PUB. 11-11-2008. FILED 6-9-2008.
- 3,567,084. **SENTRUS GROUP AND DESIGN**. SENTRUS GROUP, INC., (U.S. CLS. 100, 101 AND 102). SN 77-494,291. PUB. 11-11-2008. FILED 6-9-2008.
- 3,567,095. **PRIVET HOUSE (BLOCK FORM)**. PRIVET HOUSE, LLC, (U.S. CLS. 100, 101 AND 102). SN 77-494,900. PUB. 11-11-2008. FILED 6-10-2008.
- 3,567,099. **ZENMANGO (BLOCK FORM)**. ARJUN SEN INC., DBA RESTAURANT MARKETING GROUP, (U.S. CLS. 100, 101 AND 102). SN 77-495,086. PUB. 11-11-2008. FILED 6-10-2008.
- 3,567,104. **WORKING TOGETHER FOR GOOD (BLOCK FORM)**. PILGRIM IMPORTS, INC., (U.S. CLS. 100, 101 AND 102). SN 77-495,470. PUB. 11-11-2008. FILED 6-10-2008.
- 3,567,105. **T YNUTHUT AND DESIGN**. EZ SUPER SELLERS, LLC, (U.S. CLS. 100, 101 AND 102). SN 77-496,056. PUB. 11-11-2008. FILED 6-11-2008.
- 3,567,107. **SUITECOMMUTE (BLOCK FORM)**. SUITECOMMUTE, (U.S. CLS. 100, 101 AND 102). SN 77-496,149. PUB. 11-11-2008. FILED 6-11-2008.
- 3,567,110. **OMNI CABLE (BLOCK FORM)**. OMNI CABLE CORPORATION, (U.S. CLS. 100, 101 AND 102). SN 77-496,384. PUB. 11-11-2008. FILED 6-11-2008.
- 3,567,121. **PERFORMANCE BENEFITS, INC. INNOVATIVE FINANCIAL SOLUTIONS AND DESIGN**. PERFORMANCE BENEFITS, INC., MULTIPLE CLASS, (INT. CLS. 35 AND 36), (U.S. CLS. 100, 101 AND 102). SN 77-496,576. PUB. 11-11-2008. FILED 6-11-2008.
- 3,567,132. **SMOOTHIEQUEEN & DNC "DISCOUNT" NUTRITIONAL CENTER HEALTHY LIVING AND DESIGN**. RODRIGUEZ, GEORGE, MULTIPLE CLASS, (INT. CLS. 35 AND 43), (U.S. CLS. 100, 101 AND 102). SN 77-496,878. PUB. 11-11-2008. FILED 6-11-2008.
- 3,567,143. **GLIMCHER (BLOCK FORM)**. GLIMCHER REALTY TRUST, MULTIPLE CLASS, (INT. CLS. 35, 36 AND 37), (U.S. CLS. 100, 101, 102, 103 AND 106). SN 77-497,396. PUB. 11-11-2008. FILED 6-12-2008.
- 3,567,157. **P PATIENTSCOUNT.COM AND DESIGN**. PATIENTS COUNT, LLC, (U.S. CLS. 100, 101 AND 102). SN 77-498,129. PUB. 11-11-2008. FILED 6-13-2008.
- 3,567,164. **ONE SOURCE FOR ALL YOUR PROMOTIONAL NEEDS (BLOCK FORM)**. EASY BUSINESS SERVICES, LLC, (U.S. CLS. 100, 101 AND 102). SN 77-498,273. PUB. 11-11-2008. FILED 6-13-2008.
- 3,567,167. **SCHOLARBUYS (BLOCK FORM)**. SCHOLARBUYS LLC, (U.S. CLS. 100, 101 AND 102). SN 77-498,437. PUB. 11-11-2008. FILED 6-13-2008.
- 3,567,170. **HOPE CHEST (BLOCK FORM)**. HOPE CHEST FOR BREAST CANCER FOUNDATION, (U.S. CLS. 100, 101 AND 102). SN 77-498,581. PUB. 11-11-2008. FILED 6-13-2008.
- 3,567,184. **HONOR THE PAST, CHALLENGE THE PRESENT, CREATE THE FUTURE! (BLOCK FORM)**. LEADERSHIP STRATEGIES INTERNATIONAL, (U.S. CLS. 100, 101 AND 102). SN 77-499,447. PUB. 11-11-2008. FILED 6-16-2008.
- 3,567,186 (*See Class 16 for this trademark*).
- 3,567,189. **PATIENT ASSIST (BLOCK FORM)**. PRITCHETT, WILLIE L., (U.S. CLS. 100, 101 AND 102). SN 77-499,574. PUB. 11-11-2008. FILED 6-16-2008.
- 3,567,190 (*See Class 19 for this trademark*).
- 3,567,193. **DYE FRESH (BLOCK FORM)**. CAMPOS JR., JOSE, (U.S. CLS. 100, 101 AND 102). SN 77-499,597. PUB. 11-11-2008. FILED 6-16-2008.
- 3,567,201. **APPLIANCE ZONE (BLOCK FORM)**. APPLIANCE REPAIR SOLUTIONS, LLC, (U.S. CLS. 100, 101 AND 102). SN 77-499,755. PUB. 11-11-2008. FILED 6-16-2008.
- 3,567,216 (*See Class 9 for this trademark*).
- 3,567,226. **INDIGGO ASSOCIATES (BLOCK FORM)**. INDIGGO ASSOCIATES, INC., (U.S. CLS. 100, 101 AND 102). SN 77-500,235. PUB. 11-11-2008. FILED 6-16-2008.
- 3,567,227 (*See Class 30 for this trademark*).
- 3,567,228. **CORE FOUNDATIONS FOR EXCELLENCE (BLOCK FORM)**. INDIGGO ASSOCIATES, INC., (U.S. CLS. 100, 101 AND 102). SN 77-500,246. PUB. 11-11-2008. FILED 6-16-2008.
- 3,567,231. **INSTRATEX (BLOCK FORM)**. INSTRATEX, INC., (U.S. CLS. 100, 101 AND 102). SN 77-500,301. PUB. 11-11-2008. FILED 6-16-2008.
- 3,567,240. **MISCELLANEOUS DESIGN**. JOBBOUND, (U.S. CLS. 100, 101 AND 102). SN 77-500,498. PUB. 11-11-2008. FILED 6-17-2008.
- 3,567,241. **JOBBOUND (BLOCK FORM)**. JOBBOUND, (U.S. CLS. 100, 101 AND 102). SN 77-500,501. PUB. 11-11-2008. FILED 6-17-2008.
- 3,567,242. **FANTOYSTIC TOYS & GIFTS (BLOCK FORM)**. OLDENBURG, LAURA J., (U.S. CLS. 100, 101 AND 102). SN 77-500,516. PUB. 11-11-2008. FILED 6-17-2008.
- 3,567,255. **KITCHEN KNEADS (BLOCK FORM)**. KITCHEN KNEADS, INC., (U.S. CLS. 100, 101 AND 102). SN 77-500,726. PUB. 11-11-2008. FILED 6-17-2008.
- 3,567,258. **DATE CHECK (BLOCK FORM)**. DCAEV, INC., (U.S. CLS. 100, 101 AND 102). SN 77-500,759. PUB. 11-11-2008. FILED 6-17-2008.
- 3,567,260. **HOOKLOGIC (BLOCK FORM)**. HOOKLOGIC, INC., (U.S. CLS. 100, 101 AND 102). SN 77-500,785. PUB. 11-11-2008. FILED 6-17-2008.
- 3,567,269. **RXRDR (BLOCK FORM)**. RX REVERSE DISTRIBUTORS, INC., (U.S. CLS. 100, 101 AND 102). SN 77-500,872. PUB. 11-11-2008. FILED 6-17-2008.
- 3,567,270. **FOREMOST PROFESSIONAL (BLOCK FORM)**. FOREMOST STAFFING, (U.S. CLS. 100, 101 AND 102). SN 77-500,873. PUB. 11-11-2008. FILED 6-17-2008.
- 3,567,282. **VALLUM RESOURCES MARKETING CLIENTS TO THE NEXT LEVEL (STYLIZED)**. VALLUM RESOURCES, LLC, (U.S. CLS. 100, 101 AND 102). SN 77-501,063. PUB. 11-11-2008. FILED 6-17-2008.
- 3,567,286. **METALLIANCE (BLOCK FORM)**. MUSIC ENGINEERING AND TECHNOLOGY ALLIANCE, LLC, MULTIPLE CLASS, (INT. CLS. 35 AND 42), (U.S. CLS. 100, 101 AND 102). SN 77-501,118. PUB. 11-11-2008. FILED 6-17-2008.
- 3,567,287. **CODEPINK (STYLIZED)**. CODEPINK ACTION FUND, DBA CODEPINK, (U.S. CLS. 100, 101 AND 102). SN 77-501,179. PUB. 11-11-2008. FILED 6-17-2008.
- 3,567,290. **GLENDALE'S GOT GAME ARIZONA AND DESIGN**. CITY OF GLENDALE, ARIZONA, (U.S. CLS. 100, 101 AND 102). SN 77-501,239. PUB. 11-11-2008. FILED 6-17-2008.
- 3,567,291. **THE BUSINESS BRICKYARD (BLOCK FORM)**. TBB PARTNERS INC., (U.S. CLS. 100, 101 AND 102). SN 77-501,263. PUB. 11-11-2008. FILED 6-17-2008.
- 3,567,292. **PIONEERS OF PROSPERITY (BLOCK FORM)**. OTF GROUP, INC., AND S.E. VEN FUND, INC., (U.S. CLS. 100, 101 AND 102). SN 77-501,268. PUB. 11-11-2008. FILED 6-17-2008.
- 3,567,302. **EVENINGLINK (BLOCK FORM)**. EVENINGLINK INC, (U.S. CLS. 100, 101 AND 102). SN 77-501,314. PUB. 11-11-2008. FILED 6-17-2008.
- 3,567,303. **HIPDR (BLOCK FORM)**. AMPC ACQUISITION, INC., (U.S. CLS. 100, 101 AND 102). SN 77-501,321. PUB. 11-11-2008. FILED 6-17-2008.
- 3,567,305. **CAGE CANDY AND DESIGN**. TATE, TRACY ELIZABETH, DBA CAGE CANDY, (U.S. CLS. 100, 101 AND 102). SN 77-501,362. PUB. 11-11-2008. FILED 6-18-2008.
- 3,567,308. **THE MINE AND DESIGN**. THE TALENT MINE, INC., (U.S. CLS. 100, 101 AND 102). SN 77-501,430. PUB. 11-11-2008. FILED 6-18-2008.
- 3,567,322. **LA CURACAO (BLOCK FORM)**. ADIR INTERNATIONAL, LLC, (U.S. CLS. 100, 101 AND 102). SN 77-501,664. PUB. 11-11-2008. FILED 6-18-2008.
- 3,567,335. **IAC (BLOCK FORM)**. INTERNATIONAL ASSOCIATION OF COACHING, (U.S. CLS. 100, 101 AND 102).

- SN 77-501,867. PUB. 11-11-2008. FILED 6-18-2008.
- 3,567,352. **A & D CREATIVE (BLOCK FORM)**. A & D CREATIVE BOUTIQUE, INC., MULTIPLE CLASS, (INT. CLS. 35 AND 42), (U.S. CLS. 100, 101 AND 102). SN 77-502,055. PUB. 11-11-2008. FILED 6-18-2008.
- 3,567,361. **PETRA NEMCOVA (BLOCK FORM)**. NEMCOVA, PETRA, MULTIPLE CLASS, (INT. CLS. 35 AND 41), (U.S. CLS. 100, 101, 102 AND 107). SN 77-502,205. PUB. 11-11-2008. FILED 6-18-2008.
- 3,567,362. **NEWSMETER (BLOCK FORM)**. TAYLOR, DOUGLAS B., (U.S. CLS. 100, 101 AND 102). SN 77-502,210. PUB. 11-11-2008. FILED 6-18-2008.
- 3,567,366. **TEAMSAVI (BLOCK FORM)**. CM MITCHELL CONSULTING, (U.S. CLS. 100, 101 AND 102). SN 77-502,297. PUB. 11-11-2008. FILED 6-18-2008.
- 3,567,367. **MISS MELLOW (BLOCK FORM)**. MISS MELLOW, (U.S. CLS. 100, 101 AND 102). SN 77-502,325. PUB. 11-11-2008. FILED 6-18-2008.
- 3,567,369. **TEA LARGO AND DESIGN**. PICASSO'S CUP, INC., (U.S. CLS. 100, 101 AND 102). SN 77-502,342. PUB. 11-11-2008. FILED 6-18-2008.
- 3,567,374. **5 AND DESIGN**. THERAPEUTIC RESEARCH CENTER, INC., (U.S. CLS. 100, 101 AND 102). SN 77-502,416. PUB. 11-11-2008. FILED 6-18-2008.
- 3,567,380. **AUTOSCRATCHPAD (BLOCK FORM)**. HUNT, JAMES B., (U.S. CLS. 100, 101 AND 102). SN 77-502,491. PUB. 11-11-2008. FILED 6-19-2008.
- 3,567,390. **AGING IN THE HOME (BLOCK FORM)**. TECHNOBRANDS, INC., DBA FIRSTSTREET, (U.S. CLS. 100, 101 AND 102). SN 77-502,646. PUB. 11-11-2008. FILED 6-19-2008.
- 3,567,396. **DEZIGNARE' (BLOCK FORM)**. DEZIGNARE' INTERIOR DESIGN COLLECTIVE, INC., (U.S. CLS. 100, 101 AND 102). SN 77-502,763. PUB. 11-11-2008. FILED 6-19-2008.
- 3,567,410. **ALEXANDER BABBAGE (BLOCK FORM)**. ALEXANDER BABBAGE, INC., (U.S. CLS. 100, 101 AND 102). SN 77-502,971. PUB. 11-11-2008. FILED 6-19-2008.
- 3,567,416. **NEXMARK (BLOCK FORM)**. NEXMARK, INC., (U.S. CLS. 100, 101 AND 102). SN 77-503,023. PUB. 11-11-2008. FILED 6-19-2008.
- 3,567,423. **THE LEADER'S PATH (BLOCK FORM)**. MAXCOMM, LLC, MULTIPLE CLASS, (INT. CLS. 35 AND 41), (U.S. CLS. 100, 101, 102 AND 107). SN 77-503,156. PUB. 11-11-2008. FILED 6-19-2008.
- 3,567,424. **M M (STYLIZED)**. MAKO METALS, INC., (U.S. CLS. 100, 101 AND 102). SN 77-503,208. PUB. 11-11-2008. FILED 6-19-2008.
- 3,567,425. **MAKO METALS (BLOCK FORM)**. MAKO METALS, INC., (U.S. CLS. 100, 101 AND 102). SN 77-503,240. PUB. 11-11-2008. FILED 6-19-2008.
- 3,567,426. **RUN IMPROVE GROW (BLOCK FORM)**. MIDWEST MANUFACTURING SOLUTIONS, LLC, (U.S. CLS. 100, 101 AND 102). SN 77-503,310. PUB. 11-11-2008. FILED 6-19-2008.
- 3,567,440. **DISPLAYWARE (BLOCK FORM)**. DISPLAYWARE LLC, (U.S. CLS. 100, 101 AND 102). SN 77-503,516. PUB. 11-11-2008. FILED 6-19-2008.
- 3,567,444. **EEK TECHNOLOGY (BLOCK FORM)**. JOSEPH P. CHRISTIAN, (U.S. CLS. 100, 101 AND 102). SN 77-503,532. PUB. 11-11-2008. FILED 6-19-2008.
- 3,567,455. **TOTAL INFO (BLOCK FORM)**. LEIGHTRONIX, INC., (U.S. CLS. 100, 101 AND 102). SN 77-503,789. PUB. 11-11-2008. FILED 6-20-2008.
- 3,567,457. **MONSTER INTELLIGENCE (BLOCK FORM)**. MONSTER (CALIFORNIA), INC., MULTIPLE CLASS, (INT. CLS. 35 AND 41), (U.S. CLS. 100, 101, 102 AND 107). SN 77-503,792. PUB. 11-11-2008. FILED 6-20-2008.
- 3,567,460. **PRECIOUS KITTENS CATTERY (BLOCK FORM)**. MACKEY, PRECIOUS, (U.S. CLS. 100, 101 AND 102). SN 77-503,888. PUB. 11-11-2008. FILED 6-20-2008.
- 3,567,466. **LICENSE TO SHOP (BLOCK FORM)**. GLIMCHER REALTY TRUST, (U.S. CLS. 100, 101 AND 102). SN 77-504,209. PUB. 11-11-2008. FILED 6-20-2008.
- 3,567,475. **AMERICAN SADDLEBRED REGISTRY, INC. AND DESIGN**. AMERICAN SADDLEBRED REGISTRY, INC., (U.S. CLS. 100, 101 AND 102). SN 77-504,350. PUB. 11-11-2008. FILED 6-20-2008.
- 3,567,478. **CLASS (BLOCK FORM)**. CLASS EVENTS, LLC, (U.S. CLS. 100, 101 AND 102). SN 77-504,420. PUB. 11-11-2008. FILED 6-20-2008.
- 3,567,480. **BAPS SHAYONA (BLOCK FORM)**. BOCHASANWASI SHRI AKSHAR PURUSHOTTAM SWAMINARAYAN SANSTHA, INC., MULTIPLE CLASS, (INT. CLS. 35 AND 43), (U.S. CLS. 100, 101 AND 102). SN 77-504,474. PUB. 11-11-2008. FILED 6-20-2008.
- 3,567,482. **SUPPLYSIDE (BLOCK FORM)**. VIRGO PUBLISHING, LLC, (U.S. CLS. 100, 101 AND 102). SN 77-504,543. PUB. 11-11-2008. FILED 6-20-2008.
- 3,567,483. **HUGGABLE ME (STYLIZED)**. CENTIGAL INCORPORATED, DBA HUGGABLE ME, (U.S. CLS. 100, 101 AND 102). SN 77-504,586. PUB. 11-11-2008. FILED 6-20-2008.
- 3,567,484. **EPARTY UNLIMITED (BLOCK FORM)**. EPARTY UNLIMITED, INC., (U.S. CLS. 100, 101 AND 102). SN 77-504,593. PUB. 11-11-2008. FILED 6-20-2008.
- 3,567,486. **EVENTS OF THE HEART AND DESIGN**. EVENTS OF THE HEART, INC., (U.S. CLS. 100, 101 AND 102). SN 77-504,623. PUB. 11-11-2008. FILED 6-20-2008.
- 3,567,497. **THE APPOINTMENT MACHINE (BLOCK FORM)**. STRICTLY DIRECT, INC., (U.S. CLS. 100, 101 AND 102). SN 77-504,836. PUB. 11-11-2008. FILED 6-21-2008.
- 3,567,498. **MEZIAB (BLOCK FORM)**. MEZIAB INTERNATIONAL, L.L.C., (U.S. CLS. 100, 101 AND 102). SN 77-504,840. PUB. 11-11-2008. FILED 6-21-2008.
- 3,567,514. **MYOFFICES (BLOCK FORM)**. BENJAMIN, CLEVELAND, (U.S. CLS. 100, 101 AND 102). SN 77-505,210. PUB. 11-11-2008. FILED 6-23-2008.
- 3,567,540. **WHERE THE PRICE IS THE POINT (BLOCK FORM)**. PRICEPOINT FURNITURE, INC., DBA PRICE POINT FURNITURE, (U.S. CLS. 100, 101 AND 102). SN 77-505,688. PUB. 11-11-2008. FILED 6-23-2008.
- 3,567,543. **PRICE POINT FURNITURE (BLOCK FORM)**. PRICEPOINT FURNITURE, INC., DBA PRICE POINT FURNITURE, (U.S. CLS. 100, 101 AND 102). SN 77-505,693. PUB. 11-11-2008. FILED 6-23-2008.
- 3,567,544. **STICKS & STRINGS (BLOCK FORM)**. STICKS AND STRINGS, LLC, MULTIPLE CLASS, (INT. CLS. 35 AND 41), (U.S. CLS. 100, 101, 102 AND 107). SN 77-505,724. PUB. 11-11-2008. FILED 6-23-2008.
- 3,567,545. **SAFETY FROM THE BEGINNING (BLOCK FORM)**. LIFELINK FOUNDATION, INC., (U.S. CLS. 100, 101 AND 102). SN 77-505,744. PUB. 11-11-2008. FILED 6-23-2008.
- 3,567,546. **PR CE PO NT FURN TURE "WHERE THE PRICE IS THE POINT" AND DESIGN**. PRICEPOINT FURNITURE, INC., DBA PRICE POINT FURNITURE, (U.S. CLS. 100, 101 AND 102). SN 77-505,775. PUB. 11-11-2008. FILED 6-23-2008.
- 3,567,550. **ZABAR'S (BLOCK FORM)**. ZABAR'S & CO., INC., MULTIPLE CLASS, (INT. CLS. 35 AND 43), (U.S. CLS. 100, 101 AND 102). SN 77-505,850. PUB. 11-11-2008. FILED 6-23-2008.
- 3,567,576. **INDIEBOUND (BLOCK FORM)**. AMERICAN BOOKSELLERS ASSOCIATION, INC., (U.S. CLS. 100, 101 AND 102). SN 77-506,707. PUB. 11-11-2008. FILED 6-24-2008.
- 3,567,582. **REALTYTMS (BLOCK FORM)**. REALTYTMS, INC., (U.S. CLS. 100, 101 AND 102). SN 77-506,765. PUB. 11-11-2008. FILED 6-24-2008.
- 3,567,588. **REALTYTMS AND DESIGN**. REALTYTMS, INC., (U.S. CLS. 100, 101 AND 102). SN 77-506,823. PUB. 11-11-2008. FILED 6-24-2008.
- 3,567,594. **SEFA SPELLS SAFE (BLOCK FORM)**. SCIENTIFIC EQUIPMENT AND FURNITURE ASSOCIATION, (U.S. CLS. 100, 101 AND 102). SN 77-506,920. PUB. 11-11-2008. FILED 6-24-2008.
- 3,567,595. **IDEALAND (BLOCK FORM)**. IDEALAND LLC, (U.S. CLS. 100, 101 AND 102). SN 77-506,924. PUB. 11-11-2008. FILED 6-24-2008.
- 3,567,598. **I AND DESIGN**. AMERICAN BOOKSELLERS ASSOCIATION, INC., (U.S. CLS. 100, 101 AND 102). SN 77-507,029. PUB. 11-11-2008. FILED 6-24-2008.
- 3,567,606. **NEIGHBOR TO NEIGHBOR (BLOCK FORM)**. NEIGHBOR TO NEIGHBOR, INC., (U.S. CLS. 100, 101 AND 102). SN 77-507,232. PUB. 11-11-2008. FILED 6-24-2008.
- 3,567,623. **URBAN DECAY (BLOCK FORM)**. URBAN DECAY COSMETICS, LLC, (U.S. CLS. 100, 101 AND 102). SN 77-508,705. PUB. 11-11-2008. FILED 6-26-2008.
- 3,567,624. **BEAUTY WITH AN EDGE (BLOCK FORM)**. URBAN DECAY COSMETICS, LLC, (U.S. CLS. 100, 101

- AND 102). SN 77-508,715. PUB. 11-11-2008. FILED 6-26-2008.
- 3,567,629. **WIT INC (BLOCK FORM)**. WAVE IMAGING TECHNOLOGY INC., DBA WAVE IMAGING, WIT INC., MULTIPLE CLASS, (INT. CLS. 35 AND 42), (U.S. CLS. 100, 101 AND 102). SN 77-510,560. PUB. 11-11-2008. FILED 6-28-2008.
- 3,567,643. **INFORMEDRX AND DESIGN**. INFORMEDRX, INC., (U.S. CLS. 100, 101 AND 102). SN 77-512,531. PUB. 11-11-2008. FILED 7-1-2008.
- 3,567,650. **MAPAD (BLOCK FORM)**. MAPDENTIST, INC., (U.S. CLS. 100, 101 AND 102). SN 77-515,341. PUB. 11-11-2008. FILED 7-6-2008.
- 3,567,658 (*See Class 25 for this trademark*).
- 3,567,660. **WE DO THE STUFF THAT MATTERS (BLOCK FORM)**. WEBER ADVERTISING AND MARKETING, (U.S. CLS. 100, 101 AND 102). SN 77-518,984. PUB. 11-11-2008. FILED S.R. 7-10-2008; AM. P.R. 9-22-2008.
- 3,567,680 (*See Class 25 for this trademark*).
- 3,567,681. **DERRIE-AIR (BLOCK FORM)**. GYRO ADVERTISING, INC., (U.S. CLS. 100, 101 AND 102). SN 77-524,780. PUB. 11-11-2008. FILED 7-17-2008.
- 3,567,714. **GOLDFELLOW (BLOCK FORM)**. GOLDFELLOW, LLC, (U.S. CLS. 100, 101 AND 102). SN 77-544,452. PUB. 11-11-2008. FILED 8-12-2008.
- 3,567,718. **SALAD BISTRO (BLOCK FORM)**. VENTURA FOODS, LLC, (U.S. CLS. 100, 101 AND 102). SN 77-548,523. PUB. 11-11-2008. FILED 8-15-2008.
- 3,567,723. **APPLIANCEZONE.COM (BLOCK FORM)**. APPLIANCE REPAIR SOLUTIONS, LLC, (U.S. CLS. 100, 101 AND 102). SN 77-574,412. PUB. 11-11-2008. FILED 9-19-2008.
- 3,567,731. **PETFRIENDLYTRAVEL.COM (BLOCK FORM)**. PET FRIENDLY TRAVEL, LLC, (U.S. CLS. 100, 101 AND 102). SN 78-413,440. PUB. 11-11-2008. FILED 5-5-2004.
- 3,567,738. **WINE CHATEAU (BLOCK FORM)**. ABROL, INC., (U.S. CLS. 100, 101 AND 102). SN 78-568,152. PUB. 12-5-2006. FILED 2-15-2005.
- 3,567,745 (*See Class 9 for this trademark*).
- 3,567,752 (*See Class 16 for this trademark*).
- 3,567,773. **C-ING (BLOCK FORM)**. FUEST, LUDGER, MULTIPLE CLASS, (INT. CLS. 35, 38, 41 AND 42), (U.S. CLS. 100, 101, 102, 104 AND 107). SN 78-889,173. PUB. 11-11-2008. FILED 5-22-2006.
- 3,567,782. **SITOA (BLOCK FORM)**. SITOA CORPORATION, (U.S. CLS. 100, 101 AND 102). SN 78-952,770. PUB. 11-11-2008. FILED 8-15-2006.
- 3,567,814 (*See Class 1 for this trademark*).
- 3,567,824. **MORE LX FINANCES & LIFE AND DESIGN**. MORELX GMBH, MULTIPLE CLASS, (INT. CLS. 35, 36, 38, 39, 41, 43 AND 45), (U.S. CLS. 100, 101, 102, 104, 105 AND 107). SN 79-037,104. PUB. 11-11-2008. FILED 1-18-2007.
- 3,567,829 (*See Class 9 for this trademark*).
- 3,567,833 (*See Class 16 for this trademark*).
- 3,567,835 (*See Class 17 for this trademark*).
- 3,567,840. **RANDY RUN (STYLIZED)**. RANDYRUN GMBH, MULTIPLE CLASS, (INT. CLS. 35 AND 41), (U.S. CLS. 100, 101, 102 AND 107). SN 79-041,144. PUB. 11-11-2008. FILED 7-16-2007.
- 3,567,841. **NO WORK. JUST FUN. WITH RANDY RUN (STYLIZED)**. RANDYRUN GMBH, MULTIPLE CLASS, (INT. CLS. 35 AND 41), (U.S. CLS. 100, 101, 102 AND 107). SN 79-041,145. PUB. 11-11-2008. FILED 7-16-2007.
- 3,567,844. **ALLIANZ REAL ESTATE (BLOCK FORM)**. ALLIANZ SE, MULTIPLE CLASS, (INT. CLS. 35 AND 36), (U.S. CLS. 100, 101 AND 102). SN 79-041,610. PUB. 11-11-2008. FILED 6-8-2007.
- 3,567,848 (*See Class 9 for this trademark*).
- 3,567,863 (*See Class 4 for this trademark*).
- 3,567,864 (*See Class 4 for this trademark*).
- 3,567,870 (*See Class 9 for this trademark*).
- 3,567,887 (*See Class 12 for this trademark*).
- 3,567,909. **SPOTBUY (BLOCK FORM)**. SIEMENS AKTIENGESELLSCHAFT, (U.S. CLS. 100, 101 AND 102). SN 79-049,681. PUB. 11-11-2008. FILED 1-14-2008.
- 3,567,915 (*See Class 17 for this trademark*).
- 3,567,916 (*See Class 9 for this trademark*).
- 3,567,924. **MADE IN RESPECT (BLOCK FORM)**. MADE IN RESPECT, MULTIPLE CLASS, (INT. CLS. 35, 42 AND 45), (U.S. CLS. 100, 101 AND 102). SN 79-050,321. PUB. 11-11-2008. FILED 10-17-2007.
- 3,567,930. **AFEC PUMPS (BLOCK FORM)**. AFEC PUMPS EUROPE B.V., (U.S. CLS. 100, 101 AND 102). SN 79-050,862. PUB. 11-11-2008. FILED 1-4-2008.
- 3,567,933 (*See Class 1 for this trademark*).
- 3,567,934 (*See Class 1 for this trademark*).
- 3,567,935 (*See Class 1 for this trademark*).
- 3,567,936 (*See Class 1 for this trademark*).
- 3,567,941 (*See Class 9 for this trademark*).
- 3,567,950. **ENERGY POTENTIAL AND DESIGN**. ENERGY POTENTIAL AB.; ORG NR. 556614-9000, MULTIPLE CLASS, (INT. CLS. 35, 36 AND 42), (U.S. CLS. 100, 101 AND 102). SN 79-052,839. PUB. 11-11-2008. FILED 3-19-2008.
- 3,567,953 (*See Class 14 for this trademark*).
- 3,567,955. **COST HOUSE (BLOCK FORM)**. COST HOUSE SAS, (U.S. CLS. 100, 101 AND 102). SN 79-053,183. PUB. 11-11-2008. FILED 4-14-2008.
- 3,567,980. **SAMSKIP (BLOCK FORM)**. SAMSKIP HF., MULTIPLE CLASS, (INT. CLS. 35, 36 AND 39), (U.S. CLS. 100, 101, 102 AND 105). SN 79-056,149. PUB. 11-11-2008. FILED 3-14-2008.
-
- CLASS 36—INSURANCE AND FINANCIAL**
- 3,566,252. **BANKATLANTIC**. BANKATLANTIC BANCORP, INC., (U.S. CLS. 100, 101 AND 102). SN 75-618,643. PUB. 11-11-2008. FILED 1-7-1999.
- 3,566,253. **BANK ATLANTIC AND DESIGN**. BANKATLANTIC BANCORP, INC., (U.S. CLS. 100, 101 AND 102). SN 75-618,644. PUB. 11-11-2008. FILED 1-7-1999.
- 3,566,261. **NGEN**. NGEN MANAGEMENT, L.L.C., (U.S. CLS. 100, 101 AND 102). SN 76-502,085. PUB. 11-11-2008. FILED 3-21-2003.
- 3,566,313. **JASPER FUND (STYLIZED)**. JASPER FUNDS, LLC, (U.S. CLS. 100, 101 AND 102). SN 76-686,895. PUB. 11-11-2008. FILED 2-13-2008.
- 3,566,316. **AUTOMOTIVE REPLACEMENT COVERAGE - ARC (BLOCK FORM)**. TRI-ARC FINANCIAL SERVICES, INC., (U.S. CLS. 100, 101 AND 102). SN 76-687,405. PUB. 11-11-2008. FILED 3-6-2008.
- 3,566,324. **SELECTMYSAPCE AND DESIGN**. SELECT MY SPACE, (U.S. CLS. 100, 101 AND 102). SN 76-688,244. PUB. 11-11-2008. FILED 3-31-2008.
- 3,566,348. **WIN FINANCIAL AND DESIGN**. WIN FINANCIAL CORP., (U.S. CLS. 100, 101 AND 102). SN 76-690,403. PUB. 11-11-2008. FILED 6-9-2008.
- 3,566,355. **BLUE WATER INVESTMENT MODEL (BLOCK FORM)**. MCKELVEY FINANCIAL, (U.S. CLS. 100, 101 AND 102). SN 76-690,719. PUB. 11-11-2008. FILED 6-20-2008.
- 3,566,372 (*See Class 35 for this trademark*).
- 3,566,391. **M AMERICAN MOMENTUM BANK AND DESIGN**. AMERICAN MOMENTUM BANK, (U.S. CLS. 100, 101 AND 102). SN 77-062,006. PUB. 11-11-2008. FILED 12-12-2006.
- 3,566,392. **M AMERICAN MOMENTUM BANK AND DESIGN**. AMERICAN MOMENTUM BANK, (U.S. CLS. 100, 101 AND 102). SN 77-062,012. PUB. 11-11-2008. FILED 12-12-2006.
- 3,566,413. **SAFECO OPTIMUM PACKAGE (BLOCK FORM)**. SAFECO CORPORATION, (U.S. CLS. 100, 101 AND 102). SN 77-094,157. PUB. 11-11-2008. FILED 1-30-2007.
- 3,566,431 (*See Class 6 for this trademark*).
- 3,566,432 (*See Class 6 for this trademark*).
- 3,566,449 (*See Class 35 for this trademark*).
- 3,566,468 (*See Class 35 for this trademark*).
- 3,566,495. **DSD HOMES (BLOCK FORM)**. DSD HOMES, INC., MULTIPLE CLASS, (INT. CLS. 36 AND 37), (U.S. CLS. 100, 101, 102, 103 AND 106). SN 77-221,353. PUB. 11-11-2008. FILED 7-3-2007.
- 3,566,496. **DSD (STYLIZED)**. DSD HOMES, INC., MULTIPLE CLASS, (INT. CLS. 36 AND 37), (U.S. CLS. 100, 101, 102, 103 AND 106). SN 77-221,371. PUB. 11-11-2008. FILED 7-3-2007.
- 3,566,526. **CLIMATE LEADERS AND DESIGN**. CLIMATE LEADERS FUND MANAGEMENT LTD., (U.S. CLS. 100, 101 AND 102). SN 77-261,353. PUB. 11-11-2008. FILED 8-22-2007.

- 3,566,561. **WHOLESALE MAILING LISTS (BLOCK FORM)**. WHOLESALE MAILING LISTS, INC., MULTIPLE CLASS, (INT. CLS. 36 AND 40), (U.S. CLS. 100, 101, 102, 103 AND 106). SN 77-295,141. PUB. 11-11-2008. FILED 10-3-2007.
- 3,566,603. **WHOLESALE LISTS (BLOCK FORM)**. WHOLESALE MAILING LISTS, INC., MULTIPLE CLASS, (INT. CLS. 36 AND 40), (U.S. CLS. 100, 101, 102, 103 AND 106). SN 77-325,306. PUB. 11-11-2008. FILED 11-8-2007.
- 3,566,609. **MNL TEN (BLOCK FORM)**. MIDLAND NATIONAL LIFE INSURANCE COMPANY, (U.S. CLS. 100, 101 AND 102). SN 77-326,253. PUB. 11-11-2008. FILED 11-9-2007.
- 3,566,633 (*See Class 35 for this trademark*).
- 3,566,647. **SENIORS FOR SENIORS (BLOCK FORM)**. NORTH SHORE ANIMAL LEAGUE AMERICA, INC., MULTIPLE CLASS, (INT. CLS. 36 AND 45), (U.S. CLS. 100, 101 AND 102). SN 77-339,974. PUB. 11-11-2008. FILED 11-29-2007.
- 3,566,664. **AUDAX MEZZANINE AND DESIGN**. 101 HUNTINGTON HOLDINGS, LLC, (U.S. CLS. 100, 101 AND 102). SN 77-345,908. PUB. 11-11-2008. FILED 12-6-2007.
- 3,566,667 (*See Class 35 for this trademark*).
- 3,566,702. **COOPER DESIGN SPACE CREATIVE THINKING CREATIVE SPACE CREATIVE RESOURCES (BLOCK FORM)**. BIG MUNGA DEVELOPMENT, LLC, (U.S. CLS. 100, 101 AND 102). SN 77-354,202. PUB. 11-11-2008. FILED 12-17-2007.
- 3,566,717. **MONA LISA SUITE HOTEL (BLOCK FORM)**. MONA LISA DEVELOPMENT, LLC, MULTIPLE CLASS, (INT. CLS. 36 AND 43), (U.S. CLS. 100, 101 AND 102). SN 77-358,930. PUB. 11-11-2008. FILED 12-23-2007.
- 3,566,720. **WE BELIEVE IN PEOPLE, NOT JUST SCORES! (BLOCK FORM)**. COMPUCREDIT INTELLECTUAL PROPERTY HOLDINGS CORP. II, (U.S. CLS. 100, 101 AND 102). SN 77-359,694. PUB. 11-11-2008. FILED 12-26-2007.
- 3,566,724. **MISCELLANEOUS DESIGN**. OHIO MUTUAL INSURANCE COMPANY, (U.S. CLS. 100, 101 AND 102). SN 77-360,999. PUB. 11-11-2008. FILED 12-28-2007.
- 3,566,729. **FIRETIP (BLOCK FORM)**. FARR FINANCIAL INC., (U.S. CLS. 100, 101 AND 102). SN 77-362,569. PUB. 11-11-2008. FILED 1-2-2008.
- 3,566,748 (*See Class 35 for this trademark*).
- 3,566,770 (*See Class 35 for this trademark*).
- 3,566,792 (*See Class 35 for this trademark*).
- 3,566,794 (*See Class 35 for this trademark*).
- 3,566,796 (*See Class 35 for this trademark*).
- 3,566,800. **U.S. FLEET UNIVERSAL FLEET FUEL MANAGEMENT AND DESIGN**. WOODFIN HEATING, INC., DBA US FLEET UNIVERSAL, (U.S. CLS. 100, 101 AND 102). SN 77-407,211. PUB. 11-11-2008. FILED 2-27-2008.
- 3,566,801. **U.S. FLEET WATCHCARD FLEET FUEL MANAGEMENT AND DESIGN**. WOODFIN HEATING, INC., DBA US FLEET UNIVERSAL, (U.S. CLS. 100, 101 AND 102). SN 77-407,255. PUB. 11-11-2008. FILED 2-27-2008.
- 3,566,831. **MISCELLANEOUS DESIGN**. MERRILL LYNCH BANK & TRUST CO., FSB, DBA FIRST REPUBLIC BANK, (U.S. CLS. 100, 101 AND 102). SN 77-428,759. PUB. 11-11-2008. FILED 3-21-2008.
- 3,566,841. **THE LOAN MACHINE (BLOCK FORM)**. TITLE LOAN COMPANY, (U.S. CLS. 100, 101 AND 102). SN 77-436,112. PUB. 11-11-2008. FILED 3-31-2008.
- 3,566,844. **FIDELITY PREFERRED SERVICES (BLOCK FORM)**. FMR LLC, (U.S. CLS. 100, 101 AND 102). SN 77-437,493. PUB. 11-11-2008. FILED 4-2-2008.
- 3,566,867. **BEARDS BECAUSE (BLOCK FORM)**. SCOTT DOERR, (U.S. CLS. 100, 101 AND 102). SN 77-447,370. PUB. 11-11-2008. FILED 4-14-2008.
- 3,566,896. **MCLEAN INSURANCE AGENCY INC. AND DESIGN**. MCLEAN INSURANCE AGENCY, INC., (U.S. CLS. 100, 101 AND 102). SN 77-459,727. PUB. 11-11-2008. FILED 4-28-2008.
- 3,566,897. **MCLEAN INSURANCE AND DESIGN**. MCLEAN INSURANCE AGENCY, INC., (U.S. CLS. 100, 101 AND 102). SN 77-459,759. PUB. 11-11-2008. FILED 4-28-2008.
- 3,566,944 (*See Class 29 for this trademark*).
- 3,566,963. **YOUNG MASTERS AND DESIGN**. TSS PHOTOGRAPHY, INC, MULTIPLE CLASS, (INT. CLS. 36 AND 40), (U.S. CLS. 100, 101, 102, 103 AND 106). SN 77-481,565. PUB. 11-11-2008. FILED 5-22-2008.
- 3,566,981. **AGENT 360 AND DESIGN**. BLONDELL, HARRY W, AND MUNSON, ROBERT B, AND NACE, MICHAEL S, MULTIPLE CLASS, (INT. CLS. 36 AND 38), (U.S. CLS. 100, 101, 102 AND 104). SN 77-483,946. PUB. 11-11-2008. FILED 5-27-2008.
- 3,567,034. **QUEEN'S HARBOUR YACHT AND COUNTRY CLUB AND DESIGN**. QUEEN'S HARBOUR YACHT & COUNTRY CLUB OWNERS ASSOCIATION, INC., (U.S. CLS. 100, 101 AND 102). SN 77-490,480. PUB. 11-11-2008. FILED 6-4-2008.
- 3,567,037. **REALTYNA (BLOCK FORM)**. ATTAR, ALI MOVAHEDIAN, (U.S. CLS. 100, 101 AND 102). SN 77-490,559. PUB. 11-11-2008. FILED 6-4-2008.
- 3,567,054. **MISCELLANEOUS DESIGN**. RED DEVELOPMENT, LLC, (U.S. CLS. 100, 101 AND 102). SN 77-491,998. PUB. 11-11-2008. FILED 6-5-2008.
- 3,567,060. **HYPERLINK INSURANCE SOLUTIONS (BLOCK FORM)**. HYPERLINK INSURANCE SOLUTIONS, (U.S. CLS. 100, 101 AND 102). SN 77-492,737. PUB. 11-11-2008. FILED 6-6-2008.
- 3,567,070. **PRINSOURCE AND DESIGN**. PRINSOURCE CAPITAL COMPANIES, LLC, DBA PRINSOURCE, (U.S. CLS. 100, 101 AND 102). SN 77-493,191. PUB. 11-11-2008. FILED 6-6-2008.
- 3,567,080. **CHAMPION REAL ESTATE COMPANY (BLOCK FORM)**. CHAMPION REALTY, LTD., MULTIPLE CLASS, (INT. CLS. 36 AND 37), (U.S. CLS. 100, 101, 102, 103 AND 106). SN 77-494,248. PUB. 11-11-2008. FILED 6-9-2008.
- 3,567,086. **ENDURE ENERGY (BLOCK FORM)**. ENDURE ENERGY, L.L.C., (U.S. CLS. 100, 101 AND 102). SN 77-494,450. PUB. 11-11-2008. FILED 6-9-2008.
- 3,567,091. **DEFENSEINSURE (BLOCK FORM)**. LOCKTON RISK SERVICES, INC., (U.S. CLS. 100, 101 AND 102). SN 77-494,669. PUB. 11-11-2008. FILED 6-9-2008.
- 3,567,092. **C CHAMPION REAL ESTATE COMPANY DEFINING THE ART OF REAL ESTATE AND DESIGN**. CHAMPION REALTY, LTD., MULTIPLE CLASS, (INT. CLS. 36 AND 37), (U.S. CLS. 100, 101, 102, 103 AND 106). SN 77-494,741. PUB. 11-11-2008. FILED 6-9-2008.
- 3,567,094. **THE JEWELERS BOARD OF TRADE (BLOCK FORM)**. THE JEWELERS BOARD OF TRADE, (U.S. CLS. 100, 101 AND 102). SN 77-494,857. PUB. 11-11-2008. FILED 6-10-2008.
- 3,567,098. **REAL ESTATE 997 AND DESIGN**. REAL ESTATE 997 INC., (U.S. CLS. 100, 101 AND 102). SN 77-495,001. PUB. 11-11-2008. FILED 6-10-2008.
- 3,567,103. **REALPRICE (BLOCK FORM)**. REALPRICE, INCORPORATED, (U.S. CLS. 100, 101 AND 102). SN 77-495,380. PUB. 11-11-2008. FILED 6-10-2008.
- 3,567,106. **WHERE SMART SOLUTIONS LIVE (BLOCK FORM)**. PARDEE HOMES, MULTIPLE CLASS, (INT. CLS. 36 AND 37), (U.S. CLS. 100, 101, 102, 103 AND 106). SN 77-496,102. PUB. 11-11-2008. FILED 6-11-2008.
- 3,567,121 (*See Class 35 for this trademark*).
- 3,567,143 (*See Class 35 for this trademark*).
- 3,567,181. **YOUR ADDRESS FOR REAL ESTATE (BLOCK FORM)**. ONE PROPERTY PLACE CORPORATION, (U.S. CLS. 100, 101 AND 102). SN 77-499,411. PUB. 11-11-2008. FILED 6-16-2008.
- 3,567,195. **ULTRAMAX GOLD (BLOCK FORM)**. THE GUARDIAN LIFE INSURANCE COMPANY OF AMERICA, (U.S. CLS. 100, 101 AND 102). SN 77-499,632. PUB. 11-11-2008. FILED 6-16-2008.
- 3,567,210. **STARJAM (BLOCK FORM)**. THE STARJAM CHARITABLE TRUST, MULTIPLE CLASS, (INT. CLS. 36 AND 41), (U.S. CLS. 100, 101, 102 AND 107). SN 77-499,869. PUB. 11-11-2008. FILED 6-16-2008.
- 3,567,220. **STARJAM AND DESIGN**. THE STARJAM CHARITABLE TRUST, MULTIPLE CLASS, (INT. CLS. 36 AND 41), (U.S. CLS. 100, 101, 102 AND 107). SN 77-499,997. PUB. 11-11-2008. FILED 6-16-2008.
- 3,567,245. **CHAMPION MARKETING GROUP, LLC (BLOCK FORM)**. CHAMPION MARKETING GROUP, LLC, (U.S. CLS. 100, 101 AND 102). SN 77-500,524. PUB. 11-11-2008. FILED 6-17-2008.
- 3,567,250. **SEED AND LIGHT INTERNATIONAL (BLOCK FORM)**. SEED AND LIGHT INTERNATIONAL, (U.S.

- CLS. 100, 101 AND 102). SN 77-500,666. PUB. 11-11-2008. FILED 6-17-2008.
- 3,567,275. **ONE MISSION. ONE FUTURE. TOGETHER. (BLOCK FORM)**. PUBLISHING HOUSE OF THE EVANGELICAL LUTHERAN CHURCH IN AMERICA, (U.S. CLS. 100, 101 AND 102). SN 77-500,942. PUB. 11-11-2008. FILED 6-17-2008.
- 3,567,309. **VISIONSPRING (BLOCK FORM)**. VISIONSPRING, INC., (U.S. CLS. 100, 101 AND 102). SN 77-501,458. PUB. 11-11-2008. FILED 6-18-2008.
- 3,567,314. **GLOBEMED (BLOCK FORM)**. GLOBEMED, MULTIPLE CLASS, (INT. CLS. 36 AND 41), (U.S. CLS. 100, 101, 102 AND 107). SN 77-501,486. PUB. 11-11-2008. FILED 6-18-2008.
- 3,567,317. **MISCELLANEOUS DESIGN**. GLOBEMED, MULTIPLE CLASS, (INT. CLS. 36 AND 41), (U.S. CLS. 100, 101, 102 AND 107). SN 77-501,496. PUB. 11-11-2008. FILED 6-18-2008.
- 3,567,318. **MBI (BLOCK FORM)**. KING LOMBARDI ACQUISITIONS, INC., (U.S. CLS. 100, 101 AND 102). SN 77-501,533. PUB. 11-11-2008. FILED 6-18-2008.
- 3,567,385. **VISIONSPRING AND DESIGN**. VISIONSPRING, INC., (U.S. CLS. 100, 101 AND 102). SN 77-502,611. PUB. 11-11-2008. FILED 6-19-2008.
- 3,567,401. **SPARE SOME FOR AUTISM AND DESIGN**. SPARE SOME FOR AUTISM, INC., (U.S. CLS. 100, 101 AND 102). SN 77-502,843. PUB. 11-11-2008. FILED 6-19-2008.
- 3,567,439. **MYRETIREMENTPRO.COM (BLOCK FORM)**. VALLEY NATIONAL GROUP, (U.S. CLS. 100, 101 AND 102). SN 77-503,485. PUB. 11-11-2008. FILED 6-19-2008.
- 3,567,443. **HUMAN FINANCIAL AND DESIGN**. HUMAN FINANCIAL, LLC, DBA HUMAN FINANCIAL, (U.S. CLS. 100, 101 AND 102). SN 77-503,529. PUB. 11-11-2008. FILED 6-19-2008.
- 3,567,447. **MISCELLANEOUS DESIGN**. TORA HOLDINGS LIMITED, (U.S. CLS. 100, 101 AND 102). SN 77-503,643. PUB. 11-11-2008. FILED 6-19-2008.
- 3,567,459. **STRATEGIC SNAPSHOT (BLOCK FORM)**. STRATEGIC PLANNERS GROUP, LLC, (U.S. CLS. 100, 101 AND 102). SN 77-503,870. PUB. 11-11-2008. FILED 6-20-2008.
- 3,567,479. **STRATEGIC DISCOVERY (BLOCK FORM)**. STRATEGIC PLANNERS GROUP, LLC, (U.S. CLS. 100, 101 AND 102). SN 77-504,449. PUB. 11-11-2008. FILED 6-20-2008.
- 3,567,513. **LIBERTY BAY CREDIT UNION (BLOCK FORM)**. LIBERTY BAY CREDIT UNION, (U.S. CLS. 100, 101 AND 102). SN 77-505,201. PUB. 11-11-2008. FILED 6-23-2008.
- 3,567,541. **CREATIVE STRATEGIES-GROUNDED WISDOM (BLOCK FORM)**. YESKE BUIE INC., (U.S. CLS. 100, 101 AND 102). SN 77-505,690. PUB. 11-11-2008. FILED 6-23-2008.
- 3,567,547. **MISCELLANEOUS DESIGN**. CANYON CAPITAL ADVISORS LLC, (U.S. CLS. 100, 101 AND 102). SN 77-505,798. PUB. 11-11-2008. FILED 6-23-2008.
- 3,567,573. **CHECK360 (BLOCK FORM)**. NETDEPOSIT, INC., (U.S. CLS. 100, 101 AND 102). SN 77-506,548. PUB. 11-11-2008. FILED 6-24-2008.
- 3,567,581. **MOVE IT (BLOCK FORM)**. TARGET DATA LLC, (U.S. CLS. 100, 101 AND 102). SN 77-506,736. PUB. 11-11-2008. FILED 6-24-2008.
- 3,567,592. **REALTYTMS (BLOCK FORM)**. REALTYTMS, INC, (U.S. CLS. 100, 101 AND 102). SN 77-506,865. PUB. 11-11-2008. FILED 6-24-2008.
- 3,567,593. **REALTYTMS AND DESIGN**. REALTYTMS, INC, (U.S. CLS. 100, 101 AND 102). SN 77-506,881. PUB. 11-11-2008. FILED 6-24-2008.
- 3,567,632. **TRIANGLES OF TRUTH (BLOCK FORM)**. KAY, SHARONA, (U.S. CLS. 100, 101 AND 102). SN 77-510,723. PUB. 11-11-2008. FILED 6-29-2008.
- 3,567,636. **TORA (BLOCK FORM)**. TORA HOLDINGS LIMITED, (U.S. CLS. 100, 101 AND 102). SN 77-511,260. PUB. 11-11-2008. FILED 6-30-2008.
- 3,567,649. **MISCELLANEOUS DESIGN**. SHIFF FAMILY, LLC, MULTIPLE CLASS, (INT. CLS. 36 AND 37), (U.S. CLS. 100, 101, 102, 103 AND 106). SN 77-515,338. PUB. 11-11-2008. FILED 7-6-2008.
- 3,567,669. **EQUITY PARTNERS FOR COMPANIES PRIMED TO BECOME PUBLIC (BLOCK FORM)**. KEATING INVESTMENTS, LLC, (U.S. CLS. 100, 101 AND 102). SN 77-520,588. PUB. 11-11-2008. FILED 7-11-2008.
- 3,567,676. **BITUMINOUS AND DESIGN**. OLD REPUBLIC INTERNATIONAL CORPORATION, (U.S. CLS. 100, 101 AND 102). SN 77-523,842. PUB. 11-11-2008. FILED 7-16-2008.
- 3,567,677. **MISCELLANEOUS DESIGN**. OLD REPUBLIC INTERNATIONAL CORPORATION, (U.S. CLS. 100, 101 AND 102). SN 77-523,892. PUB. 11-11-2008. FILED 7-16-2008.
- 3,567,696. **MISCELLANEOUS DESIGN**. WACHOVIA CORPORATION, (U.S. CLS. 100, 101 AND 102). SN 77-533,887. PUB. 11-11-2008. FILED 7-29-2008.
- 3,567,708. **EBIDS (BLOCK FORM)**. NATIONAL AUTOMATED CLEARING HOUSE ASSOCIATION, (U.S. CLS. 100, 101 AND 102). SN 77-539,682. PUB. 11-11-2008. FILED 8-5-2008.
- 3,567,739. **GC GRAMERCY CAPITAL MANAGEMENT CORP. (STYLIZED)**. GRAMERCY CAPITAL MANAGEMENT CORPORATION, (U.S. CLS. 100, 101 AND 102). SN 78-573,951. PUB. 11-11-2008. FILED 2-24-2005.
- 3,567,757. **AMTRUST MORTGAGE CORPORATION (BLOCK FORM)**. AMTRUST BANK, (U.S. CLS. 100, 101 AND 102). SN 78-774,778. PUB. 11-11-2008. FILED 12-16-2005.
- 3,567,758. **EQUITY IN MOTION (BLOCK FORM)**. MARROQUIN, MICHAEL, ANTHONY, (U.S. CLS. 100, 101 AND 102). SN 78-777,523. PUB. 11-11-2008. FILED 12-20-2005.
- 3,567,768. **BETTER THAN A BANK (BLOCK FORM)**. ABNB FEDERAL CREDIT UNION, (U.S. CLS. 100, 101 AND 102). SN 78-866,760. PUB. 11-11-2008. FILED 4-21-2006.
- 3,567,794. **AIMBRIDGE CONNECT (BLOCK FORM)**. THE AIMBRIDGE GROUP, MULTIPLE CLASS, (INT. CLS. 36 AND 42), (U.S. CLS. 100, 101 AND 102). SN 78-976,095. PUB. 8-15-2006. FILED 6-7-2004.
- 3,567,799. **AMLIN (BLOCK FORM)**. AMLIN PLC, (U.S. CLS. 100, 101 AND 102). SN 79-011,475. PUB. 11-11-2008. FILED 4-25-2005.
- 3,567,824 (*See Class 35 for this trademark*).
- 3,567,836. **ARKOS CAPITAL (BLOCK FORM)**. ARKOS CAPITAL S.A., (U.S. CLS. 100, 101 AND 102). SN 79-040,088. PUB. 11-11-2008. FILED 6-18-2007.
- 3,567,844 (*See Class 35 for this trademark*).
- 3,567,887 (*See Class 12 for this trademark*).
- 3,567,908. **MISCELLANEOUS DESIGN**. ACM ADVANCED CURRENCY MARKETS SA, (U.S. CLS. 100, 101 AND 102). SN 79-049,655. PUB. 11-11-2008. FILED 1-8-2008.
- 3,567,932 (*See Class 12 for this trademark*).
- 3,567,933 (*See Class 1 for this trademark*).
- 3,567,934 (*See Class 1 for this trademark*).
- 3,567,935 (*See Class 1 for this trademark*).
- 3,567,936 (*See Class 1 for this trademark*).
- 3,567,950 (*See Class 35 for this trademark*).
- 3,567,980 (*See Class 35 for this trademark*).

CLASS 37—CONSTRUCTION AND REPAIR

- 3,566,264 (*See Class 9 for this trademark*).
- 3,566,299. **SOLARPLUS (BLOCK FORM)**. LENNAR PACIFIC PROPERTIES MANAGEMENT, INC., (U.S. CLS. 100, 103 AND 106). SN 76-684,508. PUB. 11-11-2008. FILED 11-30-2007.
- 3,566,300. **LENNAR SOLAR PLUS AND DESIGN**. LENNAR PACIFIC PROPERTIES MANAGEMENT, INC., (U.S. CLS. 100, 103 AND 106). SN 76-684,509. PUB. 11-11-2008. FILED 11-30-2007.
- 3,566,305. **SCHIAVONE (BLOCK FORM)**. SCHIAVONE CONSTRUCTION CO., (U.S. CLS. 100, 103 AND 106). SN 76-685,367. PUB. 11-11-2008. FILED 12-28-2007.
- 3,566,352. **MOBILE DENTURE LAB 245-7986 24 HR. REPAIR SERVICE WE DELIVER SMILES AND DESIGN**. SHABAZZ, ABDUL HAKIM R., (U.S. CLS. 100, 103 AND 106). SN 76-690,679. PUB. 11-11-2008. FILED 6-19-2008.
- 3,566,361. **INOVATEUS AND DESIGN**. INOVATEUS DEVELOPMENT, LLC, (U.S. CLS. 100, 103 AND 106). SN 76-690,958. PUB. 11-11-2008. FILED 6-30-2008.
- 3,566,362 (*See Class 35 for this trademark*).
- 3,566,371 (*See Class 9 for this trademark*).
- 3,566,378. **A+ DIAGNOSIS AND DESIGN**. MENDEZ, CHRISTOPHER, (U.S. CLS. 100, 103 AND 106). SN 77-028,438. PUB. 11-11-2008. FILED 10-24-2006.

- 3,566,396 (*See Class 9 for this trademark.*)
 3,566,400 (*See Class 7 for this trademark.*)
 3,566,433 (*See Class 35 for this trademark.*)
 3,566,435 (*See Class 7 for this trademark.*)
 3,566,437. **MFR MOBILE FORCE REFUELING AND DESIGN.** DAVIS, BRAD, (U.S. CLS. 100, 103 AND 106). SN 77-137,766. PUB. 9-25-2007. FILED 3-22-2007.
 3,566,443. **GUARANTEED TRANSMISSION SERVICE (BLOCK FORM).** JOHNSON TRANSMISSION, INC., DBA GUARANTEED TRANSMISSION SERVICES, (U.S. CLS. 100, 103 AND 106). SN 77-142,839. PUB. 11-11-2008. FILED 3-28-2007.
 3,566,453. **BRINGING WIND ENERGY HOME (BLOCK FORM).** WIND CAPITAL GROUP, LLC, (U.S. CLS. 100, 103 AND 106). SN 77-158,935. PUB. 11-11-2008. FILED 4-17-2007.
 3,566,495 (*See Class 36 for this trademark.*)
 3,566,496 (*See Class 36 for this trademark.*)
 3,566,515. **FEDERAL ASSIST AND DESIGN.** BRICKELL FINANCIAL SERVICES MOTOR CLUB, INC., (U.S. CLS. 100, 103 AND 106). SN 77-242,275. PUB. 11-11-2008. FILED 7-30-2007.
 3,566,534. **HORTAU AND DESIGN.** HORTAU INC., MULTIPLE CLASS, (INT. CLS. 37 AND 42), (U.S. CLS. 100, 101, 103 AND 106). SN 77-266,180. PUB. 11-11-2008. FILED 8-28-2007.
 3,566,569 (*See Class 7 for this trademark.*)
 3,566,670 (*See Class 17 for this trademark.*)
 3,566,715 (*See Class 35 for this trademark.*)
 3,566,716. **ELECTRIC DOCTOR AND DESIGN.** LANUM ELECTRIC LLC, DBA RUSSELL ELECTRIC, (U.S. CLS. 100, 103 AND 106). SN 77-358,723. PUB. 11-11-2008. FILED 12-21-2007.
 3,566,820. **RIDGECAPITALLLC AND DESIGN.** RIDGE CAPITAL, LLC, (U.S. CLS. 100, 103 AND 106). SN 77-421,276. PUB. 11-11-2008. FILED 3-13-2008.
 3,566,825. **R SCAFFOLDING RENTAL (STYLIZED).** SCAFFOLDING RENTAL & ERECTION SERVICES, LLC, (U.S. CLS. 100, 103 AND 106). SN 77-423,736. PUB. 11-11-2008. FILED 3-17-2008.
 3,566,837. **SMALL CELLARS AND DESIGN.** M. BRANDON SMITH, (U.S. CLS. 100, 103 AND 106). SN 77-431,512. PUB. 11-11-2008. FILED 3-26-2008.
 3,566,846. **BRICKMASTER (BLOCK FORM).** NEW ENGLAND BRICKMASTER WINDOWS & EXTERIORS, INC., (U.S. CLS. 100, 103 AND 106). SN 77-439,547. PUB. 11-11-2008. FILED 4-3-2008.
 3,566,873 (*See Class 35 for this trademark.*)
 3,566,874 (*See Class 35 for this trademark.*)
 3,566,919. **MISCELLANEOUS DESIGN.** INLAND COASTAL CONSTRUCTION LLC, (U.S. CLS. 100, 103 AND 106). SN 77-469,158. PUB. 11-11-2008. FILED 5-8-2008.
 3,566,982. **BUILD PLUS (STYLIZED).** ENCORE CONSTRUCTION CO., INC., (U.S. CLS. 100, 103 AND 106). SN 77-484,052. PUB. 11-11-2008. FILED 5-27-2008.
 3,567,038. **MICROMEDICS AND DESIGN.** MICROMEDICS, INC., (U.S. CLS. 100, 103 AND 106). SN 77-490,637. PUB. 11-11-2008. FILED 6-4-2008.
 3,567,042. **KEEP OUT OF THE RAIN CALL DAVE DESCHAIINE (BLOCK FORM).** DESCHAIINE, DAVID J., (U.S. CLS. 100, 103 AND 106). SN 77-490,879. PUB. 11-11-2008. FILED 6-4-2008.
 3,567,051. **DESIGNED AND BUILT FOR A LIFETIME OF LIVING (BLOCK FORM).** SUNCATCHER COMMUNITIES, LLC, (U.S. CLS. 100, 103 AND 106). SN 77-491,832. PUB. 11-11-2008. FILED 6-5-2008.
 3,567,071. **DANIEL'S AND DESIGN.** DANROY CORP., DBA DANIELS RESTORATION, (U.S. CLS. 100, 103 AND 106). SN 77-493,209. PUB. 11-11-2008. FILED 6-6-2008.
 3,567,080 (*See Class 36 for this trademark.*)
 3,567,092 (*See Class 36 for this trademark.*)
 3,567,106 (*See Class 36 for this trademark.*)
 3,567,115. **TECHEXPERT EXPRESS (BLOCK FORM).** TECHEXPERT EXPRESS, INCORPORATED, (U.S. CLS. 100, 103 AND 106). SN 77-496,513. PUB. 11-11-2008. FILED 6-11-2008.
 3,567,126. **MISCELLANEOUS DESIGN.** CUSTOM COOLING & REFRIGERATION, INC., (U.S. CLS. 100, 103 AND 106). SN 77-496,719. PUB. 11-11-2008. FILED 6-11-2008.
 3,567,143 (*See Class 35 for this trademark.*)
 3,567,144 (*See Class 6 for this trademark.*)
 3,567,162. **U ASSIST BUILDERS AND DESIGN.** U ASSIST BUILDERS, (U.S. CLS. 100, 103 AND 106). SN 77-498,243. PUB. 11-11-2008. FILED 6-13-2008.
 3,567,171. **THREE RUNS PLANTATION (STYLIZED).** TR SALES PLANTATION, LLC, DBA THREE RUNS PLANTATION, (U.S. CLS. 100, 103 AND 106). SN 77-498,584. PUB. 11-11-2008. FILED 6-13-2008.
 3,567,186 (*See Class 16 for this trademark.*)
 3,567,190 (*See Class 19 for this trademark.*)
 3,567,212. **BUILDING FOR THE WAY PEOPLE REALLY LIVE (BLOCK FORM).** CLASSIC URBAN HOMES STANFORD LP, (U.S. CLS. 100, 103 AND 106). SN 77-499,902. PUB. 11-11-2008. FILED 6-16-2008.
 3,567,229. **OUTSMART HUNGRY DEER. (BLOCK FORM).** NATURE TECHNOLOGIES, (U.S. CLS. 100, 103 AND 106). SN 77-500,286. PUB. 11-11-2008. FILED 6-16-2008.
 3,567,237. **F AND DESIGN.** FANUKA INC., (U.S. CLS. 100, 103 AND 106). SN 77-500,421. PUB. 11-11-2008. FILED 6-17-2008.
 3,567,238. **YOUR HOME IS YOUR CASTLE - SO WHY NOT TREAT IT LIKE ONE? (BLOCK FORM).** FANUKA INC., (U.S. CLS. 100, 103 AND 106). SN 77-500,426. PUB. 11-11-2008. FILED 6-17-2008.
 3,567,325. **LIVE. RIDE. HIKE. FISH. (BLOCK FORM).** LAKOTA LAKE CAMP, LLC, (U.S. CLS. 100, 103 AND 106). SN 77-501,727. PUB. 11-11-2008. FILED 6-18-2008.
 3,567,329. **SAMSO HITE (BLOCK FORM).** SAMSO HITE LLC, MULTIPLE CLASS, (INT. CLS. 37 AND 38), (U.S. CLS. 100, 101, 103, 104 AND 106). SN 77-501,772. PUB. 11-11-2008. FILED 6-18-2008.
 3,567,350. **SOLARAIRE (BLOCK FORM).** SOLARAIRE, LLC, (U.S. CLS. 100, 103 AND 106). SN 77-502,045. PUB. 11-11-2008. FILED 6-18-2008.
 3,567,391. **MISCELLANEOUS DESIGN.** BISCAYNE AQUACULTURE, INC., (U.S. CLS. 100, 103 AND 106). SN 77-502,670. PUB. 11-11-2008. FILED 6-19-2008.
 3,567,398. **SUNERGY INC. AND DESIGN.** SUNERGY, INC., MULTIPLE CLASS, (INT. CLS. 37 AND 42), (U.S. CLS. 100, 101, 103 AND 106). SN 77-502,807. PUB. 11-11-2008. FILED 6-19-2008.
 3,567,462. **BUFF & COAT (BLOCK FORM).** BUFF & COAT INTERNATIONAL, INC., (U.S. CLS. 100, 103 AND 106). SN 77-504,043. PUB. 11-11-2008. FILED 6-20-2008.
 3,567,649 (*See Class 36 for this trademark.*)
 3,567,712. **ROAD SERVICE ONLINE (BLOCK FORM).** AMERICAN AUTOMOBILE ASSOCIATION, INC., (U.S. CLS. 100, 103 AND 106). SN 77-540,363. PUB. 11-11-2008. FILED 8-6-2008.
 3,567,740. **IMAGE AND DESIGN.** GLOBAL IMAGING SYSTEMS, INC., (U.S. CLS. 100, 103 AND 106). SN 78-576,885. PUB. 11-11-2008. FILED 2-28-2005.
 3,567,839 (*See Class 7 for this trademark.*)
 3,567,868 (*See Class 9 for this trademark.*)
 3,567,915 (*See Class 17 for this trademark.*)
 3,567,926 (*See Class 7 for this trademark.*)
 3,567,933 (*See Class 1 for this trademark.*)
 3,567,934 (*See Class 1 for this trademark.*)
 3,567,935 (*See Class 1 for this trademark.*)
 3,567,936 (*See Class 1 for this trademark.*)
 3,567,953 (*See Class 14 for this trademark.*)
-
- CLASS 38—COMMUNICATION**
- 3,566,283. **TINBU (STYLIZED).** TINBU, LLC, MULTIPLE CLASS, (INT. CLS. 38 AND 42), (U.S. CLS. 100, 101 AND 104). SN 76-678,003. PUB. 11-11-2008. FILED 6-8-2007.
 3,566,358. **UBERSPAT (BLOCK FORM).** UBERSPAT HOLDINGS, LLC, (U.S. CLS. 100, 101 AND 104). SN 76-690,805. PUB. 11-11-2008. FILED 6-23-2008.
 3,566,408 (*See Class 9 for this trademark.*)
 3,566,480 (*See Class 35 for this trademark.*)
 3,566,507. **BLUESTREAK GET CONNECTED AND DESIGN.** UNICAP, INC., (U.S. CLS. 100, 101 AND 104). SN 77-229,369. PUB. 11-11-2008. FILED 7-13-2007.
 3,566,596. **NIFTY | ONLINE TELEVISION AND DESIGN.** NETWORK FOUNDATION TECHNOLOGIES, LLC, (U.S.

CLS. 100, 101 AND 104). SN 77-323,556. PUB. 11-11-2008. FILED 11-7-2007.

3,566,611. **ACEVOICE (BLOCK FORM)**. ACECAPE, INC., (U.S. CLS. 100, 101 AND 104). SN 77-327,502. PUB. 11-11-2008. FILED 11-12-2007.

3,566,612. **ACEPBX (BLOCK FORM)**. ACECAPE, INC., (U.S. CLS. 100, 101 AND 104). SN 77-327,551. PUB. 11-11-2008. FILED 11-12-2007.

3,566,663. **T-MOBILECARD (BLOCK FORM)**. DEUTSCHE TELEKOM AG, (U.S. CLS. 100, 101 AND 104). SN 77-345,611. PUB. 5-20-2008. FILED 12-6-2007.

3,566,697. **FLEXCONNECT (BLOCK FORM)**. KNOLOGY, INC., (U.S. CLS. 100, 101 AND 104). SN 77-352,820. PUB. 11-11-2008. FILED 12-14-2007.

3,566,753 (*See Class 35 for this trademark*).

3,566,757. **YOUHORSEPOWER (BLOCK FORM)**. TYE SAUNDERS, (U.S. CLS. 100, 101 AND 104). SN 77-375,992. PUB. 11-11-2008. FILED 1-19-2008.

3,566,781. **SUPPORTBUDDY (BLOCK FORM)**. MYSOBERLIFE, LLC, (U.S. CLS. 100, 101 AND 104). SN 77-394,259. PUB. 11-11-2008. FILED 2-11-2008.

3,566,836. **T-MOBILE SELECTION (BLOCK FORM)**. DEUTSCHE TELEKOM, (U.S. CLS. 100, 101 AND 104). SN 77-431,345. PUB. 9-9-2008. FILED 3-25-2008.

3,566,876. **SECUREFILEX AND DESIGN**. BENEFIT INSIGHTS, INC., (U.S. CLS. 100, 101 AND 104). SN 77-450,740. PUB. 11-11-2008. FILED 4-17-2008.

3,566,930 (*See Class 9 for this trademark*).

3,566,948. **MOODTV (BLOCK FORM)**. MOODTV PTY LTD, (U.S. CLS. 100, 101 AND 104). SN 77-477,098. PUB. 11-11-2008. FILED 5-16-2008.

3,566,981 (*See Class 36 for this trademark*).

3,566,987. **PUZZLE PIRATES (BLOCK FORM)**. THREE RINGS DESIGN, INC., (U.S. CLS. 100, 101 AND 104). SN 77-485,067. PUB. 11-11-2008. FILED 5-28-2008.

3,567,141. **LETTERS TO MY YOUNGER SELF (BLOCK FORM)**. SPRAGINS, ELLYN, (U.S. CLS. 100, 101 AND 104). SN 77-497,349. PUB. 11-11-2008. FILED 6-12-2008.

3,567,224. **LOKT (BLOCK FORM)**. CONTROL F CORPORATION, DBA LOKT, MULTIPLE CLASS, (INT. CLS. 38 AND 39), (U.S. CLS. 100, 101, 104 AND 105). SN 77-500,161. PUB. 11-11-2008. FILED 6-16-2008.

3,567,311. **MOODY RADIO (BLOCK FORM)**. MOODY BIBLE INSTITUTE OF CHICAGO, MULTIPLE CLASS, (INT. CLS. 38 AND 41), (U.S. CLS. 100, 101, 104 AND 107). SN 77-501,473. PUB. 11-11-2008. FILED 6-18-2008.

3,567,329 (*See Class 37 for this trademark*).

3,567,384. **PIOV (BLOCK FORM)**. PIOV, LLC, (U.S. CLS. 100, 101 AND 104). SN 77-502,602. PUB. 11-11-2008. FILED 6-19-2008.

3,567,461. **DECLARE YOUR CURIOSITY (BLOCK FORM)**. CBS CORPORATION, (U.S. CLS. 100, 101 AND 104). SN 77-503,967. PUB. 11-11-2008. FILED 6-20-2008.

3,567,519. **TRUCKERS AND CITIZENS UNITED (BLOCK FORM)**. TRUCKERS AND CITIZENS UNITED, (U.S. CLS. 100, 101 AND 104). SN 77-505,311. PUB. 11-11-2008. FILED 6-23-2008.

3,567,742 (*See Class 9 for this trademark*).

3,567,745 (*See Class 9 for this trademark*).

3,567,772. **COCO AND DESIGN**. COCO COMMUNICATIONS CORP., (U.S. CLS. 100, 101 AND 104). SN 78-878,077. PUB. 5-29-2007. FILED 5-5-2006.

3,567,773 (*See Class 35 for this trademark*).

3,567,815 (*See Class 9 for this trademark*).

3,567,816 (*See Class 9 for this trademark*).

3,567,824 (*See Class 35 for this trademark*).

3,567,826 (*See Class 9 for this trademark*).

3,567,848 (*See Class 9 for this trademark*).

3,567,872 (*See Class 9 for this trademark*).

3,567,880 (*See Class 9 for this trademark*).

3,567,900 (*See Class 9 for this trademark*).

3,567,916 (*See Class 9 for this trademark*).

3,567,933 (*See Class 1 for this trademark*).

3,567,934 (*See Class 1 for this trademark*).

3,567,935 (*See Class 1 for this trademark*).

3,567,936 (*See Class 1 for this trademark*).

3,567,941 (*See Class 9 for this trademark*).

CLASS 39—TRANSPORTATION AND STORAGE

3,566,293 (*See Class 35 for this trademark*).

3,566,369. **GREAT OCEAN WALK (BLOCK FORM)**. GREAT OCEAN WALK PTY LTD, (U.S. CLS. 100 AND 105). SN 77-011,406. PUB. 11-11-2008. FILED 10-2-2006.

3,566,394. **HOMES AWAY (BLOCK FORM)**. HOMEAWAY, INC., MULTIPLE CLASS, (INT. CLS. 39 AND 43), (U.S. CLS. 100, 101 AND 105). SN 77-064,489. PUB. 11-11-2008. FILED 12-14-2006.

3,566,461 (*See Class 35 for this trademark*).

3,566,590. **GASKEY THE NATURAL GAS FOR GEORGIA AND DESIGN**. PS ENERGY GROUP, INC., (U.S. CLS. 100 AND 105). SN 77-321,490. PUB. 11-11-2008. FILED 11-5-2007.

3,566,735. **JS LOGISTICS (BLOCK FORM)**. JS LOGISTICS, INC., (U.S. CLS. 100 AND 105). SN 77-364,557. PUB. 11-11-2008. FILED 1-4-2008.

3,566,824. **RICH WORLDWIDE TRAVEL INC. AND DESIGN**. RICH WORLDWIDE TRAVEL, INC., MULTIPLE CLASS, (INT. CLS. 39 AND 43), (U.S. CLS. 100, 101 AND 105). SN 77-423,466. PUB. 11-11-2008. FILED 3-17-2008.

3,566,869 (*See Class 31 for this trademark*).

3,566,920 (*See Class 9 for this trademark*).

3,567,090. **IDEAL 55 WINE LOCKERS AND DESIGN**. IDEAL55 WINE LOCKERS, INC., (U.S. CLS. 100 AND 105). SN 77-494,613. PUB. 11-11-2008. FILED 6-9-2008.

3,567,149. **RENEGY ENLIGHTENED GENERATION AND DESIGN**. RENEGY HOLDINGS, INC., (U.S. CLS. 100 AND 105). SN 77-497,588. PUB. 11-11-2008. FILED 6-12-2008.

3,567,163. **THE CLEANER ROAD AHEAD (BLOCK FORM)**. BNSF RAILWAY COMPANY, (U.S. CLS. 100 AND 105). SN 77-498,252. PUB. 11-11-2008. FILED 6-13-2008.

3,567,188. **WINGS OVER SOUTH AFRICA (BLOCK FORM)**. INTERNATIONAL EXPEDITIONS, INC., (U.S. CLS. 100 AND 105). SN 77-499,556. PUB. 11-11-2008. FILED 6-16-2008.

3,567,191. **THE GREATEST VOYAGE IN NATURAL HISTORY (BLOCK FORM)**. INTERNATIONAL EXPEDITIONS, INC., (U.S. CLS. 100 AND 105). SN 77-499,581. PUB. 11-11-2008. FILED 6-16-2008.

3,567,224 (*See Class 38 for this trademark*).

3,567,225. **MOUSETALES AND DESIGN**. ROBERT J. HILL JR., DBA MOUSE TALES TRAVEL, (U.S. CLS. 100 AND 105). SN 77-500,174. PUB. 11-11-2008. FILED 6-16-2008.

3,567,262. **TRANS-UNITED (BLOCK FORM)**. TRANS-UNITED, INC., (U.S. CLS. 100 AND 105). SN 77-500,815. PUB. 11-11-2008. FILED 6-17-2008.

3,567,267. **TRUCKISMO (BLOCK FORM)**. TRANS-UNITED, INC., (U.S. CLS. 100 AND 105). SN 77-500,841. PUB. 11-11-2008. FILED 6-17-2008.

3,567,375. **TRAVEL PERKS AT WORK (BLOCK FORM)**. KRESSLEY, PAMELA A., (U.S. CLS. 100 AND 105). SN 77-502,427. PUB. 11-11-2008. FILED 6-18-2008.

3,567,431. **HUSH (BLOCK FORM)**. HUSH TOURS, INC. (U.S. CLS. 100 AND 105). SN 77-503,369. PUB. 11-11-2008. FILED 6-19-2008.

3,567,507. **DD4HIRE (BLOCK FORM)**. DD4HIRE, INC., (U.S. CLS. 100 AND 105). SN 77-505,096. PUB. 11-11-2008. FILED 6-23-2008.

3,567,526. **WE HAVE THE DRIVERS. YOU HAVE THE FUN. (BLOCK FORM)**. DD4HIRE, INC., (U.S. CLS. 100 AND 105). SN 77-505,408. PUB. 11-11-2008. FILED 6-23-2008.

3,567,535. **GONDOLA ADVENTURES (BLOCK FORM)**. GONDOLA ADVENTURES, INC., (U.S. CLS. 100 AND 105). SN 77-505,589. PUB. 11-11-2008. FILED 6-23-2008.

3,567,568. **BAGSTER (BLOCK FORM)**. BAGSTER, LLC, (U.S. CLS. 100 AND 105). SN 77-506,434. PUB. 11-11-2008. FILED 6-24-2008.

3,567,569. **DUMPSTER IN A BAG (BLOCK FORM)**. BAGSTER, LLC, (U.S. CLS. 100 AND 105). SN 77-506,451. PUB. 11-11-2008. FILED 6-24-2008.

3,567,617. **YOUR TOOLS, YOUR LABOR, YOUR SAVINGS (BLOCK FORM)**. NORDSTROM'S AUTOMOTIVE, INC., (U.S. CLS. 100 AND 105). SN 77-507,762. PUB. 11-11-2008. FILED 6-25-2008.

3,567,795. **BIG AMAZON FISH (BLOCK FORM)**. BIG AMAZON FISH, LLC, MULTIPLE CLASS, (INT. CLS. 39 AND 41), (U.S. CLS. 100, 101, 105 AND 107). SN 78-978,902. PUB. 11-11-2008. FILED 8-4-2006.

3,567,824 (*See Class 35 for this trademark.*)
 3,567,850 (*See Class 4 for this trademark.*)
 3,567,863 (*See Class 4 for this trademark.*)
 3,567,864 (*See Class 4 for this trademark.*)
 3,567,881 (*See Class 12 for this trademark.*)
 3,567,887 (*See Class 12 for this trademark.*)
 3,567,933 (*See Class 1 for this trademark.*)
 3,567,934 (*See Class 1 for this trademark.*)
 3,567,935 (*See Class 1 for this trademark.*)
 3,567,936 (*See Class 1 for this trademark.*)
 3,567,941 (*See Class 9 for this trademark.*)
 3,567,980 (*See Class 35 for this trademark.*)

CLASS 40—MATERIAL TREATMENT

3,566,264 (*See Class 9 for this trademark.*)
 3,566,271 (*See Class 9 for this trademark.*)
 3,566,371 (*See Class 9 for this trademark.*)
 3,566,389. **KEEP IT COVERED INC. AND DESIGN. KEEP IT COVERED INC.**, (U.S. CLS. 100, 103 AND 106). SN 77-055,104. PUB. 11-11-2008. FILED 12-1-2006.
 3,566,529. **ROADRAGE (BLOCK FORM). ROAD RAGE, INC.**, (U.S. CLS. 100, 103 AND 106). SN 77-261,772. PUB. 11-11-2008. FILED 8-22-2007.
 3,566,530. **ROAD RAGE (BLOCK FORM). ROAD RAGE, INC.**, (U.S. CLS. 100, 103 AND 106). SN 77-261,782. PUB. 11-11-2008. FILED 8-22-2007.
 3,566,561 (*See Class 36 for this trademark.*)
 3,566,603 (*See Class 36 for this trademark.*)
 3,566,613. **INTEGRATED SOLUTIONS BY POSITECH AND DESIGN. AMERICAN HANDLING SYSTEMS, INC., DBA POSITECH CORPORATION**, (U.S. CLS. 100, 103 AND 106). SN 77-328,024. PUB. 11-11-2008. FILED 11-13-2007.
 3,566,636 (*See Class 35 for this trademark.*)
 3,566,660 (*See Class 20 for this trademark.*)
 3,566,865 (*See Class 1 for this trademark.*)
 3,566,899. **MIMEO MARKETPLACE (BLOCK FORM). MIMEO.COM, INC.**, MULTIPLE CLASS, (INT. CLS. 40 AND 41), (U.S. CLS. 100, 101, 103, 106 AND 107). SN 77-461,476. PUB. 11-11-2008. FILED 4-30-2008.
 3,566,900. **MIMEO MARKETPLACE AND DESIGN. MIMEO.COM, INC.**, MULTIPLE CLASS, (INT. CLS. 40 AND 41), (U.S. CLS. 100, 101, 103, 106 AND 107). SN 77-461,496. PUB. 11-11-2008. FILED 4-30-2008.
 3,566,938. **PLASTINUM POLYMER TECHNOLOGIES CORP AND DESIGN. PLASTINUM POLYMER TECHNOLOGIES CORP.**, (U.S. CLS. 100, 103 AND 106). SN 77-475,407. PUB. 11-11-2008. FILED 5-15-2008.
 3,566,940. **BLENDYMER (BLOCK FORM). PLASTINUM POLYMER TECHNOLOGIES CORP.**, (U.S. CLS. 100, 103 AND 106). SN 77-475,441. PUB. 11-11-2008. FILED 5-15-2008.
 3,566,961. **MEDITERRANEA GREENWORLD (BLOCK FORM). ARCHITECTURAL IMPORTS, LLC**, (U.S. CLS. 100, 103 AND 106). SN 77-481,147. PUB. 11-11-2008. FILED 5-22-2008.
 3,566,963 (*See Class 36 for this trademark.*)
 3,566,975. **AMSTAR SURFACE TECHNOLOGY (BLOCK FORM). AMSTAR SURFACE TECHNOLOGY, LTD.**, (U.S. CLS. 100, 103 AND 106). SN 77-483,356. PUB. 11-11-2008. FILED 5-26-2008.
 3,566,976. **AMSTAR 888 (BLOCK FORM). AMSTAR SURFACE TECHNOLOGY, LTD.**, (U.S. CLS. 100, 103 AND 106). SN 77-483,364. PUB. 11-11-2008. FILED 5-26-2008.
 3,567,006. **ICELAND AMERICA ENERGY AND DESIGN. ICELAND AMERICA ENERGY, INC., DBA ICELAND AMERICA ENERGY**, (U.S. CLS. 100, 103 AND 106). SN 77-487,319. PUB. 11-11-2008. FILED 5-30-2008.
 3,567,062. **WHAT HAVE YOU GOT TO HIDE? (BLOCK FORM). DRAPER, INC.**, (U.S. CLS. 100, 103 AND 106). SN 77-492,805. PUB. 11-11-2008. FILED 6-6-2008.
 3,567,096. **TECHNOLOGY CONSERVATION GROUP AND DESIGN. TECHNOLOGY CONSERVATION GROUP, INC.**, (U.S. CLS. 100, 103 AND 106). SN 77-494,919. PUB. 11-11-2008. FILED 6-10-2008.
 3,567,144 (*See Class 6 for this trademark.*)
 3,567,215. **TALON PROTECTIVE COATING (BLOCK FORM).**

FALCON INTERNATIONAL, INC., (U.S. CLS. 100, 103 AND 106). SN 77-499,944. PUB. 11-11-2008. FILED 6-16-2008.
 3,567,217. **TALON PROTECTIVE COATING AND DESIGN. FALCON INTERNATIONAL, INC.**, (U.S. CLS. 100, 103 AND 106). SN 77-499,957. PUB. 11-11-2008. FILED 6-16-2008.
 3,567,346. **BELLOWSTECH (BLOCK FORM). PRECISION MANUFACTURING GROUP, LLC. MULTIPLE CLASS**, (INT. CLS. 40 AND 42), (U.S. CLS. 100, 101, 103 AND 106). SN 77-502,013. PUB. 11-11-2008. FILED 6-18-2008.
 3,567,456. **PUP'PAREL (BLOCK FORM). DARNIGOLD FOR-EST, LLC**, (U.S. CLS. 100, 103 AND 106). SN 77-503,791. PUB. 11-11-2008. FILED 6-20-2008.
 3,567,524. **DINES L PLASTICS INC. AND DESIGN. DINESOL PLASTICS, INC.**, (U.S. CLS. 100, 103 AND 106). SN 77-505,382. PUB. 11-11-2008. FILED 6-23-2008.
 3,567,552 (*See Class 9 for this trademark.*)
 3,567,683. **THE FRIENDLY GEEKS (BLOCK FORM). DIGITAL IMS, INC.**, (U.S. CLS. 100, 103 AND 106). SN 77-525,771. PUB. 11-11-2008. FILED 7-18-2008.
 3,567,684. **YOU'LL LOVE US (BLOCK FORM). DIGITAL IMS, INC.**, (U.S. CLS. 100, 103 AND 106). SN 77-525,772. PUB. 11-11-2008. FILED 7-18-2008.
 3,567,685. **YOUR IMAGE IS OUR INSPIRATION (BLOCK FORM). DIGITAL IMS, INC.**, (U.S. CLS. 100, 103 AND 106). SN 77-525,776. PUB. 11-11-2008. FILED 7-18-2008.
 3,567,730 (*See Class 9 for this trademark.*)
 3,567,775. **COMPERJ (BLOCK FORM). PETROLEO BRASILEIRO S.A.- PETROBRAS**, (U.S. CLS. 100, 103 AND 106). SN 78-903,566. PUB. 11-11-2008. FILED 6-8-2006.
 3,567,850 (*See Class 4 for this trademark.*)
 3,567,863 (*See Class 4 for this trademark.*)
 3,567,864 (*See Class 4 for this trademark.*)
 3,567,868 (*See Class 9 for this trademark.*)
 3,567,891 (*See Class 7 for this trademark.*)
 3,567,931 (*See Class 1 for this trademark.*)
 3,567,933 (*See Class 1 for this trademark.*)
 3,567,934 (*See Class 1 for this trademark.*)
 3,567,935 (*See Class 1 for this trademark.*)
 3,567,936 (*See Class 1 for this trademark.*)

CLASS 41—EDUCATION AND ENTERTAINMENT

3,566,259. **NOW PLAYING. FRED WEHREBERG CIRCUIT OF THEATRES, INC.**, (U.S. CLS. 100, 101 AND 107). SN 76-474,586. PUB. 11-11-2008. FILED 12-6-2002.
 3,566,260 (*See Class 35 for this trademark.*)
 3,566,267 (*See Class 9 for this trademark.*)
 3,566,268 (*See Class 9 for this trademark.*)
 3,566,315. **EYEBLAST.TV (STYLIZED). MEDIA RESEARCH CENTER, MULTIPLE CLASS**, (INT. CLS. 41 AND 42), (U.S. CLS. 100, 101 AND 107). SN 76-687,390. PUB. 11-11-2008. FILED 3-5-2008.
 3,566,317. **GACS AND DESIGN. GREATER ATLANTA CHRISTIAN SCHOOLS, INC.**, (U.S. CLS. 100, 101 AND 107). SN 76-687,722. PUB. 11-11-2008. FILED 3-14-2008.
 3,566,318. **GACS AND DESIGN. GREATER ATLANTA CHRISTIAN SCHOOLS, INC.**, (U.S. CLS. 100, 101 AND 107). SN 76-687,723. PUB. 11-11-2008. FILED 3-14-2008.
 3,566,319. **S AND DESIGN. GREATER ATLANTA CHRISTIAN SCHOOLS, INC.**, (U.S. CLS. 100, 101 AND 107). SN 76-687,724. PUB. 11-11-2008. FILED 3-14-2008.
 3,566,320. **LADY SPAR ANS AND DESIGN. GREATER ATLANTA CHRISTIAN SCHOOLS, INC.**, (U.S. CLS. 100, 101 AND 107). SN 76-687,725. PUB. 11-11-2008. FILED 3-14-2008.
 3,566,321. **MISCELLANEOUS DESIGN. GREATER ATLANTA CHRISTIAN SCHOOLS, INC.**, (U.S. CLS. 100, 101 AND 107). SN 76-687,726. PUB. 11-11-2008. FILED 3-14-2008.
 3,566,322. **SPAR ANS AND DESIGN. GREATER ATLANTA CHRISTIAN SCHOOLS, INC.**, (U.S. CLS. 100, 101 AND 107). SN 76-687,727. PUB. 11-11-2008. FILED 3-14-2008.
 3,566,323. **WINE & DINE (STYLIZED). WINE & DINE PROPERTIES LTD**, (U.S. CLS. 100, 101 AND 107). SN 76-687,919. PUB. 11-11-2008. FILED 3-20-2008.
 3,566,339. **REGGAE RUNNINS (BLOCK FORM). REGGAE**

- RUNNINS, (U.S. CLS. 100, 101 AND 107). SN 76-690,221. PUB. 11-11-2008. FILED 6-2-2008.
- 3,566,343. **SALES REALITY (BLOCK FORM)**. BUSINESS METHODOLOGIES INTERNATIONAL, LTD., (U.S. CLS. 100, 101 AND 107). SN 76-690,346. PUB. 11-11-2008. FILED 6-6-2008.
- 3,566,344. **CASH FLOW (BLOCK FORM)**. BUSINESS METHODOLOGIES INTERNATIONAL, LTD., (U.S. CLS. 100, 101 AND 107). SN 76-690,347. PUB. 11-11-2008. FILED 6-6-2008.
- 3,566,362 (*See Class 35 for this trademark*).
- 3,566,370. **DIRTBAG CHALLENGE (BLOCK FORM)**. BROWN, PAUL ROBERT, (U.S. CLS. 100, 101 AND 107). SN 77-014,254. PUB. 11-11-2008. FILED 10-5-2006.
- 3,566,387. **THE FAIRY PRINCESS (BLOCK FORM)**. UNION STATION KANSAS CITY, INC., (U.S. CLS. 100, 101 AND 107). SN 77-052,038. PUB. 11-11-2008. FILED 11-28-2006.
- 3,566,393. **IAMHAWAII.COM AND DESIGN**. IAM HAWAII, LLC, (U.S. CLS. 100, 101 AND 107). SN 77-064,436. PUB. 11-11-2008. FILED 12-14-2006.
- 3,566,396 (*See Class 9 for this trademark*).
- 3,566,397 (*See Class 9 for this trademark*).
- 3,566,405. **CHANNELPRO (BLOCK FORM)**. CHANNEL ENABLERS USA, LLC, (U.S. CLS. 100, 101 AND 107). SN 77-078,971. PUB. 11-11-2008. FILED 1-9-2007.
- 3,566,408 (*See Class 9 for this trademark*).
- 3,566,429. **20/20 FITNESS (BLOCK FORM)**. GARLOFF, RICK L., (U.S. CLS. 100, 101 AND 107). SN 77-119,080. PUB. 4-15-2008. FILED 2-28-2007.
- 3,566,455 (*See Class 9 for this trademark*).
- 3,566,459 (*See Class 6 for this trademark*).
- 3,566,461 (*See Class 35 for this trademark*).
- 3,566,469. **REINA DE LA FIESTA DE LA FRUTA Y DE LAS FLORES DE LOS ANGELES (BLOCK FORM)**. CLUB ORIGINAL AMBATO, (U.S. CLS. 100, 101 AND 107). SN 77-188,985. PUB. 11-11-2008. FILED 5-23-2007.
- 3,566,470 (*See Class 16 for this trademark*).
- 3,566,472. **FLEX 7 (BLOCK FORM)**. SWANK AUDIO VISUALS, L.L.C., (U.S. CLS. 100, 101 AND 107). SN 77-195,877. PUB. 11-11-2008. FILED 6-1-2007.
- 3,566,486. **WELL CONTROL TRAINING A DIVISION OF WILD WELL CONTROL, INC. AND DESIGN**. WILD WELL CONTROL, INC., (U.S. CLS. 100, 101 AND 107). SN 77-210,540. PUB. 11-11-2008. FILED 6-20-2007.
- 3,566,487. **STUDIO FOR CHANGE (BLOCK FORM)**. FLOURISH STUDIOS LLC, MULTIPLE CLASS, (INT. CLS. 41 AND 44), (U.S. CLS. 100, 101 AND 107). SN 77-210,633. PUB. 11-11-2008. FILED 6-20-2007.
- 3,566,500 (*See Class 9 for this trademark*).
- 3,566,508 (*See Class 1 for this trademark*).
- 3,566,520. **T & M TOURISM & MORE AND DESIGN**. TOURISM & MORE, INC., MULTIPLE CLASS, (INT. CLS. 41 AND 45), (U.S. CLS. 100, 101 AND 107). SN 77-253,864. PUB. 11-11-2008. FILED 8-13-2007.
- 3,566,523. **CERTIFIED GREENPOINT RATER (BLOCK FORM)**. BUILD IT GREEN, INC., (U.S. CLS. 100, 101 AND 107). SN 77-259,933. PUB. 11-11-2008. FILED 8-20-2007.
- 3,566,538. **V AND DESIGN**. US WEALTH MANAGEMENT, LLC, (U.S. CLS. 100, 101 AND 107). SN 77-270,857. PUB. 11-11-2008. FILED 9-4-2007.
- 3,566,547 (*See Class 16 for this trademark*).
- 3,566,549. **RESOUNDING JOY AND DESIGN**. RESOUNDING JOY, INC., MULTIPLE CLASS, (INT. CLS. 41 AND 44), (U.S. CLS. 100, 101 AND 107). SN 77-284,544. PUB. 11-11-2008. FILED 9-20-2007.
- 3,566,551. **CELEBRATE YOUR LIFE (BLOCK FORM)**. MISHKA PRODUCTIONS, INC., (U.S. CLS. 100, 101 AND 107). SN 77-286,260. PUB. 11-11-2008. FILED 9-21-2007.
- 3,566,554. **BORN ABILITY (BLOCK FORM)**. THE WILLIS GROUP, (U.S. CLS. 100, 101 AND 107). SN 77-287,524. PUB. 11-11-2008. FILED 9-24-2007.
- 3,566,555 (*See Class 35 for this trademark*).
- 3,566,565. **JENNIFER LOOMIS PHOTOGRAPHY FEEL BEAUTIFUL (BLOCK FORM)**. JENNIFER LOOMIS, (U.S. CLS. 100, 101 AND 107). SN 77-302,720. PUB. 11-11-2008. FILED 10-12-2007.
- 3,566,566 (*See Class 9 for this trademark*).
- 3,566,580. **ACADEMIC RADIO (BLOCK FORM)**. DAVID LIVINGSTON, DBA THE ACAPPELLA PARTNERSHIP LLC, (U.S. CLS. 100, 101 AND 107). SN 77-315,995. PUB. 11-11-2008. FILED 10-29-2007.
- 3,566,587. **PRECISION LIFESTYLE AND DESIGN**. TERRIO PHYSICAL THERAPY-FITNESS, INC., (U.S. CLS. 100, 101 AND 107). SN 77-319,224. PUB. 11-11-2008. FILED 11-1-2007.
- 3,566,597. **JAK FROST AND DESIGN**. DA EMPIRE ENTERTAINMENT GROUP, LLC, (U.S. CLS. 100, 101 AND 107). SN 77-324,823. PUB. 11-11-2008. FILED 11-8-2007.
- 3,566,600 (*See Class 9 for this trademark*).
- 3,566,610 (*See Class 35 for this trademark*).
- 3,566,614 (*See Class 35 for this trademark*).
- 3,566,615 (*See Class 35 for this trademark*).
- 3,566,616. **HEALTHMILES (BLOCK FORM)**. VIRGIN HEALTHMILES, INC., (U.S. CLS. 100, 101 AND 107). SN 77-328,608. PUB. 11-11-2008. FILED 11-13-2007.
- 3,566,624 (*See Class 25 for this trademark*).
- 3,566,625 (*See Class 25 for this trademark*).
- 3,566,626 (*See Class 25 for this trademark*).
- 3,566,627. **JET CITY ROLLERGIRLS 425 AND DESIGN**. JET CITY ROLLERGIRLS, (U.S. CLS. 100, 101 AND 107). SN 77-331,984. PUB. 11-11-2008. FILED 11-16-2007.
- 3,566,632. **EYE Q TEST AND DESIGN**. HERSHEY ASSOCIATES, (U.S. CLS. 100, 101 AND 107). SN 77-334,762. PUB. 11-11-2008. FILED 11-20-2007.
- 3,566,634. **OBRAS DE HUEVOS (BLOCK FORM)**. COMUNIDAD HUEVO, S.A. DE C.V., (U.S. CLS. 100, 101 AND 107). SN 77-335,004. PUB. 11-11-2008. FILED 11-21-2007.
- 3,566,640 (*See Class 35 for this trademark*).
- 3,566,645. **CARAT CALIFORNIA RESOURCES AND TRAINING AND DESIGN**. CALIFORNIA RESOURCES AND TRAINING, (U.S. CLS. 100, 101 AND 107). SN 77-339,410. PUB. 11-11-2008. FILED 11-28-2007.
- 3,566,649. **INTERNET EVOLUTION (BLOCK FORM)**. UNITED BUSINESS MEDIA LLC, MULTIPLE CLASS, (INT. CLS. 41 AND 42), (U.S. CLS. 100, 101 AND 107). SN 77-340,564. PUB. 11-11-2008. FILED 11-29-2007.
- 3,566,650. **TACP TECHNICAL ASSISTANCE CAPACITY BUILDING PROGRAM AND DESIGN**. CALIFORNIA RESOURCES AND TRAINING, (U.S. CLS. 100, 101 AND 107). SN 77-340,645. PUB. 11-11-2008. FILED 11-29-2007.
- 3,566,652. **GHETTO INMATES (BLOCK FORM)**. ROSADO, MARCUS, AND ROSADO, STEVEN, (U.S. CLS. 100, 101 AND 107). SN 77-342,074. PUB. 11-11-2008. FILED 12-2-2007.
- 3,566,653 (*See Class 16 for this trademark*).
- 3,566,654. **TRUMP ENTERTAINMENT RESORTS (STYLIZED)**. TRUMP, DONALD J., MULTIPLE CLASS, (INT. CLS. 41 AND 43), (U.S. CLS. 100, 101 AND 107). SN 77-342,507. PUB. 11-11-2008. FILED 12-3-2007.
- 3,566,661. **THE VIRTUAL TRANQUILIZER (BLOCK FORM)**. MEDEA, ANDRA, (U.S. CLS. 100, 101 AND 107). SN 77-343,434. PUB. 11-11-2008. FILED 12-4-2007.
- 3,566,665. **LA GAVIOTA (BLOCK FORM)**. RAMOS, DANIEL, (U.S. CLS. 100, 101 AND 107). SN 77-345,915. PUB. 11-11-2008. FILED 12-6-2007.
- 3,566,671. **TINY MACHINES (BLOCK FORM)**. TINY MACHINES, (U.S. CLS. 100, 101 AND 107). SN 77-347,359. PUB. 11-11-2008. FILED 12-8-2007.
- 3,566,685. **AGE OF ENLIVENMENT (BLOCK FORM)**. CONSERVATORY SENIOR RESIDENCES, LTD., MULTIPLE CLASS, (INT. CLS. 41, 43, 44 AND 45), (U.S. CLS. 100, 101 AND 107). SN 77-349,856. PUB. 11-11-2008. FILED 12-12-2007.
- 3,566,693. **DIRECT IMAGES INTERACTIVE (BLOCK FORM)**. DIRECT IMAGES INTERACTIVE, INC., MULTIPLE CLASS, (INT. CLS. 41 AND 42), (U.S. CLS. 100, 101 AND 107). SN 77-351,780. PUB. 11-11-2008. FILED 12-13-2007.
- 3,566,705 (*See Class 35 for this trademark*).
- 3,566,718. **DIRECT IMAGES INTERACTIVE AND DESIGN**. DIRECT IMAGES INTERACTIVE, INC., MULTIPLE CLASS, (INT. CLS. 41 AND 42), (U.S. CLS. 100, 101 AND 107). SN 77-359,437. PUB. 11-11-2008. FILED 12-26-2007.
- 3,566,726. **ADMISSIONS BLUEPRINT (BLOCK FORM)**. GRAVES, KATHARINE, (U.S. CLS. 100, 101 AND 107). SN 77-362,113. PUB. 11-11-2008. FILED 12-31-2007.
- 3,566,730. **LIFERS AND DESIGN**. SOLERA COMMUNITY CHURCH, INC., DBA COVENANT LIFE CHRISTIAN CHURCH, INC., (U.S. CLS. 100, 101 AND 107). SN 77-362,629. PUB. 11-11-2008. FILED 1-2-2008.

- 3,566,733. **LAUNCH ENTERTAINMENT (BLOCK FORM)**. PIZARRO, GLADYS A., (U.S. CLS. 100, 101 AND 107). SN 77-363,758. PUB. 11-11-2008. FILED 1-3-2008.
- 3,566,750. **E ENERGY ARTS AND DESIGN**. BRUCE KUMAR FRANTZIS, (U.S. CLS. 100, 101 AND 107). SN 77-371,390. PUB. 11-11-2008. FILED 1-14-2008.
- 3,566,771. **PASSION PLAY MINISTRIES INTERNATIONAL "THAT THEY ALL MAY BE ONE... THAT THE WORLD MAY BELIEVE" AND DESIGN**. PASSION PLAY MINISTRIES INTERNATIONAL, (U.S. CLS. 100, 101 AND 107). SN 77-386,744. PUB. 11-11-2008. FILED 2-1-2008.
- 3,566,773 (*See Class 9 for this trademark*).
- 3,566,785. **INSIDE OUT LITERARY ARTS PROJECT AND DESIGN**. INSIDEOUT LITERARY ARTS PROJECT, DBA INSIDEOUT DETROIT, (U.S. CLS. 100, 101 AND 107). SN 77-395,793. PUB. 11-11-2008. FILED 2-13-2008.
- 3,566,791 (*See Class 9 for this trademark*).
- 3,566,813 (*See Class 35 for this trademark*).
- 3,566,817. **MAKE EVERY SEAT COUNT (BLOCK FORM)**. COLOR METHODS, INC., DBA CMI COMMUNICATIONS, (U.S. CLS. 100, 101 AND 107). SN 77-419,018. PUB. 11-11-2008. FILED 3-11-2008.
- 3,566,818. **CMI COMMUNICATIONS (BLOCK FORM)**. COLOR METHODS, INC., DBA CMI COMMUNICATIONS, (U.S. CLS. 100, 101 AND 107). SN 77-419,023. PUB. 11-11-2008. FILED 3-11-2008.
- 3,566,833. **VIMS EDUCATION GROUP AND DESIGN**. VIMS EDUCATION GROUP, (U.S. CLS. 100, 101 AND 107). SN 77-430,162. PUB. 11-11-2008. FILED 3-24-2008.
- 3,566,864. **CFS AND DESIGN**. THE CENTER FOR CAMPUS FIRE SAFETY, INC., MULTIPLE CLASS, (INT. CLS. 41 AND 45), (U.S. CLS. 100, 101 AND 107). SN 77-445,832. PUB. 11-11-2008. FILED 4-11-2008.
- 3,566,872. **MJE (BLOCK FORM)**. MANHATTAN JEWISH EXPERIENCE SYNAGOGUE, (U.S. CLS. 100, 101 AND 107). SN 77-449,183. PUB. 11-11-2008. FILED 4-15-2008.
- 3,566,875. **PORNPROS (BLOCK FORM)**. SSC GROUP, LLC, (U.S. CLS. 100, 101 AND 107). SN 77-450,278. PUB. 11-11-2008. FILED 4-16-2008.
- 3,566,877. **ANTIOCH UNIVERSITY SANTA BARBARA (BLOCK FORM)**. ANTIOCH UNIVERSITY, (U.S. CLS. 100, 101 AND 107). SN 77-450,991. PUB. 11-11-2008. FILED 4-17-2008.
- 3,566,879. **ANTIOCH UNIVERSITY LOS ANGELES (BLOCK FORM)**. ANTIOCH UNIVERSITY, (U.S. CLS. 100, 101 AND 107). SN 77-451,022. PUB. 11-11-2008. FILED 4-17-2008.
- 3,566,880. **ANTIOCH UNIVERSITY NEW ENGLAND (BLOCK FORM)**. ANTIOCH UNIVERSITY, (U.S. CLS. 100, 101 AND 107). SN 77-451,076. PUB. 11-11-2008. FILED 4-17-2008.
- 3,566,881. **ANTIOCH UNIVERSITY SEATTLE (BLOCK FORM)**. ANTIOCH UNIVERSITY, (U.S. CLS. 100, 101 AND 107). SN 77-451,111. PUB. 11-11-2008. FILED 4-17-2008.
- 3,566,882. **MASCC (BLOCK FORM)**. MULTINATIONAL ASSOCIATION OF SUPPORTIVE CARE IN CANCER, (U.S. CLS. 100, 101 AND 107). SN 77-452,370. PUB. 11-11-2008. FILED 4-18-2008.
- 3,566,892. **GUGGENHEIM PRODUCTIONS INC (BLOCK FORM)**. GUGGENHEIM PRODUCTIONS INC., (U.S. CLS. 100, 101 AND 107). SN 77-457,007. PUB. 11-11-2008. FILED 4-24-2008.
- 3,566,893 (*See Class 25 for this trademark*).
- 3,566,894. **THE OASIS AND DESIGN**. ARIZONA GRAND RESORT, LLC, MULTIPLE CLASS, (INT. CLS. 41 AND 44), (U.S. CLS. 100, 101 AND 107). SN 77-458,528. PUB. 11-11-2008. FILED 4-25-2008.
- 3,566,895. **CRAZY LIGHT LADY (BLOCK FORM)**. PARTANEN, ANNALISA, (U.S. CLS. 100, 101 AND 107). SN 77-459,428. PUB. 11-11-2008. FILED 4-28-2008.
- 3,566,899 (*See Class 40 for this trademark*).
- 3,566,900 (*See Class 40 for this trademark*).
- 3,566,901 (*See Class 35 for this trademark*).
- 3,566,902 (*See Class 28 for this trademark*).
- 3,566,924. **THE MUSEUM OF THE AMERICAN COCKTAIL 1803 WORLD COCKTAIL WEEK AND DESIGN**. MUSEUM OF THE AMERICAN COCKTAIL, INC., (U.S. CLS. 100, 101 AND 107). SN 77-470,003. PUB. 11-11-2008. FILED 5-9-2008.
- 3,566,926 (*See Class 35 for this trademark*).
- 3,566,939. **EDUCATA AND DESIGN**. WEBEDU, LLC, (U.S. CLS. 100, 101 AND 107). SN 77-475,435. PUB. 11-11-2008. FILED 5-15-2008.
- 3,566,942. **GLADIATOR FIT (STYLIZED)**. JOHN L. ROTONTI, JR., (U.S. CLS. 100, 101 AND 107). SN 77-475,701. PUB. 11-11-2008. FILED 5-15-2008.
- 3,566,946. **FEEL GOOD FACTORY (BLOCK FORM)**. SHAPE-MASTER USA, INC., (U.S. CLS. 100, 101 AND 107). SN 77-476,408. PUB. 11-11-2008. FILED 5-16-2008.
- 3,566,952. **401K LATINO AND DESIGN**. FUTURO LATINO, LLC, (U.S. CLS. 100, 101 AND 107). SN 77-478,918. PUB. 11-11-2008. FILED 5-20-2008.
- 3,566,954. **GIRON (BLOCK FORM)**. SOMERA, ANTONIO, (U.S. CLS. 100, 101 AND 107). SN 77-479,281. PUB. 11-11-2008. FILED 5-20-2008.
- 3,566,956. **SACRED LIFE SERIES (BLOCK FORM)**. LUND, SHARON, (U.S. CLS. 100, 101 AND 107). SN 77-479,673. PUB. 11-11-2008. FILED 5-20-2008.
- 3,566,962. **FESTIVAL EARTH (BLOCK FORM)**. RENDA BROADCASTING CORPORATION, (U.S. CLS. 100, 101 AND 107). SN 77-481,168. PUB. 11-11-2008. FILED 5-22-2008.
- 3,566,964. **IN-SHAPE FITNESS (BLOCK FORM)**. IN SHAPE HEALTH CLUBS, INC., (U.S. CLS. 100, 101 AND 107). SN 77-481,622. PUB. 11-11-2008. FILED 5-22-2008.
- 3,566,971. **IN-SHAPE SPORTS CLUB (BLOCK FORM)**. IN SHAPE HEALTH CLUBS, INC., (U.S. CLS. 100, 101 AND 107). SN 77-482,877. PUB. 11-11-2008. FILED 5-23-2008.
- 3,566,972. **IN-SHAPE SPORT (BLOCK FORM)**. IN SHAPE HEALTH CLUBS, INC., (U.S. CLS. 100, 101 AND 107). SN 77-482,884. PUB. 11-11-2008. FILED 5-23-2008.
- 3,566,973 (*See Class 9 for this trademark*).
- 3,566,983. **HEARTLAND HARVEST GARDEN (BLOCK FORM)**. POWELL GARDENS INC., (U.S. CLS. 100, 101 AND 107). SN 77-484,225. PUB. 11-11-2008. FILED 5-27-2008.
- 3,566,988. **PUZZLE PIRATES (BLOCK FORM)**. THREE RINGS DESIGN, INC., (U.S. CLS. 100, 101 AND 107). SN 77-485,086. PUB. 11-11-2008. FILED 5-28-2008.
- 3,566,996 (*See Class 25 for this trademark*).
- 3,566,999. **PROGRESSIVE AGRICULTURE SAFETY DAY ESTABLISHED 1995 AND DESIGN**. PROGRESSIVE AGRICULTURE FOUNDATION, (U.S. CLS. 100, 101 AND 107). SN 77-486,491. PUB. 11-11-2008. FILED 5-29-2008.
- 3,567,001 (*See Class 9 for this trademark*).
- 3,567,003 (*See Class 35 for this trademark*).
- 3,567,007 (*See Class 9 for this trademark*).
- 3,567,015. **CUPCAKE KIDS! (BLOCK FORM)**. WALTER, JESSICA G, (U.S. CLS. 100, 101 AND 107). SN 77-487,994. PUB. 11-11-2008. FILED 5-31-2008.
- 3,567,021. **CHAMPIONS ADVENTURE, AFTER SCHOOL AND SPORTS PROGRAMS AND DESIGN**. GOOD SPORTS PLUS LTD., (U.S. CLS. 100, 101 AND 107). SN 77-488,519. PUB. 11-11-2008. FILED 6-2-2008.
- 3,567,022. **CHAMPIONS AND DESIGN**. GOOD SPORTS PLUS LTD., (U.S. CLS. 100, 101 AND 107). SN 77-488,554. PUB. 11-11-2008. FILED 6-2-2008.
- 3,567,024. **HELPING ATHLETES WIN THE MIND GAME (BLOCK FORM)**. ADVANCED PSYCHIATRY, P.A., MULTIPLE CLASS, (INT. CLS. 41 AND 44), (U.S. CLS. 100, 101 AND 107). SN 77-488,856. PUB. 11-11-2008. FILED 6-2-2008.
- 3,567,027. **TUTERA TIPS (BLOCK FORM)**. TUTERA, DAVID, (U.S. CLS. 100, 101 AND 107). SN 77-489,399. PUB. 11-11-2008. FILED 6-3-2008.
- 3,567,048. **ELICIT ENTERTAINMENT L.L.C. AND DESIGN**. ELICIT ENTERTAINMENT, LLC, (U.S. CLS. 100, 101 AND 107). SN 77-491,333. PUB. 11-11-2008. FILED 6-5-2008.
- 3,567,056. **REGRETLAND BOOKS AND DESIGN**. THE HEALTH AND WEALTH TEAM INC., (U.S. CLS. 100, 101 AND 107). SN 77-492,278. PUB. 11-11-2008. FILED 6-5-2008.
- 3,567,057. **TIDEPOL CRUISER (BLOCK FORM)**. WINDOWS-ON-OUR-WATERS, (U.S. CLS. 100, 101 AND 107). SN 77-492,365. PUB. 11-11-2008. FILED 6-5-2008.
- 3,567,067. **10 FITNESS AND DESIGN**. 10 FITNESS, INC., (U.S. CLS. 100, 101 AND 107). SN 77-493,164. PUB. 11-11-2008. FILED 6-6-2008.
- 3,567,075. **PANJAZZ AND DESIGN**. ABSTRACT ENTERTAINMENT INC., (U.S. CLS. 100, 101 AND 107). SN 77-493,441. PUB. 11-11-2008. FILED 6-6-2008.
- 3,567,076 (*See Class 35 for this trademark*).
- 3,567,085. **CHINA IN A BOX (BLOCK FORM)**. WORLD

- STOCK FOOTAGE LTD., (U.S. CLS. 100, 101 AND 107). SN 77-494,365. PUB. 11-11-2008. FILED 6-9-2008.
- 3,567,087. **(PULP THE PARTY) (STYLIZED)**. REPUBLIC PROMOTION CO., (U.S. CLS. 100, 101 AND 107). SN 77-494,480. PUB. 11-11-2008. FILED 6-9-2008.
- 3,567,089 (*See Class 9 for this trademark*).
- 3,567,093. **COLL-EDGE (BLOCK FORM)**. MALIA, TARA, A., (U.S. CLS. 100, 101 AND 107). SN 77-494,748. PUB. 11-11-2008. FILED 6-9-2008.
- 3,567,112. **PEER-SPECTIVES (BLOCK FORM)**. CENTER OF EXCELLENCE MEDIA, LLC, (U.S. CLS. 100, 101 AND 107). SN 77-496,472. PUB. 11-11-2008. FILED 6-11-2008.
- 3,567,116. **PEER-SPECTIVES AND DESIGN**. CENTER OF EXCELLENCE MEDIA, LLC, (U.S. CLS. 100, 101 AND 107). SN 77-496,519. PUB. 11-11-2008. FILED 6-11-2008.
- 3,567,131. **LOS SAGITARIOS DE JUCHIPILA ZACATECAS (BLOCK FORM)**. ALVAREZ OLMEDO, ANGEL, (U.S. CLS. 100, 101 AND 107). SN 77-496,772. PUB. 11-11-2008. FILED 6-11-2008.
- 3,567,140. **IEN CONNECTS (BLOCK FORM)**. THOMAS PUBLISHING COMPANY, (U.S. CLS. 100, 101 AND 107). SN 77-497,219. PUB. 11-11-2008. FILED 6-12-2008.
- 3,567,146. **PLATINUM REVIEW COURSES AND DESIGN**. PLATINUM REVIEW COURSES, LLC, (U.S. CLS. 100, 101 AND 107). SN 77-497,539. PUB. 11-11-2008. FILED 6-12-2008.
- 3,567,148. **BETTER BY DEFINITION (BLOCK FORM)**. HOME BOX OFFICE, INC., (U.S. CLS. 100, 101 AND 107). SN 77-497,558. PUB. 11-11-2008. FILED 6-12-2008.
- 3,567,151. **MOTOZANIA (BLOCK FORM)**. TKTV, LLC, (U.S. CLS. 100, 101 AND 107). SN 77-497,748. PUB. 11-11-2008. FILED 6-12-2008.
- 3,567,183. **BEACH WATCH (BLOCK FORM)**. ALPHA MEDIA GROUP, INC., (U.S. CLS. 100, 101 AND 107). SN 77-499,446. PUB. 11-11-2008. FILED 6-16-2008.
- 3,567,186 (*See Class 16 for this trademark*).
- 3,567,187. **BEACH WATCH AND DESIGN**. ALPHA MEDIA GROUP, INC., (U.S. CLS. 100, 101 AND 107). SN 77-499,551. PUB. 11-11-2008. FILED 6-16-2008.
- 3,567,206 (*See Class 9 for this trademark*).
- 3,567,210 (*See Class 36 for this trademark*).
- 3,567,216 (*See Class 9 for this trademark*).
- 3,567,220 (*See Class 36 for this trademark*).
- 3,567,235. **IRRITATING JULIE (BLOCK FORM)**. DUCHESNEAU, JULIE N., AND DUCHESNEAU, SCOTT W., (U.S. CLS. 100, 101 AND 107). SN 77-500,379. PUB. 11-11-2008. FILED 6-17-2008.
- 3,567,244. **PHOXXIE (BLOCK FORM)**. PHOXXIE LLC, (U.S. CLS. 100, 101 AND 107). SN 77-500,523. PUB. 11-11-2008. FILED 6-17-2008.
- 3,567,248. **BODIES IN BALANCE SEATTLE STABILIZATION STRENGTH POWER AND DESIGN**. BODIES IN BALANCE SEATTLE, LLC, (U.S. CLS. 100, 101 AND 107). SN 77-500,551. PUB. 11-11-2008. FILED 6-17-2008.
- 3,567,253. **KARMIC MANAGEMENT (BLOCK FORM)**. KARMIC MANAGEMENT, LLC, (U.S. CLS. 100, 101 AND 107). SN 77-500,690. PUB. 11-11-2008. FILED 6-17-2008.
- 3,567,254. **FIND YOUR COURSE (BLOCK FORM)**. CENTRAL NEW MEXICO COMMUNITY COLLEGE, (U.S. CLS. 100, 101 AND 107). SN 77-500,696. PUB. 11-11-2008. FILED 6-17-2008.
- 3,567,274. **ONE MISSION (BLOCK FORM)**. PUBLISHING HOUSE OF THE EVANGELICAL LUTHERAN CHURCH IN AMERICA, (U.S. CLS. 100, 101 AND 107). SN 77-500,939. PUB. 11-11-2008. FILED 6-17-2008.
- 3,567,283. **ESA (BLOCK FORM)**. ELITE SA LLC, (U.S. CLS. 100, 101 AND 107). SN 77-501,075. PUB. 11-11-2008. FILED 6-17-2008.
- 3,567,288. **LSAPP (BLOCK FORM)**. HARRISON, SHELTON E., (U.S. CLS. 100, 101 AND 107). SN 77-501,220. PUB. 11-11-2008. FILED 6-17-2008.
- 3,567,298. **CODESTOCK AND DESIGN**. EAST TENNESSEE .NET USERS GROUP, INC, (U.S. CLS. 100, 101 AND 107). SN 77-501,299. PUB. 11-11-2008. FILED 6-17-2008.
- 3,567,301. **MOMOCRATS (BLOCK FORM)**. CAMPBELL, GLENNIA R., AND BUTLER, STEFANIA P., (U.S. CLS. 100, 101 AND 107). SN 77-501,307. PUB. 11-11-2008. FILED 6-17-2008.
- 3,567,306. **THE OPEN FEEL (BLOCK FORM)**. HARRIS, KATHERINE A., AND BRAYTON, THOMAS F., (U.S. CLS. 100, 101 AND 107). SN 77-501,364. PUB. 11-11-2008. FILED 6-18-2008.
- 3,567,311 (*See Class 38 for this trademark*).
- 3,567,314 (*See Class 36 for this trademark*).
- 3,567,317 (*See Class 36 for this trademark*).
- 3,567,320. **DIGITAL KITTEN AND DESIGN**. MARES, THOMAS, (U.S. CLS. 100, 101 AND 107). SN 77-501,623. PUB. 11-11-2008. FILED 6-18-2008.
- 3,567,333. **MASTER MARINERS (BLOCK FORM)**. MASTER MARINERS BENEVOLENT ASSOCIATION, DBA MASTER MARINERS OF SAN FRANCISCO BAY, (U.S. CLS. 100, 101 AND 107). SN 77-501,852. PUB. 11-11-2008. FILED 6-18-2008.
- 3,567,336. **HIGHLAND RUGBY (BLOCK FORM)**. GELWIX, DAVID LARRY, (U.S. CLS. 100, 101 AND 107). SN 77-501,869. PUB. 11-11-2008. FILED 6-18-2008.
- 3,567,338 (*See Class 9 for this trademark*).
- 3,567,342. **THE POLISHED PALATE (BLOCK FORM)**. THE POLISHED PALATE, LLC, (U.S. CLS. 100, 101 AND 107). SN 77-501,953. PUB. 11-11-2008. FILED 6-18-2008.
- 3,567,345. **THE POLISHED PALATE INTERNATIONAL RUM FESTIVAL (BLOCK FORM)**. THE POLISHED PALATE, LLC, (U.S. CLS. 100, 101 AND 107). SN 77-501,973. PUB. 11-11-2008. FILED 6-18-2008.
- 3,567,361 (*See Class 35 for this trademark*).
- 3,567,368. **FACT VS FEAR (BLOCK FORM)**. FOX NEWS NETWORK, LLC, (U.S. CLS. 100, 101 AND 107). SN 77-502,328. PUB. 11-11-2008. FILED 6-18-2008.
- 3,567,370. **THE COEUR D'ALENE GOLF & SPA RESORT AND DESIGN**. HAGADONE HOSPITALITY CO., (U.S. CLS. 100, 101 AND 107). SN 77-502,349. PUB. 11-11-2008. FILED 6-18-2008.
- 3,567,382. **PIRACY AGE AND DESIGN**. INOVA INTERACTIVE SARL, (U.S. CLS. 100, 101 AND 107). SN 77-502,513. PUB. 11-11-2008. FILED 6-19-2008.
- 3,567,387. **ONTHEMARC (BLOCK FORM)**. ON THE MARC EVENTS, LLC, (U.S. CLS. 100, 101 AND 107). SN 77-502,630. PUB. 11-11-2008. FILED 6-19-2008.
- 3,567,399. **WORKFORCE CHEMISTRY (BLOCK FORM)**. WORKFORCE CHEMISTRY, INC., (U.S. CLS. 100, 101 AND 107). SN 77-502,808. PUB. 11-11-2008. FILED 6-19-2008.
- 3,567,406. **BIG PRIME DA GENERAL AND DESIGN**. MAN POWER MUSIC GROUP, LLC, (U.S. CLS. 100, 101 AND 107). SN 77-502,880. PUB. 11-11-2008. FILED 6-19-2008.
- 3,567,423 (*See Class 35 for this trademark*).
- 3,567,435. **GET OUT. GET DIRTY. GET FIT. (BLOCK FORM)**. GEORGIA DEPARTMENT OF NATURAL RESOURCES, (U.S. CLS. 100, 101 AND 107). SN 77-503,420. PUB. 11-11-2008. FILED 6-19-2008.
- 3,567,450. **FRINGE CITY (BLOCK FORM)**. GLOBAL WONDER ENTERTAINMENT, INC., DBA TOONED IN, MULTIPLE CLASS, (INT. CLS. 41, 42 AND 45), (U.S. CLS. 100, 101 AND 107). SN 77-503,669. PUB. 11-11-2008. FILED 6-20-2008.
- 3,567,451. **ANNA IVEY (BLOCK FORM)**. SAVVY GRAD LLC, (U.S. CLS. 100, 101 AND 107). SN 77-503,704. PUB. 11-11-2008. FILED 6-20-2008.
- 3,567,453. **ANNA IVEY CONSULTING (BLOCK FORM)**. SAVVY GRAD LLC, (U.S. CLS. 100, 101 AND 107). SN 77-503,712. PUB. 11-11-2008. FILED 6-20-2008.
- 3,567,454. **THE IVEY FILES (BLOCK FORM)**. SAVVY GRAD LLC, (U.S. CLS. 100, 101 AND 107). SN 77-503,719. PUB. 11-11-2008. FILED 6-20-2008.
- 3,567,457 (*See Class 35 for this trademark*).
- 3,567,463. **VIEWWORKS (BLOCK FORM)**. VIEWWORKS MEDIA, LLC., (U.S. CLS. 100, 101 AND 107). SN 77-504,094. PUB. 11-11-2008. FILED 6-20-2008.
- 3,567,474. **APPOINT HER (BLOCK FORM)**. WOMEN'S CAMPAIGN FORUM FOUNDATION, (U.S. CLS. 100, 101 AND 107). SN 77-504,298. PUB. 11-11-2008. FILED 6-20-2008.
- 3,567,495. **6MM AND DESIGN**. SOUTH CAROLINA EDUCATION LOTTERY COMMISSION, (U.S. CLS. 100, 101 AND 107). SN 77-504,833. PUB. 11-11-2008. FILED 6-21-2008.
- 3,567,500. **EXTRA HELPING (BLOCK FORM)**. EXTRA HELPING, LLC, (U.S. CLS. 100, 101 AND 107). SN 77-504,844. PUB. 11-11-2008. FILED 6-21-2008.
- 3,567,509 (*See Class 16 for this trademark*).

- 3,567,522. **WYLD STYLE (BLOCK FORM)**. WYLD STYLE LLC, (U.S. CLS. 100, 101 AND 107). SN 77-505,358. PUB. 11-11-2008. FILED 6-23-2008.
- 3,567,534. **V AND DESIGN**. GYRO ADVERTISING, INC., DBA GYRO WORLDWIDE, (U.S. CLS. 100, 101 AND 107). SN 77-505,538. PUB. 11-11-2008. FILED 6-23-2008.
- 3,567,544 (*See Class 35 for this trademark*).
- 3,567,557. **TONY 2FACE (BLOCK FORM)**. BENETIZ, ANTONIO, (U.S. CLS. 100, 101 AND 107). SN 77-506,049. PUB. 11-11-2008. FILED 6-24-2008.
- 3,567,562. **HOCKEY BARN (BLOCK FORM)**. INTERACTIVE SPORTS NETWORK, LLC, (U.S. CLS. 100, 101 AND 107). SN 77-506,228. PUB. 11-11-2008. FILED 6-24-2008.
- 3,567,566. **MEDIA-CATION (BLOCK FORM)**. THE MEDIATION FOUNDATION, (U.S. CLS. 100, 101 AND 107). SN 77-506,354. PUB. 11-11-2008. FILED 6-24-2008.
- 3,567,570. **BUILDINGENERGY (BLOCK FORM)**. NORTHEAST SUSTAINABLE ENERGY ASSOCIATION, INC., DBA NESEA, (U.S. CLS. 100, 101 AND 107). SN 77-506,452. PUB. 11-11-2008. FILED 6-24-2008.
- 3,567,574. **INVESTVEST (BLOCK FORM)**. BNK INVEST, INC., (U.S. CLS. 100, 101 AND 107). SN 77-506,614. PUB. 11-11-2008. FILED 6-24-2008.
- 3,567,583. **INTERESTING CARS MEET IRRATIONAL EMOTION (BLOCK FORM)**. AMAZON TECHNOLOGIES, INC., (U.S. CLS. 100, 101 AND 107). SN 77-506,793. PUB. 11-11-2008. FILED 6-24-2008.
- 3,567,585. **CHORDSTRIKE (BLOCK FORM)**. AMAZON TECHNOLOGIES, INC., (U.S. CLS. 100, 101 AND 107). SN 77-506,813. PUB. 11-11-2008. FILED 6-24-2008.
- 3,567,586. **A MINOR BLOG FOR MAJOR MUSIC LOVERS (BLOCK FORM)**. AMAZON TECHNOLOGIES, INC., (U.S. CLS. 100, 101 AND 107). SN 77-506,815. PUB. 11-11-2008. FILED 6-24-2008.
- 3,567,587. **END USER (BLOCK FORM)**. AMAZON TECHNOLOGIES, INC., (U.S. CLS. 100, 101 AND 107). SN 77-506,822. PUB. 11-11-2008. FILED 6-24-2008.
- 3,567,589. **WE READ THE MANUALS (BLOCK FORM)**. AMAZON TECHNOLOGIES, INC., (U.S. CLS. 100, 101 AND 107). SN 77-506,824. PUB. 11-11-2008. FILED 6-24-2008.
- 3,567,590. **SIT, WATCH, DISCUSS (BLOCK FORM)**. AMAZON TECHNOLOGIES, INC., (U.S. CLS. 100, 101 AND 107). SN 77-506,843. PUB. 11-11-2008. FILED 6-24-2008.
- 3,567,591. **MAKE YOU SMILE (BLOCK FORM)**. GONZALEZ, NIEVES IV, DBA MAKE YOU SMILE PHOTOGRAPHY, (U.S. CLS. 100, 101 AND 107). SN 77-506,853. PUB. 11-11-2008. FILED 6-24-2008.
- 3,567,601. **COP WHISPERER (BLOCK FORM)**. LANSING, KAREN, (U.S. CLS. 100, 101 AND 107). SN 77-507,080. PUB. 11-11-2008. FILED 6-24-2008.
- 3,567,607. **HANDS TO HEARTS (BLOCK FORM)**. HANDS TO HEARTS INTERNATIONAL, (U.S. CLS. 100, 101 AND 107). SN 77-507,246. PUB. 11-11-2008. FILED 6-24-2008.
- 3,567,616. **XTEND A COMPLETE BODY WORKOUT (STYLIZED)**. XTEND WORKOUT, (U.S. CLS. 100, 101 AND 107). SN 77-507,695. PUB. 11-11-2008. FILED 6-25-2008.
- 3,567,619. **MYSWINGONLINE (BLOCK FORM)**. MYSWINGONLINE LLC, (U.S. CLS. 100, 101 AND 107). SN 77-508,382. PUB. 11-11-2008. FILED 6-25-2008.
- 3,567,630. **LIVERPOOL DREAMS (BLOCK FORM)**. TRADE-NAME NETWORK, INC., (U.S. CLS. 100, 101 AND 107). SN 77-510,574. PUB. 11-11-2008. FILED 6-28-2008.
- 3,567,646. **AVT EVENT TECHNOLOGIES AND DESIGN**. HOSPITALITY PARTNERS, LLC, (U.S. CLS. 100, 101 AND 107). SN 77-513,702. PUB. 11-11-2008. FILED 7-2-2008.
- 3,567,653. **UCA AND DESIGN**. VARSITY SPIRIT CORPORATION, (U.S. CLS. 100, 101 AND 107). SN 77-517,139. PUB. 11-11-2008. FILED 7-8-2008.
- 3,567,658 (*See Class 25 for this trademark*).
- 3,567,678. **FASHION RULES (BLOCK FORM)**. MALDONADO, MARGARET, (U.S. CLS. 100, 101 AND 107). SN 77-524,599. PUB. 11-11-2008. FILED 7-17-2008.
- 3,567,692. **CEO (BLOCK FORM)**. CHIEF EXECUTIVES ORGANIZATION, INC., (U.S. CLS. 100, 101 AND 107). SN 77-529,909. PUB. 11-11-2008. FILED 7-23-2008.
- 3,567,707 (*See Class 9 for this trademark*).
- 3,567,711. **BABYFIRST (BLOCK FORM)**. BFTV, LLC, (U.S. CLS. 100, 101 AND 107). SN 77-539,871. PUB. 11-11-2008. FILED 8-5-2008.
- 3,567,741. **S SPIRITS NIGHT CLUB AND DESIGN**. SEMINOLE NIGHT CLUB, LLC, (U.S. CLS. 100, 101 AND 107). SN 78-598,482. PUB. 11-11-2008. FILED 3-30-2005.
- 3,567,743. **LOS ASTROS DE DURANGO (BLOCK FORM)**. RIOS, FRANCISCO, (U.S. CLS. 100, 101 AND 107). SN 78-627,560. PUB. 6-19-2007. FILED 5-11-2005.
- 3,567,745 (*See Class 9 for this trademark*).
- 3,567,752 (*See Class 16 for this trademark*).
- 3,567,753. **MEET YOUR MATCH (BLOCK FORM)**. AMERICAN SOCIETY FOR THE PREVENTION OF CRUELTY TO ANIMALS, THE, MULTIPLE CLASS, (INT. CLS. 41 AND 45), (U.S. CLS. 100, 101 AND 107). SN 78-765,726. PUB. 11-11-2008. FILED 12-2-2005.
- 3,567,773 (*See Class 35 for this trademark*).
- 3,567,795 (*See Class 39 for this trademark*).
- 3,567,803. **BODY CLOCK CORRECTION 3.00 - 5.00AM LUNG 5.00 - 7.00AM LARGE INTESTINE 7.00 - 9.00AM STOMACH 9.00 - 11.00AM SPLEEN 11.00AM - 1.00PM HEART 1.00 - 3.00PM LIVER AND DESIGN**. DESTINY HEALTH SERVICES PTY LTD, (U.S. CLS. 100, 101 AND 107). SN 79-023,751. PUB. 11-11-2008. FILED 4-7-2006.
- 3,567,814 (*See Class 1 for this trademark*).
- 3,567,815 (*See Class 9 for this trademark*).
- 3,567,824 (*See Class 35 for this trademark*).
- 3,567,829 (*See Class 9 for this trademark*).
- 3,567,833 (*See Class 16 for this trademark*).
- 3,567,840 (*See Class 35 for this trademark*).
- 3,567,841 (*See Class 35 for this trademark*).
- 3,567,875. **APPLICA (BLOCK FORM)**. APPLICA GMBH ANGEWANDTE; CHEMISCHE ANALYTIK, MULTIPLE CLASS, (INT. CLS. 41, 42 AND 44), (U.S. CLS. 100, 101 AND 107). SN 79-047,261. PUB. 11-11-2008. FILED 10-24-2007.
- 3,567,880 (*See Class 9 for this trademark*).
- 3,567,892 (*See Class 9 for this trademark*).
- 3,567,916 (*See Class 9 for this trademark*).
- 3,567,939. **EATALY (BLOCK FORM)**. EATALY SRL, AND EATALY DISTRIBUZIONE SRL, (U.S. CLS. 100, 101 AND 107). SN 79-051,465. PUB. 11-11-2008. FILED 1-16-2008.

CLASS 42—SCIENTIFIC AND COMPUTER SERVICES

- 3,566,263. **PRISMSOFT PROBLEM SOLVED! AND DESIGN**. PRISMSOFT, (U.S. CLS. 100 AND 101). SN 76-523,128. PUB. 11-11-2008. FILED 6-16-2003.
- 3,566,264 (*See Class 9 for this trademark*).
- 3,566,267 (*See Class 9 for this trademark*).
- 3,566,268 (*See Class 9 for this trademark*).
- 3,566,283 (*See Class 38 for this trademark*).
- 3,566,293 (*See Class 35 for this trademark*).
- 3,566,314. **SEARCH EGO OPTIMIZATION (STYLIZED)**. THE JAR GROUP, INC., (U.S. CLS. 100 AND 101). SN 76-687,325. PUB. 11-11-2008. FILED 2-29-2008.
- 3,566,315 (*See Class 41 for this trademark*).
- 3,566,337. **VEEDA ONCOLOGY (BLOCK FORM)**. VEEDA CLINICAL RESEARCH, INC., (U.S. CLS. 100 AND 101). SN 76-690,148. PUB. 11-11-2008. FILED 5-30-2008.
- 3,566,362 (*See Class 35 for this trademark*).
- 3,566,371 (*See Class 9 for this trademark*).
- 3,566,396 (*See Class 9 for this trademark*).
- 3,566,398 (*See Class 16 for this trademark*).
- 3,566,399. **CONNECTUS (BLOCK FORM)**. ADN MEDIA, LLC., (U.S. CLS. 100 AND 101). SN 77-071,125. PUB. 11-11-2008. FILED 12-25-2006.
- 3,566,400 (*See Class 7 for this trademark*).
- 3,566,433 (*See Class 35 for this trademark*).
- 3,566,434 (*See Class 1 for this trademark*).
- 3,566,435 (*See Class 7 for this trademark*).
- 3,566,455 (*See Class 9 for this trademark*).
- 3,566,465 (*See Class 1 for this trademark*).
- 3,566,480 (*See Class 35 for this trademark*).
- 3,566,509 (*See Class 9 for this trademark*).
- 3,566,524. **GREENPOINT RATED (BLOCK FORM)**. BUILD IT GREEN, INC., (U.S. CLS. 100 AND 101). SN 77-259,978. PUB. 11-11-2008. FILED 8-20-2007.

- 3,566,534 (*See Class 37 for this trademark.*)
 3,566,558. **SITEPEN (BLOCK FORM)**. SITEPEN, INC., (U.S. CLS. 100 AND 101). SN 77-291,009. PUB. 11-11-2008. FILED 9-27-2007.
 3,566,569 (*See Class 7 for this trademark.*)
 3,566,579 (*See Class 35 for this trademark.*)
 3,566,585. **BLUESOURCE (BLOCK FORM)**. BLUE COAT SYSTEMS, INC., (U.S. CLS. 100 AND 101). SN 77-317,064. PUB. 11-11-2008. FILED 10-30-2007.
 3,566,594 (*See Class 35 for this trademark.*)
 3,566,621 (*See Class 35 for this trademark.*)
 3,566,635. **WEBART (BLOCK FORM)**. BUSINESSVOICE, INC., (U.S. CLS. 100 AND 101). SN 77-335,530. PUB. 11-11-2008. FILED 11-21-2007.
 3,566,636 (*See Class 35 for this trademark.*)
 3,566,637 (*See Class 1 for this trademark.*)
 3,566,649 (*See Class 41 for this trademark.*)
 3,566,660 (*See Class 20 for this trademark.*)
 3,566,688 (*See Class 35 for this trademark.*)
 3,566,693 (*See Class 41 for this trademark.*)
 3,566,698. **ONE ELEVEN INTERACTIVE (BLOCK FORM)**. ONE ELEVEN INTERACTIVE, INC., (U.S. CLS. 100 AND 101). SN 77-352,860. PUB. 11-11-2008. FILED 12-14-2007.
 3,566,712. **IA INSITE ARCHITECTURE INC AND DESIGN**. INSITE ARCHITECTURE, INC., (U.S. CLS. 100 AND 101). SN 77-356,974. PUB. 11-11-2008. FILED 12-20-2007.
 3,566,715 (*See Class 35 for this trademark.*)
 3,566,718 (*See Class 41 for this trademark.*)
 3,566,745. **ULTRAGOLD (BLOCK FORM)**. ULTRA SCIENTIFIC, INCORPORATED, (U.S. CLS. 100 AND 101). SN 77-368,209. PUB. 11-11-2008. FILED 1-10-2008.
 3,566,753 (*See Class 35 for this trademark.*)
 3,566,760 (*See Class 9 for this trademark.*)
 3,566,852. **GTEL NETWORKS, INC. "A VERY DIFFERENT IT FIRM" AND DESIGN**. GTEL NETWORKS, INC., (U.S. CLS. 100 AND 101). SN 77-441,361. PUB. 11-11-2008. FILED 4-7-2008.
 3,566,906. **MARKEY AND DESIGN**. MARKEY MACHINERY COMPANY, INC., (U.S. CLS. 100 AND 101). SN 77-463,543. PUB. 11-11-2008. FILED 5-1-2008.
 3,566,907 (*See Class 35 for this trademark.*)
 3,566,917. **MISCELLANEOUS DESIGN**. WMS SOLUTIONS, INC., DBA INTERLINK TECHNOLOGIES, (U.S. CLS. 100 AND 101). SN 77-467,982. PUB. 11-11-2008. FILED 5-7-2008.
 3,566,925. **HEALTHCARE DISCOVERIES AND DESIGN**. HEALTHCARE DISCOVERIES, DBA ICON DEVELOPMENT SOLUTIONS, (U.S. CLS. 100 AND 101). SN 77-470,129. PUB. 11-11-2008. FILED 5-9-2008.
 3,566,935 (*See Class 9 for this trademark.*)
 3,566,958. **SHYFTR (BLOCK FORM)**. UPSHOT INTERACTIVE, INC., (U.S. CLS. 100 AND 101). SN 77-480,385. PUB. 11-11-2008. FILED 5-21-2008.
 3,566,960. **SHYFTR AND DESIGN**. UPSHOT INTERACTIVE, INC., (U.S. CLS. 100 AND 101). SN 77-480,412. PUB. 11-11-2008. FILED 5-21-2008.
 3,566,989. **THREE RINGS (BLOCK FORM)**. THREE RINGS DESIGN, INC., (U.S. CLS. 100 AND 101). SN 77-485,116. PUB. 11-11-2008. FILED 5-28-2008.
 3,567,002. **HIGHERGIVING (BLOCK FORM)**. WORD ENTERPRISES, LTD., DBA ELEXIO, (U.S. CLS. 100 AND 101). SN 77-486,932. PUB. 11-11-2008. FILED S.R. 5-30-2008; AM. P.R. 9-26-2008.
 3,567,014. **BANKGPS (BLOCK FORM)**. PLANSMITH CORPORATION, (U.S. CLS. 100 AND 101). SN 77-487,973. PUB. 11-11-2008. FILED 5-31-2008.
 3,567,025. **ELLAAR (BLOCK FORM)**. ALFORD, DAVID RANDALL, (U.S. CLS. 100 AND 101). SN 77-488,998. PUB. 11-11-2008. FILED 6-2-2008.
 3,567,043. **BIKERDIVE PRODUCTS & SERVICES AND DESIGN**. CLARK, MELANIE, DBA BD WEB BUILDERS, (U.S. CLS. 100 AND 101). SN 77-490,911. PUB. 11-11-2008. FILED 6-4-2008.
 3,567,061. **UPTIME ENGINEERING (BLOCK FORM)**. UPTIME SCIENCE CORPORATION, (U.S. CLS. 100 AND 101). SN 77-492,792. PUB. 11-11-2008. FILED 6-6-2008.
 3,567,077. **BUILD-A-DRIVER (BLOCK FORM)**. PRECIMED S.A., (U.S. CLS. 100 AND 101). SN 77-493,899. PUB. 11-11-2008. FILED 6-9-2008.
 3,567,083. **ACTIFI ROADMAP (BLOCK FORM)**. ACTIFI, INC., (U.S. CLS. 100 AND 101). SN 77-494,279. PUB. 11-11-2008. FILED 6-9-2008.
 3,567,100. **NETSAFE (BLOCK FORM)**. MYMAIL, LTD., (U.S. CLS. 100 AND 101). SN 77-495,108. PUB. 11-11-2008. FILED 6-10-2008.
 3,567,158. **PROCURE TREATMENT CENTERS AND DESIGN**. PROCURE TREATMENT CENTERS, INC., (U.S. CLS. 100 AND 101). SN 77-498,185. PUB. 11-11-2008. FILED 6-13-2008.
 3,567,180. **VOLICO (BLOCK FORM)**. BUSINESSHOSTING, INC., DBA VOLICO, (U.S. CLS. 100 AND 101). SN 77-499,395. PUB. 11-11-2008. FILED 6-16-2008.
 3,567,185. **UNEARTH YOUR AIR DITCHCARBON.COM AND DESIGN**. PROGRESSIVE ENERGY GROUP LLC, DBA PROSPECTIVE LLC, (U.S. CLS. 100 AND 101). SN 77-499,455. PUB. 11-11-2008. FILED 6-16-2008.
 3,567,186 (*See Class 16 for this trademark.*)
 3,567,198. **BLITHE BEASTIES AND DESIGN**. MCBRIDE, SUSAN, (U.S. CLS. 100 AND 101). SN 77-499,709. PUB. 11-11-2008. FILED 6-16-2008.
 3,567,208. **DESIGNERS CALL (BLOCK FORM)**. STORM INTERIORS, (U.S. CLS. 100 AND 101). SN 77-499,853. PUB. 11-11-2008. FILED 6-16-2008.
 3,567,222. **ICECRM AND DESIGN**. BELL BIZ INC., DBA COMPUTER EVOLUTION, (U.S. CLS. 100 AND 101). SN 77-500,020. PUB. 11-11-2008. FILED 6-16-2008.
 3,567,249 (*See Class 9 for this trademark.*)
 3,567,257. **LOOKBACK (BLOCK FORM)**. CHS INC., (U.S. CLS. 100 AND 101). SN 77-500,752. PUB. 11-11-2008. FILED 6-17-2008.
 3,567,286 (*See Class 35 for this trademark.*)
 3,567,321. **BIOSIGNIA TECHNOLOGY FOR LIFE AND DESIGN**. BIOSIGNIA, INC., (U.S. CLS. 100 AND 101). SN 77-501,651. PUB. 11-11-2008. FILED 6-18-2008.
 3,567,331. **ONE SPOT AND DESIGN**. LARGESMALL SYSTEMS, INC., (U.S. CLS. 100 AND 101). SN 77-501,776. PUB. 11-11-2008. FILED 6-18-2008.
 3,567,346 (*See Class 40 for this trademark.*)
 3,567,352 (*See Class 35 for this trademark.*)
 3,567,398 (*See Class 37 for this trademark.*)
 3,567,436. **KALI SYSTEMS LLC (BLOCK FORM)**. KALI SYSTEMS LLC, (U.S. CLS. 100 AND 101). SN 77-503,453. PUB. 11-11-2008. FILED 6-19-2008.
 3,567,438. **FOTOHARBOR (BLOCK FORM)**. SUNNI RAIN INC., (U.S. CLS. 100 AND 101). SN 77-503,480. PUB. 11-11-2008. FILED 6-19-2008.
 3,567,445. **ENDECE (BLOCK FORM)**. ENDECE, LLC, (U.S. CLS. 100 AND 101). SN 77-503,540. PUB. 11-11-2008. FILED 6-19-2008.
 3,567,450 (*See Class 41 for this trademark.*)
 3,567,470. **MOMTOPIA (BLOCK FORM)**. GLIMCHER REALTY TRUST, (U.S. CLS. 100 AND 101). SN 77-504,250. PUB. 11-11-2008. FILED 6-20-2008.
 3,567,504. **PUBGET (BLOCK FORM)**. PUBGET INC., (U.S. CLS. 100 AND 101). SN 77-504,910. PUB. 11-11-2008. FILED 6-22-2008.
 3,567,538. **LADCO RESORT DESIGN GROUP (BLOCK FORM)**. LADCO, LTD., (U.S. CLS. 100 AND 101). SN 77-505,682. PUB. 11-11-2008. FILED 6-23-2008.
 3,567,584. **PENCILPAD (BLOCK FORM)**. ADVANCED INSTRUCTIONAL SYSTEMS, INC., (U.S. CLS. 100 AND 101). SN 77-506,798. PUB. 11-11-2008. FILED 6-24-2008.
 3,567,629 (*See Class 35 for this trademark.*)
 3,567,640. **DESIGNED FOR RESULTS (BLOCK FORM)**. COVANCE INC., (U.S. CLS. 100 AND 101). SN 77-512,125. PUB. 11-11-2008. FILED 7-1-2008.
 3,567,644. **GET A JOB AND TAKE OVER THE WORLD (BLOCK FORM)**. BUNGIE, LLC, (U.S. CLS. 100 AND 101). SN 77-512,965. PUB. 11-11-2008. FILED 7-1-2008.
 3,567,647. **MANAGEMYSBAM (BLOCK FORM)**. SYNCHRONET INDUSTRIES, INC., (U.S. CLS. 100 AND 101). SN 77-514,286. PUB. 11-11-2008. FILED 7-3-2008.
 3,567,651. **TORA (BLOCK FORM)**. TORA HOLDINGS LIMITED, (U.S. CLS. 100 AND 101). SN 77-516,847. PUB. 11-11-2008. FILED 7-8-2008.
 3,567,679. **BIOSWITCH (BLOCK FORM)**. ENDECE, LLC, (U.S. CLS. 100 AND 101). SN 77-524,636. PUB. 11-11-2008. FILED 7-17-2008.

- 3,567,690. **MISCELLANEOUS DESIGN**. TORA HOLDINGS LIMITED, (U.S. CLS. 100 AND 101). SN 77-528,852. PUB. 11-11-2008. FILED 7-22-2008.
- 3,567,702. **FREEDOM WEB (BLOCK FORM)**. TECHNIGRAPHICS, INC., (U.S. CLS. 100 AND 101). SN 77-536,738. PUB. 11-11-2008. FILED 8-1-2008.
- 3,567,725 (*See Class 9 for this trademark*).
- 3,567,730 (*See Class 9 for this trademark*).
- 3,567,742 (*See Class 9 for this trademark*).
- 3,567,744. **NEWGATOR (BLOCK FORM)**. NEWGATOR TECHNOLOGIES, INC., (U.S. CLS. 100 AND 101). SN 78-633,112. PUB. 11-11-2008. FILED 5-19-2005.
- 3,567,773 (*See Class 35 for this trademark*).
- 3,567,794 (*See Class 36 for this trademark*).
- 3,567,807 (*See Class 7 for this trademark*).
- 3,567,810 (*See Class 7 for this trademark*).
- 3,567,814 (*See Class 1 for this trademark*).
- 3,567,816 (*See Class 9 for this trademark*).
- 3,567,820 (*See Class 6 for this trademark*).
- 3,567,826 (*See Class 9 for this trademark*).
- 3,567,827 (*See Class 5 for this trademark*).
- 3,567,839 (*See Class 7 for this trademark*).
- 3,567,843 (*See Class 5 for this trademark*).
- 3,567,850 (*See Class 4 for this trademark*).
- 3,567,868 (*See Class 9 for this trademark*).
- 3,567,870 (*See Class 9 for this trademark*).
- 3,567,872 (*See Class 9 for this trademark*).
- 3,567,875 (*See Class 41 for this trademark*).
- 3,567,877 (*See Class 1 for this trademark*).
- 3,567,880 (*See Class 9 for this trademark*).
- 3,567,885 (*See Class 24 for this trademark*).
- 3,567,900 (*See Class 9 for this trademark*).
- 3,567,916 (*See Class 9 for this trademark*).
- 3,567,917 (*See Class 9 for this trademark*).
- 3,567,924 (*See Class 35 for this trademark*).
- 3,567,933 (*See Class 1 for this trademark*).
- 3,567,934 (*See Class 1 for this trademark*).
- 3,567,935 (*See Class 1 for this trademark*).
- 3,567,936 (*See Class 1 for this trademark*).
- 3,567,941 (*See Class 9 for this trademark*).
- 3,567,946. **WISOLUTION (STYLIZED)**. WISOLUTION LTD., (U.S. CLS. 100 AND 101). SN 79-052,129. PUB. 11-11-2008. FILED 1-10-2008.
- 3,567,950 (*See Class 35 for this trademark*).
- 3,567,982. **J-DESSERT (BLOCK FORM)**. ASSOCIATIONS FOR ESTABLISHMENT; OF EVIDENCE IN INTERVENTIONS, (U.S. CLS. 100 AND 101). SN 79-056,820. PUB. 11-11-2008. FILED 6-13-2008.
-
- CLASS 43—HOTEL AND RESTAURANT SERVICES**
- 3,566,277 (*See Class 35 for this trademark*).
- 3,566,289. **CAKES-N-CREAMS FOR THE SWEETEST TIME OF YOUR LIFE! (BLOCK FORM)**. MOORE, JOHN AUSTIN, AND MOORE, CRISTINA SUSANNA, (U.S. CLS. 100 AND 101). SN 76-682,683. PUB. 11-11-2008. FILED 10-5-2007.
- 3,566,329. **KIP'S AUTHENTIC IRISH PUB AND RESTAURANT EST. 2005 AND DESIGN**. GSH MPLS FULL SERVICE, L.L.C., (U.S. CLS. 100 AND 101). SN 76-688,871. PUB. 11-11-2008. FILED 4-22-2008.
- 3,566,340. **REAL CAJUN! REAL GOOD! (BLOCK FORM)**. CRAWFISH TOWN U.S.A., INC., (U.S. CLS. 100 AND 101). SN 76-690,278. PUB. 11-11-2008. FILED 6-5-2008.
- 3,566,347. **PASSION YOU CAN TASTE (BLOCK FORM)**. PROSTAR SERVICES, INC, (U.S. CLS. 100 AND 101). SN 76-690,371. PUB. 11-11-2008. FILED 6-9-2008.
- 3,566,394 (*See Class 39 for this trademark*).
- 3,566,461 (*See Class 35 for this trademark*).
- 3,566,525. **BAYOU CITY WINGS (BLOCK FORM)**. TEN LBS LTD., DBA BAYOU CITY WINGS, (U.S. CLS. 100 AND 101). SN 77-260,194. PUB. 11-11-2008. FILED 8-21-2007.
- 3,566,532. **TOKYO DINING AND DESIGN**. MITSUKOSHI (U.S.A.), INC., (U.S. CLS. 100 AND 101). SN 77-264,885. PUB. 11-11-2008. FILED 8-27-2007.
- 3,566,606. **MONDONGO'S RESTAURANTE (BLOCK FORM)**. OCTAVIO VELASQUEZ, JOSE, (U.S. CLS. 100 AND 101). SN 77-325,760. PUB. 11-11-2008. FILED 11-9-2007.
- 3,566,654 (*See Class 41 for this trademark*).
- 3,566,675 (*See Class 29 for this trademark*).
- 3,566,685 (*See Class 41 for this trademark*).
- 3,566,694. **MY HUMBLE HOUSE (BLOCK FORM)**. TUNG LOK MILLENNIUM PTE LTD, (U.S. CLS. 100 AND 101). SN 77-351,814. PUB. 11-11-2008. FILED 12-13-2007.
- 3,566,704. **VIVANTY'S (BLOCK FORM)**. VIVANTY FOODS INC., (U.S. CLS. 100 AND 101). SN 77-354,348. PUB. 11-11-2008. FILED 12-18-2007.
- 3,566,706. **SMARTWORLD COFFEE AND DESIGN**. WALTERS, DAVID, C, (U.S. CLS. 100 AND 101). SN 77-355,311. PUB. 11-11-2008. FILED 12-19-2007.
- 3,566,717 (*See Class 36 for this trademark*).
- 3,566,789. **BIG NIGHT OUT (BLOCK FORM)**. THE MELTING POT RESTAURANTS, INC., (U.S. CLS. 100 AND 101). SN 77-397,211. PUB. 11-11-2008. FILED 2-14-2008.
- 3,566,790. **SUSHI DO (BLOCK FORM)**. TRUE WORLD HOLDINGS LLC, (U.S. CLS. 100 AND 101). SN 77-399,651. PUB. 11-11-2008. FILED 2-18-2008.
- 3,566,824 (*See Class 39 for this trademark*).
- 3,566,834. **CLOCKWORK LEARNING CENTERS AND DESIGN**. CLOCKWORK LEARNING CENTERS MANAGEMENT COMPANY, INC., (U.S. CLS. 100 AND 101). SN 77-430,997. PUB. 11-11-2008. FILED 3-25-2008.
- 3,566,835. **CLOCKWORK LEARNING CENTERS (BLOCK FORM)**. CLOCKWORK LEARNING CENTERS MANAGEMENT COMPANY, INC., (U.S. CLS. 100 AND 101). SN 77-431,008. PUB. 11-11-2008. FILED 3-25-2008.
- 3,566,904. **B.B. KING'S CAFE (BLOCK FORM)**. KINGSID VENTURES, LTD., (U.S. CLS. 100 AND 101). SN 77-463,150. PUB. 11-11-2008. FILED 5-1-2008.
- 3,566,932. **OCEAN REEF CLUB (BLOCK FORM)**. OCEAN REEF CLUB INC., (U.S. CLS. 100 AND 101). SN 77-471,821. PUB. 11-11-2008. FILED 5-12-2008.
- 3,566,943. **TIMBER CREEK GRILL BUFFET AND DESIGN**. TIMBER CREEK BUFFET LLC, (U.S. CLS. 100 AND 101). SN 77-475,715. PUB. 11-11-2008. FILED 5-15-2008.
- 3,566,996 (*See Class 25 for this trademark*).
- 3,567,033 (*See Class 35 for this trademark*).
- 3,567,044. **24/7 AND DESIGN**. WANNA GET FRESH RESTAURANTS LLC, (U.S. CLS. 100 AND 101). SN 77-491,167. PUB. 11-11-2008. FILED 6-4-2008.
- 3,567,063. **LEVANTATE CON EL PIE DERECHO (BLOCK FORM)**. LA QUINTA WORLDWIDE, LLC, (U.S. CLS. 100 AND 101). SN 77-492,943. PUB. 11-11-2008. FILED 6-6-2008.
- 3,567,064 (*See Class 25 for this trademark*).
- 3,567,069 (*See Class 25 for this trademark*).
- 3,567,088. **TORTILLA UNIVERSITY (BLOCK FORM)**. MCCARNEY, KEVIN, DBA POQUITO MAS, (U.S. CLS. 100 AND 101). SN 77-494,487. PUB. 11-11-2008. FILED 6-9-2008.
- 3,567,120. **QUALITY IS EVERYTHING (BLOCK FORM)**. MIGHTY FINE BURGERS FRIES SHAKES, (U.S. CLS. 100 AND 101). SN 77-496,572. PUB. 11-11-2008. FILED 6-11-2008.
- 3,567,124. **MERCURYS COFFEE CO. AND DESIGN**. MERCURY MADNESS, INC., (U.S. CLS. 100 AND 101). SN 77-496,646. PUB. 11-11-2008. FILED 6-11-2008.
- 3,567,127. **MERCURYS COFFEE CO. AND DESIGN**. MERCURY MADNESS, INC., (U.S. CLS. 100 AND 101). SN 77-496,722. PUB. 11-11-2008. FILED 6-11-2008.
- 3,567,128. **MERCURYS COFFEE CO. (STYLIZED)**. MERCURY MADNESS, INC., (U.S. CLS. 100 AND 101). SN 77-496,739. PUB. 11-11-2008. FILED 6-11-2008.
- 3,567,130. **MISCELLANEOUS DESIGN**. MERCURY MADNESS, INC., (U.S. CLS. 100 AND 101). SN 77-496,770. PUB. 11-11-2008. FILED 6-11-2008.
- 3,567,132 (*See Class 35 for this trademark*).
- 3,567,153. **TORTILLA U (BLOCK FORM)**. KEVIN MCCARNEY, DBA POQUITO MAS, (U.S. CLS. 100 AND 101). SN 77-497,923. PUB. 11-11-2008. FILED 6-12-2008.
- 3,567,214. **CINZETTI'S ALL YOU CAN EAT ITALIAN FEAST AND DESIGN**. CINZZETTI'S RESTAURANT CORP., (U.S. CLS. 100 AND 101). SN 77-499,939. PUB. 11-11-2008. FILED 6-16-2008.
- 3,567,219. **ASSISTED LIVING WITH AN INDEPENDENT**

- SPIRIT (BLOCK FORM)**, MENORAH MANOR, INC., MULTIPLE CLASS, (INT. CLS. 43 AND 44), (U.S. CLS. 100 AND 101). SN 77-499,983. PUB. 11-11-2008. FILED 6-16-2008.
- 3,567,232. **CIMINO CARE AND DESIGN**, CIMINOCARE, MULTIPLE CLASS, (INT. CLS. 43 AND 45), (U.S. CLS. 100 AND 101). SN 77-500,316. PUB. 11-11-2008. FILED 6-16-2008.
- 3,567,300. **DELFINA (BLOCK FORM)**, DEFLINA RESTAURANT, INC., (U.S. CLS. 100 AND 101). SN 77-501,302. PUB. 11-11-2008. FILED 6-17-2008.
- 3,567,341. **LULU'S COMBOS (BLOCK FORM)**, MI CHULA'S CORPORATION, (U.S. CLS. 100 AND 101). SN 77-501,911. PUB. 11-11-2008. FILED 6-18-2008.
- 3,567,347. **THE MONK'S KETTLE (BLOCK FORM)**, PATCH EDWARD, LLC, (U.S. CLS. 100 AND 101). SN 77-502,022. PUB. 11-11-2008. FILED 6-18-2008.
- 3,567,383. **TO GO AND DESIGN**, FAMOUS DAVE'S OF AMERICA, INC., (U.S. CLS. 100 AND 101). SN 77-502,544. PUB. 11-11-2008. FILED 6-19-2008.
- 3,567,480 (*See Class 35 for this trademark*).
- 3,567,485. **GINGERSNAP (BLOCK FORM)**, WILD GINGER ASIAN RESTAURANT, (U.S. CLS. 100 AND 101). SN 77-504,610. PUB. 11-11-2008. FILED 6-20-2008.
- 3,567,530. **RU YI AUTHENTIC ASIAN CUISINE AND DESIGN**, FOREST COUNTY POTAWATOMI COMMUNITY, DBA POTAWATOMI BINGO CASINO, (U.S. CLS. 100 AND 101). SN 77-505,435. PUB. 11-11-2008. FILED 6-23-2008.
- 3,567,550 (*See Class 35 for this trademark*).
- 3,567,638. **FAST FINE (BLOCK FORM)**, W & M CAFE, INC., DBA D/B/A PRESS 101, (U.S. CLS. 100 AND 101). SN 77-511,446. PUB. 11-11-2008. FILED 6-30-2008.
- 3,567,736. **CHICK-N-JOY (BLOCK FORM)**, CHICK-N-JOY SYSTEMS LIMITED, (U.S. CLS. 100 AND 101). SN 78-508,997. PUB. 10-4-2005. FILED 11-1-2004.
- 3,567,748. **PIZZA MEETS MARTINIS (BLOCK FORM)**, SMILEY, KAREN, (U.S. CLS. 100 AND 101). SN 78-691,946. PUB. 11-11-2008. FILED 8-12-2005.
- 3,567,750. **MR. LUCKY'S 24/7 AND DESIGN**, HARD ROCK HOTEL, INC., (U.S. CLS. 100 AND 101). SN 78-737,119. PUB. 7-25-2006. FILED 10-20-2005.
- 3,567,751. **MR. LUCKY'S 24/7 (BLOCK FORM)**, HARD ROCK HOTEL, INC., (U.S. CLS. 100 AND 101). SN 78-737,144. PUB. 1-23-2007. FILED 10-20-2005.
- 3,567,804. **T2GO (BLOCK FORM)**, TEA TOO PTY LTD, (U.S. CLS. 100 AND 101). SN 79-024,622. PUB. 7-24-2007. FILED 4-10-2006.
- 3,567,824 (*See Class 35 for this trademark*).
- 3,567,889. **O BAL TAN (BLOCK FORM)**, HEON YONG LEE, (U.S. CLS. 100 AND 101). SN 79-048,723. PUB. 11-11-2008. FILED 12-12-2007.
-
- CLASS 44—MEDICAL, BEAUTY AND AGRICULTURAL SERVICES**
- 3,566,271 (*See Class 9 for this trademark*).
- 3,566,278. **COMMUNITY HEALTHCARE SYSTEM AND DESIGN**, COMMUNITY FOUNDATION OF NORTHWEST INDIANA, INC., (U.S. CLS. 100 AND 101). SN 76-676,320. PUB. 11-11-2008. FILED 5-2-2007.
- 3,566,285. **SACRED BRIDGING (BLOCK FORM)**, FRASE', ANDREA, (U.S. CLS. 100 AND 101). SN 76-679,902. PUB. 11-11-2008. FILED 7-25-2007.
- 3,566,364 (*See Class 16 for this trademark*).
- 3,566,368 (*See Class 9 for this trademark*).
- 3,566,400 (*See Class 7 for this trademark*).
- 3,566,434 (*See Class 1 for this trademark*).
- 3,566,484. **CAPE ATLANTIC (BLOCK FORM)**, HOSPICOMM, INC., (U.S. CLS. 100 AND 101). SN 77-208,841. PUB. 11-11-2008. FILED 6-18-2007.
- 3,566,487 (*See Class 41 for this trademark*).
- 3,566,492. **SEEK AND DESIGN**, SEEK EDUCATION, INC., (U.S. CLS. 100 AND 101). SN 77-219,123. PUB. 11-11-2008. FILED 6-29-2007.
- 3,566,510. **ESCAPE TO SHAPE (BLOCK FORM)**, MALATES-TAS LLC, (U.S. CLS. 100 AND 101). SN 77-235,268. PUB. 11-11-2008. FILED 7-20-2007.
- 3,566,544. **...WHAT YOU NEED, WHEN YOU NEED IT. (BLOCK FORM)**, T. L. CORPORATION, (U.S. CLS. 100 AND 101). SN 77-278,970. PUB. 11-11-2008. FILED 9-13-2007.
- 3,566,549 (*See Class 41 for this trademark*).
- 3,566,560. **ANSON HIGGINS (BLOCK FORM)**, ANSON & HIGGINS PLASTIC SURGERY ASSOCIATES, LLP, (U.S. CLS. 100 AND 101). SN 77-294,390. PUB. 4-1-2008. FILED 10-2-2007.
- 3,566,629. **HEALTHY TRANSFORMATIONS (BLOCK FORM)**, ELIAS, LORENZO ALFREDO, DBA HEALTHY TRANSFORMATIONS, (U.S. CLS. 100 AND 101). SN 77-333,528. PUB. 11-11-2008. FILED 11-19-2007.
- 3,566,658. **MINI DENTAL IMPLANT CENTERS OF AMERICA AND DESIGN**, MINI DENTAL IMPLANT CENTERS OF AMERICA, INC., (U.S. CLS. 100 AND 101). SN 77-343,033. PUB. 11-11-2008. FILED 12-3-2007.
- 3,566,681. **LUCKY (BLOCK FORM)**, GATEWAY HEALTH PLAN, L.P., (U.S. CLS. 100 AND 101). SN 77-349,517. PUB. 11-11-2008. FILED 12-11-2007.
- 3,566,685 (*See Class 41 for this trademark*).
- 3,566,687. **BODY MOTION PHYSICAL THERAPY AND DESIGN**, BODY MOTION PHYSICAL THERAPY INC., DBA BODY MOTION PHYSICAL THERAPY, (U.S. CLS. 100 AND 101). SN 77-350,501. PUB. 11-11-2008. FILED 12-12-2007.
- 3,566,754. **BIOMEDWORKS (BLOCK FORM)**, KRAGIE, LAURA A, (U.S. CLS. 100 AND 101). SN 77-373,222. PUB. 11-11-2008. FILED 1-16-2008.
- 3,566,788. **MANUPRACTIC (BLOCK FORM)**, LAU, LINCOLN T., DBA INTERNATIONAL MANUPRACTIC INSTITUTE, (U.S. CLS. 100 AND 101). SN 77-396,592. PUB. 11-11-2008. FILED 2-14-2008.
- 3,566,791 (*See Class 9 for this trademark*).
- 3,566,813 (*See Class 35 for this trademark*).
- 3,566,823. **MISCELLANEOUS DESIGN**, AGAVE ENVIRONMENTAL CONTRACTING, INC., (U.S. CLS. 100 AND 101). SN 77-422,697. PUB. 11-11-2008. FILED 3-14-2008.
- 3,566,842. **GLOBAL NEURO-DIAGNOSTICS AND DESIGN**, GLOBAL NEURO-DIAGNOSTICS, LP, (U.S. CLS. 100 AND 101). SN 77-436,609. PUB. 11-11-2008. FILED 4-1-2008.
- 3,566,869 (*See Class 31 for this trademark*).
- 3,566,884. **EMPOWER HER AND DESIGN**, THE ROSE, (U.S. CLS. 100 AND 101). SN 77-453,968. PUB. 11-11-2008. FILED 4-21-2008.
- 3,566,890 (*See Class 16 for this trademark*).
- 3,566,894 (*See Class 41 for this trademark*).
- 3,566,913. **PRAIRIE GODMOTHERS (BLOCK FORM)**, PRAIRIE GODMOTHERS LLC, (U.S. CLS. 100 AND 101). SN 77-466,347. PUB. 11-11-2008. FILED 5-5-2008.
- 3,566,921. **HEARTSHAPE (BLOCK FORM)**, CARDIOVASCULAR ASSOCIATES, P.C., (U.S. CLS. 100 AND 101). SN 77-469,397. PUB. 11-11-2008. FILED 5-8-2008.
- 3,566,933. **OCEAN REEF CLUB (BLOCK FORM)**, OCEAN REEF CLUB INC., (U.S. CLS. 100 AND 101). SN 77-472,102. PUB. 11-11-2008. FILED 5-12-2008.
- 3,566,965. **R AND DESIGN**, OCEAN REEF CLUB INC., (U.S. CLS. 100 AND 101). SN 77-482,253. PUB. 11-11-2008. FILED 5-23-2008.
- 3,567,016. **ITAN SOLARIUMS AND DESIGN**, GOLD MARK, LLC, (U.S. CLS. 100 AND 101). SN 77-488,005. PUB. 11-11-2008. FILED 5-31-2008.
- 3,567,024 (*See Class 41 for this trademark*).
- 3,567,045. **VATERSPINE (BLOCK FORM)**, THOMAS L. VATER, D.O., LTD., (U.S. CLS. 100 AND 101). SN 77-491,177. PUB. 11-11-2008. FILED 6-4-2008.
- 3,567,118. **GOOD PHYSICAL THERAPY HELPING YOU REACH OPTIMAL HEALTH AND PEAK PERFORMANCE AND DESIGN**, KEITH L. GOOD, P.C., DBA GOOD PHYSICAL THERAPY, (U.S. CLS. 100 AND 101). SN 77-496,545. PUB. 11-11-2008. FILED 6-11-2008.
- 3,567,136. **GOOD CENTER OF BALANCE HELPING YOU REACH OPTIMAL HEALTH AND PEAK PERFORMANCE AND DESIGN**, KEITH L. GOOD, P.C., DBA GOOD PHYSICAL THERAPY, (U.S. CLS. 100 AND 101). SN 77-497,089. PUB. 11-11-2008. FILED 6-12-2008.
- 3,567,139. **WEIGHT LOSS KING (BLOCK FORM)**, WILSON, ANTHONY V, (U.S. CLS. 100 AND 101). SN 77-497,195. PUB. 11-11-2008. FILED 6-12-2008.
- 3,567,176. **BUBBIESITTER AND ZADIES TOO (BLOCK**

FORM). FINE, REBECCA-LYNN WEXLER, (U.S. CLS. 100 AND 101). SN 77-499,131. PUB. 11-11-2008. FILED 6-14-2008.
 3,567,205. **GREEN APPLE DENTAL AND DESIGN.** GREEN APPLE DENTAL MANAGEMENT, LLC, (U.S. CLS. 100 AND 101). SN 77-499,804. PUB. 11-11-2008. FILED 6-16-2008.
 3,567,213. **MISCELLANEOUS DESIGN.** BALANCED CARE FOR WOMEN OF ST. LOUIS, P.C., (U.S. CLS. 100 AND 101). SN 77-499,924. PUB. 11-11-2008. FILED 6-16-2008.
 3,567,219 (*See Class 43 for this trademark*).
 3,567,279. **THIS IS MORE (BLOCK FORM).** FAIRVIEW HEALTH SERVICES, (U.S. CLS. 100 AND 101). SN 77-501,023. PUB. 11-11-2008. FILED 6-17-2008.
 3,567,280. **WITH NEW THINKING, MORE IS POSSIBLE (BLOCK FORM).** FAIRVIEW HEALTH SERVICES, (U.S. CLS. 100 AND 101). SN 77-501,047. PUB. 11-11-2008. FILED 6-17-2008.
 3,567,437. **THE SPA COEUR D'ALENE AND DESIGN.** HAGADONE HOSPITALITY CO., (U.S. CLS. 100 AND 101). SN 77-503,474. PUB. 11-11-2008. FILED 6-19-2008.
 3,567,481. **PREVENTFIRST (BLOCK FORM).** ULTRASOUND SERVICES OF AMERICA, INC., DBA PREVENTFIRST, (U.S. CLS. 100 AND 101). SN 77-504,528. PUB. 11-11-2008. FILED 6-20-2008.
 3,567,502. **DCOSMETIQUE (BLOCK FORM).** DAS, DEEPA, AND DAS, MUNISH, (U.S. CLS. 100 AND 101). SN 77-504,890. PUB. 11-11-2008. FILED 6-21-2008.
 3,567,506. **MISCELLANEOUS DESIGN.** GARDEN STATE FOOT & ANKLE GROUP, LLC, (U.S. CLS. 100 AND 101). SN 77-505,066. PUB. 11-11-2008. FILED 6-23-2008.
 3,567,554 (*See Class 33 for this trademark*).
 3,567,555. **LIQUID METAL TATTOO & PIERCING (BLOCK FORM).** SANDRA KING, DBA LIQUID METAL TATTOO & PIERCING, (U.S. CLS. 100 AND 101). SN 77-506,028. PUB. 11-11-2008. FILED 6-23-2008.
 3,567,746. **HOA HEMATOLOGY/ONCOLOGY ASSOCIATES OF CENTRAL NEW YORK AND DESIGN.** HEMATOLOGY-ONCOLOGY ASSOCIATES OF CENTRAL NEW YORK, P.C., (U.S. CLS. 100 AND 101). SN 78-658,529. PUB. 11-11-2008. FILED 6-27-2005.
 3,567,749 (*See Class 2 for this trademark*).
 3,567,818 (*See Class 9 for this trademark*).
 3,567,875 (*See Class 41 for this trademark*).

CLASS 45—PERSONAL AND LEGAL SERVICES

3,566,274. **SPYVILLE (BLOCK FORM).** SPYVILLE, LLC, (U.S. CLS. 100 AND 101). SN 76-671,073. PUB. 11-11-2008. FILED 1-5-2007.
 3,566,293 (*See Class 35 for this trademark*).
 3,566,360. **PLAUDITS! (BLOCK FORM).** PLAUDITS!, INC., (U.S. CLS. 100 AND 101). SN 76-690,835. PUB. 11-11-2008. FILED 6-25-2008.
 3,566,372 (*See Class 35 for this trademark*).
 3,566,395. **VIDEO DOORMAN (BLOCK FORM).** AMERICAN SECURITY SYSTEMS, INC., (U.S. CLS. 100 AND 101). SN 77-067,418. PUB. 12-4-2007. FILED 12-19-2006.
 3,566,461 (*See Class 35 for this trademark*).
 3,566,513 (*See Class 3 for this trademark*).
 3,566,520 (*See Class 41 for this trademark*).
 3,566,535. **GOTTADO (BLOCK FORM).** PREBBLE, LANCE EDMUND KNIGHTS, (U.S. CLS. 100 AND 101). SN 77-266,996. PUB. 11-11-2008. FILED 8-29-2007.
 3,566,594 (*See Class 35 for this trademark*).
 3,566,605 (*See Class 35 for this trademark*).
 3,566,607 (*See Class 35 for this trademark*).
 3,566,647 (*See Class 36 for this trademark*).
 3,566,648. **LIFEAID (BLOCK FORM).** LIFESTATION, INC., (U.S. CLS. 100 AND 101). SN 77-340,396. PUB. 11-11-2008. FILED 11-29-2007.
 3,566,685 (*See Class 41 for this trademark*).
 3,566,748 (*See Class 35 for this trademark*).
 3,566,791 (*See Class 9 for this trademark*).
 3,566,805. **GET THE GUY (BLOCK FORM).** GET THE GIRL, INC., DBA GET THE GUY, (U.S. CLS. 100 AND 101). SN 77-409,531. PUB. 11-11-2008. FILED 2-29-2008.

3,566,813 (*See Class 35 for this trademark*).
 3,566,864 (*See Class 41 for this trademark*).
 3,566,869 (*See Class 31 for this trademark*).
 3,566,912. **LR LEGALREMEDY.NET SIMPLIFYING THE LEGAL PROCESS AND DESIGN.** LEGALREMEDY.NET, INC., (U.S. CLS. 100 AND 101). SN 77-465,309. PUB. 11-11-2008. FILED 5-5-2008.
 3,566,926 (*See Class 35 for this trademark*).
 3,567,013. **TMAP THREAT MANAGEMENT AND PROTECTION, INC. AND DESIGN.** THREAT MANAGEMENT AND PROTECTION, INC., (U.S. CLS. 100 AND 101). SN 77-487,859. PUB. 11-11-2008. FILED 5-30-2008.
 3,567,019. **EVER ARGUE WITH A WOMAN? (BLOCK FORM).** SCHRODER JOSEPH & ASSOCIATES LLP, (U.S. CLS. 100 AND 101). SN 77-488,308. PUB. 11-11-2008. FILED 6-2-2008.
 3,567,073. **ENVIROMOM (BLOCK FORM).** READYSETMOM, INC., (U.S. CLS. 100 AND 101). SN 77-493,352. PUB. 11-11-2008. FILED 6-6-2008.
 3,567,109. **CAREFORWARD AUTO INJURY CASE MANAGEMENT AND DESIGN.** PROFESSIONAL CASE MANAGEMENT, DBA CAREFORWARD, (U.S. CLS. 100 AND 101). SN 77-496,238. PUB. 11-11-2008. FILED 6-11-2008.
 3,567,134. **OCEAN TRIBUTE (BLOCK FORM).** WATTS, JAMIE, (U.S. CLS. 100 AND 101). SN 77-497,020. PUB. 11-11-2008. FILED 6-12-2008.
 3,567,135. **JOURNEY OF REMEMBRANCE (BLOCK FORM).** WATTS, JAMIE, (U.S. CLS. 100 AND 101). SN 77-497,024. PUB. 11-11-2008. FILED 6-12-2008.
 3,567,186 (*See Class 16 for this trademark*).
 3,567,211. **KELLEHER & ASSOCIATES (BLOCK FORM).** KELLEHER & ASSOCIATES, LLC, (U.S. CLS. 100 AND 101). SN 77-499,876. PUB. 11-11-2008. FILED 6-16-2008.
 3,567,232 (*See Class 43 for this trademark*).
 3,567,271. **CRARY BUCHANAN (BLOCK FORM).** CRARY, BUCHANAN, BOWDISH, BOVIE, ELDER & WILLIAMSON, (U.S. CLS. 100 AND 101). SN 77-500,885. PUB. 11-11-2008. FILED 6-17-2008.
 3,567,334 (*See Class 9 for this trademark*).
 3,567,348. **CARE ON CALL AND DESIGN.** CARE ON CALL FRANCHISE, INC., (U.S. CLS. 100 AND 101). SN 77-502,027. PUB. 11-11-2008. FILED 6-18-2008.
 3,567,450 (*See Class 41 for this trademark*).
 3,567,492. **VENDORCHECK (BLOCK FORM).** PRECHECK, INC., (U.S. CLS. 100 AND 101). SN 77-504,799. PUB. 11-11-2008. FILED 6-21-2008.
 3,567,600. **ALL ATTORNEYS PASS THE BAR, HIRE ONE WHO RAISES IT. (BLOCK FORM).** FULLER, REBECCA A, DBA FULLER LAW PRACTICE, PC, (U.S. CLS. 100 AND 101). SN 77-507,053. PUB. 11-11-2008. FILED 6-24-2008.
 3,567,622. **XTRALERT (BLOCK FORM).** RFR, INC, DBA JANSEN ELECTRONICS, (U.S. CLS. 100 AND 101). SN 77-508,617. PUB. 11-11-2008. FILED 6-26-2008.
 3,567,659. **MISCELLANEOUS DESIGN.** MAGNUS RESEARCH CONSULTANTS, INC., (U.S. CLS. 100 AND 101). SN 77-518,759. PUB. 11-11-2008. FILED 7-10-2008.
 3,567,661. **INSIGHTS FOR SUCCESS (BLOCK FORM).** MAGNUS RESEARCH CONSULTANTS, INC., (U.S. CLS. 100 AND 101). SN 77-519,089. PUB. 11-11-2008. FILED 7-10-2008.
 3,567,753 (*See Class 41 for this trademark*).
 3,567,824 (*See Class 35 for this trademark*).
 3,567,842. **MISCELLANEOUS DESIGN.** ORDINE DI SAN GIOVANNI DI GERUSALEMME, (U.S. CLS. 100 AND 101). SN 79-041,162. PUB. 11-11-2008. FILED 5-15-2007.
 3,567,916 (*See Class 9 for this trademark*).
 3,567,924 (*See Class 35 for this trademark*).
 3,567,932 (*See Class 12 for this trademark*).

* * * * *

SECTION 2.—PRIOR UNITED STATES CLASSIFICATION

COLLECTIVE MEMBERSHIP MARKS

CLASS 200—COLLECTIVE MEMBERSHIP

3,566,959. **OCEAN REEF CLUB (BLOCK FORM)**. OCEAN REEF CLUB INC., SN 77-480,395. PUB. 11-11-2008. FILED 5-21-2008.

ALPACA REGISTRY, INC., SN 77-454,087. PUB. 11-11-2008. FILED 4-21-2008.

3,567,389. **CIRCLE OF GREEN (BLOCK FORM)**. NATURAL BIO-ACTIVE PRODUCTS LLC, SN 77-502,644. PUB. 11-11-2008. FILED 6-19-2008.

CERTIFICATION MARKS

CLASS A—GOODS

3,566,326. **UNION MADE . AFFILIATED WITH . AMERICAN FEDERATION OF LABOR & CONGRESS OF INDUSTRIAL ORGANIZATIONS & CANADIAN LABOUR CONGRESS ORGANIZED NOV. 28, 1891 . INTERNATIONAL BROTHERHOOD OF ELECTRICAL WORKERS AND DESIGN. INTERNATIONAL BROTHERHOOD OF ELECTRICAL WORKERS**, SN 76-688,528. PUB. 11-11-2008. FILED 4-10-2008.

3,566,885. **ARI ALPACA REGISTRY INC AND DESIGN**.

CLASS B—SERVICES

3,566,365. **CAHME; CA + HME AND DESIGN. COMMISSION ON ACCREDITATION OF HEALTHCARE MANAGEMENT EDUCATION**, SN 76-978,868. PUB. 11-11-2008. FILED 6-3-2008.

3,566,586. **ACCREDITED PETROLEUM ACCOUNTANT (BLOCK FORM)**. COUNCIL OF PETROLEUM ACCOUNTANTS SOCIETIES, INC. (COPAS), SN 77-318,514. PUB. 11-11-2008. FILED 10-31-2007.

3,567,133. **ATP (BLOCK FORM)**. ANGEL THERAPY, INC., SN 77-496,902. PUB. 11-11-2008. FILED 6-11-2008.

* * * * *

TRADEMARK REGISTRATIONS ISSUED UNDER SECTION 1(d)

The following marks have registered on the Principal Register pursuant to the intent-to-use provisions of Section 1(d) of the Trademark Act of 1946, as amended.

SECTION 1.— INTERNATIONAL CLASSIFICATION

The short titles associated below with the international class numbers are terms designed merely for quick identification and are not an official part of the international classification. The full names of international classes are given in section 6.1 of the trademark rules of practice.

The designation "U.S. Cl." appearing in this section refers to the U.S. class in effect prior to Sep. 1, 1973 rather than the international class which applies to applications filed on or after that date. For adoption of international classification see notice in the OFFICIAL GAZETTE of Jun. 26, 1973 (911 O.G. TM 210).

Application in more than one class

3,567,995. SURFACE TECHNOLOGY HOLDINGS, LTD.,
CINCINNATI, OH. SN 76-559,549. PUB. 8-30-2005, FILED
10-27-2003.

LPB

SEC. 2(F).

CLASS 40—MATERIAL TREATMENT

FOR METAL TREATMENT SERVICES (U.S. CLS. 100,
103 AND 106).
FIRST USE 10-1-2008; IN COMMERCE 10-1-2008.

CLASS 42—SCIENTIFIC AND COMPUTER SERVICES

FOR DESIGN, ANALYSIS, AND TESTING OF SURFACE ENHANCEMENTS FOR INDUSTRIAL METALLIC COMPONENTS FOR THE PURPOSE OF IMPROVING FATIGUE LIFE (U.S. CLS. 100 AND 101).
FIRST USE 10-1-2008; IN COMMERCE 10-1-2008.

CLASS 16—PAPER GOODS AND PRINTED MATTER

FOR PRINTED MATTER, NAMELY, INSTRUCTION MANUALS, TECHNICAL DIAGRAMS, DESIGN DRAWINGS, INSTRUCTION AND TEACHING MATERIAL EXCEPT APPARATUS IN THE FIELD OF ENGINE COMPONENTS, EMISSION CONTROL SYSTEMS, BRAKE SYSTEMS AND VALVE TECHNOLOGY (U.S. CLS. 2, 5, 22, 23, 29, 37, 38 AND 50).
FIRST USE 8-1-1988; IN COMMERCE 8-1-1988.

CLASS 42—SCIENTIFIC AND COMPUTER SERVICES

FOR SCIENTIFIC AND TECHNOLOGICAL SERVICES AND RESEARCH AND DESIGN RELATING TO NEW PRODUCT DESIGN IN THE FIELD OF COMBUSTION ENGINES AND THE PARTS THEREOF; INDUSTRIAL ANALYSIS AND RESEARCH SERVICES IN THE FIELD OF MACHINES AND MACHINE TOOLS, MOTOR AND ENGINES, DESIGN AND DEVELOPMENT OF COMPUTER HARDWARE AND SOFTWARE IN THE FIELD OF MACHINES, MACHINE TOOLS, MOTORS AND ENGINES AS WELL AS PARTS THEREOF (U.S. CLS. 100 AND 101).
FIRST USE 8-1-1988; IN COMMERCE 8-1-1988.

3,568,000. GURRERA, JOSEPH R., NEW YORK, NY. SN 76-609,673. PUB. 3-7-2006, FILED 8-27-2004.

3,567,997. HILITE INTERNATIONAL, INC., CLEVELAND,
OH. SN 76-589,785. PUB. 7-4-2006, FILED 4-30-2004.

HILITE

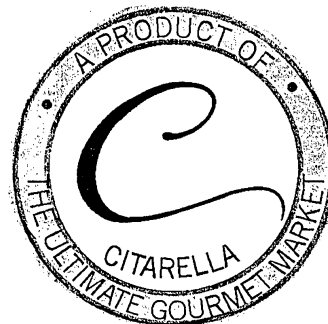

THE MARK CONSISTS OF STANDARD CHARACTERS WITHOUT CLAIM TO ANY PARTICULAR FONT, STYLE, SIZE, OR COLOR.

OWNER OF U.S. REG. NOS. 1,756,194, 2,586,109, AND OTHERS.

NO CLAIM IS MADE TO THE EXCLUSIVE RIGHT TO USE "A PRODUCT OF THE ULTIMATE GOURMET MARKET", APART FROM THE MARK AS SHOWN.

3,568,020. UNI-CLEANER AMERIKA APS, DK-6990 ULFBORG, DENMARK. SN 76-675,028. PUB. 3-18-2008, FILED 4-3-2007.

CLASS 29—MEATS AND PROCESSED FOODS

FOR DRIED FRUIT; NUT MEATS AND ROASTED, SHELLED AND PROCESSED NUTS; PREPARED AND PACKAGED ENTREES PRIMARILY OF MEAT, FISH, POULTRY OR VEGETABLES; PRESERVED TRUFFLES; OLIVE OIL; FOIE GRAS; PEELED TOMATOES; CAVIAR; CHEESES (U.S. CL. 46).

FIRST USE 11-12-2008; IN COMMERCE 11-12-2008.

CLASS 30—STAPLE FOODS

FOR PROCESSED HERBS; PROCESSED CEREALS; CHOCOLATE TRUFFLES; PROCESSED GRAINS; SPICES; SAUCES; PASTAS; RICES; VINEGAR; COFFEE; AND TEA (U.S. CL. 46).

FIRST USE 11-12-2008; IN COMMERCE 11-12-2008.



THE MARK CONSISTS OF THE WORDING "MIL-TEK" PRINTED BELOW A SILHOUETTE OF A HUMAN FIGURE SQUEEZING A BUNDLE OF TIED MATERIAL WHICH IS LOCATED WITHIN AN ARC IN THE FORM OF A CURVED ARROW.

3,568,007. TONY'S SEAFOOD, LTD., BATON ROUGE, LA. SN 76-658,854. PUB. 9-4-2007, FILED 4-24-2006.

CLASS 3—COSMETICS AND CLEANING PREPARATIONS

FOR GENERAL HOUSEHOLD BIOLOGICAL DETERGENTS, NAMELY, DETERGENT SOAPS AND LAUNDRY DETERGENTS (U.S. CLS. 1, 4, 6, 50, 51 AND 52).

FIRST USE 1-1-2005; IN COMMERCE 1-1-2005.

CLASS 7—MACHINERY

FOR BLAST GUNS FOR USE IN CLEANING AND COMPACTING MACHINES FOR COMPACTING, SQUEEZING AND COMPRESSING WASTE, MATERIALS, PAPER, PLASTIC, AND GARBAGE BAGS; COMPRESSED AIR BLAST GUNS FOR GENERAL CLEANING AND DUSTING PURPOSES FOR CLEANING ARTICLES OF DUST, DIRT, AND OILY OR STICKY SUBSTANCE (U.S. CLS. 13, 19, 21, 23, 31, 34 AND 35).

FIRST USE 1-1-2005; IN COMMERCE 1-1-2005.

CLASS 22—CORDAGE AND FIBERS

FOR CORDAGE (U.S. CLS. 1, 2, 7, 19, 22, 42 AND 50).

FIRST USE 1-1-2005; IN COMMERCE 1-1-2005.

CATERING TO GEAUX

THE MARK CONSISTS OF STANDARD CHARACTERS WITHOUT CLAIM TO ANY PARTICULAR FONT, STYLE, SIZE, OR COLOR.

CLASS 29—MEATS AND PROCESSED FOODS

FOR COOKED AND PREPARED FOODS, NAMELY, SHELLFISH; FISH; CHICKEN; TURKEY; PORK; BEEF; FRIED POTATOES; POTATO SALAD; VEGETABLE SALAD; COLE SLAW; COOKED AND PREPARED VEGETABLES, NAMELY, GREEN BEANS, MUSTARD GREENS, BAKED BEANS, BROCCOLI, AND OKRA; GUMBO; SAUSAGES; BOUDIN; ETOUFFEE; AND HOGSHEAD CHEESE (U.S. CL. 46).

FIRST USE 10-0-2006; IN COMMERCE 10-0-2006.

CLASS 30—STAPLE FOODS

FOR COOKED AND PREPARED FOODS, NAMELY, JAMBALAYA; RED BEANS AND RICE; CORN; HUSH-PUPPIES; RICE DRESSING; SANDWICHES; PASTA AND READY MADE SAUCES; MEAT AND SEAFOOD PIES; PUDDINGS; AND FRUIT COBBLERS (U.S. CL. 46).

FIRST USE 10-0-2006; IN COMMERCE 10-0-2006.

3,568,025. EZ-FLO INTERNATIONAL, INC., ONTARIO, CA. SN 76-680,667. PUB. 7-1-2008, FILED 8-13-2007.

PLUMBWELL

THE MARK CONSISTS OF STANDARD CHARACTERS WITHOUT CLAIM TO ANY PARTICULAR FONT, STYLE, SIZE, OR COLOR.

CLASS 6—METAL GOODS

FOR SILVER SOLDER, METAL LOCKS, METAL LATCHES, METAL HINGES, METAL DOOR STOPS AND METAL DOOR KNOBS, METAL BALL JOINT WASHERS, METAL WATER CLOSET NUTS, METAL WATER CLOSET BOLT WASHERS, METAL WATER CLOSET SCREWS; METAL JOINERY FITTINGS, NAMELY, COMPRESSION FITTINGS, COMPRESSION SLEEVE, COMPRESSION ELBOWS, COMPRESSION TEE, COMPRESSION UNION, FLARE ELBOW, FLARE FITTINGS, FLARE NUT, FLARE UNION, FLARE TEE, COMPRESSION NUT; METAL HOSE CONNECTORS, COPPER TUBING, STAINLESS STEEL DISHWASHER SUPPLY LINE, DRYER VENT KITS COMPRISED OF METAL CLAMPS, ALUMINUM DUCTING AND TRAP BUCKETS, METAL FACE PLATES; METAL FILTER HOSE WASHERS, METAL FIREPLACE KEYS, METAL PLATED FLANGES, METAL FLARE CAPS FOR PIPES, METAL FLEXIBLE DOOR STOP, METAL GAS RANGE FLEX CONNECTOR, METAL SINK HANGERS, METAL EXTENSION TUBE, METAL HOSE BARBS, METAL HOSE CONNECTORS, STAINLESS STEEL WASHING MACHINE HOSE, METAL J BEND, METAL NUTS, METAL P TRAPS, METAL PIPE REPAIR CLAMPS, METAL FLOAT RODS, METAL S TRAPS, METAL SEWER RODS, METAL SLIP JOINT NUTS, METAL SLIP JOINT WASHERS, METAL PIPES, NAMELY, BRANCH TAILPIECES (U.S. CLS. 2, 12, 13, 14, 23, 25 AND 50).
FIRST USE 11-1-2007; IN COMMERCE 11-1-2007.

CLASS 11—ENVIRONMENTAL CONTROL APPARATUS

FOR PLUMBING FITTINGS, NAMELY, FAUCETS, VALVES, SHOWERHEADS, COMPRESSION ADAPTERS, HANDLE ADAPTERS, FAUCET AERATORS, BALLCOCKS, BALLCOCK PARTS, DELTA BALLS, TANK BALLS, BATH SPRAY, DISHWASHER AIR GAP, DIVERTER SPOUT, SHOWER DOOR SEAL, SHOWER DRAINS, ESCUTCHEON NIPPLE, TOILET FLAPPERS, FLOW RESTRICTOR, FLUSH VALVE, FLUSH VALVE SEAL, FORCE CUPS, TOILET TANK LEVER, NIPPLES FOR FAUCETS, PERSONAL SHOWERS, SADDLE VALVES, FAUCET SEATS, SHAMPOO SPRAY, SHOWER ARMS, SHOWER DRAIN, SHOWER FLOW RESTRICTOR, SHOWER HEADS, SHOWER TREAD, SINK TRAP, SPRAY HEAD, STEMS, STRAINERS, SINK TUB, SWIVEL GLIDES, TOILET BOWL FLOATS, TOILET SEAT BUMPERS, TOILET TANK LEVERS, TUB COVE, VALVES, STAINLESS STEEL FAUCET CONNECTORS AND GAS FLEX CONNECTORS; COPPER WASTE CONNECTORS, COPPER WATER HEATER FLEX CONNECTORS, METAL FAUCET HANDLES, FAUCET HOLE COVERS AND FAUCET STEMS; BRASS TOILET BOWL FLANGE (U.S. CLS. 13, 21, 23, 31 AND 34).
FIRST USE 11-1-2007; IN COMMERCE 11-1-2007.

CLASS 17—RUBBER GOODS

FOR PIPE JOINT TAPE, ELECTRICAL INSULATING TAPE, PUTTY AND GASKET SEALER FOR USE IN PLUMBING, RUBBER WATER CLOSET BOWL RINGS, RUBBER CONE WASHERS; PIPE FITTINGS, NAMELY, CPVC CONNECTORS, PVC FAUCET CONNECTORS, PLASTIC WASTE CONNECTORS, RUBBER DISHWASHER DISPOSER CONNECTOR; RUBBER DISHWASHER DRAIN HOSE, RUBBER DISPOSER HUSH CUSHION, RUBBER DISPOSER SPLASH GUARD, PLASTIC FACE PLATES, NONMETAL GASKETS, RUBBER DISHWASHER DRAIN HOSE, PLASTIC WASHING MACHINE DRAIN HOSE, PLASTIC J BEND, NONMETAL LAVATORY FLANGE GASKET, PLASTIC P TRAPS AND S TRAPS, RUBBER O RINGS STOPPER RINGS, NONMETAL SEAT HINGE GASKETS, RUBBER SHOWER BALL JOINT WASHERS, NONMETAL SINK GASKET, RUBBER SWING SPOUT WASHERS, RUBBER TANK WASHERS, PLASTIC TOILET BOWL FLANGE, VINYL TRAP COVER, PLASTIC SEAT BUMPERS, PLASTIC EXTENSION TUBE; NON-METALLIC PIPES, NAMELY, BRANCH TAILPIECES (U.S. CLS. 1, 5, 12, 13, 35 AND 50).
FIRST USE 11-1-2007; IN COMMERCE 11-1-2007.

3,568,029. ERA DESIGN, LTD., BROOKLYN, NY. SN 76-682,517. PUB. 3-18-2008, FILED 10-2-2007.

DON'T BE SHY, SHINE!

THE MARK CONSISTS OF STANDARD CHARACTERS WITHOUT CLAIM TO ANY PARTICULAR FONT, STYLE, SIZE, OR COLOR.

CLASS 9—ELECTRICAL AND SCIENTIFIC APPARATUS

FOR SUNGLASSES AND EYEGLASSES (U.S. CLS. 21, 23, 26, 36 AND 38).
FIRST USE 12-17-2007; IN COMMERCE 12-17-2007.

CLASS 14—JEWELRY

FOR WATCHES (U.S. CLS. 2, 27, 28 AND 50).
FIRST USE 12-17-2007; IN COMMERCE 12-17-2007.

CLASS 16—PAPER GOODS AND PRINTED MATTER

FOR BALLPOINT PENS (U.S. CLS. 2, 5, 22, 23, 29, 37, 38 AND 50).
FIRST USE 12-17-2007; IN COMMERCE 12-17-2007.

3,568,046. THE STUDENT CONSERVATION ASSOCIATION, INC., CHARLESTOWN, NH. SN 77-015,035. PUB. 6-19-2007, FILED 10-5-2006.



OWNER OF U.S. REG. NOS. 1,734,734, 1,758,814, AND 2,229,673.

THE MARK CONSISTS OF A DESIGN OF A LEAF WITH THE LETTERS "SCA" UNDERNEATH THE DESIGN.

CLASS 9—ELECTRICAL AND SCIENTIFIC APPARATUS

FOR DVDS FEATURING INFORMATION REGARDING THE INTERNSHIP AND TRAINING PROGRAM EXPERIENCES OF STUDENTS AND THE GENERAL PUBLIC WHO PARTICIPATE IN ENVIRONMENTAL PROJECTS (U.S. CLS. 21, 23, 26, 36 AND 38).
FIRST USE 1-31-2008; IN COMMERCE 1-31-2008.

CLASS 16—PAPER GOODS AND PRINTED MATTER

FOR PUBLICATIONS, NAMELY, NEWSLETTERS FEATURING INFORMATION REGARDING THE INTERNSHIP AND TRAINING PROGRAM EXPERIENCES OF STUDENTS AND THE GENERAL PUBLIC WHO PARTICIPATE IN ENVIRONMENTAL PROJECTS; PENS, NOTEPADS (U.S. CLS. 2, 5, 22, 23, 29, 37, 38 AND 50).
FIRST USE 10-1-2006; IN COMMERCE 10-1-2006.

3,568,049. UWINK, INC., VAN NUYS, CA. SN 77-019,052. PUB. 7-31-2007, FILED 10-11-2006.

CLASS 21—HOUSEWARES AND GLASS

FOR PLASTIC WATER BOTTLES SOLD EMPTY; TRAVEL MUGS; COFFEE MUGS (U.S. CLS. 2, 13, 23, 29, 30, 33, 40 AND 50).
FIRST USE 10-1-2006; IN COMMERCE 10-1-2006.

CLASS 25—CLOTHING

FOR CLOTHING, NAMELY, SHIRTS, JACKETS, VESTS, HATS AND BANDANAS (U.S. CLS. 22 AND 39).
FIRST USE 10-1-2006; IN COMMERCE 10-1-2006.

CLASS 41—EDUCATION AND ENTERTAINMENT

FOR EDUCATIONAL SERVICES, NAMELY, INTERNSHIP AND TRAINING PROGRAMS FOR STUDENTS AND THE GENERAL PUBLIC FEATURING ENVIRONMENTAL PROJECTS IN NATIONAL PARKS, FORESTS AND OTHER PUBLIC LANDS (U.S. CLS. 100, 101 AND 107).
FIRST USE 10-1-2006; IN COMMERCE 10-1-2006.



3,568,047. RFIDCOMPLETE, ANCHORAGE, AK. SN 77-016,085. PUB. 5-15-2007, FILED 10-6-2006.

THE MARK CONSISTS OF A FORK AND KNIFE DESIGN WITHIN TWO CIRCLES.

CLASS 25—CLOTHING

FOR CLOTHING, NAMELY, T-SHIRTS, TANK TOPS; HEAD WEAR; CAPS (U.S. CLS. 22 AND 39).
FIRST USE 11-30-2006; IN COMMERCE 11-30-2006.

CLASS 41—EDUCATION AND ENTERTAINMENT

FOR ENTERTAINMENT SERVICES, NAMELY, PROVIDING ON-LINE COMPUTER GAMES, INTERACTIVE ONLINE COMPUTER GAMES AND COMPUTER GAMES; ENTERTAINMENT SERVICES, NAMELY, CONDUCTING LIVE INTERACTIVE COMPUTER GAMES AND CONDUCTING COMPUTER GAME TOURNAMENTS VIA COMPUTER TOUCH SCREENS BETWEEN TABLES WITHIN A RESTAURANT, BAR OR COCKTAIL LOUNGE; ENTERTAINMENT SERVICES, NAMELY, PROVIDING CUSTOMERS INTERACTIVE COMPUTER TOUCH SCREENS FOR LIVE INTERACTIVE COMMUNICATIONS BETWEEN TABLES WITHIN A RESTAURANT, BAR OR COCKTAIL LOUNGE AND FOR VIEWING AUDIO AND VIDEO MEDIA INCLUDING PRERECORDED VIDEOS, MOVIE TRAILERS, AND HOROSCOPES (U.S. CLS. 100, 101 AND 107).
FIRST USE 11-30-2006; IN COMMERCE 11-30-2006.

CLASS 43—HOTEL AND RESTAURANT SERVICES

FOR RESTAURANT, BAR AND COCKTAIL LOUNGE SERVICES FEATURING INTERACTIVE COMPUTER TOUCH SCREENS FOR ORDERING FOOD AND DRINKS; RESTAURANT, BAR AND COCKTAIL LOUNGE SERVICES (U.S. CLS. 100 AND 101).
FIRST USE 11-30-2006; IN COMMERCE 11-30-2006.

Intertiviti

THE MARK CONSISTS OF STANDARD CHARACTERS WITHOUT CLAIM TO ANY PARTICULAR FONT, STYLE, SIZE, OR COLOR.

CLASS 35—ADVERTISING AND BUSINESS

FOR ASSISTANCE, ADVISORY SERVICES AND CONSULTANCY WITH REGARD TO BUSINESS PLANNING, BUSINESS ANALYSIS, BUSINESS MANAGEMENT, AND BUSINESS ORGANIZATION; BUSINESS MANAGEMENT CONSULTANCY SERVICES; INVENTORY MANAGEMENT IN THE FIELDS OF HEALTH CARE, TRANSPORTATION AND MILITARY OPERATIONS (U.S. CLS. 100, 101 AND 102).
FIRST USE 11-2-2006; IN COMMERCE 11-2-2006.

CLASS 42—SCIENTIFIC AND COMPUTER SERVICES

FOR INFORMATION TECHNOLOGY CONSULTATION (U.S. CLS. 100 AND 101).
FIRST USE 11-2-2006; IN COMMERCE 11-2-2006.

3,568,050. UWINK, INC., VAN NUYS, CA. SN 77-019,062. PUB. 7-31-2007, FILED 10-11-2006.

3,568,051. UWINK, INC., VAN NUYS, CA. SN 77-019,072. PUB. 7-31-2007, FILED 10-11-2006.



THE MARK CONSISTS OF A MARTINI DESIGN WITHIN TWO CIRCLES.

CLASS 25—CLOTHING

FOR CLOTHING, NAMELY, T-SHIRTS, TANK TOPS (U.S. CLS. 22 AND 39).
FIRST USE 11-30-2006; IN COMMERCE 11-30-2006.

CLASS 41—EDUCATION AND ENTERTAINMENT

FOR ENTERTAINMENT SERVICES, NAMELY, PROVIDING ON-LINE COMPUTER GAMES, INTERACTIVE ONLINE COMPUTER GAMES AND COMPUTER GAMES; ENTERTAINMENT SERVICES, NAMELY, CONDUCTING LIVE INTERACTIVE COMPUTER GAMES AND CONDUCTING COMPUTER GAME TOURNAMENTS VIA COMPUTER TOUCH SCREENS BETWEEN TABLES WITHIN A RESTAURANT, BAR OR COCKTAIL LOUNGE; ENTERTAINMENT SERVICES, NAMELY, PROVIDING CUSTOMERS INTERACTIVE COMPUTER TOUCH SCREENS FOR LIVE INTERACTIVE COMMUNICATIONS BETWEEN TABLES WITHIN A RESTAURANT, BAR OR COCKTAIL LOUNGE AND FOR VIEWING AUDIO AND VIDEO MEDIA INCLUDING VIDEOS, MOVIE TRAILERS, AND HOROSCOPES (U.S. CLS. 100, 101 AND 107).
FIRST USE 11-30-2006; IN COMMERCE 11-30-2006.

CLASS 43—HOTEL AND RESTAURANT SERVICES

FOR RESTAURANT, BAR AND COCKTAIL LOUNGE SERVICES FEATURING INTERACTIVE COMPUTER TOUCH SCREENS FOR ORDERING FOOD AND DRINKS; RESTAURANT, BAR AND COCKTAIL LOUNGE SERVICES (U.S. CLS. 100 AND 101).
FIRST USE 11-30-2006; IN COMMERCE 11-30-2006.



THE MARK CONSISTS OF A MONITOR DESIGN WITHIN TWO CIRCLES.

CLASS 25—CLOTHING

FOR CLOTHING, NAMELY, T-SHIRTS AND TANK TOPS (U.S. CLS. 22 AND 39).
FIRST USE 11-30-2006; IN COMMERCE 11-30-2006.

CLASS 41—EDUCATION AND ENTERTAINMENT

FOR ENTERTAINMENT SERVICES, NAMELY, PROVIDING ON-LINE COMPUTER GAMES, INTERACTIVE ONLINE COMPUTER GAMES AND COMPUTER GAMES; ENTERTAINMENT SERVICES, NAMELY, CONDUCTING LIVE INTERACTIVE COMPUTER GAMES AND CONDUCTING COMPUTER GAME TOURNAMENTS VIA COMPUTER TOUCH SCREENS BETWEEN TABLES WITHIN A RESTAURANT, BAR OR COCKTAIL LOUNGE; ENTERTAINMENT SERVICES, NAMELY, PROVIDING CUSTOMERS INTERACTIVE COMPUTER TOUCH SCREENS FOR LIVE INTERACTIVE COMMUNICATIONS BETWEEN TABLES WITHIN A RESTAURANT, BAR OR COCKTAIL LOUNGE AND FOR VIEWING AUDIO AND VIDEO MEDIA INCLUDING VIDEOS, MOVIE TRAILERS, AND HOROSCOPES (U.S. CLS. 100, 101 AND 107).
FIRST USE 11-30-2006; IN COMMERCE 11-30-2006.

CLASS 43—HOTEL AND RESTAURANT SERVICES

FOR RESTAURANT, BAR AND COCKTAIL LOUNGE SERVICES FEATURING INTERACTIVE COMPUTER TOUCH SCREENS FOR ORDERING FOOD AND DRINKS; RESTAURANT, BAR AND COCKTAIL LOUNGE SERVICES (U.S. CLS. 100 AND 101).
FIRST USE 11-30-2006; IN COMMERCE 11-30-2006.

3,568,053. AMERICAN ACADEMY OF ORTHOPAEDIC SURGEONS, ROSEMONT, IL. SN 77-020,435. PUB. 6-26-2007, FILED 10-13-2006.



OWNER OF U.S. REG. NOS. 2,147,400, 2,149,033, AND 2,357,561.

NO CLAIM IS MADE TO THE EXCLUSIVE RIGHT TO USE "AMERICAN ASSOCIATION OF ORTHOPAEDIC SURGEONS", APART FROM THE MARK AS SHOWN.

THE MARK CONSISTS OF THE CAPITAL LETTERS "AAOS", WITH THE "O" BEING COMPRISED OF SEMI-CIRCULAR SHAPED SEGMENTS, WITH THE WORDING "AMERICAN ASSOCIATION OF ORTHOPAEDIC SURGEONS" WRITTEN BELOW AND IN SMALLER FONT.

CLASS 9—ELECTRICAL AND SCIENTIFIC APPARATUS

FOR PRE-RECORDED CD'S, VIDEO TAPES, LASER DISKS AND DVD'S FEATURING EDUCATIONAL AND INFORMATIVE CONTENT IN RELATION TO ORTHOPAEDIC HEALTH (U.S. CLS. 21, 23, 26, 36 AND 38).
FIRST USE 1-1-2007; IN COMMERCE 1-1-2007.

CLASS 16—PAPER GOODS AND PRINTED MATTER

FOR PUBLICATIONS, NAMELY, BROCHURES, BOOKLETS, AND TEACHING MATERIALS IN THE FIELD OF ORTHOPAEDIC SURGERY (U.S. CLS. 2, 5, 22, 23, 29, 37, 38 AND 50).
FIRST USE 1-1-2007; IN COMMERCE 1-1-2007.

CLASS 35—ADVERTISING AND BUSINESS

FOR ASSOCIATION SERVICES, NAMELY, PROMOTING THE INTERESTS OF ORTHOPAEDIC SURGEONS AND PERSONS PRACTICING RELATED MEDICAL SPECIALTIES (U.S. CLS. 100, 101 AND 102).
FIRST USE 1-1-2007; IN COMMERCE 1-1-2007.

CLASS 41—EDUCATION AND ENTERTAINMENT

FOR EDUCATIONAL SERVICES, NAMELY, CONDUCTING SEMINARS AND CONFERENCES IN THE FIELD OF ORTHOPAEDIC HEALTH AND RELATED MEDICAL SPECIALTIES AND DISTRIBUTION OF COURSE MATERIAL IN CONNECTION THEREWITH (U.S. CLS. 100, 101 AND 107).
FIRST USE 1-1-2007; IN COMMERCE 1-1-2007.

3,568,059. CYTYC CORPORATION, MARLBOROUGH, MA. SN 77-027,416. PUB. 12-25-2007, FILED 10-23-2006.

CELLIENT

THE MARK CONSISTS OF STANDARD CHARACTERS WITHOUT CLAIM TO ANY PARTICULAR FONT, STYLE, SIZE, OR COLOR.

CLASS 1—CHEMICALS

FOR DIAGNOSTIC PREPARATIONS, REAGENTS AND CHEMICAL TEST KITS FOR SCIENTIFIC LABORATORY OR RESEARCH USE IN DETECTING CANCEROUS CONDITIONS (U.S. CLS. 1, 5, 6, 10, 26 AND 46).
FIRST USE 9-28-2007; IN COMMERCE 9-28-2007.

CLASS 5—PHARMACEUTICALS

FOR DIAGNOSTIC PREPARATIONS, REAGENTS AND TESTING KITS FOR CLINICAL OR MEDICAL LABORATORY USE IN DETECTING CANCEROUS CONDITIONS (U.S. CLS. 6, 18, 44, 46, 51 AND 52).
FIRST USE 9-28-2007; IN COMMERCE 9-28-2007.

CLASS 9—ELECTRICAL AND SCIENTIFIC APPARATUS

FOR APPARATUS, EQUIPMENT AND INSTRUMENTS FOR CYTOLOGY, HISTOLOGY AND PATHOLOGY LABORATORIES USED IN THE PREPARATION OF BIOLOGICAL HUMAN AND ANIMAL BIOLOGICAL SPECIMENS FOR CLINICAL DIAGNOSTIC PURPOSES AND FOR CYTOLOGY AND HISTOLOGY STUDY, NAMELY, SEMI-AUTOMATED CELL BLOCK PROCESSOR WITH ALCOHOL REAGENTS, EOSIN REAGENTS, XYLENE REAGENTS AND PARAFFIN; CASSETTES FOR CAPTURING AND CONTAINING BIOLOGICAL SAMPLES FOR USE IN THE FOREGOING CELL BLOCK PROCESSOR; LABORATORY EQUIPMENT, NAMELY, CELL BLOCK FINISHING STATION WITH SURFACE FOR HEATING CELL BLOCKS (U.S. CLS. 21, 23, 26, 36 AND 38).
FIRST USE 9-28-2007; IN COMMERCE 9-28-2007.

CLASS 10—MEDICAL APPARATUS

FOR MEDICAL DEVICES AND EQUIPMENT, NAMELY, CELL BLOCK APPARATUS FOR PREPARING HUMAN AND ANIMAL BIOLOGICAL SPECIMENS FOR CLINICAL MEDICAL OR VETERINARY DIAGNOSIS INCLUDING ONCOLOGY (U.S. CLS. 26, 39 AND 44).
FIRST USE 9-28-2007; IN COMMERCE 9-28-2007.

3,568,060. FOR YOUR EASE ONLY, INC., CHICAGO, IL. SN 77-030,671. PUB. 3-25-2008, FILED 10-27-2006.

LORI GREINER

THE MARK CONSISTS OF STANDARD CHARACTERS WITHOUT CLAIM TO ANY PARTICULAR FONT, STYLE, SIZE, OR COLOR.

CLASS 4—LUBRICANTS AND FUELS

FOR CANDLES (U.S. CLS. 1, 6 AND 15).
FIRST USE 0-0-1999; IN COMMERCE 0-0-1999.

CLASS 6—METAL GOODS

FOR JEWELRY BOXES MADE OF METAL (U.S. CLS. 2, 12, 13, 14, 23, 25 AND 50).
FIRST USE 2-28-2003; IN COMMERCE 2-28-2003.

CLASS 9—ELECTRICAL AND SCIENTIFIC APPARATUS

FOR EYE GLASSES; PLASTIC AND WOOD HOUSEHOLD STORAGE CONTAINERS FOR DVD, PHONOGRAPHIC RECORDS AND CD ORGANIZATION (U.S. CLS. 21, 23, 26, 36 AND 38).
FIRST USE 9-9-2002; IN COMMERCE 9-9-2002.

CLASS 14—JEWELRY

FOR COSTUME JEWELRY; SILVER JEWELRY; JEWELRY BOXES NOT OF METAL (U.S. CLS. 2, 27, 28 AND 50).
FIRST USE 0-0-1996; IN COMMERCE 0-0-1996.

CLASS 18—LEATHER GOODS

FOR COSMETIC CASES SOLD EMPTY; FABRIC COATED PLASTIC COSMETIC ORGANIZING CASES SOLD EMPTY; LUGGAGE (U.S. CLS. 1, 2, 3, 22 AND 41).
FIRST USE 3-24-2003; IN COMMERCE 3-24-2003.

CLASS 20—FURNITURE AND ARTICLES NOT OTHERWISE CLASSIFIED

FOR HANGERS FOR CLOTHES; PLASTIC CLOTHES HANGERS; PICTURE FRAMES; CLOSET ORGANIZERS, NAMELY, FABRIC SHELVES (U.S. CLS. 2, 13, 22, 25, 32 AND 50).

FIRST USE 9-3-2002; IN COMMERCE 9-3-2002.

CLASS 21—HOUSEWARES AND GLASS

FOR PLASTIC STORAGE CONTAINERS AND TRAYS FOR HOUSEHOLD AND DOMESTIC USE; BOWLS; MIXING BOWLS; SERVING FORKS AND SPOONS; PLASTIC TRAYS FOR HOUSEHOLD USE; PLASTIC TRIVETS; PLASTIC CONTAINERS FOR HOUSEHOLD USE; PLASTIC CONTAINERS FOR ORGANIZING GIFT WRAP; GLASS CANDLESTICKS; CORKSCREWS; FOOD FRESHNESS EXTENDERS, NAMELY, HOUSEHOLD CONTAINERS FOR FOOD (U.S. CLS. 2, 13, 23, 29, 30, 33, 40 AND 50).

FIRST USE 10-18-1999; IN COMMERCE 10-18-1999.

CLASS 35—ADVERTISING AND BUSINESS

FOR ONLINE RETAIL STORE SERVICES FEATURING HOUSEHOLD PRODUCTS; PROVIDING HOME SHOPPING SERVICES IN THE FIELD OF HOUSEHOLD GOODS BY MEANS OF TELEVISION (U.S. CLS. 100, 101 AND 102).

FIRST USE 0-0-2002; IN COMMERCE 0-0-2002.

3,568,062. EMBOTICS CORPORATION, KANATA, ONTARIO, CANADA. SN 77-033,899. PUB. 11-20-2007, FILED 11-1-2006.

EMBOTICS

THE MARK CONSISTS OF STANDARD CHARACTERS WITHOUT CLAIM TO ANY PARTICULAR FONT, STYLE, SIZE, OR COLOR.

CLASS 9—ELECTRICAL AND SCIENTIFIC APPARATUS

FOR COMPUTER SOFTWARE FOR ADMINISTRATION AND MANAGEMENT OF COMPUTER SYSTEMS (U.S. CLS. 21, 23, 26, 36 AND 38).

FIRST USE 11-30-2006; IN COMMERCE 11-30-2006.

CLASS 42—SCIENTIFIC AND COMPUTER SERVICES

FOR SOFTWARE CONSULTING IN THE FIELD OF ADMINISTRATION, MANAGEMENT AND SECURITY OF COMPUTER SYSTEMS; INTEGRATION, INSTALLATION, PERIODIC UPGRADING FOR OTHERS, AND MAINTENANCE OF COMPUTER SOFTWARE FOR USE IN THE FIELD OF ADMINISTRATION, MANAGEMENT AND SECURITY OF COMPUTER SYSTEMS (U.S. CLS. 100 AND 101).

FIRST USE 11-30-2006; IN COMMERCE 11-30-2006.

3,568,064. VUSTAR, LLC, FALLS CHURCH, VA. SN 77-039,717. PUB. 2-19-2008, FILED 11-8-2006.

VUSTAR

THE MARK CONSISTS OF STANDARD CHARACTERS WITHOUT CLAIM TO ANY PARTICULAR FONT, STYLE, SIZE, OR COLOR.

CLASS 9—ELECTRICAL AND SCIENTIFIC APPARATUS

FOR COMPUTER HARDWARE, COMPUTER PERIPHERALS, CAMERAS, AUDIO SPEAKERS, SATELLITE RECEIVERS, TELEVISION MONITORS, VIDEO RECORDERS, DVD PLAYERS AND ASSOCIATED COMPUTER SOFTWARE, FOR USE IN PROVIDING INFORMATION, COMMUNICATIONS AND ENTERTAINMENT TO MASS TRANSPORTATION VEHICLES AND FOR REMOTE MONITORING OF SECURITY AND ONBOARD CONDITIONS OF MASS TRANSPORTATION VEHICLES AND PASSENGERS THEREOF (U.S. CLS. 21, 23, 26, 36 AND 38).

FIRST USE 1-0-2007; IN COMMERCE 1-0-2007.

CLASS 38—COMMUNICATION

FOR INFORMATION TRANSMISSION SERVICES VIA ELECTRONIC COMMUNICATIONS NETWORKS IN THE FIELD OF MASS TRANSPORTATION; BROADCASTING SERVICES VIA SATELLITE AND WIRELESS BROADBAND IN THE FIELD OF MASS TRANSPORTATION; COMMUNICATIONS SERVICES VIA SATELLITE AND WIRELESS BROADBAND IN THE FIELD OF MASS TRANSPORTATION (U.S. CLS. 100, 101 AND 104).

FIRST USE 1-0-2007; IN COMMERCE 1-0-2007.

3,568,069. RSIALARM, INC., CIRCLE PINES, MN. SN 77-047,525. PUB. 6-19-2007, FILED 11-20-2006.

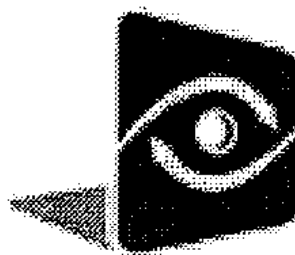
**CLASS 9—ELECTRICAL AND SCIENTIFIC APPARATUS**

FOR RESIDENTIAL AND COMMERCIAL ACCESS CONTROL AND SECURITY ALARM SYSTEMS COMPRISING ELECTRICAL AND ELECTRONIC ALARMS, CAMERAS AND VIDEO EQUIPMENT, MOTION AND INFRARED SENSORS, AND ELECTRONIC COMMUNICATION INSTRUMENTS AND COMPONENTS, NAMELY, TRANSMITTERS AND RECEIVERS, AND DATA LINKS (U.S. CLS. 21, 23, 26, 36 AND 38).

FIRST USE 11-30-2006; IN COMMERCE 11-30-2006.

CLASS 37—CONSTRUCTION AND REPAIR

FOR RESIDENTIAL AND COMMERCIAL SECURITY ALARM SERVICES, NAMELY, MAINTAINING AND SERVICING SECURITY ALARM SYSTEMS (U.S. CLS. 100, 103 AND 106).
FIRST USE 11-30-2006; IN COMMERCE 11-30-2006.

CLASS 45—PERSONAL AND LEGAL SERVICES

FOR RESIDENTIAL AND COMMERCIAL SECURITY ALARM SERVICES, NAMELY, MONITORING AND RESPONDING TO SECURITY ALARM SYSTEMS (U.S. CLS. 100 AND 101).
FIRST USE 11-30-2006; IN COMMERCE 11-30-2006.

3,568,078. COMPASS GROUP USA, INC., CHARLOTTE, NC. SN 77-060,337. PUB. 7-3-2007, FILED 12-8-2006.



THE MARK CONSISTS OF THE WORD "ENVIRONMENTS" WITHIN A LONG, HORIZONTAL OVAL, AND A VERTICAL FORK, KNIFE AND SPOON DESIGN.

CLASS 43—HOTEL AND RESTAURANT SERVICES

FOR CAFETERIAS; CONTRACT FOOD SERVICES (U.S. CLS. 100 AND 101).
FIRST USE 5-0-2006; IN COMMERCE 12-31-2007.

CLASS 44—MEDICAL, BEAUTY AND AGRICULTURAL SERVICES

FOR FOOD NUTRITION CONSULTATION (U.S. CLS. 100 AND 101).
FIRST USE 5-0-2006; IN COMMERCE 12-31-2007.

3,568,091. SANY HEAVY INDUSTRY CO., LTD., CHANGSHA HU NAN PROVINCE, CHINA. SN 77-077,405. PUB. 3-11-2008, FILED 1-5-2007.



OWNER OF U.S. REG. NO. 3,213,715.

CLASS 7—MACHINERY

FOR TRUCK-MOUNTED CONCRETE BOOM PUMP; TRUCK-MOUNTED CONCRETE LINE PUMP; TRAILER-MOUNTED CONCRETE PUMP; PLACING BOOM; TRUCK-MOUNTED CONCRETE MIXER; BULLDOZER; HYDRAULIC EXCAVATOR; SOIL COMPACTOR; ROLLER FOR USE IN ROAD CONSTRUCTION; PAVING MACHINES; COLD MILLING MACHINE; ASPHALT MIXING MACHINE; EARTH MOVING MACHINES, NAMELY, MOTOR GRADERS; DIRECTIONAL HORIZONTAL DRILLING MACHINE; MOBILE CRANE; CRAWLER CRANE; ROUGH TERRAIN CRANE; PILE DRILLERS (U.S. CLS. 13, 19, 21, 23, 31, 34 AND 35).
FIRST USE 2-14-2006; IN COMMERCE 2-14-2006.

CLASS 37—CONSTRUCTION AND REPAIR

FOR INSTALLATION, MAINTENANCE AND REPAIRS OF TRUCK-MOUNTED CONCRETE BOOM PUMP, TRUCK-MOUNTED CONCRETE LINE PUMP, TRAILER-MOUNTED CONCRETE PUMP, PLACING BOOM, CONCRETE BATCHING PLANT, CONCRETE TRUCK MIXER, BULLDOZER, EXCAVATOR, COMPACTOR, ROLLER, PAVER, COLD MILLING MACHINE, ASPHALT MIXING PLANT, ASPHALT TRANSFERRING VEHICLE, MOTOR GRADER, DIRECTIONAL HORIZONTAL DRILLING MACHINE, MOBILE CRANE, CRAWLER CRANE, ROUGH TERRAIN CRANE AND PILE DRILLER (U.S. CLS. 100, 103 AND 106).
FIRST USE 2-14-2006; IN COMMERCE 2-14-2006.

3,568,092. SANY HEAVY INDUSTRY CO., LTD., CHANGSHA HU NAN PROVINCE, CHINA. SN 77-077,407. PUB. 3-11-2008, FILED 1-5-2007.



THE MARK CONSISTS OF STANDARD CHARACTERS WITHOUT CLAIM TO ANY PARTICULAR FONT, STYLE, SIZE, OR COLOR.
OWNER OF U.S. REG. NO. 3,225,336.

CLASS 7—MACHINERY

FOR TRUCK-MOUNTED CONCRETE BOOM PUMP; TRUCK-MOUNTED CONCRETE LINE PUMP; TRAILER-MOUNTED CONCRETE PUMP; PLACING BOOM; TRUCK-MOUNTED CONCRETE MIXER; BULLDOZER; HYDRAULIC EXCAVATOR; SOIL COMPACTOR; ROLLER FOR USE IN ROAD CONSTRUCTION; PAVING MACHINES; COLD MILLING MACHINE; ASPHALT MIXING MACHINE; EARTH MOVING MACHINES, NAMELY, MOTOR GRADERS; DIRECTIONAL HORIZONTAL DRILLING MACHINE; MOBILE CRANE; CRAWLER CRANE; ROUGH TERRAIN CRANE; PILE DRILLER (U.S. CLS. 13, 19, 21, 23, 31, 34 AND 35).
FIRST USE 2-14-2006; IN COMMERCE 2-14-2006.

CLASS 37—CONSTRUCTION AND REPAIR

FOR INSTALLATION, MAINTENANCE AND REPAIRS OF TRUCK-MOUNTED CONCRETE BOOM PUMP, TRUCK-MOUNTED CONCRETE LINE PUMP, TRAILER-MOUNTED CONCRETE PUMP, PLACING BOOM, CONCRETE BATCHING PLANT, CONCRETE TRUCK MIXER, BULLDOZER, EXCAVATOR, COMPACTOR, ROLLER, PAVER, COLD MILLING MACHINE, ASPHALT MIXING PLANT, ASPHALT TRANSFERRING VEHICLE, MOTOR GRADER, DIRECTIONAL HORIZONTAL DRILLING MACHINE, MOBILE CRANE, CRAWLER CRANE, ROUGH TERRAIN CRANE AND PILE DRILLER (U.S. CLS. 100, 103 AND 106).
FIRST USE 2-14-2006; IN COMMERCE 2-14-2006.

3,568,112. SEEFELD, MATT, ENCINITAS, CA. SN 77-100,306. PUB. 1-15-2008, FILED 2-6-2007.

INTERPOINT PARTNERS

THE MARK CONSISTS OF STANDARD CHARACTERS WITHOUT CLAIM TO ANY PARTICULAR FONT, STYLE, SIZE, OR COLOR.

NO CLAIM IS MADE TO THE EXCLUSIVE RIGHT TO USE "PARTNERS", APART FROM THE MARK AS SHOWN.

CLASS 35—ADVERTISING AND BUSINESS

FOR CONSULTING SERVICES IN THE FIELD OF HUMAN RESOURCES DEVELOPMENT, NAMELY, FOR THE PROMOTION OF EMPLOYEE RETENTION, CAREER GROWTH, AND INCREASED PRODUCTIVITY FOR EMPLOYEES AND EMPLOYERS; BUSINESS CONSULTING AND INFORMATION SERVICES; BUSINESS CONSULTING AND BUSINESS INFORMATION SERVICES FOR ENTERPRISES; BUSINESS MANAGEMENT CONSULTING AND ADVISORY SERVICES; BUSINESS ORGANIZATION AND MANAGEMENT CONSULTING SERVICES; MANAGEMENT AND BUSINESS CONSULTING SERVICES IN THE FIELD OF HEALTH CARE AND MEDICAL SERVICE INDUSTRIES; PERSONNEL CONSULTANCY; PERSONNEL MANAGEMENT CONSULTATION (U.S. CLS. 100, 101 AND 102).
FIRST USE 6-1-2008; IN COMMERCE 6-1-2008.

CLASS 42—SCIENTIFIC AND COMPUTER SERVICES

FOR CUSTOMIZATION OF COMPUTER HARDWARE AND SOFTWARE; COMPUTER SOFTWARE DEVELOPMENT; DATABASE DEVELOPMENT SERVICES; DESIGN AND DEVELOPMENT OF ON-LINE COMPUTER SOFTWARE SYSTEMS; DESIGN, DEVELOPMENT AND IMPLEMENTATION OF SOFTWARE; INFORMATION TECHNOLOGY CONSULTING; CONSULTING SERVICES IN THE FIELD OF OFFICE AND WORKPLACE AUTOMATION (U.S. CLS. 100 AND 101).
FIRST USE 11-1-2007; IN COMMERCE 11-1-2007.

3,568,120. ACUSHNET COMPANY, FAIRHAVEN, MA. SN 77-102,545. PUB. 3-4-2008, FILED 2-8-2007.



OWNER OF U.S. REG. NO. 3,111,131.
THE MARK CONSISTS OF A HUMAN DEPICTED GOLFING.

CLASS 18—LEATHER GOODS

FOR DUFFLE BAGS AND TRAVEL BAGS (U.S. CLS. 1, 2, 3, 22 AND 41).
FIRST USE 11-0-2005; IN COMMERCE 11-0-2005.

CLASS 25—CLOTHING

FOR HATS, GOLF SHIRTS, T-SHIRTS, MOCK TURTLENECK SWEATERS, JACKETS, WIND-RESISTANT JACKETS, SHORTS, SWEATPANTS (U.S. CLS. 22 AND 39).
FIRST USE 11-0-2005; IN COMMERCE 11-0-2005.

CLASS 28—TOYS AND SPORTING GOODS

FOR GOLF EQUIPMENT, NAMELY, GOLF BAGS (U.S. CLS. 22, 23, 38 AND 50).
FIRST USE 11-0-2004; IN COMMERCE 11-0-2004.

3,568,126. DALTON, ERIC L., NAPLES, FL. AND POLLEY, WILLIAM F., NAPLES, FL. SN 77-110,428. PUB. 2-19-2008, FILED 2-19-2007.

BREEZERITE

THE MARK CONSISTS OF STANDARD CHARACTERS WITHOUT CLAIM TO ANY PARTICULAR FONT, STYLE, SIZE, OR COLOR.

CLASS 6—METAL GOODS

FOR DUAL OVERHEAD METAL GARAGE DOORS (U.S. CLS. 2, 12, 13, 14, 23, 25 AND 50).
FIRST USE 6-21-2007; IN COMMERCE 9-5-2008.

CLASS 19—NON-METALLIC BUILDING MATERIALS

FOR DUAL OVERHEAD NON-METAL GARAGE DOORS (U.S. CLS. 1, 12, 33 AND 50).
FIRST USE 6-21-2007; IN COMMERCE 9-5-2008.

3,568,128. NAIL SOUP MEDIA, LLC, WILMINGTON, DE. SN 77-114,398. PUB. 2-26-2008, FILED 2-23-2007.



NO CLAIM IS MADE TO THE EXCLUSIVE RIGHT TO USE "PREFERRED FINANCE", APART FROM THE MARK AS SHOWN.

THE STIPPLING IS FOR SHADING PURPOSES.
THE MARK CONSISTS OF THE LITERAL ELEMENTS "PREFERRED FINANCE" IN STYLIZED PRINT, WITH A SINGLE SWEEPING ORBIT FROM THE LETTER "P" TO THE LETTER "E".

CLASS 35—ADVERTISING AND BUSINESS

FOR MONITORING CONSUMER CREDIT REPORTS AND PROVIDING AN ALERT AS TO ANY CHANGES THEREIN; INSURANCE LEAD COLLECTION AND MATCHING SERVICES, NAMELY, MATCHING CONSUMER REQUESTS FOR INSURANCE POLICY QUOTES COLLECTED OVER THE INTERNET TO PRE-QUALIFIED INSURANCE BROKERS, AGENTS AND AGENCIES INTERESTED IN THOSE REQUESTS; PROVIDING INSURANCE AGENT REFERRALS (U.S. CLS. 100, 101 AND 102).

FIRST USE 6-25-2003; IN COMMERCE 6-25-2003.

CLASS 36—INSURANCE AND FINANCIAL

FOR FINANCIAL SERVICES, NAMELY, ADVISEMENT IN THE FIELD OF FINANCIAL PLANNING; MORTGAGE BANKING SERVICES, NAMELY, ORIENTATION, ACQUISITION, SERVICING, SECURITIZATION AND BROKERAGE OF MORTGAGE LOANS; FINANCIAL SERVICES, NAMELY, MORTGAGE PLANNING; CONSUMER CREDIT CONSULTATION; CREDIT AND FINANCIAL CONSULTATION; CREDIT REPORTING SERVICES; CREDIT RISK MANAGEMENT; FINANCIAL ANALYSIS AND CONSULTATION; FINANCIAL CONSULTATION; FINANCIAL LOAN CONSULTATION; FINANCIAL PLANNING CONSULTATION; FINANCIAL PLANNING, NAMELY, THE CREATION OF PERSONALIZED STRATEGIES TO ACHIEVE FINANCIAL INDEPENDENCE; FINANCIAL VALUATION OF PERSONAL PROPERTY AND REAL ESTATE (U.S. CLS. 100, 101 AND 102).

FIRST USE 6-25-2003; IN COMMERCE 6-25-2003.

3,568,134. RMC OF ILLINOIS, PHILADELPHIA, PA. SN 77-119,017. PUB. 3-11-2008, FILED 2-28-2007.

RIGHT CHOICE

THE MARK CONSISTS OF STANDARD CHARACTERS WITHOUT CLAIM TO ANY PARTICULAR FONT, STYLE, SIZE, OR COLOR.

OWNER OF U.S. REG. NOS. 2,755,894, 3,118,077, AND OTHERS.

CLASS 35—ADVERTISING AND BUSINESS

FOR BUSINESS CONSULTATION SERVICES, CAREER TRANSITION SERVICES, NAMELY, EMPLOYMENT OUTPLACEMENT SERVICES, CAREER PLACEMENT SERVICES, CAREER RECRUITING SERVICES IN THE NATURE OF EMPLOYMENT RECRUITING, EMPLOYMENT COUNSELING SERVICES, EMPLOYMENT OUTPLACEMENT SERVICES, HUMAN RESOURCE CONSULTATION SERVICES, PERSONNEL MANAGEMENT CONSULTATION SERVICES, AND PERSONNEL RETENTION CONSULTATION SERVICES (U.S. CLS. 100, 101 AND 102).

FIRST USE 11-17-2008; IN COMMERCE 11-17-2008.

CLASS 41—EDUCATION AND ENTERTAINMENT

FOR CAREER MANAGEMENT SERVICES, NAMELY, CAREER COUNSELING (U.S. CLS. 100, 101 AND 107).

FIRST USE 11-17-2008; IN COMMERCE 11-17-2008.

3,568,135. VIRGINIE NEUMANN, PARIS, FRANCE. SN 77-120,798. PUB. 3-18-2008, FILED 3-2-2007.

virginie castaway

THE MARK CONSISTS OF STANDARD CHARACTERS WITHOUT CLAIM TO ANY PARTICULAR FONT, STYLE, SIZE, OR COLOR.

"THE NAME(S), PORTRAIT(S), AND/OR SIGNATURE(S) SHOWN IN THE MARK DOES NOT IDENTIFY A PARTICULAR LIVING INDIVIDUAL."

CLASS 18—LEATHER GOODS

FOR EVENING HANDBAGS; HANDBAGS; LEATHER HANDBAGS (U.S. CLS. 1, 2, 3, 22 AND 41).

FIRST USE 2-1-2007; IN COMMERCE 2-1-2007.

CLASS 25—CLOTHING

FOR JERSEYS; LEATHER BELTS; MANTLES; MUFFLERS; SHIRTS; SHORT SETS; SHOULDER WRAPS; TOPS (U.S. CLS. 22 AND 39).

FIRST USE 2-1-2007; IN COMMERCE 2-1-2007.

3,568,139. ALEXANDRIA REAL ESTATE EQUITIES, INC., PASADENA, CA. SN 77-123,883. PUB. 3-4-2008, FILED 3-6-2007.

ALEXANDRIA TECHNOLOGY ACCELERATOR

THE MARK CONSISTS OF STANDARD CHARACTERS WITHOUT CLAIM TO ANY PARTICULAR FONT, STYLE, SIZE, OR COLOR.

OWNER OF U.S. REG. NOS. 2,300,322 AND 2,300,323.

NO CLAIM IS MADE TO THE EXCLUSIVE RIGHT TO USE "TECHNOLOGY", APART FROM THE MARK AS SHOWN.

CLASS 36—INSURANCE AND FINANCIAL

FOR REAL ESTATE SERVICES, NAMELY, REAL ESTATE BROKERAGE, ACQUISITION, RENTAL, LEASING AND MANAGEMENT OF OFFICE, RESEARCH AND LABORATORY PROPERTIES; FINANCIAL SERVICES, NAMELY, FINANCIAL CONSULTATION AND FINANCING SERVICES (U.S. CLS. 100, 101 AND 102).

FIRST USE 5-0-2003; IN COMMERCE 5-0-2003.

CLASS 37—CONSTRUCTION AND REPAIR

FOR REAL ESTATE DEVELOPMENT SERVICES; BUILDING CONSTRUCTION, MAINTENANCE AND REPAIR SERVICES (U.S. CLS. 100, 103 AND 106).

FIRST USE 5-0-2003; IN COMMERCE 5-0-2003.

3,568,142. PREFERRED HOTEL GROUP, INC., CHICAGO, IL. SN 77-126,112. PUB. 3-18-2008, FILED 3-8-2007.

3,568,147. THE UPPER DECK COMPANY, NORTH LAS VEGAS, NV. SN 77-128,613. PUB. 3-11-2008, FILED 3-12-2007.

PREFERRED RESIDENCES

THE MARK CONSISTS OF STANDARD CHARACTERS WITHOUT CLAIM TO ANY PARTICULAR FONT, STYLE, SIZE, OR COLOR.

OWNER OF U.S. REG. NOS. 1,227,080, 1,419,160, AND OTHERS.

NO CLAIM IS MADE TO THE EXCLUSIVE RIGHT TO USE "RESIDENCES", APART FROM THE MARK AS SHOWN.

SEC. 2(F) AS TO "PREFERRED".

CLASS 36—INSURANCE AND FINANCIAL

FOR VACATION RESORT TIME SHARE SERVICES (U.S. CLS. 100, 101 AND 102).

FIRST USE 1-0-2008; IN COMMERCE 1-0-2008.

CLASS 43—HOTEL AND RESTAURANT SERVICES

FOR HOTEL SERVICES (U.S. CLS. 100 AND 101).
FIRST USE 1-0-2008; IN COMMERCE 1-0-2008.

3,568,146. WILD FLAVORS, INC., ERLANGER, KY. SN 77-128,108. PUB. 3-11-2008, FILED 3-12-2007.

SAVORCRAVE

THE MARK CONSISTS OF STANDARD CHARACTERS WITHOUT CLAIM TO ANY PARTICULAR FONT, STYLE, SIZE, OR COLOR.

CLASS 29—MEATS AND PROCESSED FOODS

FOR SOUPS, MEATS, FROZEN ENTREES CONSISTING PRIMARILY OF MEAT, FISH, POULTRY OR VEGETABLES, SIDE DISHES, NAMELY, PROCESSED VEGETABLES, SOY-BASED SNACK FOODS (U.S. CL. 46).

FIRST USE 2-29-2008; IN COMMERCE 2-29-2008.

CLASS 30—STAPLE FOODS

FOR SAUCES, MARINADES, FROZEN ENTREES CONSISTING PRIMARILY OF PASTA OR RICE, PIZZA, SIDE DISHES, NAMELY, RICE, PASTA SALAD, MACARONI AND CHEESE, COUSCOUS; SALAD DRESSINGS, SEASONINGS, CEREAL-BASED SNACK FOODS, RICE-BASED SNACK FOODS, WHEAT-BASED SNACK FOODS AND CORN-BASED SNACK FOODS (U.S. CL. 46).

FIRST USE 2-29-2008; IN COMMERCE 2-29-2008.

SUBCASTS

THE MARK CONSISTS OF STANDARD CHARACTERS WITHOUT CLAIM TO ANY PARTICULAR FONT, STYLE, SIZE, OR COLOR.

CLASS 20—FURNITURE AND ARTICLES NOT OTHERWISE CLASSIFIED

FOR FIGURINES MADE OF PLASTIC, BONE, IVORY, PLASTER, WOOD, WAX, RESIN, FABRIC; PILLOWS; CHAIR PADS; WINDOW BLINDS; WINDOW SHADES; CLOSET ORGANIZERS COMPRISED OF SHELVES AND RACKS; JEWELRY BOXES NOT OF METAL; SLEEPING BAGS; PLAQUES NOT OF METAL; NON-METAL KEY RINGS; OFFICE FURNITURE; FURNITURE AND UPHOLSTERY FABRICS (U.S. CLS. 2, 13, 22, 25, 32 AND 50).
FIRST USE 8-1-2007; IN COMMERCE 8-1-2007.

CLASS 28—TOYS AND SPORTING GOODS

FOR ACTION SKILL GAMES; AMUSEMENT GAME MACHINES; ARCADE GAMES; ARCADE-TYPE ELECTRONIC EDUCATION VIDEO GAMES; ARCADE-TYPE ELECTRONIC VIDEO GAMES; BACKGAMMON GAME SETS; BADMINTON GAME PLAYING EQUIPMENT; BASKETBALL TABLE TOP GAMES; BILLIARD GAME PLAYING EQUIPMENT; BINGO GAME PLAYING EQUIPMENT; BOARD GAMES; CARD GAMES; COIN-OPERATED VIDEO GAMES; DICE GAMES; DISPOSABLE TICKET SETS FOR PLAYING GAMES OF CHANCE; ELECTRONIC DART GAMES; ELECTRONIC EDUCATIONAL GAME MACHINES FOR CHILDREN; EQUIPMENT SOLD AS A UNIT FOR PLAYING BOARD GAMES; EQUIPMENT SOLD AS A UNIT FOR PLAYING CARD GAMES; EQUIPMENT SOLD AS A UNIT FOR PLAYING A MEMORY GAME; EQUIPMENT SOLD AS A UNIT FOR PLAYING ACTION TYPE TARGET GAMES; FLOOR-STANDING UNITS FOR PLAYING ELECTRONIC GAMES OTHER THAN IN CONJUNCTION WITH A TELEVISION OR COMPUTER; GAME EQUIPMENT, NAMELY, CHIPS; GAME TABLES; GAMING EQUIPMENT, NAMELY, GAME WHEELS; HAND HELD UNIT FOR PLAYING ELECTRONIC GAMES; HAND HELD UNIT FOR PLAYING VIDEO GAMES; HAND-HELD GAMES WITH LIQUID CRYSTAL DISPLAYS; HORIZONTAL PINBALL MACHINE; JAPANESE CHESS; JAPANESE DICE GAMES; KARUTA PLAYING CARDS (JAPANESE CARD GAME); LCD GAME MACHINES; MANIPULATIVE GAMES; NETS FOR BALL GAMES; PADDLE BALL GAMES; PARLOR GAMES; PARTY GAMES; PINBALL-TYPE GAMES; PROMOTIONAL GAME CARDS; RING GAMES; ROLE PLAYING GAMES; STAND ALONE VIDEO GAME MACHINES; TABLETOP UNITS FOR PLAYING ELECTRONIC GAMES OTHER THAN IN CONJUNCTION WITH A TELEVISION OR COMPUTER; TOY, NAMELY, BATTERY-POWERED COMPUTER GAME WITH LCD SCREEN WHICH FEATURES ANIMATION AND SOUND EFFECTS; TRADING CARD GAMES; BABY MULTIPLE ACTIVITY TOYS; BATH TOYS; BATTERY OPERATED ACTION TOYS; CASES FOR TOY STRUCTURES; TOY VEHICLES AND ACCESSORIES THEREFORE; COLLECTIBLE VEHICLES; DIECAST COLLECTIBLE VEHICLES; CASES FOR TOY VEHICLES; CHILDREN'S MULTIPLE ACTIVITY TOYS; CHILDREN'S WIRE CONSTRUCTION AND ART ACTIVITY TOYS; COLLECTABLE TOY FIGURES; ELECTRIC ACTION TOYS; ELECTRONIC LEARNING TOYS; ELECTRONICALLY OPERATED TOY MOTOR VEHICLES; FANTASY CHARACTER TOYS; INFANT TOYS; MECHANICAL TOYS; MINIATURE TOY HELMETS; MODELED TOY FIGURINES;

TOY FIGURINES; MUSICAL TOYS; PLAY MATS FOR USE WITH TOY VEHICLES; PLUSH TOYS; POP UP TOYS; POSITIONAL TOY FIGURES; REMOTE CONTROL TOYS; SAND TOYS; RUBBER CHARACTER TOYS; SQUEEZE TOYS; STACKING TOYS; STUFFED TOY ANIMALS; TOY ACTION FIGURES; TOY ANIMALS AND ACCESSORIES THEREFOR; TOY BOXES; TOY BUILDING BLOCKS; TOY CLOCKS AND WATCHES; TOY CONSTRUCTION SETS; TOY FURNITURE; TOY MASKS; TOY MODEL TRAIN SETS; TOY MODEL CARS; TOY STAMPS; WIND-UP TOYS (U.S. CLS. 22, 23, 38 AND 50).

FIRST USE 8-1-2007; IN COMMERCE 8-1-2007.

3,568,149. URBAN MAPPING, INC., SAN FRANCISCO, CA. SN 77-130,326. PUB. 3-11-2008, FILED 3-13-2007.

GEOMOD

THE MARK CONSISTS OF STANDARD CHARACTERS WITHOUT CLAIM TO ANY PARTICULAR FONT, STYLE, SIZE, OR COLOR.

CLASS 35—ADVERTISING AND BUSINESS

FOR GEOSPATIAL DATA COMPILING AND ANALYZING RELATING TO BUSINESS MANAGEMENT, PREPARING GEOSPATIAL DATA BUSINESS REPORTS (U.S. CLS. 100, 101 AND 102).

FIRST USE 9-30-2007; IN COMMERCE 9-30-2007.

CLASS 42—SCIENTIFIC AND COMPUTER SERVICES

FOR PROVIDING TEMPORARY USE OF ON-LINE NON-DOWNLOADABLE INTERACTIVE SOFTWARE FOR MANAGING, SEARCHING, AND SORTING GEOSPATIAL DATA (U.S. CLS. 100 AND 101).

FIRST USE 9-30-2007; IN COMMERCE 9-30-2007.

CLASS 45—PERSONAL AND LEGAL SERVICES

FOR LICENSING OF INTELLECTUAL PROPERTY, NAMELY, GEOSPATIAL DATA REPORTS TO OTHERS (U.S. CLS. 100 AND 101).

FIRST USE 9-30-2007; IN COMMERCE 9-30-2007.

3,568,160. CARPENTER., JOSEPH L., LAS VEGAS, NV. SN 77-137,273. PUB. 3-18-2008, FILED 3-22-2007.

MYSCHOOL

THE MARK CONSISTS OF STANDARD CHARACTERS WITHOUT CLAIM TO ANY PARTICULAR FONT, STYLE, SIZE, OR COLOR.

CLASS 35—ADVERTISING AND BUSINESS

FOR ADVERTISING SERVICES, NAMELY, ADVERTISING, PROMOTING AND OFFERING INFORMATION ABOUT THE GOODS AND SERVICES OF OTHERS VIA A GLOBAL COMMUNICATION NETWORK; PROVIDING A WEB SITE THAT ENABLES USERS TO POST ITEMS FOR SALE THROUGH ON-LINE CLASSIFIED ADVERTISEMENTS AND MESSAGES (U.S. CLS. 100, 101 AND 102).

FIRST USE 12-8-2008; IN COMMERCE 12-8-2008.

CLASS 38—COMMUNICATION

FOR COMMUNICATIONS SERVICES, NAMELY, PROVIDING ON-LINE CHAT ROOMS AND FORUMS FOR TRANSMISSION OF MESSAGES, PHOTOGRAPHS, INFORMATION AND DATA AMONG COMPUTER USERS IN THE FIELD OF GENERAL INTEREST, INCLUDING AMONG ALUMNI OF VARIOUS EDUCATIONAL INSTITUTIONS; ELECTRONIC TRANSMISSION OF INFORMATION, MESSAGES, DATA, SOUND, IMAGES AND DOCUMENTS AMONG USERS OF COMPUTERS; PROVIDING ON-LINE COMMUNICATIONS LINKS WHICH TRANSFER THE WEBSITE USER TO OTHER LOCAL AND GLOBAL WEB PAGES ELECTRONIC TRANSMISSION OF DATA AND DOCUMENTS AMONG USERS OF COMPUTERS; PROVIDING ACCESS TO DATABASES VIA A GLOBAL COMMUNICATION NETWORK (U.S. CLS. 100, 101 AND 104).

FIRST USE 12-8-2008; IN COMMERCE 12-8-2008.

3,568,161. CARPENTER., JOSEPH L., LAS VEGAS, NV. SN 77-137,274. PUB. 3-18-2008, FILED 3-22-2007.

MYSCHOOL411

THE MARK CONSISTS OF STANDARD CHARACTERS WITHOUT CLAIM TO ANY PARTICULAR FONT, STYLE, SIZE, OR COLOR.

CLASS 35—ADVERTISING AND BUSINESS

FOR ADVERTISING SERVICES, NAMELY, ADVERTISING, PROMOTING AND OFFERING INFORMATION ABOUT THE GOODS AND SERVICES OF OTHERS VIA A GLOBAL COMMUNICATION NETWORK; PROVIDING A WEB SITE THAT ENABLES USERS TO POST ITEMS FOR SALE THROUGH ON-LINE CLASSIFIED ADVERTISEMENTS AND MESSAGES (U.S. CLS. 100, 101 AND 102).

FIRST USE 12-8-2008; IN COMMERCE 12-8-2008.

CLASS 38—COMMUNICATION

FOR COMMUNICATIONS SERVICES, NAMELY, PROVIDING ON-LINE CHAT ROOMS AND FORUMS FOR TRANSMISSION OF MESSAGES, PHOTOGRAPHS, INFORMATION AND DATA AMONG COMPUTER USERS IN THE FIELD OF GENERAL INTEREST, INCLUDING AMONG ALUMNI OF VARIOUS EDUCATIONAL INSTITUTIONS; ELECTRONIC TRANSMISSION OF INFORMATION, MESSAGES, DATA, SOUND, IMAGES AND DOCUMENTS AMONG USERS OF COMPUTERS; PROVIDING ON-LINE COMMUNICATIONS LINKS WHICH TRANSFER THE WEBSITE USER TO OTHER LOCAL AND GLOBAL WEB PAGES ELECTRONIC TRANSMISSION OF DATA AND DOCUMENTS AMONG USERS OF COMPUTERS; PROVIDING ACCESS TO DATABASES VIA A GLOBAL COMMUNICATION NETWORK (U.S. CLS. 100, 101 AND 104).

FIRST USE 12-8-2008; IN COMMERCE 12-8-2008.

3,568,165. WILLIAMS, VENUS, NEW YORK, NY. SN 77-140,698. PUB. 2-19-2008, FILED 3-26-2007.

3,568,192. STERIS INC., TEMECULA, CA. SN 77-169,965. PUB. 3-11-2008, FILED 5-1-2007.

Eleven by Venus Williams

THE MARK CONSISTS OF STANDARD CHARACTERS WITHOUT CLAIM TO ANY PARTICULAR FONT, STYLE, SIZE, OR COLOR.

THE NAME(S), PORTRAIT(S), AND/OR SIGNATURE(S) SHOWN IN THE MARK IDENTIFIES VENUS WILLIAMS, WHOSE CONSENT(S) TO REGISTER IS SUBMITTED.

CLASS 9—ELECTRICAL AND SCIENTIFIC APPARATUS

FOR SUNGLASSES (U.S. CLS. 21, 23, 26, 36 AND 38). FIRST USE 11-15-2007; IN COMMERCE 11-15-2007.

CLASS 14—JEWELRY

FOR JEWELRY, NECKLACES, EARRINGS, BRACELETS BEING JEWELRY (U.S. CLS. 2, 27, 28 AND 50). FIRST USE 11-15-2007; IN COMMERCE 11-15-2007.

CLASS 25—CLOTHING

FOR PANTS, JEANS, SHIRTS, SKIRTS, SHORTS, DRESSES, JACKETS, OUTERWEAR IN THE NATURE OF PARKAS AND RAINCOATS, COATS, FOOTWEAR, TENNIS SHOES, SNEAKERS, HEADWEAR, SOCKS, TRACKSUITS, BRAS (U.S. CLS. 22 AND 39). FIRST USE 11-15-2007; IN COMMERCE 11-15-2007.

3,568,180. ALEXANDRIA REAL ESTATE EQUITIES, INC., PASADENA, CA. SN 77-157,040. PUB. 3-18-2008, FILED 4-15-2007.

ALEXANDRIA TECHNOLOGY SQUARE

THE MARK CONSISTS OF STANDARD CHARACTERS WITHOUT CLAIM TO ANY PARTICULAR FONT, STYLE, SIZE, OR COLOR.

OWNER OF U.S. REG. NOS. 2,300,322 AND 2,300,323.

CLASS 35—ADVERTISING AND BUSINESS

FOR BUSINESS MANAGEMENT AND CONSULTATION SERVICES; RENTAL AND LEASING OF OFFICE MACHINERY AND EQUIPMENT (U.S. CLS. 100, 101 AND 102). FIRST USE 6-0-2006; IN COMMERCE 6-0-2006.

CLASS 36—INSURANCE AND FINANCIAL

FOR REAL ESTATE SERVICES, NAMELY, REAL ESTATE ACQUISITION, RENTAL, LEASING AND MANAGEMENT (U.S. CLS. 100, 101 AND 102). FIRST USE 6-0-2006; IN COMMERCE 6-0-2006.

PROCONNECT

THE MARK CONSISTS OF STANDARD CHARACTERS WITHOUT CLAIM TO ANY PARTICULAR FONT, STYLE, SIZE, OR COLOR.

CLASS 37—CONSTRUCTION AND REPAIR

FOR TECHNICAL SUPPORT SERVICES, NAMELY, PROVIDING PRIORITY TECHNICAL ADVICE TO CUSTOMERS BY TELEPHONE IN THE FIELD OF THE MAINTENANCE OF DECONTAMINATION EQUIPMENT AND PRODUCTS; ONLINE MAINTENANCE MONITORING SERVICES, NAMELY, REMOTE MONITORING OF THE REPAIR AND MAINTENANCE OF CUSTOMER'S STERILIZATION EQUIPMENT AND PRODUCTS; AND PROVIDING MAINTENANCE INFORMATION TO CUSTOMERS ABOUT THEIR EQUIPMENT AND MAINTENANCE HISTORY THROUGH A CUSTOMER PORTAL ON THE INTERNET (U.S. CLS. 100, 103 AND 106). FIRST USE 4-1-2007; IN COMMERCE 4-1-2007.

CLASS 42—SCIENTIFIC AND COMPUTER SERVICES

FOR TECHNICAL SUPPORT SERVICE, NAMELY, PROVIDING PRIORITY TECHNICAL ADVICE TO CUSTOMERS BY TELEPHONE IN THE FIELD OF THE OPERATION OF DECONTAMINATION EQUIPMENT AND PRODUCTS FOR SCIENTIFIC USE (U.S. CLS. 100 AND 101). FIRST USE 4-1-2007; IN COMMERCE 4-1-2007.

3,568,210. MICROSOFT CORPORATION, REDMOND, WA. SN 77-181,786. PUB. 3-11-2008, FILED 5-15-2007.

POPFLY

THE MARK CONSISTS OF STANDARD CHARACTERS WITHOUT CLAIM TO ANY PARTICULAR FONT, STYLE, SIZE, OR COLOR.

CLASS 9—ELECTRICAL AND SCIENTIFIC APPARATUS

FOR COMPUTER SOFTWARE THAT SEARCHES, ANALYZES, AND COMPILES INFORMATION FROM MORE THAN ONE SOURCE INTO AN INTEGRATED DISPLAY; COMPUTER SOFTWARE FOR BUILDING AND DEVELOPING WEBSITES AND WEB SOFTWARE COMPONENTS (U.S. CLS. 21, 23, 26, 36 AND 38). FIRST USE 5-0-2007; IN COMMERCE 5-0-2007.

CLASS 42—SCIENTIFIC AND COMPUTER SERVICES

FOR COMPUTER SOFTWARE DEVELOPMENT AND PROGRAMMING SERVICES; COMPUTER SERVICES, NAMELY, PROVIDING ONLINE NON-DOWNLOADABLE SOFTWARE DEVELOPMENT TOOLS TO ENABLE USERS TO CREATE, DESIGN, SAVE, AND SHARE COMPUTER SOFTWARE APPLICATIONS; COMPUTER SERVICES, NAMELY, HOSTING AND MAINTAINING AN ONLINE WEBSITE FOR OTHERS TO VIEW SIMULTANEOUS INFORMATION FROM OTHER WEBSITES; AND PROVIDING A WEBSITE THAT FEATURES INFORMATION IN THE FIELD OF COMPUTER TECHNOLOGY AND PROGRAMMING (U.S. CLS. 100 AND 101).

FIRST USE 5-0-2007; IN COMMERCE 5-0-2007.

3,568,231. THE PROCTER & GAMBLE COMPANY, CINCINNATI, OH. SN 77-199,552. PUB. 8-5-2008, FILED 6-6-2007.

SWASH

THE MARK CONSISTS OF STANDARD CHARACTERS WITHOUT CLAIM TO ANY PARTICULAR FONT, STYLE, SIZE, OR COLOR.

CLASS 1—CHEMICALS

FOR CHEMICAL PREPARATIONS USED IN DE-WRINKLING CLOTHING AND FABRICS, UPHOLSTERY AND CARPETS (U.S. CLS. 1, 5, 6, 10, 26 AND 46).

FIRST USE 8-27-2007; IN COMMERCE 8-27-2007.

CLASS 3—COSMETICS AND CLEANING PREPARATIONS

FOR PENS, SPRAYS, WIPES AND DRYER SHEETS ALL CONTAINING CLOTHING AND FABRIC STAIN-REMOVING PREPARATIONS; PENS, SPRAYS, WIPES AND DRYER SHEETS ALL CONTAINING CLOTHING AND FABRIC DE-WRINKLING PREPARATIONS; PENS, SPRAYS, WIPES AND DRYER SHEETS ALL CONTAINING CLOTHING AND FABRIC ANTI-STATIC PREPARATIONS; CHEMICAL PREPARATIONS USED IN REMOVING STAINS AND REDUCING STATIC IN CLOTHING, FABRICS, UPHOLSTERY AND CARPETS (U.S. CLS. 1, 4, 6, 50, 51 AND 52).

FIRST USE 8-27-2007; IN COMMERCE 8-27-2007.

CLASS 5—PHARMACEUTICALS

FOR PENS, SPRAYS, WIPES AND DRYER SHEETS ALL CONTAINING CLOTHING AND FABRIC DEODORIZING PREPARATIONS; CHEMICAL PREPARATIONS USED IN DEODORIZING CLOTHING, FABRICS, UPHOLSTERY AND CARPETS (U.S. CLS. 6, 18, 44, 46, 51 AND 52).

FIRST USE 8-27-2007; IN COMMERCE 8-27-2007.

CLASS 21—HOUSEWARES AND GLASS

FOR LINT ROLLERS AND SCENT-DEPOSITING LINT ROLLERS (U.S. CLS. 2, 13, 23, 29, 30, 33, 40 AND 50).

FIRST USE 8-27-2007; IN COMMERCE 8-27-2007.

3,568,216. TOTAL SYNERGY PTY LTD, NORTH SYDNEY, AUSTRALIA. SN 77-186,340. PUB. 1-1-2008, FILED 5-21-2007.



THE MARK CONSISTS OF THE SHADOW OF A SERIES OF THREE INTERLOCKED RINGS ABOVE THE WORDING "TOTAL SYNERGY".

CLASS 9—ELECTRICAL AND SCIENTIFIC APPARATUS

FOR COMPUTER SOFTWARE AND COMPUTER PROGRAMMES FOR ARCHITECTS, ENGINEERS, AND THE CONSTRUCTION INDUSTRY FOR PRACTICE MANAGEMENT, DATABASE MANAGEMENT, CLIENT MANAGEMENT, PROJECT ACCOUNTING AND MANAGEMENT, DOCUMENT MANAGEMENT, PROJECT DEVELOPMENT AND COST ANALYSIS (U.S. CLS. 21, 23, 26, 36 AND 38).

FIRST USE 11-26-2008; IN COMMERCE 11-26-2008.

3,568,235. WOLFGANG CANDY COMPANY, INC., YORK, PA. SN 77-205,775. PUB. 1-1-2008, FILED 6-14-2007.

DAS SWEETEN HAUS

THE MARK CONSISTS OF STANDARD CHARACTERS WITHOUT CLAIM TO ANY PARTICULAR FONT, STYLE, SIZE, OR COLOR.

NO CLAIM IS MADE TO THE EXCLUSIVE RIGHT TO USE "SWEETEN", APART FROM THE MARK AS SHOWN.

THE ENGLISH TRANSLATION OF "DAS SWEETEN HAUS" IS THE SWEET HOUSE.

CLASS 42—SCIENTIFIC AND COMPUTER SERVICES

FOR DESIGN, DEVELOPMENT, INSTALLATION, UPDATE, MAINTENANCE OF COMPUTER SOFTWARE AIMED AT ARCHITECTS, ENGINEERS AND THE CONSTRUCTION INDUSTRY; TECHNICAL SUPPORT SERVICES, NAMELY, TROUBLESHOOTING OF COMPUTER SOFTWARE PROBLEMS (U.S. CLS. 100 AND 101).

FIRST USE 11-26-2008; IN COMMERCE 11-26-2008.

CLASS 30—STAPLE FOODS

FOR CANDY, COOKIES AND COOKIE DOUGH (U.S. CL. 46).
FIRST USE 1-1-1988; IN COMMERCE 1-1-1988.

CLASS 35—ADVERTISING AND BUSINESS

FOR RETAIL STORE SERVICES FEATURING CANDY, NUTS, MEATS AND GIFTS (U.S. CLS. 100, 101 AND 102).
FIRST USE 1-1-1988; IN COMMERCE 1-1-1988.

CLASS 18—LEATHER GOODS

FOR PET CLOTHING (U.S. CLS. 1, 2, 3, 22 AND 41).
FIRST USE 10-0-2006; IN COMMERCE 10-0-2006.

CLASS 21—HOUSEWARES AND GLASS

FOR PET FEEDING DISHES, NAMELY, DOG BOWLS (U.S. CLS. 2, 13, 23, 29, 30, 33, 40 AND 50).
FIRST USE 10-0-2006; IN COMMERCE 10-0-2006.

3,568,239. KW INTELLECTUAL PROPERTIES, INC., POLK CITY, FL. SN 77-214,424. PUB. 1-1-2008, FILED 6-25-2007.

3,568,242. ELEME MEDICAL INC., MERRIMACK, NH. SN 77-217,643. PUB. 1-1-2008, FILED 6-28-2007.

THE WIZARD OF ORLAMPA

THE MARK CONSISTS OF STANDARD CHARACTERS WITHOUT CLAIM TO ANY PARTICULAR FONT, STYLE, SIZE, OR COLOR.

CLASS 25—CLOTHING

FOR CLOTHING, NAMELY, SHIRTS, CAPS, HATS (U.S. CLS. 22 AND 39).
FIRST USE 9-18-2008; IN COMMERCE 9-18-2008.

CLASS 41—EDUCATION AND ENTERTAINMENT

FOR PRODUCTION AND PRESENTATION OF TELEVISION PROGRAMS; PRODUCTION AND PRESENTATION OF SOUND AND VIDEO RECORDINGS; PRODUCTION OF ENTERTAINMENT SHOWS FOR DISTRIBUTION VIA TELEVISION, CABLE, SATELLITE, AUDIO AND VIDEO MEDIA AND ELECTRONIC MEANS; ENTERTAINMENT SERVICES IN THE NATURE OF A TELEVISION SERIES IN THE REALITY GENRE (U.S. CLS. 100, 101 AND 107).
FIRST USE 3-6-2008; IN COMMERCE 3-6-2008.

3,568,240. DLJJ & ASSOCIATES, LLC, BEVERLY HILLS, CA. SN 77-214,980. PUB. 3-18-2008, FILED 6-25-2007.



THE MARK CONSISTS OF THE STYLIZED LETTER "P", WHICH FORMS THE NOSE OF AND A RING AROUND THE LEFT EYE OF A PUPPY.

ELEME MEDICAL

THE MARK CONSISTS OF STANDARD CHARACTERS WITHOUT CLAIM TO ANY PARTICULAR FONT, STYLE, SIZE, OR COLOR.

NO CLAIM IS MADE TO THE EXCLUSIVE RIGHT TO USE "MEDICAL", APART FROM THE MARK AS SHOWN.

CLASS 10—MEDICAL APPARATUS

FOR APPARATUS FOR MEDICAL PURPOSES, NAMELY, LASER FOR MEDICAL AND AESTHETIC SKIN TREATMENTS, AND CELLULITE TREATMENT, REDUCTION, AND ELIMINATION (U.S. CLS. 26, 39 AND 44).
FIRST USE 10-1-2007; IN COMMERCE 5-14-2008.

CLASS 44—MEDICAL, BEAUTY AND AGRICULTURAL SERVICES

FOR HEALTH SPA SERVICES, NAMELY, COSMETIC BODY CARE SERVICES (U.S. CLS. 100 AND 101).
FIRST USE 10-1-2007; IN COMMERCE 3-17-2008.

3,568,251. MYMENU CANADA INC., KITCHENER, ONTARIO, CANADA. SN 77-226,189. PUB. 2-26-2008, FILED 7-10-2007.

MYMENUMSTORES.COM

THE MARK CONSISTS OF STANDARD CHARACTERS WITHOUT CLAIM TO ANY PARTICULAR FONT, STYLE, SIZE, OR COLOR.

CLASS 29—MEATS AND PROCESSED FOODS

FOR SEAFOOD, MEATS; PREPARED MEATS; PROCESSED MEATS; PREPARED SEAFOOD; PROCESSED SEAFOOD; FROZEN, PREPARED AND PACKAGED MEALS CONSISTING PRIMARILY OF MEAT, FISH, SEAFOOD, POULTRY OR VEGETABLES; BREADED VEGETABLES; STUFFED POTATOES; BATTERED CHEESE STICKS; CHILI; SCALLOPED POTATOES; PROCESSED FRUITS; PROCESSED VEGETABLES; PROCESSED POTATOES; CHEESE DIPS; CABBAGE ROLLS; SOUPS; PROCESSED VEGETABLES, NAMELY, ZUCCHINI STICKS; ONION RINGS; FRUIT BARS, NAMELY, PROCESSED FRUIT BASED FOOD BARS (U.S. CL. 46).
FIRST USE 8-20-2008; IN COMMERCE 8-20-2008.

CLASS 30—STAPLE FOODS

FOR FROZEN, PREPARED AND PACKAGED MEALS CONSISTING PRIMARILY OF PASTA OR RICE; PIZZA; POT STICKERS; PIZZA DOUGH SNACKS FILLED PRIMARILY WITH MEAT, VEGETABLES, CHEESE AND/OR SPICES; SPRING ROLLS; EGG ROLLS; LASAGNA; SHEPHERD PIES; MEAT PIES; CHICKEN PIE; MACARONI AND CHEESE; CANNELLONI; QUESADILLAS; BREAKFAST EGGS OR MEAT WRAPPED IN A TORTILLA; BREAD; GARLIC BREAD; QUICHE; MEAT STUFFED PASTRIES; CREAM PUFFS; PIES; APPLE CRISP; CAKES; BROWNIES; TIRAMISU; CRÈME BRULÉ; PASTA SALAD; FRUIT BARS, NAMELY, GRAIN-BASED FOOD FEATURING FRUIT; DIPPING SAUCES; SAUCES; HORSERADISH (U.S. CL. 46).
FIRST USE 8-20-2008; IN COMMERCE 8-20-2008.

CLASS 35—ADVERTISING AND BUSINESS

FOR ONLINE AND TRADITIONAL RETAIL STORE SERVICES FEATURING FOOD PRODUCTS (U.S. CLS. 100, 101 AND 102).
FIRST USE 5-30-2008; IN COMMERCE 5-30-2008.

CLASS 3—COSMETICS AND CLEANING PREPARATIONS

FOR PENS, SPRAYS, WIPES AND DRYER SHEETS ALL CONTAINING CLOTHING AND FABRIC STAIN-REMOVING PREPARATIONS; PENS, SPRAYS, WIPES AND DRYER SHEETS ALL CONTAINING CLOTHING AND FABRIC DE-WRINKLING PREPARATIONS; PENS, SPRAYS, WIPES AND DRYER SHEETS ALL CONTAINING CLOTHING AND FABRIC ANTI-STATIC PREPARATIONS; CHEMICAL PREPARATIONS USED IN REMOVING STAINS AND REDUCING STATIC IN CLOTHING, FABRICS, UPHOLSTERY AND CARPETS (U.S. CLS. 1, 4, 6, 50, 51 AND 52).
FIRST USE 8-27-2007; IN COMMERCE 8-27-2007.

CLASS 5—PHARMACEUTICALS

FOR PENS, SPRAYS, WIPES AND DRYER SHEETS ALL CONTAINING CLOTHING AND FABRIC DEODORIZING PREPARATIONS; CHEMICAL PREPARATIONS USED IN DEODORIZING CLOTHING, FABRICS, UPHOLSTERY AND CARPETS (U.S. CLS. 6, 18, 44, 46, 51 AND 52).
FIRST USE 8-27-2007; IN COMMERCE 8-27-2007.

CLASS 21—HOUSEWARES AND GLASS

FOR LINT ROLLERS AND SCENT-DEPOSITING LINT ROLLERS (U.S. CLS. 2, 13, 23, 29, 30, 33, 40 AND 50).
FIRST USE 8-27-2007; IN COMMERCE 8-27-2007.

3,568,269. ASSOCIATION OF INSURANCE AND REINSURANCE RUN-OFF COMPANIES, DBA AIRROC, ALPHARETTA, GA. SN 77-238,744. PUB. 8-12-2008, FILED 7-25-2007.

3,568,261. THE PROCTER & GAMBLE COMPANY, CINCINNATI, OH. SN 77-232,904. PUB. 7-29-2008, FILED 7-18-2007.

WE SEEK SOLUTIONS

THE MARK CONSISTS OF THE WORD "SWASH" WITH THE WORD "TIDE" SUPERIMPOSED ON 3 RADIAL SYMMETRICAL BANDS, WITHIN THE LETTER "A" IN "SWASH".

CLASS 1—CHEMICALS

FOR CHEMICAL PREPARATIONS USED IN DE-WRINKLING CLOTHING AND FABRICS, UPHOLSTERY AND CARPETS (U.S. CLS. 1, 5, 6, 10, 26 AND 46).
FIRST USE 8-27-2007; IN COMMERCE 8-27-2007.

THE MARK CONSISTS OF STANDARD CHARACTERS WITHOUT CLAIM TO ANY PARTICULAR FONT, STYLE, SIZE, OR COLOR.

CLASS 35—ADVERTISING AND BUSINESS

FOR ASSOCIATION SERVICES, NAMELY, PROMOTING THE INTERESTS OF INSURANCE AND REINSURANCE RUN-OFF COMPANIES (U.S. CLS. 100, 101 AND 102).
FIRST USE 10-31-2006; IN COMMERCE 10-31-2006.

CLASS 41—EDUCATION AND ENTERTAINMENT

FOR EDUCATIONAL SERVICES, NAMELY, PROVIDING SEMINARS AND WORKSHOPS IN THE FIELDS OF INSURANCE AND REINSURANCE TO INSURANCE AND REINSURANCE RUN-OFF COMPANIES (U.S. CLS. 100, 101 AND 107).
FIRST USE 10-20-2008; IN COMMERCE 10-20-2008.

3,568,272. ALLIES IN HEALTHCARE PUBLISHING, LLC, ST. LOUIS, MO. SN 77-241,078. PUB. 5-27-2008, FILED 7-27-2007.



NO CLAIM IS MADE TO THE EXCLUSIVE RIGHT TO USE "HEALTHCARE", APART FROM THE MARK AS SHOWN.

THE MARK CONSISTS OF THE STYLIZED WORDING "ALLIES IN HEALTHCARE" ABOVE THE STYLIZED WORDING "OPTIMAL HEALTHCARE & PARITY FOR ALL", HAVING A HORIZONTAL LINE BETWEEN THE SETS OF WORDING, AND HAVING THE DESIGN OF FOUR INTERCONNECTED HANDS ABOVE A CARICATURE OF A EARTHLIKE OBJECT TO THE LEFT OF THE WORDING.

CLASS 16—PAPER GOODS AND PRINTED MATTER

FOR REFERENCE GUIDES CONSISTING OF A CALENDAR, DAILY PLANNER, MEDICAL GLOSSARY, AND OTHER FILLABLE FORMS USED TO DOCUMENT AND STORE MEDICAL AND HEALTH INFORMATION, APPOINTMENTS, AND EMERGENCY CONTACT INFORMATION (U.S. CLS. 2, 5, 22, 23, 29, 37, 38 AND 50).
FIRST USE 8-0-2007; IN COMMERCE 8-0-2007.

CLASS 44—MEDICAL, BEAUTY AND AGRICULTURAL SERVICES

FOR PROVIDING A WEBSITE WITH LINKS TO OTHER WEBSITES FEATURING HEALTH, MEDICAL, AND WELLNESS INFORMATION; PROVIDING A WEBSITE FEATURING HEALTH, MEDICAL, AND WELLNESS INFORMATION (U.S. CLS. 100 AND 101).
FIRST USE 8-0-2007; IN COMMERCE 8-0-2007.

3,568,282. BELFOR USA GROUP INC., BIRMINGHAM, MI. SN 77-248,937. PUB. 1-29-2008, FILED 8-7-2007.



OWNER OF U.S. REG. NO. 2,559,315.

NO CLAIM IS MADE TO THE EXCLUSIVE RIGHT TO USE "ENVIRONMENTAL", APART FROM THE MARK AS SHOWN.

THE MARK CONSISTS OF THE WORD "BELFOR" ABOVE THE WORD "ENVIRONMENTAL" AND TO THE LEFT OF A DESIGN CONSISTING OF A CIRCLE IN BETWEEN TWO ARC DESIGNS.

CLASS 39—TRANSPORTATION AND STORAGE

FOR TRANSPORTATION OF MEDICAL WASTE AND SPECIAL WASTE; TRUCK TRANSPORT (U.S. CLS. 100 AND 105).
FIRST USE 5-18-2007; IN COMMERCE 12-2-2008.

CLASS 42—SCIENTIFIC AND COMPUTER SERVICES

FOR CHEMICAL, BIOCHEMICAL, BIOLOGICAL AND BACTERIOLOGICAL RESEARCH AND ANALYSIS; ENVIRONMENTAL TESTING AND INSPECTION SERVICES; EVALUATION AND TESTING OF REAL ESTATE FOR THE PRESENCE OF HAZARDOUS MATERIAL (U.S. CLS. 100 AND 101).
FIRST USE 5-18-2007; IN COMMERCE 12-2-2008.

3,568,283. ACTION CANDY COMPANY LTD, CONCORD, ONTARIO, CANADA. SN 77-250,102. PUB. 2-12-2008, FILED 8-8-2007.

BONUS!

THE MARK CONSISTS OF STANDARD CHARACTERS WITHOUT CLAIM TO ANY PARTICULAR FONT, STYLE, SIZE, OR COLOR.

CLASS 5—PHARMACEUTICALS

FOR MEDICATED GUM FOR PROVIDING ENERGY; NUTRITIONAL ENERGY BARS FOR USE AS A MEAL SUBSTITUTE; MEAL REPLACEMENT BARS; MEAL REPLACEMENT DRINKS; MEAL REPLACEMENT POWDERS (U.S. CLS. 6, 18, 44, 46, 51 AND 52).
FIRST USE 2-0-2008; IN COMMERCE 2-0-2008.

CLASS 30—STAPLE FOODS

FOR CHEWING GUM; CANDY MINTS; LOLLIPOPS; GREEN TEA (U.S. CL. 46).
FIRST USE 2-0-2008; IN COMMERCE 2-0-2008.

3,568,284. IMMUNOTEC INC., VAUDREUIL-DORIONQUEBEC, CANADA. SN 77-250,241. PUB. 2-19-2008, FILED 8-8-2007.

IMMUNOTEC

THE MARK CONSISTS OF STANDARD CHARACTERS WITHOUT CLAIM TO ANY PARTICULAR FONT, STYLE, SIZE, OR COLOR.

CLASS 3—COSMETICS AND CLEANING PREPARATIONS

FOR SKIN CREAM (U.S. CLS. 1, 4, 6, 50, 51 AND 52).
FIRST USE 5-28-2007; IN COMMERCE 5-28-2007.

CLASS 5—PHARMACEUTICALS

FOR APPETITE SUPPRESSANTS; DIETARY AND NUTRITIONAL SUPPLEMENTS IN LIQUID, POWDER OR CAPSULE FORM; HERBAL SUPPLEMENTS; DIETARY AND NUTRITIONAL SUPPLEMENTS, NAMELY, HERBAL TONICS AND BIOACTIVE MILK PEPTIDES; WHEY PROTEIN DIETARY AND NUTRITIONAL SUPPLEMENTS (U.S. CLS. 6, 18, 44, 46, 51 AND 52).
FIRST USE 5-28-2007; IN COMMERCE 5-28-2007.

CLASS 29—MEATS AND PROCESSED FOODS

FOR NATURAL DAIRY PRODUCTS AND ANY DERIVATIVES THEREOF, NAMELY, WHEY, WHEY PROTEIN CONCENTRATE, WHEY-BASED FOOD BEVERAGES; MILK DERIVED PROTEIN PRODUCTS, NAMELY, MILK DERIVED PROTEIN USED FOR A FOOD FILLER OR ADDITIVE, AND MILK PROTEIN ISOLATE, ALL IN LIQUID, POWDER OR CAPSULE FORM (U.S. CL. 46).
FIRST USE 5-28-2007; IN COMMERCE 5-28-2007.

CLASS 32—LIGHT BEVERAGES

FOR HERBAL ENERGY DRINKS; WHEY-BASED POWDERS FOR USE IN MAKING BEVERAGES (U.S. CLS. 45, 46 AND 48).
FIRST USE 5-28-2007; IN COMMERCE 5-28-2007.

3,568,290. WEATHERGUARD BUILDING PRODUCTS, INC., WEST PALM BEACH, FL. SN 77-255,644. PUB. 1-15-2008, FILED 8-15-2007.

COMMANDO

THE MARK CONSISTS OF STANDARD CHARACTERS WITHOUT CLAIM TO ANY PARTICULAR FONT, STYLE, SIZE, OR COLOR.

CLASS 6—METAL GOODS

FOR INTERIOR METAL SHUTTERS; METAL ROLL SHUTTERS; METAL ROLLING WINDOW SHUTTERS; METAL WINDOW SHUTTERS; METALLIC DOORS, WINDOWS, SHUTTERS, SLATTED SHUTTERS (U.S. CLS. 2, 12, 13, 14, 23, 25 AND 30).
FIRST USE 6-1-2002; IN COMMERCE 6-1-2002.

CLASS 19—NON-METALLIC BUILDING MATERIALS

FOR NON-METAL EXTERIOR BUILDING SHUTTERS; NON-METAL EXTERIOR ROLL SHUTTERS; NON-METAL ROLL SHUTTERS; NON-METAL WINDOW SHUTTERS (U.S. CLS. 1, 12, 33 AND 50).
FIRST USE 6-1-2002; IN COMMERCE 6-1-2002.

3,568,292. BLACK BUFFALO ARTWORKS, INC., NEW YORK, NY. SN 77-257,664. PUB. 3-4-2008, FILED 8-17-2007.

BLACK BUFFALO ARTWORKS

THE MARK CONSISTS OF STANDARD CHARACTERS WITHOUT CLAIM TO ANY PARTICULAR FONT, STYLE, SIZE, OR COLOR.

NO CLAIM IS MADE TO THE EXCLUSIVE RIGHT TO USE "ARTWORKS", APART FROM THE MARK AS SHOWN.

CLASS 35—ADVERTISING AND BUSINESS

FOR WHOLESALE AND RETAIL STORE AND ONLINE RETAIL STORE SERVICES FEATURING ARTWORK AND REPRODUCTIONS OF ARTWORK (U.S. CLS. 100, 101 AND 102).
FIRST USE 4-21-2008; IN COMMERCE 11-18-2008.

CLASS 40—MATERIAL TREATMENT

FOR REPRODUCTION OF ARTWORK FOR OTHERS (U.S. CLS. 100, 103 AND 106).
FIRST USE 4-21-2008; IN COMMERCE 11-18-2008.

3,568,301. INTERNATIONAL RAW MATERIALS LTD., PHILADELPHIA, PA. SN 77-262,538. PUB. 2-19-2008, FILED 8-23-2007.

EXCELLENCE IS ALWAYS IN SEASON

THE MARK CONSISTS OF STANDARD CHARACTERS WITHOUT CLAIM TO ANY PARTICULAR FONT, STYLE, SIZE, OR COLOR.

CLASS 1—CHEMICALS

FOR CHEMICAL FERTILIZERS FOR DOMESTIC AND AGRICULTURAL USE (U.S. CLS. 1, 5, 6, 10, 26 AND 46).
FIRST USE 5-17-2007; IN COMMERCE 5-17-2007.

CLASS 35—ADVERTISING AND BUSINESS

FOR ONLINE DISTRIBUTORSHIP SERVICES FEATURING CHEMICAL AND ORGANIC FERTILIZERS (U.S. CLS. 100, 101 AND 102).
FIRST USE 1-6-2006; IN COMMERCE 1-6-2006.

3,568,307. OLIVE OIL IMPORTS, LLC, RED BANK, NJ. SN 77-266,439. PUB. 3-4-2008, FILED 8-28-2007.

CARTER & CAVERO

THE MARK CONSISTS OF STANDARD CHARACTERS WITHOUT CLAIM TO ANY PARTICULAR FONT, STYLE, SIZE, OR COLOR.

CLASS 29—MEATS AND PROCESSED FOODS

FOR OLIVE OIL AND PROCESSED OLIVES (U.S. CL. 46).
FIRST USE 11-17-2007; IN COMMERCE 11-17-2007.

CLASS 30—STAPLE FOODS

FOR VINEGAR (U.S. CL. 46).
FIRST USE 11-17-2007; IN COMMERCE 11-17-2007.

3,568,308. OLIVE OIL IMPORTS, LLC, RED BANK, NJ. SN 77-266,449. PUB. 3-4-2008, FILED 8-28-2007.

CARTER & CAVERO

THE MARK CONSISTS OF STANDARD CHARACTERS WITHOUT CLAIM TO ANY PARTICULAR FONT, STYLE, SIZE, OR COLOR.

CLASS 3—COSMETICS AND CLEANING PREPARATIONS

FOR SKIN, BODY, HAND AND FACE CREAMS, LOTIONS FOR SKIN, BODY, HANDS AND FACE, BODY OILS, FACIAL SCRUBS, BATH AND FACE SOAPS, LIP BALMS, ALL MADE WITH OLIVE OILS (U.S. CLS. 1, 4, 6, 50, 51 AND 52).
FIRST USE 11-17-2007; IN COMMERCE 11-17-2007.

CLASS 35—ADVERTISING AND BUSINESS

FOR RETAIL STORE SERVICES IN THE FIELD OF OLIVE OIL, OLIVES, OLIVE OIL RELATED PRODUCTS, AND PERSONAL CARE PRODUCTS MADE WITH OLIVE OIL AND VINEGAR; WHOLESALE SERVICES IN THE FIELD OF OLIVE OIL, OLIVES, OLIVE OIL RELATED PRODUCTS, AND PERSONAL CARE PRODUCTS MADE WITH OLIVE OIL AND VINEGAR (U.S. CLS. 100, 101 AND 102).
FIRST USE 11-17-2007; IN COMMERCE 11-17-2007.

3,568,316. KNOWLEDGE LEARNING CORPORATION, PORTLAND, OR. SN 77-271,345. PUB. 3-25-2008, FILED 9-4-2007.



THE MARK CONSISTS OF THE LETTER "C" WITH A FIGURE TO THE RIGHT AND THE LETTERS "C", "C", "L", "C" ARRANGED VERTICALLY ADJACENT THERETO.

CLASS 35—ADVERTISING AND BUSINESS

FOR BUSINESS CONSULTING SERVICES IN THE FIELD OF OPERATING AND MANAGING CHILD CARE CENTERS; CONDUCTING COST ANALYSIS FOR OTHERS IN THE AREA OF CHILD CARE CENTERS; BUSINESS MANAGEMENT OF CHILD CARE CENTERS FOR OTHERS; EMPLOYMENT STAFFING SERVICES; BUSINESS AND BUSINESS PERSONNEL RELOCATION CONSULTING SERVICES (U.S. CLS. 100, 101 AND 102).
FIRST USE 8-23-2007; IN COMMERCE 8-23-2007.

CLASS 41—EDUCATION AND ENTERTAINMENT

FOR EDUCATIONAL SERVICES, NAMELY, PROVIDING COURSES OF INSTRUCTION AND PROGRAMS AT THE PRE-KINDERGARTEN, KINDERGARTEN AND THE ELEMENTARY SCHOOL LEVELS; PROVIDING BEFORE AND AFTER SCHOOL PROGRAMS FOR PRE-KINDERGARTEN, KINDERGARTEN AND ELEMENTARY SCHOOL STUDENTS IN READING, WRITING, SCIENCE, MATH, MUSIC, SPORTS AND ART; RECREATIONAL CAMP SERVICES; EDUCATIONAL SERVICES, NAMELY, PROVIDING WORKSHOPS IN THE FIELDS OF CHILD CARE AND CHILD REARING; DESIGN OF CHILD CARE CENTERS FOR OTHERS, NAMELY, DEVELOPMENT AND DISSEMINATION OF EDUCATIONAL MATERIALS FOR OTHERS IN THE FIELD OF CHILD CARE (U.S. CLS. 100, 101 AND 107).
FIRST USE 8-23-2007; IN COMMERCE 8-23-2007.

CLASS 43—HOTEL AND RESTAURANT SERVICES

FOR CHILD CARE SERVICES; CHILD CARE SERVICES, NAMELY, BEFORE AND AFTER SCHOOL, EXTENDED, EMERGENCY, VACATION, AND HOLIDAY CHILD CARE AND DAY CARE CENTER SERVICES (U.S. CLS. 100 AND 101).
FIRST USE 8-23-2007; IN COMMERCE 8-23-2007.

3,568,317. QUINTILES TRANSNATIONAL CORP., DURHAM, NC. SN 77-271,620. PUB. 3-18-2008, FILED 9-5-2007.

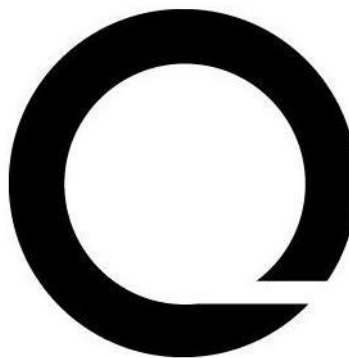

CLASS 35—ADVERTISING AND BUSINESS

FOR COMPUTERIZED DATABASE MANAGEMENT AND DATA PROCESSING SERVICES IN THE FIELDS OF PHARMACEUTICAL, PHARMACOGENOMIC, BIOTECHNICAL AND MEDICAL PRODUCTS AND DEVICES; MANUFACTURERS' AND INDEPENDENT SALES REPRESENTATIVES IN THE FIELDS OF PHARMACEUTICALS, PHARMACOGENOMIC, BIOTECHNICAL, AND MEDICAL PRODUCTS AND DEVICES; MARKETING SERVICES FOR OTHERS, NAMELY, CREATING AND MANAGING PRODUCT SALES AND PRODUCT LAUNCH PROGRAMS IN THE FIELDS OF PHARMACEUTICALS, PHARMACOGENOMIC, BIOTECHNICAL, AND MEDICAL PRODUCTS AND DEVICES; BUSINESS MARKETING CONSULTING SERVICES IN THE FIELDS OF PHARMACEUTICALS, PHARMACOGENOMIC, BIOTECHNICAL, AND MEDICAL PRODUCTS AND DEVICES; MARKET RESEARCH AND ANALYSIS SERVICES IN THE FIELDS OF PHARMACEUTICALS, PHARMACOGENOMIC, BIOTECHNICAL, AND MEDICAL PRODUCTS AND DEVICES; PERSONNEL RECRUITMENT AND PLACEMENT; PROVIDING BUSINESS INFORMATION, NAMELY, INFORMATION USEFUL FOR ACHIEVING AND MAINTAINING REGULATORY APPROVAL AND MARKET INTRODUCTION OF DRUGS, DEVICES AND BIOLOGICS (U.S. CLS. 100, 101 AND 102).
FIRST USE 2-1-1982; IN COMMERCE 2-1-1982.

CLASS 41—EDUCATION AND ENTERTAINMENT

FOR EDUCATIONAL AND TRAINING SERVICES, NAMELY, CONDUCTING TRAINING PROGRAMS, SEMINARS, CLASSES, CONFERENCES AND WORKSHOPS IN THE FIELDS OF HEALTH CARE, HEALTH MANAGEMENT AND DISEASE MANAGEMENT, PHARMACEUTICAL SALES SKILLS, AND PHARMACEUTICAL AND HEALTH PRODUCTS, AND DISTRIBUTING COURSE MATERIALS IN CONNECTION THEREWITH (U.S. CLS. 100, 101 AND 107).

FIRST USE 0-0-2003; IN COMMERCE 0-0-2003.

CLASS 42—SCIENTIFIC AND COMPUTER SERVICES

FOR CLINICAL RESEARCH AND TESTING SERVICES IN THE FIELDS OF PHARMACEUTICALS, PHARMACOGENOMIC, BIOTECHNICAL, AND MEDICAL PRODUCTS AND DEVICES; PRODUCT DEVELOPMENT CONSULTATION IN THE FIELDS OF MEDICAL PRODUCTS AND DEVICES; HEALTHCARE POLICY RESEARCH AND DEVELOPMENT SERVICES; LABORATORY TESTING SERVICES IN THE FIELDS OF PHARMACEUTICAL, PHARMACOGENOMIC, BIOTECHNICAL AND MEDICAL PRODUCTS AND DEVICES; CONSULTANCY PERTAINING TO PHARMACOLOGY AND BIOTECHNICAL RESEARCH; MANAGING, MONITORING AND COORDINATING CLINICAL STUDIES ON HUMAN SUBJECTS FOR OTHERS (U.S. CLS. 100 AND 101).

FIRST USE 0-0-2003; IN COMMERCE 0-0-2003.

CLASS 44—MEDICAL, BEAUTY AND AGRICULTURAL SERVICES

FOR PROVIDING HEALTH, MEDICAL, PHARMACEUTICAL, HEALTH MANAGEMENT AND DISEASE MANAGEMENT INFORMATION TO OTHERS; MEDICAL EVALUATION SERVICES, NAMELY, DEVELOPING AND IMPLEMENTING DISEASE MANAGEMENT AND TREATMENT PROTOCOLS AND PATIENT OUTCOME ANALYSIS SERVICES; CONSULTING SERVICES IN THE FIELDS OF HEALTH CARE, MEDICAL AND PHARMACEUTICALS (U.S. CLS. 100 AND 101).

FIRST USE 7-28-1998; IN COMMERCE 7-28-1998.

CLASS 45—PERSONAL AND LEGAL SERVICES

FOR REGULATORY RESEARCH IN THE PHARMACEUTICAL INDUSTRY, BIOTECHNOLOGY INDUSTRY AND THE MEDICAL AND DIAGNOSTICS INDUSTRY; CONSULTATION SERVICES IN THE FIELD OF COMPLIANCE EVALUATION TO INSURE VALIDITY AND ACCURACY OF REGULATORY SUBMISSIONS TO THE FDA BY LIFE SCIENCES COMPANIES; CONDUCTING REGULATORY AND COMPLIANCE AUDITS FOR OTHERS IN THE FIELDS OF PHARMACEUTICAL, PHARMACOGENOMIC, BIOTECHNICAL AND MEDICAL PRODUCTS AND DEVICES; CONSULTING SERVICES IN THE FIELDS OF REGULATORY AFFAIRS, MANUFACTURING COMPLIANCE AND VALIDATION; PROVIDING REGULATORY INFORMATION AND IMPLEMENTATION SERVICES RELATING TO THE DEVELOPMENT AND VALIDATION OF DRUGS, DEVICES AND BIOLOGICS (U.S. CLS. 100 AND 101).

FIRST USE 8-8-1994; IN COMMERCE 8-8-1994.

3,568,350. V&S VIN & SPRIT AKTIEBOLAG (PUBL), STOCKHOLM, SWEDEN. SN 77-285,774. PUB. 4-1-2008, FILED 9-21-2007.



OWNER OF U.S. REG. NOS. 1,893,279, 3,020,896, AND OTHERS.

THE MARK CONSISTS OF THE TERM "ABSOLUT" WHERE THE "O" IS REPRESENTED BY A BLUE AND WHITE GLOBE DESIGN AND THE REMAINING LETTERS ARE SHOWN IN BLACK.

THE FOREIGN WORDING IN THE MARK TRANSLATES INTO ENGLISH AS "ABSOLUTE."

CLASS 33—WINES AND SPIRITS

FOR ALCOHOLIC BEVERAGES, NAMELY, DISTILLED SPIRITS (U.S. CLS. 47 AND 49).

FIRST USE 2-0-2008; IN COMMERCE 2-0-2008.

CLASS 35—ADVERTISING AND BUSINESS

FOR PROMOTING PUBLIC AWARENESS OF CLIMATE CHANGE, ENVIRONMENT, ENERGY CONSERVATION AND NATURAL RESOURCE PROTECTION ISSUES; PUBLIC ADVOCACY TO PROMOTE AWARENESS OF CLIMATE CHANGE, ENVIRONMENT, ENERGY CONSERVATION AND NATURAL RESOURCE PROTECTION ISSUES; PUBLIC POLICY RESEARCH SERVICES; ORGANIZING AND CONDUCTING VOLUNTEER PROGRAMS AND COMMUNITY SERVICE PROJECTS; AND PROVIDING CONSUMER INFORMATION IN THE FIELDS OF CLIMATE CHANGE, ENVIRONMENT, ENERGY CONSERVATION AND NATURAL RESOURCE PROTECTION ISSUES (U.S. CLS. 100, 101 AND 102).

FIRST USE 2-0-2008; IN COMMERCE 2-0-2008.

3,568,365. LIVING CONSCIOUSLY BY DESIGN, INC., FOXBORO, MA. SN 77-290,457. PUB. 3-11-2008, FILED 9-27-2007.

LIVING CONSCIOUSLY BY DESIGN

THE MARK CONSISTS OF STANDARD CHARACTERS WITHOUT CLAIM TO ANY PARTICULAR FONT, STYLE, SIZE, OR COLOR.

CLASS 9—ELECTRICAL AND SCIENTIFIC APPARATUS

FOR PRE-RECORDED CDS, VIDEO TAPES, LASER DISKS AND DVDS FEATURING GUIDED MEDITATION (U.S. CLS. 21, 23, 26, 36 AND 38).

FIRST USE 11-1-2008; IN COMMERCE 11-1-2008.

CLASS 35—ADVERTISING AND BUSINESS

FOR MAIL ORDER CATALOG SERVICES FEATURING PRODUCTS RELATING TO PERSONAL GROWTH, PERSONAL ENRICHMENT, AND SPIRITUAL GROWTH (U.S. CLS. 100, 101 AND 102).

FIRST USE 11-1-2008; IN COMMERCE 11-1-2008.

CLASS 41—EDUCATION AND ENTERTAINMENT

FOR CONDUCTING WORKSHOPS AND SEMINARS IN PERSONAL GROWTH, PERSONAL ENRICHMENT, AND SPIRITUAL GROWTH (U.S. CLS. 100, 101 AND 107).

FIRST USE 11-1-2008; IN COMMERCE 11-1-2008.

3,568,383. ENGMAN-TAYLOR COMPANY, INC., MENOMONEE FALLS, WI. SN 77-294,085. PUB. 5-6-2008, FILED 10-2-2007.



THE MARK CONSISTS OF THE LETTERS "CCST", WITH AN ARROW THROUGH THE LETTER "S" AND THE WORDS "CUSTOMER COST SAVINGS TEAM" TO THE RIGHT.

CLASS 35—ADVERTISING AND BUSINESS

FOR DISTRIBUTORSHIP SERVICES IN THE FIELD OF INDUSTRIAL EQUIPMENT, PARTS AND TOOLS (U.S. CLS. 100, 101 AND 102).

FIRST USE 10-0-2007; IN COMMERCE 10-0-2007.

CLASS 42—SCIENTIFIC AND COMPUTER SERVICES

FOR PROVISION OF ENGINEERING SERVICES IN THE NATURE OF DEVELOPING TURN-KEY PROCESSES AND AUTOMATION SOLUTIONS FOR MANUFACTURING, RESEARCH AND DEVELOPMENT, AND BUSINESS SYSTEMS (U.S. CLS. 100 AND 101).

FIRST USE 10-0-2007; IN COMMERCE 10-0-2007.

3,568,382. ENGMAN-TAYLOR COMPANY, INC., MENOMONEE FALLS, WI. SN 77-294,074. PUB. 5-6-2008, FILED 10-2-2007.

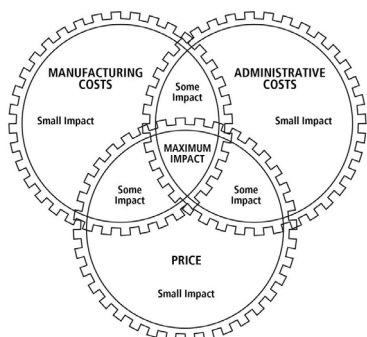

NO CLAIM IS MADE TO THE EXCLUSIVE RIGHT TO USE "MANUFACTURING COSTS" "ADMINISTRATIVE COSTS" AND "PRICE", APART FROM THE MARK AS SHOWN.

THE MARK CONSISTS OF THREE INTERLOCKING GEARS WITH WORDING INSIDE THE GEARS.

CLASS 35—ADVERTISING AND BUSINESS

FOR DISTRIBUTORSHIP SERVICES IN THE FIELD OF INDUSTRIAL EQUIPMENT, PARTS AND TOOLS (U.S. CLS. 100, 101 AND 102).

FIRST USE 10-22-2007; IN COMMERCE 10-0-2007.

CLASS 42—SCIENTIFIC AND COMPUTER SERVICES

FOR PROVISION OF ENGINEERING SERVICES IN THE NATURE OF DEVELOPING TURN-KEY PROCESSES AND AUTOMATION SOLUTIONS FOR MANUFACTURING, RESEARCH AND DEVELOPMENT, AND BUSINESS SYSTEMS (U.S. CLS. 100 AND 101).

FIRST USE 10-0-2007; IN COMMERCE 10-0-2007.

3,568,388. SIGMA-ALDRICH BIOTECHNOLOGY L.P., ST. LOUIS, MO. SN 77-295,860. PUB. 7-22-2008, FILED 10-4-2007.

SIGMA ADJUVANT SYSTEM

THE MARK CONSISTS OF STANDARD CHARACTERS WITHOUT CLAIM TO ANY PARTICULAR FONT, STYLE, SIZE, OR COLOR.

OWNER OF U.S. REG. NOS. 897,642, 1,438,820, AND OTHERS.

NO CLAIM IS MADE TO THE EXCLUSIVE RIGHT TO USE "ADJUVANT SYSTEM", APART FROM THE MARK AS SHOWN.

CLASS 1—CHEMICALS

FOR ADJUVANTS DERIVED FROM BIOLOGICAL MATERIALS FOR USE IN THE RESEARCH, DEVELOPMENT, AND MANUFACTURE OF PHARMACEUTICALS AND VACCINES; STABLE OIL-IN-WATER EMULSION ADJUVANTS DERIVED FROM BACTERIAL AND MYCOBACTERIAL CELL WALL COMPONENTS FOR USE IN THE RESEARCH DEVELOPMENT, AND MANUFACTURE OF PHARMACEUTICALS AND VACCINES; CHEMICAL, BIOCHEMICAL AND BIOLOGICAL COMPOUNDS FOR USE IN THE MANUFACTURE OF PHARMACEUTICAL PREPARATIONS, NAMELY, FOR USE IN ENHANCING THE EFFECTIVENESS OF VACCINES AND PHARMACEUTICALS; CHEMICAL COMPOUNDS FOR USE IN THE MANUFACTURE OF PHARMACEUTICAL PREPARATIONS (U.S. CLS. 1, 5, 6, 10, 26 AND 46).

FIRST USE 11-21-2008; IN COMMERCE 11-21-2008.

CLASS 5—PHARMACEUTICALS

FOR ADJUVANTS DERIVED FROM BIOLOGICAL MATERIALS FOR MEDICAL PURPOSES; STABLE OIL-IN-WATER EMULSION ADJUVANTS DERIVED FROM BACTERIAL AND MYCOBACTERIAL CELL WALL COMPONENTS FOR MEDICAL PURPOSES (U.S. CLS. 6, 18, 44, 46, 51 AND 52).

FIRST USE 11-21-2008; IN COMMERCE 11-21-2008.

3,568,389. CENTER FOR THE STUDY OF EXPERTISE IN TEACHING AND LEARNING, INC., DBA COMMUNITIES FOR LEARNING; LEADING LASTING CHANGE, FLORAL PARK, NY. SN 77-295,955. PUB. 3-18-2008, FILED 10-4-2007.

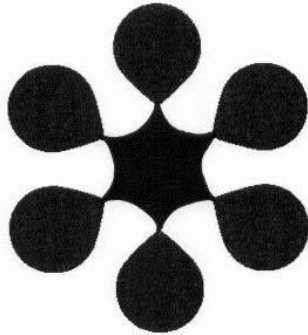

THE MARK CONSISTS OF A FANCIFUL DESIGN OF A HEXAGON WITH CURVED SIDES SURROUNDED BY SIX TEARDROP SHAPED CIRCLES.

CLASS 35—ADVERTISING AND BUSINESS

FOR PROVIDING ORGANIZATIONAL DEVELOPMENT CONSULTING SERVICES; EDUCATIONAL LEADERSHIP DEVELOPMENT (U.S. CLS. 100, 101 AND 102).

FIRST USE 1-14-2008; IN COMMERCE 1-14-2008.

CLASS 41—EDUCATION AND ENTERTAINMENT

FOR CONSULTING AND DEVELOPMENT SERVICES PROVIDED TO PROFESSIONAL LEARNING COMMUNITIES IN SCHOOLS AND OTHER EDUCATIONAL ORGANIZATIONS FOR THE PURPOSES OF IMPROVING TEACHING AND LEARNING; DEVELOPMENT OF EDUCATIONAL MATERIALS INCLUDING MEASURES, PROCESSES AND TOOLS FOR PROFESSIONAL LEARNING COMMUNITIES IN THE FIELDS OF TEACHING AND LEARNING (U.S. CLS. 100, 101 AND 107).

FIRST USE 1-14-2008; IN COMMERCE 1-14-2008.

3,568,394. LAMBS & IVY, INC., EL SEGUNDO, CA. SN 77-298,840. PUB. 4-8-2008, FILED 10-8-2007.

YUM YUM BABY

THE MARK CONSISTS OF STANDARD CHARACTERS WITHOUT CLAIM TO ANY PARTICULAR FONT, STYLE, SIZE, OR COLOR.

NO CLAIM IS MADE TO THE EXCLUSIVE RIGHT TO

USE "BABY", APART FROM THE MARK AS SHOWN.

CLASS 24—FABRICS

FOR LINENS, TOWELS, AND BURP CLOTHS NOT OF PAPER; BLANKETS, PLACE MATS, HANDKERCHIEFS AND NAPKINS OF CLOTH (U.S. CLS. 42 AND 50).

FIRST USE 3-1-2008; IN COMMERCE 3-1-2008.

CLASS 25—CLOTHING

FOR CLOTH BIBS (U.S. CLS. 22 AND 39).

FIRST USE 3-1-2008; IN COMMERCE 3-1-2008.

CLASS 28—TOYS AND SPORTING GOODS

FOR PUPPETS (U.S. CLS. 22, 23, 38 AND 50).

FIRST USE 3-1-2008; IN COMMERCE 3-1-2008.

3,568,424. BR PHARMA LIMITED, BOREHAMWOOD, HERFORDS., UNITED KINGDOM. SN 77-319,944. PUB. 5-20-2008, FILED 11-2-2007.

PHARMARAMA

THE MARK CONSISTS OF STANDARD CHARACTERS WITHOUT CLAIM TO ANY PARTICULAR FONT, STYLE, SIZE, OR COLOR.

CLASS 35—ADVERTISING AND BUSINESS

FOR PROCUREMENT SERVICES, NAMELY, PURCHASING FOR OTHERS OF PHARMACEUTICAL PRODUCTS FOR CLINICAL TRIALS; PROVIDING MARKETING AND PROMOTIONAL SERVICES FOR THE PHARMACEUTICALS, DRUGS AND MEDICINES OF OTHERS; PROVISION OF INFORMATION AND ADVICE REGARDING THE FOREGOING; PACKAGING OF PHARMACEUTICAL PRODUCTS TO THE ORDER AND/OR SPECIFICATION OF OTHERS; RETAIL PHARMACY SERVICES AND PROVIDING ADVICE IN CONJUNCTION THEREWITH; DISTRIBUTORSHIP SERVICES FOR PHARMACIES, HOSPITALS, CLINICS, CLINICAL TRIALS AND MEDICAL PROFESSIONALS IN THE FIELD OF PHARMACEUTICALS, DRUGS AND MEDICINES; SAMPLE DISTRIBUTION OF PHARMACEUTICALS, DRUGS AND MEDICINES TO PHARMACIES, HOSPITALS, CLINICS AND MEDICAL PROFESSIONALS (U.S. CLS. 100, 101 AND 102).

FIRST USE 9-1-2007; IN COMMERCE 9-1-2007.

CLASS 39—TRANSPORTATION AND STORAGE

FOR PROVISION OF STORAGE FOR THE PHARMACEUTICALS, DRUGS AND MEDICINES OF OTHERS; PACKAGING OF PHARMACEUTICAL PRODUCTS FOR TRANSPORTATION (U.S. CLS. 100 AND 105).

FIRST USE 9-1-2007; IN COMMERCE 9-1-2007.

CLASS 40—MATERIAL TREATMENT

FOR APPLICATION OF PHARMACEUTICAL PRODUCT LABELS TO THE ORDER AND/OR SPECIFICATION OF OTHERS; ASSEMBLY OF CLINICAL TRIAL PATIENT KITS FOR OTHERS (U.S. CLS. 100, 103 AND 106).

FIRST USE 9-1-2007; IN COMMERCE 9-1-2007.

CLASS 44—MEDICAL, BEAUTY AND AGRICULTURAL SERVICES

FOR PROVIDING MEDICAL INFORMATION RELATING TO PHARMACEUTICALS, DRUGS AND MEDICINES; PHARMACEUTICAL ADVICE; PROVIDING MEDICAL PHARMACEUTICAL CONSULTATION; DISPENSING OF PHARMACEUTICALS, DRUGS AND MEDICINES (U.S. CLS. 100 AND 101).
FIRST USE 9-1-2007; IN COMMERCE 9-1-2007.

3,568,428. PROLA VEGA LLC, WILSON, WY. SN 77-323,615.
PUB. 4-29-2008, FILED 11-7-2007.

GIFTARROW

THE MARK CONSISTS OF STANDARD CHARACTERS WITHOUT CLAIM TO ANY PARTICULAR FONT, STYLE, SIZE, OR COLOR.

3,568,425. LIVING CONSCIOUSLY BY DESIGN, INC., FOXBORO, MA. SN 77-319,954. PUB. 6-3-2008, FILED 11-2-2007.

INFINITE BLESSINGS

THE MARK CONSISTS OF STANDARD CHARACTERS WITHOUT CLAIM TO ANY PARTICULAR FONT, STYLE, SIZE, OR COLOR.

CLASS 3—COSMETICS AND CLEANING PREPARATIONS

FOR BATH SALTS; BATH OILS; ESSENTIAL OILS; SCENTED ROOM SPRAYS (U.S. CLS. 1, 4, 6, 50, 51 AND 52).
FIRST USE 11-8-2008; IN COMMERCE 11-8-2008.

CLASS 4—LUBRICANTS AND FUELS

FOR CANDLES (U.S. CLS. 1, 6 AND 15).
FIRST USE 11-8-2008; IN COMMERCE 11-8-2008.

CLASS 9—ELECTRICAL AND SCIENTIFIC APPARATUS

FOR MAGNETS (U.S. CLS. 21, 23, 26, 36 AND 38).
FIRST USE 11-8-2008; IN COMMERCE 11-8-2008.

CLASS 14—JEWELRY

FOR JEWELRY (U.S. CLS. 2, 27, 28 AND 50).
FIRST USE 11-8-2008; IN COMMERCE 11-8-2008.

CLASS 16—PAPER GOODS AND PRINTED MATTER

FOR CALENDARS; NOTE CARDS; POSTERS (U.S. CLS. 2, 5, 22, 23, 29, 37, 38 AND 50).
FIRST USE 11-8-2008; IN COMMERCE 11-8-2008.

CLASS 18—LEATHER GOODS

FOR TOTE BAGS (U.S. CLS. 1, 2, 3, 22 AND 41).
FIRST USE 11-8-2008; IN COMMERCE 11-8-2008.

CLASS 25—CLOTHING

FOR HATS; T-SHIRTS (U.S. CLS. 22 AND 39).
FIRST USE 11-8-2008; IN COMMERCE 11-8-2008.

CLASS 35—ADVERTISING AND BUSINESS

FOR ONLINE ORDERING SERVICES FEATURING GENERAL MERCHANDISE; PROVIDING SEARCHABLE ONLINE ADVERTISING GUIDE FEATURING THE GOODS AND SERVICES OF OTHER ONLINE VENDORS ON THE INTERNET (U.S. CLS. 100, 101 AND 102).
FIRST USE 8-10-2008; IN COMMERCE 8-10-2008.

CLASS 45—PERSONAL AND LEGAL SERVICES

FOR GIFT WRAPPING SERVICES (U.S. CLS. 100 AND 101).
FIRST USE 8-10-2008; IN COMMERCE 8-10-2008.

3,568,429. APPLIED AESTHETICS, INC., DBA HAND-WROUGHT JEWELRY, INC., JUNO BEACH, FL. SN 77-326,705. PUB. 4-22-2008, FILED 11-11-2007.

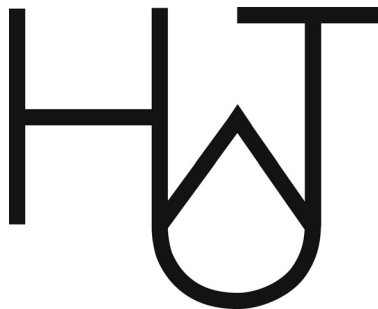

THE MARK CONSISTS OF THE STYLIZED LETTERS "H W J".

THE WORDING "HWJ" HAS NO MEANING OTHER THAN TRADEMARK SIGNIFICANCE.

CLASS 14—JEWELRY

FOR BEADS FOR USE IN THE MANUFACTURE OF JEWELRY; BRACELETS; BROOCHES; CHARMS; DIAMOND JEWELRY; GEMSTONE JEWELRY; JEWELRY; JEWELRY BOXES; JEWELRY BOXES NOT OF METAL; JEWELRY BOXES OF METAL; JEWELRY BOXES OF PRECIOUS METAL; JEWELRY CHAINS; JEWELRY FINDINGS; JEWELRY, NAMELY, PRECIOUS METAL PLATED REAL LEAVES AND FLOWERS; LEATHER JEWELRY AND ACCESSORY BOXES; PINS BEING JEWELRY; RINGS; RINGS BEING JEWELRY (U.S. CLS. 2, 27, 28 AND 50).
FIRST USE 12-1-2007; IN COMMERCE 3-1-2008.

CLASS 35—ADVERTISING AND BUSINESS

FOR MAIL ORDER SERVICES FEATURING JEWELRY; RETAIL JEWELRY STORES; STREET VENDOR SERVICES FEATURING JEWELRY; VENDING IN THE FIELD OF JEWELRY; WHOLESALE STORES FEATURING JEWELRY (U.S. CLS. 100, 101 AND 102).
FIRST USE 12-1-2007; IN COMMERCE 3-1-2008.

3,568,437. PHYSICIANS HEALTH PLAN OF NORTHERN INDIANA, INC., FORT WAYNE, IN. SN 77-329,029. PUB. 4-22-2008, FILED 11-14-2007.

INDIGO INDIVIDUAL

THE MARK CONSISTS OF STANDARD CHARACTERS WITHOUT CLAIM TO ANY PARTICULAR FONT, STYLE, SIZE, OR COLOR.

NO CLAIM IS MADE TO THE EXCLUSIVE RIGHT TO USE "INDIVIDUAL", APART FROM THE MARK AS SHOWN.

CLASS 36—INSURANCE AND FINANCIAL

FOR UNDERWRITING, ORGANIZING AND ADMINISTRATION OF PRE-PAID HEALTH CARE SERVICES AND PLANS (U.S. CLS. 100, 101 AND 102).
FIRST USE 9-17-2007; IN COMMERCE 9-17-2007.

CLASS 44—MEDICAL, BEAUTY AND AGRICULTURAL SERVICES

FOR HEALTH CARE SERVICES PROVIDED BY A NETWORK OF HEALTH CARE PROFESSIONALS AND SERVICE PROVIDERS (U.S. CLS. 100 AND 101).
FIRST USE 9-17-2007; IN COMMERCE 9-17-2007.

3,568,445. GODADDY.COM, INC., SCOTTSDALE, AZ. SN 77-334,505. PUB. 4-29-2008, FILED 11-20-2007.

THE WEB IS YOUR DOMAIN!

THE MARK CONSISTS OF STANDARD CHARACTERS WITHOUT CLAIM TO ANY PARTICULAR FONT, STYLE, SIZE, OR COLOR.

NO CLAIM IS MADE TO THE EXCLUSIVE RIGHT TO USE "WEB" AND "DOMAIN", APART FROM THE MARK AS SHOWN.

CLASS 9—ELECTRICAL AND SCIENTIFIC APPARATUS

FOR WEB SITE DEVELOPMENT SOFTWARE (U.S. CLS. 21, 23, 26, 36 AND 38).
FIRST USE 12-19-2007; IN COMMERCE 12-19-2007.

CLASS 35—ADVERTISING AND BUSINESS

FOR ONLINE AUCTION SERVICES; AUCTION MANAGEMENT SERVICES PROVIDED TO OTHERS OVER AN ON-LINE WEB SITE ACCESSED THROUGH A GLOBAL COMPUTER NETWORK (U.S. CLS. 100, 101 AND 102).
FIRST USE 12-19-2007; IN COMMERCE 12-19-2007.

CLASS 39—TRANSPORTATION AND STORAGE

FOR PARKING DOMAIN NAMES FOR OTHERS, NAMELY, PROVIDING COMPUTER SERVERS FOR FACILITATION OF THE STORAGE OF DOMAIN NAME ADDRESSES (U.S. CLS. 100 AND 105).
FIRST USE 12-19-2007; IN COMMERCE 12-19-2007.

CLASS 42—SCIENTIFIC AND COMPUTER SERVICES

FOR DESIGN, CREATION, HOSTING, MAINTENANCE OF WEBSITES FOR OTHERS; WEBSITE DEVELOPMENT FOR OTHERS; COMPUTER SERVICES, NAMELY, CREATING AND MAINTAINING WEB SITES FOR OTHERS; COMPUTER SERVICES, NAMELY, DESIGNING AND IMPLEMENTING WEB SITES FOR OTHERS; CREATING OR MAINTAINING WEB SITES FOR OTHERS; HOSTING THE WEB SITES OF OTHERS ON A COMPUTER SERVER FOR A GLOBAL COMPUTER NETWORK; WEB SITE HOSTING SERVICES (U.S. CLS. 100 AND 101).
FIRST USE 12-19-2007; IN COMMERCE 12-19-2007.

CLASS 45—PERSONAL AND LEGAL SERVICES

FOR REGISTRATION OF DOMAIN NAMES FOR IDENTIFICATION OF USERS ON A GLOBAL COMPUTER NETWORK (U.S. CLS. 100 AND 101).
FIRST USE 12-19-2007; IN COMMERCE 12-19-2007.

3,568,447. ADTECH CAPITAL GROUP, INC., CITY OF INDUSTRY, CA. SN 77-334,706. PUB. 4-29-2008, FILED 11-20-2007.



THE MARK CONSISTS OF A LETTER "A" IN UPPER CASE, FOLLOWED BY A NUMBER "25", BOTH IN BLACK, AND A CURVED WHITE BAND RUNS HORIZONTALLY THROUGH THE MARK IN THE MIDDLE OF THE MARK.

CLASS 6—METAL GOODS

FOR INDUSTRIAL PACKAGING CONTAINERS OF METAL (U.S. CLS. 2, 12, 13, 14, 23, 25 AND 50).
FIRST USE 7-25-2008; IN COMMERCE 7-25-2008.

CLASS 16—PAPER GOODS AND PRINTED MATTER

FOR CARDBOARD PACKAGING (U.S. CLS. 2, 5, 22, 23, 29, 37, 38 AND 50).
FIRST USE 7-25-2008; IN COMMERCE 7-25-2008.

3,568,451. SODA BY AMY, LLC, CHICAGO, IL. SN 77-338,653. PUB. 4-29-2008, FILED 11-28-2007.

3,568,458. PARTNERS IN LEADERSHIP IP II, LLC, TEMECULA, CA. SN 77-342,959. PUB. 3-11-2008, FILED 12-3-2007.

SODA

OUTER RING

THE MARK CONSISTS OF STANDARD CHARACTERS WITHOUT CLAIM TO ANY PARTICULAR FONT, STYLE, SIZE, OR COLOR.

THE MARK CONSISTS OF STANDARD CHARACTERS WITHOUT CLAIM TO ANY PARTICULAR FONT, STYLE, SIZE, OR COLOR.

CLASS 21—HOUSEWARES AND GLASS

FOR PORCELAIN CUPS AND MUGS (U.S. CLS. 2, 13, 23, 29, 30, 33, 40 AND 50).
FIRST USE 1-0-2008; IN COMMERCE 1-0-2008.

CLASS 35—ADVERTISING AND BUSINESS

FOR BUSINESS SERVICES, NAMELY, BUSINESS CONSULTATION SERVICES AND BUSINESS MANAGEMENT SERVICES (U.S. CLS. 100, 101 AND 102).
FIRST USE 6-2-2008; IN COMMERCE 8-15-2008.

CLASS 27—FLOOR COVERINGS

FOR WALLPAPER (U.S. CLS. 19, 20, 37, 42 AND 50).
FIRST USE 1-0-2008; IN COMMERCE 1-0-2008.

CLASS 41—EDUCATION AND ENTERTAINMENT

FOR EDUCATIONAL AND TRAINING SERVICES, NAMELY, CONSULTING SEMINARS, WORKSHOPS AND ONE-ON-ONE TRAINING IN THE FIELDS OF BUSINESS MANAGEMENT AND BUSINESS OPERATIONS AND DISTRIBUTION OF COURSE MATERIAL IN CONNECTION THEREWITH (U.S. CLS. 100, 101 AND 107).
FIRST USE 6-2-2008; IN COMMERCE 8-15-2008.

3,568,457. PARTNERS IN LEADERSHIP IP II, LLC, TEMECULA, CA. SN 77-342,952. PUB. 3-11-2008, FILED 12-3-2007.

3,568,459. PARTNERS IN LEADERSHIP IP II, LLC, TEMECULA, CA. SN 77-343,000. PUB. 3-11-2008, FILED 12-3-2007.

INNER RING

REALITY WINDOW

THE MARK CONSISTS OF STANDARD CHARACTERS WITHOUT CLAIM TO ANY PARTICULAR FONT, STYLE, SIZE, OR COLOR.

THE MARK CONSISTS OF STANDARD CHARACTERS WITHOUT CLAIM TO ANY PARTICULAR FONT, STYLE, SIZE, OR COLOR.

CLASS 35—ADVERTISING AND BUSINESS

FOR BUSINESS SERVICES, NAMELY, BUSINESS CONSULTATION SERVICES AND BUSINESS MANAGEMENT SERVICES (U.S. CLS. 100, 101 AND 102).
FIRST USE 6-2-2008; IN COMMERCE 8-15-2008.

CLASS 35—ADVERTISING AND BUSINESS

FOR BUSINESS SERVICES, NAMELY, BUSINESS CONSULTATION SERVICES AND BUSINESS MANAGEMENT SERVICES (U.S. CLS. 100, 101 AND 102).
FIRST USE 6-2-2008; IN COMMERCE 8-15-2008.

CLASS 41—EDUCATION AND ENTERTAINMENT

FOR EDUCATIONAL AND TRAINING SERVICES, NAMELY, CONSULTING SEMINARS, WORKSHOPS AND ONE-ON-ONE TRAINING IN THE FIELDS OF BUSINESS MANAGEMENT AND BUSINESS OPERATIONS AND DISTRIBUTION OF COURSE MATERIAL IN CONNECTION THEREWITH (U.S. CLS. 100, 101 AND 107).
FIRST USE 6-2-2008; IN COMMERCE 8-15-2008.

CLASS 41—EDUCATION AND ENTERTAINMENT

FOR EDUCATIONAL AND TRAINING SERVICES, NAMELY, CONSULTING SEMINARS, WORKSHOPS AND ONE-ON-ONE TRAINING IN THE FIELDS OF BUSINESS MANAGEMENT AND BUSINESS OPERATIONS AND DISTRIBUTION OF COURSE MATERIAL IN CONNECTION THEREWITH (U.S. CLS. 100, 101 AND 107).
FIRST USE 6-2-2008; IN COMMERCE 8-15-2008.

3,568,473. INSURANCE TECHNOLOGIES GROUP, INC., DBA WORKCOMPARE, INC., PASADENA, CA. SN 77-359,994. PUB. 5-6-2008, FILED 12-27-2007.

WorkCompare.com

THE MARK CONSISTS OF STANDARD CHARACTERS WITHOUT CLAIM TO ANY PARTICULAR FONT, STYLE, SIZE, OR COLOR.

CLASS 35—ADVERTISING AND BUSINESS

FOR (BASED ON USE IN COMMERCE) DATA COMPILING AND ANALYZING IN THE FIELD OF INSURANCE; PROMOTING, ADVERTISING AND MARKETING OF THE ON-LINE WEBSITES OF OTHERS; INSURANCE LEAD COLLECTION AND MATCHING SERVICES, NAMELY, MATCHING CONSUMER REQUESTS FOR INSURANCE POLICY QUOTES COLLECTED OVER THE INTERNET TO PRE-QUALIFIED INSURANCE BROKERS, AGENTS AND AGENCIES INTERESTED IN THOSE REQUESTS (U.S. CLS. 100, 101 AND 102).

FIRST USE 12-1-2006; IN COMMERCE 12-1-2006.

CLASS 36—INSURANCE AND FINANCIAL

FOR (BASED ON USE IN COMMERCE) PROVIDING INFORMATION REGARDING WORKERS' COMPENSATION INSURANCE POLICY RATES; INSURANCE PREMIUM RATE COMPUTING; INSURANCE AGENCY AND BROKERAGE; INSURANCE AGENCIES IN THE FIELD OF WORKERS COMPENSATION (U.S. CLS. 100, 101 AND 102).

FIRST USE 12-1-2006; IN COMMERCE 12-1-2006.

3,568,478. EXETER VENTURE MANAGEMENT COMPANY, LLC, BOSTON, MA. SN 77-364,524. PUB. 5-20-2008, FILED 1-4-2008.

FLYBRIDGE

THE MARK CONSISTS OF STANDARD CHARACTERS WITHOUT CLAIM TO ANY PARTICULAR FONT, STYLE, SIZE, OR COLOR.

CLASS 35—ADVERTISING AND BUSINESS

FOR BUSINESS MANAGEMENT CONSULTING (U.S. CLS. 100, 101 AND 102).

FIRST USE 3-17-2008; IN COMMERCE 3-17-2008.

CLASS 36—INSURANCE AND FINANCIAL

FOR PRIVATE EQUITY FUND INVESTMENT SERVICES; VENTURE CAPITAL SERVICES, NAMELY, PROVIDING FINANCING TO EMERGING AND START-UP COMPANIES; INVESTMENT ADVISORY SERVICES; INVESTMENT MANAGEMENT (U.S. CLS. 100, 101 AND 102).

FIRST USE 3-17-2008; IN COMMERCE 3-17-2008.

3,568,497. GACH, JONATHAN L., QUEEN CREEK, AZ. AND MEDINA, DEBORAH A., GILBERT, AZ. SN 77-384,926. PUB. 6-24-2008, FILED 1-31-2008.



THE MARK CONSISTS OF A PROFILE OF A MAN WITH A THIN MUSTACHE AND A FEDORA HAT.

CLASS 25—CLOTHING

FOR BASEBALL CAPS; T-SHIRTS (U.S. CLS. 22 AND 39).

FIRST USE 9-1-2008; IN COMMERCE 9-1-2008.

CLASS 33—WINES AND SPIRITS

FOR LIQUOR (U.S. CLS. 47 AND 49).

FIRST USE 9-1-2008; IN COMMERCE 9-1-2008.

3,568,507. AMERICAN OF MARTINSVILLE, INC., MARTINSVILLE, VA. SN 77-399,966. PUB. 7-8-2008, FILED 2-19-2008.



OWNER OF U.S. REG. NOS. 1,044,876 AND 1,772,375.

THE MARK CONSISTS OF THE TERMS, "AMERICAN OF MARTINSVILLE", TO THE RIGHT OF THE FANCIFUL DESIGN OF A WAVE.

SEC. 2(F) AS TO "AMERICAN OF MARTINSVILLE".

CLASS 20—FURNITURE AND ARTICLES NOT OTHERWISE CLASSIFIED

FOR FURNITURE (U.S. CLS. 2, 13, 22, 25, 32 AND 50).

FIRST USE 5-31-2008; IN COMMERCE 5-31-2008.

CLASS 35—ADVERTISING AND BUSINESS

FOR WHOLESALE DISTRIBUTORSHIP SERVICES FEATURING FURNITURE FOR HOTELS AND SENIOR LIVING FACILITIES (U.S. CLS. 100, 101 AND 102).

FIRST USE 1-31-2008; IN COMMERCE 1-31-2008.

3,568,522. DOW JONES & COMPANY, INC., NEW YORK, NY. SN 77-414,880. PUB. 7-22-2008, FILED 3-6-2008.

3,568,525. URBAN PIRATES, LLC, BALTIMORE, MD. SN 77-418,269. PUB. 7-22-2008, FILED 3-10-2008.

WSJ

THE MARK CONSISTS OF STANDARD CHARACTERS WITHOUT CLAIM TO ANY PARTICULAR FONT, STYLE, SIZE, OR COLOR.

OWNER OF U.S. REG. NOS. 2,119,170, 2,575,504, AND OTHERS.

CLASS 9—ELECTRICAL AND SCIENTIFIC APPARATUS

FOR DOWNLOADABLE ELECTRONIC PUBLICATIONS IN THE NATURE OF MAGAZINES IN THE FIELD OF LIFESTYLE, LEISURE AND LUXURY TOPICS; ELECTRONIC PUBLICATIONS, NAMELY, MAGAZINES FEATURING LIFESTYLE, LEISURE AND LUXURY TOPICS RECORDED ON COMPUTER MEDIA (U.S. CLS. 21, 23, 26, 36 AND 38).
FIRST USE 9-6-2008; IN COMMERCE 9-6-2008.

CLASS 16—PAPER GOODS AND PRINTED MATTER

FOR MAGAZINES FEATURING LIFESTYLE, LEISURE AND LUXURY TOPICS (U.S. CLS. 2, 5, 22, 23, 29, 37, 38 AND 50).
FIRST USE 9-6-2008; IN COMMERCE 9-6-2008.

CLASS 41—EDUCATION AND ENTERTAINMENT

FOR PROVIDING NON-DOWNLOADABLE ON-LINE PUBLICATION IN THE NATURE OF ON-LINE MAGAZINES IN THE FIELD OF LIFESTYLE, LEISURE AND LUXURY TOPICS (U.S. CLS. 100, 101 AND 107).
FIRST USE 9-6-2008; IN COMMERCE 9-6-2008.

3,568,524. TON, QUY THAT, BATON ROUGE, LA. SN 77-418,227. PUB. 7-22-2008, FILED 3-10-2008.

SONATA

THE MARK CONSISTS OF STANDARD CHARACTERS WITHOUT CLAIM TO ANY PARTICULAR FONT, STYLE, SIZE, OR COLOR.

CLASS 10—MEDICAL APPARATUS

FOR MASSAGE CHAIR AND FOOTBATHS SOLD AS A UNIT THEREWITH (U.S. CLS. 26, 39 AND 44).
FIRST USE 7-13-2008; IN COMMERCE 7-13-2008.

CLASS 11—ENVIRONMENTAL CONTROL APPARATUS

FOR FOOTBATHS FOR USE IN PEDICURE SALONS AND DAY SPAS (U.S. CLS. 13, 21, 23, 31 AND 34).
FIRST USE 7-13-2008; IN COMMERCE 7-13-2008.

Urban Pirates

THE MARK CONSISTS OF STANDARD CHARACTERS WITHOUT CLAIM TO ANY PARTICULAR FONT, STYLE, SIZE, OR COLOR.

CLASS 25—CLOTHING

FOR TOPS; HOODED SWEAT SHIRTS; LONG-SLEEVED SHIRTS; SHORT-SLEEVED OR LONG-SLEEVED T-SHIRTS (U.S. CLS. 22 AND 39).
FIRST USE 3-1-2008; IN COMMERCE 6-1-2008.

CLASS 39—TRANSPORTATION AND STORAGE

FOR ARRANGING OF TOURS AND CRUISES; BOAT CRUISES (U.S. CLS. 100 AND 105).
FIRST USE 3-1-2008; IN COMMERCE 5-1-2008.

CLASS 41—EDUCATION AND ENTERTAINMENT

FOR CHILDREN'S ENTERTAINMENT AND AMUSEMENT CENTERS, NAMELY, INTERACTIVE PLAY AREAS; ENTERTAINMENT SERVICES, NAMELY, CONDUCTING PARTIES (U.S. CLS. 100, 101 AND 107).
FIRST USE 3-1-2008; IN COMMERCE 5-25-2008.

3,568,528. ION MEDIA NETWORKS, INC., WEST PALM BEACH, FL. SN 77-419,741. PUB. 7-29-2008, FILED 3-12-2008.

ION TELEVISION POSITIVELY ENTERTAINING

THE MARK CONSISTS OF STANDARD CHARACTERS WITHOUT CLAIM TO ANY PARTICULAR FONT, STYLE, SIZE, OR COLOR.

NO CLAIM IS MADE TO THE EXCLUSIVE RIGHT TO USE "TELEVISION", APART FROM THE MARK AS SHOWN.

CLASS 38—COMMUNICATION

FOR CABLE TELEVISION BROADCASTING; TELEVISION BROADCASTING; VIDEO BROADCASTING (U.S. CLS. 100, 101 AND 104).
FIRST USE 5-1-2008; IN COMMERCE 5-1-2008.

CLASS 41—EDUCATION AND ENTERTAINMENT

FOR DISTRIBUTION OF TELEVISION PROGRAMMING TO CABLE TELEVISION SYSTEMS; ENTERTAINMENT IN THE NATURE OF ON-GOING TELEVISION PROGRAMS IN THE FIELD OF NEWS, SPORTS, WEATHER, COMEDY, DRAMA, HEALTH AND FITNESS, MEDICINE, COOKING, CHILDREN'S PROGRAMMING AND VARIETY SHOWS (U.S. CLS. 100, 101 AND 107).

FIRST USE 5-1-2008; IN COMMERCE 5-1-2008.

3,568,544. MANGANLOTIS, JOHNNY, CLIFTON, NJ. SN 77-441,680. PUB. 8-26-2008, FILED 4-7-2008.

MR. CUPCAKES

THE MARK CONSISTS OF STANDARD CHARACTERS WITHOUT CLAIM TO ANY PARTICULAR FONT, STYLE, SIZE, OR COLOR.

NO CLAIM IS MADE TO THE EXCLUSIVE RIGHT TO USE "CUPCAKES", APART FROM THE MARK AS SHOWN.

CLASS 25—CLOTHING

FOR APRONS; BABY BIBS NOT OF PAPER; BABY TOPS; BASEBALL CAPS; BOXER SHORTS; CAP VISORS; CAPS; CAPS WITH VISORS; CHEF'S HATS; CHILDREN'S AND INFANTS' CLOTH BIBS; CHILDREN'S HEADWEAR; GOLF SHIRTS; HOODED PULLOVERS; HOODED SWEAT SHIRTS; JACKETS; PAJAMA BOTTOMS; SWEAT PANTS; SWEAT SHIRTS; TANK-TOPS; TEE SHIRTS; TIES; TRACK SUITS (U.S. CLS. 22 AND 39).

FIRST USE 4-7-2008; IN COMMERCE 4-7-2008.

CLASS 30—STAPLE FOODS

FOR BAKERY DESSERTS; BAKERY GOODS; BAKERY PRODUCTS; BAKERY PRODUCTS, NAMELY, SWEET BAKERY GOODS; BISCUITS; BUNS; HONEY BUNS; CINNAMON ROLLS; CUP CAKES (U.S. CL. 46).

FIRST USE 4-7-2008; IN COMMERCE 4-7-2008.

3,568,548. HEALING FLOW YOGA AND RETREAT MINISTRIES LLC, NAPERVILLE, IL. SN 77-443,486. PUB. 8-26-2008, FILED 4-9-2008.

HEALING FLOW

THE MARK CONSISTS OF STANDARD CHARACTERS WITHOUT CLAIM TO ANY PARTICULAR FONT, STYLE, SIZE, OR COLOR.

CLASS 41—EDUCATION AND ENTERTAINMENT

FOR YOGA INSTRUCTION (U.S. CLS. 100, 101 AND 107).

FIRST USE 6-0-2008; IN COMMERCE 6-0-2008.

CLASS 45—PERSONAL AND LEGAL SERVICES

FOR MINISTERIAL SERVICES (U.S. CLS. 100 AND 101).

FIRST USE 6-0-2008; IN COMMERCE 6-0-2008.

3,568,561. THE NATIONAL OSTEOPOROSIS FOUNDATION, WASHINGTON, DC. SN 77-497,500. PUB. 8-19-2008, FILED 6-12-2008.

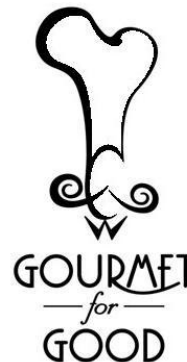

THE MARK CONSISTS OF A FANCIFUL HUMAN HEAD WITH A MUSTACHE, CHEF HAT AND BOW TIE, ABOVE THE VERTICALLY STACKED WORDS "GOURMET FOR GOOD", WITH A HORIZONTAL LINE ON EACH SIDE OF THE WORD FOR.

CLASS 36—INSURANCE AND FINANCIAL

FOR CHARITABLE FUNDRAISING SERVICES, NAMELY, RAISING FUNDS TO PROVIDE PUBLIC EDUCATION REGARDING AND PROMOTING AWARENESS ABOUT OSTEOPOROSIS (U.S. CLS. 100, 101 AND 102).

FIRST USE 10-20-2008; IN COMMERCE 10-20-2008.

CLASS 43—HOTEL AND RESTAURANT SERVICES

FOR ORGANIZING, CONDUCTING AND SPONSORING DINNER EVENTS WHERE PARTICIPANTS SAMPLE MEALS AND DRINKS AT A SERIES OF RESTAURANTS TO PROMOTE PUBLIC AWARENESS ABOUT OSTEOPOROSIS (U.S. CLS. 100 AND 101).

FIRST USE 10-20-2008; IN COMMERCE 10-20-2008.

3,568,564. MENDES, EVA, BEVERLY HILLS, CA. SN 77-976,120. PUB. 7-31-2007, FILED 3-12-2007.

EVA MENDES

THE MARK CONSISTS OF STANDARD CHARACTERS WITHOUT CLAIM TO ANY PARTICULAR FONT, STYLE, SIZE, OR COLOR.

THE NAME "EVA MENDES" IDENTIFIES A LIVING INDIVIDUAL WHOSE CONSENT IS OF RECORD.

CLASS 24—FABRICS

FOR BED LINEN; DUVET COVERS; PLACE MATS OF TEXTILE MATERIAL; TABLE CLOTHS NOT OF PAPER; TABLE LINEN; TAPESTRIES OF TEXTILE; TEXTILE FABRICS FOR HOME AND COMMERCIAL INTERIORS; TEXTILE TABLECLOTHS; TEXTILE WALL HANGINGS; TOWELS (U.S. CLS. 42 AND 50).

FIRST USE 6-1-2008; IN COMMERCE 6-1-2008.

CLASS 41—EDUCATION AND ENTERTAINMENT

FOR ENTERTAINMENT IN THE NATURE OF VISUAL AND AUDIO PERFORMANCES, AND MUSICAL, VARIETY, NEWS AND COMEDY SHOWS; ENTERTAINMENT SERVICES NAMELY LIVE, TELEVISED AND MOVIE APPEARANCES BY A PROFESSIONAL ENTERTAINER (U.S. CLS. 100, 101 AND 107).

FIRST USE 1-1-2008; IN COMMERCE 1-1-2008.

3,568,570. INTERNATIONAL SURFACE PREPARATION GROUP, INC., GOLDEN, CO. SN 78-292,295. PUB. 10-4-2005, FILED 8-26-2003.



**INTERNATIONAL
SURFACE PREPARATION**

NO CLAIM IS MADE TO THE EXCLUSIVE RIGHT TO USE "INTERNATIONAL SURFACE PREPARATION", APART FROM THE MARK AS SHOWN.

CLASS 37—CONSTRUCTION AND REPAIR

FOR REPAIR, MAINTENANCE, AND INSTALLATION OF MACHINERY FOR BLASTING, CLEANING, COATING, ETCHING, DEBURRING, DESCALING, PROFILING, FINISHING, SHAPING, AND PEENING METALS, DUST COLLECTION, AUTOMATIC PAINTING, AND POWER OPERATED SAWS AND GRINDERS (U.S. CLS. 100, 103 AND 106).

FIRST USE 12-1-2003; IN COMMERCE 12-1-2003.

CLASS 40—MATERIAL TREATMENT

FOR CUSTOM MANUFACTURE OF MACHINERY FOR BLASTING, CLEANING, COATING, ETCHING, DESCALING, DEBURRING, DUST COLLECTING, PROFILING, FINISHING, CUTTING, SAWING, ABRADING, SCARIFING, PAINTING, AND PEENING METALS; SURFACE PREPARATION AND FINISHING SERVICES, NAMELY, BLASTING, CLEANING, ETCHING, POLISHING, DESCALING, DEBURRING, DUST COLLECTING, PROFILING, FINISHING, CUTTING, SAWING, ABRADING, SCARIFING, DUST COLLECTING, PAINTING, AND PEENING METALS (U.S. CLS. 100, 103 AND 106).

FIRST USE 12-1-2003; IN COMMERCE 12-1-2003.

CLASS 41—EDUCATION AND ENTERTAINMENT

FOR TRAINING SERVICES IN THE FIELD OF SURFACE PREPARATION, NAMELY, TRAINING IN THE OPERATION OF MACHINERY FOR BLASTING, CLEANING, ETCHING, POLISHING, DESCALING, DEBURRING, DUST COLLECTING, PROFILING, FINISHING, CUTTING, SAWING, ABRADING, SCARIFING, PAINTING, AND PEENING METALS (U.S. CLS. 100, 101 AND 107).

FIRST USE 12-1-2003; IN COMMERCE 12-1-2003.

3,568,573. OMRON LASERFRONT INC., KANAGAWA-KEN, JAPAN. SN 78-351,281. PUB. 9-20-2005, FILED 1-13-2004.

LASERFRONT

THE MARK CONSISTS OF STANDARD CHARACTERS WITHOUT CLAIM TO ANY PARTICULAR FONT, STYLE, SIZE, OR COLOR.

CLASS 7—MACHINERY

FOR LASER PROCESSING MACHINES, NAMELY, LASER MACHINES FOR TRIMMING, SCRIBING, CUTTING, WELDING, DRILLING, SURFACE TREATMENT, MATERIAL DEPOSITION, REMOVING, MARKING, SOLDERING, MELTING, SINTERING, REPAIRING, ANNEALING, AND/OR CLEANING; LASER TESTING MACHINES FOR ELECTRIC DISCHARGE (U.S. CLS. 13, 19, 21, 23, 31, 34 AND 35).

FIRST USE 4-20-2004; IN COMMERCE 11-14-2006.

CLASS 9—ELECTRICAL AND SCIENTIFIC APPARATUS

FOR LASERS NOT FOR MEDICAL USE, AND PARTS THEREFOR; LASER OSCILLATORS; SWITCH UNITS FOR LASER OSCILLATORS; PROTECTIVE GLASSES FOR YAG LASER; ELECTRICAL CONTROLLERS FOR LASER PROCESSING MACHINES; OPTICAL SCANNERS FOR LASER MACHINING UNITS; OPTICAL LENSES, OPTICAL MIRRORS, AND OPTICAL READERS, USED IN COMBINATION AS AN OPTICAL SYSTEM FOR LASER MACHINING UNITS; FIBER OPTICS, OPTICAL LENSES, AND OPTICAL MIRRORS USED IN COMBINATION AS AN OPTICAL SYSTEM FOR LASER MACHINING UNITS; LASER DIODES FOR LASER OSCILLATORS (U.S. CLS. 21, 23, 26, 36 AND 38).

FIRST USE 7-14-2004; IN COMMERCE 11-14-2006.

CLASS 11—ENVIRONMENTAL CONTROL APPARATUS

FOR LAMPS AS LASER COMPONENTS, NAMELY, PUMPING EXCITATION LAMPS FOR LASER OSCILLATORS (U.S. CLS. 13, 21, 23, 31 AND 34).

FIRST USE 4-15-2004; IN COMMERCE 1-1-2006.

3,568,575. SCHOLAR BALLER I.M.A.G.E., LLC, MESA, AZ. SN 78-385,765. PUB. 8-16-2005, FILED 3-17-2004.

SCHOLAR-BALLER

THE MARK CONSISTS OF STANDARD CHARACTERS WITHOUT CLAIM TO ANY PARTICULAR FONT, STYLE, SIZE, OR COLOR.

CLASS 25—CLOTHING

FOR APPAREL, NAMELY, SHIRTS, JACKETS, SWEATERS, SHORTS, PANTS, SWEATSHIRTS, HATS, VISORS, FOOTWEAR, SOCKS, AND UNDERGARMENTS (U.S. CLS. 22 AND 39).

FIRST USE 3-17-2004; IN COMMERCE 3-17-2004.

CLASS 41—EDUCATION AND ENTERTAINMENT

FOR EDUCATIONAL SERVICES, NAMELY, CONDUCTING CLASSES, SEMINARS, CONFERENCES AND WORKSHOPS IN THE FIELD OF LEADERSHIP TRAINING AND COUNSELING, ACADEMIC ACHIEVEMENT AND ATHLETICS AND PHYSICAL EDUCATION (U.S. CLS. 100, 101 AND 107).

FIRST USE 3-14-2004; IN COMMERCE 3-14-2004.

3,568,588. LEGAL AID SOCIETY OF ORANGE COUNTY, SANTA ANA, CA. SN 78-477,918. PUB. 8-23-2005, FILED 9-2-2004.

LEGAL GENIE

THE MARK CONSISTS OF STANDARD CHARACTERS WITHOUT CLAIM TO ANY PARTICULAR FONT, STYLE, SIZE, OR COLOR.

NO CLAIM IS MADE TO THE EXCLUSIVE RIGHT TO USE "LEGAL", APART FROM THE MARK AS SHOWN.

CLASS 35—ADVERTISING AND BUSINESS

3,568,585. AERO PRODUCTS INTERNATIONAL, INC., SCHAUMBURG, IL. SN 78-450,306. PUB. 9-6-2005, FILED 7-14-2004.

FOR LAWYER REFERRAL SERVICE (U.S. CLS. 100, 101 AND 102).

FIRST USE 11-13-2008; IN COMMERCE 11-13-2008.

CLASS 42—SCIENTIFIC AND COMPUTER SERVICES

FOR LEGAL SERVICES, NAMELY, LEGAL ADVICE AND COUNSELING AND LEGAL DOCUMENT PREPARATION SERVICES (U.S. CLS. 100 AND 101).

FIRST USE 11-13-2008; IN COMMERCE 11-13-2008.

**A GREAT NIGHT'S
SLEEP IS IN THE BAG**

3,568,593. SELLS GOALKEEPER PRODUCTS LIMITED, LONDON, UNITED KINGDOM. SN 78-508,436. PUB. 2-13-2007, FILED 10-29-2004.

SELLS

THE MARK CONSISTS OF STANDARD CHARACTERS WITHOUT CLAIM TO ANY PARTICULAR FONT, STYLE, SIZE, OR COLOR.

NO CLAIM IS MADE TO THE EXCLUSIVE RIGHT TO USE "BAG", APART FROM THE MARK AS SHOWN.

CLASS 20—FURNITURE AND ARTICLES NOT OTHERWISE CLASSIFIED

FOR INFLATABLE FURNITURE FOR INDOOR AND OUTDOOR USE (U.S. CLS. 2, 13, 22, 25, 32 AND 50).

FIRST USE 10-6-2008; IN COMMERCE 10-6-2008.

CLASS 28—TOYS AND SPORTING GOODS

FOR INFLATABLE FURNITURE FOR RECREATIONAL USE, NAMELY, INFLATABLE MATTRESSES (U.S. CLS. 22, 23, 38 AND 50).

FIRST USE 10-6-2008; IN COMMERCE 10-6-2008.

THE MARK CONSISTS OF STANDARD CHARACTERS WITHOUT CLAIM TO ANY PARTICULAR FONT, STYLE, SIZE, OR COLOR.

CLASS 18—LEATHER GOODS

FOR BAGS, NAMELY, HOLDALLS, SPORTS KIT BAGS, GYM SACKS, RUCKSACKS; LUGGAGE; PURSES WALLETS (U.S. CLS. 1, 2, 3, 22 AND 41).

FIRST USE 6-1-2004; IN COMMERCE 6-1-2004.

CLASS 25—CLOTHING

FOR CLOTHING, NAMELY, T-SHIRTS, SWEATSHIRTS, SHORTS, JERSEYS, UNDERSHIRTS, PANTS, ALL FOR USE BY SOCCER PLAYERS; FOOTWEAR; HEADGEAR, NAMELY, CAPS, VISORS (U.S. CLS. 22 AND 39).

FIRST USE 6-1-2004; IN COMMERCE 6-1-2004.

CLASS 28—TOYS AND SPORTING GOODS

FOR SPORTING AND GYMNASTIC EQUIPMENT RELATING TO THE GAME OF SOCCER, NAMELY, BALLS; TRAINING BALLS; SHIN GUARDS FOR ATHLETIC USE; KNEE GUARDS FOR ATHLETIC USE; ELBOW GUARDS FOR ATHLETIC USE; AND GOAL-KEEPER GLOVES (U.S. CLS. 22, 23, 38 AND 50).
FIRST USE 6-1-2002; IN COMMERCE 6-1-2002.

3,568,596. GCA SERVICES GROUP, INC., CLEVELAND, OH. SN 78-539,577. PUB. 9-5-2006, FILED 12-29-2004.

QUALITY • MEASURED. MANAGED. GUARANTEED.

CLASS 35—ADVERTISING AND BUSINESS

FOR MAIL SORTING, HANDLING AND RECEIVING (U.S. CLS. 100, 101 AND 102).
FIRST USE 12-0-2006; IN COMMERCE 12-0-2006.

CLASS 37—CONSTRUCTION AND REPAIR

FOR CLEANING SERVICES, NAMELY, JANITORIAL AND CUSTODIAL SERVICES; CLEANING OF THE INTERIOR OF BUILDING; OFFICE, POST-CONSTRUCTION SITE, AND INDUSTRIAL PREMISES CLEANING SERVICES; WINDOW CLEANING SERVICES; CARPET AND RUG CLEANING SERVICES; FLOOR MAINTENANCE AND RESTORATION SERVICES; FURNITURE CLEANING SERVICES; PAINTING SERVICES; CLEANING, AND MAINTENANCE OF CLEAN ROOM FACILITIES; BUILDING MAINTENANCE AND REPAIR SERVICES; MAINTENANCE AND PREVENTATIVE MAINTENANCE SERVICES FOR HEATING, VENTILATING AND AIR CONDITIONING SYSTEMS (U.S. CLS. 100, 103 AND 106).
FIRST USE 12-0-2006; IN COMMERCE 12-0-2006.

CLASS 39—TRANSPORTATION AND STORAGE

FOR PORTER SERVICES; FURNITURE MOVING (U.S. CLS. 100 AND 105).
FIRST USE 12-0-2006; IN COMMERCE 12-0-2006.

CLASS 44—MEDICAL, BEAUTY AND AGRICULTURAL SERVICES

FOR LANDSCAPE GARDENING; LAWN CARE AND LAWN MOWING SERVICES FOR OTHERS (U.S. CLS. 100 AND 101).
FIRST USE 12-0-2006; IN COMMERCE 12-0-2006.

3,568,600. WANER, JANE M., LITTLE ROCK, AR. SN 78-567,076. PUB. 7-22-2008, FILED 2-14-2005.

DERMATEEN

THE MARK CONSISTS OF STANDARD CHARACTERS WITHOUT CLAIM TO ANY PARTICULAR FONT, STYLE, SIZE, OR COLOR.

CLASS 3—COSMETICS AND CLEANING PREPARATIONS

FOR TOPICAL SKINCARE PRODUCTS, NAMELY, SKIN CLEANSERS, SKIN TONER CREAMS, SKIN LOTIONS (U.S. CLS. 1, 4, 6, 50, 51 AND 52).
FIRST USE 2-0-2007; IN COMMERCE 2-0-2007.

CLASS 5—PHARMACEUTICALS

FOR ACNE TREATMENT CREAMS (U.S. CLS. 6, 18, 44, 46, 51 AND 52).
FIRST USE 2-0-2007; IN COMMERCE 2-0-2007.

3,568,608. BUSINESS INTEGRITY LIMITED, LONDON, UNITED KINGDOM. SN 78-656,286. PUB. 9-26-2006, FILED 6-22-2005.

DealBuilder

THE MARK CONSISTS OF STANDARD CHARACTERS WITHOUT CLAIM TO ANY PARTICULAR FONT, STYLE, SIZE, OR COLOR.

CLASS 9—ELECTRICAL AND SCIENTIFIC APPARATUS

FOR (BASED ON USE IN COMMERCE) COMPUTER SOFTWARE FOR CONTRACT DOCUMENT AUTOMATION AND ASSEMBLY FEATURING CONTRACT PROCESS AUTOMATION, CONTRACT PREPARATION AND MANAGEMENT, AND MANAGEMENT OF CONTRACT PRECEDENTS, CONTRACT TEMPLATES, CONTRACT STANDARDS AND CONTRACT MODELS (U.S. CLS. 21, 23, 26, 36 AND 38).
FIRST USE 1-1-2002; IN COMMERCE 5-31-2002.

CLASS 41—EDUCATION AND ENTERTAINMENT

FOR EDUCATIONAL SERVICES, NAMELY, CONDUCTING CLASSES AND SEMINARS FEATURING TRAINING IN THE USE OF COMPUTER SOFTWARE FOR DOCUMENT AUTOMATION AND ASSEMBLY THAT FEATURES ONE OR MORE OF CONTRACT AND CONTRACT PROCESS AUTOMATION, CONTRACT PREPARATION AND MANAGEMENT, AND MANAGEMENT OF PRECEDENTS, TEMPLATES STANDARDS AND MODELS (U.S. CLS. 100, 101 AND 107).
FIRST USE 12-1-2008; IN COMMERCE 12-1-2008.

CLASS 42—SCIENTIFIC AND COMPUTER SERVICES

FOR COMPUTER SOFTWARE DESIGN AND DEVELOPMENT FOR OTHERS OF COMPUTER SOFTWARE FOR CONTRACT DOCUMENT AUTOMATION AND ASSEMBLY FEATURING CONTRACT PROCESS AUTOMATION, CONTRACT PREPARATION AND MANAGEMENT, AND MANAGEMENT OF CONTRACT PRECEDENTS, CONTRACT TEMPLATES, CONTRACT STANDARDS AND CONTRACT MODELS; INSTALLATION OF COMPUTER SOFTWARE FOR CONTRACT DOCUMENT AUTOMATION AND ASSEMBLY FEATURING CONTRACT PROCESS AUTOMATION, CONTRACT PREPARATION AND MANAGEMENT, AND MANAGEMENT OF CONTRACT PRECEDENTS, CONTRACT TEMPLATES, CONTRACT STANDARDS AND CONTRACT MODELS; TECHNICAL SUPPORT SERVICES, NAMELY, TROUBLESHOOTING OF COMPUTER CONTRACT DOCUMENTATION AND AUTOMATION ASSEMBLY SOFTWARE PROBLEMS (U.S. CLS. 100 AND 101).

FIRST USE 12-1-2008; IN COMMERCE 12-1-2008.

3,568,614. LAVISH LASHES, LLC, RIVERSIDE, CA. SN 78-676,796. PUB. 4-24-2007, FILED 7-23-2005.

LAVISH LASHES

THE MARK CONSISTS OF STANDARD CHARACTERS WITHOUT CLAIM TO ANY PARTICULAR FONT, STYLE, SIZE, OR COLOR.

NO CLAIM IS MADE TO THE EXCLUSIVE RIGHT TO USE "LASHES", APART FROM THE MARK AS SHOWN.

CLASS 3—COSMETICS AND CLEANING PREPARATIONS

FOR ARTIFICIAL EYELASHES, EYELASH EXTENSIONS, COSMETICS, ADHESIVES FOR ATTACHING ARTIFICIAL EYELASHES AND/OR FINGERNAILS, ADHESIVES FOR COSMETIC USE, AMMONIA FOR CLEANING PURPOSES, ASTRINGENTS FOR COSMETIC PURPOSES, BODY SCRUBS, BODY CREAM, BODY EMULSIONS, ALL PURPOSE CLEANING PREPARATIONS, SKIN CLEANSING LOTION, DISINFECTANT SOAPS, EYE SHADOW, EYE GELS, EYEBROW PENCILS, MAKEUP REMOVER, MAKEUP, MAKEUP FOUNDATION, EYE MAKEUP REMOVER, EYE MAKEUP, FACIAL MAKEUP, MASCARA, MASSAGE OIL, MEDICATED SOAP, SKIN MOISTURIZER, PRE-MOISTENED COSMETIC TISSUES, PRE-MOISTENED COSMETIC TOWELETTES, PRE-MOISTENED COSMETIC WIPES, SKIN CLEANSERS, SKIN EMOLLIENTS, SKIN CLARIFIERS, SKIN TEXTURIZERS, SKIN SOAP, LIQUID SOAP, COTTON SWABS FOR COSMETIC PURPOSES, COTTON SWABS FOR PERSONAL USE, AND PERMANENT MAKEUP (U.S. CLS. 1, 4, 6, 50, 51 AND 52).

FIRST USE 3-15-2005; IN COMMERCE 3-15-2005.

CLASS 35—ADVERTISING AND BUSINESS

FOR RETAIL STORE AND WHOLESALE STORE SERVICES IN THE FIELD OF ARTIFICIAL EYELASHES, EYELASH EXTENSIONS AND COSMETICS; COMPUTERIZED ON-LINE RETAIL STORE AND WHOLESALE STORE SERVICES IN THE FIELD OF ARTIFICIAL EYELASHES, EYELASH EXTENSIONS AND COSMETICS; CONDUCTING TRADE SHOWS IN THE FIELD OF EYELASH EXTENSIONS AND ARTIFICIAL EYELASHES (U.S. CLS. 100, 101 AND 102).

FIRST USE 3-15-2005; IN COMMERCE 3-15-2005.

CLASS 41—EDUCATION AND ENTERTAINMENT

FOR ARRANGING PROFESSIONAL WORKSHOPS, TRAINING COURSES AND TRAINING SERVICES IN THE FIELD OF EYELASH EXTENSIONS AND ARTIFICIAL EYELASHES; PROVIDING ON-LINE EDUCATIONAL WORKSHOPS AND TRAINING COURSES IN THE FIELD OF EYELASH EXTENSIONS AND ARTIFICIAL EYELASHES (U.S. CLS. 100, 101 AND 107).

FIRST USE 3-15-2005; IN COMMERCE 3-15-2005.

3,568,619. DISCOVERY COMMUNICATIONS, LLC, SILVER SPRING, MD. SN 78-722,378. PUB. 8-21-2007, FILED 9-28-2005.

MIAMI INK

THE MARK CONSISTS OF STANDARD CHARACTERS WITHOUT CLAIM TO ANY PARTICULAR FONT, STYLE, SIZE, OR COLOR.

NO CLAIM IS MADE TO THE EXCLUSIVE RIGHT TO USE "MIAMI" FOR CLASS 9 GOODS, APART FROM THE MARK AS SHOWN.

CLASS 9—ELECTRICAL AND SCIENTIFIC APPARATUS

FOR DVDS AND MULTIMEDIA SOFTWARE RECORDED ON CD-ROM FEATURING CONTENT FROM OR RELATING TO APPLICANT'S TELEVISION SERIES OF THE SAME NAME; SUNGLASSES (U.S. CLS. 21, 23, 26, 36 AND 38).

FIRST USE 7-0-2007; IN COMMERCE 7-0-2007.

CLASS 16—PAPER GOODS AND PRINTED MATTER

FOR PLAYING CARDS, WALL CALENDARS, TEMPORARY TATTOOS (U.S. CLS. 2, 5, 22, 23, 29, 37, 38 AND 50).

FIRST USE 6-0-2006; IN COMMERCE 6-0-2006.

CLASS 25—CLOTHING

FOR FOOTWEAR, T-SHIRTS, PAJAMAS, HATS, CAPS, SWEATSHIRTS, UNDERWEAR, BANDANNAS (U.S. CLS. 22 AND 39).

FIRST USE 1-0-2006; IN COMMERCE 1-0-2006.

3,568,627. BATH & BODY WORKS BRAND MANAGEMENT, INC., REYNOLDSBURG, OH. SN 78-766,805. PUB. 8-7-2007, FILED 12-5-2005.

BATH & BODY WORKS CLASSICS

THE MARK CONSISTS OF STANDARD CHARACTERS WITHOUT CLAIM TO ANY PARTICULAR FONT, STYLE, SIZE, OR COLOR.

OWNER OF U.S. REG. NOS. 1,742,062, 2,396,469, AND OTHERS.

NO CLAIM IS MADE TO THE EXCLUSIVE RIGHT TO USE "BATH & BODY", APART FROM THE MARK AS SHOWN.

CLASS 3—COSMETICS AND CLEANING PREPARATIONS

FOR PERSONAL CARE PRODUCTS, NAMELY, AFTER SHAVE, AFTER SHAVE BALM, AGE SPOT LIGHTENER, ANTIPERSPIRANTS FOR PERSONAL USE, ASTRINGENT FOR THE FACE, ASTRINGENT FOR THE SKIN, BATH BEADS, BATH CREAM, BATH CUBES, BATH FIZZIES, BATH FOAM, BATH MILK, BATH OIL, BATH SALTS, NON-MEDICATED BODY SOAKS, BLEMISH CORRECTOR, NAMELY, FACIAL CONCEALERS, BLEMISH STICK, NAMELY, BODY CONCEALER BLUSH, BODY BALM, BODY SOAP BAR, BODY BUTTER, BODY CREAM, BODY ESSENCE IN THE NATURE OF A BODY SPRAY WITH A FRAGRANCE, BODY GEL, BODY GLITTER, BODY LOTION, BODY MASK, BODY MIST, BODY OIL, BODY PAINT, BODY POWDER, BODY SCRUB, BODY SMOOTHER, BODY SOAP, BODY SPLASH, BODY WASH, BUBBLE BATH, BUFFING BAR, COLOGNE, CREAM BODY WASH, CREAM CLEANSER, CUTICLE CREAM, CUTICLE CREAM STICK, CUTICLE OIL PEN, PERSONAL DEODORANTS, ESSENTIAL OILS, EXFOLIATOR FOR THE FEET, NAMELY, FOOT EXFOLIATING LOTION, EYE SUNSCREEN BLOCK, EYE CREAM, EYE GEL, EYE MASK, EYE REPAIR CREAM, FACE BALM, FACE BLOCK, FACE CLEANSER, FACE CREAM, FACE GEL, FACE LOTION, FACE MASK, FACE MIST SPRAY, FACE MOISTURIZER, FACE POLISHER, FACE POWDER, FACE SCRUB, FACE SOAP, FACE WASH, FOAM BATH, FOOT CREAM, FOOT LOTION, FOOT POWDER, FOOT SCRUB, FOOT SOAK, FOOT SPRAY, GEL FACE WASH, GLYCERIN SOAP, HAIR CONDITIONER, HAIR DETANGLER, HAIR DYE, HAIR GEL, HAIR GLITTER, HAIR INHIBITOR LOTION, HAIR MASCARA, HAIR MIST SPRAY, HAIR POMADE, HAIR RECONSTRUCTING CREAM, HAIR REMOVING CREAM, HAIR REPAIR, HAIR RINSE, HAIR SHAMPOO, HAIR SHINE SERUM, HAIR SPRAY, HAIR STRAIGHTENING CREAM, HAIR STYLING MOUSSE, HAND BALM, HAND CLEANSING SPRAY, HAND CREAM, HAND EXFOLIATOR, NAMELY, EXFOLIATING HAND SKIN CREAM, HAND LOTION, HAND RENEWING LOTION, HAND SOAP, HAND WASH, LEG BRONZING CREAM, LEG REFRESHER IN THE NATURE OF LEG SPRAY, LINE PREVENTION CONCENTRATE, LINE PREVENTION SERUM, LINE REDUCING CONCENTRATE, LINE REDUCING SERUM, LIP BALM, LIP BLOCK, LIP GLOSS, LIP PAINT, NON-MEDICATED LIP PROTECTOR BALM, LIP SHINE, LIP TINT, MASSAGE CREAM, MASSAGE LOTION, MASSAGE OIL, MINERAL BATH, MOOD ENHANCING MASSAGE OINTMENT, NON-MEDICATED COSMETIC MOOD ENHANCING MIST IN THE NATURE OF FRAGRANCED SPRAY, MOOD ENHANCING SKIN CREAM, NAIL CORRECTOR PEN IN THE NATURE OF NAIL POLISH REMOVER IN PEN FORM, NAIL CREAM, NAIL POLISH, NAIL POLISH REMOVER, NAIL STENCILS, NIGHT EYE CREAM, NIGHT NOURISHING SKIN CREAM, OIL BLOTting SHEETS FOR THE SKIN, OIL BODY SPRAY, NON-MEDICATED SKIN CREAM PENETRATING RUB, PERFUME, PERFUME OILS, PILLOW MIST IN THE NATURE OF SCENTED FRAGRANCES FOR PILLOWS, POST-SUNTANNING LOTION FOR THE BODY, POTPOURRI, POWDER FOR THE FEET, PRE-SUNTANNING LOTION FOR THE BODY, PULSE POINT BEAUTY CREAM, PUMICE STONES FOR PERSONAL USE, REFILLS FOR ELECTRIC ROOM FRAGRANCE DISPENSERS, ROOM FRAGRANCE SPRAY, SACHETS, NON-MEDICATED SALT BODY SCRUB, NON-MEDICATED SEA SALT EXFOLIATING BODY OIL, SELF TANNING LOTION, SHAVING CREAM, SHEA BUTTER HAND CREAM, SHEA BUTTER CREAM TREATMENT STICK, SHOWER CREAM, SHOWER FOAM, SHOWER GEL, SHOWER SCRUB, SKIN BRONZING CREAM, NON-

MEDICATED SKIN CLEANSING WIPES, SKIN CREAM, SKIN EXFOLIATING CREAM, SKIN LOTION, SKIN MATTIFIER CREAM, SKIN MOISTURIZER, SKIN POLISHER, SKIN SCRUB, NON-MEDICATED SKIN SERUM, SKIN SMOOTHING OIL, SOAP, HAIR STYLING FOAM, SUGAR SKIN SCRUB, SUN SCREEN, SUNBLOCK FOR THE BODY, SUNBLOCK FOR THE FACE, SUNLESS TANNING CREAM, SUNLESS TANNING LOTION FOR THE BODY, SUNLESS TANNING LOTION FOR THE FACE, SUNTAN LOTION FOR THE BODY, SUNTAN LOTION FOR THE FACE, TALCUM POWDER (U.S. CLS. 1, 4, 6, 50, 51 AND 52).

FIRST USE 1-24-2006; IN COMMERCE 1-24-2006.

CLASS 35—ADVERTISING AND BUSINESS

FOR RETAIL STORE SERVICES, MAIL ORDER RETAIL STORE SERVICES AND ONLINE RETAIL STORE SERVICES ALL IN THE FIELD OF PERSONAL CARE PRODUCTS, COSMETICS, HOME FRAGRANCE PRODUCTS AND ACCESSORIES (U.S. CLS. 100, 101 AND 102).

FIRST USE 1-24-2006; IN COMMERCE 1-24-2006.

3,568,636. BLUE GROTTO TECHNOLOGIES, INC., PLYMOUTH MEETING, PA. SN 78-792,654. PUB. 3-6-2007, FILED 1-17-2006.

SLIDES - THE CURRENCY OF COMMUNICATION

THE MARK CONSISTS OF STANDARD CHARACTERS WITHOUT CLAIM TO ANY PARTICULAR FONT, STYLE, SIZE, OR COLOR.

CLASS 9—ELECTRICAL AND SCIENTIFIC APPARATUS

FOR COMPUTER PROGRAMS FOR FACILITATING COLLABORATION AMONG GROUPS OF PERSONS IN THE CREATION AND EDITING OF SLIDE KITS RELATING TO VARIOUS SUBJECTS (U.S. CLS. 21, 23, 26, 36 AND 38).

FIRST USE 3-31-2007; IN COMMERCE 3-31-2007.

CLASS 35—ADVERTISING AND BUSINESS

FOR PROVIDING A WEB SITE RESTRICTED TO A LIMITED NUMBER OF INDIVIDUALS WHICH ENABLE GROUPS OF PERSONS TO COLLABORATE IN THE CREATION AND EDITING OF SLIDE KITS FOR USE IN BUSINESS (U.S. CLS. 100, 101 AND 102).

FIRST USE 11-25-2008; IN COMMERCE 11-25-2008.

3,568,642. OUR NETWORKING CANADA LTD., THORNHILL, CANADA. SN 78-815,202. PUB. 9-4-2007, FILED 2-15-2006.

GUY4GAME

THE MARK CONSISTS OF STANDARD CHARACTERS WITHOUT CLAIM TO ANY PARTICULAR FONT, STYLE, SIZE, OR COLOR.

CLASS 36—INSURANCE AND FINANCIAL

FOR ON-LINE BROKERAGE SERVICES IN THE FIELD OF ROLE PLAYING GAME CHARACTER POWER LEVELING, AND VIRTUAL CURRENCY FOR ONLINE ROLE PLAYING GAMES (U.S. CLS. 100, 101 AND 102).

FIRST USE 6-25-2004; IN COMMERCE 6-25-2004.

CLASS 41—EDUCATION AND ENTERTAINMENT

FOR PROVIDING AN ONLINE WEBSITE FEATURING INFORMATION ABOUT ONLINE COMPUTER GAMES, TIPS AND STRATEGIES FOR COMPUTER GAMES, AND NEWS CONCERNING COMPUTER GAMES; PROVIDING ONLINE INFORMATION RELATING TO VIDEO GAMES, COMPUTER GAMES AND RELATED COMPUTER ENHANCEMENTS FOR GAMES (U.S. CLS. 100, 101 AND 107).

FIRST USE 11-26-2008; IN COMMERCE 11-26-2008.

3,568,647. SERMO, INC., CAMBRIDGE, MA. SN 78-841,002.
PUB. 3-27-2007, FILED 3-20-2006.

SERMO

THE MARK CONSISTS OF STANDARD CHARACTERS WITHOUT CLAIM TO ANY PARTICULAR FONT, STYLE, SIZE, OR COLOR.

CLASS 35—ADVERTISING AND BUSINESS

FOR CONDUCTING MARKETING STUDIES USING SOCIAL NETWORK THEORY, PREDICTION MARKETS AND METHODS OR SYSTEMS FOR THE ARBITRAGE OF INFORMATION INCLUDING THE DETECTION AND SURVEY OF TRENDS IN VARIOUS MARKETS; BUSINESS CONSULTING SERVICES IN THE FIELD OF CONNECTING EXPERTS WITH BUYERS WHO PURCHASE EXPERTISE AND SYSTEMS THAT COLLECTIVELY HARNESS THE INSIGHTS OF INDIVIDUALS (U.S. CLS. 100, 101 AND 102).

FIRST USE 3-21-2006; IN COMMERCE 3-21-2006.

CLASS 38—COMMUNICATION

FOR VIRTUAL CHATROOMS FOR A VIRTUAL COLLABORATIVE COMMUNITY OF PROFESSIONALS THAT MAKE OBSERVATIONS ABOUT THEIR EXPERTISE INCLUDING CARE OF PATIENTS, USE OF MEDICAL DEVICES AND PHARMACEUTICALS (U.S. CLS. 100, 101 AND 104).

FIRST USE 3-21-2006; IN COMMERCE 3-21-2006.

CLASS 42—SCIENTIFIC AND COMPUTER SERVICES

FOR COMPUTER SERVICES, NAMELY, HOSTING AN INTERACTIVE WEBSITE FOR A VIRTUAL COLLABORATIVE COMMUNITY OF MEDICAL PROFESSIONALS THAT MAKE OBSERVATIONS ABOUT THEIR EXPERTISE INCLUDING CARE OF PATIENTS, USE OF MEDICAL DEVICES AND PHARMACEUTICALS (U.S. CLS. 100 AND 101).

FIRST USE 3-21-2006; IN COMMERCE 3-21-2006.

3,568,650. DELPHILINK LLC, MOUNTAIN VIEW, CA. SN 78-857,919. PUB. 5-15-2007, FILED 4-10-2006.

Masque Number

THE MARK CONSISTS OF STANDARD CHARACTERS WITHOUT CLAIM TO ANY PARTICULAR FONT, STYLE, SIZE, OR COLOR.

NO CLAIM IS MADE TO THE EXCLUSIVE RIGHT TO USE "NUMBER", APART FROM THE MARK AS SHOWN.

CLASS 38—COMMUNICATION

FOR TELEPHONE COMMUNICATION SERVICES, NAMELY, PROVIDING A COMPREHENSIVE, UNIVERSAL TEMPORARY TELEPHONE NUMBER ACCOUNT WHICH OPERATES AS AN INBOUND AND OUTBOUND PROXY FOR ONE OR MORE OTHER CONTACT PHONE NUMBERS USED TO MAINTAIN PRIVACY FOR ACTUAL TELEPHONE NUMBERS ASSOCIATED WITH TELECOMMUNICATION LINES (U.S. CLS. 100, 101 AND 104).

FIRST USE 4-26-2006; IN COMMERCE 8-24-2006.

CLASS 42—SCIENTIFIC AND COMPUTER SERVICES

FOR COMPUTER SERVICES, NAMELY, PROVIDING TEMPORARY USE OF ON-LINE, NON-DOWNLOADABLE SOFTWARE FOR ON-LINE COMMUNITY COMMUNICATION SERVICES, NAMELY, PROVIDING INTERFACE FOR INTEGRATING EXISTING INTERNET-USER COMMUNITIES WITH A COMPREHENSIVE, UNIVERSAL TELEPHONE NUMBER ACCOUNT WHICH OPERATES AS AN INBOUND AND OUTBOUND PROXY FOR ONE OR MORE OTHER CONTACT PHONE NUMBERS USED TO MAINTAIN AND PROTECT PRIVACY FOR ACTUAL PHONE NUMBERS ASSOCIATED WITH TELECOMMUNICATIONS LINES (U.S. CLS. 100 AND 101).

FIRST USE 4-26-2006; IN COMMERCE 8-24-2006.

3,568,651. IGUIDE, INC., WALTHAM, MA. SN 78-859,683.
PUB. 9-4-2007, FILED 4-12-2006.

NAMEMEDIA

THE MARK CONSISTS OF STANDARD CHARACTERS WITHOUT CLAIM TO ANY PARTICULAR FONT, STYLE, SIZE, OR COLOR.

CLASS 35—ADVERTISING AND BUSINESS

FOR DISSEMINATION OF ADVERTISING FOR OTHERS ON A GLOBAL COMPUTER NETWORK; BROKERAGE IN THE FIELD OF INTERNET DOMAIN NAMES, NAMELY, MATCHING BUYERS AND SELLERS OF INTERNET DOMAIN NAMES; PROVIDING ON-LINE DIRECTORY INFORMATION SERVICES REGARDING A WIDE VARIETY OF SUBJECTS, ALSO FEATURING HYPERLINKS TO OTHER WEB SITES; ON-LINE ADVERTISING AND MARKETING SERVICES, NAMELY, DIRECT ONLINE MARKETING FOR THE PURPOSE OF ACQUIRING CUSTOMERS FOR OTHERS VIA GLOBAL COMPUTER NETWORKS' AND SERVICES RELATING TO THE ANALYSIS, EVALUATION, CREATION AND BRAND ESTABLISHMENT OF DOMAIN NAMES (U.S. CLS. 100, 101 AND 102).

FIRST USE 6-30-2006; IN COMMERCE 6-30-2006.

CLASS 42—SCIENTIFIC AND COMPUTER SERVICES

FOR COMPUTER SERVICES, NAMELY, HOSTING OF WEB SITES FOR OTHERS; WEB SITE DEVELOPMENT FOR OTHERS; COMPUTER SERVICES, NAMELY, DEVELOPING AND HOSTING INTERNET PORTALS FEATURING A WIDE ARRAY OF INFORMATION AND ADVERTISING CONTENT (U.S. CLS. 100 AND 101).

FIRST USE 6-30-2006; IN COMMERCE 6-30-2006.

3,568,663. MULTIENLACE S.A., MEDELLÍN, COLOMBIA. SN 78-910,652. PUB. 7-17-2007, FILED 6-17-2006.



NO CLAIM IS MADE TO THE EXCLUSIVE RIGHT TO USE "CONTACT CENTER", APART FROM THE MARK AS SHOWN.

THE MARK CONSISTS OF THREE CURVED LINES, POSITIONED HORIZONTALLY, ALL INTERRUPTED IN A DIFFERENT SPOT, TO THE LEFT SIDE OF THE WORDS "CONTACT CENTER MULTIENLACE SOLUCIONES PARA CONTACTOS EFECTIVOS"

THE FOREIGN WORDING IN THE MARK TRANSLATES INTO ENGLISH AS MULTILINK SOLUTIONS FOR EFFECTIVE CONTACTS.

CLASS 35—ADVERTISING AND BUSINESS

FOR BUSINESS MANAGEMENT AND CONSULTATION SERVICES PROVIDED TO COMPANIES THAT OUTSOURCE CALL CENTERS WITH NATIONWIDE COVERAGE, COMPUTER MESSAGING SERVICES WHEREIN OPERATORS RECEIVE ONLINE CONTACTS AND MESSAGES FROM CUSTOMERS AND RESPOND TO THOSE MESSAGES, SERVICES OF BACK OFFICE AGENTS VIA TELECOMMUNICATIONS FOR OPERATIONS OF ASSISTANCE TO CUSTOMER SUPPORT, CONTACT CENTERS VIA TELECOMMUNICATIONS TO ATTEND TO THE NEEDS OF THE CUSTOMERS TO WHICH THE CLIENT PROVIDES ITS SERVICES (U.S. CLS. 100, 101 AND 102).

FIRST USE 12-31-1997; IN COMMERCE 12-31-2005.

CLASS 38—COMMUNICATION

FOR TELECOMMUNICATIONS CONSULTATION SERVICES PROVIDED TO COMPANIES THAT OUTSOURCE CALL CENTERS WITH NATIONWIDE COVERAGE, COMPUTER MESSAGING SERVICES WHEREIN OPERATORS RECEIVE ONLINE CONTACTS AND MESSAGES FROM CUSTOMERS AND RESPOND TO THOSE MESSAGES, SERVICES OF BACK OFFICE AGENTS VIA TELECOMMUNICATIONS FOR OPERATIONS OF ASSISTANCE TO CUSTOMER SUPPORT, CONTACT CENTERS VIA TELECOMMUNICATIONS TO ATTEND TO THE NEEDS OF THE CUSTOMERS TO WHICH THE CLIENT PROVIDES ITS SERVICES (U.S. CLS. 100, 101 AND 104).

FIRST USE 12-31-1997; IN COMMERCE 12-31-2005.

3,568,678. FRANK BRUNCKHORST CO., L.L.C., BROOKLYN, NY. SN 78-933,951. PUB. 3-13-2007, FILED 7-20-2006.

**CLASS 29—MEATS AND PROCESSED FOODS**

FOR PROCESSED MEATS, CHEESES, FRANKFURTERS, BACON, SAUSAGES, BRATWURST, KNOCKWURST, SAUERKRAUT, PICKLES, PROCESSED ONIONS (U.S. CL. 46).

FIRST USE 8-31-2006; IN COMMERCE 8-31-2006.

CLASS 30—STAPLE FOODS

FOR HORSERADISH, MUSTARD, BARBECUE SAUCE, HOT SAUCE, HAM GLAZE (U.S. CL. 46).

FIRST USE 11-30-2008; IN COMMERCE 11-30-2008.

3,568,688. MATTEL, INC., EL SEGUNDO, CA. SN 78-949,759. PUB. 9-25-2007, FILED 8-10-2006.

BARBIE AS THE ISLAND PRINCESS

THE MARK CONSISTS OF STANDARD CHARACTERS WITHOUT CLAIM TO ANY PARTICULAR FONT, STYLE, SIZE, OR COLOR.

OWNER OF U.S. REG. NOS. 689,055, 2,588,845, AND OTHERS.

CLASS 9—ELECTRICAL AND SCIENTIFIC APPARATUS

FOR ELECTRONICS, NAMELY, VIDEO GAME CARTRIDGES AND INTERACTIVE VIDEO GAME PROGRAMS (U.S. CLS. 21, 23, 26, 36 AND 38).

FIRST USE 12-9-2008; IN COMMERCE 12-9-2008.

3,568,702. OIKOS INTERNATIONAL LTD., 33 CANTON RD., KOWLOON, HONG KONG. SN 78-980,266. PUB. 7-24-2007, FILED 4-24-2006.

CLASS 28—TOYS AND SPORTING GOODS

FOR TOYS, GAMES AND PLAYTHINGS, NAMELY, DOLLS, DOLL CLOTHING, AND DOLL ACCESSORIES; TOY FIGURES; PLUSH TOYS (U.S. CLS. 22, 23, 38 AND 50).

FIRST USE 4-5-2007; IN COMMERCE 4-5-2007.

3,568,690. VERIZON TRADEMARK SERVICES LLC, ARLINGTON, VA. SN 78-952,081. PUB. 2-19-2008, FILED 8-15-2006.



OWNER OF U.S. REG. NOS. 2,879,802, 3,085,712, AND OTHERS.

NO CLAIM IS MADE TO THE EXCLUSIVE RIGHT TO USE "BUSINESS", APART FROM THE MARK AS SHOWN.

THE MARK CONSISTS OF "VERIZON BUSINESS" AND STACKED V DESIGN.

CLASS 38—COMMUNICATION

FOR CONSULTING IN THE FIELD OF TELECOMMUNICATIONS AND COMPUTERIZED COMMUNICATIONS (U.S. CLS. 100, 101 AND 104).

FIRST USE 1-23-2006; IN COMMERCE 1-23-2006.

CLASS 42—SCIENTIFIC AND COMPUTER SERVICES

FOR WEB PAGE HOSTING SERVICES, OPERATING ELECTRONIC INFORMATION NETWORKS; DESIGN IN THE FIELD OF TELECOMMUNICATIONS AND COMPUTERIZED COMMUNICATIONS; CONSULTING AND DESIGN SERVICES IN THE FIELD OF INFORMATION TECHNOLOGY, COMPUTER PROGRAMMING, DATA CENTER MANAGEMENT SERVICES AND GLOBAL COMPUTER NETWORKS; PROVIDING DATA CENTER SERVICE, NAMELY, THE CENTRALIZED INSTALLATION AND MANAGEMENT FOR OTHERS OF STORAGE USED BY AN APPLICATION SERVICE PROVIDER TO MAINTAIN DATABASE INFORMATION OF OTHERS; COLOCATION SERVICES, NAMELY, THE PROVISION OF A SECURE ENVIRONMENTALLY-CONTROLLED FACILITY AND TECHNICAL MONITORING FOR THE TELECOMMUNICATIONS EQUIPMENT OF OTHERS; HOSTING THE WEB SITES OF OTHERS ON A COMPUTER SERVER ON A GLOBAL COMPUTER NETWORK, HOSTING OF DIGITAL CONTENT ON THE INTERNET, MAINTENANCE OF WEBSITES FOR OTHERS; APPLICATION SERVICE PROVIDER (ASP) SERVICES, NAMELY, HOSTING COMPUTER SOFTWARE APPLICATIONS OF OTHERS; AUTHENTICATION SERVICES IN THE FIELDS OF TELECOMMUNICATIONS AND NETWORK SERVICES; PROVIDING TEMPORARY USE OF NON-DOWNLOADABLE NETWORK AUDITING SOFTWARE IN THE FIELDS OF SECURE COMMUNICATIONS AND DATA NETWORKS; DESIGN FOR OTHERS IN THE FIELD OF COMPUTERIZED COMMUNICATIONS AND DATA NETWORKS (U.S. CLS. 100 AND 101).

FIRST USE 1-23-2006; IN COMMERCE 1-23-2006.



THE MARK CONSISTS OF THE WORDING "OIKOS FOLLOW YOUR HEART" IN STYLIZED LETTERING, THE FIRST LETTER "O" IN "OIKOS" HAS A GEOMETRIC FIGURE IN THE CENTER OF THE LETTER, THE WORDING "FOLLOW YOUR HEART" APPEARS BELOW THE WORD "OIKOS" IN SMALLER LETTERS.

THE FOREIGN WORDING IN THE MARK TRANSLATES INTO ENGLISH AS "HOME".

CLASS 8—HAND TOOLS

FOR TABLEWARE SERVICES, NAMELY, KNIVES, FORKS AND SPOONS (U.S. CLS. 23, 28 AND 44).

FIRST USE 2-9-2007; IN COMMERCE 7-13-2007.

CLASS 21—HOUSEWARES AND GLASS

FOR NON-ELECTRIC PRESSURE COOKERS, BOXES OF GLASS, CAKE MOLDS, CERAMICS FOR HOUSEHOLD PURPOSES, NAMELY, CERAMIC FIGURINES, CERAMIC VASES, VESSELS, BOWLS, PLATES AND POTS, CLOSURES FOR POT LIDS, CONTAINERS FOR HOUSEHOLD OR KITCHEN USE EXCEPT IN PRECIOUS METAL, COOKERY MOLDS, COOKING POT SETS CONSISTING OF COOKING POTS OF VARYING SIZES, COOKING POTS, NON-ELECTRIC COOKING UTENSILS NAMELY GRILL COVERS AND WIRE BASKETS, COVERS FOR DISHES, CROCKERY, NAMELY, POTS, BOWLS, CUPS, NOT OF PRECIOUS METAL, CUFFING BOARDS FOR THE KITCHEN, EARTHENWARE, NAMELY, POTS, BOWLS, MUGS, FIGURINES, JARS, SCULPTURES, STATUETTES, STATUES, FRYING PANS, GLASS BOWLS, NON-ELECTRIC GRIDDLES, COOKING UTENSILS, NAMELY, GRILLS, THERMAL-INSULATED CONTAINERS FOR FOOD OR BEVERAGES, KITCHEN CONTAINERS NOT OF PRECIOUS METAL, KITCHEN UTENSILS NOT OF PRECIOUS METAL, NAMELY, SIEVES, SPATULAS, STRAINERS, TURNERS, KNIFE RESTS FOR THE TABLE, LUNCH BOXES, MIXING SPOONS, MOULDS, NAMELY, CHOCOLATE MOULDS, PASTRY MOULDS, CAKE MOULDS, MUGS NOT OF PRECIOUS METAL, PORCELAIN WARE, NAMELY, POTS, BOWLS, MUGS, FIGURINES, JARS, SCULPTURES, STATUETTES, STATUES, POT LIDS, POTS, KITCHEN UTENSILS, NAMELY, SPATULAS, SPICE RACKS, STEW-PANS, THERMALLY INSULATED CONTAINERS FOR FOOD (U.S. CLS. 2, 13, 23, 29, 30, 33, 40 AND 50).

FIRST USE 2-9-2007; IN COMMERCE 7-27-2007.

* * * * *

SECTION 2.— INTERNATIONAL CLASSIFICATION

The short titles associated below with the international class numbers are terms designed merely for quick identification and are not an official part of the international classification. The full names of international classes are given in section 6.1 of the trademark rules of practice.

The designation "U.S. Cl." appearing in this section refers to the U.S. class in effect prior to Sep. 1, 1973 rather than the international class which applies to applications filed on or after that date. For adoption of international classification see notice in the OFFICIAL GAZETTE of Jun. 26, 1973 (911 O.G. TM 210).

Application in one class

CLASS 1—CHEMICALS

3,568,012. CELL SIGNALING TECHNOLOGY, INC., DANVERS, MA. SN 76-663,495. PUB. 3-13-2007, FILED 7-21-2006.

SIGNALSLIDE

THE MARK CONSISTS OF STANDARD CHARACTERS WITHOUT CLAIM TO ANY PARTICULAR FONT, STYLE, SIZE, OR COLOR.

OWNER OF U.S. REG. NOS. 2,752,804 AND 2,917,856.

FOR REAGENTS FOR SCIENTIFIC AND CLINICAL RESEARCH USE, NAMELY, KITS CONTAINING NUCLEIC ACIDS, CONTROL CELLS AND/OR ANTIBODIES FOR THE DETECTION OF PROTEIN ACTIVITY OR EXPRESSION (U.S. CLS. 1, 5, 6, 10, 26 AND 46).

FIRST USE 3-26-2008; IN COMMERCE 3-26-2008.

3,568,072. POET RESEARCH, INC., SIOUX FALLS, SD. SN 77-051,811. PUB. 11-13-2007, FILED 11-28-2006.



THE MARK CONSISTS OF A STYLIZED LETTER "O" WHICH RESEMBLES A LEAF.

FOR ENZYME PREPARATIONS FOR USE IN THE FUEL INDUSTRY; MICROBIAL CONTROL AGENTS AND MICROBES FOR USE IN THE FUEL INDUSTRY; ORGANIC ACIDS AND BIO-COMPOSITES FOR USE IN THE FUEL INDUSTRY; PLANT-BASED POLYMERS FOR USE IN FURTHER MANUFACTURING; POLYMER COMPOSITIONS, AS A PLASTIC SUBSTITUTE OR PLASTIC ADDITIVE, USED IN THE MANUFACTURE OF COMMERCIAL AND INDUSTRIAL GOODS; SOIL ADDITIVES; AND SOIL AMENDMENTS (U.S. CLS. 1, 5, 6, 10, 26 AND 46).

FIRST USE 6-1-2008; IN COMMERCE 6-1-2008.

CLASS 1—(Continued).

3,568,334. MILLIPORE CORPORATION, BILLERICA, MA. SN 77-278,852. PUB. 3-4-2008, FILED 9-13-2007.

UCOE

THE MARK CONSISTS OF STANDARD CHARACTERS WITHOUT CLAIM TO ANY PARTICULAR FONT, STYLE, SIZE, OR COLOR.

FOR GENE EXPRESSION TECHNOLOGY REAGENTS, NAMELY, UBIQUITOUS CHROMATIN OPENING ELEMENTS, FOR INDUSTRIAL PURPOSES (U.S. CLS. 1, 5, 6, 10, 26 AND 46).

FIRST USE 12-31-2005; IN COMMERCE 12-31-2005.

3,568,406. R. HAMMER ENTERPRISES, INC., LONGVIEW, TX. SN 77-304,555. PUB. 4-1-2008, FILED 10-15-2007.

PERFORMA

THE MARK CONSISTS OF STANDARD CHARACTERS WITHOUT CLAIM TO ANY PARTICULAR FONT, STYLE, SIZE, OR COLOR.

FOR COUPLING AGENT FOR INDUSTRIAL USE, NAMELY, CHEMICAL GEL COMPOUNDS FOR USE IN TRANSMITTING ULTRASONIC VIBRATIONS FROM A TRANSDUCER TO AN OBJECT TO GAUGE THICKNESS (U.S. CLS. 1, 5, 6, 10, 26 AND 46).

FIRST USE 11-0-2007; IN COMMERCE 11-0-2007.

CLASS 1—(Continued).

3,568,479. LALLEMAND INC., MONTREAL, CANADA. SN 77-365,275. PUB. 5-20-2008, FILED 1-7-2008.

FLORAPAN

THE MARK CONSISTS OF STANDARD CHARACTERS WITHOUT CLAIM TO ANY PARTICULAR FONT, STYLE, SIZE, OR COLOR.

FOR CULTURES OF MICROORGANISMS OTHER THAN FOR MEDICAL AND VETERINARY USE (U.S. CLS. 1, 5, 6, 10, 26 AND 46).
FIRST USE 9-9-2008; IN COMMERCE 9-9-2008.

3,568,572. ARCHER-DANIELS-MIDLAND COMPANY, DECATUR, IL. SN 78-343,266. PUB. 3-8-2005, FILED 12-19-2003.

NOVAXAN

THE MARK CONSISTS OF STANDARD CHARACTERS WITHOUT CLAIM TO ANY PARTICULAR FONT, STYLE, SIZE, OR COLOR.

OWNER OF U.S. REG. NO. 3,090,220.
FOR XANTHAN GUM FOR USE AS AN INGREDIENT IN FOOD (U.S. CLS. 1, 5, 6, 10, 26 AND 46).
FIRST USE 3-0-2004; IN COMMERCE 3-0-2004.

3,568,581. KEY ENERGY SERVICES, INC., HOUSTON, TX. SN 78-417,021. PUB. 4-19-2005, FILED 5-11-2004.



THE COLOR(S) BLACK AND BLUE IS/ARE CLAIMED AS A FEATURE OF THE MARK.

CLASS 1—(Continued).

THE COLOR BLACK APPEARS IN THE WORD "STIM" AND THE COLOR BLUE APPEARS IN THE TERM "FLOW" AND RAINDROP DESIGN.

FOR COMBINATION OF CHEMICALS WHICH IS USED TO HELP INCREASE THE FLOW BACK OF VARIOUS FRACTURING FLUIDS USED IN HYDRAULIC FRACTURING PROCESSES IN THE COMPLETION AND RE-COMPLETION OF OIL AND GAS WELLS (U.S. CLS. 1, 5, 6, 10, 26 AND 46).
FIRST USE 5-31-2004; IN COMMERCE 5-31-2004.

3,568,643. SUN DRILLING PRODUCTS CORPORATION, BELLE CHASSE, LA. SN 78-816,266. PUB. 9-26-2006, FILED 2-16-2006.

FRACBLACK

THE MARK CONSISTS OF STANDARD CHARACTERS WITHOUT CLAIM TO ANY PARTICULAR FONT, STYLE, SIZE, OR COLOR.

FOR SYNTHETIC PROPPANT FOR USE IN FRACTURE STIMULATION OF OIL AND GAS RESERVOIRS (U.S. CLS. 1, 5, 6, 10, 26 AND 46).
FIRST USE 3-29-2007; IN COMMERCE 3-29-2007.

3,568,648. ADHESIVE ENGINEERING & SUPPLY, INC., RAYMOND, NH. SN 78-843,294. PUB. 6-5-2007, FILED 3-22-2006.

Signwelder

THE MARK CONSISTS OF STANDARD CHARACTERS WITHOUT CLAIM TO ANY PARTICULAR FONT, STYLE, SIZE, OR COLOR.

FOR INDUSTRIAL ADHESIVES FOR USE IN THE ASSEMBLY AND MAINTENANCE OF METAL, PLASTIC, AND COMPOSITE SIGNAGE (U.S. CLS. 1, 5, 6, 10, 26 AND 46).
FIRST USE 1-1-2007; IN COMMERCE 1-1-2007.

CLASS 1—(Continued).

3,568,676. BIO-BOTANICA, INC., HAUPPAUGE, NY. SN 78-933,064. PUB. 8-28-2007, FILED 7-19-2006.



NO CLAIM IS MADE TO THE EXCLUSIVE RIGHT TO USE "ORAC" AND "7", APART FROM THE MARK AS SHOWN.

THE COLOR(S) PURPLE, WHITE, BLUE, DARK PINK, GREEN, RED, AND BLACK IS/ARE CLAIMED AS A FEATURE OF THE MARK.

THE MARK CONSISTS OF THE COLOR PURPLE APPEARS IN THE CIRCLE CARRIER. THE COLOR WHITE APPEARS IN THE LETTERING "ORAC SUPER 7" IN THE CARRIER, IN THE BACKGROUND OF THE CIRCLE, AND IN THE FLESH OF THE MISCELLANEOUS FRUIT IN THE LOWER CENTER. THE COLOR DARK PINK APPEARS IN THE POMEGRANATE. THE COLOR GREEN APPEARS IN THE LEAVES. THE COLOR BLUE APPEARS IN THE BLUEBERRIES. THE COLOR BLACK APPEARS IN THE BLACKBERRIES AND MISCELLANEOUS BERRIES IN THE LOWER RIGHT. THE COLOR RED APPEARS IN THE POMEGRANATE, THE PEEL OF THE MISCELLANEOUS FRUIT IN THE LOWER CENTER, THE RASPBERRIES, AND THE MISCELLANEOUS BERRIES IN THE UPPER RIGHT.

FOR BIOTANICAL ESSENCES AND EXTRACTS AND PREPARATIONS FOR USE AS INGREDIENTS IN THE MANUFACTURE OF PHARMACEUTICALS, FOOD SUPPLEMENTS, COSMETICS AND PERSONAL CARE PREPARATIONS (U.S. CLS. 1, 5, 6, 10, 26 AND 46).

FIRST USE 4-1-2006; IN COMMERCE 4-1-2006.

CLASS 2—PAINTS

3,568,131. CROSSLINK TECHNOLOGY, ONTARIO, CANADA. SN 77-117,405. PUB. 3-4-2008, FILED 2-27-2007.

BLAZE FIGHTER

THE MARK CONSISTS OF STANDARD CHARACTERS WITHOUT CLAIM TO ANY PARTICULAR FONT, STYLE, SIZE, OR COLOR.

PRIORITY CLAIMED UNDER SEC. 44(D) ON CANADA APPLICATION NO. 1333505, FILED 2-1-2007.

FOR INTUMESCENT FIREPROOF COATINGS AND INTUMESCENT SEALER COATINGS FOR USE IN FIRE-PROOFING APPLICATIONS (U.S. CLS. 6, 11 AND 16).

FIRST USE 10-1-2008; IN COMMERCE 10-1-2008.

CLASS 2—(Continued).

3,568,455. DEAN, LESTER M., KANSAS CITY, MO. SN 77-341,848. PUB. 6-3-2008, FILED 12-1-2007.

Mulch Bright

THE MARK CONSISTS OF STANDARD CHARACTERS WITHOUT CLAIM TO ANY PARTICULAR FONT, STYLE, SIZE, OR COLOR.

NO CLAIM IS MADE TO THE EXCLUSIVE RIGHT TO USE "MULCH", APART FROM THE MARK AS SHOWN.

FOR CLEAR AND PIGMENTED COATINGS USED IN THE NATURE OF PAINT FOR COATING MULCH (U.S. CLS. 6, 11 AND 16).

FIRST USE 4-15-2008; IN COMMERCE 4-15-2008.

CLASS 3—COSMETICS AND CLEANING PREPARATIONS

3,568,040. OMP INC., LONG BEACH, CA. SN 77-007,945. PUB. 7-24-2007, FILED 9-26-2006.

OBAGI ELASTIDERM

THE MARK CONSISTS OF STANDARD CHARACTERS WITHOUT CLAIM TO ANY PARTICULAR FONT, STYLE, SIZE, OR COLOR.

OWNER OF U.S. REG. NOS. 2,114,897, 2,203,028, AND OTHERS.

FOR EYE CREAM; FACE CREAM; NECK CREAM; HAND CREAM (U.S. CLS. 1, 4, 6, 50, 51 AND 52).

FIRST USE 10-9-2006; IN COMMERCE 10-9-2006.

3,568,048. ROYAL APPLIANCE MFG. CO., GLENWILLOW, OH. SN 77-017,721. PUB. 7-10-2007, FILED 10-10-2006.

WORKING FOR A CLEANER WORLD

THE MARK CONSISTS OF STANDARD CHARACTERS WITHOUT CLAIM TO ANY PARTICULAR FONT, STYLE, SIZE, OR COLOR.

FOR NON-TOXIC, ENVIRONMENTALLY SENSITIVE HOUSEHOLD CLEANING PREPARATIONS (U.S. CLS. 1, 4, 6, 50, 51 AND 52).

FIRST USE 10-10-2006; IN COMMERCE 10-10-2006.

CLASS 3—(Continued).

3,568,199. AMOREPACIFIC CORPORATION, SEOUL, REPUBLIC OF KOREA. SN 77-173,576. PUB. 3-11-2008, FILED 5-4-2007.

LANEIGE PROFESSIONAL SELECTION - SHADOW

THE MARK CONSISTS OF STANDARD CHARACTERS WITHOUT CLAIM TO ANY PARTICULAR FONT, STYLE, SIZE, OR COLOR.

OWNER OF U.S. REG. NOS. 3,018,434, 3,233,852, AND OTHERS.

NO CLAIM IS MADE TO THE EXCLUSIVE RIGHT TO USE "PROFESSIONAL SELECTION - SHADOW", APART FROM THE MARK AS SHOWN.

FOR EYE SHADOW; MASCARAS; EYELINERS; EYE MAKE-UP REMOVERS (U.S. CLS. 1, 4, 6, 50, 51 AND 52). FIRST USE 7-0-2007; IN COMMERCE 7-0-2007.



3,568,255. GAZUL PRODUCCIONES, S.L.U., MADRID, SPAIN. SN 77-227,595. PUB. 11-27-2007, FILED 7-12-2007.

SIETE ALEJANDRO SANZ

THE MARK CONSISTS OF STANDARD CHARACTERS WITHOUT CLAIM TO ANY PARTICULAR FONT, STYLE, SIZE, OR COLOR.

THE NAME(S), PORTRAIT(S), AND/OR SIGNATURE(S) SHOWN IN THE MARK IDENTIFIES A LIVING INDIVIDUAL, WHOSE CONSENT(S) TO REGISTER IS SUBMITTED.

THE FOREIGN WORDING IN THE MARK TRANSLATES INTO ENGLISH AS SEVEN ALEJANDRO SANZ.

FOR PERFUMES (U.S. CLS. 1, 4, 6, 50, 51 AND 52). FIRST USE 9-30-2007; IN COMMERCE 9-30-2008.



3,568,297. BROX, LLC, VIRGINIA BEACH, VA. SN 77-258,012. PUB. 4-1-2008, FILED 8-17-2007.

PAWL'S BOUTIQUE

NO CLAIM IS MADE TO THE EXCLUSIVE RIGHT TO USE "BOUTIQUE", APART FROM THE MARK AS SHOWN.

FOR PET SHAMPOO, HAIR CONDITIONER, FRAGRANCE SPRAYS AND STAIN REMOVERS (U.S. CLS. 1, 4, 6, 50, 51 AND 52).

FIRST USE 2-1-2007; IN COMMERCE 6-13-2007.

CLASS 3—(Continued).

3,568,361. INDUSTRIA LA POPULAR, S.A., GUATEMALA CITY, GUATEMALA. SN 77-287,916. PUB. 3-11-2008, FILED 9-25-2007.

AQUA BAIN

THE MARK CONSISTS OF STANDARD CHARACTERS WITHOUT CLAIM TO ANY PARTICULAR FONT, STYLE, SIZE, OR COLOR.

NO CLAIM IS MADE TO THE EXCLUSIVE RIGHT TO USE "BAIN", APART FROM THE MARK AS SHOWN.

THE FOREIGN WORDING IN THE MARK TRANSLATES INTO ENGLISH AS BATH.

FOR COSMETICS; BODY LOTION; BODY SPRAY USED AS A PERSONAL DEODORANT AND AS FRAGRANCE; TALCUM POWDER; DEODORANT FOR PERSONAL USE; BAR SOAP; SHOWER GEL; LOTIONS FOR FOOT MOISTURIZING; BODY SPRAYS; FOOT DEODORANT SPRAY; EXFOLIANTS FOR FOOT AND HAND; SKIN CREAM; HAND CREAM; SUN BLOCK; SUN SCREEN; FOOT POWDER; CREAMS FOR CELLULITE REDUCTION; LOTIONS FOR CELLULITE REDUCTION; NON-MEDICATED SKIN CARE PREPARATIONS; HAND LOTIONS; BABY SHAMPOO; HAIR CARE KITS COMPRISING NON-MEDICATED HAIR CARE PREPARATIONS, NAMELY, SHAMPOOS, CONDITIONERS; SHAMPOO-CONDITIONERS; SHAMPOOS; CONDITIONERS; HAIR CONDITIONER; HAIR CARE CREAMS; HAIR OILS; HAIR GELS; HAIR STRAIGHTENING PREPARATIONS; HAIR STYLING GEL; HAIR STYLING PREPARATIONS (U.S. CLS. 1, 4, 6, 50, 51 AND 52).

FIRST USE 11-30-2008; IN COMMERCE 11-30-2008.



3,568,385. JOE WATSON, INC., NOKOMIS, FL. SN 77-294,722. PUB. 5-20-2008, FILED 10-3-2007.

NO SWEAT...GET A GRIP

THE MARK CONSISTS OF STANDARD CHARACTERS WITHOUT CLAIM TO ANY PARTICULAR FONT, STYLE, SIZE, OR COLOR.

OWNER OF U.S. REG. NO. 3,367,697.

FOR NON-MEDICATED LOTIONS FOR APPLICATION TO A PERSON'S HANDS, ARMS, AND LEGS TO REDUCE WETNESS (U.S. CLS. 1, 4, 6, 50, 51 AND 52).

FIRST USE 1-30-2006; IN COMMERCE 1-30-2006.

CLASS 3—(Continued).

3,568,409. DESIGNER SKIN, LLC, INDIANAPOLIS, IN. SN 77-308,657. PUB. 7-22-2008, FILED 10-19-2007.

DESIGNER SKIN BLACK

THE MARK CONSISTS OF STANDARD CHARACTERS WITHOUT CLAIM TO ANY PARTICULAR FONT, STYLE, SIZE, OR COLOR.

PRIORITY CLAIMED UNDER SEC. 44(D) ON PERU APPLICATION NO. 305030-2007, FILED 5-18-2007.

OWNER OF U.S. REG. NOS. 2,415,111, 2,865,390, AND OTHERS.

NO CLAIM IS MADE TO THE EXCLUSIVE RIGHT TO USE "SKIN", APART FROM THE MARK AS SHOWN.

FOR SKIN CARE PREPARATIONS, NAMELY, MOISTURIZERS, BRONZERS, INDOOR TANNING PREPARATIONS, SELF-TANNING LOTIONS AND SPRAYS, SUNLESS TANNING LOTIONS AND SPRAYS, AND LOTIONS TO ACCELERATE, EXTEND AND/OR ENHANCE TANS (U.S. CLS. 1, 4, 6, 50, 51 AND 52).

FIRST USE 11-0-2007; IN COMMERCE 11-0-2007.

3,568,419. COSMOPRO, INC., DAYTONA BEACH, FL. SN 77-316,854. PUB. 3-4-2008, FILED 10-30-2007.

PEVONIA ORGANICA

THE MARK CONSISTS OF STANDARD CHARACTERS WITHOUT CLAIM TO ANY PARTICULAR FONT, STYLE, SIZE, OR COLOR.

OWNER OF U.S. REG. NOS. 1,685,004 AND 1,707,674.

NO CLAIM IS MADE TO THE EXCLUSIVE RIGHT TO USE "ORGANICA", APART FROM THE MARK AS SHOWN.

THE FOREIGN WORDING IN THE MARK TRANSLATES INTO ENGLISH AS "ORGANIC".

FOR NON-MEDICATED SKIN CARE CREAMS AND LOTIONS; FACE CREAMS; NON-MEDICATED SKIN PEELING CREAMS AND GELS; SKIN ABRASIVE PREPARATIONS; FACIAL MASKS; NON-MEDICATED FOOT CREAMS AND POWDERS; NON-MEDICATED FOOT LOTIONS; NON-MEDICATED BODY CREAMS AND POWDERS; NON-MEDICATED BODY LOTION; NON-MEDICATED BATH SALTS; AND NON-MEDICATED EYE CREAMS; ALL OF THE FOREGOING GOODS MADE IN WHOLE OR IN SUBSTANTIAL PART OF ORGANIC INGREDIENTS (U.S. CLS. 1, 4, 6, 50, 51 AND 52).

FIRST USE 11-1-2007; IN COMMERCE 11-1-2007.

CLASS 3—(Continued).

3,568,482. THE PROCTER & GAMBLE COMPANY, CINCINNATI, OH. SN 77-367,480. PUB. 6-3-2008, FILED 1-9-2008.



OWNER OF U.S. REG. NOS. 2,296,103, 2,602,870, AND OTHERS.

NO CLAIM IS MADE TO THE EXCLUSIVE RIGHT TO USE "DUST & SHINE", APART FROM THE MARK AS SHOWN.

THE MARK CONSISTS OF THE WORDS "SWIFFER DUST & SHINE" SUPERIMPOSED ON AN "S"-SHAPED SWIRL, CONNECTING "SWIFFER" TO THE WORDS "DUST & SHINE".

FOR FURNITURE POLISH (U.S. CLS. 1, 4, 6, 50, 51 AND 52).

FIRST USE 7-7-2008; IN COMMERCE 7-7-2008.

3,568,494. GREEN-TARANTELLI, HOLLY, ITHACA, NY. SN 77-377,376. PUB. 8-12-2008, FILED 1-22-2008.

norabloom

THE MARK CONSISTS OF STANDARD CHARACTERS WITHOUT CLAIM TO ANY PARTICULAR FONT, STYLE, SIZE, OR COLOR.

THE NAME(S), PORTRAIT(S), AND/OR SIGNATURE(S) SHOWN IN THE MARK DOES NOT IDENTIFY A PARTICULAR LIVING INDIVIDUAL.

FOR COSMETIC CREAMS FOR SKIN CARE (U.S. CLS. 1, 4, 6, 50, 51 AND 52).

FIRST USE 9-1-2008; IN COMMERCE 11-1-2008.

3,568,510. HIGH DESERT PHARMACEUTICS, INC., RENO, NV. SN 77-403,066. PUB. 7-8-2008, FILED 2-21-2008.



NO CLAIM IS MADE TO THE EXCLUSIVE RIGHT TO USE "HAND PROTECTION", APART FROM THE MARK AS SHOWN.

THE COLOR(S) BLUE, BLACK AND WHITE IS/ARE CLAIMED AS A FEATURE OF THE MARK.

CLASS 3—(Continued).

THE COLOR BLUE APPEARS IN THE WAVE LINE DESIGN AND THE WORD "GLOVE"; THE COLOR BLACK APPEARS IN THE WORDS "GLIDE" AND "HAND PROTECTION"; THE COLOR WHITE APPEARS AS BACKGROUND TO THE ENTIRE MARK.

FOR COSMETICS AND COSMETIC PREPARATIONS; NON-MEDICATED SKIN CARE PREPARATIONS; SKIN MOISTURIZER; TOPICAL SKIN SPRAYS FOR COSMETIC PURPOSES (U.S. CLS. 1, 4, 6, 50, 51 AND 52).
FIRST USE 8-1-2008; IN COMMERCE 8-1-2008.

3,568,512. HIGH DESERT PHARMACEUTICS, INC., RENO, NV. SN 77-403,119. PUB. 7-8-2008, FILED 2-21-2008.



NO CLAIM IS MADE TO THE EXCLUSIVE RIGHT TO USE "WETSUITS LUBRICANT", APART FROM THE MARK AS SHOWN.

THE COLOR(S) BLUE, BLACK AND WHITE IS/ARE CLAIMED AS A FEATURE OF THE MARK.

THE COLOR BLUE APPEARS IN THE SQUARE DESIGN HOUSING THE WHITE CIRCLES AND IN THE WORD "WATER"; THE COLOR BLACK APPEARS IN THE WORDS "GLIDE" AND "WETSUITS LUBRICANT"; THE COLOR WHITE APPEARS IN THE CIRCLES HOUSED IN THE BLUE SQUARE DESIGN.

FOR COSMETICS AND COSMETIC PREPARATIONS; NON-MEDICATED SKIN CARE PREPARATIONS; SKIN MOISTURIZER; TOPICAL SKIN SPRAYS FOR COSMETIC PURPOSES (U.S. CLS. 1, 4, 6, 50, 51 AND 52).
FIRST USE 8-1-2008; IN COMMERCE 8-1-2008.

3,568,513. HIGH DESERT PHARMACEUTICS, INC., RENO, NV. SN 77-403,129. PUB. 7-8-2008, FILED 2-21-2008.



NO CLAIM IS MADE TO THE EXCLUSIVE RIGHT TO USE "COMPRESSION ASSIST HOSIERY FITTING & DONNING AIDE", APART FROM THE MARK AS SHOWN.

THE COLOR(S) BLUE, GREEN AND BLACK IS/ARE CLAIMED AS A FEATURE OF THE MARK.

THE COLOR BLUE APPEARS IN THE WORD "COMPRESSION"; THE COLOR GREEN APPEARS IN THE CIRCLE ABOVE THE LETTER "I" IN THE WORD "COMPRESSION"; THE COLOR BLACK APPEARS IN THE WORDS "ASSIST" AND "HOSIERY FITTING & DONNING AIDE".

FOR COSMETICS AND COSMETIC PREPARATIONS; NON-MEDICATED SKIN CARE PREPARATIONS; SKIN MOISTURIZER; TOPICAL SKIN SPRAYS FOR COSMETIC PURPOSES (U.S. CLS. 1, 4, 6, 50, 51 AND 52).
FIRST USE 8-1-2008; IN COMMERCE 8-1-2008.

CLASS 3—(Continued).

3,568,535. BERGQUIST, DIANN JUDITH, PLYMOUTH, MI. SN 77-428,230. PUB. 7-29-2008, FILED 3-21-2008.



THE MARK CONSISTS OF THE TEXT "PUREMEN" WITH A HALO AFFXED ABOVE THE LETTER "U".
FOR COSMETICS AND COSMETIC PREPARATIONS (U.S. CLS. 1, 4, 6, 50, 51 AND 52).

FIRST USE 5-13-2008; IN COMMERCE 5-13-2008.

3,568,542. PURE & NATURAL COMPANY, SCOTTSDALE, AZ. SN 77-438,377. PUB. 8-19-2008, FILED 4-2-2008.

FAST BREAK

THE MARK CONSISTS OF STANDARD CHARACTERS WITHOUT CLAIM TO ANY PARTICULAR FONT, STYLE, SIZE, OR COLOR.

FOR DEODORANTS AND ANTIPERSPIRANTS (U.S. CLS. 1, 4, 6, 50, 51 AND 52).
FIRST USE 1-15-2008; IN COMMERCE 1-15-2008.

3,568,590. PRO-LINE INTERNATIONAL, INC., MELROSE PARK, IL. SN 78-483,006. PUB. 9-6-2005, FILED 9-14-2004.

SOFT & BEAUTIFUL

THE MARK CONSISTS OF STANDARD CHARACTERS WITHOUT CLAIM TO ANY PARTICULAR FONT, STYLE, SIZE, OR COLOR.

OWNER OF U.S. REG. NO. 2,037,271.
FOR NON-MEDICATED SKIN CARE PREPARATIONS (U.S. CLS. 1, 4, 6, 50, 51 AND 52).
FIRST USE 6-1-2008; IN COMMERCE 6-1-2008.

CLASS 3—(Continued).

3,568,599. HAIR TEAM 53, LTD., ITASCA, IL. SN 78-566,277. PUB. 12-12-2006, FILED 2-13-2005.



THE MARK CONSISTS OF PROFILE OF A WOMANS FACE WITH THE WORD HAIRFUME FLOWING THROUGH HER HAIR.

FOR HAIR FRESHENING GELS, SPRAYS AND LOTIONS; HAIR SHINE ENHANCEMENT PRODUCTS, NAMELY, HAIR GELS, SPRAYS AND SERUMS; HAIR DETANGLERS (U.S. CLS. 1, 4, 6, 50, 51 AND 52).

FIRST USE 6-23-2007; IN COMMERCE 6-23-2007.

3,568,628. PLATINA COSMETICOS LTDA., SAO BENEDITO, UBERABA - MG, BRAZIL. SN 78-768,558. PUB. 7-24-2007, FILED 12-7-2005.

OWNER OF BRAZIL REG. NO. 814810314, DATED 4-5-2005, EXPIRES 4-5-2015.

THE MARK CONSISTS OF A STYLIZED DEPICTION OF THE TERM "SKALA".

THE FOREIGN WORDING IN THE MARK TRANSLATES INTO ENGLISH AS SCALE, STAIRCASE, STAIR AND/OR STEP.

FOR PERFUMES AND TOILETRY ARTICLES, IN GENERAL, NAMELY, SOAPS, PERFUMES, ESSENTIAL OILS, COSMETICS, HAIR LOTIONS, AND DENTIFRICES (U.S. CLS. 1, 4, 6, 50, 51 AND 52).

FIRST USE 10-17-2006; IN COMMERCE 10-17-2006.

3,568,654. DR. JAMES L. GEIGER, M.D., OILMD, P.C., GILBERT, AZ. SN 78-867,314. PUB. 9-4-2007, FILED 4-21-2006.

THE MARK CONSISTS OF STANDARD CHARACTERS WITHOUT CLAIM TO ANY PARTICULAR FONT, STYLE, SIZE, OR COLOR.

OWNER OF U.S. REG. NOS. 3,186,794, 3,186,798, AND OTHERS.

FOR AROMATHERAPY OILS; ESSENTIAL OILS; ESSENTIAL OILS FOR PERSONAL USE; ESSENTIAL OILS FOR USE IN MANUFACTURING OF PRODUCTS TO PROMOTE WELLNESS (U.S. CLS. 1, 4, 6, 50, 51 AND 52). FIRST USE 9-15-2007; IN COMMERCE 9-15-2007.

CLASS 3—(Continued).

3,568,655. SMART BEAUTY HOLDINGS LIMITED, DOUGLAS, UNITED KINGDOM. SN 78-870,125. PUB. 3-4-2008, FILED 4-26-2006.

NO CLAIM IS MADE TO THE EXCLUSIVE RIGHT TO USE "COLOUR", APART FROM THE MARK AS SHOWN.

THE MARK CONSISTS OF THE WORD "SMART" ON TOP OF THE WORD "COLOUR".

FOR HAIR CARE PREPARATIONS; HAIR LOTIONS; NON-MEDICATED PREPARATIONS FOR THE HAIR AND SCALP; HAIR COLOURANTS; HAIR BLEACHING PREPARATIONS; HAIR DYEING PREPARATIONS; SHAMPOO, CONDITIONER; HAIR SHEEN, RINSE, GEL, MOUSSE, SPRAY AND OIL (U.S. CLS. 1, 4, 6, 50, 51 AND 52).

FIRST USE 1-31-2007; IN COMMERCE 1-31-2007.

3,568,664. BOTICA COMERCIAL FARMACEUTICA S.A., SAO JOSE DOS PINHAIS, PARANA, BRAZIL. SN 78-920,249. PUB. 2-26-2008, FILED 6-29-2006.

THE MARK CONSISTS OF STANDARD CHARACTERS WITHOUT CLAIM TO ANY PARTICULAR FONT, STYLE, SIZE, OR COLOR.

NO CLAIM IS MADE TO THE EXCLUSIVE RIGHT TO USE "LILY ESSENCE", APART FROM THE MARK AS SHOWN.

THE FOREIGN WORDING IN THE MARK TRANSLATES INTO ENGLISH AS "THE PHARMACIST".

FOR COSMETICS, PERFUMERY AND PERSONAL HYGIENE PRODUCTS, NAMELY, TOILET WATER, COLOGNE WATER, LAVENDER WATER, TOILET SOAPS, DEODORANT SOAPS, OILS FOR TOILETRY PURPOSES, NON-MEDICATED TOILETRIES, BATH OILS FOR COSMETIC PURPOSES, COSMETIC OILS, NON-MEDICATED BATH SALTS, PRE-SHAVE AND AFTERSHAVE GELS, SKIN CLEANSING LOTIONS AND CREAMS, BODY AND BEAUTY CARE COSMETICS, BEAUTY MASKS, COSMETIC PENCILS, PRE-MOISTENED COSMETIC WIPES IMPREGNATED WITH COSMETIC LOTIONS, PERFUMED TALCUM POWDER FOR TOILET USE, PERFUMERY, HAIR SHAMPOOS AND CONDITIONERS (U.S. CLS. 1, 4, 6, 50, 51 AND 52). FIRST USE 3-31-2008; IN COMMERCE 3-31-2008.

CLASS 3—(Continued).

3,568,672. COCOON HAIR STUDIO, LLC, NEW YORK, NY. SN 78-928,053. PUB. 9-11-2007, FILED 7-12-2006.

AMAZON BEAUTY

THE MARK CONSISTS OF STANDARD CHARACTERS WITHOUT CLAIM TO ANY PARTICULAR FONT, STYLE, SIZE, OR COLOR.

NO CLAIM IS MADE TO THE EXCLUSIVE RIGHT TO USE "BEAUTY", APART FROM THE MARK AS SHOWN.

FOR BATH GELS; BATH LOTION; BODY LOTIONS; BODY OILS; CONDITIONERS; COSMETIC SOAPS; COSMETIC SUN-PROTECTING PREPARATIONS; COSMETIC SUN-TANNING PREPARATIONS; CREAM SOAPS; FACE AND BODY CREAMS; FACE AND BODY LOTIONS; FACIAL SCRUBS; FRAGRANCES FOR PERSONAL USE; HAIR CARE PREPARATIONS; HAIR CONDITIONER; HAIR CREAMS; HAIR GELS; HAIR LOTIONS; HAIR NOURISHERS; HAIR SHAMPOO; HAIR SPRAY; INCENSE; LIQUID BATH SOAPS; LOTIONS FOR FACE AND BODY CARE; OILS FOR HAIR CONDITIONING; PERFUME; SHAMPOO-CONDITIONERS; SHOWER AND BATH GEL; SKIN CLEANSERS; SKIN CREAM; SKIN GELS FOR ACCELERATING, ENHANCING OR EXTENDING TANS; SKIN MOISTURIZER; SKIN SOAP; SOAPS FOR PERSONAL USE; SUN BLOCK PREPARATIONS; SUN CARE LOTIONS; SUN CREAMS; XSUN TAN GEL; SUN TAN OIL; SUNTANNING PREPARATIONS (U.S. CLS. 1, 4, 6, 50, 51 AND 52).
FIRST USE 4-1-2008; IN COMMERCE 4-1-2008.

3,568,697. ROLITE COMPANY, INC., HARTLAND, WI. SN 78-966,165. PUB. 3-18-2008, FILED 9-1-2006.

WELLNESS FOR THE FEET

THE MARK CONSISTS OF STANDARD CHARACTERS WITHOUT CLAIM TO ANY PARTICULAR FONT, STYLE, SIZE, OR COLOR.

FOR FOOT CARE PRODUCTS, NAMELY, FOOT BALM, NON-MEDICATED FOOT CREAM, NON-MEDICATED FOOT SPRAY, FOOT DEODORANT, FOOT SOAK AND FOOT BATH SALTS AND TABLETS (U.S. CLS. 1, 4, 6, 50, 51 AND 52).

FIRST USE 1-31-2006; IN COMMERCE 1-31-2006.

CLASS 5—PHARMACEUTICALS

CLASS 5—(Continued).

3,567,992. ALGETA ASA, BLINDERN, OSLO, NORWAY. SN 76-248,687. PUB. 12-10-2002, FILED 4-27-2001.

ALPHARADIN

PRIORITY CLAIMED UNDER SEC. 44(D) ON NORWAY APPLICATION NO. 200013253, FILED 11-1-2000, REG. NO. 209331, DATED 7-5-2001, EXPIRES 7-5-2011.

FOR PHARMACEUTICAL, VETERINARY AND SANITARY PREPARATIONS, NAMELY, RADIO PHARMACEUTICALS AND RADIOACTIVE PHARMACEUTICALS, ALL FOR THE TREATMENT OF CANCER AND BONE ILLNESSES AND DISEASES (U.S. CLS. 6, 18, 44, 46, 51 AND 52).

FIRST USE 8-11-2008; IN COMMERCE 8-11-2008.

3,567,999. GALENCIA NUTRITION GMBH, ZURICH, SWITZERLAND. SN 76-609,605. PUB. 7-31-2007, FILED 8-19-2004.

GALENCIA

THE MARK CONSISTS OF STANDARD CHARACTERS WITHOUT CLAIM TO ANY PARTICULAR FONT, STYLE, SIZE, OR COLOR.

FOR DIETARY SUPPLEMENTS, NUTRITIONAL SUPPLEMENTS, HERBAL TEAS AND MEDICINAL HERBAL EXTRACTS FOR MEDICAL PURPOSES, MEDICATED SKIN AND HAIR CARE PREPARATIONS (U.S. CLS. 6, 18, 44, 46, 51 AND 52).

FIRST USE 4-11-2008; IN COMMERCE 4-11-2008.

3,568,052. MEDS AND FOOD FOR KIDS, ST. LOUIS, MO. SN 77-019,390. PUB. 5-29-2007, FILED 10-12-2006.

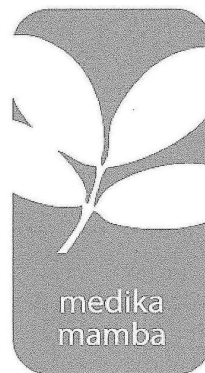

THE NAME "MEDIKA MAMBA" DOES NOT IDENTIFY A LIVING INDIVIDUAL.

CLASS 5—(Continued).

THE MARK CONSISTS OF A TREE BRANCH WITH FOUR LEAVES WITH THE WORDING "MEDIKA MAMBA" SET DIRECTLY BELOW THE DESIGN SURROUNDED BY A RECTANGULAR BORDER.

FOR NUTRITIONAL SUPPLEMENTS IN THE NATURE OF READY TO EAT BARS AND PASTES CONTAINING VITAMINS, MINERALS, PROTEINS AND ANTI-OXIDANTS (U.S. CLS. 6, 18, 44, 46, 51 AND 52).

FIRST USE 1-1-2006; IN COMMERCE 1-1-2006.

3,568,121. SANOFI PASTEUR LIMITED/SANOFI PASTEUR LIMITEE, TORONTO, ONTARIO, CANADA. SN 77-103,869. PUB. 7-10-2007, FILED 2-9-2007.

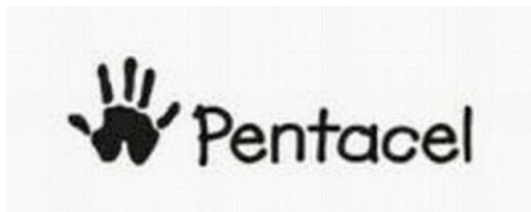

OWNER OF U.S. REG. NO. 3,065,270.

THE MARK CONSISTS OF THE STYLIZED WORDING "PENTACEL" AND THE DESIGN OF A HAND PRINT.

FOR PHARMACEUTICAL PREPARATIONS, NAMELY, A COMBINATION OF COMPONENT DIPHThERIA, TETANUS, PERTUSSIS, POLIO AND HAEMOPHILUS INFLUENZAE TYPE B (HIB) VACCINE (U.S. CLS. 6, 18, 44, 46, 51 AND 52).

FIRST USE 7-14-2008; IN COMMERCE 7-14-2008.

3,568,122. SANOFI PASTEUR LIMITED/SANOFI PASTEUR LIMITEE, TORONTO, ONTARIO, CANADA. SN 77-103,899. PUB. 7-10-2007, FILED 2-9-2007.



OWNER OF U.S. REG. NO. 3,065,270.

THE COLOR(S) YELLOW, GREEN AND BLUE IS/ARE CLAIMED AS A FEATURE OF THE MARK.

THE COLOR YELLOW APPEARS IN THE DESIGN OF A HANDPRINT. THE COLOR GREEN APPEARS IN THE LETTERS "PENT" IN THE STYLIZED WORDING "PENTACEL". THE COLOR BLUE APPEARS IN THE LETTERS "ACEL" IN THE STYLIZED WORDING "PENTACEL".

FOR PHARMACEUTICAL PREPARATIONS, NAMELY, A COMBINATION OF COMPONENT DIPHThERIA, TETANUS, PERTUSSIS, POLIO AND HAEMOPHILUS INFLUENZAE TYPE B (HIB) VACCINE (U.S. CLS. 6, 18, 44, 46, 51 AND 52).

FIRST USE 7-14-2008; IN COMMERCE 7-14-2008.

CLASS 5—(Continued).

3,568,141. MITSUI CHEMICALS, INC., TOKYO, JAPAN. SN 77-124,462. PUB. 9-25-2007, FILED 3-7-2007.

TENCHU

THE MARK CONSISTS OF STANDARD CHARACTERS WITHOUT CLAIM TO ANY PARTICULAR FONT, STYLE, SIZE, OR COLOR.

THE ENGLISH TRANSLATION OF "TENCHU" IS "HEAVEN'S PUNISHMENT".

FOR PREPARATIONS FOR KILLING WEEDS AND DESTROYING VERMIN; INSECTICIDES; PESTICIDES; VERMICIDES; FUNGICIDES; HERBICIDES; GERMICIDES (U.S. CLS. 6, 18, 44, 46, 51 AND 52).

FIRST USE 6-27-2008; IN COMMERCE 6-27-2008.

3,568,188. KEYSTONE SCENT COMPANY, INC., BALTIMORE, MD. SN 77-166,493. PUB. 2-19-2008, FILED 4-26-2007.



OWNER OF U.S. REG. NOS. 983,113 AND 2,088,313.

NO CLAIM IS MADE TO THE EXCLUSIVE RIGHT TO USE "SCENT", APART FROM THE MARK AS SHOWN.

THE MARK CONSISTS OF "K29" INSIDE OVAL SECTION OF A KEY SHAPE DESIGN WITH THE WORDS "KEYSTONE SCENT" APPEARING ON THE ELONGATED RECTANGULAR SHAPE.

FOR AIR FRESHENERS; AIR FRESHENER SPRAYS (U.S. CLS. 6, 18, 44, 46, 51 AND 52).

FIRST USE 1-31-2007; IN COMMERCE 1-31-2007.

3,568,208. SYNGENTA PARTICIPATIONS AG, BASEL, SWITZERLAND. SN 77-180,322. PUB. 10-9-2007, FILED 5-14-2007.

TENACITY

THE MARK CONSISTS OF STANDARD CHARACTERS WITHOUT CLAIM TO ANY PARTICULAR FONT, STYLE, SIZE, OR COLOR.

FOR HERBICIDES FOR AGRICULTURAL USE (U.S. CLS. 6, 18, 44, 46, 51 AND 52).

FIRST USE 3-14-2008; IN COMMERCE 3-14-2008.

CLASS 5—(Continued).

3,568,241. ZICAM, LLC, SCOTTSDALE, AZ. SN 77-216,134. PUB. 2-26-2008, FILED 6-26-2007.

CLASS 5—(Continued).

3,568,527. REVOLUTIONARY INVESTMENTS, LLC, NAPERVILLE, IL. SN 77-419,189. PUB. 7-29-2008, FILED 3-11-2008.

DON'T LET A COLD RUN YOU
DOWN

SNAPDRAGON

THE MARK CONSISTS OF STANDARD CHARACTERS WITHOUT CLAIM TO ANY PARTICULAR FONT, STYLE, SIZE, OR COLOR.

FOR OVER-THE-COUNTER, PHARMACEUTICAL PREPARATIONS AND HOMEOPATHIC PHARMACEUTICAL PREPARATIONS FOR THE RELIEF OF COLDS AND ALLERGY SYMPTOMS (U.S. CLS. 6, 18, 44, 46, 51 AND 52).

FIRST USE 9-1-2008; IN COMMERCE 9-1-2008.

THE MARK CONSISTS OF STANDARD CHARACTERS WITHOUT CLAIM TO ANY PARTICULAR FONT, STYLE, SIZE, OR COLOR.

FOR NUTRITIONAL SUPPLEMENTS IN THE FORM OF INGESTIBLE LIQUIDS FOR PROMOTING HEALTHY SKIN, HAIR AND NAILS (U.S. CLS. 6, 18, 44, 46, 51 AND 52).

FIRST USE 9-10-2008; IN COMMERCE 9-10-2008.

3,568,511. HIGH DESERT PHARMACEUTICS, INC., RENO, NV. SN 77-403,103. PUB. 7-8-2008, FILED 2-21-2008.

3,568,574. XS ENERGY, LLC, SANTA FE SPRINGS, CA. SN 78-354,481. PUB. 9-13-2005, FILED 1-20-2004.



HIGH DESERT PHARMACEUTICS, INC.

XS

NO CLAIM IS MADE TO THE EXCLUSIVE RIGHT TO USE "PHARMACEUTICS, INC.", APART FROM THE MARK AS SHOWN.

THE COLOR(S) BLUE, GREEN, GOLD, WHITE AND BLACK IS/ARE CLAIMED AS A FEATURE OF THE MARK.

THE COLOR BLUE APPEARS IN THE TOP SECTION OF THE THREE-SECTION DIVIDED SQUARE; THE COLOR GREEN APPEARS IN THE MIDDLE SECTION OF THE THREE-SECTION DIVIDED SQUARE; THE COLOR GOLD APPEARS IN THE BOTTOM SECTION OF THE THREE-SECTION DIVIDED SQUARE; THE COLOR WHITE APPEARS AS BACKGROUND TO THE ENTIRE MARK; THE COLOR BLACK APPEARS IN THE WORDS "HIGH DESERT PHARMACEUTICS, INC."

FOR MEDICAL LUBRICANT, NAMELY, A SKIN LUBRICANT AND MOISTURIZER FOR USE IN DONNING MEDICAL AND NON-MEDICAL GARMENTS (U.S. CLS. 6, 18, 44, 46, 51 AND 52).

FIRST USE 8-1-2008; IN COMMERCE 8-1-2008.

THE MARK CONSISTS OF STANDARD CHARACTERS WITHOUT CLAIM TO ANY PARTICULAR FONT, STYLE, SIZE, OR COLOR.

OWNER OF U.S. REG. NO. 2,826,858.

FOR SPORTS NUTRITIONAL SUPPLEMENTS; DIETARY FOOD SUPPLEMENTS; MEAL REPLACEMENT DRINKS; MEAL REPLACEMENT POWDERS (U.S. CLS. 6, 18, 44, 46, 51 AND 52).

FIRST USE 3-31-2005; IN COMMERCE 3-31-2005.

CLASS 5—(Continued).

3,568,601. NUTRABELLA, LLC, SAN MATEO, CA. SN 78-599,040. PUB. 2-6-2007, FILED 3-31-2005.

NutraBella

THE MARK CONSISTS OF STANDARD CHARACTERS WITHOUT CLAIM TO ANY PARTICULAR FONT, STYLE, SIZE, OR COLOR.

FOR NUTRITIONAL PRODUCTS FOR USE BY WOMEN BEFORE, DURING AND AFTER PREGNANCY, NAMELY, NUTRITIONALLY FORTIFIED BEVERAGES AND VITAMIN AND MINERAL FORTIFIED NUTRITION BARS (U.S. CLS. 6, 18, 44, 46, 51 AND 52).
FIRST USE 7-20-2005; IN COMMERCE 7-20-2005.

3,568,609. PROFESSIONAL DISPOSABLES INTERNATIONAL, INC., ORANGEBURG, NY. SN 78-660,754. PUB. 3-21-2006, FILED 6-29-2005.

SANI-KIDS

THE MARK CONSISTS OF STANDARD CHARACTERS WITHOUT CLAIM TO ANY PARTICULAR FONT, STYLE, SIZE, OR COLOR.

FOR PREMOISTENED HAND SANITIZING WIPES (U.S. CLS. 6, 18, 44, 46, 51 AND 52).
FIRST USE 6-1-2008; IN COMMERCE 6-1-2008.

CLASS 5—(Continued).

3,568,673. PROTECH PROFESSIONAL PRODUCTS, INC., BOYNTON BEACH, FL. SN 78-928,930. PUB. 2-27-2007, FILED 7-13-2006.

PRISTINE

THE MARK CONSISTS OF STANDARD CHARACTERS WITHOUT CLAIM TO ANY PARTICULAR FONT, STYLE, SIZE, OR COLOR.

FOR SANITIZERS FOR TOOTHBRUSHES (U.S. CLS. 6, 18, 44, 46, 51 AND 52).
FIRST USE 11-11-2008; IN COMMERCE 11-11-2008.

3,568,696. VITACOST.COM INC., BOCA RATON, FL. SN 78-965,658. PUB. 4-24-2007, FILED 9-1-2006.

ULTRASORB-C

THE MARK CONSISTS OF STANDARD CHARACTERS WITHOUT CLAIM TO ANY PARTICULAR FONT, STYLE, SIZE, OR COLOR.

OWNER OF U.S. REG. NO. 2,257,056.
FOR DIETARY AND NUTRITIONAL SUPPLEMENTS (U.S. CLS. 6, 18, 44, 46, 51 AND 52).
FIRST USE 11-5-2008; IN COMMERCE 11-5-2008.

CLASS 6—METAL GOODS

3,568,071. BFS DIVERSIFIED PRODUCTS, LLC, INDIANAPOLIS, IN. SN 77-049,463. PUB. 4-10-2007, FILED 11-22-2006.

UNA-EDGE

THE MARK CONSISTS OF STANDARD CHARACTERS WITHOUT CLAIM TO ANY PARTICULAR FONT, STYLE, SIZE, OR COLOR.

FOR METAL ROOFING EDGES (U.S. CLS. 2, 12, 13, 14, 23, 25 AND 50).
FIRST USE 1-17-2007; IN COMMERCE 1-17-2007.

CLASS 6—(Continued).

3,568,123. DAKA CORPORATION, PINE CITY, MN. SN 77-105,239. PUB. 3-4-2008, FILED 2-12-2007.

CLEARWATER

THE MARK CONSISTS OF STANDARD CHARACTERS WITHOUT CLAIM TO ANY PARTICULAR FONT, STYLE, SIZE, OR COLOR.

FOR METAL BOAT DOCKS, NAMELY, FLOATING DOCKS, SECTIONAL DOCKS AND ROLL-IN DOCKS (U.S. CLS. 2, 12, 13, 14, 23, 25 AND 50);

FIRST USE 4-4-2007; IN COMMERCE 4-4-2007.



3,568,181. LIBERTY HARDWARE MFG. CORP., WINSTON-SALEM, NC. SN 77-158,482. PUB. 3-4-2008, FILED 4-17-2007.

CLASSIC TAPESTRY

THE MARK CONSISTS OF STANDARD CHARACTERS WITHOUT CLAIM TO ANY PARTICULAR FONT, STYLE, SIZE, OR COLOR.

NO CLAIM IS MADE TO THE EXCLUSIVE RIGHT TO USE "CLASSIC", APART FROM THE MARK AS SHOWN.

FOR CABINET HARDWARE, NAMELY, HANDLES, KNOBS AND PULLS MADE PRIMARILY OF METAL (U.S. CLS. 2, 12, 13, 14, 23, 25 AND 50);

FIRST USE 3-0-2008; IN COMMERCE 3-0-2008.



3,568,243. ROSAEN PRODUCTS, LLC, HAZEL PARK, MI. SN 77-218,084. PUB. 3-11-2008, FILED 6-28-2007.

TOMATOH!

THE MARK CONSISTS OF STANDARD CHARACTERS WITHOUT CLAIM TO ANY PARTICULAR FONT, STYLE, SIZE, OR COLOR.

FOR METAL SUPPORT FRAME FOR PLANTS AND HOLDERS THEREFOR (U.S. CLS. 2, 12, 13, 14, 23, 25 AND 50).

FIRST USE 6-26-2007; IN COMMERCE 6-26-2007.



CLASS 7—MACHINERY

CLASS 7—(Continued).

3,568,018. US SAWS, INC., SANTA ANA, CA. SN 76-673,930. PUB. 4-15-2008, FILED 3-12-2007.

CORE EZ

THE MARK CONSISTS OF STANDARD CHARACTERS WITHOUT CLAIM TO ANY PARTICULAR FONT, STYLE, SIZE, OR COLOR.

NO CLAIM IS MADE TO THE EXCLUSIVE RIGHT TO USE "CORE", APART FROM THE MARK AS SHOWN.

FOR HAND HELD POWER OPERATED CEMENT DRILLING TOOLS AND ACCESSORIES, NAMELY, CORE BITS AND DRILL BITS (U.S. CLS. 13, 19, 21, 23, 31, 34 AND 35).

FIRST USE 5-16-2007; IN COMMERCE 5-16-2007.



3,568,034. HOLLEY PERFORMANCE PRODUCTS, INC., BOWLING GREEN, KY. SN 76-685,824. PUB. 5-27-2008, FILED 1-16-2008.



OWNER OF U.S. REG. NOS. 1,866,730 AND 1,867,992. THE COLOR(S) RED, GRAY, WHITE, AND BLACK IS/ ARE CLAIMED AS A FEATURE OF THE MARK.

THE MARK CONSISTS OF THE TERM "STREET" APPEARING IN A RED STYLIZED FONT CENTERED IMMEDIATELY ABOVE THE TERM "WARRIOR" APPEARING IN A GRAY AND WHITE STYLIZED FONT, WITH THE PHRASE "BY WEIAND" APPEARING IN THE LOWER RIGHT CORNER BELOW THE AFOREMENTIONED ELEMENTS, AND WITH THE TERM "WEIAND" BEING CENTERED WITHIN A STYLIZED "W" DESIGN, AND WHEREIN A STYLIZED SUIT-OF-ARMOR HELMET APPEARS IMMEDIATELY TO THE RIGHT OF THE AFOREMENTIONED IN THE FORM OF A RED, BLACK, WHITE, AND GRAY STYLIZED DESIGN ELEMENT.

FOR INTAKE MANIFOLDS FOR LAND VEHICLE INTERNAL COMBUSTION ENGINES (U.S. CLS. 13, 19, 21, 23, 31, 34 AND 35).

FIRST USE 10-31-2007; IN COMMERCE 4-26-2008.

CLASS 7—(Continued).

3,568,090. CAR-MON PRODUCTS, INC., ELGIN, IL. SN 77-077,232. PUB. 8-21-2007, FILED 1-5-2007.

CLASS 7—(Continued).

3,568,407. VAN CAMP, GORDON, RIO RICO, AZ. SN 77-306,314. PUB. 4-1-2008, FILED 10-17-2007.

EMPLOYEE OF THE MONTH

THE MARK CONSISTS OF STANDARD CHARACTERS WITHOUT CLAIM TO ANY PARTICULAR FONT, STYLE, SIZE, OR COLOR.

FOR INDUSTRIAL ROBOTS, NAMELY, ROBOTIC LOADERS (U.S. CLS. 13, 19, 21, 23, 31, 34 AND 35). FIRST USE 1-5-2007; IN COMMERCE 4-25-2008.

THE MARK CONSISTS OF STANDARD CHARACTERS WITHOUT CLAIM TO ANY PARTICULAR FONT, STYLE, SIZE, OR COLOR.

FOR EARTH MOVING MACHINES, NAMELY, LOADERS; FRONT END LOADERS (U.S. CLS. 13, 19, 21, 23, 31, 34 AND 35). FIRST USE 10-30-2008; IN COMMERCE 10-30-2008.

3,568,440. STOWE WOODWARD, LLC, WESTBOROUGH, MA. SN 77-330,100. PUB. 4-22-2008, FILED 11-15-2007.

3,568,145. ANDERSEN, KENNETH W., SAN DIEGO, CA. SN 77-127,530. PUB. 9-11-2007, FILED 3-9-2007.



THE MARK CONSISTS OF AN INVERTED TEARDROP DESIGN WITH THE PHRASE "HARMAN AND COLLINS" SUPERIMPOSED OVER THE TOP TWO-THIRDS OF THE TEARDROP, AND WITH A STYLIZED AUTOMOBILE DESIGN WHICH APPEARS TO BE CIRCLING THE BOTTOM SECTION OF THE TEARDROP.

FOR MECHANICAL ENGINE PARTS FOR LAND VEHICLES (U.S. CLS. 13, 19, 21, 23, 31, 34 AND 35). FIRST USE 11-1-2008; IN COMMERCE 11-1-2008.

Ultrelease

THE MARK CONSISTS OF STANDARD CHARACTERS WITHOUT CLAIM TO ANY PARTICULAR FONT, STYLE, SIZE, OR COLOR.

FOR MACHINE PARTS, NAMELY, INDUSTRIAL SLEEVES FOR USE AS ROLLERS IN PAPERMAKING MACHINES (U.S. CLS. 13, 19, 21, 23, 31, 34 AND 35). FIRST USE 11-27-2007; IN COMMERCE 11-27-2007.

3,568,506. LF, LLC, WILMINGTON, DE. SN 77-396,724. PUB. 5-6-2008, FILED 2-14-2008.

FOR CHUCKS FOR POWER DRILLS (U.S. CLS. 13, 19, 21, 23, 31, 34 AND 35). FIRST USE 10-0-2007; IN COMMERCE 10-0-2007.

CLASS 7—(Continued).

3,568,631. FINLEY, ROBERT, L., JENSEN BEACH, FL. SN 78-773,441. PUB. 5-15-2007, FILED 12-14-2005.

CLASS 8—(Continued).

3,568,167. HELTON, DON D., JR., MACON, GA. SN 77-142,760. PUB. 3-11-2008, FILED 3-28-2007.

CYCLONIFICATION

THE MARK CONSISTS OF STANDARD CHARACTERS WITHOUT CLAIM TO ANY PARTICULAR FONT, STYLE, SIZE, OR COLOR.

FOR FUEL FILTERS, NAMELY, FILTERS WHICH PASS FUEL PAST METALS, PLASTICS OR MAGNETS IN ORDER TO ENHANCE, RECONSTITUTE, REGENERATE, REFURBISH, CLEAN, OR MOLECULARLY CHANGE THE FUEL (U.S. CLS. 13, 19, 21, 23, 31, 34 AND 35).

FIRST USE 2-20-2006; IN COMMERCE 10-31-2007.

SHOVEL DAWG

THE MARK CONSISTS OF STANDARD CHARACTERS WITHOUT CLAIM TO ANY PARTICULAR FONT, STYLE, SIZE, OR COLOR.

NO CLAIM IS MADE TO THE EXCLUSIVE RIGHT TO USE "SHOVEL", APART FROM THE MARK AS SHOWN.

FOR HAND TOOL, NAMELY, A TOOL HAVING A SHOVEL HEAD ATTACHMENT FOR USE IN PULLING UP FLOORING DURING DEMOLITION OF A BUILDING (U.S. CLS. 23, 28 AND 44).

FIRST USE 5-11-2007; IN COMMERCE 5-11-2007.

3,568,641. STRATALOC TECHNOLOGY PRODUCTS LLC, HOUSTON, TX. SN 78-813,145. PUB. 6-5-2007, FILED 2-13-2006.

HEVIPAC

THE MARK CONSISTS OF STANDARD CHARACTERS WITHOUT CLAIM TO ANY PARTICULAR FONT, STYLE, SIZE, OR COLOR.

FOR DOWNHOLE DRILLING TUBULARS FOR USE IN DRILLING STRINGS, NAMELY, DOWNHOLE TOOLS FOR USE WITHIN A BOTTOM HOLE ASSEMBLY AND MECHANICALLY INTERCONNECTABLE WITH A DRILLING STRING TO CONTROL DRILLING CHARACTERISTICS THEREOF, AND BEING UTILIZED IN THE OIL AND GAS INDUSTRY FOR DRILLING A BOREHOLE THROUGH SUBSURFACE GEOLOGICAL FORMATIONS (U.S. CLS. 13, 19, 21, 23, 31, 34 AND 35).

FIRST USE 7-15-2007; IN COMMERCE 7-15-2007.

CLASS 9—ELECTRICAL AND SCIENTIFIC APPARATUS

3,568,006. GEARBOX SOFTWARE LLC, PLANO, TX. SN 76-653,670. PUB. 4-17-2007, FILED 1-20-2006.

BROTHERS IN ARMS HELL'S HIGHWAY

THE MARK CONSISTS OF STANDARD CHARACTERS WITHOUT CLAIM TO ANY PARTICULAR FONT, STYLE, SIZE, OR COLOR.

OWNER OF U.S. REG. NO. 3,016,028.

FOR SOFTWARE AND ELECTRONIC GAMES, NAMELY, SOFTWARE GAMES RECORDED ON CD-ROM AND DIGITAL VIDEO DISCS FOR COMPUTERS; SOFTWARE GAMES RECORDED ON CD-ROMS, DIGITAL VIDEO DISCS, AND CARTRIDGES FOR CONSOLE AND INDIVIDUAL, PORTABLE GAMING SYSTEMS; SOFTWARE GAMES THAT ARE DOWNLOADABLE FROM A REMOTE COMPUTER SITE; AND SOFTWARE GAMES FOR MOBILE PHONES, PERSONAL DIGITAL ASSISTANTS, AND HANDHELD COMPUTERS (U.S. CLS. 21, 23, 26, 36 AND 38).

FIRST USE 10-7-2008; IN COMMERCE 10-7-2008.

CLASS 8—HAND TOOLS

3,567,993. AUTOZONE, INC., MEMPHIS, TN. SN 76-527,959. PUB. 3-18-2008, FILED 7-7-2003.

DURALAST

OWNER OF U.S. REG. NOS. 1,467,999 AND 1,607,305. FOR HAND TOOLS, NAMELY, WRENCHES, RATCHET WRENCHES AND ATTACHMENTS THEREFOR, SOCKET WRENCHES, SOCKET SETS, PLIERS, SCREWDRIVERS, EXCEPT FOR THOSE SPECIFICALLY DESIGNED AND INTENDED FOR USE IN ROOFING APPLICATIONS (U.S. CLS. 23, 28 AND 44).

FIRST USE 12-31-2003; IN COMMERCE 12-31-2003.

CLASS 9—(Continued).

3,568,013. GAMELOFT S.A., 75009 PARIS, FRANCE. SN 76-664,753. PUB. 5-8-2007, FILED 8-18-2006.

BRAIN BOOSTER

THE MARK CONSISTS OF STANDARD CHARACTERS WITHOUT CLAIM TO ANY PARTICULAR FONT, STYLE, SIZE, OR COLOR.

FOR COMPUTER SOFTWARE FOR ELECTRONIC GAMES AND ENTERTAINMENT, NAMELY, SOFTWARE THAT IS DOWNLOADABLE FROM A REMOTE COMPUTER SITE VIA A GLOBAL COMPUTER NETWORK AND WIRELESS DEVICES, NAMELY, ELECTRONIC GAME PROGRAMS, RING TONES AND VOICE RINGERS FOR MOBILE TELECOMMUNICATIONS DEVICES, WALL PAPERS, SCREEN SAVERS, ANIMATED IMAGES AND COMPUTER SOFTWARE PROGRAMS FOR DOWNLOADING IMAGES TO MOBILE TELECOMMUNICATION DEVICES, NAMELY, MOBILE AND CELLULAR TELEPHONES, HANDHELD COMPUTERS, PERSONAL COMPUTERS AND PERSONAL DIGITAL ASSISTANTS; AND COMPUTER SOFTWARE, NAMELY, COMPUTER AIDED DESIGN, CAD, SOFTWARE, FOR USE IN THE DESIGN, DEVELOPMENT AND EXECUTION OF WIRELESS COMPUTER GAMES, AND COMPUTER GAME SOFTWARE FOR USE WITH WIRELESS CONSOLE GAMING DEVICES AND PERSONAL COMPUTERS (U.S. CLS. 21, 23, 26, 36 AND 38).

FIRST USE 12-11-2008; IN COMMERCE 12-11-2008.

3,568,041. BEST VENDORS MANAGEMENT COMPANY, INC., MINNEAPOLIS, MN. SN 77-009,215. PUB. 5-15-2007, FILED 9-28-2006.

BV FUSION

THE MARK CONSISTS OF STANDARD CHARACTERS WITHOUT CLAIM TO ANY PARTICULAR FONT, STYLE, SIZE, OR COLOR.

FOR COMPUTER SOFTWARE FOR USE IN THE VENDING INDUSTRY FOR THE COLLECTION, SYNCHRONIZATION, ORGANIZING, MODIFYING, TRANSFERRING, STORING AND SHARING OF DATA AND INFORMATION RELATING TO SALES, CASH ACCOUNTING, INVENTORY AND VENDOR METRICS (U.S. CLS. 21, 23, 26, 36 AND 38).

FIRST USE 8-0-2007; IN COMMERCE 12-0-2007.

CLASS 9—(Continued).

3,568,077. KING, GARY, CAMBRIDGE, MA. SN 77-057,526. PUB. 2-12-2008, FILED 12-5-2006.

DATAVERSE NETWORK

THE MARK CONSISTS OF STANDARD CHARACTERS WITHOUT CLAIM TO ANY PARTICULAR FONT, STYLE, SIZE, OR COLOR.

NO CLAIM IS MADE TO THE EXCLUSIVE RIGHT TO USE "NETWORK", APART FROM THE MARK AS SHOWN.

FOR COMPUTER SOFTWARE USED IN CONNECTION WITH RESEARCH DATA ARCHIVAL SERVICES FOR ANALYZING, CITING, ARCHIVING, TRANSFORMING, SUBSETTING, PRESERVING, SHARING, ACCESSING, SEARCHING, RETRIEVING, DOWNLOADING AND MANAGING ELECTRONIC RESEARCH DATA (U.S. CLS. 21, 23, 26, 36 AND 38).

FIRST USE 1-0-2007; IN COMMERCE 1-0-2007.

3,568,084. NITTO DENKO CORPORATION, IBARAKI-SHI, OSAKA, JAPAN. SN 77-071,828. PUB. 12-11-2007, FILED 12-27-2006.

NIBCOM

THE MARK CONSISTS OF STANDARD CHARACTERS WITHOUT CLAIM TO ANY PARTICULAR FONT, STYLE, SIZE, OR COLOR.

FOR POLARIZING FILM FOR LIQUID CRYSTAL DISPLAYS; RETARDATION FILM FOR LIQUID CRYSTAL DISPLAYS (U.S. CLS. 21, 23, 26, 36 AND 38).

FIRST USE 4-0-2002; IN COMMERCE 5-0-2003.

CLASS 9—(Continued).

3,568,086. ESTREM, SCOTT A., SPRINGFIELD, MO. SN 77-073,550. PUB. 2-19-2008, FILED 12-29-2006.

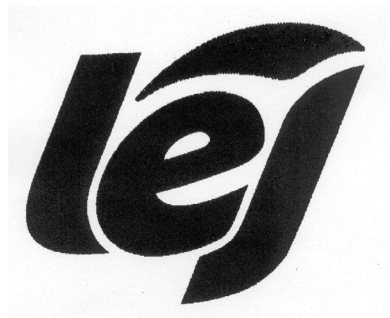

THE MARK CONSISTS OF THE LETTERING "LEJ" WITH A DESIGN ELEMENT CONSISTING OF A LEDGE-FORM VISOR ARCHING OVER THE "E" AND "J" LETTERS.
 FOR EYEWEAR, NAMELY, EYEGLASSES, SUNGLASSES AND ANTI-GLARE GLASSES; EYEGLASS FRAMES, NAMELY, FULL FRAME STYLE, HALF-RIMLESS STYLE, RIMLESS-STYLE AND END PIECES, AND GOGGLE STYLE (U.S. CLS. 21, 23, 26, 36 AND 38).
 FIRST USE 11-11-2008; IN COMMERCE 11-11-2008.

3,568,089. CROREY, DAVID J., CLINTON TOWNSHIP, MI. SN 77-076,919. PUB. 3-18-2008, FILED 1-5-2007.

CENTER MARK

THE MARK CONSISTS OF STANDARD CHARACTERS WITHOUT CLAIM TO ANY PARTICULAR FONT, STYLE, SIZE, OR COLOR.
 NO CLAIM IS MADE TO THE EXCLUSIVE RIGHT TO USE "MARK", APART FROM THE MARK AS SHOWN.
 FOR MAGNETIC HAND TOOLS, NAMELY, AN ELECTRICAL BOX LOCATOR FOR FINDING AN ELECTRICAL BOX BEHIND A SHEET OF DRYWALL, PANELING, OR PLYWOOD (U.S. CLS. 21, 23, 26, 36 AND 38).
 FIRST USE 5-15-2007; IN COMMERCE 6-15-2007.

3,568,103. RF SURGICAL SYSTEMS, INC., BELLEVUE, WA. SN 77-090,467. PUB. 7-10-2007, FILED 1-24-2007.

RF SURGICAL

THE MARK CONSISTS OF STANDARD CHARACTERS WITHOUT CLAIM TO ANY PARTICULAR FONT, STYLE, SIZE, OR COLOR.

CLASS 9—(Continued).

NO CLAIM IS MADE TO THE EXCLUSIVE RIGHT TO USE "SURGICAL", APART FROM THE MARK AS SHOWN.
 FOR ELECTRONIC DEVICES AND ACCESSORIES, NAMELY, A HANDHELD SCANNING WAND AND A CONSOLE POWER CONTROLLER FOR DETECTING TAGGED MEDICAL DISPOSABLE GOODS AND GENERATING AN AUDIBLE SIGNAL WHEN SUCH GOODS ARE DETECTED (U.S. CLS. 21, 23, 26, 36 AND 38).
 FIRST USE 2-15-2007; IN COMMERCE 2-15-2007.

3,568,108. MITCHEM, JAMES D., NAPLES, FL. SN 77-099,073. PUB. 7-31-2007, FILED 2-5-2007.



THE MARK CONSISTS OF "NEVER-KNOT" WITH THE LETTER "O" IN THE WORD "KNOT" DEPICTED AS A CIRCLE WITH A LINE THROUGH IT SUCH AS A WARNING SIGN. THE LINE INSIDE THE CIRCLE HAS A KNOT TIED ON IT.
 FOR EXTENSION CORDS (U.S. CLS. 21, 23, 26, 36 AND 38).
 FIRST USE 6-1-2007; IN COMMERCE 2-15-2008.

3,568,138. ALTEC, INC., BROUSSARD, LA. SN 77-123,825. PUB. 9-4-2007, FILED 3-6-2007.

GO SYSTEM

THE MARK CONSISTS OF STANDARD CHARACTERS WITHOUT CLAIM TO ANY PARTICULAR FONT, STYLE, SIZE, OR COLOR.
 FOR DEWATERING APPARATUS, NAMELY, PRESSURE REGULATING DEVICES PLACED IN A TAIL PIPE BELOW A PACKER AND PRODUCTION TUBING OF A WELL BORE (U.S. CLS. 21, 23, 26, 36 AND 38).
 FIRST USE 11-24-2008; IN COMMERCE 11-24-2008.

CLASS 9—(Continued).

3,568,155. TRIDENT SECURITY CONCEPTS, LLC, TEMPLETON, CA. SN 77-132,193. PUB. 10-2-2007, FILED 3-15-2007.



THE MARK CONSISTS OF THE LETTER "Y" IN STYLIZED FONT OVERLAYING A SOLID CIRCLE.

FOR ELECTRONIC SECURITY AND SAFETY DEVICES, NAMELY, ELECTRONIC SENSORS FOR MONITORING AND DETECTING MOTION, PROXIMITY, SMOKE, HEAT, FIRE, CARBON MONOXIDE AND/OR FLOOD, FEATURING SIRENS, FLASHING BEACONS AND ALARMS (U.S. CLS. 21, 23, 26, 36 AND 38).

FIRST USE 3-15-2007; IN COMMERCE 11-12-2008.

3,568,157. PULSIC LIMITED, BRISTOL, UNITED KINGDOM. SN 77-132,475. PUB. 9-18-2007, FILED 3-15-2007.

CDA

THE MARK CONSISTS OF STANDARD CHARACTERS WITHOUT CLAIM TO ANY PARTICULAR FONT, STYLE, SIZE, OR COLOR.

FOR DOWNLOADABLE COMPUTER SOFTWARE FOR USE IN THE PHYSICAL DESIGN OF INTEGRATED CIRCUITS (U.S. CLS. 21, 23, 26, 36 AND 38).

FIRST USE 10-0-2006; IN COMMERCE 10-0-2006.

CLASS 9—(Continued).

3,568,171. DAIHAN SCIENTIFIC CO., LTD., SEOUL 136-120, REPUBLIC OF KOREA. SN 77-146,378. PUB. 3-18-2008, FILED 4-2-2007.

WiseBath

THE MARK CONSISTS OF STANDARD CHARACTERS WITHOUT CLAIM TO ANY PARTICULAR FONT, STYLE, SIZE, OR COLOR.

FOR LABORATORY EQUIPMENT AND SUPPLIES, NAMELY, CONSTANT TEMPERATURE WATER BATH, GENERAL PURPOSE WATER BATH, SHAKING WATER BATH, MULTI-CHAMBER WATER BATH (U.S. CLS. 21, 23, 26, 36 AND 38).

FIRST USE 8-10-2006; IN COMMERCE 8-10-2006.

3,568,177. CLARKE/TRANSFORM, LLC, CHEVY CHASE, MD. SN 77-152,114. PUB. 10-9-2007, FILED 4-9-2007.

Eat Less & Move More

THE MARK CONSISTS OF STANDARD CHARACTERS WITHOUT CLAIM TO ANY PARTICULAR FONT, STYLE, SIZE, OR COLOR.

FOR PEDOMETERS (U.S. CLS. 21, 23, 26, 36 AND 38).

FIRST USE 10-1-2008; IN COMMERCE 10-1-2008.

3,568,179. OLYMPUS IMAGING CORP., TOKYO, JAPAN. SN 77-154,201. PUB. 8-21-2007, FILED 4-11-2007.

SSWF

THE MARK CONSISTS OF STANDARD CHARACTERS WITHOUT CLAIM TO ANY PARTICULAR FONT, STYLE, SIZE, OR COLOR.

FOR A FEATURE OF DIGITAL CAMERAS THAT GENERATES ULTRASONIC VIBRATIONS THAT SHAKES DUST OFF THE SURFACE OF THE IMAGE SENSOR (U.S. CLS. 21, 23, 26, 36 AND 38).

FIRST USE 8-31-2003; IN COMMERCE 8-31-2003.

CLASS 9—(Continued).

3,568,185. OLYMPUS IMAGING CORP., TOKYO, JAPAN. SN 77-165,573. PUB. 8-21-2007, FILED 4-25-2007.

SWD

THE MARK CONSISTS OF STANDARD CHARACTERS WITHOUT CLAIM TO ANY PARTICULAR FONT, STYLE, SIZE, OR COLOR.

FOR DIGITAL CAMERAS, AND PARTS AND ACCESSORIES THEREFOR, NAMELY, INTERCHANGEABLE LENSES (U.S. CLS. 21, 23, 26, 36 AND 38).

FIRST USE 11-23-2007; IN COMMERCE 11-23-2007.

CLASS 9—(Continued).

3,568,193. VALIDUS MEDICAL SYSTEMS, INC., SANTA CRUZ, CA. SN 77-170,348. PUB. 4-29-2008, FILED 5-1-2007.

Validus

THE MARK CONSISTS OF STANDARD CHARACTERS WITHOUT CLAIM TO ANY PARTICULAR FONT, STYLE, SIZE, OR COLOR.

FOR COMPUTER SOFTWARE PROGRAMS DESIGNED FOR AUTOMATED ORDER ENTRY SYSTEMS FOR USE BY MEDICAL INSTITUTIONS AND PHYSICIANS (U.S. CLS. 21, 23, 26, 36 AND 38).

FIRST USE 9-1-2008; IN COMMERCE 9-1-2008.

3,568,186. LASER TECHNOLOGY, INC., CENTENNIAL, CO. AND KAMA-TECH, HK LTD., TSIM SHA TSUI, HONG KONG. SN 77-165,691. PUB. 10-23-2007, FILED 4-25-2007.

TRUVECTOR

THE MARK CONSISTS OF STANDARD CHARACTERS WITHOUT CLAIM TO ANY PARTICULAR FONT, STYLE, SIZE, OR COLOR.

FOR COMPASSES TO TAKE BEARING AND DISTANCE MEASUREMENTS; COMPASSES EMBEDDED IN LASERS TO TAKE BEARING AND DISTANCE MEASUREMENTS (U.S. CLS. 21, 23, 26, 36 AND 38).

FIRST USE 6-18-2007; IN COMMERCE 6-18-2007.

3,568,225. HOFFORD, JAMES L., WASHINGTON, NH. SN 77-195,424. PUB. 11-20-2007, FILED 6-1-2007.

Vid-Po

THE MARK CONSISTS OF STANDARD CHARACTERS WITHOUT CLAIM TO ANY PARTICULAR FONT, STYLE, SIZE, OR COLOR.

FOR MUSICAL VIDEO RECORDINGS; PRERECORDED DIGITAL VIDEO DISKS FEATURING RECORDED POETRY; VIDEO DISKS FEATURING RECORDED POETRY; VIDEO RECORDINGS FEATURING RECORDED POETRY (U.S. CLS. 21, 23, 26, 36 AND 38).

FIRST USE 7-25-2008; IN COMMERCE 7-25-2008.

3,568,190. PRADA S.A., LUXEMBOURG, LUXEMBOURG. SN 77-169,310. PUB. 3-11-2008, FILED 4-30-2007.

PRADA

OWNER OF U.S. REG. NOS. 2,098,660, 2,622,757, AND OTHERS. SEC. 2(F).

FOR TELEPHONES, MOBILE TELEPHONES AND ACCESSORIES THEREFOR, NAMELY, HEADSETS, COVERS AND EARPHONES (U.S. CLS. 21, 23, 26, 36 AND 38).

FIRST USE 12-0-2007; IN COMMERCE 12-0-2007.

3,568,236. ADVANCED SOFTWARE APPLICATIONS CORP., BRIDGEVILLE, PA. SN 77-207,380. PUB. 2-26-2008, FILED 6-15-2007.

Quantum

THE MARK CONSISTS OF STANDARD CHARACTERS WITHOUT CLAIM TO ANY PARTICULAR FONT, STYLE, SIZE, OR COLOR.

FOR COMPUTER SOFTWARE DIRECTED TO FINANCIAL INSTITUTIONS FOR THE ADMINISTRATION OF EMPLOYEE INCENTIVE PROGRAMS AND EMPLOYEE VARIABLE COMPENSATION PLANS (U.S. CLS. 21, 23, 26, 36 AND 38).

FIRST USE 10-1-2007; IN COMMERCE 10-1-2007.

CLASS 9—(Continued).

3,568,245. LIFEMODELER, INC., SAN CLEMENTE, CA. SN 77-219,610. PUB. 2-26-2008, FILED 6-29-2007.

BRINGING SIMULATION TO LIFE

THE MARK CONSISTS OF STANDARD CHARACTERS WITHOUT CLAIM TO ANY PARTICULAR FONT, STYLE, SIZE, OR COLOR.

FOR ENGINEERING SOFTWARE FOR MODELING BIOLOGICAL ENTITIES AND DOWNLOADABLE ENGINEERING SOFTWARE FOR MODELING BIOLOGICAL ENTITIES (U.S. CLS. 21, 23, 26, 36 AND 38).

FIRST USE 3-21-2006; IN COMMERCE 3-21-2006.

3,568,263. VICTOR TECHNOLOGY, LLC, BOLINGBROOK, IL. SN 77-234,247. PUB. 1-8-2008, FILED 7-19-2007.

PROMPT LOGIC

THE MARK CONSISTS OF STANDARD CHARACTERS WITHOUT CLAIM TO ANY PARTICULAR FONT, STYLE, SIZE, OR COLOR.

FOR COMMERCIAL PRINTING CALCULATORS AND NON-PRINTING CALCULATORS (U.S. CLS. 21, 23, 26, 36 AND 38).

FIRST USE 8-1-2007; IN COMMERCE 12-1-2007.

3,568,265. GLOBAL CORPORATE SERVICES LTD, MAHE, SEYCHELLES. SN 77-235,138. PUB. 5-27-2008, FILED 7-20-2007.

INFINI

THE MARK CONSISTS OF STANDARD CHARACTERS WITHOUT CLAIM TO ANY PARTICULAR FONT, STYLE, SIZE, OR COLOR.

CLASS 9—(Continued).

THE FOREIGN WORDING IN THE MARK TRANSLATES INTO ENGLISH AS "INFINITE".

FOR COMPUTER APPLICATION SOFTWARE FOR MOBILE PHONES; COMPUTER COMMUNICATIONS SOFTWARE TO ALLOW CUSTOMERS TO ACCESS BANK ACCOUNT INFORMATION AND TRANSACT BANK BUSINESS; COMPUTER DATABASE MANAGEMENT SOFTWARE FOR USE IN PERSONALIZING THE CONTENT OF E-MAIL COMMUNICATIONS; COMPUTER E-COMMERCE SOFTWARE TO ALLOW USERS TO PERFORM ELECTRONIC BUSINESS TRANSACTIONS VIA A GLOBAL COMPUTER NETWORK; COMPUTER GAME SOFTWARE; COMPUTER GRAPHICS SOFTWARE; COMPUTER PROGRAM FOR THE COMPILATION OF CREDIT REPORTING DATA; COMPUTER PROGRAMMES FOR DOCUMENT MANAGEMENT; COMPUTER PROGRAMS FOR EDITING IMAGES, SOUND AND VIDEO; COMPUTER PROGRAMS FOR SEARCHING THE CONTENTS OF COMPUTERS AND COMPUTER NETWORKS BY REMOTE CONTROL; COMPUTER PROGRAMS FOR THE ENABLING OF ACCESS OR ENTRANCE CONTROL; COMPUTER SCREEN SAVER SOFTWARE; COMPUTER SEARCH ENGINE SOFTWARE; COMPUTER SOFTWARE DEVELOPMENT TOOLS; COMPUTER SOFTWARE FOR ACCESSING INFORMATION DIRECTORIES THAT MAY BE DOWNLOADED FROM THE GLOBAL COMPUTER NETWORK; COMPUTER SOFTWARE FOR ADMINISTRATION OF COMPUTER LOCAL AREA NETWORKS; COMPUTER PROGRAMS FOR USE IN DATABASE MANAGEMENT, SPREADSHEET, WORD PROCESSING AND ACCOUNTING; COMPUTER SOFTWARE FOR APPLICATION AND DATABASE INTEGRATION; COMPUTER SOFTWARE FOR COMMUNICATING WITH USERS OF HAND-HELD COMPUTERS; COMPUTER SOFTWARE FOR COMPUTER SYSTEM AND APPLICATION DEVELOPMENT, DEPLOYMENT AND MANAGEMENT; COMPUTER SOFTWARE FOR CONTROLLING AND MANAGING ACCESS SERVER APPLICATIONS; COMPUTER SOFTWARE FOR CREATING SEARCHABLE DATABASES OF INFORMATION AND DATA; COMPUTER SOFTWARE FOR ENCRYPTION; COMPUTER SOFTWARE FOR MANIPULATING DIGITAL AUDIO INFORMATION FOR USE IN AUDIO MEDIA APPLICATIONS; COMPUTER SOFTWARE FOR ORGANIZING AND VIEWING DIGITAL IMAGES AND PHOTOGRAPHS; COMPUTER SOFTWARE FOR PROCESSING DIGITAL MUSIC FILES; COMPUTER SOFTWARE FOR PROVIDING AN ON-LINE DATABASE IN THE FIELD OF TRANSACTION PROCESSING TO UPLOAD TRANSACTIONAL DATA, PROVIDE STATISTICAL ANALYSIS, AND PRODUCE NOTIFICATIONS AND REPORTS; COMPUTER SOFTWARE FOR REDISTRIBUTING, NAMELY, AGGREGATING SMALLER GEOGRAPHICAL AREAS INTO MULTIPLE LARGER AREAS; COMPUTER SOFTWARE FOR THE COLLECTION, EDITING, ORGANIZING, MODIFYING, BOOK MARKING, TRANSMISSION, STORAGE AND SHARING OF DATA AND INFORMATION; COMPUTER SOFTWARE FOR THE CREATION OF FIREWALLS; COMPUTER SOFTWARE FOR THE FIELD OF WAREHOUSING AND DISTRIBUTION, TO MANAGE TRANSACTIONAL DATA, PROVIDE STATISTICAL ANALYSIS, AND PRODUCE NOTIFICATIONS AND REPORTS; COMPUTER SOFTWARE FOR THE MANAGEMENT OF COMMERCIAL PRINTING COMPANIES IN THE FIELD OF COST ESTIMATING, PRODUCTION PLANNING, SCHEDULING PRODUCTION, BINDING, SHIPPING AND ANALYSIS OF THE PRINTING JOB; COMPUTER SOFTWARE FOR USE IN CUSTOMER RELATIONSHIP MANAGEMENT (CRM); COMPUTER SOFTWARE FOR USE IN PROGRAMMING FACSIMILE MACHINES; COMPUTER SOFTWARE FOR USE IN RELATION TO DIGITAL ANIMATION AND SPECIAL EFFECTS OF IMAGES; COMPUTER SOFTWARE FOR USE IN THE ENCRYPTION AND DECRYPTION OF DIGITAL FILES, INCLUDING AUDIO, VIDEO, TEXT, BINARY, STILL IMAGES, GRAPHICS AND MULTIMEDIA FILES; COMPUTER SOFTWARE FOR USE IN THE SAFEGUARDING OF DIGITAL FILES, INCLUDING AUDIO, VIDEO, TEXT, BINARY, STILL IMAGES, GRAPHICS AND MULTIMEDIA FILES; COMPUTER SOFTWARE FOR WIRELESS CONTENT DELIVERY; COMPUTER SOFTWARE THAT ASSISTS COMPUTERS IN DEPLOYING PARALLEL APPLICATIONS AND PERFORMING PARALLEL COMPUTATIONS; COMPUTER SOFTWARE THAT PROVIDES REAL-TIME, INTEGRATED BUSI-

CLASS 9—(Continued).

NESS MANAGEMENT INTELLIGENCE BY COMBINING INFORMATION FROM VARIOUS DATABASES AND PRESENTING IT IN AN EASY-TO-UNDERSTAND USER INTERFACE; COMPUTER SOFTWARE TO AUTOMATE DATA WAREHOUSING; COMPUTER SOFTWARE TO ENABLE THE TRANSMISSION OF PHOTOGRAPHS TO MOBILE TELEPHONES; COMPUTER SOFTWARE TO ENHANCE THE AUDIO-VISUAL CAPABILITIES OF MULTIMEDIA APPLICATIONS, NAMELY, FOR THE INTEGRATION OF TEXT, AUDIO, GRAPHICS, STILL IMAGES AND MOVING PICTURES; COMPUTER SOFTWARE TO MONITOR AND CONTROL FACTORY MANUFACTURING PROCESSES; COMPUTER SOFTWARE, NAMELY, AN APPLICATION ALLOWING SALES AND FIELD SERVICE EMPLOYEES TO UPDATE AND RECEIVE DATA STORED IN AN ENTERPRISE'S COMPUTER DATABASES IN REAL TIME, USING A MOBILE DEVICE, WITH FULL TELEPHONY INTEGRATION WITH THE TELEPHONE AND/OR SOFTWARE FEATURES OF THE MOBILE DEVICE; COMPUTER SOFTWARE, NAMELY, SOFTWARE DEVELOPMENT TOOLS FOR THE CREATION OF MOBILE INTERNET APPLICATIONS AND CLIENT INTERFACES; DATA COMPRESSION SOFTWARE; DESKTOP PUBLISHING SOFTWARE; DOWNLOADABLE MP3 FILES, MP3 RECORDINGS, ONLINE DISCUSSION BOARDS, WEBCASTS, PODCASTS FEATURING MUSIC, AUDIO BOOKS AND NEWS BROADCASTS; DOWNLOADABLE AUDIO FILES, MULTIMEDIA FILES, TEXT FILES, EMAILS, WRITTEN DOCUMENTS, AUDIO MATERIAL, VIDEO MATERIAL AND GAMES FEATURING INFORMATION IN THE FORM OF DOWNLOADABLE SHORT EDUCATIONAL/TRAINING COMMUNICATIONS IN THE FIELD OF HUMAN RESOURCE DEVELOPMENT FOR THE PROMOTION OF EMPLOYEE RETENTION, CAREER GROWTH AND INCREASED PRODUCTIVITY FOR EMPLOYEES AND EMPLOYERS; DOWNLOADABLE COMPUTER PROGRAMS FEATURING POSITIONABLE GAME PIECE FIGURES FOR USE IN THE FIELD OF COMPUTER GAMES; DOWNLOADABLE ELECTRONIC PUBLICATIONS IN THE NATURE OF TEACHING MATERIAL IN THE FIELD OF EDUCATION; DOWNLOADABLE MUSICAL SOUND RECORDINGS; DOWNLOADABLE PODCASTS IN THE FIELD OF BUSINESS; DOWNLOADABLE PRINTING FONTS; DOWNLOADABLE RING TONES, GRAPHICS AND MUSIC VIA A GLOBAL COMPUTER NETWORK AND WIRELESS DEVICES; DOWNLOADABLE VIDEO RECORDINGS FEATURING BUSINESS; DOWNLOADABLE WEBCASTS IN THE FIELD OF BUSINESS; EDUCATIONAL SOFTWARE FEATURING INSTRUCTION IN LANGUAGES; ENTERPRISE SOFTWARE IN THE NATURE OF A DATABASE FOR NON-TRANSACTIONAL DATA AND A SEARCH ENGINE FOR DATABASE CONTENT; FACILITIES MANAGEMENT SOFTWARE, NAMELY, SOFTWARE TO CONTROL BUILDING ENVIRONMENTAL, ACCESS AND SECURITY SYSTEMS; FACTORY AUTOMATION SOFTWARE, NAMELY, SOFTWARE TO INTEGRATE MANUFACTURING MACHINE OPERATIONS, TRACK PROBLEMS AND GENERATE PRODUCTION REPORTS; TAX MANAGEMENT SOFTWARE; COMPUTER GROUPWARE FOR COLLABORATION; ANTI-SPYWARE SOFTWARE; COMPILER SOFTWARE; COMPUTER OPERATING PROGRAMS; COMPUTER SOFTWARE AND FIRMWARE FOR GAMES OF CHANCE ON ANY COMPUTERIZED PLATFORM, INCLUDING DEDICATED GAMING CONSOLES, VIDEO BASED SLOT MACHINES, REEL

CLASS 9—(Continued).

BASED SLOT MACHINES, AND VIDEO LOTTERY TERMINALS; COMPUTER SOFTWARE FOR SCIENTIFIC ANALYSIS OF GENETIC SEQUENCES; COMPUTER SOFTWARE FOR VISUALIZATION IN THE NATURE OF GRAPHICAL REPRESENTATION AND ANALYSIS OF SATELLITES; COMPUTER SOFTWARE THAT ALLOWS PEOPLE OR ORGANIZATIONS TO CREATE A VOTING EVENT, VOTE ON THE ISSUE, CHANGE THEIR VOTE AT WILL AND TRACK THE INPUT AND DISPLAY IT IN A UNIQUE GRAPHICAL WAY; COMPUTER SOFTWARE TO CONTROL AND IMPROVE COMPUTER AND AUDIO EQUIPMENT SOUND QUALITY; DECODER SOFTWARE; DOWNLOADABLE ELECTRONIC DICTIONARIES; DOWNLOADABLE SCIENTIFIC AND MEDICAL DATA VIA THE INTERNET; ELECTRONIC GAME SOFTWARE; FLIGHT SIMULATORS; GLOBAL POSITIONING SYSTEM; MEDICAL SOFTWARE FOR AUTO DIAGNOSIS; MUSIC-COMPOSITION SOFTWARE; VIRTUAL REALITY GAME SOFTWARE; VIRTUAL REALITY SOFTWARE FOR COMMERCE (U.S. CLS. 21, 23, 26, 36 AND 38).

FIRST USE 1-1-2004; IN COMMERCE 1-1-2004.

3,568,271. GE FANUC AUTOMATION AMERICAS, INC., CHARLOTTESVILLE, VA. SN 77-240,754. PUB. 6-17-2008, FILED 7-27-2007.

TRANSPIHERE

THE MARK CONSISTS OF STANDARD CHARACTERS WITHOUT CLAIM TO ANY PARTICULAR FONT, STYLE, SIZE, OR COLOR.

FOR WIRELESS COMMUNICATION DEVICES, NAMELY, MODEMS AND NETWORK ACCESS SERVER HARDWARE FOR AUTOMATION APPLICATIONS FOR THE TRANSFER OF INFORMATION FROM FIXED ASSETS SUCH AS OIL AND GAS WELLS, COMPRESSOR STATIONS, PIPELINES, FLUID STORAGE TANKS AND UTILITY METERS (U.S. CLS. 21, 23, 26, 36 AND 38).

FIRST USE 10-0-2007; IN COMMERCE 10-0-2007.

3,568,273. BONFIRE PRODUCTIONS, INC., BELLEVUE, WA. SN 77-241,986. PUB. 4-8-2008, FILED 7-30-2007.

Bonfire Tales

THE MARK CONSISTS OF STANDARD CHARACTERS WITHOUT CLAIM TO ANY PARTICULAR FONT, STYLE, SIZE, OR COLOR.

NO CLAIM IS MADE TO THE EXCLUSIVE RIGHT TO USE "TALES", APART FROM THE MARK AS SHOWN.

FOR AUDIO RECORDINGS FEATURING CHILDREN'S FAIRY TALES; DIGITAL MATERIALS, NAMELY, CDS, DOWNLOADABLE AUDIO FILES FEATURING CHILDREN'S FAIRY TALES; DIGITAL MEDIA, NAMELY, CDS, DOWNLOADABLE AUDIO FILES FEATURING CHILDREN'S FAIRY TALES; DOWNLOADABLE MP3 FILES, MP3 RECORDINGS (U.S. CLS. 21, 23, 26, 36 AND 38).

FIRST USE 4-16-2008; IN COMMERCE 4-16-2008.

CLASS 9—(Continued).

3,568,281. THE HARRINGTON GROUP, ORLANDO, FL. SN 77-248,549. PUB. 2-12-2008, FILED 8-6-2007.



THIS MARK IS THE LOGO FOR A SERIOUS GAME THAT WILL BE USED TO SUPPORT THE TRAINING OF MILITARY PERSONNEL IN THE DETECTION OF IEDS. THE LOGO INCLUDES VARIOUS TYPES OF MATERIALS NORMALLY USED TO HIDE IEDS (ROCKS, PIECES OF METAL, ETC.) SURROUNDING THE TITLE OF THE GAME, "VIGILANCE".

FOR COMPUTER GAME PROGRAMS (U.S. CLS. 21, 23, 26, 36 AND 38).

FIRST USE 8-6-2007; IN COMMERCE 8-6-2007.

3,568,294. CARTER, SHAWN, NEW YORK, NY. SN 77-257,863. PUB. 2-12-2008, FILED 8-17-2007.



THE MARK CONSISTS OF TWO HANDS FACING OUTWARD WITH THE THUMBS AND INDEX FINGERS TOUCHING.

FOR DIGITAL MEDIA, NAMELY, CDS, DVDS, DOWNLOADABLE AUDIO FILES FEATURING MUSIC AND MOVIES (U.S. CLS. 21, 23, 26, 36 AND 38).

FIRST USE 8-30-2007; IN COMMERCE 8-30-2007.

CLASS 9—(Continued).

3,568,299. UES, INC., DAYTON, OH. SN 77-260,399. PUB. 5-6-2008, FILED 8-21-2007.

ROBO-MET.3D

THE MARK CONSISTS OF STANDARD CHARACTERS WITHOUT CLAIM TO ANY PARTICULAR FONT, STYLE, SIZE, OR COLOR.

FOR AUTOMATED SERIAL SECTIONING DEVICE, COMPRISING AN OPTICAL MICROSCOPE AND CAMERA THAT RECORDS IMAGES OF MULTIPLE SHAVING SAMPLES FROM A SINGLE SOURCE OF METALLIC, CERAMIC POLYMERIC OR COMPOSITE MATERIAL, TO GENERATE THREE-DIMENSIONAL MICROGRAPHS OF THE SAMPLE AND FACILITATE A MICROSTRUCTURAL INVESTIGATION OF THE SAMPLE. A ROBOT THAT POSITIONS THE METALLIC, CERAMIC POLYMERIC AND COMPOSITE MATERIAL FOR SHAVING AND MICROSCOPIC ANALYSIS AND A POLISHER FOR SHAVING MULTIPLE SAMPLES FROM A SINGLE SOURCE OF METALLIC, CERAMIC POLYMERIC OR COMPOSITE MATERIAL, TO PREPARE THE MATERIAL FOR MICROSCOPIC ANALYSIS (U.S. CLS. 21, 23, 26, 36 AND 38).

FIRST USE 10-0-2006; IN COMMERCE 2-27-2008.

3,568,309. FOCUS, INC., SOUTH JORDAN, UT. SN 77-267,689. PUB. 2-26-2008, FILED 8-29-2007.



NO CLAIM IS MADE TO THE EXCLUSIVE RIGHT TO USE "VIDEO SURVEILLANCE SYSTEMS", APART FROM THE MARK AS SHOWN.

THE MARK CONSISTS OF A CIRCLE IN THREE DIFFERENT LINES.

FOR ELECTRONIC DIGITAL VIDEO SURVEILLANCE SYSTEMS COMPRISED OF CAMERAS, BOOMS AND TRAILERS FOR MOBILE SURVEILLANCE (U.S. CLS. 21, 23, 26, 36 AND 38).

FIRST USE 11-3-2008; IN COMMERCE 11-3-2008.

CLASS 9—(Continued).

3,568,313. JEREMY BLAIR CLEMONS, RALEIGH, NC. SN 77-269,394. PUB. 2-26-2008, FILED 8-31-2007.

Geek In A Box

THE MARK CONSISTS OF STANDARD CHARACTERS WITHOUT CLAIM TO ANY PARTICULAR FONT, STYLE, SIZE, OR COLOR.

FOR EDUCATIONAL SOFTWARE FEATURING INSTRUCTION IN COMPUTER OPERATION (U.S. CLS. 21, 23, 26, 36 AND 38).

FIRST USE 7-7-2007; IN COMMERCE 7-7-2007.

CLASS 9—(Continued).

3,568,331. MAL TECHNOLOGY SDN BHD, PUCHONG, SELANGOR, MALAYSIA. SN 77-277,930. PUB. 3-11-2008, FILED 9-12-2007.

XYVIO

THE MARK CONSISTS OF THE LETTERS "XYVIO" IN STYLIZED PRINT.

FOR TELEVISION APPARATUS, NAMELY, TELEVISION SETS AND LCD TELEVISIONS (U.S. CLS. 21, 23, 26, 36 AND 38).

FIRST USE 3-15-2007; IN COMMERCE 10-8-2007.

3,568,325. JUST WHEELS & TIRE CO., HUNTINGTON BEACH, CA. SN 77-276,413. PUB. 8-5-2008, FILED 9-11-2007.

PETROL

THE MARK CONSISTS OF STANDARD CHARACTERS WITHOUT CLAIM TO ANY PARTICULAR FONT, STYLE, SIZE, OR COLOR.

OWNER OF U.S. REG. NOS. 3,268,827 AND 3,314,265. FOR EYEGLASSES, SUNGLASSES, GOGGLES FOR SPORTS, SAFETY GOGGLES, DUST MASKS, DUST PROTECTIVE GOGGLES AND MASKS AND CASES THEREFORE; FRAMES FOR SPECTACLES AND SUNGLASSES, CASES FOR EYEGLASSES, CHAINS FOR EYEGLASSES (U.S. CLS. 21, 23, 26, 36 AND 38).

FIRST USE 6-5-2008; IN COMMERCE 6-27-2008.

3,568,348. ONEWORLD GLOBAL MANUFACTURING SOLUTIONS LTD, KOWLOON BAY, HONG KONG. SN 77-285,245. PUB. 3-11-2008, FILED 9-21-2007.

LASER LEVELPRO

THE MARK CONSISTS OF STANDARD CHARACTERS WITHOUT CLAIM TO ANY PARTICULAR FONT, STYLE, SIZE, OR COLOR.

NO CLAIM IS MADE TO THE EXCLUSIVE RIGHT TO USE "LASER", APART FROM THE MARK AS SHOWN.

FOR CARPENTER'S LEVELS; LEVEL INDICATORS; LEVEL MEASURING MACHINES; SURVEYORS' LEVELS (U.S. CLS. 21, 23, 26, 36 AND 38).

FIRST USE 12-1-2004; IN COMMERCE 12-1-2004.

3,568,330. KLEIN TOOLS, INC., LINCOLNSHIRE, IL. SN 77-277,868. PUB. 9-2-2008, FILED 9-12-2007.

TAPE STOP

THE MARK CONSISTS OF STANDARD CHARACTERS WITHOUT CLAIM TO ANY PARTICULAR FONT, STYLE, SIZE, OR COLOR.

NO CLAIM IS MADE TO THE EXCLUSIVE RIGHT TO USE "TAPE", APART FROM THE MARK AS SHOWN.

FOR TAPE MEASURES (U.S. CLS. 21, 23, 26, 36 AND 38).

FIRST USE 1-1-2008; IN COMMERCE 1-1-2008.

3,568,357. BEST VENDORS MANAGEMENT, INC., MINNEAPOLIS, MN. SN 77-287,060. PUB. 3-18-2008, FILED 9-24-2007.



THE MARK CONSISTS OF A HORIZONTAL RECTANGLE WITH THE LEFT HALF CONSISTING OF THE STYLIZED LETTERS "FV" WITH AN OPEN PARENTHESIS TO THE LEFT AND TWO CLOSE PARENTHESSES TO THE RIGHT, AND THE RIGHT HALF CONSISTING OF THE WORD "FUSION" WITHIN THE RECTANGLE.

FOR COMPUTER SOFTWARE FOR USE IN THE VENDING INDUSTRY FOR THE COLLECTION, SYNCHRONIZATION, ORGANIZING, MODIFYING, TRANSFERRING, STORING AND SHARING OF DATA AND INFORMATION RELATING TO SALES, CASH ACCOUNTING, INVENTORY AND VENDOR METRICS (U.S. CLS. 21, 23, 26, 36 AND 38).

FIRST USE 8-0-2007; IN COMMERCE 12-0-2007.

CLASS 9—(Continued).

3,568,363. PLAYFIRST, INC., SAN FRANCISCO, CA. SN 77-288,793. PUB. 8-12-2008, FILED 9-25-2007.

Dress Shop Hop

THE MARK CONSISTS OF STANDARD CHARACTERS WITHOUT CLAIM TO ANY PARTICULAR FONT, STYLE, SIZE, OR COLOR.

FOR COMPUTER GAME SOFTWARE; ELECTRONIC GAME SOFTWARE; GAME SOFTWARE; VIDEO GAME SOFTWARE (U.S. CLS. 21, 23, 26, 36 AND 38).

FIRST USE 12-13-2007; IN COMMERCE 12-13-2007.

3,568,366. ENERGYLED CORPORATION, SINDIAN CITY, TAIPEI COUNTY, TAIWAN. SN 77-290,703. PUB. 3-11-2008, FILED 9-27-2007.



THE COLOR(S) BLACK, WHITE, BLUE AND YELLOW IS/ ARE CLAIMED AS A FEATURE OF THE MARK.

THE MARK CONSISTS OF THE WORD "ENERGYLED" IN STYLIZED LETTERS IN BLACK, WITH A FANCIFUL LETTER "E" IN BLUE, WHITE AND YELLOW.

FOR LIGHT EMITTING DIODES LEDS; LED DISPLAYS; LED ARRAYS; LED MODULES (U.S. CLS. 21, 23, 26, 36 AND 38).

FIRST USE 1-30-2008; IN COMMERCE 1-30-2008.

CLASS 9—(Continued).

3,568,367. KONAMI GAMING, INC., LAS VEGAS, NV. SN 77-291,058. PUB. 3-11-2008, FILED 9-28-2007.

LOT A BUCKS

THE MARK CONSISTS OF STANDARD CHARACTERS WITHOUT CLAIM TO ANY PARTICULAR FONT, STYLE, SIZE, OR COLOR.

FOR COMPUTER SOFTWARE AND FIRMWARE FOR GAMES OF CHANCE ON ANY COMPUTERIZED PLATFORM, INCLUDING DEDICATED GAMING CONSOLES, VIDEO BASED SLOT MACHINES, REEL BASED SLOT MACHINES, AND VIDEO LOTTERY TERMINALS; GAMING EQUIPMENT, NAMELY, SLOT MACHINES WITH OR WITHOUT VIDEO OUTPUT (U.S. CLS. 21, 23, 26, 36 AND 38).

FIRST USE 11-0-2007; IN COMMERCE 11-0-2007.

3,568,373. KOEI CO., LTD., YOKOHAMA, JAPAN. SN 77-292,908. PUB. 3-18-2008, FILED 10-1-2007.

OPOONA

THE MARK CONSISTS OF STANDARD CHARACTERS WITHOUT CLAIM TO ANY PARTICULAR FONT, STYLE, SIZE, OR COLOR.

FOR COMPUTER GAME DISCS, COMPUTER GAME PROGRAMS, COMPUTER GAME SOFTWARE; VIDEO GAME DISCS, VIDEO GAME PROGRAMS, VIDEO GAME SOFTWARE; USER MANUALS PROVIDED TOGETHER THEREWITH AS A UNIT (U.S. CLS. 21, 23, 26, 36 AND 38).

FIRST USE 9-27-2007; IN COMMERCE 3-25-2008.

3,568,374. TAYMAC CORPORATION, TEMPE, AZ. SN 77-293,341. PUB. 3-18-2008, FILED 10-1-2007.

WALL PLATES RE-INVENTED

THE MARK CONSISTS OF STANDARD CHARACTERS WITHOUT CLAIM TO ANY PARTICULAR FONT, STYLE, SIZE, OR COLOR.

NO CLAIM IS MADE TO THE EXCLUSIVE RIGHT TO USE "WALL PLATES", APART FROM THE MARK AS SHOWN.

FOR ELECTRIC OUTLET COVERS; ELECTRIC SWITCH PLATES (U.S. CLS. 21, 23, 26, 36 AND 38).

FIRST USE 11-12-2007; IN COMMERCE 11-12-2007.

CLASS 9—(Continued).

3,568,375. PAGLO LABS INC., PALO ALTO, CA. SN 77-293,472. PUB. 8-12-2008, FILED 10-2-2007.

PAGLO

THE MARK CONSISTS OF STANDARD CHARACTERS WITHOUT CLAIM TO ANY PARTICULAR FONT, STYLE, SIZE, OR COLOR.

FOR COMPUTER PROGRAMS FOR USE IN DISCOVERING, INDEXING, IDENTIFYING, SEARCHING, MANAGING AND COLLABORATING ON A WIDE VARIETY OF INFORMATION IN A VARIETY OF FIELDS (U.S. CLS. 21, 23, 26, 36 AND 38).

FIRST USE 1-29-2008; IN COMMERCE 2-6-2008.

3,568,410. ADVANCED ENERGY INDUSTRIES, INC., FORT COLLINS, CO. SN 77-308,905. PUB. 4-1-2008, FILED 10-19-2007.

Ascent

THE MARK CONSISTS OF STANDARD CHARACTERS WITHOUT CLAIM TO ANY PARTICULAR FONT, STYLE, SIZE, OR COLOR.

FOR POWER CONTROLLERS; POWER SUPPLIES (U.S. CLS. 21, 23, 26, 36 AND 38).

FIRST USE 5-19-2008; IN COMMERCE 11-24-2008.

3,568,413. JAMES R. LOWRY, JR., ALEXANDRIA, VA. SN 77-311,658. PUB. 4-1-2008, FILED 10-23-2007.

Blooming Buds

THE MARK CONSISTS OF STANDARD CHARACTERS WITHOUT CLAIM TO ANY PARTICULAR FONT, STYLE, SIZE, OR COLOR.

NO CLAIM IS MADE TO THE EXCLUSIVE RIGHT TO USE "BUDS", APART FROM THE MARK AS SHOWN.

FOR EAR PHONES (U.S. CLS. 21, 23, 26, 36 AND 38).

FIRST USE 9-2-2008; IN COMMERCE 9-2-2008.

CLASS 9—(Continued).

3,568,416. WINDY CITY WIRE CABLE AND TECHNOLOGY PRODUCTS, LLC, BOLINGBROOK, IL. SN 77-314,432. PUB. 4-8-2008, FILED 10-26-2007.

RACKPACK

THE MARK CONSISTS OF STANDARD CHARACTERS WITHOUT CLAIM TO ANY PARTICULAR FONT, STYLE, SIZE, OR COLOR.

FOR ELECTRICAL WIRE AND CABLE (U.S. CLS. 21, 23, 26, 36 AND 38).

FIRST USE 4-0-2008; IN COMMERCE 4-0-2008.

3,568,420. NEUTRON DYNAMIC SYSTEMS INC., CRESTON, BRITISH COLUMBIA, CANADA. SN 77-317,240. PUB. 3-18-2008, FILED 10-30-2007.

MISCHIEVIOUS

THE MARK CONSISTS OF STANDARD CHARACTERS WITHOUT CLAIM TO ANY PARTICULAR FONT, STYLE, SIZE, OR COLOR.

FOR PRERECORDED DIGITAL VIDEO DISCS (DVD'S) CONTAINING ADULT CONTENT AND PRERECORDED VIDEO TAPES CONTAINING ADULT CONTENT (U.S. CLS. 21, 23, 26, 36 AND 38).

FIRST USE 8-18-2008; IN COMMERCE 8-18-2008.

3,568,433. DIEBOLD, INCORPORATED, NORTH CANTON, OH. SN 77-328,339. PUB. 4-22-2008, FILED 11-13-2007.

OPTIGARD

THE MARK CONSISTS OF STANDARD CHARACTERS WITHOUT CLAIM TO ANY PARTICULAR FONT, STYLE, SIZE, OR COLOR.

FOR ELECTRONIC LOCKS (U.S. CLS. 21, 23, 26, 36 AND 38).

FIRST USE 11-7-2008; IN COMMERCE 12-3-2008.

CLASS 9—(Continued).

3,568,452. GUANGZHOU PULAN ELECT. CO. LTD, GUANGZHOU, CHINA. SN 77-338,776. PUB. 4-22-2008, FILED 11-28-2007.

CLASS 9—(Continued).

3,568,454. MONSTER CABLE PRODUCTS, INC., BRISBANE, CA. SN 77-339,181. PUB. 3-25-2008, FILED 11-28-2007.

NEED FOR SPEED

Pilotek

THE MARK CONSISTS OF STANDARD CHARACTERS WITHOUT CLAIM TO ANY PARTICULAR FONT, STYLE, SIZE, OR COLOR.

FOR ELECTRICAL AND ELECTROMAGNETIC SIGNAL TRANSMITTING, AMPLIFYING, RECEIVING, AND CONVERTING DEVICES, NAMELY, CABLES, WIRES, AND CONNECTORS FOR USE WITH ELECTRICAL, ELECTRONIC, AND COMPUTER DEVICES (U.S. CLS. 21, 23, 26, 36 AND 38).

FIRST USE 9-30-2007; IN COMMERCE 9-30-2007.

THE MARK CONSISTS OF STANDARD CHARACTERS WITHOUT CLAIM TO ANY PARTICULAR FONT, STYLE, SIZE, OR COLOR.

FOR APPARATUS FOR RECORDING, TRANSMISSION, PROCESSING AND REPRODUCTION OF SOUND, IMAGES OR DATA; CALCULATING MACHINES, DATA PROCESSING EQUIPMENT AND COMPUTERS; COMPUTER HARDWARE AND COMPUTER PERIPHERAL DEVICES; COMPUTER SOFTWARE DEVELOPMENT TOOLS; COMPUTER SOFTWARE FOR APPLICATION AND DATABASE INTEGRATION; COMPUTER SOFTWARE FOR THE COLLECTION, EDITING, ORGANIZING, MODIFYING, BOOK MARKING, TRANSMISSION, STORAGE AND SHARING OF DATA AND INFORMATION; COMPUTER SOFTWARE FOR PROCESSING DIGITAL MUSIC FILES; COMPUTER SOFTWARE THAT PROVIDES REAL-TIME, INTEGRATED BUSINESS MANAGEMENT INTELLIGENCE BY COMBINING INFORMATION FROM VARIOUS DATABASES AND PRESENTING IT IN AN EASY-TO-UNDERSTAND USER INTERFACE; COMPUTER SOFTWARE TO AUTOMATE DATA WAREHOUSING; COMPUTER SOFTWARE FOR USE IN CUSTOMER RELATIONSHIP MANAGEMENT (CRM); CENTRAL PROCESSING UNITS (CPU); LOW VOLTAGE POWER SUPPLY; UNINTERRUPTED POWER SUPPLY; ACCUMULATORS AND BATTERIES; AUTOMATIC ELECTRICAL DISTRIBUTION APPARATUS; ELECTRICAL SWITCHES; SWITCH BOXES; ELECTRIC SWITCH PLATES; ELECTRIC DISTRIBUTION CONSOLES; ELECTRICAL DISTRIBUTION BOXES; ELECTRICAL DISTRIBUTION SYSTEMS, NAMELY, POWER DISTRIBUTION PANELS; ELECTRIC CONTROL PANELS; COMPUTER SOFTWARE, NAMELY, AN APPLICATION ALLOWING SALES AND FIELD SERVICE EMPLOYEES TO UPDATE AND RECEIVE DATA STORED IN AN ENTERPRISE'S COMPUTER DATABASES IN REAL TIME, USING A MOBILE DEVICE, WITH FULL TELEPHONY INTEGRATION WITH THE TELEPHONE AND/OR SOFTWARE FEATURES OF THE MOBILE DEVICE; ELECTRIC INSTALLATIONS FOR THE REMOTE CONTROL OF INDUSTRIAL OPERATIONS; COMMUTATION ELECTRIC APPARATUS (U.S. CLS. 21, 23, 26, 36 AND 38).

FIRST USE 1-25-2005; IN COMMERCE 6-17-2008.

3,568,463. MONSTER CABLE PRODUCTS, INC., BRISBANE, CA. SN 77-346,199. PUB. 3-18-2008, FILED 12-6-2007.



OWNER OF U.S. REG. NOS. 2,220,851, 2,728,729, AND OTHERS.

NO CLAIM IS MADE TO THE EXCLUSIVE RIGHT TO USE "ULTRA-HIGH SPEED" AND "10.2 GBPS", APART FROM THE MARK AS SHOWN.

THE MARK CONSISTS OF THE LITERAL ELEMENT ON A STYLIZED DESIGN.

FOR ELECTRICAL AND ELECTROMAGNETIC SIGNAL TRANSMITTING, AMPLIFYING, RECEIVING, AND CONVERTING DEVICES, NAMELY, CABLES, WIRES, AND CONNECTORS FOR USE WITH ELECTRICAL, ELECTRONIC, AND COMPUTER DEVICES (U.S. CLS. 21, 23, 26, 36 AND 38).

FIRST USE 9-30-2007; IN COMMERCE 9-30-2007.

CLASS 9—(Continued).

3,568,464. MONSTER CABLE PRODUCTS, INC., BRISBANE, CA. SN 77-346,206. PUB. 3-18-2008, FILED 12-6-2007.



NO CLAIM IS MADE TO THE EXCLUSIVE RIGHT TO USE "ADVANCED HIGH SPEED" AND "6.68 GBPS", APART FROM THE MARK AS SHOWN.

THE MARK CONSISTS OF THE LITERAL ELEMENT ON A STYLIZED DESIGN.

FOR ELECTRICAL AND ELECTROMAGNETIC SIGNAL TRANSMITTING, AMPLIFYING, RECEIVING, AND CONVERTING DEVICES, NAMELY, CABLES, WIRES, AND CONNECTORS FOR USE WITH ELECTRICAL, ELECTRONIC, AND COMPUTER DEVICES (U.S. CLS. 21, 23, 26, 36 AND 38).

FIRST USE 9-30-2007; IN COMMERCE 9-30-2007.

3,568,481. MIPS TECHNOLOGIES, INC., MOUNTAIN VIEW, CA. SN 77-366,893. PUB. 6-3-2008, FILED 1-8-2008.

1004K

THE MARK CONSISTS OF STANDARD CHARACTERS WITHOUT CLAIM TO ANY PARTICULAR FONT, STYLE, SIZE, OR COLOR.

OWNER OF U.S. REG. NOS. 2,845,137, 3,376,822, AND OTHERS.

FOR COMPUTER SOFTWARE USED IN, AND FOR USE IN THE DESIGN AND DEVELOPMENT OF, MICROPROCESSOR CORES AND SEMICONDUCTOR INTELLECTUAL PROPERTY (SIP) CORES; COMPUTER CODE PRODUCTS, NAMELY, SIMULATORS; SIP CORES AND MICROPROCESSOR CORES; ELECTRONIC PUBLICATIONS IN THE NATURE OF MANUALS, SPECIFICATIONS, GUIDES, AND DATA SHEETS ALL IN THE FIELD OF COMPUTER TECHNOLOGY IN DOWNLOADABLE FORM OR RECORDED ON COMPUTER MEDIA (U.S. CLS. 21, 23, 26, 36 AND 38).

FIRST USE 6-30-2008; IN COMMERCE 6-30-2008.

CLASS 9—(Continued).

3,568,487. SINNESLOSCHEN, LLC, DALLAS, TX. SN 77-372,165. PUB. 6-3-2008, FILED 1-15-2008.

POLYBIUS

THE MARK CONSISTS OF STANDARD CHARACTERS WITHOUT CLAIM TO ANY PARTICULAR FONT, STYLE, SIZE, OR COLOR.

FOR ENTERTAINMENT SERVICES, NAMELY, PROVIDING ON-LINE DOWNLOADABLE SOFTWARE FOR COMPUTER GAMES (U.S. CLS. 21, 23, 26, 36 AND 38).

FIRST USE 10-1-2007; IN COMMERCE 10-1-2007.

3,568,489. SANDLOT GAMES, BOTHELL, WA. SN 77-372,821. PUB. 4-8-2008, FILED 1-16-2008.

Eye for Design

THE MARK CONSISTS OF STANDARD CHARACTERS WITHOUT CLAIM TO ANY PARTICULAR FONT, STYLE, SIZE, OR COLOR.

FOR COMPUTER GAME PROGRAMS; COMPUTER GAME SOFTWARE; COMPUTER PROGRAMS FOR VIDEO AND COMPUTER GAMES; DOWNLOADABLE ELECTRONIC GAME PROGRAMS VIA THE INTERNET AND WIRELESS DEVICES; ELECTRONIC GAME PROGRAMS; ELECTRONIC GAME SOFTWARE; INTERACTIVE MULTIMEDIA COMPUTER GAME PROGRAM; GAME SOFTWARE (U.S. CLS. 21, 23, 26, 36 AND 38).

FIRST USE 5-2-2008; IN COMMERCE 5-2-2008.

3,568,490. CONTEC, LLC, SCHENECTADY, NY. SN 77-373,040. PUB. 6-17-2008, FILED 1-16-2008.

QuickTest

THE MARK CONSISTS OF STANDARD CHARACTERS WITHOUT CLAIM TO ANY PARTICULAR FONT, STYLE, SIZE, OR COLOR.

FOR TESTING SYSTEMS COMPRISED OF HARDWARE AND SOFTWARE FOR TESTING OVERALL FUNCTIONALITY OF CABLE TELEVISION SET TOP BOXES AND TELCO BOXES INCLUDING ALL INPUTS, OUTPUTS AND INTERNAL DIAGNOSTICS (U.S. CLS. 21, 23, 26, 36 AND 38).

FIRST USE 5-27-2008; IN COMMERCE 5-27-2008.

CLASS 9—(Continued).

3,568,502. IPC SYSTEMS, INC., JERSEY CITY, NJ. SN 77-395,874. PUB. 9-9-2008, FILED 2-13-2008.

MAXACCESS 1000

THE MARK CONSISTS OF STANDARD CHARACTERS WITHOUT CLAIM TO ANY PARTICULAR FONT, STYLE, SIZE, OR COLOR.

OWNER OF U.S. REG. NO. 3,341,474.

FOR COMPUTER SOFTWARE THAT PROVIDES DESKTOP COMMUNICATIONS CAPABILITIES FOR USE IN THE FINANCIAL INDUSTRY, TRADING FLOOR ENVIRONMENTS, SECURITY AND LAW ENFORCEMENT INDUSTRY, UTILITY INDUSTRY, HEALTHCARE INDUSTRY AND CUSTOMER SUPPORT AND CONTACT CENTER ENVIRONMENTS AND INSTRUCTIONAL MANUALS, SOLD AS A UNIT (U.S. CLS. 21, 23, 26, 36 AND 38).

FIRST USE 6-16-2008; IN COMMERCE 6-16-2008.

3,568,516. CDMR, INC., CARLSBAD, CA. SN 77-408,004. PUB. 7-29-2008, FILED 2-27-2008.



multi-point^{CD}

NO CLAIM IS MADE TO THE EXCLUSIVE RIGHT TO USE "CD", APART FROM THE MARK AS SHOWN.

THE COLOR(S) BLUE IS/ARE CLAIMED AS A FEATURE OF THE MARK.

THE MARK CONSISTS OF THE WORD "MULTI-POINT" WITH THE LETTERS "CD" AS A SUPERSCRIPIT AT THE END AND A SERIES OF DOTS STACKED VERTICALLY IN A WAVE PATTERN ABOVE THE WORD, ALL APPEARING IN THE COLOR BLUE.

FOR WEB-ENABLED CASE TRACKING AND DATABASE SOFTWARE FOR USE IN MANAGING CONSTRUCTION DEFECT LITIGATION, MEDIATION AND PROJECT MANAGEMENT (U.S. CLS. 21, 23, 26, 36 AND 38).

FIRST USE 1-30-2008; IN COMMERCE 1-30-2008.

CLASS 9—(Continued).

3,568,517. CDMR, INC., CARLSBAD, CA. SN 77-408,023. PUB. 7-29-2008, FILED 2-27-2008.



multi-point^{CD}

NO CLAIM IS MADE TO THE EXCLUSIVE RIGHT TO USE "CD", APART FROM THE MARK AS SHOWN.

THE MARK CONSISTS OF THE WORD "MULTI-POINT" WITH THE LETTERS "CD" AS A SUPERSCRIPIT AT THE END.

FOR WEB-ENABLED CASE TRACKING AND DATABASE SOFTWARE FOR USE IN MANAGING CONSTRUCTION DEFECT LITIGATION, MEDIATION AND PROJECT MANAGEMENT (U.S. CLS. 21, 23, 26, 36 AND 38).

FIRST USE 1-30-2008; IN COMMERCE 1-30-2008.

3,568,549. MARKET CENTRAL, INC., PITTSBURGH, PA. SN 77-444,769. PUB. 9-2-2008, FILED 4-10-2008.



SECURESWITCH

OWNER OF U.S. REG. NO. 2,390,873.

THE MARK CONSISTS OF THE TERM "SECURESWITCH" WITH A DESIGN OF AN UPPER CURVED LINE EXTENDING FROM THE FIRST LETTER "S" TO THE LETTER "H", WITH A DESIGN OF A LOWER CURVED LINE EXTENDING FROM THE FIRST LETTER "S" TO THE SECOND LETTER "C", WITH A DESIGN OF A FIRST DIAGONAL LINE EXTENDING FROM THE UPPER CURVED LINE TO THE LETTER "U", AND WITH A DESIGN OF A SECOND DIAGONAL LINE EXTENDING FROM THE LETTER "U" TO THE UPPER CURVED LINE.

FOR TELECOMMUNICATION SWITCHES (U.S. CLS. 21, 23, 26, 36 AND 38).

FIRST USE 12-4-2008; IN COMMERCE 12-4-2008.

CLASS 9—(Continued).

3,568,560. SURFATECH CORPORATION, DACULA, GA. SN 77-488,106. PUB. 8-26-2008, FILED 6-1-2008.

CLASS 9—(Continued).

3,568,592. KLD ASSOCIATES, INC., HAUPPAUGE, NY. SN 78-494,448. PUB. 9-13-2005, FILED 10-5-2004.

POLYMER SPECTATOR

IMPOST

THE MARK CONSISTS OF STANDARD CHARACTERS WITHOUT CLAIM TO ANY PARTICULAR FONT, STYLE, SIZE, OR COLOR.

NO CLAIM IS MADE TO THE EXCLUSIVE RIGHT TO USE "POLYMER", APART FROM THE MARK AS SHOWN.

FOR DOWNLOADABLE ELECTRONIC PUBLICATIONS IN THE NATURE OF ELECTRONIC NEWSLETTERS IN THE FIELD OF POLYMER CHEMISTRY (U.S. CLS. 21, 23, 26, 36 AND 38).

FIRST USE 11-15-2008; IN COMMERCE 11-15-2008.

THE MARK CONSISTS OF STANDARD CHARACTERS WITHOUT CLAIM TO ANY PARTICULAR FONT, STYLE, SIZE, OR COLOR.

FOR COMPUTER SOFTWARE FOR USE IN TRANSPORTATION ENGINEERING AND SIMULATION (U.S. CLS. 21, 23, 26, 36 AND 38).

FIRST USE 12-0-2003; IN COMMERCE 12-0-2003.

3,568,580. RAGULA SYSTEMS DEVELOPMENT CORP., DBA FATPIPE NETWORKS, SALT LAKE CITY, UT. SN 78-412,800. PUB. 4-1-2008, FILED 5-4-2004.

3,568,604. AK, TUNC, LOS ANGELES, CA. SN 78-646,780. PUB. 11-21-2006, FILED 6-8-2005.

SPAM POLICE



THE MARK CONSISTS OF STANDARD CHARACTERS WITHOUT CLAIM TO ANY PARTICULAR FONT, STYLE, SIZE, OR COLOR.

NO CLAIM IS MADE TO THE EXCLUSIVE RIGHT TO USE "SPAM", APART FROM THE MARK AS SHOWN.

FOR COMPUTER NETWORKING HARDWARE FOR QUARANTINING UNSOLICITED EMAIL (U.S. CLS. 21, 23, 26, 36 AND 38).

FIRST USE 7-21-2008; IN COMMERCE 7-21-2008.

THE MARK CONSISTS OF THE "TA" CIRCULAR LOGO WHICH REPRESENTS TUNC AK.

FOR DOWNLOADABLE MUSICAL SOUND RECORDINGS (U.S. CLS. 21, 23, 26, 36 AND 38).

FIRST USE 1-0-2008; IN COMMERCE 1-0-2008.

CLASS 9—(Continued).

3,568,606. TOPTRONIC LIMITED, CENTRAL HONG KONG, HONG KONG. SN 78-649,320. PUB. 12-12-2006, FILED 6-13-2005.



The logo for TOPTRONIC features the word "TOP" in a large, bold, italicized sans-serif font, with a thick horizontal bar above it. Below "TOP" is the word "TRONIC" in a similar bold, italicized sans-serif font, with a thick horizontal bar above it as well.

THE MARK CONSISTS OF STANDARD CHARACTERS WITHOUT CLAIM TO ANY PARTICULAR FONT, STYLE, SIZE, OR COLOR.

FOR ELECTRICAL AND ELECTRONIC TEST AND MEASURING INSTRUMENTS AND APPARATUS, NAMELY, INSULATION TESTERS, PROSPECTIVE SHORT CIRCUIT TESTERS, CLAMP-METERS, RESISTANCE TESTERS, THERMOMETERS, HIGH VOLTAGE TESTERS AND INSULATION TESTERS TO TEST AND MEASURE INSULATION RESISTANCE; CONTINUITY TESTERS TO TEST AND MEASURE CONTINUITY RESISTANCE; PROSPECTIVE SHORT CIRCUIT TESTERS TO TEST AND MEASURE WHAT A SHORT CIRCUIT CURRENT WOULD BE IF A SHORT CIRCUIT IS DONE AT THE SAME LOCATION WHERE THE TEST IS DONE; LOOP TESTERS TO TEST AND MEASURE WHAT THE LOOP IMPEDANCE OF A CIRCUIT IS; CLAMP-METERS TO MEASURE THE CURRENT BY CLAMPING A SENSOR AROUND A WIRE; RESISTANCE TESTERS TO TEST AND MEASURE RESISTANCE; THERMOMETERS TO TEST AND MEASURE TEMPERATURE; HIGH VOLTAGE TESTERS TO TEST AND MEASURE INSULATION RESISTANCE AND RELATED PARAMETERS USING A HIGH VOLTAGE TECHNIQUE THAT LOW CURRENT AND HIGH RESISTANCE CAN BE MEASURED AND USED FOR PREDICTIVE MAINTENANCE; LOW OHM TESTERS AND MICRO OHMS METERS TO TEST AND MEASURE LOW RESISTANCE IN THE ORDER OF MICRO AND NANO OHMS BY INJECTING HIGH CURRENT (U.S. CLS. 21, 23, 26, 36 AND 38).

FIRST USE 12-31-1991; IN COMMERCE 12-31-1998.

3,568,607. GUITAR CENTER, INC., WESTLAKE VILLAGE, CA. SN 78-650,328. PUB. 6-17-2008, FILED 6-14-2005.

STERLING AUDIO

THE MARK CONSISTS OF STANDARD CHARACTERS WITHOUT CLAIM TO ANY PARTICULAR FONT, STYLE, SIZE, OR COLOR.

CLASS 9—(Continued).

NO CLAIM IS MADE TO THE EXCLUSIVE RIGHT TO USE "AUDIO", APART FROM THE MARK AS SHOWN.

FOR MICROPHONES, MICROPHONE CARTRIDGES, MICROPHONE STANDS, CASES FOR MICROPHONES AND AUDIO SYSTEMS, MICROPHONE WINDSCREENS, POP FILTERS, SPEAKER MICROPHONES, SPEAKER MICROPHONE CARTRIDGES, MICROPHONE CABLES AND CORDSETS, AUDIO CABLES, POWER CABLES, MICROPHONE TRANSFORMERS, AUDIO MIXERS, PREAMPLIFIERS, POWER AMPLIFIERS, AUDIO AMPLIFIERS, WIRELESS AUDIO RECEIVERS, WIRELESS AUDIO TRANSMITTERS, ANTENNAS, ANTENNA DISTRIBUTION SYSTEMS, NAMELY, AMPLIFIERS, COMBINERS AND SPLITTERS; ANTENNA CABLES, ANTENNA SPLITTERS, RACK MOUNTING KITS, NAMELY, BRACKETS, FASTENERS, TRAYS, SPACERS, PANELS, CONNECTORS AND CABLES; MICROPHONE GOOSENECKS, MICROPHONE ANTI-ROLL DEVICES, AUDIO CONNECTORS, WIRELESS AUDIO SYSTEMS, NAMELY, MICROPHONES, RECEIVERS, TRANSMITTERS, POWER SUPPLIES, CABLES AND ANTENNAS; AUDIO EQUALIZERS, AUDIO PROCESSORS, AUDIO FEEDBACK REDUCERS, POWER SUPPLIES, HARD WIRED AND WIRELESS AUDIO MONITOR SYSTEMS, NAMELY, TRANSMITTERS, RECEIVERS, EARPIECES, HEADPHONES, SPEAKERS; MICROPHONE GRILLS, MICROPHONE MOUNTS AND ADAPTERS, MICROPHONE SWITCHES, MOUNTS FOR ATTACHING MICROPHONES OR AUDIO EQUIPMENT TO A USER, AUDIO EQUIPMENT, NAMELY, STEREO SPEAKERS, WOOFERS, SUB-WOOFERS, TWEETERS AND AMPLIFIERS (U.S. CLS. 21, 23, 26, 36 AND 38).

FIRST USE 6-1-2006; IN COMMERCE 6-1-2006.

3,568,611. GALE CORPORATION, SACRAMENTO, CA. SN 78-661,705. PUB. 6-6-2006, FILED 6-30-2005.



THE MARK CONSISTS OF THE TEXT "INNOVATION" IN OUTLINED LETTERS. THE DOT ABOVE THE FIRST "I" IS REPLACED BY A LIGHT BULB WITH AN ABSTRACT LOGO ON THE INTERIOR. BEHIND THE LIGHT BULB AND THE TEXT IS A CHECKERED FLAG.

FOR SPLITTERS, DIRECTIONAL COUPLERS, FILTERS, AMPLIFIERS, FREQUENCY CONVERTERS, ALL OF WHICH ARE DEVICES INVOLVED WITH THE SPLITTING OR MODIFYING OF THE AUDIO, VIDEO, AND DATA SIGNALS IN LOW VOLTAGE NETWORKS (U.S. CLS. 21, 23, 26, 36 AND 38).

FIRST USE 6-15-2005; IN COMMERCE 5-1-2008.

CLASS 9—(Continued).

3,568,616. MEDTRONIC, INC., MINNEAPOLIS, MN. SN 78-697,564. PUB. 11-29-2005, FILED 8-22-2005.

CLASS 9—(Continued).

3,568,629. HNTB HOLDINGS LTD, KANAS CITY, MO. SN 78-768,856. PUB. 8-8-2006, FILED 12-7-2005.

SOFTSTART/STOP

THE MARK CONSISTS OF STANDARD CHARACTERS WITHOUT CLAIM TO ANY PARTICULAR FONT, STYLE, SIZE, OR COLOR.

FOR CONTROL CIRCUITRY, WHICH INCLUDES A PROGRAMMING FEATURE THEREIN TO PROVIDE AN IMPLANTED NEUROSTIMULATOR THAT INCREMENTALLY INCREASES AND DECREASES STIMULATION AMPLITUDE UNTIL IT REACHES A SPECIFIED LEVEL (U.S. CLS. 21, 23, 26, 36 AND 38).

FIRST USE 3-7-2002; IN COMMERCE 3-7-2002.

ROUTE WORKS

THE MARK CONSISTS OF STANDARD CHARACTERS WITHOUT CLAIM TO ANY PARTICULAR FONT, STYLE, SIZE, OR COLOR.

NO CLAIM IS MADE TO THE EXCLUSIVE RIGHT TO USE "ROUTE", APART FROM THE MARK AS SHOWN.

FOR COMPUTER SOFTWARE FOR DISPLAYING LIVE TRAVEL AND ADVISORY INFORMATION IN THE FIELD OF TRAFFIC INFORMATION (U.S. CLS. 21, 23, 26, 36 AND 38).

FIRST USE 9-28-2004; IN COMMERCE 9-28-2004.

3,568,621. TAIYO YUDEN CO., LTD., TOKYO, JAPAN. SN 78-724,479. PUB. 2-5-2008, FILED 9-30-2005.

TYG03

THE MARK CONSISTS OF STANDARD CHARACTERS WITHOUT CLAIM TO ANY PARTICULAR FONT, STYLE, SIZE, OR COLOR.

PRIORITY CLAIMED UNDER SEC. 44(D) ON AUSTRALIA APPLICATION NO. 1073584, FILED 9-2-2005.

FOR BLANK OPTICAL DISCS (U.S. CLS. 21, 23, 26, 36 AND 38).

FIRST USE 3-0-2005; IN COMMERCE 3-0-2005.

3,568,646. ENVOY CORPORATION, NASHVILLE, TN. SN 78-840,367. PUB. 7-3-2007, FILED 3-17-2006.

3,568,622. PHYSICAL OPTICS CORPORATION, TORRANCE, CA. SN 78-740,243. PUB. 2-27-2007, FILED 10-25-2005.

SMART SEARCH

THE MARK CONSISTS OF STANDARD CHARACTERS WITHOUT CLAIM TO ANY PARTICULAR FONT, STYLE, SIZE, OR COLOR.

NO CLAIM IS MADE TO THE EXCLUSIVE RIGHT TO USE "SEARCH", APART FROM THE MARK AS SHOWN.

FOR COMPUTER SOFTWARE AND DOCUMENTATION DISTRIBUTED THEREWITH, NAMELY, AUTOMATED ELIGIBILITY VERIFICATION SOFTWARE CONTAINING CASCADING SEARCH CRITERIA FOR USE IN DETERMINING WHETHER A PATIENT IS COVERED BY HEALTH INSURANCE (U.S. CLS. 21, 23, 26, 36 AND 38).

FIRST USE 7-0-2006; IN COMMERCE 7-0-2006.

THE MARK CONSISTS OF STANDARD CHARACTERS WITHOUT CLAIM TO ANY PARTICULAR FONT, STYLE, SIZE, OR COLOR.

FOR METAL DETECTORS; OPTICAL INSPECTION APPARATUS FOR INDUSTRIAL USE; X-RAY PHOTOGRAPHS, OTHER THAN FOR MEDICAL PURPOSES (U.S. CLS. 21, 23, 26, 36 AND 38).

FIRST USE 6-0-2007; IN COMMERCE 3-5-2008.

LEXID

CLASS 9—(Continued).

3,568,653. XCPT COMMUNICATION TECHNOLOGIES, LLC, VENICE, FL. SN 78-864,996. PUB. 11-28-2006, FILED 4-19-2006.

LOOK BY XCPT

THE MARK CONSISTS OF STANDARD CHARACTERS WITHOUT CLAIM TO ANY PARTICULAR FONT, STYLE, SIZE, OR COLOR.

FOR FEATURE OF COMPUTER SOFTWARE USED TO MANAGE, RENDER, INTERPRET, ENHANCE AND PROCESS PICTURES, X-RAYS, IMAGES AND DIGITAL CONTENT IN THE FIELD OF DENTISTRY FOR DIAGNOSIS AND TREATMENT (U.S. CLS. 21, 23, 26, 36 AND 38).

FIRST USE 6-1-2006; IN COMMERCE 6-1-2006.

3,568,682. SAN MARTIN, KRISTY RAIN, BOZEMAN, MT. AND SAN MARTIN, SAGE WILLIAM, BOZEMAN, MT. SN 78-937,459. PUB. 10-30-2007, FILED 7-25-2006.

Dwarven Mine Productions

THE MARK CONSISTS OF STANDARD CHARACTERS WITHOUT CLAIM TO ANY PARTICULAR FONT, STYLE, SIZE, OR COLOR.

NO CLAIM IS MADE TO THE EXCLUSIVE RIGHT TO USE "PRODUCTIONS", APART FROM THE MARK AS SHOWN.

FOR AUDIO RECORDINGS FEATURING MUSIC (U.S. CLS. 21, 23, 26, 36 AND 38).

FIRST USE 9-1-2006; IN COMMERCE 9-29-2008.

3,568,683. VIDEOJET TECHNOLOGIES INC., WOOD DALE, IL. SN 78-939,338. PUB. 3-18-2008, FILED 7-27-2006.

IMPRINTS

THE MARK CONSISTS OF STANDARD CHARACTERS WITHOUT CLAIM TO ANY PARTICULAR FONT, STYLE, SIZE, OR COLOR.

FOR COMPUTER SOFTWARE FOR GENERATING UNIQUE PRODUCT IDENTIFIERS THAT CAN BE EMBEDDED IN A RFID CHIP, BE SCANNED AS A LINEAR OR 2D BAR CODE, OR BE HUMAN READABLE IN ORDER TO TRACE ITEMS FROM THEIR SOURCE THROUGHOUT THE SUPPLY CHAIN (U.S. CLS. 21, 23, 26, 36 AND 38).

FIRST USE 6-1-2008; IN COMMERCE 6-1-2008.

CLASS 9—(Continued).

3,568,687. AGAMATRIX, INC., SALEM, NH. SN 78-946,591. PUB. 3-13-2007, FILED 8-7-2006.

ZERO-CLICK

THE MARK CONSISTS OF STANDARD CHARACTERS WITHOUT CLAIM TO ANY PARTICULAR FONT, STYLE, SIZE, OR COLOR.

FOR WIRED COMMUNICATION DEVICES FOR COMMUNICATION BETWEEN ANY OF THE DIGITAL SIGNAL PROCESSING APPARATUS AND DATA TRANSFER OR EXTERNAL OR REMOTE STORAGE DEVICES, FOR EXAMPLE A CABLE FOR CONNECTING A DIGITAL SIGNAL PROCESSING APPARATUS TO A PERSONAL COMPUTER; SOFTWARE FOR CONTROLLING ELECTROCHEMICAL METERS FOR THE MEDICAL PURPOSE OF ELECTROCHEMICAL MONITORING OF ANALYTES IN BIOLOGICAL FLUIDS; SOFTWARE FOR CONTROLLING ELECTROCHEMICAL METERS FOR THE MEDICAL PURPOSE OF ELECTROCHEMICAL MONITORING OF GLUCOSE IN BIOLOGICAL FLUIDS; SOFTWARE FOR CONTROLLING WIRED COMMUNICATION DEVICES FOR COMMUNICATION BETWEEN A DIGITAL SIGNAL PROCESSING APPARATUS AND A DATA TRANSFER OR EXTERNAL OR REMOTE STORAGE DEVICE; AND COMBINATIONS THEREOF SOLD AS A UNIT (U.S. CLS. 21, 23, 26, 36 AND 38).

FIRST USE 1-24-2007; IN COMMERCE 1-24-2007.

3,568,693. HEARTLAND STUDIO'S, INCORPORATED, OREGON, IL. SN 78-960,789. PUB. 7-17-2007, FILED 8-25-2006.

THE DEER GUYS

THE MARK CONSISTS OF STANDARD CHARACTERS WITHOUT CLAIM TO ANY PARTICULAR FONT, STYLE, SIZE, OR COLOR.

FOR PRE-RECORDED DIGITAL VIDEO DISCS, DIGITAL COMPUTER FILES, INCLUDING AUDIO, VIDEO, TEXT, BINARY, STILL IMAGE, GRAPHICS AND MULTIMEDIA FILES COMPACT DISCS FEATURING COMEDY (U.S. CLS. 21, 23, 26, 36 AND 38).

FIRST USE 6-30-2007; IN COMMERCE 6-30-2007.

CLASS 9—(Continued).

3,568,706. DISNEY ENTERPRISES, INC., BURBANK, CA. SN 78-980,788. PUB. 7-31-2007, FILED 12-8-2005.

CLASS 10—(Continued).

3,568,249. BROOKS, CATHERINE, SOLANA BEACH, CA. SN 77-223,655. PUB. 12-25-2007, FILED 7-6-2007.

CRIMINAL MINDS

THE MARK CONSISTS OF STANDARD CHARACTERS WITHOUT CLAIM TO ANY PARTICULAR FONT, STYLE, SIZE, OR COLOR.

FOR PRE-RECORDED DVDS, DIGITAL VERSATILE DISC, DIGITAL VIDEO DISCS FEATURING LIVE ACTION ENTERTAINMENT (U.S. CLS. 21, 23, 26, 36 AND 38).

FIRST USE 11-0-2006; IN COMMERCE 11-0-2006.

C-PANTY

THE MARK CONSISTS OF STANDARD CHARACTERS WITHOUT CLAIM TO ANY PARTICULAR FONT, STYLE, SIZE, OR COLOR.

FOR CLOTHING AND UNDERGARMENTS FOR MEDICAL PURPOSES POST SURGICALLY, NAMELY, PANTY, UNDERWEAR, BIKINI, THONG, SLEEPWEAR, BELT, SUPPORT CLOTHING IN THE NATURE OF A GIRDLE, LOW-RISE, HIGH RISE, SUPPORT STYLE, FULL OR CUT HEIGHT UNDERGARMENT OR UNDERPANTS HAVING ONE OR MORE MEDICAMENT AND/OR COMPRESSION PANELS TO PROMOTE HEALING OF SURGICAL SCARS (U.S. CLS. 26, 39 AND 44).

FIRST USE 10-11-2006; IN COMMERCE 9-13-2007.

CLASS 10—MEDICAL APPARATUS

3,568,162. H.H. BROWN SHOE TECHNOLOGIES, INC., GREENWICH, CT. SN 77-137,473. PUB. 9-25-2007, FILED 3-22-2007.

KÜR X

THE MARK CONSISTS OF STANDARD CHARACTERS WITHOUT CLAIM TO ANY PARTICULAR FONT, STYLE, SIZE, OR COLOR.

FOR ORTHOPEDIC SOLES; ORTHOTIC INSERTS FOR FOOTWEAR (U.S. CLS. 26, 39 AND 44).

FIRST USE 4-30-2007; IN COMMERCE 4-30-2007.

3,568,253. BECTON, DICKINSON AND COMPANY, FRANKLIN LAKES, NJ. SN 77-226,869. PUB. 12-25-2007, FILED 7-11-2007.

3,568,197. OLYMPUS AMERICA, INC., CENTER VALLEY, PA. SN 77-171,814. PUB. 9-25-2007, FILED 5-3-2007.



THE MARK CONSISTS OF THE STYLIZED WORD "ENDOCLEANER" WITH A SHADOW OF THE PRODUCT GOING THROUGH THE LETTER "C" AND UNDER THE REMAINDER OF THE MARK. THERE IS ALSO A BRUSH DESIGN ABOVE THE LETTERS "EANER" IN THE MARK.

FOR ENDOSCOPIC EQUIPMENT, NAMELY, BRUSHES FOR CLEANING CHANNELS OF MEDICAL ENDOSCOPES (U.S. CLS. 26, 39 AND 44).

FIRST USE 5-0-2005; IN COMMERCE 5-0-2005.



THE MARK CONSISTS OF A SHADED CIRCLE WITH A LINE DOWN THE MIDDLE AND TWO LINES ACROSS.

FOR MEDICAL NEEDLES (U.S. CLS. 26, 39 AND 44).

FIRST USE 5-1-2008; IN COMMERCE 5-1-2008.

CLASS 10—(Continued).

3,568,260. AMERICAN HEARING SYSTEMS INC., DBA INTERTON INC., BLOOMINGTON, MN. SN 77-229,558. PUB. 11-20-2007, FILED 7-13-2007.

INSTINCT

THE MARK CONSISTS OF STANDARD CHARACTERS WITHOUT CLAIM TO ANY PARTICULAR FONT, STYLE, SIZE, OR COLOR.

FOR HEARING AIDS (U.S. CLS. 26, 39 AND 44).
FIRST USE 7-0-2008; IN COMMERCE 7-0-2008.

3,568,280. ADVANCED CIRCULATORY SYSTEMS, INC., EDEN PRAIRIE, MN. SN 77-245,757. PUB. 6-3-2008, FILED 8-2-2007.

ResQGard

THE MARK CONSISTS OF STANDARD CHARACTERS WITHOUT CLAIM TO ANY PARTICULAR FONT, STYLE, SIZE, OR COLOR.

OWNER OF U.S. REG. NOS. 2,643,815, 2,770,302, AND 2,785,012.

FOR MEDICAL DEVICE IN THE NATURE OF IMPEDANCE THRESHOLD DEVICE USED ON SPONTANEOUSLY BREATHING PEOPLE IN STATES OF LOW BLOOD FLOW FOR THE PURPOSE OF REDUCING POOR CIRCULATION DURING HYPOTENSION FROM A VARIETY OF CAUSES IN THE NATURE OF ORTHOSTATIC INTOLERANCE, HYPOVOLEMIA, HEAT SHOCK, BLOOD DONATION AND DIALYSIS (U.S. CLS. 26, 39 AND 44).

FIRST USE 1-1-2008; IN COMMERCE 1-1-2008.

3,568,397. HELENA LABORATORIES CORPORATION, BEAUMONT, TX. SN 77-299,621. PUB. 3-25-2008, FILED 10-9-2007.

HEMOHEEL

THE MARK CONSISTS OF STANDARD CHARACTERS WITHOUT CLAIM TO ANY PARTICULAR FONT, STYLE, SIZE, OR COLOR.

FOR MEDICAL DEVICES, NAMELY, A DEVICE USED FOR MAKING AN INCISION ON A BABY'S HEEL TO FACILITATE OBTAINING A BLOOD SPECIMEN (U.S. CLS. 26, 39 AND 44).

FIRST USE 9-21-2007; IN COMMERCE 11-17-2008.

CLASS 10—(Continued).

3,568,417. VERTEBRAL TECHNOLOGIES, INC., MINNETONKA, MN. SN 77-315,261. PUB. 4-15-2008, FILED 10-27-2007.

UPLIFT

THE MARK CONSISTS OF STANDARD CHARACTERS WITHOUT CLAIM TO ANY PARTICULAR FONT, STYLE, SIZE, OR COLOR.

FOR MEDICAL AND SURGICAL APPARATUS AND INSTRUMENTS, NAMELY, ORTHOPEDIC FIXATION DEVICE USED IN ORTHOPEDIC TRANSPLANT AND/OR IMPLANT SURGERY (U.S. CLS. 26, 39 AND 44).

FIRST USE 12-3-2008; IN COMMERCE 12-3-2008.

3,568,446. KOIS CENTER, LLC, SEATTLE, WA. SN 77-334,524. PUB. 4-29-2008, FILED 11-20-2007.

TaKteeth

THE MARK CONSISTS OF STANDARD CHARACTERS WITHOUT CLAIM TO ANY PARTICULAR FONT, STYLE, SIZE, OR COLOR.

FOR DENTAL OVERLAY FOR USE IN FACILITATING ESTHETIC ORIENTATION AND PREVIEWING CHANGES IN TOOTH POSITION (U.S. CLS. 26, 39 AND 44).

FIRST USE 7-17-2008; IN COMMERCE 8-5-2008.

3,568,498. DISTLER MICHAEL J., KEMAH, TX. SN 77-385,020. PUB. 6-24-2008, FILED 1-31-2008.



NO CLAIM IS MADE TO THE EXCLUSIVE RIGHT TO USE "SCANNER", APART FROM THE MARK AS SHOWN. THE COLOR(S) BLUE AND TEAL IS/ARE CLAIMED AS A FEATURE OF THE MARK.

CLASS 10—(Continued).

THE MARK CONSISTS OF BLUE WAVE DESIGN WITH THE WORDING "DELTA SCANNER" IN A TEAL STYLIZED FONT SUPERIMPOSED ON TOP.

FOR ELECTROMEDICAL REHABILITATIVE AND PAIN MANAGEMENT PRODUCTS FOR CLINICAL AND HOME USE, NAMELY, ELECTRICAL NERVE AND MUSCLE STIMULATORS, ULTRASONIC STIMULATORS, MAGNET THERAPY STIMULATORS AND LASER THERAPY STIMULATORS; ELECTRONIC STIMULATOR FOR NERVES, SKIN AND MUSCLE; NERVE STIMULATOR APPARATUS (U.S. CLS. 26, 39 AND 44).

FIRST USE 10-14-2008; IN COMMERCE 10-14-2008.

3,568,586. CORNOVA, INC., BURLINGTON, MA. SN 78-454,188. PUB. 10-11-2005, FILED 7-21-2004.

CorNova

THE MARK CONSISTS OF STANDARD CHARACTERS WITHOUT CLAIM TO ANY PARTICULAR FONT, STYLE, SIZE, OR COLOR.

FOR CARDIOVASCULAR MEDICAL DEVICES, NAMELY, ANGIOPLASTY CATHETERS AND STENTS (U.S. CLS. 26, 39 AND 44).

FIRST USE 2-28-2006; IN COMMERCE 2-28-2006.

3,568,613. ANDERSEN STERILIZERS, INC., HAW RIVER, NC. SN 78-674,643. PUB. 3-13-2007, FILED 7-20-2005.

ANDERSEN ABATOR

THE MARK CONSISTS OF STANDARD CHARACTERS WITHOUT CLAIM TO ANY PARTICULAR FONT, STYLE, SIZE, OR COLOR.

OWNER OF U.S. REG. NO. 860,220.
NO CLAIM IS MADE TO THE EXCLUSIVE RIGHT TO USE "ABATOR", APART FROM THE MARK AS SHOWN.
SEC. 2(F).

FOR MEDICAL APPARATUS, NAMELY, CABINETS AND CARTRIDGES FOR ATTACHMENT TO STERILIZER ENCLOSURES FOR THE PURPOSE OF REMOVING ETHYLENE OXIDE FROM THE EXHAUST STREAM THEREOF (U.S. CLS. 26, 39 AND 44).

FIRST USE 10-3-2008; IN COMMERCE 10-3-2008.

CLASS 10—(Continued).

3,568,623. FKA DISTRIBUTING CO., DBA HOMEDICS, INC., COMMERCE TOWNSHIP, MI. SN 78-741,408. PUB. 1-9-2007, FILED 10-27-2005.

SMART FIT

THE MARK CONSISTS OF STANDARD CHARACTERS WITHOUT CLAIM TO ANY PARTICULAR FONT, STYLE, SIZE, OR COLOR.

FOR BLOOD PRESSURE MONITOR CUFF SOLD AS AN INTEGRAL COMPONENT OF BLOOD PRESSURE MONITORS (U.S. CLS. 26, 39 AND 44).

FIRST USE 1-0-2006; IN COMMERCE 1-0-2006.

3,568,705. WILSON-COOK MEDICAL INC., WINSTON-SALEM, NC. SN 78-980,752. PUB. 9-4-2007, FILED 8-18-2006.

HERCULES

THE MARK CONSISTS OF STANDARD CHARACTERS WITHOUT CLAIM TO ANY PARTICULAR FONT, STYLE, SIZE, OR COLOR.

FOR MEDICAL DEVICES, NAMELY, ESOPHAGEAL DILATION BALLOONS (U.S. CLS. 26, 39 AND 44).

FIRST USE 4-30-2008; IN COMMERCE 4-30-2008.

CLASS 11—ENVIRONMENTAL CONTROL APPARATUS

3,568,030. SHARP KABUSHIKI KAISHA, TA SHARP CORPORATION, OSAKA 545-8522, JAPAN. SN 76-682,676. PUB. 3-18-2008, FILED 10-4-2007.

TWINTOUCH

THE MARK CONSISTS OF STANDARD CHARACTERS WITHOUT CLAIM TO ANY PARTICULAR FONT, STYLE, SIZE, OR COLOR.

FOR MICROWAVE OVENS FOR COMMERCIAL USE (U.S. CLS. 13, 21, 23, 31 AND 34).

FIRST USE 1-31-2008; IN COMMERCE 1-31-2008.

CLASS 11—(Continued).

3,568,039. SHENZHEN SUNZONE ELECTRICAL APPLIANCES LTD., SHENZHEN, CHINA. SN 77-006,971. PUB. 3-4-2008, FILED 9-25-2006.

ASTERION

FOR AIR CONDITIONER FITTINGS, NAMELY, VALVES FOR AIR CONDITIONERS; AIR HEATER, NAMELY, HOT AIR BLOWER, HOT-AIR SPACE HEATING APPARATUS FOR HOUSEHOLD PURPOSES; ELECTRIC SPACE HEATERS, ELECTRIC HEATERS FOR COMMERCIAL USE; FAN FOR AIR CONDITIONING, NAMELY, ELECTRIC FANS FOR HOUSEHOLD PURPOSES, ELECTRIC FANS; OVENS, NAMELY, BAKING OVENS, DOMESTIC COOKING OVENS, ELECTRIC COOKING OVEN FOR HOUSEHOLD PURPOSES; ELECTRIC HEATER FITTING, NAMELY, HEAT PIPES TO COOL HEAT PRODUCING COMPONENTS, HEAT SINKS FOR USE IN HEATING, HEAT REGISTERS; ELECTRIC HEATER, NAMELY, ELECTRIC SPACE HEATERS, ELECTRIC RADIANT HEATERS FOR HOUSEHOLD PURPOSES, ELECTRIC HEATER FOR COMMERCIAL USE; AIR PURIFYING FITTING AND MACHINE, NAMELY, AIR CLEANING UNITS, AIR PURIFICATION UNITS, AIR PURIFIERS, AIR PURIFIERS FOR HOUSEHOLD PURPOSES, AIR PURIFYING UNITS FOR COMMERCIAL, DOMESTIC AND INDUSTRIAL USE; CLOTHES DRYERS FOR HOUSEHOLD USE; HUMIDIFIER FITTING, NAMELY, VALVES FOR HUMIDIFIERS; ELECTRIC WATER HEATER (U.S. CLS. 13, 21, 23, 31 AND 34).

FIRST USE 7-19-2006; IN COMMERCE 7-19-2006.

3,568,098. AAF-MCQUAY INC., LOUISVILLE, KY. SN 77-083,395. PUB. 1-22-2008, FILED 1-16-2007.

MicroKlean

THE MARK CONSISTS OF STANDARD CHARACTERS WITHOUT CLAIM TO ANY PARTICULAR FONT, STYLE, SIZE, OR COLOR.

FOR AIR FILTERS FOR RESIDENTIAL USE (U.S. CLS. 13, 21, 23, 31 AND 34).

FIRST USE 4-15-1999; IN COMMERCE 4-15-1999.

CLASS 11—(Continued).

3,568,176. CATACEL CORP., GARRETTSVILLE, OH. SN 77-151,497. PUB. 10-9-2007, FILED 4-9-2007.

HEP

THE MARK CONSISTS OF STANDARD CHARACTERS WITHOUT CLAIM TO ANY PARTICULAR FONT, STYLE, SIZE, OR COLOR.

FOR HEAT EXCHANGERS NOT BEING PARTS OF MACHINES; HEAT EXCHANGERS FOR FUEL PROCESSING AND FOR FUEL CELL SYSTEMS; HEAT EXCHANGERS FOR SUPPORTING CHEMICAL REACTIONS (U.S. CLS. 13, 21, 23, 31 AND 34).

FIRST USE 7-14-2008; IN COMMERCE 7-14-2008.

3,568,202. ECOQUEST INTERNATIONAL, INC., GREENEVILLE, TN. SN 77-176,167. PUB. 4-8-2008, FILED 5-9-2007.

THINK OUTSIDE. INSIDE

THE MARK CONSISTS OF STANDARD CHARACTERS WITHOUT CLAIM TO ANY PARTICULAR FONT, STYLE, SIZE, OR COLOR.

FOR ENVIRONMENTAL CONTROL APPARATUS, NAMELY, PARTICLE ACTIVATORS FOR USE IN AIR AND SURFACE PURIFICATION FOR DOMESTIC AND COMMERCIAL USE (U.S. CLS. 13, 21, 23, 31 AND 34).

FIRST USE 8-0-2007; IN COMMERCE 8-0-2007.

3,568,207. DEGREE CONTROLS, INC., MILFORD, NH. SN 77-179,758. PUB. 9-11-2007, FILED 5-14-2007.

HotSpotr

THE MARK CONSISTS OF STANDARD CHARACTERS WITHOUT CLAIM TO ANY PARTICULAR FONT, STYLE, SIZE, OR COLOR.

FOR DYNAMIC AIRFLOW MANAGEMENT SYSTEM USED TO MANAGE TEMPERATURE, HUMIDITY, AIRFLOW OR PARTICULATES IN PRECISION ENVIRONMENTS SUCH AS DATA CENTERS, CLEAN ROOMS, LABORATORIES AND CRITICAL MANUFACTURING, COMPRISED OF INTELLIGENT ELECTRIC FAN OR NETWORK OF ELECTRIC FANS FEATURING AN ARRAY OF ENVIRONMENTAL SENSORS WHICH CAN SENSE TEMPERATURE, HUMIDITY, AIRFLOW AND PARTICULATES (U.S. CLS. 13, 21, 23, 31 AND 34).

FIRST USE 7-0-2007; IN COMMERCE 7-0-2007.

CLASS 11—(Continued).

3,568,213. AEROGROW INTERNATIONAL, INC., BOULDER, CO. SN 77-185,032. PUB. 10-2-2007, FILED 5-18-2007.

FLORIST IN A BOX

THE MARK CONSISTS OF STANDARD CHARACTERS WITHOUT CLAIM TO ANY PARTICULAR FONT, STYLE, SIZE, OR COLOR.

FOR GARDENING APPLIANCE SYSTEMS, NAMELY, HYDROPONIC AND AEROPONIC, AGRICULTURAL AND HORTICULTURAL PROPAGATION SYSTEMS, FOR USE IN GROWING PLANTS, NAMELY, ONE OR MORE ENVIRONMENTALLY CONTROLLED CHAMBERS AND APPARATUS CAPABLE OF PROVIDING WATER, PLANT NUTRIENTS, AND LIGHT, SAID SYSTEM COMPRISING AN IRRIGATION UNIT, OPTIONALLY A WATER PUMP, LIGHTING FIXTURES, AND LIGHTS, SAID SYSTEM OPTIONALLY SOLD WITH INTEGRATED COMPONENTS FOR PLANT GROWTH, NAMELY, SEED POD UNITS CONSISTING OF CONTAINERS, SPONGE-LIKE GROWTH MATRICES, AND/OR SEEDS, AND/OR PLANT NUTRIENTS, ALL SOLD AS A UNIT (U.S. CLS. 13, 21, 23, 31 AND 34).
FIRST USE 9-1-2007; IN COMMERCE 11-12-2007.

CLASS 11—(Continued).

3,568,223. MENARD, INC., EAU CLAIRE, WI. SN 77-192,012. PUB. 12-25-2007, FILED 5-29-2007.

GUIDESMAN

THE MARK CONSISTS OF STANDARD CHARACTERS WITHOUT CLAIM TO ANY PARTICULAR FONT, STYLE, SIZE, OR COLOR.

OWNER OF U.S. REG. NOS. 3,028,185 AND 3,028,186.
FOR FLASHLIGHTS, CRANK LIGHTS, NAMELY, CRANK POWERED FLASHLIGHTS AND LATERNES, ELECTRIC LANTERNS, SPOTLIGHTS, PERSONAL HEADLAMPS AND BOOK LIGHTS (U.S. CLS. 13, 21, 23, 31 AND 34).
FIRST USE 12-0-2005; IN COMMERCE 12-0-2005.

3,568,258. FILTREX HOLDINGS PTE LTD, PARKLANE MALL, SINGAPORE. SN 77-228,549. PUB. 11-27-2007, FILED 7-12-2007.

BRAND INSIDE THE BRANDS

THE MARK CONSISTS OF STANDARD CHARACTERS WITHOUT CLAIM TO ANY PARTICULAR FONT, STYLE, SIZE, OR COLOR.

FOR CARBON FILTERS FOR WATER FILTRATION (U.S. CLS. 13, 21, 23, 31 AND 34).
FIRST USE 3-0-2008; IN COMMERCE 3-0-2008.

3,568,291. ARROWHEAD BRASS PRODUCTS, LLC, LOS ANGELES, CA. SN 77-257,586. PUB. 2-12-2008, FILED 8-16-2007.

ARROW-BREAKER

THE MARK CONSISTS OF STANDARD CHARACTERS WITHOUT CLAIM TO ANY PARTICULAR FONT, STYLE, SIZE, OR COLOR.

OWNER OF U.S. REG. NO. 2,010,123.
FOR PLUMBING FITTINGS, NAMELY, VALVES, FAUCETS AND HANDLES (U.S. CLS. 13, 21, 23, 31 AND 34).
FIRST USE 7-0-2007; IN COMMERCE 7-0-2007.

3,568,222. MENARD, INC., EAU CLAIRE, WI. SN 77-192,006. PUB. 12-25-2007, FILED 5-29-2007.



OWNER OF U.S. REG. NOS. 3,028,185 AND 3,028,186.
THE APPLICANT CLAIMS COLOR AS A FEATURE OF THE MARK, NAMELY, BEIGE AND BROWN.

THE MARK CONSISTS OF A COMPASS DESIGN WITH THE WORD "GUIDESMAN" WRITTEN ACROSS THE CENTER. THE TERM "GUIDESMAN" APPEARS IN BEIGE AGAINST A RECTANGULAR BROWN BACKGROUND WITH A BEIGE BORDER. THE CIRCULAR BACKGROUND APPEARS IN BEIGE WITH A BROWN BORDER. THE RAYS OF THE CENTRAL STAR DESIGN ARE ALTERNATIELY BROWN AND BEIGE.

FOR FLASHLIGHTS, CRANK LIGHTS, NAMELY, CRANK POWERED FLASHLIGHTS AND LANTERNS, ELECTRIC LANTERNS, SPOTLIGHTS, PERSONAL HEADLAMPS AND BOOK LIGHTS (U.S. CLS. 13, 21, 23, 31 AND 34).
FIRST USE 12-0-2005; IN COMMERCE 12-0-2005.

CLASS 11—(Continued).

3,568,326. MAURA DANIEL, INC., CULVER CITY, CA. SN 77-276,779. PUB. 3-18-2008, FILED 9-11-2007.

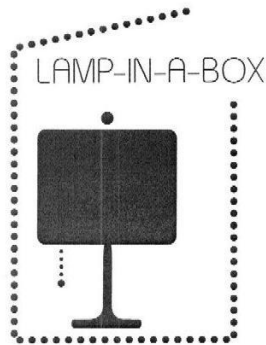

NO CLAIM IS MADE TO THE EXCLUSIVE RIGHT TO USE "LAMP-IN-A-BOX", APART FROM THE MARK AS SHOWN.

THE MARK CONSISTS OF A SILHOUETTE OF A TABLE LAMP FRAMED BY A DOTTED RECTANGLE WITH THE TOP BORDER ANGLED SLIGHTLY UPWARD TO SUGGEST THE OPEN LID OF A BOX, AND THE WORDING "LAMP-IN-A-BOX" APPEARING ABOVE THE LAMP AND BELOW THE TOP BORDER OF THE BOX.

FOR TABLE LAMPS (U.S. CLS. 13, 21, 23, 31 AND 34).
FIRST USE 10-1-2008; IN COMMERCE 10-1-2008.

3,568,359. BRILLIANT PRODUCTS, LLC, BILLINGS, MT. SN 77-287,503. PUB. 3-18-2008, FILED 9-24-2007.

BRILLIANT CONCEPTS

THE MARK CONSISTS OF STANDARD CHARACTERS WITHOUT CLAIM TO ANY PARTICULAR FONT, STYLE, SIZE, OR COLOR.

FOR LIGHTING FIXTURES (U.S. CLS. 13, 21, 23, 31 AND 34).
FIRST USE 12-2-2008; IN COMMERCE 12-2-2008.

CLASS 11—(Continued).

3,568,370. STERIL-AIRE, INC., BURBANK, CA. SN 77-291,578. PUB. 3-18-2008, FILED 9-28-2007.

STERIL-ZONE

THE MARK CONSISTS OF STANDARD CHARACTERS WITHOUT CLAIM TO ANY PARTICULAR FONT, STYLE, SIZE, OR COLOR.

FOR AIR CLEANING UNITS; AIR FILTERS FOR DOMESTIC USE; AIR PURIFICATION UNITS; AIR PURIFIERS; HOUSEHOLD AIR CLEANERS; ULTRAVIOLET LAMPS NOT FOR MEDICAL PURPOSES (U.S. CLS. 13, 21, 23, 31 AND 34).

FIRST USE 10-31-2007; IN COMMERCE 10-31-2007.

3,568,467. NOVITA CO., LTD., CHUNGCHEONGNAM-DO, REPUBLIC OF KOREA. SN 77-355,026. PUB. 7-15-2008, FILED 12-18-2007.

novita

THE MARK CONSISTS OF STANDARD CHARACTERS WITHOUT CLAIM TO ANY PARTICULAR FONT, STYLE, SIZE, OR COLOR.

FOR HOUSEHOLD NON-ELECTRIC WATER PURIFIERS; HOUSEHOLD DISH STERILIZERS; HOUSEHOLD WATER PURIFIERS; HOUSEHOLD BAKING OVENS; BREAD MAKERS; HEAT WAVE OVENS; BAKING OVENS; MICROWAVE OVENS; TOILETS; TOILET SEATS; BIDETS; WASHING TOILETS; ELECTRIC HEATING APPARATUS IN THE NATURE OF A SPACE HEATER; ELECTRIC RADIATORS; HOUSEHOLD AIR PURIFIERS; HOUSEHOLD WATER IONIZERS; HOUSEHOLD ELECTRIC BATH PURIFIERS; AIR DRIERS; AIR STERILIZERS; AIR PURIFIERS; ELECTRIC AIR DEODORIZERS; WATER STERILIZERS; WATER FILTERS FOR DOMESTIC USE; HUMIDIFIERS; ELECTRIC PRESSURE COOKERS; ELECTRIC WATER HEATERS; ELECTRIC RICE AND PRESSURE COOKERS (U.S. CLS. 13, 21, 23, 31 AND 34).

FIRST USE 11-10-2007; IN COMMERCE 11-10-2007.

CLASS 11—(Continued).

3,568,624. FUSION UV SYSTEMS, INC., GAITHERSBURG, MD. SN 78-745,417. PUB. 4-1-2008, FILED 11-2-2005.

CREATIVE SOLUTIONS USING
THE POWER OF LIGHT

THE MARK CONSISTS OF STANDARD CHARACTERS WITHOUT CLAIM TO ANY PARTICULAR FONT, STYLE, SIZE, OR COLOR.

FOR ULTRAVIOLET LAMPS, NOT FOR MEDICAL PURPOSES, COMPRISING LIGHT-EMITTING BULBS AND OTHER PARTS THEREFOR, NAMELY, POWER SUPPLIES OR POWER GENERATING DEVICES, REFLECTIVE AND REFRACTIVE OPTICS, INTERCONNECTING CABLES, AND THE POLYMERIZING COATINGS USED THEREWITH FOR ULTRA VIOLET CURING APPLICATIONS SOLD AS A UNIT (U.S. CLS. 13, 21, 23, 31 AND 34).

FIRST USE 11-1-2008; IN COMMERCE 11-1-2008.

3,568,625. FUSION UV SYSTEMS, INC., GAITHERSBURG, MD. SN 78-745,609. PUB. 4-1-2008, FILED 11-2-2005.

CREATIVE SOLUTIONS USING
THE INCREDIBLE POWER OF
LIGHT

THE MARK CONSISTS OF STANDARD CHARACTERS WITHOUT CLAIM TO ANY PARTICULAR FONT, STYLE, SIZE, OR COLOR.

FOR ULTRAVIOLET LAMPS, NOT FOR MEDICAL PURPOSES, COMPRISING LIGHT-EMITTING BULBS AND OTHER PARTS THEREFOR, NAMELY, POWER SUPPLIES OR POWER GENERATING DEVICES, REFLECTIVE AND REFRACTIVE OPTICS, INTERCONNECTING CABLES, AND THE POLYMERIZING COATINGS USED THEREWITH FOR ULTRA VIOLET CURING APPLICATIONS SOLD AS A UNIT (U.S. CLS. 13, 21, 23, 31 AND 34).

FIRST USE 11-1-2008; IN COMMERCE 11-1-2008.

3,568,695. SLOAN VALVE COMPANY, FRANKLIN AVENUE, IL. SN 78-964,715. PUB. 9-25-2007, FILED 8-31-2006.



OWNER OF U.S. REG. NOS. 576,222, 620,217, AND OTHERS.

CLASS 11—(Continued).

NO CLAIM IS MADE TO THE EXCLUSIVE RIGHT TO USE "100 YEARS 1906-2006", APART FROM THE MARK AS SHOWN.

FOR PLUMBING FIXTURES, NAMELY, FLUSH VALVES, FLUSHOMETER BODIES, ACTIVATION HANDLES, CONTROL STOPS, VACUUM BREAKERS AND INTERNAL REPAIR PARTS THEREOF, QUIET FLUSH VALVE EQUIPMENT COMPRISED OF FLUSH VALVES ASSEMBLES (U.S. CLS. 13, 21, 23, 31 AND 34).

FIRST USE 10-2-2006; IN COMMERCE 10-2-2006.

CLASS 12—VEHICLES

3,568,096. MAXI MILIAAN B.V., HELMOND, NETHERLANDS. SN 77-080,694. PUB. 10-16-2007, FILED 1-11-2007.

MAXI-COSI MICO

THE MARK CONSISTS OF STANDARD CHARACTERS WITHOUT CLAIM TO ANY PARTICULAR FONT, STYLE, SIZE, OR COLOR.

OWNER OF U.S. REG. NOS. 2,721,687 AND 3,206,453.

FOR BABY CARRIAGES, NAMELY, PUSHCHAIRS, BUGGIES, PRAMS AND STRUCTURAL PARTS THEREFOR; SAFETY SEATS FOR CHILDREN AND BABIES FOR USE IN AND ON VEHICLES FOR TRANSPORT BY LAND, AIR AND WATER, PARTS THEREFOR SOLD AS A UNIT WITH THE GOODS; SAFETY BELTS FOR VEHICLE SEATS FOR CHILDREN AND ADULTS; WHEELED SUPPORTS FOR CAR SEATS FOR CHILDREN AND BABIES FOR USE AS A STROLLER; FITTED COVERS AND INSERTS ADAPTED FOR CAR SEATS (U.S. CLS. 19, 21, 23, 31, 35 AND 44).

FIRST USE 5-31-2007; IN COMMERCE 5-31-2007.

3,568,125. MVP RV, INC., MORENO VALLEY, CA. SN 77-109,701. PUB. 3-4-2008, FILED 2-16-2007.

SONOMA

THE MARK CONSISTS OF STANDARD CHARACTERS WITHOUT CLAIM TO ANY PARTICULAR FONT, STYLE, SIZE, OR COLOR.

FOR RECREATIONAL VEHICLES, NAMELY, TRAVEL TRAILERS (U.S. CLS. 19, 21, 23, 31, 35 AND 44).

FIRST USE 0-0-2007; IN COMMERCE 0-0-2007.

CLASS 12—(Continued).

3,568,143. ANDERSEN MANUFACTURING, INC., IDAHO FALLS, ID. SN 77-127,216. PUB. 2-12-2008, FILED 3-9-2007.

ALUMISTINGER

THE MARK CONSISTS OF STANDARD CHARACTERS WITHOUT CLAIM TO ANY PARTICULAR FONT, STYLE, SIZE, OR COLOR.

FOR VEHICLE TOW BARS AND BALL MOUNTS FOR ATTACHING TO VEHICLES FOR TOWING (U.S. CLS. 19, 21, 23, 31, 35 AND 44).

FIRST USE 9-1-2001; IN COMMERCE 9-1-2001.

CLASS 12—(Continued).

3,568,343. HYUNDAI TRANSLEAD, SAN DIEGO, CA. SN 77-281,776. PUB. 2-26-2008, FILED 9-18-2007.

HT HY-CUBE

THE MARK CONSISTS OF STANDARD CHARACTERS WITHOUT CLAIM TO ANY PARTICULAR FONT, STYLE, SIZE, OR COLOR.

NO CLAIM IS MADE TO THE EXCLUSIVE RIGHT TO USE "HIGH CUBE", APART FROM THE MARK AS SHOWN.

FOR SEMI-TRACTOR TRAILERS (U.S. CLS. 19, 21, 23, 31, 35 AND 44).

FIRST USE 11-20-2008; IN COMMERCE 11-20-2008.

3,568,285. GET KAYAKTIVE, L.L.C., ORIENTAL, NC. SN 77-252,045. PUB. 2-12-2008, FILED 8-10-2007.

KAYAKTIVE

THE MARK CONSISTS OF STANDARD CHARACTERS WITHOUT CLAIM TO ANY PARTICULAR FONT, STYLE, SIZE, OR COLOR.

FOR KAYAK LOADERS AND LAUNCHERS (U.S. CLS. 19, 21, 23, 31, 35 AND 44).

FIRST USE 9-30-2008; IN COMMERCE 9-30-2008.

3,568,344. HYUNDAI TRANSLEAD, SAN DIEGO, CA. SN 77-281,780. PUB. 2-26-2008, FILED 9-18-2007.

HT DROPFRAME

THE MARK CONSISTS OF STANDARD CHARACTERS WITHOUT CLAIM TO ANY PARTICULAR FONT, STYLE, SIZE, OR COLOR.

NO CLAIM IS MADE TO THE EXCLUSIVE RIGHT TO USE "DROP FRAME", APART FROM THE MARK AS SHOWN.

FOR SEMI-TRACTOR TRAILERS (U.S. CLS. 19, 21, 23, 31, 35 AND 44).

FIRST USE 11-20-2008; IN COMMERCE 11-20-2008.

3,568,321. BOOK FAIRY, INC., OMAHA, NE. SN 77-272,472. PUB. 3-4-2008, FILED 9-5-2007.

Oopsi

THE MARK CONSISTS OF STANDARD CHARACTERS WITHOUT CLAIM TO ANY PARTICULAR FONT, STYLE, SIZE, OR COLOR.

FOR STRAPS FOR CHILDREN'S CAR SEATS FOR ATTACHING BOOKS, TOYS, CUPS AND THE LIKE (U.S. CLS. 19, 21, 23, 31, 35 AND 44).

FIRST USE 9-7-2007; IN COMMERCE 9-7-2007.

3,568,364. TOYO BOSEKI KABUSHIKI KAISHA, DBA TOYOBO CO., LTD., OSAKA, JAPAN. SN 77-289,776. PUB. 2-19-2008, FILED 9-26-2007.

VOLANS

THE MARK CONSISTS OF STANDARD CHARACTERS WITHOUT CLAIM TO ANY PARTICULAR FONT, STYLE, SIZE, OR COLOR.

FOR AUTOMOTIVE INTERIOR TRIM MADE OF NON-WOVEN FABRIC (U.S. CLS. 19, 21, 23, 31, 35 AND 44).

FIRST USE 12-1-1978; IN COMMERCE 12-21-2007.

CLASS 12—(Continued).

3,568,462. BENNINGTON MARINE, LLC, ELKHART, IN. SN 77-344,817. PUB. 5-6-2008, FILED 12-5-2007.

ESP

THE MARK CONSISTS OF STANDARD CHARACTERS WITHOUT CLAIM TO ANY PARTICULAR FONT, STYLE, SIZE, OR COLOR.
FOR RECREATIONAL BOATS AND STRUCTURAL PARTS THEREFOR (U.S. CLS. 19, 21, 23, 31, 35 AND 44).
FIRST USE 6-0-2007; IN COMMERCE 7-0-2007.

3,568,492. SPECIALIZED BICYCLE COMPONENTS, INC., MORGAN HILL, CA. SN 77-373,607. PUB. 6-17-2008, FILED 1-16-2008.

COMMAND POST

THE MARK CONSISTS OF STANDARD CHARACTERS WITHOUT CLAIM TO ANY PARTICULAR FONT, STYLE, SIZE, OR COLOR.
FOR BICYCLE SEAT POSTS (U.S. CLS. 19, 21, 23, 31, 35 AND 44).
FIRST USE 7-3-2008; IN COMMERCE 9-1-2008.

3,568,547. VANCE, JOHN, BAY CITY, TX. SN 77-443,382. PUB. 8-26-2008, FILED 4-8-2008.



FOR BOATS (U.S. CLS. 19, 21, 23, 31, 35 AND 44).
FIRST USE 6-30-1998; IN COMMERCE 9-17-2004.

CLASS 12—(Continued).

3,568,689. ISLAND CITY, LLC, MERRILL, WI. SN 78-951,424. PUB. 7-17-2007, FILED 8-14-2006.

FMTV+

THE MARK CONSISTS OF STANDARD CHARACTERS WITHOUT CLAIM TO ANY PARTICULAR FONT, STYLE, SIZE, OR COLOR.
FOR MODIFIED TACTICAL LAND VEHICLES (U.S. CLS. 19, 21, 23, 31, 35 AND 44).
FIRST USE 8-1-2008; IN COMMERCE 8-1-2008.

CLASS 13—FIREARMS

3,568,033. WINCO FIREWORKS INTERNATIONAL, L.L.C., PRAIRIE VILLAGE, KS. SN 76-685,458. PUB. 5-27-2008, FILED 1-2-2008.

PRO FIRE

THE MARK CONSISTS OF STANDARD CHARACTERS WITHOUT CLAIM TO ANY PARTICULAR FONT, STYLE, SIZE, OR COLOR.
OWNER OF U.S. REG. NOS. 2,455,387 AND 3,187,321.
NO CLAIM IS MADE TO THE EXCLUSIVE RIGHT TO USE "FIRE", APART FROM THE MARK AS SHOWN.
FOR FIREWORKS DETONATOR (U.S. CLS. 2 AND 9).
FIRST USE 6-11-2008; IN COMMERCE 6-12-2008.

3,568,137. KENG'S FIREARMS SPECIALTY, INC., ATLANTA, GA. SN 77-122,561. PUB. 9-4-2007, FILED 3-5-2007.

THUNDER

THE MARK CONSISTS OF STANDARD CHARACTERS WITHOUT CLAIM TO ANY PARTICULAR FONT, STYLE, SIZE, OR COLOR.
FOR BI-POD SUPPORT STANDS AND GRIPS FOR USE WITH SMALL ARMS/WEAPONRY; MOUNTING ADAPTORS FOR BI-POD SUPPORT STANDS AND GRIPS FOR SMALL ARMS/WEAPONRY (U.S. CLS. 2 AND 9).
FIRST USE 11-21-2008; IN COMMERCE 11-21-2008.

CLASS 13—(Continued).

3,568,302. MACE SECURITY INTERNATIONAL, INC., BENNINGTON, VT. SN 77-262,910. PUB. 6-24-2008, FILED 8-23-2007.

MACE PEPPER GUN

THE MARK CONSISTS OF STANDARD CHARACTERS WITHOUT CLAIM TO ANY PARTICULAR FONT, STYLE, SIZE, OR COLOR.

OWNER OF U.S. REG. NOS. 88,891, 1,656,201, AND 1,909,927.

NO CLAIM IS MADE TO THE EXCLUSIVE RIGHT TO USE "PEPPER GUN", APART FROM THE MARK AS SHOWN.

FOR AEROSOL DISPENSER FOR PERSONAL DEFENSE (U.S. CLS. 2 AND 9).

FIRST USE 8-23-2007; IN COMMERCE 8-23-2007.

CLASS 14—JEWELRY

3,568,152. BULOVA CORPORATION, WOODSIDE, NY. SN 77-131,077. PUB. 7-1-2008, FILED 3-14-2007.

ACCUTRON ASTRONAUT

THE MARK CONSISTS OF STANDARD CHARACTERS WITHOUT CLAIM TO ANY PARTICULAR FONT, STYLE, SIZE, OR COLOR.

OWNER OF U.S. REG. NO. 709,055.

FOR WATCHES (U.S. CLS. 2, 27, 28 AND 50).

FIRST USE 8-24-2007; IN COMMERCE 8-24-2007.

3,568,234. CHRISTOPHER YEE, MORTON GROVE, IL. SN 77-203,562. PUB. 4-1-2008, FILED 6-12-2007.

YG COMMEMORATIVE

THE MARK CONSISTS OF STANDARD CHARACTERS WITHOUT CLAIM TO ANY PARTICULAR FONT, STYLE, SIZE, OR COLOR.

NO CLAIM IS MADE TO THE EXCLUSIVE RIGHT TO USE "COMMEMORATIVE", APART FROM THE MARK AS SHOWN.

CLASS 14—(Continued).

THE WORDING "YG" HAS NO MEANING OTHER THAN TRADEMARK SIGNIFICANCE.

FOR COLLECTIBLE COINS; COMMEMORATIVE COINS; NON-MONETARY COINS; ORNAMENTAL LAPEL PINS; ORNAMENTAL PINS; MEDALS; MEDALLIONS (U.S. CLS. 2, 27, 28 AND 50).

FIRST USE 12-1-2008; IN COMMERCE 12-1-2008.

3,568,537. BARNEY'S BLING, SANTA MONICA, CA. SN 77-428,808. PUB. 8-5-2008, FILED 3-21-2008.



barney's bling

NO CLAIM IS MADE TO THE EXCLUSIVE RIGHT TO USE "BLING", APART FROM THE MARK AS SHOWN.

THE MARK CONSISTS OF THE TEXT "BARNEY'S BLING" IN SMALL CASE LETTERS, SIMPLE TYPE FONT; A DIAMOND SYMBOL OVER THE "I" IN "BLING"; A DOG LOGO (SILHOUETTE OF A YORKSHIRE TERRIER STANDING WITH DIAMOND AROUND NECK).

FOR JEWELRY; PET JEWELRY (U.S. CLS. 2, 27, 28 AND 50).

FIRST USE 11-1-2007; IN COMMERCE 11-1-2007.

3,568,559. MULTI MEDIA EXPOSURE, INC., BERNARDSVILLE, NJ. SN 77-478,378. PUB. 8-5-2008, FILED 5-19-2008.

PAB

THE MARK CONSISTS OF STANDARD CHARACTERS WITHOUT CLAIM TO ANY PARTICULAR FONT, STYLE, SIZE, OR COLOR.

FOR JEWELRY (U.S. CLS. 2, 27, 28 AND 50).

FIRST USE 10-17-2008; IN COMMERCE 10-17-2008.

CLASS 14—(Continued).

3,568,567. CONWAY, MARY, CLEVELAND HEIGHTS, OH. SN 78-198,348. PUB. 10-14-2003, FILED 12-28-2002.

RINGDROP

FOR PENDANT – NECKLACE PENDANT FOR NECKLACE JEWELRY ITEM (U.S. CLS. 2, 27, 28 AND 50). FIRST USE 7-6-2006; IN COMMERCE 7-6-2006.



3,568,568. JACK REISS LLC, NEW YORK, NY. SN 78-214,415. PUB. 10-23-2007, FILED 2-13-2003.

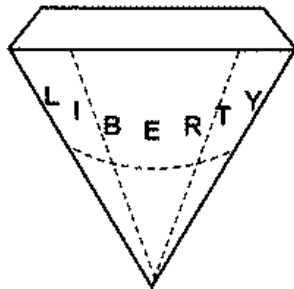

THE LINING IS A FEATURE OF THE MARK AND DOES NOT INDICATE COLOR. FOR JEWELRY, NAMELY, DIAMONDS (U.S. CLS. 2, 27, 28 AND 50). FIRST USE 6-25-2008; IN COMMERCE 6-25-2008.



CLASS 16—PAPER GOODS AND PRINTED MATTER

3,568,008. PENTEL OF AMERICA, LTD., TORRANCE, CA. SN 76-660,826. PUB. 1-22-2008, FILED 5-30-2006.

PENNA

THE MARK CONSISTS OF STANDARD CHARACTERS WITHOUT CLAIM TO ANY PARTICULAR FONT, STYLE, SIZE, OR COLOR. FOR PENS AND PEN CASES; PENCILS AND PENCIL CASES; DAILY PLANNERS AND CALENDARS (U.S. CLS. 2, 5, 22, 23, 29, 37, 38 AND 50). FIRST USE 6-0-2007; IN COMMERCE 6-0-2007.

CLASS 16—(Continued).

3,568,024. GILMAN, PETER A., TOLEDO, OH. SN 76-680,149. PUB. 3-18-2008, FILED 8-1-2007.

STROKE BY STROKE

THE MARK CONSISTS OF STANDARD CHARACTERS WITHOUT CLAIM TO ANY PARTICULAR FONT, STYLE, SIZE, OR COLOR. FOR GREETING CARDS (U.S. CLS. 2, 5, 22, 23, 29, 37, 38 AND 50). FIRST USE 12-1-2008; IN COMMERCE 12-1-2008.



3,568,080. FINE CRAFT, INC., GLENCOE, IL. SN 77-063,412. PUB. 12-18-2007, FILED 12-13-2006.

FUNNY LITTLE FRIEND SERIES

THE MARK CONSISTS OF STANDARD CHARACTERS WITHOUT CLAIM TO ANY PARTICULAR FONT, STYLE, SIZE, OR COLOR. NO CLAIM IS MADE TO THE EXCLUSIVE RIGHT TO USE "SERIES", APART FROM THE MARK AS SHOWN. FOR CHILDREN'S BOOKS (U.S. CLS. 2, 5, 22, 23, 29, 37, 38 AND 50). FIRST USE 11-0-2008; IN COMMERCE 11-0-2008.



3,568,106. SCOTT, MEREDITH, GREENSBORO, NC. SN 77-095,290. PUB. 7-24-2007, FILED 1-31-2007.

ON THE BALL

THE MARK CONSISTS OF STANDARD CHARACTERS WITHOUT CLAIM TO ANY PARTICULAR FONT, STYLE, SIZE, OR COLOR. FOR PERSONAL ORGANIZERS (U.S. CLS. 2, 5, 22, 23, 29, 37, 38 AND 50). FIRST USE 10-14-2008; IN COMMERCE 10-14-2008.

CLASS 16—(Continued).

3,568,109. PLAYBOY ENTERPRISES INTERNATIONAL, INC., CHICAGO, IL. SN 77-099,670. PUB. 7-10-2007, FILED 2-5-2007.

ROCK THE RABBIT

THE MARK CONSISTS OF STANDARD CHARACTERS WITHOUT CLAIM TO ANY PARTICULAR FONT, STYLE, SIZE, OR COLOR.

SEC. 2(F).
FOR MAGAZINE SECTIONS IN THE FIELD OF MUSIC AND FASHION (U.S. CLS. 2, 5, 22, 23, 29, 37, 38 AND 50).

FIRST USE 2-28-2007; IN COMMERCE 2-28-2007.

3,568,116. B601 FOGGY BOTTOM LLC, HOBOKEN, NJ. SN 77-102,024. PUB. 7-31-2007, FILED 2-7-2007.

buyyourfriendadrink

THE MARK CONSISTS OF STANDARD CHARACTERS WITHOUT CLAIM TO ANY PARTICULAR FONT, STYLE, SIZE, OR COLOR.

FOR GIFT CARDS (U.S. CLS. 2, 5, 22, 23, 29, 37, 38 AND 50).

FIRST USE 3-25-2007; IN COMMERCE 3-25-2007.

CLASS 16—(Continued).

3,568,129. WOOPS CONCEPT LIMITED, CENTRAL, HONG KONG. SN 77-115,825. PUB. 3-4-2008, FILED 2-26-2007.

!

énfasis

THE MARK CONSISTS OF THE WORD "ENFASIS" IN STYLIZED LOWER CASE LETTERS WITH AN ACUTE ACCENT ABOVE THE E, ALL UNDERNEATH A STYLIZED EXCLAMATION POINT.

FOR STATIONERY; ART SUPPLIES, NAMELY, WATER COLORS, CRAYONS, OIL PASTELS, SOFT PASTELS, COLORED PENCILS, MARKERS, PAINT-BRUSHES, PAINTERS' EASELS, CANVAS FOR PAINTING, AND ART SUPPLIES KITS CONTAINING ONE OR MORE OF THE PRECEDING ITEMS, NAMELY, SCRAP-BOOKS; NOTEBOOKS; DRAWING BOOKS AND SKETCHPADS (U.S. CLS. 2, 5, 22, 23, 29, 37, 38 AND 50).

FIRST USE 12-0-2006; IN COMMERCE 7-6-2008.

3,568,163. SEVEN DAYS PUBLISHING LLC, LONG BEACH, CA. SN 77-137,813. PUB. 3-25-2008, FILED 3-22-2007.

THE DISTRICT WEEKLY

THE MARK CONSISTS OF STANDARD CHARACTERS WITHOUT CLAIM TO ANY PARTICULAR FONT, STYLE, SIZE, OR COLOR.

NO CLAIM IS MADE TO THE EXCLUSIVE RIGHT TO USE "WEEKLY", APART FROM THE MARK AS SHOWN.

FOR WEEKLY NEWSPAPER (U.S. CLS. 2, 5, 22, 23, 29, 37, 38 AND 50).

FIRST USE 4-11-2007; IN COMMERCE 4-11-2007.

CLASS 16—(Continued).

3,568,169. IBASIS, INC., BURLINGTON, MA. SN 77-144,451.
PUB. 7-10-2007, FILED 3-30-2007.

Asia United

THE MARK CONSISTS OF STANDARD CHARACTERS WITHOUT CLAIM TO ANY PARTICULAR FONT, STYLE, SIZE, OR COLOR.

NO CLAIM IS MADE TO THE EXCLUSIVE RIGHT TO USE "ASIA", APART FROM THE MARK AS SHOWN.

FOR PRE-PAID TELEPHONE CALLING CARDS, NOT MAGNETICALLY ENCODED; TELEPHONE CALLING CARDS, NOT MAGNETICALLY ENCODED (U.S. CLS. 2, 5, 22, 23, 29, 37, 38 AND 50).

FIRST USE 11-25-2008; IN COMMERCE 11-25-2008.

CLASS 16—(Continued).

3,568,340. SAMUEL F. MULGREW, PEOSTA, IA. SN 77-281,237. PUB. 3-11-2008, FILED 9-17-2007.

PREBITUARIES

THE MARK CONSISTS OF STANDARD CHARACTERS WITHOUT CLAIM TO ANY PARTICULAR FONT, STYLE, SIZE, OR COLOR.

FOR A SERIES OF WRITTEN ARTICLES IN THE FIELD OF PERSONAL LIFE EXPERIENCES, PERSONAL STORIES AND BIOGRAPHICAL INFORMATION ABOUT LIVING INDIVIDUALS (U.S. CLS. 2, 5, 22, 23, 29, 37, 38 AND 50).

FIRST USE 3-19-2008; IN COMMERCE 3-19-2008.

3,568,246. ETHIKIDS, INC., NEW YORK, NICARAGUA. SN 77-220,705. PUB. 3-18-2008, FILED 7-2-2007.

WHAT'S THE DEAL?

THE MARK CONSISTS OF STANDARD CHARACTERS WITHOUT CLAIM TO ANY PARTICULAR FONT, STYLE, SIZE, OR COLOR.

FOR CONVERSATION CARDS, NAMELY, PRINTED MATTER IN THE FORM OF CARDS, ON WHICH STORIES AND QUESTIONS ARE PRINTED IN ORDER TO ENCOURAGE CONVERSATION (U.S. CLS. 2, 5, 22, 23, 29, 37, 38 AND 50).

FIRST USE 12-10-2007; IN COMMERCE 2-15-2008.

3,568,352. UP COUNTRY INC., EAST PROVIDENCE, RI. SN 77-286,027. PUB. 3-18-2008, FILED 9-21-2007.

UP COUNTRY

THE MARK CONSISTS OF STANDARD CHARACTERS WITHOUT CLAIM TO ANY PARTICULAR FONT, STYLE, SIZE, OR COLOR.

OWNER OF U.S. REG. NO. 1,303,720.

FOR NOTE CARDS, GREETING CARDS AND INVITATION CARDS (U.S. CLS. 2, 5, 22, 23, 29, 37, 38 AND 50).

FIRST USE 1-31-2003; IN COMMERCE 1-31-2003.

3,568,328. JAKKS PACIFIC, INC., MALIBU, CA. SN 77-277,143. PUB. 3-25-2008, FILED 9-11-2007.

STICK ART

THE MARK CONSISTS OF STANDARD CHARACTERS WITHOUT CLAIM TO ANY PARTICULAR FONT, STYLE, SIZE, OR COLOR.

NO CLAIM IS MADE TO THE EXCLUSIVE RIGHT TO USE "ART", APART FROM THE MARK AS SHOWN.

FOR ARTS AND CRAFT PAINT KITS; ALBUMS FOR STICKERS; STICKERS; MARKERS; POSTERS; DECALS (U.S. CLS. 2, 5, 22, 23, 29, 37, 38 AND 50).

FIRST USE 6-2-2008; IN COMMERCE 6-2-2008.

3,568,380. CYCON, DEAN, ORANGE, MA. SN 77-294,028. PUB. 3-18-2008, FILED 10-2-2007.

JAVA NOTES

THE MARK CONSISTS OF STANDARD CHARACTERS WITHOUT CLAIM TO ANY PARTICULAR FONT, STYLE, SIZE, OR COLOR.

NO CLAIM IS MADE TO THE EXCLUSIVE RIGHT TO USE "NOTES", APART FROM THE MARK AS SHOWN.

FOR NOTE CARDS; NOTE PAPER (U.S. CLS. 2, 5, 22, 23, 29, 37, 38 AND 50).

FIRST USE 7-1-2008; IN COMMERCE 7-1-2008.

CLASS 16—(Continued).

3,568,390. VALPAK DIRECT MARKETING SYSTEMS, INC., LARGO, FL. SN 77-296,620. PUB. 3-18-2008, FILED 10-4-2007.

THE BLUE ENVELOPE

THE MARK CONSISTS OF STANDARD CHARACTERS WITHOUT CLAIM TO ANY PARTICULAR FONT, STYLE, SIZE, OR COLOR.

NO CLAIM IS MADE TO THE EXCLUSIVE RIGHT TO USE "ENVELOPE", APART FROM THE MARK AS SHOWN. FOR ENVELOPES, BROCHURES, BOOKLETS, PAMPHLETS, AND COUPON BOOKS WHICH PROMOTE THE GOODS AND SERVICES OF OTHERS (U.S. CLS. 2, 5, 22, 23, 29, 37, 38 AND 50).

FIRST USE 12-26-2007; IN COMMERCE 12-26-2007.

3,568,427. JAKKS PACIFIC, INC., MALIBU, CA. SN 77-321,496. PUB. 3-25-2008, FILED 11-5-2007.



NO CLAIM IS MADE TO THE EXCLUSIVE RIGHT TO USE "ROOM DECOR", APART FROM THE MARK AS SHOWN.

THE MARK CONSISTS OF THE WORDS "STICK ART" IN OUTLINE, BENEATH WHICH APPEAR THE WORDS "ROOM DECOR".

FOR ARTS AND CRAFT PAINT KITS; ALBUMS FOR STICKERS; STICKERS; MARKERS; POSTERS; DECALS (U.S. CLS. 2, 5, 22, 23, 29, 37, 38 AND 50).

FIRST USE 6-2-2008; IN COMMERCE 6-2-2008.

3,568,477. THE GLIDDEN COMPANY, STRONGSVILLE, OH. SN 77-364,214. PUB. 4-22-2008, FILED 1-4-2008.

SLOOP

THE MARK CONSISTS OF STANDARD CHARACTERS WITHOUT CLAIM TO ANY PARTICULAR FONT, STYLE, SIZE, OR COLOR.

FOR PAINT BRUSHES (U.S. CLS. 2, 5, 22, 23, 29, 37, 38 AND 50).

FIRST USE 3-31-2008; IN COMMERCE 3-31-2008.

CLASS 16—(Continued).

3,568,491. OMX, INC., NAPERVILLE, IL. SN 77-373,230. PUB. 7-29-2008, FILED 1-16-2008.

KRITTER KREW

THE MARK CONSISTS OF STANDARD CHARACTERS WITHOUT CLAIM TO ANY PARTICULAR FONT, STYLE, SIZE, OR COLOR.

FOR OFFICE SUPPLIES AND SCHOOL SUPPLIES, NAMELY, LUNCH BAGS, PAPERCLIPS, BINDER CLIPS, BOOKMARKS, PENCILS, PENS, MARKERS, PENCIL BOXES, POUCHES FOR WRITING INSTRUMENTS, WRITING TABLETS, NOTEBOOKS, FOLDERS, BINDERS, DESKTOP ORGANIZERS, RULERS, BOOK COVERS, DRAWING COMPASSES, PROTRACTORS FOR OFFICE AND SCHOOL USE, PENCIL SHARPENERS, AND ERASERS (U.S. CLS. 2, 5, 22, 23, 29, 37, 38 AND 50).

FIRST USE 5-1-2008; IN COMMERCE 5-1-2008.

3,568,515. MARRA, MELISSA M., DBA KIDCARDS, CHESTERLAND, OH. SN 77-407,587. PUB. 9-2-2008, FILED 2-27-2008.



KidCards

NO CLAIM IS MADE TO THE EXCLUSIVE RIGHT TO USE "KIDCARDS", APART FROM THE MARK AS SHOWN.

THE MARK CONSISTS OF A CHILD-SIZED HAND AND THE WORD "KIDCARDS".

FOR CARDS BEARING UNIVERSAL GREETINGS; GREETING CARDS; CRAFT PAPER; CHILDREN'S ACTIVITY BOOKS; COLORING BOOKS (U.S. CLS. 2, 5, 22, 23, 29, 37, 38 AND 50).

FIRST USE 4-30-2008; IN COMMERCE 6-20-2008.

CLASS 16—(Continued).

3,568,520. CRI 2000, L.P., SAN DIEGO, CA. SN 77-411,755. PUB. 7-29-2008, FILED 3-3-2008.

SMEAR TEK

THE MARK CONSISTS OF STANDARD CHARACTERS WITHOUT CLAIM TO ANY PARTICULAR FONT, STYLE, SIZE, OR COLOR.

FOR HIGHLIGHTING MARKERS (U.S. CLS. 2, 5, 22, 23, 29, 37, 38 AND 50).
FIRST USE 7-6-2008; IN COMMERCE 7-6-2008.



3,568,532. LIVING CONSCIOUSLY BY DESIGN, INC., FOXBORO, MA. SN 77-424,860. PUB. 7-8-2008, FILED 3-18-2008.

LIVING CBD PUBLISHING

THE MARK CONSISTS OF STANDARD CHARACTERS WITHOUT CLAIM TO ANY PARTICULAR FONT, STYLE, SIZE, OR COLOR.

NO CLAIM IS MADE TO THE EXCLUSIVE RIGHT TO USE "PUBLISHING", APART FROM THE MARK AS SHOWN.

FOR A SERIES OF BOOKS, WRITTEN ARTICLES, HANDOUTS AND WORKSHEETS IN THE FIELD OF MINDFUL LIVING AND PERSONAL AND SPIRITUAL GROWTH; BOOKS IN THE FIELD OF MINDFUL LIVING AND PERSONAL AND SPIRITUAL GROWTH; PUBLICATIONS, NAMELY, WRITTEN MANUSCRIPTS AND BOOKS IN THE FIELDS OF MINDFUL LIVING AND PERSONAL AND SPIRITUAL GROWTH (U.S. CLS. 2, 5, 22, 23, 29, 37, 38 AND 50).
FIRST USE 11-1-2008; IN COMMERCE 11-1-2008.



3,568,538. THE HAIN CELESTIAL GROUP, INC., MELVILLE, NY. SN 77-429,236. PUB. 8-12-2008, FILED 3-24-2008.

EARTH'S BEST

THE MARK CONSISTS OF STANDARD CHARACTERS WITHOUT CLAIM TO ANY PARTICULAR FONT, STYLE, SIZE, OR COLOR.

OWNER OF U.S. REG. NOS. 3,251,387 AND 3,251,388.
FOR DISPOSABLE DIAPERS AND DISPOSABLE WIPES NOT IMPREGNATED WITH CHEMICALS OR COMPOUNDS (U.S. CLS. 2, 5, 22, 23, 29, 37, 38 AND 50).
FIRST USE 8-0-2008; IN COMMERCE 8-0-2008.

CLASS 16—(Continued).

3,568,598. SHURGARD STORAGE CENTERS, LLC, GLENDALE, CA. SN 78-559,109. PUB. 11-8-2005, FILED 2-2-2005.

SHURGARD

OWNER OF U.S. REG. NOS. 1,126,037, 1,542,858, AND OTHERS.

FOR PAPER BOXES; CORRUGATED RECORD STORAGE BOXES; FILE BOXES FOR STORAGE OF BUSINESS AND PERSONAL RECORDS; PAPER TAPE (U.S. CLS. 2, 5, 22, 23, 29, 37, 38 AND 50).
FIRST USE 12-31-2003; IN COMMERCE 12-31-2003.



3,568,615. BROOK, ADAM M., JACKSON, MS. SN 78-687,081. PUB. 5-23-2006, FILED 8-5-2005.

GOLDEN GATE DIET

THE MARK CONSISTS OF STANDARD CHARACTERS WITHOUT CLAIM TO ANY PARTICULAR FONT, STYLE, SIZE, OR COLOR.

NO CLAIM IS MADE TO THE EXCLUSIVE RIGHT TO USE "DIET", APART FROM THE MARK AS SHOWN.

FOR BOOKS FEATURING DESCRIPTIONS OF FOOD AND FOOD PREPARATION AND FOOD COMBINATIONS TO IMPROVE WEIGHT AND TO IMPROVE HEALTH (U.S. CLS. 2, 5, 22, 23, 29, 37, 38 AND 50).
FIRST USE 4-27-2008; IN COMMERCE 4-27-2008.



3,568,640. PIANO PLAY MUSIC SYSTEMS, INC., SHERMAN OAKS, CA. SN 78-809,392. PUB. 3-27-2007, FILED 2-7-2006.

PIANO PLAY

THE MARK CONSISTS OF STANDARD CHARACTERS WITHOUT CLAIM TO ANY PARTICULAR FONT, STYLE, SIZE, OR COLOR.

OWNER OF U.S. REG. NO. 2,244,585.

CLASS 16—(Continued).

NO CLAIM IS MADE TO THE EXCLUSIVE RIGHT TO USE "PIANO", APART FROM THE MARK AS SHOWN.

FOR PRINTED MATERIALS, NAMELY, PRINTED NEWSLETTERS FEATURING INFORMATION ON MUSIC AND MUSIC INSTRUCTION; PRINTED BOOKS AND NEWSLETTERS FEATURING EDUCATIONAL, ENTERTAINMENT AND INFORMATIVE MATERIALS FOR CHILDREN AND PARENTS IN THE FIELD OF MUSIC, MUSIC INSTRUCTION, MUSICAL INSTRUMENTS AND GAMES; PRINTED CHILDREN'S ACTIVITY BOOKS, FLASHCARDS, AND CHILDREN'S STORY BOOKS; PRINTS; PRINTED CERTIFICATES; PRINTED INSTRUCTIONAL AND TEACHING MATERIALS AND INFORMATIONAL FLYERS IN THE FIELDS OF AND RELATED TO MUSIC, MUSIC INSTRUCTION, MUSICAL INSTRUMENTS, ARTS AND CRAFTS, AND CHILDREN'S EDUCATION IN THE FIELDS OF MUSIC, MATH, READING, LISTENING COMPREHENSION, AND MOTOR SKILLS (U.S. CLS. 2, 5, 22, 23, 29, 37, 38 AND 50).

FIRST USE 2-28-1986; IN COMMERCE 4-30-2008.

3,568,665. CARVAJAL S.A., CALI, COLOMBIA. SN 78-921,036. PUB. 9-11-2007, FILED 6-30-2006.

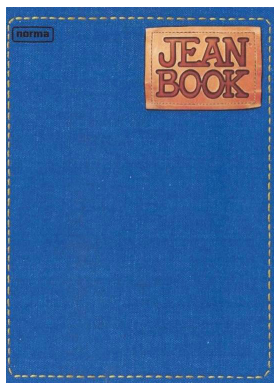

OWNER OF U.S. REG. NOS. 1,440,575 AND 1,574,777.

NO CLAIM IS MADE TO THE EXCLUSIVE RIGHT TO USE "BOOK", APART FROM THE MARK AS SHOWN.

THE COLOR(S) BLUE, BROWN, TAN, BLACK AND YELLOW IS/ARE CLAIMED AS A FEATURE OF THE MARK.

THE MARK CONSISTS OF A BLUE RECTANGLE RESEMBLING DENIM FABRIC WITH YELLOW STITCHING AROUND ITS PERIMETER. A BLACK RECTANGLE WITH THE WORD "NORMA" IN BLACK STYLIZED LETTERING APPEARS IN THE UPPER LEFT HAND CORNER OF THE BLUE RECTANGLE. A SMALLER TAN RECTANGLE RESEMBLING A PATCH APPEARS WITH BROWN STITCHING AROUND THE PERIMETER IN THE UPPER RIGHT CORNER OF THE BLUE RECTANGLE. THE WORDS "JEAN BOOK" ARE DISPLAYED IN THE CENTER OF THE TAN RECTANGLE IN BROWN STYLIZED LETTERING.

FOR NOTE-BOOKS, BINDERS FOR PAPER (U.S. CLS. 2, 5, 22, 23, 29, 37, 38 AND 50).

FIRST USE 6-0-2005; IN COMMERCE 6-0-2005.

CLASS 17—RUBBER GOODS**CLASS 17—(Continued).**

3,568,262. COOLCOP, LLC, PASO ROBLES, CA. SN 77-234,035. PUB. 4-1-2008, FILED 7-19-2007.

COOLSOLDIER

THE MARK CONSISTS OF STANDARD CHARACTERS WITHOUT CLAIM TO ANY PARTICULAR FONT, STYLE, SIZE, OR COLOR.

NO CLAIM IS MADE TO THE EXCLUSIVE RIGHT TO USE "COOL", APART FROM THE MARK AS SHOWN.

FOR BODY ARMOR ACCESSORY CONSISTING OF FLEXIBLE HOSES MADE OF PLASTIC WHICH ATTACH TO A VEHICLE AIR-CONDITIONING VENT AND THE ENTITY WEARING BODY ARMOR (U.S. CLS. 1, 5, 12, 13, 35 AND 50).

FIRST USE 3-14-2008; IN COMMERCE 3-14-2008.

3,568,338. W. ATLEE BURPEE COMPANY, WARMINSTER, PA. SN 77-281,196. PUB. 3-11-2008, FILED 9-17-2007.

AQUA-SHIELD

THE MARK CONSISTS OF STANDARD CHARACTERS WITHOUT CLAIM TO ANY PARTICULAR FONT, STYLE, SIZE, OR COLOR.

FOR PLASTIC TUBES THAT CAN BE FILLED WITH WATER FOR USE AS AN INSULATING BARRIER FOR GROWING PLANTS (U.S. CLS. 1, 5, 12, 13, 35 AND 50).

FIRST USE 12-0-2007; IN COMMERCE 12-0-2007.

3,568,368. ENERGYSEAL AIR BARRIER SYSTEMS, MCCALL, ID. SN 77-291,271. PUB. 3-18-2008, FILED 9-28-2007.

AQUABLOWN SOFTFLEX

THE MARK CONSISTS OF STANDARD CHARACTERS WITHOUT CLAIM TO ANY PARTICULAR FONT, STYLE, SIZE, OR COLOR.

FOR URETHANE SPRAY FOAMS APPLIED AS INSULATION TO HOMES, COMMERCIAL BUILDINGS, AND INDUSTRIAL APPLICATIONS (U.S. CLS. 1, 5, 12, 13, 35 AND 50).

FIRST USE 10-25-2008; IN COMMERCE 10-25-2008.

CLASS 17—(Continued).

3,568,509. MP GLOBAL PRODUCTS, LLC, NORFOLK, NE. SN 77-400,051. PUB. 7-8-2008, FILED 2-19-2008.

QUIET STRIDE

THE MARK CONSISTS OF STANDARD CHARACTERS WITHOUT CLAIM TO ANY PARTICULAR FONT, STYLE, SIZE, OR COLOR.

OWNER OF U.S. REG. NO. 3,426,690. FOR SOUND ABSORBING FLOORING UNDERLAYMENT (U.S. CLS. 1, 5, 12, 13, 35 AND 50). FIRST USE 7-1-2008; IN COMMERCE 7-1-2008.

CLASS 18—(Continued).

3,568,534. BOYT BRANDS, INC., IOWA FALLS, IA. SN 77-427,576. PUB. 7-29-2008, FILED 3-20-2008.

mach⁵

OWNER OF U.S. REG. NOS. 2,757,117 AND 2,972,748. THE MARK CONSISTS OF A STYLIZED REPRESENTATION OF "MACH⁵". FOR LUGGAGE (U.S. CLS. 1, 2, 3, 22 AND 41). FIRST USE 3-1-2008; IN COMMERCE 7-1-2008.

CLASS 18—LEATHER GOODS

3,568,221. AGILIS GROUP INC., SAN DIEGO, CA. SN 77-191,596. PUB. 11-13-2007, FILED 5-29-2007.

woof's life

THE MARK CONSISTS OF STANDARD CHARACTERS WITHOUT CLAIM TO ANY PARTICULAR FONT, STYLE, SIZE, OR COLOR.

FOR COLLARS FOR PETS; DOG APPAREL; PET CLOTHING (U.S. CLS. 1, 2, 3, 22 AND 41). FIRST USE 8-16-2007; IN COMMERCE 9-19-2008.

3,568,543. BRIDEN, PATRICIA G., VIRGINIA BEACH, VA. SN 77-438,410. PUB. 8-26-2008, FILED 4-2-2008.

LUV MY PURSE STRAP

THE MARK CONSISTS OF STANDARD CHARACTERS WITHOUT CLAIM TO ANY PARTICULAR FONT, STYLE, SIZE, OR COLOR.

NO CLAIM IS MADE TO THE EXCLUSIVE RIGHT TO USE "PURSE STRAP", APART FROM THE MARK AS SHOWN. FOR STRAPS FOR HANDBAGS (U.S. CLS. 1, 2, 3, 22 AND 41). FIRST USE 6-1-2008; IN COMMERCE 6-1-2008.

3,568,346. ANGELL BRIDGE INCORPORATED, PAWTUCKET, RI. SN 77-283,207. PUB. 3-25-2008, FILED 9-19-2007.

Bag Sacks 

NO CLAIM IS MADE TO THE EXCLUSIVE RIGHT TO USE "BAG SACKS", APART FROM THE MARK AS SHOWN. FOR ALL-PURPOSE CARRYING BAGS (U.S. CLS. 1, 2, 3, 22 AND 41). FIRST USE 10-1-2007; IN COMMERCE 1-3-2008.

3,568,661. PACIFIC TRAIL CORPORATION, PORTLAND, OR. SN 78-907,144. PUB. 1-30-2007, FILED 6-13-2006.

 **BLACK DOT**

OWNER OF U.S. REG. NOS. 1,860,991 AND 2,526,036. FOR BACKPACKS; ALL-PURPOSE SPORT BAGS; ALL PURPOSE CARRYING BAGS; DUFFEL BAGS; LUGGAGE (U.S. CLS. 1, 2, 3, 22 AND 41). FIRST USE 10-13-2008; IN COMMERCE 10-13-2008.

CLASS 18—(Continued).

3,568,692. PACIFIC TRAIL CORPORATION, PORTLAND, OR. SN 78-959,629. PUB. 2-13-2007, FILED 8-24-2006.

BLACK DOT

THE MARK CONSISTS OF STANDARD CHARACTERS WITHOUT CLAIM TO ANY PARTICULAR FONT, STYLE, SIZE, OR COLOR.

OWNER OF U.S. REG. NOS. 1,860,991 AND 2,526,036.
FOR ALL PURPOSE SPORT BAGS; ALL-PURPOSE ATHLETIC BAGS; ALL-PURPOSE CARRYING BAGS; BACKPACKS; DUFFEL BAGS; LUGGAGE (U.S. CLS. 1, 2, 3, 22 AND 41).
FIRST USE 10-13-2008; IN COMMERCE 10-13-2008.

CLASS 19—NON-METALLIC BUILDING MATERIALS

3,568,079. ASIA FACTORY DIRECT, INC, MIAMI, FL. SN 77-060,691. PUB. 12-18-2007, FILED 12-9-2006.

CRESTWOOD AMERICA

THE MARK CONSISTS OF STANDARD CHARACTERS WITHOUT CLAIM TO ANY PARTICULAR FONT, STYLE, SIZE, OR COLOR.

NO CLAIM IS MADE TO THE EXCLUSIVE RIGHT TO USE "AMERICA", APART FROM THE MARK AS SHOWN.
FOR FLOOR BOARDS; FLOOR PANELS; FLOOR TILES OF WOOD; LAMINATE FLOORING; NON-METAL FLOORS; PARQUET FLOORING AND PARQUET SLABS; PARQUET FLOORING MADE OF WOOD; PARQUET FLOORING OF WOOD; PARQUET WOOD FLOORING; UNDERLAY FOR LAMINATE FLOORING; VENEER FOR FLOORS; WOOD TILE FLOORS; WOODEN FLOORING (U.S. CLS. 1, 12, 33 AND 50).
FIRST USE 5-1-2008; IN COMMERCE 5-1-2008.

3,568,154. INNOVATIVE BUILDING PRODUCTS INC., AJAX, ONTARIO, CANADA. SN 77-132,162. PUB. 4-29-2008, FILED 3-15-2007.

PROPATCH

THE MARK CONSISTS OF STANDARD CHARACTERS WITHOUT CLAIM TO ANY PARTICULAR FONT, STYLE, SIZE, OR COLOR.

PRIORITY CLAIMED UNDER SEC. 44(D) ON CANADA APPLICATION NO. 1338747, FILED 3-9-2007, REG. NO. TMA705732, DATED 1-25-2008, EXPIRES 1-25-2023.
FOR BITUMEN-BASED ASPHALT PATCHING COMPOUNDS (U.S. CLS. 1, 12, 33 AND 50).
FIRST USE 3-0-2000; IN COMMERCE 9-24-2008.

CLASS 19—(Continued).

3,568,633. MASONITE INTERNATIONAL CORPORATION, MISSISSAUGA, CANADA. SN 78-787,243. PUB. 1-9-2007, FILED 1-9-2006.

LINCOLN PARK

THE MARK CONSISTS OF STANDARD CHARACTERS WITHOUT CLAIM TO ANY PARTICULAR FONT, STYLE, SIZE, OR COLOR.

FOR DOOR LITES, SIDE LITES, TRANSOM LITES, ALL IN THE NATURE OF GLASS AND PLASTIC PANELS FOR DOORS AND DOOR AREAS; DECORATIVE GLASS FOR BUILDING USE (U.S. CLS. 1, 12, 33 AND 50).
FIRST USE 12-1-2006; IN COMMERCE 3-27-2008.

3,568,634. MASONITE INTERNATIONAL CORPORATION, MISSISSAUGA, CANADA. SN 78-787,294. PUB. 1-9-2007, FILED 1-9-2006.

MENLO PARK

THE MARK CONSISTS OF STANDARD CHARACTERS WITHOUT CLAIM TO ANY PARTICULAR FONT, STYLE, SIZE, OR COLOR.

FOR DOOR LITES, SIDE LITES, TRANSOM LITES, ALL IN THE NATURE OF GLASS AND PLASTIC PANELS FOR DOORS AND DOOR AREAS; DECORATIVE GLASS FOR BUILDING USE (U.S. CLS. 1, 12, 33 AND 50).
FIRST USE 12-1-2006; IN COMMERCE 3-27-2008.

CLASS 20—FURNITURE AND ARTICLES NOT OTHERWISE CLASSIFIED

3,568,066. TIME INC., NEW YORK, NY. SN 77-042,899. PUB. 9-25-2007, FILED 11-13-2006.

REAL SIMPLE

THE MARK CONSISTS OF STANDARD CHARACTERS WITHOUT CLAIM TO ANY PARTICULAR FONT, STYLE, SIZE, OR COLOR.

CLASS 20—(Continued).

OWNER OF U.S. REG. NOS. 2,470,211, 2,953,267, AND 3,098,845.

FOR CLOSET ACCESSORIES, NAMELY, CLOSET AND STORAGE SYSTEMS AND ORGANIZATIONAL UNITS COMPRISED OF COMBINATIONS OF SHELVES, CABINETS, DRAWERS, TIE RACKS, BELT RACKS, WIRE BASKETS OR RODS, SOLD AS A UNIT; HOME OFFICE SYSTEMS COMPRISED OF COMBINATIONS OF SHELVES, CABINETS OR TABLES SOLD INDIVIDUALLY AND AS A UNIT; AND GARAGE, LAUNDRY AND PANTRY SYSTEMS AND ORGANIZATIONAL UNITS COMPRISED OF COMBINATIONS OF CABINETS, SHELVES, DRAWERS OR RACKS SOLD INDIVIDUALLY AND AS A UNIT (U.S. CLS. 2, 13, 22, 25, 32 AND 50).

FIRST USE 6-30-2007; IN COMMERCE 6-30-2007.

CLASS 20—(Continued).

3,568,244. CBT SUPPLY, INC., HIBERNIA, NJ. SN 77-219,414. PUB. 11-20-2007, FILED 6-29-2007.

HEMISPHERES

THE MARK CONSISTS OF STANDARD CHARACTERS WITHOUT CLAIM TO ANY PARTICULAR FONT, STYLE, SIZE, OR COLOR.

FOR OFFICE FURNITURE (U.S. CLS. 2, 13, 22, 25, 32 AND 50).

FIRST USE 7-16-2008; IN COMMERCE 7-16-2008.

3,568,156. QUINN, JANET F, LYONS, CO. SN 77-132,445. PUB. 9-18-2007, FILED 3-15-2007.

**Wisdom Stones -
Touchstones to What
Matters Most**

THE MARK CONSISTS OF STANDARD CHARACTERS WITHOUT CLAIM TO ANY PARTICULAR FONT, STYLE, SIZE, OR COLOR.

FOR POLYRESIN TABLETS WHICH LOOK LIKE STONE, AND HAVE QUOTATIONS, SAYINGS, AND BIBLE VERSES ENGRAVED ON THEM, PACKAGED WITH DISPLAY STAND (U.S. CLS. 2, 13, 22, 25, 32 AND 50).

FIRST USE 7-31-2006; IN COMMERCE 3-16-2007.

3,568,438. ARC LUXE LLC, CHARLOTTE, NC. SN 77-329,257. PUB. 4-15-2008, FILED 11-14-2007.



THE MARK CONSISTS OF A GRAPHIC REPRESENTATION OF A FLOWER NEXT TO THE WORD "KUSH" WITH THE WORDS "SUPPORTS LIKE A DREAM" STYLIZED IN ITALICS UNDERNEATH.

FOR BREAST SEPARATOR NOT FOR THERAPEUTIC USE, NAMELY, AN ANTI-SLIP SEPARATING CUSHION USED IN BETWEEN THE BREASTS OF A HUMAN BEING FOR USE DURING SLEEP (U.S. CLS. 2, 13, 22, 25, 32 AND 50).

FIRST USE 11-14-2007; IN COMMERCE 11-14-2007.

3,568,205. WERNER MEDIA PARTNERS, LLC, DBA NATURE'S SLEEP, LLC, DAVIE, FL. SN 77-177,441. PUB. 4-15-2008, FILED 5-10-2007.

ECOTEX

THE MARK CONSISTS OF STANDARD CHARACTERS WITHOUT CLAIM TO ANY PARTICULAR FONT, STYLE, SIZE, OR COLOR.

FOR BEDDING, NAMELY, PILLOWS (U.S. CLS. 2, 13, 22, 25, 32 AND 50).

FIRST USE 8-31-2007; IN COMMERCE 8-31-2007.

3,568,442. BACK QUALITY USA, BZ DEN HAAG, NETHERLANDS. SN 77-334,041. PUB. 4-29-2008, FILED 11-20-2007.

COMFORTMOVE

THE MARK CONSISTS OF STANDARD CHARACTERS WITHOUT CLAIM TO ANY PARTICULAR FONT, STYLE, SIZE, OR COLOR.

FOR CHAIRS (U.S. CLS. 2, 13, 22, 25, 32 AND 50).

FIRST USE 11-28-2008; IN COMMERCE 11-28-2008.

CLASS 20—(Continued).

3,568,443. BACK QUALITY USA, BZ DEN HAAG, NETHERLANDS. SN 77-334,044. PUB. 4-29-2008, FILED 11-20-2007.

CORRECTSIT

THE MARK CONSISTS OF STANDARD CHARACTERS WITHOUT CLAIM TO ANY PARTICULAR FONT, STYLE, SIZE, OR COLOR.

FOR CHAIRS (U.S. CLS. 2, 13, 22, 25, 32 AND 50).
FIRST USE 11-28-2008; IN COMMERCE 11-28-2008.

3,568,444. BACK QUALITY USA, BZ DEN HAAG, NETHERLANDS. SN 77-334,046. PUB. 4-29-2008, FILED 11-20-2007.

ERGOSOLEX

THE MARK CONSISTS OF STANDARD CHARACTERS WITHOUT CLAIM TO ANY PARTICULAR FONT, STYLE, SIZE, OR COLOR.

FOR CHAIRS (U.S. CLS. 2, 13, 22, 25, 32 AND 50).
FIRST USE 11-28-2008; IN COMMERCE 11-28-2008.

3,568,545. CENRO USA, LLC, HUNTSVILLE, AL. SN 77-441,849. PUB. 8-26-2008, FILED 4-7-2008.

Cenro

THE MARK CONSISTS OF STANDARD CHARACTERS WITHOUT CLAIM TO ANY PARTICULAR FONT, STYLE, SIZE, OR COLOR.

FOR FURNITURE FRAMES AND FURNITURE PARTS (U.S. CLS. 2, 13, 22, 25, 32 AND 50).
FIRST USE 8-11-2008; IN COMMERCE 8-11-2008.

CLASS 20—(Continued).

3,568,579. THE NORTH FACE APPAREL CORP., WILMINGTON, DE. SN 78-411,466. PUB. 2-8-2005, FILED 4-30-2004.



FOR SLEEPING BAGS (U.S. CLS. 2, 13, 22, 25, 32 AND 50).

FIRST USE 1-0-2005; IN COMMERCE 1-0-2005.

3,568,639. CUBE SOLUTIONS, L.L.C., DALLAS, TX. SN 78-806,714. PUB. 2-6-2007, FILED 2-3-2006.

CUBE SOLUTIONS

THE MARK CONSISTS OF STANDARD CHARACTERS WITHOUT CLAIM TO ANY PARTICULAR FONT, STYLE, SIZE, OR COLOR.

OWNER OF U.S. REG. NOS. 3,236,513 AND 3,246,739.
FOR OFFICE FURNITURE; WORKSTATIONS HAVING MULTI-USE WORK SURFACES FOR USE IN A WIDE VARIETY OF FIELDS; OFFICE DESKS; OFFICE TABLES; OFFICE CHAIRS; WORK SURFACES; COMPUTER FURNITURE (U.S. CLS. 2, 13, 22, 25, 32 AND 50).
FIRST USE 9-18-2008; IN COMMERCE 9-18-2008.

3,568,657. DARREL R. CALHOUN, ASHVILLE, AL. SN 78-879,474. PUB. 8-28-2007, FILED 5-9-2006.

DOMEGARD

THE MARK CONSISTS OF STANDARD CHARACTERS WITHOUT CLAIM TO ANY PARTICULAR FONT, STYLE, SIZE, OR COLOR.

FOR PLASTIC PROTECTIVE COVERS FOR GAS AND LIQUID STORAGE TANK DOME SHELLS (U.S. CLS. 2, 13, 22, 25, 32 AND 50).
FIRST USE 2-15-2008; IN COMMERCE 2-15-2008.

CLASS 20—(Continued).

3,568,667. PETROCOFSKI, ANTHONY, TROY, NY. SN 78-921,616. PUB. 9-4-2007, FILED 7-1-2006.

Clip N Drip

THE MARK CONSISTS OF STYLIZED WORD "CLIP" FOLLOWED BY A STYLIZED "N" FOLLOWED BY A STYLIZED APOSTROPHE FOLLOWED BY STYLIZED "DRIP".

FOR PLASTIC CLIPS FOR ATTACHING CLOTHING AND TOWELS TO SHOWER RODS, CLOTHESLINES, GARMENT RACKS AND THE LIKE FOR DRYING PURPOSES (U.S. CLS. 2, 13, 22, 25, 32 AND 50).

FIRST USE 9-1-2008; IN COMMERCE 9-1-2008.

CLASS 21—(Continued).

3,568,081. HI-TECH INDUSTRIES, INC., SOUTHFIELD, MI. SN 77-066,736. PUB. 8-14-2007, FILED 12-18-2006.



NO CLAIM IS MADE TO THE EXCLUSIVE RIGHT TO USE "ORIGINAL, AUTHENTIC AND OFFICIAL", APART FROM THE MARK AS SHOWN.

FOR WIPING CLOTHS, NAMELY, CHAMOIS MADE FROM SYNTHETIC MATERIALS FOR USE ON AUTOMOBILES, BOATS AND AIRCRAFTS (U.S. CLS. 2, 13, 23, 29, 30, 33, 40 AND 50).

FIRST USE 12-0-2007; IN COMMERCE 12-0-2007.

3,568,669. VEGAS.COM, LLC, LAS VEGAS, NV. SN 78-921,937. PUB. 9-4-2007, FILED 7-3-2006.



OWNER OF U.S. REG. NOS. 3,129,209, 3,150,317, AND OTHERS.

SEC. 2(F) VEGAS. FOR PICTURE FRAMES, PLASTIC SCULPTURES, PLASTIC SCULPTURES THAT LIGHT UP (U.S. CLS. 2, 13, 22, 25, 32 AND 50).

FIRST USE 2-3-2006; IN COMMERCE 2-3-2006.

3,568,140. EVRIHOLDER PRODUCTS LLC., ANAHEIM, CA. SN 77-123,990. PUB. 3-18-2008, FILED 3-6-2007.

SLIPPER GENIE

THE MARK CONSISTS OF STANDARD CHARACTERS WITHOUT CLAIM TO ANY PARTICULAR FONT, STYLE, SIZE, OR COLOR.

NO CLAIM IS MADE TO THE EXCLUSIVE RIGHT TO USE "SLIPPER", APART FROM THE MARK AS SHOWN.

FOR SLIPPERS WITH MICROFIBER SOLES FOR CLEANING PURPOSES (U.S. CLS. 2, 13, 23, 29, 30, 33, 40 AND 50).

FIRST USE 5-18-2007; IN COMMERCE 5-18-2007.

CLASS 21—HOUSEWARES AND GLASS

CLASS 21—(Continued).

3,568,201. NEVAREZ, MICHAEL, BATTLE CREEK, MI. SN 77-174,237. PUB. 9-25-2007, FILED 5-7-2007.



THE MARK CONSISTS OF AN ABSTRACT DESIGN OF A CAVEMAN WITH THOUGHT BUBBLES, AND THE WORDING "NEANDER THOUGHTS".
FOR MUGS (U.S. CLS. 2, 13, 23, 29, 30, 33, 40 AND 50).
FIRST USE 7-9-2007; IN COMMERCE 5-9-2008.

3,568,224. INDUSTRIAS PUNTI BLOND TENAX, S.A., BARCELONA, SPAIN. SN 77-193,161. PUB. 2-19-2008, FILED 5-30-2007.



NO CLAIM IS MADE TO THE EXCLUSIVE RIGHT TO USE "LIMPIA", APART FROM THE MARK AS SHOWN.
THE FOREIGN WORDING IN THE MARK TRANSLATES INTO ENGLISH AS "CLEAN EASY".
FOR CLEANING CLOTH (U.S. CLS. 2, 13, 23, 29, 30, 33, 40 AND 50).
FIRST USE 7-0-2008; IN COMMERCE 7-0-2008.

CLASS 21—(Continued).

3,568,311. STEMPNOWSKI, RICHARD H, FORT MYERS, FL. SN 77-268,964. PUB. 3-11-2008, FILED 8-31-2007.



THE COLOR(S) GREEN, YELLOW, BLUE, WHITE, AND ORANGE IS/ARE CLAIMED AS A FEATURE OF THE MARK.

THE MARK CONSISTS OF A GREEN COLORED SEEDLING ON THE LEFT SIDE. IT IS COMPOSED OF A STEM AND TWO LEAVES, BOTH OF WHICH HAVE A YELLOW VEIN RUNNING THROUGH THE CENTER. BELOW THE SEEDLING IS A BLUE RECTANGULAR BAR. IT CONTAINS WHITE LINES IN THE TOP LEFT CORNER TO DEPICT THE ROOTS OF THE YOUNG PLANT. TO THE RIGHT OF THE SEEDLING AND ABOVE THE BLUE BAR IS THE WORD HYDROSPRIT WRITTEN IN ORANGE.

FOR PLANT GROWING SYSTEMS, CONSISTING OF POTS, PLASTIC NUTRIENT RESERVOIRS, COVERS, GROW MEDIA, WATER PUMPS, AIR PUMPS, AIR DIFFUSERS, AND IRRIGATION ACCESSORIES, NAMELY TUBING, DRIP EMITTERS, GROMMETS, AND BARBED CONNECTOR FITTINGS, SOLD AS A UNIT FOR HYDROPONICS GARDENING (U.S. CLS. 2, 13, 23, 29, 30, 33, 40 AND 50).
FIRST USE 10-10-2008; IN COMMERCE 10-10-2008.

3,568,353. UP COUNTRY INC., EAST PROVIDENCE, RI. SN 77-286,038. PUB. 3-18-2008, FILED 9-21-2007.

UP COUNTRY

THE MARK CONSISTS OF STANDARD CHARACTERS WITHOUT CLAIM TO ANY PARTICULAR FONT, STYLE, SIZE, OR COLOR.

OWNER OF U.S. REG. NO. 1,303,720.
FOR PET FOOD BOWLS, CUPS AND CANISTERS (U.S. CLS. 2, 13, 23, 29, 30, 33, 40 AND 50).
FIRST USE 1-31-2003; IN COMMERCE 1-31-2003.

CLASS 21—(Continued).

3,568,461. LEISURE SALES, INCORPORATED, DALLAS, TX. SN 77-344,649. PUB. 5-6-2008, FILED 12-5-2007.

THE MASTER BREADER

THE MARK CONSISTS OF STANDARD CHARACTERS WITHOUT CLAIM TO ANY PARTICULAR FONT, STYLE, SIZE, OR COLOR.

NO CLAIM IS MADE TO THE EXCLUSIVE RIGHT TO USE "BREADER", APART FROM THE MARK AS SHOWN.

FOR COOKING UTENSIL, NAMELY, BATTER DISPENSER DESIGNED TO SPREAD BATTER OVER RAW MEATS AND VEGETABLES (U.S. CLS. 2, 13, 23, 29, 30, 33, 40 AND 50).

FIRST USE 11-3-2008; IN COMMERCE 11-3-2008.

3,568,499. MEYER MANUFACTURING COMPANY LIMITED, KOWLOON, HONGKONG, CHINA. SN 77-388,208. PUB. 6-17-2008, FILED 2-4-2008.

COOK GREAT, LOOK GREAT

THE MARK CONSISTS OF STANDARD CHARACTERS WITHOUT CLAIM TO ANY PARTICULAR FONT, STYLE, SIZE, OR COLOR.

FOR COOKWARE, NAMELY, POTS AND PANS; BAKEWARE (U.S. CLS. 2, 13, 23, 29, 30, 33, 40 AND 50).

FIRST USE 1-1-2008; IN COMMERCE 1-1-2008.

3,568,533. SHETLER STAINLESS STEEL HOUSEWARES, GENEVA, IN. SN 77-426,420. PUB. 7-29-2008, FILED 3-19-2008.

Lindy's

THE MARK CONSISTS OF STANDARD CHARACTERS WITHOUT CLAIM TO ANY PARTICULAR FONT, STYLE, SIZE, OR COLOR.

FOR HOUSEHOLD UTENSILS, NAMELY, GRATERS; HOUSEHOLD UTENSILS, NAMELY, SIEVES; HOUSEHOLD UTENSILS, NAMELY, SKIMMERS; HOUSEHOLD UTENSILS, NAMELY, SPATULAS; HOUSEHOLD UTENSILS, NAMELY, STRAINERS; HOUSEHOLD UTENSILS, NAMELY, TURNERS; BUTTER PANS; CAKE PANS; COOKING PANS; COOKING POTS AND PANS; COOKWARE, NAMELY, POTS AND PANS; COOKWARE, NAMELY, ROASTING PANS; BASINS; BOWLS; NON-ELECTRIC COFFEE MAKERS (U.S. CLS. 2, 13, 23, 29, 30, 33, 40 AND 50).

FIRST USE 3-1-2008; IN COMMERCE 3-1-2008.

CLASS 23—YARNS AND THREADS

3,568,578. CHIN, LILY, NEW YORK, NY. SN 78-406,008. PUB. 7-22-2008, FILED 4-21-2004.

LILY CHIN

THE MARK CONSISTS OF STANDARD CHARACTERS WITHOUT CLAIM TO ANY PARTICULAR FONT, STYLE, SIZE, OR COLOR.

THE NAME(S), PORTRAIT(S), AND/OR SIGNATURE(S) SHOWN IN THE MARK IDENTIFIES MYSELF, WHOSE CONSENT(S) TO REGISTER IS SUBMITTED.

FOR KNITTING YARN AND CROCHETING YARN (U.S. CL. 43).

FIRST USE 1-1-2006; IN COMMERCE 1-1-2006.

CLASS 24—FABRICS

3,568,256. TEXSTYLE, LLC, CINCINNATI, OH. SN 77-228,139. PUB. 3-18-2008, FILED 7-12-2007.

REGAL ELEGANCE

THE MARK CONSISTS OF STANDARD CHARACTERS WITHOUT CLAIM TO ANY PARTICULAR FONT, STYLE, SIZE, OR COLOR.

FOR TEXTILE FABRICS USED IN COMBINATION WITH FURNITURE COVERS (U.S. CLS. 42 AND 50).

FIRST USE 10-31-2007; IN COMMERCE 10-31-2007.

CLASS 25—CLOTHING

CLASS 25—(Continued).

3,567,998. A & H SPORTSWEAR CO., INC., STOCKERTOWN, PA. SN 76-595,138. PUB. 9-13-2005, FILED 5-28-2004.

RAPTURE

THE MARK CONSISTS OF STANDARD CHARACTERS WITHOUT CLAIM TO ANY PARTICULAR FONT, STYLE, SIZE, OR COLOR.

FOR WOMEN'S, GIRLS', MEN'S AND BOYS' SWIMWEAR AND COVER-UPS; LINGERIE, SHAPEWEAR, NAMELY, GIRDLES, THIGH SHAPERS, BODY SUITS, CONTROL BRIEFS, CONTROL SLIPS; BRAS AND PANTS (U.S. CLS. 22 AND 39).

FIRST USE 11-19-2008; IN COMMERCE 11-19-2008.

3,568,003. SCOTT, MARILYN, MANHATTAN BEACH, CA. SN 76-640,365. PUB. 3-21-2006, FILED 6-6-2005.

STARTINGGREEN

THE MARK CONSISTS OF STANDARD CHARACTERS WITHOUT CLAIM TO ANY PARTICULAR FONT, STYLE, SIZE, OR COLOR.

FOR GARMENTS FOR INFANTS, NAMELY, T-SHIRTS, PULLOVERS, SHIRTS, LEGGINGS, CAPS, ONE PIECE SLEEPWEAR, SHORTS, PANTS, PAJAMAS, SHOES, SOCKS, AND SWEATERS; OUTWEAR FOR INFANTS, NAMELY, JACKETS AND HOODIES (U.S. CLS. 22 AND 39).

FIRST USE 5-27-2007; IN COMMERCE 5-27-2007.

3,568,005. JPG PRODUCTS, LLC, ARLINGTON HEIGHTS, IL. SN 76-648,728. PUB. 5-15-2007, FILED 10-18-2005.

ROADSIDE REPAIRWARE

THE MARK CONSISTS OF STANDARD CHARACTERS WITHOUT CLAIM TO ANY PARTICULAR FONT, STYLE, SIZE, OR COLOR.

NO CLAIM IS MADE TO THE EXCLUSIVE RIGHT TO USE "ROADSIDE", APART FROM THE MARK AS SHOWN.

FOR AUTOMOTIVE EMERGENCY KITS COMPRISED OF DISPOSABLE COVERALLS, GLOVES, TOWELETTES, SHOP CLOTHS, KNEELING PADS, EMERGENCY WARNING LIGHTS, FLASHLIGHTS AND FUEL CONTAINERS (U.S. CLS. 22 AND 39).

FIRST USE 8-18-2008; IN COMMERCE 8-28-2008.

CLASS 25—(Continued).

3,568,026. LA MODE ORIGINALS, INC., ABERDEEN, NJ. SN 76-681,124. PUB. 2-19-2008, FILED 8-24-2007.

DRESS YOUR FEET

THE MARK CONSISTS OF STANDARD CHARACTERS WITHOUT CLAIM TO ANY PARTICULAR FONT, STYLE, SIZE, OR COLOR.

FOR FOOTWEAR, NAMELY, SHOES, SNEAKERS, SLIPPERS, SANDALS, RUNNING SHOES AND FLIP FLOPS (U.S. CLS. 22 AND 39).

FIRST USE 4-0-2008; IN COMMERCE 4-0-2008.

3,568,042. ST. LOUIS RAMS PARTNERSHIP, ST. LOUIS, MO. SN 77-009,616. PUB. 4-10-2007, FILED 9-28-2006.



OWNER OF U.S. REG. NOS. 971,046, 2,565,679, AND OTHERS.

THE MARK CONSISTS OF A STYLIZED DESIGN OF A RAM'S HEAD.

FOR MEN'S, WOMEN'S AND CHILDREN'S CLOTHING, NAMELY, T-SHIRTS, SWEATSHIRTS AND CAPS (U.S. CLS. 22 AND 39).

FIRST USE 9-0-2005; IN COMMERCE 9-0-2005.

3,568,054. CUSOLITO, RICHARD, WESTLAKE VILLAGE, CA. SN 77-022,104. PUB. 7-10-2007, FILED 10-16-2006.

Roadwork Athletic

THE MARK CONSISTS OF STANDARD CHARACTERS WITHOUT CLAIM TO ANY PARTICULAR FONT, STYLE, SIZE, OR COLOR.

NO CLAIM IS MADE TO THE EXCLUSIVE RIGHT TO USE "ATHLETIC", APART FROM THE MARK AS SHOWN.

FOR CLOTHING AND ATHLETIC APPAREL, NAMELY, SWEATSHIRTS, SWEATPANTS, T-SHIRTS, WORKOUT SHIRTS, HATS, WORKOUT SHORTS (U.S. CLS. 22 AND 39).

FIRST USE 11-14-2008; IN COMMERCE 11-14-2008.

CLASS 25—(Continued).

3,568,055. CHARLES RIVER APPAREL, INC., MEDFORD, MA. SN 77-023,145. PUB. 1-15-2008, FILED 10-17-2006.

CHARLES RIVER SPORT

THE MARK CONSISTS OF STANDARD CHARACTERS WITHOUT CLAIM TO ANY PARTICULAR FONT, STYLE, SIZE, OR COLOR.

OWNER OF U.S. REG. NOS. 1,305,145, 1,340,938, AND 1,915,049.

NO CLAIM IS MADE TO THE EXCLUSIVE RIGHT TO USE "SPORT", APART FROM THE MARK AS SHOWN.

FOR ANORAKS, ATHLETIC UNIFORMS, JACKETS, RAINCOATS, RAIN SHIRTS, PARKAS, PONCHOS, PULLOVERS, SLICKERS, SWEATSHIRTS, TOPS, AND WARM-UP SUITS, FOR MEN WOMEN AND CHILDREN (U.S. CLS. 22 AND 39).

FIRST USE 4-23-2007; IN COMMERCE 4-23-2007.

3,568,056. CHARLES RIVER APPAREL, INC., MEDFORD, MA. SN 77-023,165. PUB. 1-15-2008, FILED 10-17-2006.



OWNER OF U.S. REG. NOS. 1,305,145, 1,340,938, AND 1,915,049.

NO CLAIM IS MADE TO THE EXCLUSIVE RIGHT TO USE "SPORT", APART FROM THE MARK AS SHOWN.

THE COLOR(S) ROYAL BLUE IS A FEATURE OF THE MARK IS/ARE CLAIMED AS A FEATURE OF THE MARK.

THE MARK CONSISTS OF A ROWER PROFILE ABOVE THE WORDS "CHARLES RIVER SPORT", ALL IN ROYAL BLUE.

FOR ANORAKS, ATHLETIC UNIFORMS, JACKETS, RAINCOATS, RAIN SHIRTS, PARKAS, PONCHOS, PULLOVERS, SLICKERS, SWEATSHIRTS, TOPS, AND WARM-UP SUITS, FOR MEN WOMEN AND CHILDREN (U.S. CLS. 22 AND 39).

FIRST USE 4-23-2007; IN COMMERCE 4-23-2007.

CLASS 25—(Continued).

3,568,057. CHARLES RIVER APPAREL, INC., MEDFORD, MA. SN 77-023,184. PUB. 3-18-2008, FILED 10-17-2006.



OWNER OF U.S. REG. NOS. 1,305,145, 1,340,938, AND 1,915,049.

NO CLAIM IS MADE TO THE EXCLUSIVE RIGHT TO USE "SPORT", APART FROM THE MARK AS SHOWN.

THE COLOR(S) ROYAL BLUE AND WHITE IS/ARE CLAIMED AS A FEATURE OF THE MARK.

THE MARK CONSISTS OF A PROFILE OF A ROWER IN ROYAL BLUE WITH A WHITE BACKGROUND, A RECTANGLE DESIGN IN ROYAL BLUE AND THE WORDING "CHARLES RIVER" AND "SPORT" IN WHITE.

FOR ANORAKS, ATHLETIC UNIFORMS, JACKETS, RAINCOATS, RAIN SHIRTS, PARKAS, PONCHOS, PULLOVERS, SLICKERS, SWEATSHIRTS, TOPS, AND WARM-UP SUITS, FOR MEN WOMEN AND CHILDREN (U.S. CLS. 22 AND 39).

FIRST USE 4-23-2007; IN COMMERCE 4-23-2007.

3,568,063. NASARE ENTERPRISES, LLC., NEW YORK, NY. SN 77-036,401. PUB. 12-18-2007, FILED 11-3-2006.



NO CLAIM IS MADE TO THE EXCLUSIVE RIGHT TO USE "ATHLETICS", APART FROM THE MARK AS SHOWN.

THE MARK CONSISTS OF A STYLIZED "N" APPEARING AS A SEMI-CIRCULAR PATTERN; CENTERED UNDERNEATH THE STYLIZED "N" APPEARS THE WORD "NASARE" IN STYLIZED LETTERING; UNDERNEATH THE WORD "NASARE" APPEARS THE WORD "ATHLETICS".

FOR ATHLETIC FOOTWEAR; ATHLETIC SHOES; ATHLETIC UNIFORMS; FOOTWEAR FOR TRACK AND FIELD ATHLETICS (U.S. CLS. 22 AND 39).

FIRST USE 8-17-2005; IN COMMERCE 8-17-2005.

CLASS 25—(Continued).

3,568,067. JADE-A-KINS, LTD., LAS VEGAS, NV. SN 77-043,051. PUB. 3-11-2008, FILED 11-13-2006.

TINY TUCKER

THE MARK CONSISTS OF STANDARD CHARACTERS WITHOUT CLAIM TO ANY PARTICULAR FONT, STYLE, SIZE, OR COLOR.

FOR SWADDLING CLOTHES (U.S. CLS. 22 AND 39).
FIRST USE 7-6-2006; IN COMMERCE 10-1-2006.

3,568,102. DANCE PAWS, LLC, CAMBRIDGE, MA. SN 77-087,104. PUB. 2-19-2008, FILED 1-19-2007.

FOOT PAWS

THE MARK CONSISTS OF STANDARD CHARACTERS WITHOUT CLAIM TO ANY PARTICULAR FONT, STYLE, SIZE, OR COLOR.

NO CLAIM IS MADE TO THE EXCLUSIVE RIGHT TO USE "FOOT", APART FROM THE MARK AS SHOWN.

FOR FOOTWEAR DESIGNED TO PROTECT THE UNSHOD FOOT, INCLUDING FOOTWEAR SUITABLE FOR USE IN DANCE, GYMNASTICS, ATHLETICS, MARTIAL ARTS, WATER SPORTS, AND TRADITIONALLY BAREFOOTED ACTIVITIES (U.S. CLS. 22 AND 39).

FIRST USE 3-26-2007; IN COMMERCE 3-26-2007.

3,568,107. CHEVRON INTELLECTUAL PROPERTY LLC, SAN RAMON, CA. SN 77-095,968. PUB. 8-28-2007, FILED 1-31-2007.

**MAKING THE THINGS THAT GO,
GO BETTER**

THE MARK CONSISTS OF STANDARD CHARACTERS WITHOUT CLAIM TO ANY PARTICULAR FONT, STYLE, SIZE, OR COLOR.

FOR CLOTHING, NAMELY, SHIRTS (U.S. CLS. 22 AND 39).

FIRST USE 7-1-2008; IN COMMERCE 7-1-2008.

CLASS 25—(Continued).

3,568,127. GURU DENIM INC., VERNON, CA. SN 77-113,843. PUB. 9-25-2007, FILED 2-22-2007.

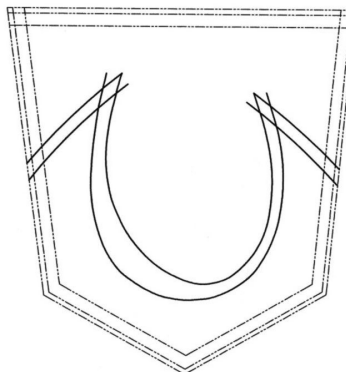

OWNER OF U.S. REG. NO. 3,147,244.
THE MARK CONSISTS OF A POCKET STITCHING DESIGN ON A GARMENT WHICH IS A STYLIZED REPRESENTATION OF THE LETTER "U." THE BROKEN LINES ARE USED TO INDICATE THE POSITIONING OF THE MARK ON THE GOODS AND ARE NOT A FEATURE OF THE MARK.

FOR APPAREL, NAMELY, JEANS, PANTS, SKIRTS, JACKETS (U.S. CLS. 22 AND 39).
FIRST USE 7-1-2007; IN COMMERCE 7-1-2007.

3,568,148. MERRELL, JOSH, IRVINE, CA. SN 77-129,017. PUB. 9-11-2007, FILED 3-12-2007.

FAREWELL FOREVER

THE MARK CONSISTS OF STANDARD CHARACTERS WITHOUT CLAIM TO ANY PARTICULAR FONT, STYLE, SIZE, OR COLOR.

FOR CLOTHING, NAMELY, MEN'S, WOMEN'S AND CHILDREN'S CASUAL AND DRESS CLOTHING, NAMELY, SHIRTS, PANTS, SHORTS, JACKETS, TOPS, HOODED SWEATSHIRTS, LONG SLEEVED SHIRTS, AND HEADWEAR (U.S. CLS. 22 AND 39).

FIRST USE 1-15-2008; IN COMMERCE 1-15-2008.

CLASS 25—(Continued).

3,568,168. CHEN, SHERI L., SOMERSET, NJ. SN 77-144,284. PUB. 10-9-2007, FILED 3-29-2007.



THE MARK CONSISTS OF THE WORD "CLIMATE", WITH THE LETTER "X" CENTERED IN THE BACKGROUND.

FOR ANGLERS' SHOES; APRES-SKI SHOES; ATHLETIC SHOES; BALLET SHOES; BASEBALL SHOES; BEACH SHOES; BELTS; BOWLING SHOES; BOXING SHOES; CANVAS SHOES; CAPS; CLOTHING FOR WEAR IN JUDO PRACTICES; CLOTHING FOR WEAR IN WRESTLING GAMES; CLOTHING, NAMELY, ARM WARMERS; CLOTHING, NAMELY, FOLK COSTUMES; CLOTHING, NAMELY, KNEE WARMERS; CLOTHING, NAMELY, NECK TUBES; CLOTHING, NAMELY, WRAP-AROUNDS; CYCLING SHOES; DECK-SHOES; DRIVERS; DUSTERS; FOOTBALL SHOES; FOULARDS; GOLF SHOES; GYMNASTIC SHOES; HANDBALL SHOES; HOCKEY SHOES; HOODS; INFANTS' SHOES AND BOOTS; INSOLES; JERSEYS; LEATHER BELTS; LEATHER SHOES; MANTLES; MUFFLERS; PARTS OF CLOTHING, NAMELY, GUSSETS FOR TIGHTS, GUSSETS FOR STOCKINGS, GUSSETS FOR BATHING SUITS, GUSSETS FOR UNDERWEAR, GUSSETS FOR LEOTARDS AND GUSSETS FOR FOOTLETS; PER-SPARATION ABSORBENT UNDERWEAR CLOTHING; PROTECTIVE METAL MEMBERS FOR SHOES AND BOOTS; RUBBER SHOES; RUGBY SHOES; RUNNING SHOES; SHIFTS; SHOE DOWELS; SHOE INSERTS FOR PRIMARILY NON-ORTHOPEDIC PURPOSES; SHOE PEGS; SHOE SOLES; SHOES; SHOES SOLES FOR REPAIR; SHORT SETS; SHOULDER WRAPS; SKI AND SNOWBOARD SHOES AND PARTS THEREOF; SKIING SHOES; SOCCER SHOES; SWADDLING CLOTHES; TAP SHOES; TENNIS SHOES; TIES; TONGUE OR PULL-STRAP FOR SHOES AND BOOTS; TOPS; TRACK AND FIELD SHOES; TRAINING SHOES; VOLLEYBALL SHOES; WOMEN'S SHOES; WORK SHOES AND BOOTS; WRAPS (U.S. CLS. 22 AND 39).

FIRST USE 4-3-2007; IN COMMERCE 4-3-2007.

3,568,174. MANDALAY REAL ESTATE LIMITED, 2001 NEUCHATEL, SWITZERLAND. SN 77-148,854. PUB. 4-15-2008, FILED 4-4-2007.

MIH

THE MARK CONSISTS OF STANDARD CHARACTERS WITHOUT CLAIM TO ANY PARTICULAR FONT, STYLE, SIZE, OR COLOR.

FOR JEANS, T-SHIRTS, SHIRTS, DRESSES, SHORTS AND TROUSERS, SWIMWEAR, KNITWEAR IN THE NATURE OF JUMPERS, CARDIGANS, DRESSES, SCARVES, HATS AND GLOVES AND ACCESSORIES, NAMELY, BELTS AND HATS (U.S. CLS. 22 AND 39).

FIRST USE 9-1-2006; IN COMMERCE 9-1-2006.

CLASS 25—(Continued).

3,568,200. CARDIFF ADVISORS, INC., DEL MAR, CA. SN 77-173,707. PUB. 10-23-2007, FILED 5-5-2007.

HAVIKA BIKINI

THE MARK CONSISTS OF STANDARD CHARACTERS WITHOUT CLAIM TO ANY PARTICULAR FONT, STYLE, SIZE, OR COLOR.

NO CLAIM IS MADE TO THE EXCLUSIVE RIGHT TO USE "BIKINI", APART FROM THE MARK AS SHOWN. FOR CLOTHING, NAMELY, SWIMWEAR (U.S. CLS. 22 AND 39).

FIRST USE 8-1-2007; IN COMMERCE 12-15-2007.

3,568,206. JOE BENBASSET, INC., NEW YORK, NY. SN 77-177,855. PUB. 3-18-2008, FILED 5-10-2007.

STUDIO 253

THE MARK CONSISTS OF STANDARD CHARACTERS WITHOUT CLAIM TO ANY PARTICULAR FONT, STYLE, SIZE, OR COLOR.

FOR CLOTHING, NAMELY, PANTS, SKIRTS, SHORTS, SHIRTS, JACKETS (U.S. CLS. 22 AND 39).

FIRST USE 11-0-2007; IN COMMERCE 11-0-2007.

3,568,217. AIRTIME GEAR, LLC, BEAVERTON, OR. SN 77-189,195. PUB. 3-18-2008, FILED 5-24-2007.

AIRTIME GEAR

THE MARK CONSISTS OF STANDARD CHARACTERS WITHOUT CLAIM TO ANY PARTICULAR FONT, STYLE, SIZE, OR COLOR.

NO CLAIM IS MADE TO THE EXCLUSIVE RIGHT TO USE "GEAR", APART FROM THE MARK AS SHOWN.

FOR CLOTHING, NAMELY, PARKAS, COATS, JACKETS, VESTS; RAIN GEAR, NAMELY, RAIN COATS, RAIN JACKETS, RAIN SUITS; OUTERWEAR, NAMELY, SKI BIBS, UNIFORMS (U.S. CLS. 22 AND 39).

FIRST USE 4-30-2005; IN COMMERCE 4-30-2005.

CLASS 25—(Continued).

3,568,218. AIRTIME GEAR, LLC, BEAVERTON, OR. SN 77-189,204. PUB. 3-18-2008, FILED 5-24-2007.

AIRTIME 911

THE MARK CONSISTS OF STANDARD CHARACTERS WITHOUT CLAIM TO ANY PARTICULAR FONT, STYLE, SIZE, OR COLOR.

FOR CLOTHING, NAMELY, PARKAS, COATS, JACKETS, VESTS, RAIN GEAR, NAMELY, RAIN COATS, RAIN JACKETS, RAIN SUITS, OUTERWEAR, NAMELY, SKI BIBS, UNIFORMS (U.S. CLS. 22 AND 39).

FIRST USE 4-30-2005; IN COMMERCE 4-30-2005.

3,568,219. AIRTIME GEAR, LLC, BEAVERTON, OR. SN 77-189,206. PUB. 3-18-2008, FILED 5-24-2007.

AIRTIME

THE MARK CONSISTS OF STANDARD CHARACTERS WITHOUT CLAIM TO ANY PARTICULAR FONT, STYLE, SIZE, OR COLOR.

FOR CLOTHING, NAMELY, PARKAS, COATS, JACKETS, VESTS; RAIN GEAR, NAMELY, RAIN COATS, RAIN JACKETS, RAIN SUITS; OUTERWEAR, NAMELY, SKI BIBS, UNIFORMS (U.S. CLS. 22 AND 39).

FIRST USE 12-31-1986; IN COMMERCE 12-31-1986.

3,568,267. NOBIS, INC., MARKHAM, CANADA. SN 77-237,235. PUB. 2-12-2008, FILED 7-24-2007.

NOBIS

THE MARK CONSISTS OF STANDARD CHARACTERS WITHOUT CLAIM TO ANY PARTICULAR FONT, STYLE, SIZE, OR COLOR.

FOR HEADWEAR; T-SHIRTS; JACKETS; SWEATERS; TOPS; COATS; SCARVES; NECK BANDS; NECK GAITERS; GLOVES; MITTENS (U.S. CLS. 22 AND 39).

FIRST USE 9-1-2007; IN COMMERCE 9-1-2007.

CLASS 25—(Continued).

3,568,279. PLBD, INC., IRVING, TX. SN 77-244,814. PUB. 1-22-2008, FILED 8-1-2007.



PERFECT LITTLE BLACK DRESS

NO CLAIM IS MADE TO THE EXCLUSIVE RIGHT TO USE "PERFECT LITTLE BLACK DRESS", APART FROM THE MARK AS SHOWN.

THE MARK CONSISTS OF THE LETTERS "P", "L", "B" AND "D" WITH STARS AND LOOPING VINES ABOVE THE WORDS "PERFECT LITTLE BLACK DRESS".

FOR DRESSES (U.S. CLS. 22 AND 39).

FIRST USE 8-2-2007; IN COMMERCE 8-2-2007.

3,568,293. CARTER, SHAWN, NEW YORK, NY. SN 77-257,846. PUB. 2-12-2008, FILED 8-17-2007.



THE MARK CONSISTS OF TWO HANDS FACING OUTWARD WITH THE THUMBS AND INDEX FINGERS TOUCHING.

FOR CLOTHING; NAMELY, TEE SHIRTS, SHIRTS, TANK TOPS, SWEAT SHIRTS, JEANS, PANTS, JACKETS, COATS, UNDERGARMENTS, SOCKS AND HEADWEAR (U.S. CLS. 22 AND 39).

FIRST USE 8-30-2007; IN COMMERCE 8-30-2007.

3,568,310. KOBRA INTERNATIONAL, LTD., NEW YORK, NY. SN 77-268,109. PUB. 3-4-2008, FILED 8-30-2007.

N BY NICOLE MILLER

THE MARK CONSISTS OF STANDARD CHARACTERS WITHOUT CLAIM TO ANY PARTICULAR FONT, STYLE, SIZE, OR COLOR.

OWNER OF U.S. REG. NOS. 1,277,092, 2,855,579, AND OTHERS.

THE NAME "NICOLE MILLER" IDENTIFIES A LIVING INDIVIDUAL WHOSE CONSENT IS OF RECORD.

FOR FOOTWEAR (U.S. CLS. 22 AND 39).

FIRST USE 2-0-2008; IN COMMERCE 2-0-2008.

CLASS 25—(Continued).

3,568,320. TUDOR, GRACE M., WESTLAKE VILLAGE, CA. SN 77-272,441. PUB. 3-11-2008, FILED 9-5-2007.



THE COLOR(S) BLACK IS/ARE CLAIMED AS A FEATURE OF THE MARK.

THE MARK CONSISTS OF A TIKI FACE THAT HAS TWO EYES, ONE NOSE, ONE MOUTH, WITH DESIGN OF TWO ARROWS ON FOREHEAD POINTING DOWN, TWO LINES (ARROWS) ON CHIN POINTING UP, TWO LINES (ARROWS) ON EACH CHEEK POINTING IN. THE FACE IS ALL IN BLACK.

FOR ANKLE SOCKS; BERMUDA SHORTS; BOARD SHORTS; BOXER SHORTS; BRIEFS; DRESS SHIRTS; GOLF SHIRTS; GYM SHORTS; HATS; KNITTED UNDERWEAR; LADIES' UNDERWEAR; MEN'S SOCKS; NIGHT SHIRTS; RUGBY SHORTS; SPORT SHIRTS; SWEAT SHIRTS; SWIMWEAR; SNOWBOARD BOOTS; SNOWBOARD GLOVES; SNOWBOARD MITTENS; SNOWBOARD PANTS; ANTI-PERSPIRANT SOCKS; BUTTON-FRONT ALOHA SHIRTS; KNIT SHIRTS; LONG-SLEEVED SHIRTS; OPEN-NECKED SHIRTS; PANTIES, SHORTS AND BRIEFS; POLO SHIRTS; SHORTS; SLEEP SHIRTS; SOCKS; UNDERWEAR, NAMELY, BOY SHORTS; YOGA SHIRTS (U.S. CLS. 22 AND 39).

FIRST USE 2-1-2000; IN COMMERCE 8-1-2000.

CLASS 25—(Continued).

3,568,327. FIXICO, PHIL, WILKES, INGLEWOOD, CA. SN 77-277,138. PUB. 6-3-2008, FILED 9-11-2007.

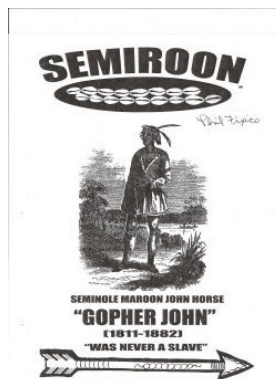

THE NAME "JOHN HORSE" AND "GOPHER JOHN" DOES NOT IDENTIFY A LIVING INDIVIDUAL. THE PORTRAIT DOES NOT IDENTIFY A LIVING INDIVIDUAL.

THE MARK CONSISTS OF TOP LINE IS THE NAME "SEMIROON IN BOLD PRINT". UNDER THAT IS A BLACK ELLIPTICAL SHAPE WITH 17 COWRIE SHELLS IN 2 ROWS INSIDE THE SHAPE. BELOW ON THE RIGHT IS THE SIGNATURE PHIL FIXICO. UNDER THAT AND IN THE CENTER OF THE PAGE IS A 19TH CENTURY DRAWING OF A BLACK INDIAN STANDING BETWEEN VEGETATION NEAR A LAKE. BELOW THIS APPEARS THE WORDS "SEMINOLE MAROON JOHN HORSE". UNDER THIS APPEARS THE NICKNAME "GOPHER JOHN". THEN BELOW THE DATES APPEARS THE QUOTE "WAS NEVER A SLAVE". FINALLY UNDER THE QUOTE THERE APPEARS AN ARROW WITH DECORATIONS ON IT..

SEMIROON DOES NOT HAVE ANY MEANING IN A FOREIGN LANGUAGE.

FOR SHORT-SLEEVED OR LONG-SLEEVED T-SHIRTS; T-SHIRTS (U.S. CLS. 22 AND 39).

FIRST USE 9-19-2007; IN COMMERCE 9-19-2007.

3,568,323. KABUSHIKI KAISHA MIYAKE DESIGN JI-MUSHO, DBA MIYAKE DESIGN STUDIO, SHIBUYA-KU, TOKYO, JAPAN. SN 77-275,319. PUB. 3-11-2008, FILED 9-10-2007.

CAULIFLOWER

THE MARK CONSISTS OF STANDARD CHARACTERS WITHOUT CLAIM TO ANY PARTICULAR FONT, STYLE, SIZE, OR COLOR.

FOR CLOTHING, NAMELY, DRESSES, GOWNS, SHIRTS, TOPS, BLOUSES, PANTS, SWEATERS, OVERCOATS, VESTS, CAMISOLES, BELTS, SHAWLS, SCARVES, HOSIERY (U.S. CLS. 22 AND 39).

FIRST USE 12-9-2007; IN COMMERCE 12-9-2007.

3,568,333. EVERLAST WORLD'S BOXING HEADQUARTERS CORPORATION, NEW YORK, NY. SN 77-278,707. PUB. 3-4-2008, FILED 9-13-2007.

HYDROLAST

THE MARK CONSISTS OF STANDARD CHARACTERS WITHOUT CLAIM TO ANY PARTICULAR FONT, STYLE, SIZE, OR COLOR.

FOR BOXING SHOES, FOOTWEAR (U.S. CLS. 22 AND 39).

FIRST USE 10-0-2007; IN COMMERCE 12-0-2007.

CLASS 25—(Continued).

3,568,336. BOLDWEAR CLOTHING, LLC, ATLANTA, GA. SN 77-279,144. PUB. 3-4-2008, FILED 9-13-2007.

BOLDWEAR

THE MARK CONSISTS OF STANDARD CHARACTERS WITHOUT CLAIM TO ANY PARTICULAR FONT, STYLE, SIZE, OR COLOR.
FOR CLOTHING, NAMELY, TEE SHIRTS (U.S. CLS. 22 AND 39).

FIRST USE 5-27-2008; IN COMMERCE 5-27-2008.

3,568,345. HBI BRANDED APPAREL ENTERPRISES, LLC, WINSTON-SALEM, NC. SN 77-282,002. PUB. 3-25-2008, FILED 9-18-2007.

INVISIBLY PRETTY

THE MARK CONSISTS OF STANDARD CHARACTERS WITHOUT CLAIM TO ANY PARTICULAR FONT, STYLE, SIZE, OR COLOR.

FOR BRAS; PANTIES (U.S. CLS. 22 AND 39).
FIRST USE 7-1-2008; IN COMMERCE 7-1-2008.

3,568,358. MARPESSA, INC., SOLANA BEACH, CA. SN 77-287,458. PUB. 3-11-2008, FILED 9-24-2007.

MARPESSA

THE MARK CONSISTS OF STANDARD CHARACTERS WITHOUT CLAIM TO ANY PARTICULAR FONT, STYLE, SIZE, OR COLOR.

FOR BIKINIS, BATHING SUITS, SWIMWEAR, BEACHWEAR (U.S. CLS. 22 AND 39).
FIRST USE 9-0-2007; IN COMMERCE 9-0-2007.

CLASS 25—(Continued).

3,568,381. RAINBOW SANDALS, INC., SAN CLEMENTE, CA. SN 77-294,030. PUB. 3-18-2008, FILED 10-2-2007.

MOCCA-LOAF

THE MARK CONSISTS OF STANDARD CHARACTERS WITHOUT CLAIM TO ANY PARTICULAR FONT, STYLE, SIZE, OR COLOR.

FOR FOOTWEAR, NAMELY, SHOES (U.S. CLS. 22 AND 39).

FIRST USE 6-25-2008; IN COMMERCE 6-30-2008.

3,568,449. AMERICAN SOCCER COMPANY, INC., WILMINGTON, CA. SN 77-338,379. PUB. 3-11-2008, FILED 11-27-2007.

ONE WORLD ONE SPORT

THE MARK CONSISTS OF STANDARD CHARACTERS WITHOUT CLAIM TO ANY PARTICULAR FONT, STYLE, SIZE, OR COLOR.

FOR SOCCER UNIFORMS (U.S. CLS. 22 AND 39).
FIRST USE 2-0-2008; IN COMMERCE 2-0-2008.

3,568,472. BARRETT, MARILYN, LOS ANGELES, CA. SN 77-358,928. PUB. 5-13-2008, FILED 12-23-2007.

REVENGE IS...

THE MARK CONSISTS OF STANDARD CHARACTERS WITHOUT CLAIM TO ANY PARTICULAR FONT, STYLE, SIZE, OR COLOR.

FOR CLOTHING, FOOTWEAR AND HEADGEAR, NAMELY, SLEEP WEAR, NAMELY, PAJAMAS, SLEEP SHIRTS AND ROBES, DORM SHIRTS, UNDERWEAR, LINGERIE, BOXER SHORTS, BOXER BRIEFS, SWIMWEAR, COATS AND JACKETS, SHIRTS AND TOPS INCLUDING TANK TOPS AND T-SHIRTS, SWEAT-SHIRTS AND SWEAT PANTS, SHORTS; CAPS AND HATS, SKIRTS, TROUSERS, JEANS, HOSIERY, UNDERWEAR, DRESSES, ROMPERS, OVERALLS, SHOES, SANDALS, BOOTS, HOUSE SHOES, SLIPPERS, CLOTH BIBS, HALLOWEEN COSTUMES, VESTS, BLOUSES, BANDANAS, SCARVES, TIES, NECKWEAR, BELTS, HEAD BANDS, JOGGING AND WARM-UP SUITS, EXERCISE TOPS, SHORTS AND PANTS, AND SWEAT BANDS (U.S. CLS. 22 AND 39).

FIRST USE 11-18-2008; IN COMMERCE 11-18-2008.

CLASS 25—(Continued).

3,568,514. MARPESSA, INC., SOLANA BEACH, CA. SN 77-407,578. PUB. 7-15-2008, FILED 2-27-2008.

CLASS 25—(Continued).

3,568,539. TWO STAR DOG, INC., BERKELEY, CA. SN 77-430,893. PUB. 8-5-2008, FILED 3-25-2008.

ENSEMBLE

STELLA CARAKASI

THE MARK CONSISTS OF STANDARD CHARACTERS WITHOUT CLAIM TO ANY PARTICULAR FONT, STYLE, SIZE, OR COLOR.

FOR BIKINIS, BATHING SUITS, SWIMWEAR, BEACHWEAR (U.S. CLS. 22 AND 39).

FIRST USE 3-0-2008; IN COMMERCE 3-0-2008.

THE MARK CONSISTS OF STANDARD CHARACTERS WITHOUT CLAIM TO ANY PARTICULAR FONT, STYLE, SIZE, OR COLOR.

THE NAME(S), PORTRAIT(S), AND/OR SIGNATURE(S) SHOWN IN THE MARK IDENTIFIES "STELLA CARAKASI", WHOSE CONSENT(S) TO REGISTER IS MADE OF RECORD.

FOR COATS, JACKETS, PANTS, SKIRTS, SWEATERS, BLOUSES, SHIRTS AND DRESSES (U.S. CLS. 22 AND 39).

FIRST USE 10-20-2008; IN COMMERCE 10-20-2008.

3,568,521. GRANUS, JACKIE, ST PAUL, MN. SN 77-412,505. PUB. 8-5-2008, FILED 3-4-2008.

3,568,565. LOVERLY, INC., ASTORIA, NY. SN 77-976,251. PUB. 2-12-2008, FILED 2-20-2007.



NO CLAIM IS MADE TO THE EXCLUSIVE RIGHT TO USE "COLLECTION", APART FROM THE MARK AS SHOWN.

THE COLOR(S) BLACK, BLUE ORANGE, YELLOW AND WHITE IS/ARE CLAIMED AS A FEATURE OF THE MARK.

THE MARK CONSISTS OF THE WORD "CONASAUR" IN BLUE WITH BLACK OUTLINES ABOVE A DINOSAUR IN ORANGE WITH BLUE TRIM, WHITE TEETH AND OUTLINES IN BLACK AND THE WORD "COLLECTION" UNDERNEATH IT IN BLUE WITH BLACK OULINES ENCLOSED WITH A BLACK CIRCLE AROUND THE ENTIRE DESIGN THE BACKGROUND IS WHITE THE EYE IS YELLOW.

FOR FOOTWEAR (U.S. CLS. 22 AND 39).
FIRST USE 11-6-2008; IN COMMERCE 11-6-2008.

THE MARK CONSISTS OF WOMAN SEATED IN AND GRASPING THE LETTER "O" IN THE WORD "LOVERLY".

FOR BLOUSES; BOTTOMS; COATS; FOOTWEAR; HEADGEAR, NAMELY, HATS, CAPS, JACKETS; LINGERIE; LOUNGEWEAR; PAJAMAS; ROMPERS; SHIRTS; SKIRTS; SLEEPWEAR; T-SHIRTS; TOPS; UNDERGARMENTS (U.S. CLS. 22 AND 39).

FIRST USE 11-5-2008; IN COMMERCE 11-5-2008.

CLASS 25—(Continued).

3,568,566. MISTER HOLLYWOOD CO., LTD., OSAKA-SHI, OSAKA, JAPAN. SN 77-976,345. PUB. 3-18-2008, FILED 3-16-2007.

N . HOOLYWOOD

½ MISTER HÖLLYWOOD

FOR BLOUSONS, BLAZERS, PARKAS, JACKETS, JUMPERS, SUITS, PANTS, COATS, SWEATERS, VESTS, SHIRTS, SWEAT SHIRTS, SWEAT PANTS, POLO SHIRTS, TEE-SHIRTS, UNDERWEAR, SOCKS, STOLE, SHAWLS, SCARFS, NECKTIES, NECKERCHIEFS, BANDANAS, MUFFLERS, HATS, STOCKING SUSPENDERS, BRACES IN THE NATURE OF SUSPENDERS, WAIST-BANDS, BELTS, FOOTWEAR, AND SPECIAL SPORTING/GYMNASTIC FOOTWEAR (U.S. CLS. 22 AND 39).
FIRST USE 2-12-2008; IN COMMERCE 2-12-2008.

3,568,597. GALLAGHER, STEVEN R., DEDHAM, MA. AND QUINN, TIMOTHY C., WESTROXBURY, MA. SN 78-559,011. PUB. 11-1-2005, FILED 2-2-2005.



THE MARK CONSISTS OF THE MARK IS IN THE SHAPE OF A CLOVER WITH THE TWO LEAVES ON THE RIGHT SIDE OF THE CLOVER HOLLOWED OUT INTO THE SHAPE OF THE LETTER "B". THE LEFT LEAF OF THE CLOVER IS COLORED IN.

FOR TOPS, BOTTOMS, HEADWEAR, COATS, JACKETS (U.S. CLS. 22 AND 39).
FIRST USE 6-15-2005; IN COMMERCE 6-15-2005.

CLASS 25—(Continued).

3,568,612. LE CHAUVINIST, INC., LA JOLLA, CA. SN 78-672,982. PUB. 4-4-2006, FILED 7-18-2005.

Le Chauvinist

THE MARK CONSISTS OF STANDARD CHARACTERS WITHOUT CLAIM TO ANY PARTICULAR FONT, STYLE, SIZE, OR COLOR.

FOR CAPS; HEADGEAR, NAMELY, HATS, CAPS, VISORS; HEADWEAR; SWEAT SHIRTS; TOPS; T-SHIRTS (U.S. CLS. 22 AND 39).

FIRST USE 9-20-2003; IN COMMERCE 12-1-2007.

3,568,617. LOVE LINE, INC., DBA LOVE LINE, INC. HOUSTON, TX. SN 78-713,305. PUB. 1-30-2007, FILED 9-15-2005.

LOVE LINE

THE MARK CONSISTS OF STANDARD CHARACTERS WITHOUT CLAIM TO ANY PARTICULAR FONT, STYLE, SIZE, OR COLOR.

NO CLAIM IS MADE TO THE EXCLUSIVE RIGHT TO USE "LINE", APART FROM THE MARK AS SHOWN.

FOR ATHLETIC CLOTHING FOR GIRLS, TODDLERS AND BABIES, NAMELY, BLOUSES, SHIRTS, JERSEYS, TOPS, SKIRTS, SKIRTS AND DRESSES, PANTS, JACKETS, SWEATERS, HATS, CAPS, AND BELTS (U.S. CLS. 22 AND 39).

FIRST USE 1-1-2005; IN COMMERCE 1-1-2005.

3,568,656. DUGERY, ERIN, NEWTOWN SQUARE, PA. AND DAY, KELLY, BRYN MAWR, PA. SN 78-879,344. PUB. 9-26-2006, FILED 5-9-2006.

SAVE SECOND BASE

THE MARK CONSISTS OF STANDARD CHARACTERS WITHOUT CLAIM TO ANY PARTICULAR FONT, STYLE, SIZE, OR COLOR.

FOR BASEBALL CAPS; POLO SHIRTS; SWEAT SHIRTS; T-SHIRTS (U.S. CLS. 22 AND 39).
FIRST USE 11-6-2008; IN COMMERCE 11-6-2008.

CLASS 25—(Continued).

3,568,681. FIORY S.A., MEDELLIN, COLOMBIA. SN 78-936,380. PUB. 9-11-2007, FILED 7-24-2006.



FOR CLOTHING, NAMELY, PULLOVERS, JACKETS, BLOUSES, SHIRTS, TEE-SHIRTS, TOPS, BOTTOMS, BLUE JEANS, CAPRIS, PANTS, AND SKIRTS (U.S. CLS. 22 AND 39).
FIRST USE 6-30-2005; IN COMMERCE 6-30-2005.

3,568,686. MARLENE M. GUIRGUIS, NORTHRIDGE, CA. SN 78-944,212. PUB. 3-27-2007, FILED 8-3-2006.



THE COLOR(S) BLACK AND YELLOW IS/ARE CLAIMED AS A FEATURE OF THE MARK.
THE MARK CONSISTS OF A BLACK AND YELLOW HONEY BEE FLYING IN THE FORM OF A HEART OUTLINED IN BLACK; THE WORD "HONEYLOVE" APPEARS IN THE COLOR BLACK AND IS WRITTEN ACROSS THE CENTER OF THE HEART.
THE MARK CONSISTS OF A BLACK AND YELLOW HONEY BEE FLYING IN THE FORM OF A HEART.
FOR TOPS, PANTS, DENIM JEANS, LINGERIE, UNDERWEAR, T-SHIRTS, SHORTS, SHOES, SKIRTS, DRESSES, JACKETS, HATS, HEADWEAR, TANK TOPS, SWEATPANTS, SWEATSHIRTS, JUMPSUITS, BATHING SUITS, BELTS, CORSETS (U.S. CLS. 22 AND 39).
FIRST USE 7-1-2007; IN COMMERCE 1-10-2008.

CLASS 25—(Continued).

3,568,703. KIPP, MASTIN, LOS ANGELES, CA. SN 78-980,679. PUB. 7-3-2007, FILED 10-23-2005.

LOVE YOURSELF

THE MARK CONSISTS OF STANDARD CHARACTERS WITHOUT CLAIM TO ANY PARTICULAR FONT, STYLE, SIZE, OR COLOR.
FOR CLOTHING, NAMELY, T-SHIRTS (U.S. CLS. 22 AND 39).
FIRST USE 6-30-2005; IN COMMERCE 6-30-2005.

CLASS 26—FANCY GOODS

3,568,439. LESLIE LAMBERT TURNQUEST, NASSAU, BAHAMAS. SN 77-329,259. PUB. 4-8-2008, FILED 11-14-2007.

BE-DAZZLED

THE MARK CONSISTS OF STANDARD CHARACTERS WITHOUT CLAIM TO ANY PARTICULAR FONT, STYLE, SIZE, OR COLOR.
FOR HAIR EXTENSIONS AND HAIR PIECES IN THE FORM OF SYNTHETIC, KANEKALON AND HUMAN HAIR WEAVES; HAIR EXTENSIONS AND HAIR PIECES IN THE FORM OF SYNTHETIC, KANEKALON AND HUMAN HAIR BRAIDS (U.S. CLS. 37, 39, 40, 42 AND 50).
FIRST USE 10-15-2008; IN COMMERCE 10-15-2008.

CLASS 27—FLOOR COVERINGS

3,568,113. GODFREY HIRST AUSTRALIA PTY LTD., SOUTH GEELONG VICTORIA, AUSTRALIA. SN 77-101,562. PUB. 10-9-2007, FILED 2-7-2007.



NO CLAIM IS MADE TO THE EXCLUSIVE RIGHT TO USE "CARPETS", APART FROM THE MARK AS SHOWN.
THE NAME "GODFREY HIRST" DOES NOT IDENTIFY A LIVING INDIVIDUAL.
THE COLOR(S) BLACK, RED AND WHITE IS/ARE CLAIMED AS A FEATURE OF THE MARK.
THE MARK CONSISTS OF A RED RECTANGLE WITH THE WORDING "GODFREY HIRST" IN WHITE ON TOP AND A BLACK RECTANGLE WITH THE WORD "CARPETS" IN WHITE ON TOP.
FOR CARPETS, CARPET TILES, FLOOR COVERINGS, CARPET UNDERLAYS; RUGS, FLOOR MATS (U.S. CLS. 19, 20, 37, 42 AND 50).
FIRST USE 7-10-2000; IN COMMERCE 7-10-2000.

CLASS 27—(Continued).

3,568,114. GODFREY HIRST AUSTRALIA PTY LTD., SOUTH GEELONG VICTORIA, AUSTRALIA. SN 77-101,615. PUB. 10-9-2007, FILED 2-7-2007.

GODFREY HIRST

THE MARK CONSISTS OF STANDARD CHARACTERS WITHOUT CLAIM TO ANY PARTICULAR FONT, STYLE, SIZE, OR COLOR.

THE NAME "GODFREY HIRST" DOES NOT IDENTIFY A LIVING INDIVIDUAL.

FOR CARPETS, CARPET TILES, FLOOR COVERINGS, CARPET UNDERLAYS; RUGS, FLOOR MATS (U.S. CLS. 19, 20, 37, 42 AND 50).

FIRST USE 8-15-1997; IN COMMERCE 8-15-1997.

3,568,115. GODFREY HIRST AUSTRALIA PTY LTD., SOUTH GEELONG VICTORIA, AUSTRALIA. SN 77-101,654. PUB. 10-9-2007, FILED 2-7-2007.



THE NAME "GODFREY HIRST" DOES NOT IDENTIFY A LIVING INDIVIDUAL.

THE MARK CONSISTS OF THE WORDS "GODFREY HIRST" IN A SCRIPT FORM.

FOR CARPETS, CARPET TILES, FLOOR COVERINGS, CARPET UNDERLAYS; RUGS, FLOOR MATS (U.S. CLS. 19, 20, 37, 42 AND 50).

FIRST USE 5-15-1997; IN COMMERCE 8-15-1997.

3,568,675. ARMS BUILDING & MAINTENANCE, INC., LONGVIEW, TX. SN 78-932,189. PUB. 2-27-2007, FILED 7-18-2006.



FOR SYNTHETIC TURF FOR OUTDOOR FIELDS USED FOR SOCCER, FOOTBALL, BASEBALL, LACROSSE, FIELD HOCKEY AND OTHER ATHLETIC ACTIVITIES (U.S. CLS. 19, 20, 37, 42 AND 50).

FIRST USE 9-30-2006; IN COMMERCE 1-31-2007.

CLASS 28—TOYS AND SPORTING GOODS

CLASS 28—(Continued).

3,568,019. WIZARDS OF THE COAST, INC., PAWTUCKET, RI. SN 76-674,743. PUB. 8-14-2007, FILED 3-28-2007.

MORNINGTIDE

THE MARK CONSISTS OF STANDARD CHARACTERS WITHOUT CLAIM TO ANY PARTICULAR FONT, STYLE, SIZE, OR COLOR.

FOR TRADING CARD GAMES (U.S. CLS. 22, 23, 38 AND 50).

FIRST USE 2-1-2008; IN COMMERCE 2-1-2008.

3,568,076. BLUE BOX TOY FACTORY LIMITED, EAST KOWLOON, HONG KONG. SN 77-056,919. PUB. 3-25-2008, FILED 12-5-2006.

CLICKEROOS

THE MARK CONSISTS OF STANDARD CHARACTERS WITHOUT CLAIM TO ANY PARTICULAR FONT, STYLE, SIZE, OR COLOR.

FOR TOYS, GAMES AND PLAYTHINGS, NAMELY, ACTION FIGURES AND ACCESSORIES TO THE ACTION FIGURES, STUFFED TOYS; PLUSH TOYS AND PLUSH TOY ANIMALS; BATHTUB TOYS; RIDE-ON TOYS; TOY VEHICLES (U.S. CLS. 22, 23, 38 AND 50).

FIRST USE 10-29-2007; IN COMMERCE 10-29-2007.

3,568,085. AEROGROW INTERNATIONAL, INC., BOULDER, CO. SN 77-073,345. PUB. 10-23-2007, FILED 12-29-2006.

AEROGARDEN

THE MARK CONSISTS OF STANDARD CHARACTERS WITHOUT CLAIM TO ANY PARTICULAR FONT, STYLE, SIZE, OR COLOR.

FOR CHILDREN'S TOY HOBBY SETS FOR GERMINATING SEEDS AND GROWING PLANTS HYDROPONICALLY AND AEROPONICALLY (U.S. CLS. 22, 23, 38 AND 50).

FIRST USE 12-29-2006; IN COMMERCE 11-10-2008.

CLASS 28—(Continued).

3,568,088. STROKIN, LLC, CHASKA, MN. SN 77-075,495.
PUB. 2-26-2008, FILED 1-3-2007.

SPITFIRE XL

THE MARK CONSISTS OF STANDARD CHARACTERS WITHOUT CLAIM TO ANY PARTICULAR FONT, STYLE, SIZE, OR COLOR.
NO CLAIM IS MADE TO THE EXCLUSIVE RIGHT TO USE "XL", APART FROM THE MARK AS SHOWN.
FOR GOLF CLUBS (U.S. CLS. 22, 23, 38 AND 50).
FIRST USE 3-7-2007; IN COMMERCE 3-7-2007.

3,568,150. SNYDER, DAVID, EAGLE ROCK, CA. AND SNYDER, NJERI, EAGLE ROCK, CA. SN 77-130,331.
PUB. 9-18-2007, FILED 3-13-2007.

Blast Toys

THE MARK CONSISTS OF STANDARD CHARACTERS WITHOUT CLAIM TO ANY PARTICULAR FONT, STYLE, SIZE, OR COLOR.
NO CLAIM IS MADE TO THE EXCLUSIVE RIGHT TO USE "TOYS", APART FROM THE MARK AS SHOWN.
FOR TOY VEHICLES; BATH TOYS; CHILDREN'S MULTIPLE ACTIVITY TOYS; COLLECTABLE TOY FIGURES; DISC TOSS TOYS; DRAWING TOYS; EDUCATIONAL TOY FOR THE PURPOSE OF THE DEMONSTRATION OF ALTERNATIVE ENERGY SOURCES; FANTASY CHARACTER TOYS; INFANT DEVELOPMENT TOYS; MECHANICAL TOYS; MUSICAL TOYS; PARTY FAVORS IN THE NATURE OF SMALL TOYS; PLUSH TOYS; POP UP TOYS; PRINTING TOYS; RIDE-ON TOYS; TOY ACTION FIGURES; TOY BAKEWARE AND COOKWARE; TOY CONSTRUCTION BLOCKS (U.S. CLS. 22, 23, 38 AND 50).
FIRST USE 11-19-2007; IN COMMERCE 11-19-2007.

3,568,191. MATTEL, INC., EL SEGUNDO, CA. SN 77-169,672.
PUB. 4-1-2008, FILED 5-1-2007.

TILT-OFFS

THE MARK CONSISTS OF STANDARD CHARACTERS WITHOUT CLAIM TO ANY PARTICULAR FONT, STYLE, SIZE, OR COLOR.
FOR TOYS, GAMES AND PLAYTHINGS, NAMELY, TOY VEHICLES AND ACCESSORIES THEREFOR (U.S. CLS. 22, 23, 38 AND 50).
FIRST USE 12-2-2008; IN COMMERCE 12-2-2008.

CLASS 28—(Continued).

3,568,194. MATTEL, INC., EL SEGUNDO, CA. SN 77-170,388.
PUB. 4-1-2008, FILED 5-1-2007.

SUDS & SURPRISE

THE MARK CONSISTS OF STANDARD CHARACTERS WITHOUT CLAIM TO ANY PARTICULAR FONT, STYLE, SIZE, OR COLOR.
OWNER OF U.S. REG. NO. 2,520,582.
FOR TOYS, GAMES AND PLAYTHINGS, NAMELY, DOLLS, DOLL CLOTHING AND DOLL ACCESSORIES, TOY FIGURES, DOLL HAIR STYLING HEADS, BATH TOYS, AND ACCESSORIES FOR ALL OF THE FOREGOING (U.S. CLS. 22, 23, 38 AND 50).
FIRST USE 3-28-2008; IN COMMERCE 3-28-2008.

3,568,195. MATTEL, INC., EL SEGUNDO, CA. SN 77-170,390.
PUB. 4-1-2008, FILED 5-1-2007.

STYLISH SCENTS

THE MARK CONSISTS OF STANDARD CHARACTERS WITHOUT CLAIM TO ANY PARTICULAR FONT, STYLE, SIZE, OR COLOR.
OWNER OF U.S. REG. NOS. 2,915,113 AND 2,968,319.
FOR TOYS, GAMES AND PLAYTHINGS, NAMELY, DOLLS, DOLL CLOTHING AND DOLL ACCESSORIES, TOY FIGURES AND ACCESSORIES THEREFOR (U.S. CLS. 22, 23, 38 AND 50).
FIRST USE 3-28-2008; IN COMMERCE 3-28-2008.

3,568,228. ZACHARY JIRKOVSKY, CAMARILLO, CA. SN 77-196,410. PUB. 2-26-2008, FILED 6-4-2007.

JIRKOV

THE MARK CONSISTS OF STANDARD CHARACTERS WITHOUT CLAIM TO ANY PARTICULAR FONT, STYLE, SIZE, OR COLOR.
FOR SURFBOARD WAX; SURFBOARDS; SNOWBOARD DECKS; SNOWBOARDS; SKATEBOARD DECKS; SKATEBOARD GRIP TAPES; SKATEBOARDS; BOARDS USED IN THE PRACTICE OF WATER SPORTS; PADDLE BOARDS (U.S. CLS. 22, 23, 38 AND 50).
FIRST USE 11-19-2008; IN COMMERCE 11-19-2008.

CLASS 28—(Continued).

3,568,230. CLAWSON CUSTOM CUES, INC., JACKSONVILLE, FL. SN 77-196,874. PUB. 3-18-2008, FILED 6-4-2007.

ARSENIC

THE MARK CONSISTS OF STANDARD CHARACTERS WITHOUT CLAIM TO ANY PARTICULAR FONT, STYLE, SIZE, OR COLOR.

FOR POOL CUES, BILLIARD CUES, BILLIARD ACCESSORIES, NAMELY, CUE CASES (U.S. CLS. 22, 23, 38 AND 50).

FIRST USE 10-24-2007; IN COMMERCE 10-24-2007.

CLASS 28—(Continued).

3,568,351. UP COUNTRY INC., EAST PROVIDENCE, RI. SN 77-285,984. PUB. 3-18-2008, FILED 9-21-2007.

UP COUNTRY

THE MARK CONSISTS OF STANDARD CHARACTERS WITHOUT CLAIM TO ANY PARTICULAR FONT, STYLE, SIZE, OR COLOR.

OWNER OF U.S. REG. NO. 1,303,720. FOR PET TOYS (U.S. CLS. 22, 23, 38 AND 50). FIRST USE 1-31-1984; IN COMMERCE 1-31-1984.

3,568,303. SUSAN P. WALSH, NORTHVILLE, MI. SN 77-263,456. PUB. 2-26-2008, FILED 8-24-2007.

RADDLEPADDLE

THE MARK CONSISTS OF STANDARD CHARACTERS WITHOUT CLAIM TO ANY PARTICULAR FONT, STYLE, SIZE, OR COLOR.

FOR NOVELTY AND GIFT ITEMS, NAMELY, TOY NOISEMAKERS (U.S. CLS. 22, 23, 38 AND 50).

FIRST USE 1-16-2007; IN COMMERCE 1-16-2007.

3,568,318. CITY OF NEW YORK BY AND THROUGH THE NEW YORK CITY TAXI AND LIMOUSINE COMMISSION, NEW YORK, NY. SN 77-271,974. PUB. 8-5-2008, FILED 9-5-2007.



NO CLAIM IS MADE TO THE EXCLUSIVE RIGHT TO USE "NYC TAXI", APART FROM THE MARK AS SHOWN.

THE MARK CONSISTS OF A STYLIZED CHECKER DESIGN TO THE RIGHT OF "7C43", OF A RECTANGLE CONTAINING A STYLIZED DEPICTION OF A MAN HAILING A CAB NEXT TO THE WORDING "\$2.50 INITIAL FARE" AND ILLEGIBLE TAXI FARE INFORMATION, AND OF THE WORDING "NYC TAXI" IN STYLIZED FORMAT WHEREIN THE "T" IS ENCASED IN A CIRCLE.

FOR TOY VEHICLES (U.S. CLS. 22, 23, 38 AND 50). FIRST USE 11-1-2007; IN COMMERCE 11-1-2007.

3,568,401. ACTIVE ANKLE SYSTEMS, INC., JEFFERSONVILLE, IN. SN 77-300,934. PUB. 3-25-2008, FILED 10-10-2007.

VOLT

THE MARK CONSISTS OF STANDARD CHARACTERS WITHOUT CLAIM TO ANY PARTICULAR FONT, STYLE, SIZE, OR COLOR.

FOR ATHLETIC EQUIPMENT, NAMELY, ANKLE BRACES (U.S. CLS. 22, 23, 38 AND 50). FIRST USE 1-10-2008; IN COMMERCE 1-10-2008.

3,568,422. ACTIVE ANKLE SYSTEMS, INC., JEFFERSONVILLE, IN. SN 77-319,242. PUB. 3-25-2008, FILED 11-1-2007.



THE MARK CONSISTS OF "VOLT" APPEARING WITHIN A ROUNDED RECTANGLE, WITH A PATTERN OF ZIG-ZAG LINES APPEARING IN THE INTERIOR OF THE ROUNDED RECTANGLE.

FOR ATHLETIC EQUIPMENT, NAMELY, ANKLE BRACES (U.S. CLS. 22, 23, 38 AND 50). FIRST USE 1-10-2008; IN COMMERCE 1-10-2008.

CLASS 28—(Continued).

3,568,423. ACTIVE ANKLE SYSTEMS, INC., JEFFERSONVILLE, IN. SN 77-319,286. PUB. 3-25-2008, FILED 11-1-2007.



THE COLOR(S) YELLOW, SILVER, AND WHITE IS/ARE CLAIMED AS A FEATURE OF THE MARK.

THE MARK CONSISTS OF "VOLT" IN THE COLOR YELLOW (OUTLINED IN THE COLOR WHITE AND ACCENTED IN THE COLOR SILVER) APPEARING WITHIN A ROUNDED RECTANGLE HAVING A PATTERN OF SILVER ZIG-ZAG LINES THROUGHOUT ITS INTERIOR, WITH THE EXTERIOR BORDER OF THE ROUNDED RECTANGLE APPEARING IN THE COLOR SILVER AND THE INTERIOR BORDER OF THE ROUNDED RECTANGLE APPEARING IN THE COLOR WHITE.

FOR ATHLETIC EQUIPMENT, NAMELY, ANKLE BRACES (U.S. CLS. 22, 23, 38 AND 50).

FIRST USE 1-10-2008; IN COMMERCE 1-10-2008.

CLASS 28—(Continued).

3,568,468. GREENMASTER INDUSTRIAL CORP., TAIPING, TAIWAN. SN 77-356,445. PUB. 5-13-2008, FILED 12-20-2007.

EMX

THE MARK CONSISTS OF STANDARD CHARACTERS WITHOUT CLAIM TO ANY PARTICULAR FONT, STYLE, SIZE, OR COLOR.

FOR EXERCISE EQUIPMENT, NAMELY, ROWING MACHINES; CHEST EXPANDERS; EXERCISE EQUIPMENT, NAMELY, STATIONARY CYCLES; EXERCISE TREADMILLS; EXERCISING EQUIPMENT, NAMELY, POWERED TREADMILLS FOR RUNNING; EXERCISING EQUIPMENT, NAMELY, WEIGHT LIFTING MACHINES; LEG WEIGHTS FOR EXERCISING; STATIONARY EXERCISE BICYCLES; STATIONARY EXERCISE BICYCLES AND ROLLERS THEREFOR; VIBRATING APPARATUS USED IN FITNESS AND EXERCISE PROGRAMS TO STIMULATE MUSCLES AND INCREASE STRENGTH AND PHYSICAL PERFORMANCE; EXERCISE EQUIPMENT, NAMELY, ABDOMINAL BOARDS; AEROBIC STEP MACHINES; EXERCISE EQUIPMENT, NAMELY, STAIR-STEPPING MACHINES (U.S. CLS. 22, 23, 38 AND 50).

FIRST USE 12-21-2007; IN COMMERCE 3-21-2008.

3,568,460. MAXIMA MANUFACTURING COMPANY MEINEL VERWALTUNGES GMBH & CO. KG, GERETSRIED, FED REP GERMANY. SN 77-343,748. PUB. 4-29-2008, FILED 12-4-2007.

TREAZURE

THE MARK CONSISTS OF STANDARD CHARACTERS WITHOUT CLAIM TO ANY PARTICULAR FONT, STYLE, SIZE, OR COLOR.

FOR FISHING LINES (U.S. CLS. 22, 23, 38 AND 50).
FIRST USE 12-5-2007; IN COMMERCE 12-5-2007.

3,568,471. AMERICAN SPORTS LICENSING, INC., WILMINGTON, DE. SN 77-357,933. PUB. 5-6-2008, FILED 12-21-2007.

C3

THE MARK CONSISTS OF STANDARD CHARACTERS WITHOUT CLAIM TO ANY PARTICULAR FONT, STYLE, SIZE, OR COLOR.

FOR GOLF EQUIPMENT, NAMELY, BALLS, CLUBS, BAGS AND GLOVES (U.S. CLS. 22, 23, 38 AND 50).
FIRST USE 5-1-2008; IN COMMERCE 5-1-2008.

CLASS 28—(Continued).

3,568,474. KNOWLEDGEBALL LLC, PASADENA, CA. SN 77-361,242. PUB. 5-27-2008, FILED 12-28-2007.

KNOWLEDGEBALL

THE MARK CONSISTS OF STANDARD CHARACTERS WITHOUT CLAIM TO ANY PARTICULAR FONT, STYLE, SIZE, OR COLOR.

FOR SPORT BALLS, NAMELY, FOOTBALLS, MEDICINE BALLS, EXERCISE BALLS, BALLS FOR PERFORMING YOGA EXERCISES, BASEBALLS, SOCCER BALLS, BASKETBALLS, RUGBY BALLS AND GOLF BALLS ALL WITH IMPRINTED INSTRUCTIONS ON HOW TO PLAY THE PARTICULAR SPORT (U.S. CLS. 22, 23, 38 AND 50).

FIRST USE 3-15-2008; IN COMMERCE 6-1-2008.

3,568,551. PENN RACQUET SPORTS, INC., PHOENIX, AZ. SN 77-447,142. PUB. 8-19-2008, FILED 4-14-2008.



The logo for Pro Penn+ features the word "Pro" in a stylized, italicized font above the word "Penn+" in a larger, bold, italicized font. A plus sign is positioned at the end of "Penn+".

OWNER OF U.S. REG. NOS. 986,844, 1,936,108, AND 2,765,325.

NO CLAIM IS MADE TO THE EXCLUSIVE RIGHT TO USE "PRO", APART FROM THE MARK AS SHOWN.

THE MARK CONSISTS OF THE WORDS "PRO PENN" AND A DESIGN SYMBOL THAT IS A PLUS SIGN.

FOR TENNIS BALLS (U.S. CLS. 22, 23, 38 AND 50).

FIRST USE 5-6-2008; IN COMMERCE 7-15-2008.

3,568,587. LUCASFILM ENTERTAINMENT COMPANY LTD., SAN FRANCISCO, CA. SN 78-456,850. PUB. 8-23-2005, FILED 7-26-2004.

GENERAL GRIEVOUS

THE MARK CONSISTS OF STANDARD CHARACTERS WITHOUT CLAIM TO ANY PARTICULAR FONT, STYLE, SIZE, OR COLOR.

FOR BOARD GAMES, CONSTRUCTION TOYS, JIGSAW PUZZLES, TOY ACTION FIGURES, TOY WEAPONS, TOY MODEL VEHICLES, COLLECTIBLE CARD GAMES; COLLECTIBLE MINIATURE BOARD GAMES (U.S. CLS. 22, 23, 38 AND 50).

FIRST USE 4-0-2005; IN COMMERCE 4-0-2005.

CLASS 28—(Continued).

3,568,603. PRAETORIAN FITNESS PRODUCTS, INC., CARLISLE, PA. SN 78-639,930. PUB. 2-28-2006, FILED 5-31-2005.



The logo for Praetorian features the word "PRAETORIAN" in a bold, serif font, arched over a central graphic element that resembles a stylized 'X' or a similar symbol.

FOR MANUALLY OPERATED FOREARM AND WRIST EXERCISER (U.S. CLS. 22, 23, 38 AND 50).

FIRST USE 9-17-2008; IN COMMERCE 9-17-2008.

3,568,620. LAVALLEY, WILLIAM, AUSTIN, TX. SN 78-724,132. PUB. 9-19-2006, FILED 9-30-2005.

Shouting Anagrams

THE MARK CONSISTS OF STANDARD CHARACTERS WITHOUT CLAIM TO ANY PARTICULAR FONT, STYLE, SIZE, OR COLOR.

NO CLAIM IS MADE TO THE EXCLUSIVE RIGHT TO USE "ANAGRAMS", APART FROM THE MARK AS SHOWN.

FOR PARLOR GAMES; PARTY GAMES (U.S. CLS. 22, 23, 38 AND 50).

FIRST USE 9-30-2005; IN COMMERCE 6-15-2007.

3,568,645. HEALTH FLEX TECHNOLOGIES, INC. MIAMI, FL. SN 78-830,210. PUB. 3-25-2008, FILED 3-6-2006.

Break the Habit

THE MARK CONSISTS OF STANDARD CHARACTERS WITHOUT CLAIM TO ANY PARTICULAR FONT, STYLE, SIZE, OR COLOR.

FOR ISOTONIC POSTURAL EXERCISER, NAMELY, A MANUAL EXERCISE APPARATUS FOR BENEFITING THE BACK (U.S. CLS. 22, 23, 38 AND 50).

FIRST USE 3-0-2008; IN COMMERCE 3-0-2008.

CLASS 28—(Continued).

3,568,649. NEGRETE, RICHARD, EL SEGUNDO, CA. SN 78-854,315. PUB. 11-21-2006, FILED 4-5-2006.

ROCK OF AGES

THE MARK CONSISTS OF STANDARD CHARACTERS WITHOUT CLAIM TO ANY PARTICULAR FONT, STYLE, SIZE, OR COLOR.
FOR BOARD GAMES (U.S. CLS. 22, 23, 38 AND 50).
FIRST USE 9-19-2008; IN COMMERCE 10-15-2008.

3,568,659. PEARSON, MELANIE A., ANTELOPE, CA. AND PEARSON, KENT D., ANTELOPE, CA. SN 78-900,737. PUB. 7-17-2007, FILED 6-5-2006.



NO CLAIM IS MADE TO THE EXCLUSIVE RIGHT TO USE "GAMES", APART FROM THE MARK AS SHOWN.
FOR BOARD GAMES AND GAME TABLES (U.S. CLS. 22, 23, 38 AND 50).
FIRST USE 2-12-2006; IN COMMERCE 9-19-2006.

CLASS 29—MEATS AND PROCESSED FOODS

3,568,028. SAFEWAY INC., PLEASANTON, CA. SN 76-682,103. PUB. 7-8-2008, FILED 9-19-2007.

PARTY PLEASERS

THE MARK CONSISTS OF STANDARD CHARACTERS WITHOUT CLAIM TO ANY PARTICULAR FONT, STYLE, SIZE, OR COLOR.
NO CLAIM IS MADE TO THE EXCLUSIVE RIGHT TO USE "PARTY", APART FROM THE MARK AS SHOWN.
FOR CHEESE PLATTERS (U.S. CL. 46).
FIRST USE 11-2-2007; IN COMMERCE 11-2-2007.

CLASS 29—(Continued).

3,568,105. NEXT PHASE SOLUTIONS, LLC, PHOENIX, AZ. SN 77-092,293. PUB. 11-27-2007, FILED 1-26-2007.



NO CLAIM IS MADE TO THE EXCLUSIVE RIGHT TO USE "HOMESTYLE", APART FROM THE MARK AS SHOWN.
THE MARK CONSISTS OF A WOMAN WEARING AN APRON WITH A SUN BEHIND HER, HOLDING A PLATTER CONTAINING WORDS.
FOR FROZEN ENTREES CONSISTING PRIMARILY OF MEAT; FROZEN MEAT (U.S. CL. 46).
FIRST USE 10-0-2006; IN COMMERCE 10-0-2006.

3,568,158. LIPARI FOODS, INC., WARREN, MI. SN 77-133,208. PUB. 3-11-2008, FILED 3-16-2007.

THE ROMANCE OF CHEESE

THE MARK CONSISTS OF STANDARD CHARACTERS WITHOUT CLAIM TO ANY PARTICULAR FONT, STYLE, SIZE, OR COLOR.
NO CLAIM IS MADE TO THE EXCLUSIVE RIGHT TO USE "CHEESE", APART FROM THE MARK AS SHOWN.
FOR CHEESE (U.S. CL. 46).
FIRST USE 2-26-2007; IN COMMERCE 2-26-2007.

3,568,172. CONSERVAS ARTESANAS ROSARA, S.L., ANDOSILLA (NAVARRA), SPAIN. SN 77-147,449. PUB. 4-1-2008, FILED 4-3-2007.

KIT DE TAPAS

THE MARK CONSISTS OF STANDARD CHARACTERS WITHOUT CLAIM TO ANY PARTICULAR FONT, STYLE, SIZE, OR COLOR.

CLASS 29—(Continued).

NO CLAIM IS MADE TO THE EXCLUSIVE RIGHT TO USE "TAPAS", APART FROM THE MARK AS SHOWN.

FOR CANNED MEAT; CANNED FISH; CANNED VEGETABLES; CANNED FRUIT; PRESERVED, DRIED AND COOKED VEGETABLES; PREPARED ENTREES CONSISTING PRIMARILY OF MEAT, FISH, POULTRY OR VEGETABLES; JELLIES, NAMELY, BREAD SPREADS; JAMS; COMPOTES, EGGS; MILK; OLIVE OIL AND EDIBLE FAT (U.S. CL. 46).

FIRST USE 11-5-2007; IN COMMERCE 6-18-2007.

3,568,204. JOMARA SEAFOOD, INC, HIALEAH, FL. SN 77-176,868. PUB. 11-6-2007, FILED 5-9-2007.



NO CLAIM IS MADE TO THE EXCLUSIVE RIGHT TO USE "OCEAN TREATS PREMIUM SEAFOOD", APART FROM THE MARK AS SHOWN.

THE MARK CONSISTS OF A OCEAN WAVE AND HOOK WITH THE WORDS "OCEAN TREATS PREMIUM SEAFOOD".

FOR SEAFOOD (U.S. CL. 46).

FIRST USE 4-1-2008; IN COMMERCE 4-1-2008.

3,568,229. SKIPPACK CREEK CORPORATION, WILMINGTON, DE. SN 77-196,860. PUB. 3-25-2008, FILED 6-4-2007.



OWNER OF U.S. REG. NOS. 2,595,943 AND 3,011,371.

NO CLAIM IS MADE TO THE EXCLUSIVE RIGHT TO USE "STEAKHOUSE", APART FROM THE MARK AS SHOWN.

THE COLOR(S) BLUE, RED, GOLD, BLACK, AND WHITE IS/ARE CLAIMED AS A FEATURE OF THE MARK.

THE MARK CONSISTS OF A DEPICTION OF A BLUE LABEL OUTLINED WITH A THIN GOLD LINE, THEN A THIN BLUE LINE, THEN A WHITE LINE, AND LASTLY, AN OUTER THICKER GOLD LINE. THE MIDDLE OF THE LABEL CONTAINS A CURVED RED BANNER OUTLINED IN GOLD WITH THE WORD "STEAKHOUSE" IN WHITE PRINT, OUTLINED IN BLACK AND SHADOWED WITH

CLASS 29—(Continued).

GOLD. DIRECTLY ABOVE THIS CURVED BANNER IS A CURVED GOLD DOTTED HORIZONTAL LINE. BELOW THIS BANNER IS THE WORD "CLASSIC" IN WHITE SCRIPT, OUTLINED IN BLACK. THE TOP AND BOTTOM PARTS OF THE LABEL CONTAIN TWO GEOMETRIC DESIGN ELEMENTS. THE DESIGN CONSISTS OF TWO ISOSCELES RED TRIANGLES OUTLINED IN GOLD POINTING OUTWARD FROM A RED DIAMOND OUTLINED BY A GOLD DIAMOND AND SET WITHIN A GOLD OVAL.

FOR MEAT (U.S. CL. 46).

FIRST USE 5-0-2007; IN COMMERCE 5-0-2007.

3,568,369. KABUSHIKI KAISHA MITSUKAN GROUP HONSHA, AICHI-KEN, JAPAN. SN 77-291,337. PUB. 8-5-2008, FILED 9-28-2007.



THE COLOR(S) BLACK, WHITE AND RED IS/ARE CLAIMED AS A FEATURE OF THE MARK.

THE MARK CONSISTS OF JAPANESE CHARCTERS IN WHITE WITH RED SHADOWING ON A BLACK BACKGROUND.

THE TRANSLITERATED WORDING NIOWANATTO HAS NO MEANING IN A FOREIGN LANGUAGE.

THE NON-LATIN CHARACTERS IN THE MARK TRANSLITERATE TO NIOWANATTO.

FOR FERMENTED SOY BEANS (U.S. CL. 46).

FIRST USE 4-1-2000; IN COMMERCE 1-1-2008.

3,568,400. SPARBOE FARMS, INC., LITCHFIELD, MN. SN 77-300,311. PUB. 3-25-2008, FILED 10-10-2007.

We Love Eggs, and It Shows!

THE MARK CONSISTS OF STANDARD CHARACTERS WITHOUT CLAIM TO ANY PARTICULAR FONT, STYLE, SIZE, OR COLOR.

FOR EGGS (U.S. CL. 46).

FIRST USE 8-30-2008; IN COMMERCE 8-30-2008.

CLASS 29—(Continued).

3,568,552. DCI CHEESE COMPANY, INC., RICHFIELD, WI. SN 77-450,936. PUB. 8-19-2008, FILED 4-17-2008.

LE GRAND LUXE

THE MARK CONSISTS OF STANDARD CHARACTERS WITHOUT CLAIM TO ANY PARTICULAR FONT, STYLE, SIZE, OR COLOR.

THE FOREIGN WORD "LE" IN THE MARK TRANSLATES INTO ENGLISH AS "THE". THE FOREIGN WORD "LUXE" IN THE MARK TRANSLATES INTO ENGLISH AS "LUXURY".

FOR CHEESE (U.S. CL. 46).
FIRST USE 11-1-2008; IN COMMERCE 11-1-2008.

3,568,577. T.J. PUPILLO, INC., HARLEYSVILLE, PA. SN 78-395,463. PUB. 9-13-2005, FILED 4-2-2004.

SEASMART

THE MARK CONSISTS OF STANDARD CHARACTERS WITHOUT CLAIM TO ANY PARTICULAR FONT, STYLE, SIZE, OR COLOR.

FOR SALADS, EXCEPT MACARONI, RICE, AND PASTA SALAD; SEAFOOD-BASED SPREADS (U.S. CL. 46).

FIRST USE 12-2-2008; IN COMMERCE 12-2-2008.

3,568,595. VALCO ENTERPRISES, L.L.C., NEWARK, DE. SN 78-537,122. PUB. 9-13-2005, FILED 12-22-2004.

OTTAVIO SUMMUM

THE MARK CONSISTS OF STANDARD CHARACTERS WITHOUT CLAIM TO ANY PARTICULAR FONT, STYLE, SIZE, OR COLOR.

OWNER OF U.S. REG. NO. 2,406,777.

CLASS 29—(Continued).

THE NAME "OTTAVIO SUMMUM" DOES NOT IDENTIFY A LIVING INDIVIDUAL.

FOR OLIVE OIL AND SPECIALTY OLIVE OIL (U.S. CL. 46).
FIRST USE 11-29-2008; IN COMMERCE 11-29-2008.

3,568,602. HANSEL 'N GRETEL BRAND, INC., GLENDALE, NY. SN 78-611,220. PUB. 1-10-2006, FILED 4-18-2005.

ONCE TRIED NEVER DENIED

THE MARK CONSISTS OF STANDARD CHARACTERS WITHOUT CLAIM TO ANY PARTICULAR FONT, STYLE, SIZE, OR COLOR.

FOR PROCESSED MEATS (U.S. CL. 46).
FIRST USE 11-17-2008; IN COMMERCE 11-17-2008.

3,568,680. JENNIE-O TURKEY STORE, LLC, WILLMAR, MN. SN 78-934,633. PUB. 2-27-2007, FILED 7-21-2006.

FOOL-PROOF

THE MARK CONSISTS OF STANDARD CHARACTERS WITHOUT CLAIM TO ANY PARTICULAR FONT, STYLE, SIZE, OR COLOR.

OWNER OF U.S. REG. NO. 3,091,311.
FOR BEEF, PORK, PRIME RIB OF BEEF, ROAST BEEF (U.S. CL. 46).

FIRST USE 10-19-2007; IN COMMERCE 10-19-2007.

CLASS 30—STAPLE FOODS

3,568,016. JOORABCHI, REZA, WELLESLEY, MA. SN 76-673,210. PUB. 9-4-2007, FILED 2-26-2007.

QUEEN OF FRAGRANCE

THE MARK CONSISTS OF STANDARD CHARACTERS WITHOUT CLAIM TO ANY PARTICULAR FONT, STYLE, SIZE, OR COLOR.

FOR RICE (U.S. CL. 46).
FIRST USE 11-21-2008; IN COMMERCE 11-24-2008.

CLASS 30—(Continued).

3,568,153. NONNI'S FOOD COMPANY, INC., TULSA, OK. SN 77-131,167. PUB. 9-18-2007, FILED 3-14-2007.

Treat Yourself to a Nonni's Biscotti Break

THE MARK CONSISTS OF STANDARD CHARACTERS WITHOUT CLAIM TO ANY PARTICULAR FONT, STYLE, SIZE, OR COLOR.

OWNER OF U.S. REG. NOS. 1,727,905, 2,853,785, AND OTHERS.

FOR BAKERY GOODS, NAMELY, BISCOTTI (U.S. CL. 46).

FIRST USE 1-1-2007; IN COMMERCE 1-1-2007.

3,568,421. ORTEGA, RAFAEL, HOUSTON, TX. SN 77-317,344. PUB. 3-18-2008, FILED 10-30-2007.

El Ahorro

THE MARK CONSISTS OF STANDARD CHARACTERS WITHOUT CLAIM TO ANY PARTICULAR FONT, STYLE, SIZE, OR COLOR.

OWNER OF U.S. REG. NO. 3,301,559.

THE FOREIGN WORDING IN THE MARK TRANSLATES INTO ENGLISH AS THE SAVINGS.

FOR TORTILLA CHIPS; TORTILLA SHELLS; TORTILLAS (U.S. CL. 46).

FIRST USE 5-19-2007; IN COMMERCE 5-19-2007.

3,568,432. MECKEL, BARRETT T, WALTON, NY. SN 77-328,092. PUB. 4-29-2008, FILED 11-13-2007.

FLORN

THE MARK CONSISTS OF STANDARD CHARACTERS WITHOUT CLAIM TO ANY PARTICULAR FONT, STYLE, SIZE, OR COLOR.

FOR TORTILLA CHIPS; TORTILLA SHELLS; TORTILLAS; BREAD; BREAD DOUGHS; BREAD MIXES; BREAD ROLLS; FLOUR FOR FOOD (U.S. CL. 46).

FIRST USE 4-15-2000; IN COMMERCE 4-15-2000.

CLASS 30—(Continued).

3,568,480. BEYOND COFFEE & CAPPUCCINO LLC, FREDERICKSBURG, VA. SN 77-365,737. PUB. 5-27-2008, FILED 1-7-2008.

Full of Possibilities

THE MARK CONSISTS OF STANDARD CHARACTERS WITHOUT CLAIM TO ANY PARTICULAR FONT, STYLE, SIZE, OR COLOR.

FOR BEVERAGES MADE OF COFFEE; CAFFEINE-FREE COFFEE; COFFEE; COFFEE AND TEA; COFFEE BASED BEVERAGES; COFFEE BEANS; COFFEE BEVERAGES WITH MILK; COFFEE ESSENCES; COFFEE EXTRACTS; COFFEE FLAVORED SYRUP USED IN MAKING FOOD BEVERAGES; COFFEE-BASED BEVERAGE CONTAINING MILK; COFFEE-BASED BEVERAGES; INSTANT COFFEE; PREPARED COFFEE AND COFFEE-BASED BEVERAGES; ROASTED COFFEE BEANS; CAPPUCCINO (U.S. CL. 46).

FIRST USE 2-1-2008; IN COMMERCE 2-1-2008.

3,568,484. LACY, AUBREY, LAPLACE, LA. SN 77-369,700. PUB. 5-27-2008, FILED 1-11-2008.



NO CLAIM IS MADE TO THE EXCLUSIVE RIGHT TO USE "FOOD AND COMPANIES, LLC", APART FROM THE MARK AS SHOWN.

THE MARK CONSISTS OF TWO CHEF FIGURES, PUFFS OF STEAM, THE WORDS "ERMA & AL'S," A BANNER WITH THE WORDS, "FOODS AND COMPANIES, LLC" AND THE WORDS "AWESOME IN COMPARISON".

FOR STAPLE FOODS, NAMELY, SPICES (U.S. CL. 46). FIRST USE 6-1-2008; IN COMMERCE 7-25-2008.

CLASS 30—(Continued).

3,568,488. NV BISCUITS DELACRE SA, B-17002, BELGIUM. SN 77-372,776. PUB. 5-27-2008, FILED 1-16-2008.

GRAND PALACE

THE MARK CONSISTS OF STANDARD CHARACTERS WITHOUT CLAIM TO ANY PARTICULAR FONT, STYLE, SIZE, OR COLOR.

FOR BISCUITS, COOKIES, CHOCOLATE COVERED BISCUITS (U.S. CL. 46).

FIRST USE 8-1-2008; IN COMMERCE 8-1-2008.



3,568,555. POST FOODS, LLC, ST. LOUIS, MO. SN 77-463,149. PUB. 8-19-2008, FILED 5-1-2008.

JUST BUNCHES!

THE MARK CONSISTS OF STANDARD CHARACTERS WITHOUT CLAIM TO ANY PARTICULAR FONT, STYLE, SIZE, OR COLOR.

FOR BREAKFAST CEREALS (U.S. CL. 46).

FIRST USE 6-1-2008; IN COMMERCE 6-1-2008.



3,568,562. NEST NATURALS, INC., EMERYVILLE, CA. SN 77-499,963. PUB. 9-2-2008, FILED 6-16-2008.

JAMMY SAMMY

THE MARK CONSISTS OF STANDARD CHARACTERS WITHOUT CLAIM TO ANY PARTICULAR FONT, STYLE, SIZE, OR COLOR.

FOR GRAIN-BASED FOOD BARS CONTAINING FRUITS AND NUTS (U.S. CL. 46).

FIRST USE 10-16-2008; IN COMMERCE 10-16-2008.

CLASS 30—(Continued).

3,568,591. INGENIO DEL CAUCA S.A., VALLE DEL CAUCA, COLOMBIA. SN 78-489,438. PUB. 1-31-2006, FILED 9-24-2004.



THE MARK CONSISTS OF A FIGURE IN FRONT OF THE STYLIZED AND UNDERLINED WORD "INCAUCA".

FOR SUGAR, NATURAL SWEETENERS, SUGAR PRODUCTS, NAMELY, WHITE SUGAR, BROWN SUGAR, DEMERARA SUGAR; SUGARED MIXES COMPOSED PRIMARILY OF SUGAR AND SMALL AMOUNTS OF ARTIFICIAL OR NATURAL SWEETENERS, NATURAL LOW CALORIE SWEETENERS; LIGHT SUGARS (U.S. CL. 46).

FIRST USE 0-0-1993; IN COMMERCE 4-0-2008.



3,568,638. HI LIMITED PARTNERSHIP, CLEARWATER, FL. SN 78-800,328. PUB. 9-12-2006, FILED 1-26-2006.

Hooters

THE MARK CONSISTS OF STANDARD CHARACTERS WITHOUT CLAIM TO ANY PARTICULAR FONT, STYLE, SIZE, OR COLOR.

OWNER OF U.S. REG. NOS. 1,557,380, 3,043,735, AND OTHERS.

FOR SAUCES (U.S. CL. 46).

FIRST USE 3-27-1983; IN COMMERCE 3-27-1983.



CLASS 31—NATURAL AGRICULTURAL PRODUCTS

CLASS 31—(Continued).

3,568,073. POET RESEARCH, INC., SIOUX FALLS, SD. SN 77-052,048. PUB. 11-13-2007, FILED 11-28-2006.



THE MARK CONSISTS OF A STYLIZED LETTER "O" WHICH RESEMBLES A LEAF.
FOR FEED FOR ANIMALS; UNPROCESSED DISTILLERS GRAINS (U.S. CLS. 1 AND 46).
FIRST USE 7-1-2007; IN COMMERCE 7-1-2007.

3,568,286. MARS, INCORPORATED, MCLEAN, VA. SN 77-253,480. PUB. 3-4-2008, FILED 8-13-2007.



OWNER OF U.S. REG. NO. 2,073,460.
NO CLAIM IS MADE TO THE EXCLUSIVE RIGHT TO USE "DEVELOPED WITH VETERANS", APART FROM THE MARK AS SHOWN.
THE MARK CONSISTS OF TWO CIRCLES; THE SMALLER CIRCLE HAS AN EQUAL-ARMED CROSS IN THE MIDDLE AND IS INSIDE OF A LARGER CIRCLE. THE LARGER CIRCLE APPEARS WITH THE WORDS "DEVELOPED WITH VETERINARIANS" WHICH WRAPS AROUND THE SMALLER CIRCLE.
FOR PET FOOD (U.S. CLS. 1 AND 46).
FIRST USE 1-0-2008; IN COMMERCE 1-0-2008.

CLASS 31—(Continued).

3,568,329. DELANO FARMS COMPANY, DELANO, CA. SN 77-277,697. PUB. 3-4-2008, FILED 9-12-2007.

ON THE GO GRAPES

THE MARK CONSISTS OF STANDARD CHARACTERS WITHOUT CLAIM TO ANY PARTICULAR FONT, STYLE, SIZE, OR COLOR.

NO CLAIM IS MADE TO THE EXCLUSIVE RIGHT TO USE "GRAPES", APART FROM THE MARK AS SHOWN.
FOR FRESH FRUIT, NAMELY, GRAPES (U.S. CLS. 1 AND 46).
FIRST USE 8-8-2008; IN COMMERCE 8-8-2008.

3,568,377. CHANEY, KELLY COSTELLO, PITTSBURGH, PA. SN 77-293,884. PUB. 3-18-2008, FILED 10-2-2007.



NO CLAIM IS MADE TO THE EXCLUSIVE RIGHT TO USE "PUPPY", APART FROM THE MARK AS SHOWN.
THE COLOR(S) BROWN, WHITE, PINK, YELLOW, AND BLACK IS/ARE CLAIMED AS A FEATURE OF THE MARK.
THE MARK CONSISTS OF A STYLIZED BROWN AND WHITE WORD "PUPPY" TO THE LEFT OF A STYLIZED PINK AND WHITE WORD "CAKE" IN FRONT OF A PINK BOWL CONTAINING A YELLOW CAKE WITH WHITE FROSTING AND A BONE. THE STYLIZED WORD "MIX" IN WHITE AND PINK IS LOCATED BELOW THE BOWL. THE INSIDE OF THE BOWL, THE OUTLINE OF THE BOWL, AND THE OUTLINE OF THE BONE APPEAR IN BLACK.
FOR DOG TREATS (U.S. CLS. 1 AND 46).
FIRST USE 11-1-2007; IN COMMERCE 11-14-2007.

3,568,453. BLUE BUFFALO COMPANY, LLC, WILTON, CT. SN 77-338,862. PUB. 4-29-2008, FILED 11-28-2007.



OWNER OF U.S. REG. NO. 3,248,022.

CLASS 31—(Continued).

NO CLAIM IS MADE TO THE EXCLUSIVE RIGHT TO USE "CO.", APART FROM THE MARK AS SHOWN.

THE MARK CONSISTS OF A DIAMOND-SHAPED LOGO DEPICTING THE WORD "BLUE" IN CONNECTION WITH A BUFFALO DESIGN ABOVE THE WORD "LONGEVITY". FOR CAT FOOD; CAT TREATS; DOG BISCUITS; DOG FOOD; DOG TREATS; PET BEVERAGES (U.S. CLS. 1 AND 46).

FIRST USE 10-0-2008; IN COMMERCE 10-0-2008.

3,568,500. ELSNER PAC JUNGPFANZEN GBR, DRESDEN, FED REP GERMANY. SN 77-388,713. PUB. 7-22-2008, FILED 2-5-2008.

CANDY FLOWERS

THE MARK CONSISTS OF STANDARD CHARACTERS WITHOUT CLAIM TO ANY PARTICULAR FONT, STYLE, SIZE, OR COLOR.

NO CLAIM IS MADE TO THE EXCLUSIVE RIGHT TO USE "FLOWERS", APART FROM THE MARK AS SHOWN. FOR LIVE PLANTS AND NATURAL FLOWERS THEREOF (U.S. CLS. 1 AND 46).

FIRST USE 9-29-2008; IN COMMERCE 9-29-2008.

CLASS 32—LIGHT BEVERAGES

3,568,038. NICK STAFFORD AND SALLY STAFFORD, TA HAMBLETON ALES, NORTH YORKSHIRE, UNITED KINGDOM. SN 77-003,671. PUB. 1-8-2008, FILED 9-20-2006.



PRIORITY CLAIMED UNDER SEC. 44(D) ON UNITED KINGDOM APPLICATION NO. 2427646, FILED 7-20-2006.

NO CLAIM IS MADE TO THE EXCLUSIVE RIGHT TO USE "HAMBLETON ALES", APART FROM THE MARK AS SHOWN.

THE NAME "NICK STAFFORD" IDENTIFIES A LIVING INDIVIDUAL WHOSE CONSENT IS OF RECORD.

THE MARK CONSISTS OF SQUARE SHAPE WITH A SILHOUETTE OF A HORSE AND THE WORDS "NICK STAFFORD'S HAMBLETON ALES".

FOR BEER, ALE AND PORTER (U.S. CLS. 45, 46 AND 48).

FIRST USE 9-0-1999; IN COMMERCE 9-0-1999.

CLASS 32—(Continued).

3,568,093. PABST BREWING COMPANY, SAN ANTONIO, TX. SN 77-078,301. PUB. 6-5-2007, FILED 1-8-2007.

BEER BUILT RIGHT

THE MARK CONSISTS OF STANDARD CHARACTERS WITHOUT CLAIM TO ANY PARTICULAR FONT, STYLE, SIZE, OR COLOR.

NO CLAIM IS MADE TO THE EXCLUSIVE RIGHT TO USE "BEER", APART FROM THE MARK AS SHOWN. FOR BEER (U.S. CLS. 45, 46 AND 48).

FIRST USE 11-25-2008; IN COMMERCE 11-25-2008.

3,568,227. SUNOPTA, INC., ONTARIO, CANADA. SN 77-195,791. PUB. 12-4-2007, FILED 6-1-2007.

OPTA ENERGY

THE MARK CONSISTS OF STANDARD CHARACTERS WITHOUT CLAIM TO ANY PARTICULAR FONT, STYLE, SIZE, OR COLOR.

NO CLAIM IS MADE TO THE EXCLUSIVE RIGHT TO USE "ENERGY", APART FROM THE MARK AS SHOWN. FOR ORGANIC ENERGY DRINKS (U.S. CLS. 45, 46 AND 48).

FIRST USE 9-27-2007; IN COMMERCE 9-27-2007.

3,568,324. SEA BREEZE FRUIT FLAVORS, INC., TOWACO, NJ. SN 77-275,647. PUB. 3-18-2008, FILED 9-10-2007.

SEA BREEZE WATERS

THE MARK CONSISTS OF STANDARD CHARACTERS WITHOUT CLAIM TO ANY PARTICULAR FONT, STYLE, SIZE, OR COLOR.

NO CLAIM IS MADE TO THE EXCLUSIVE RIGHT TO USE "WATERS", APART FROM THE MARK AS SHOWN. FOR CONCENTRATES USED TO PREPARE SOFT DRINKS (U.S. CLS. 45, 46 AND 48).

FIRST USE 10-1-2008; IN COMMERCE 10-1-2008.

CLASS 32—(Continued).

3,568,426. PALE HORSE BREWING COMPANY, SALEM, OR.
SN 77-320,965. PUB. 4-15-2008, FILED 11-5-2007.

HILLBILLY BLONDE

THE MARK CONSISTS OF STANDARD CHARACTERS WITHOUT CLAIM TO ANY PARTICULAR FONT, STYLE, SIZE, OR COLOR.

NO CLAIM IS MADE TO THE EXCLUSIVE RIGHT TO USE "BLONDE", APART FROM THE MARK AS SHOWN.

FOR ALE (U.S. CLS. 45, 46 AND 48).
FIRST USE 12-8-2008; IN COMMERCE 12-8-2008.

3,568,536. BARD'S TALE BEER COMPANY, LLC, EDINA, MN. SN 77-428,609. PUB. 8-5-2008, FILED 3-21-2008.



OWNER OF U.S. REG. NO. 3,211,334.
THE MARK CONSIST OF AN UPRAISED HUMAN HAND HOLDING A BOTTLE OF "BARD'S BEER".
FOR BEER (U.S. CLS. 45, 46 AND 48).
FIRST USE 11-30-2008; IN COMMERCE 11-30-2008.

3,568,594. POMWONDERFUL LLC, LOS ANGELES, CA. SN 78-534,906. PUB. 9-27-2005, FILED 12-17-2004.

THE POWER OF POMEGRANATE JUICE

THE MARK CONSISTS OF STANDARD CHARACTERS WITHOUT CLAIM TO ANY PARTICULAR FONT, STYLE, SIZE, OR COLOR.

CLASS 32—(Continued).

NO CLAIM IS MADE TO THE EXCLUSIVE RIGHT TO USE "POMEGRANATE JUICE", APART FROM THE MARK AS SHOWN.

FOR FRUIT JUICES, FRUIT DRINKS, FRUIT JUICE CONCENTRATES, FRUIT SMOOTHIES, FRUIT-FLAVORED DRINKING WATER, SPORTS DRINKS, ENERGY DRINKS, NON-CARBONATED SOFT DRINKS, ALL MADE IN WHOLE OR SIGNIFICANT PART OF POMEGRANATE JUICE (U.S. CLS. 45, 46 AND 48).

FIRST USE 9-1-2006; IN COMMERCE 9-1-2006.

CLASS 33—WINES AND SPIRITS

3,568,017. PROKUPAC A.D., PROKUPLJE, SERBIA/MONTE-NEGRO. SN 76-673,537. PUB. 9-11-2007, FILED 3-2-2007.

STOMAKLIJA

FOR BRANDY (U.S. CLS. 47 AND 49).
FIRST USE 3-1-2008; IN COMMERCE 3-1-2008.

3,568,027. VAN RUITEN FAMILY WINERY, LLC, LODI, CA. SN 76-681,579. PUB. 3-4-2008, FILED 9-6-2007.

GLORY DAYS

THE MARK CONSISTS OF STANDARD CHARACTERS WITHOUT CLAIM TO ANY PARTICULAR FONT, STYLE, SIZE, OR COLOR.

FOR WINE (U.S. CLS. 47 AND 49).
FIRST USE 5-1-2008; IN COMMERCE 5-1-2008.

3,568,043. SAZERAC COMPANY, INC., NEW ORLEANS, LA. SN 77-009,717. PUB. 4-10-2007, FILED 9-28-2006.

RAIN RENEWS

THE MARK CONSISTS OF STANDARD CHARACTERS WITHOUT CLAIM TO ANY PARTICULAR FONT, STYLE, SIZE, OR COLOR.

OWNER OF U.S. REG. NOS. 2,438,707 AND 2,541,274.
FOR VODKA (U.S. CLS. 47 AND 49).
FIRST USE 2-0-2008; IN COMMERCE 2-0-2008.

CLASS 33—(Continued).

3,568,118. GOLDEN EAGLE ESTATES, LLC, MURPHYS, CA.
SN 77-102,472. PUB. 9-11-2007, FILED 2-8-2007.

DANZA ROJA

THE MARK CONSISTS OF STANDARD CHARACTERS WITHOUT CLAIM TO ANY PARTICULAR FONT, STYLE, SIZE, OR COLOR.

NO CLAIM IS MADE TO THE EXCLUSIVE RIGHT TO USE "ROJA", APART FROM THE MARK AS SHOWN.

THE ENGLISH TRANSLATION OF THE WORD "DANZA ROJA" IN THE MARK IS "DANCING RED".

FOR WINES (U.S. CLS. 47 AND 49).

FIRST USE 12-1-2006; IN COMMERCE 12-1-2006.

3,568,119. GOLDEN EAGLE ESTATES, LLC, MURPHYS, CA.
SN 77-102,494. PUB. 9-11-2007, FILED 2-8-2007.

DANZA BLANCA

THE MARK CONSISTS OF STANDARD CHARACTERS WITHOUT CLAIM TO ANY PARTICULAR FONT, STYLE, SIZE, OR COLOR.

NO CLAIM IS MADE TO THE EXCLUSIVE RIGHT TO USE "BLANC", APART FROM THE MARK AS SHOWN.

THE ENGLISH TRANSLATION OF THE WORD "DANZA BLANCA" IN THE MARK IS "DANCING WHITE".

FOR WINES (U.S. CLS. 47 AND 49).

FIRST USE 4-1-2007; IN COMMERCE 4-1-2007.

3,568,257. GONZALEZ, FRANCISCO, CASTAIC, CA. AND
GONZALEZ, JOSE A., CASTAIC, CA. SN 77-228,215. PUB.
11-27-2007, FILED 7-12-2007.

El Cucuy

THE MARK CONSISTS OF STANDARD CHARACTERS WITHOUT CLAIM TO ANY PARTICULAR FONT, STYLE, SIZE, OR COLOR.

THE FOREIGN WORDING IN THE MARK TRANSLATES INTO ENGLISH AS THE BOOGIEMAN.

FOR TEQUILA (U.S. CLS. 47 AND 49).

FIRST USE 11-1-2008; IN COMMERCE 11-1-2008.

CLASS 33—(Continued).

3,568,275. BROWN-FORMAN CORPORATION, LOUISVILLE, KY. SN 77-243,340. PUB. 1-22-2008, FILED 7-31-2007.

HOW REFRESHING

THE MARK CONSISTS OF STANDARD CHARACTERS WITHOUT CLAIM TO ANY PARTICULAR FONT, STYLE, SIZE, OR COLOR.

FOR WINES (U.S. CLS. 47 AND 49).

FIRST USE 4-16-2008; IN COMMERCE 4-16-2008.

3,568,277. FETZER VINEYARDS, HOPLAND, CA. SN 77-244,316. PUB. 1-22-2008, FILED 8-1-2007.

SAVE A GODDESS

THE MARK CONSISTS OF STANDARD CHARACTERS WITHOUT CLAIM TO ANY PARTICULAR FONT, STYLE, SIZE, OR COLOR.

FOR ALCOHOLIC BEVERAGES, NAMELY, WINE (U.S. CLS. 47 AND 49).

FIRST USE 9-27-2007; IN COMMERCE 9-27-2007.

3,568,319. FOSTER'S WINE ESTATES AMERICAS COMPANY, NAPA, CA. SN 77-272,190. PUB. 2-19-2008, FILED 9-5-2007.

BERTHA'S VINEYARD

THE MARK CONSISTS OF STANDARD CHARACTERS WITHOUT CLAIM TO ANY PARTICULAR FONT, STYLE, SIZE, OR COLOR.

NO CLAIM IS MADE TO THE EXCLUSIVE RIGHT TO USE "VINEYARD", APART FROM THE MARK AS SHOWN.

FOR WINE (U.S. CLS. 47 AND 49).

FIRST USE 9-30-2008; IN COMMERCE 10-21-2008.

CLASS 33—(Continued).

3,568,408. DENDINORA LLC, ANGWIN, CA. SN 77-307,756.
PUB. 4-1-2008, FILED 10-18-2007.

KIND CELLARS

THE MARK CONSISTS OF STANDARD CHARACTERS WITHOUT CLAIM TO ANY PARTICULAR FONT, STYLE, SIZE, OR COLOR.

NO CLAIM IS MADE TO THE EXCLUSIVE RIGHT TO USE "CELLARS", APART FROM THE MARK AS SHOWN. FOR WINE (U.S. CLS. 47 AND 49).

FIRST USE 8-1-2008; IN COMMERCE 8-1-2008.

3,568,469. BODEGAS EMILIO MORO, S.L., DE DUERO 47315, SPAIN. SN 77-357,071. PUB. 5-13-2008, FILED 12-20-2007.

FINCA RESALSO

THE MARK CONSISTS OF STANDARD CHARACTERS WITHOUT CLAIM TO ANY PARTICULAR FONT, STYLE, SIZE, OR COLOR.

OWNER OF U.S. REG. NO. 2,899,686.

NO CLAIM IS MADE TO THE EXCLUSIVE RIGHT TO USE "FINCA", APART FROM THE MARK AS SHOWN.

THE FOREIGN WORDING IN THE MARK TRANSLATES INTO ENGLISH AS "ESTATE". THE WORD "RESALSO" HAS NO MEANING OTHER THAN TRADEMARK SIGNIFICANCE.

FOR ALCOHOLIC BEVERAGES, NAMELY, WINES (U.S. CLS. 47 AND 49).

FIRST USE 0-0-1998; IN COMMERCE 1-0-1999.

3,568,470. BODEGAS EMILIO MORO, S.L., DE DUERO 47315, SPAIN. SN 77-357,112. PUB. 5-13-2008, FILED 12-20-2007.

MALLEOLUS DE SANCHOMARTIN

THE MARK CONSISTS OF STANDARD CHARACTERS WITHOUT CLAIM TO ANY PARTICULAR FONT, STYLE, SIZE, OR COLOR.

OWNER OF U.S. REG. NOS. 2,843,846 AND 2,879,426.

THE WORDING "MALLEOLUS DE SANCHOMARTIN" HAS NO MEANING OTHER THAN TRADEMARK SIGNIFICANCE.

FOR ALCOHOLIC BEVERAGES, NAMELY, WINES (U.S. CLS. 47 AND 49).

FIRST USE 1-0-2002; IN COMMERCE 0-0-2002.

CLASS 33—(Continued).

3,568,523. DESTILADORA DE LOS ALTOS S.A. DE C.V., ARANDAS, MEXICO. SN 77-414,916. PUB. 7-22-2008, FILED 3-6-2008.

HACIENDA VIEJA

THE MARK CONSISTS OF STANDARD CHARACTERS WITHOUT CLAIM TO ANY PARTICULAR FONT, STYLE, SIZE, OR COLOR.

OWNER OF U.S. REG. NO. 2,816,547.

THE FOREIGN WORDING IN THE MARK TRANSLATES INTO ENGLISH AS "OLD RANCH"

FOR ALCOHOLIC BEVERAGES, NAMELY, BEVERAGES DERIVED FROM THE AGAVE PLANT; TEQUILA; DISTILLED SPIRITS OF THE AGAVE PLANT (U.S. CLS. 47 AND 49).

FIRST USE 8-8-2008; IN COMMERCE 8-8-2008.

3,568,556. BARONESS SMALL ESTATES, INC., DENVER, CO. SN 77-469,167. PUB. 8-26-2008, FILED 5-8-2008.



THE MARK CONSISTS OF THE TEXT "RHEA" UNDERNEATH A STYLIZED GROUP OF HILLS AND VALLEY COMPOSED OF CURVED LINES AND SHADING.

FOR RED WINE; WHITE WINE; WINES (U.S. CLS. 47 AND 49).

FIRST USE 8-21-2008; IN COMMERCE 8-21-2008.

3,568,557. BARONESS SMALL ESTATES, INC., DENVER, CO. SN 77-470,798. PUB. 8-26-2008, FILED 5-9-2008.

IL MURETTO

THE MARK CONSISTS OF STANDARD CHARACTERS WITHOUT CLAIM TO ANY PARTICULAR FONT, STYLE, SIZE, OR COLOR.

THE ENGLISH TRANSLATION OF THE WORD "IL MURETTO" IN THE MARK IS "THE WALL".

FOR RED WINE; WINES (U.S. CLS. 47 AND 49).

FIRST USE 10-2-2008; IN COMMERCE 10-2-2008.

CLASS 33—(Continued).

3,568,558. BARONESS SMALL ESTATES, INC., DENVER, CO. SN 77-474,798. PUB. 8-26-2008, FILED 5-15-2008.

VIA LATTEA

THE MARK CONSISTS OF STANDARD CHARACTERS WITHOUT CLAIM TO ANY PARTICULAR FONT, STYLE, SIZE, OR COLOR.
THE FOREIGN WORDING IN THE MARK TRANSLATES INTO ENGLISH AS MILKY WAY.
FOR RED WINE; WHITE WINE; WINES (U.S. CLS. 47 AND 49).
FIRST USE 11-13-2008; IN COMMERCE 11-13-2008.

SERVICE MARKS

CLASS 35—ADVERTISING AND BUSINESS

3,567,994. AMERICAN FARM BUREAU FEDERATION, WASHINGTON, DC. SN 76-558,727. PUB. 12-20-2005, FILED 11-13-2003.

FB APPAREL

THE MARK CONSISTS OF STANDARD CHARACTERS WITHOUT CLAIM TO ANY PARTICULAR FONT, STYLE, SIZE, OR COLOR.
NO CLAIM IS MADE TO THE EXCLUSIVE RIGHT TO USE "APPAREL", APART FROM THE MARK AS SHOWN.
FOR RETAIL CLOTHING STORE SERVICES RENDERED THROUGH THE INTERNET (U.S. CLS. 100, 101 AND 102).
FIRST USE 7-1-2003; IN COMMERCE 7-1-2003.

3,568,032. MILITARY OFFICERS ASSOCIATION OF AMERICA, ALEXANDRIA, VA. SN 76-684,516. PUB. 4-29-2008, FILED 11-30-2007.

THINKING ABOUT YOUR NEXT CAREER? SO ARE WE

THE MARK CONSISTS OF STANDARD CHARACTERS WITHOUT CLAIM TO ANY PARTICULAR FONT, STYLE, SIZE, OR COLOR.
FOR PROVIDING INFORMATION ON MILITARY CAREER CHANGES AND OPTIONS (U.S. CLS. 100, 101 AND 102).
FIRST USE 11-15-2007; IN COMMERCE 11-15-2007.

CLASS 35—(Continued).

3,568,035. ADVANCE MAGAZINE PUBLISHERS INC., NEW YORK, NY. SN 76-686,717. PUB. 5-13-2008, FILED 2-11-2008.

WOMEN DOING GOOD

THE MARK CONSISTS OF STANDARD CHARACTERS WITHOUT CLAIM TO ANY PARTICULAR FONT, STYLE, SIZE, OR COLOR.
FOR ORGANIZING, HOSTING, ARRANGING AND PROMOTING MARKETING PROMOTIONAL EVENTS AND CONTESTS FOR OTHERS (U.S. CLS. 100, 101 AND 102).
FIRST USE 9-24-2008; IN COMMERCE 9-24-2008.

3,568,036. SERVICES GROUP OF AMERICA, INC., SCOTTSDALE, AZ. SN 77-003,223. PUB. 8-28-2007, FILED 9-20-2006.



SYSTEMS SERVICES
of AMERICA

NO CLAIM IS MADE TO THE EXCLUSIVE RIGHT TO USE "SERVICES" AND "AMERICA", APART FROM THE MARK AS SHOWN.
FOR DISTRIBUTORSHIP SERVICES FOR FOODS PACKAGED, MANUFACTURED, AND PREPARED BY OTHERS (U.S. CLS. 100, 101 AND 102).
FIRST USE 11-17-2006; IN COMMERCE 11-17-2006.

3,568,037. SERVICES GROUP OF AMERICA, INC., SCOTTSDALE, AZ. SN 77-003,225. PUB. 8-28-2007, FILED 9-20-2006.



SYSTEMS SERVICES
of AMERICA

NO CLAIM IS MADE TO THE EXCLUSIVE RIGHT TO USE "SERVICES" AND "AMERICA", APART FROM THE MARK AS SHOWN.
FOR DISTRIBUTORSHIP SERVICES FOR FOODS PACKAGED, MANUFACTURED, AND PREPARED BY OTHERS (U.S. CLS. 100, 101 AND 102).
FIRST USE 11-17-2006; IN COMMERCE 11-17-2006.

CLASS 35—(Continued).

3,568,044. NATIONAL HEARING CENTERS, INC., PLYMOUTH, MN. SN 77-011,884. PUB. 3-25-2008, FILED 10-2-2006.

YOU CAN HEAR BETTER

THE MARK CONSISTS OF STANDARD CHARACTERS WITHOUT CLAIM TO ANY PARTICULAR FONT, STYLE, SIZE, OR COLOR.

FOR RETAIL STORE SERVICES FEATURING AUDIOLOGY PRODUCTS (U.S. CLS. 100, 101 AND 102). FIRST USE 3-23-2007; IN COMMERCE 3-23-2007.

3,568,058. TERRA RESORT GROUP LLC, TETON VILLAGE, WY. SN 77-025,196. PUB. 1-1-2008, FILED 10-19-2006.

Terra Resort Group

THE MARK CONSISTS OF STANDARD CHARACTERS WITHOUT CLAIM TO ANY PARTICULAR FONT, STYLE, SIZE, OR COLOR.

NO CLAIM IS MADE TO THE EXCLUSIVE RIGHT TO USE "RESORT GROUP", APART FROM THE MARK AS SHOWN.

FOR ADMINISTRATIVE HOTEL MANAGEMENT; BUSINESS MANAGEMENT OF HOTELS FOR OTHERS; HOTEL MANAGEMENT FOR OTHERS; MANAGEMENT OF HOTEL INCENTIVE PROGRAMS OF OTHERS; MANAGING AND OPERATING RESORT HOTELS, BUT NOT RESTAURANT SERVICES, AND BUSINESS CONFERENCE CENTERS OF OTHERS (U.S. CLS. 100, 101 AND 102).

FIRST USE 12-22-2006; IN COMMERCE 12-22-2006.

CLASS 35—(Continued).

3,568,065. CTRAC COMPUTER SERVICES, INC., DBA C.TRAC INFORMATION SOLUTIONS, STRONGSVILLE, OH. SN 77-042,791. PUB. 6-19-2007, FILED 11-13-2006.

QUAL.TRAC

THE MARK CONSISTS OF STANDARD CHARACTERS WITHOUT CLAIM TO ANY PARTICULAR FONT, STYLE, SIZE, OR COLOR.

FOR MANAGEMENT AND COMPILATION OF COMPUTERIZED DATABASES; DIRECT MARKETING SERVICES; MARKET RESEARCH CONSULTATION; MARKET RESEARCH SERVICES; ADVICE ON THE ANALYSIS OF CONSUMER BUYING HABITS AND NEEDS PROVIDED WITH THE HELP OF SENSORY, QUALITY AND QUANTITY-RELATED DATA; ASSISTANCE, ADVISORY SERVICES AND CONSULTANCY WITH REGARD TO BUSINESS PLANNING, BUSINESS ANALYSIS, BUSINESS MANAGEMENT, AND BUSINESS ORGANIZATION; BUSINESS ADVICE AND ANALYSIS OF MARKETS; BUSINESS RESEARCH SERVICES, NAMELY, PROVIDING ANALYSIS OF RETAIL DATA ON SPECIFIC BUSINESS LOCATIONS AND MARKET ANALYSIS (U.S. CLS. 100, 101 AND 102).

FIRST USE 10-1-2008; IN COMMERCE 10-1-2008.

3,568,068. EPIC MEDIA GROUP LLC, EL SEGUNDO, CA. SN 77-045,506. PUB. 6-5-2007, FILED 11-16-2006.

REACH PEOPLE WHERE THEY
LIVE, WORK AND PLAY

THE MARK CONSISTS OF STANDARD CHARACTERS WITHOUT CLAIM TO ANY PARTICULAR FONT, STYLE, SIZE, OR COLOR.

FOR PROMOTIONAL, MARKETING AND ADVERTISING SERVICES USING LARGE SIGNAGE (U.S. CLS. 100, 101 AND 102).

FIRST USE 10-22-2008; IN COMMERCE 10-22-2008.

CLASS 35—(Continued).

3,568,070. ANDREA OBSTON MARKETING COMMUNICATIONS, LLC, BLOOMFIELD, CT. SN 77-047,946. PUB. 1-15-2008, FILED 11-20-2006.

B2E - STRATEGICALLY
CONNECTING YOUR BUSINESS
TO EVERYONE

THE MARK CONSISTS OF STANDARD CHARACTERS WITHOUT CLAIM TO ANY PARTICULAR FONT, STYLE, SIZE, OR COLOR.

FOR ADVERTISING, MARKETING AND PUBLICITY SERVICES, NAMELY, STRATEGIC MARKETING AUDITS, BRAND DEVELOPMENT AND MARKETING, PUBLIC AND MEDIA RELATIONS, BUSINESS CONSULTATION RELATING TO CRISIS PLANNING AND MANAGEMENT, WEBSITES AND INTERNET ADVERTISING AND RELATIONS WITH MEDIA OUTLETS (U.S. CLS. 100, 101 AND 102).

FIRST USE 9-20-2006; IN COMMERCE 9-20-2006.

3,568,074. POET RESEARCH, INC., SIOUX FALLS, SD. SN 77-052,137. PUB. 11-13-2007, FILED 11-28-2006.



THE MARK CONSISTS OF A STYLIZED LETTER "O" WHICH RESEMBLES A LEAF.

FOR MANAGEMENT OF FACILITIES FOR OTHERS IN THE FIELDS OF ETHANOL, BIO-REFINERIES, GRAIN FRACTIONATION, VEGETABLE OIL EXTRACTION, SEED PRODUCTION, GRAIN STORAGE, BUSINESS MARKETING CONSULTING SERVICES IN THE FIELDS OF ETHANOL, CARBON DIOXIDE (CO₂), GRAIN, CO-PRODUCTS, FEED, BIO-FUELS VEGETABLE OILS, AND INDUSTRIAL CHEMICALS (U.S. CLS. 100, 101 AND 102).

FIRST USE 7-0-2007; IN COMMERCE 7-0-2007.

3,568,087. WERNER ENTERPRISES, INC., OMAHA, NE. SN 77-075,237. PUB. 3-4-2008, FILED 1-3-2007.



NO CLAIM IS MADE TO THE EXCLUSIVE RIGHT TO USE "LOGISTICS", APART FROM THE MARK AS SHOWN. THE COLOR(S) BLUE, WHITE AND YELLOW IS/ARE CLAIMED AS A FEATURE OF THE MARK.

CLASS 35—(Continued).

THE MARK CONSISTS OF THE STYLIZED WORDS "WERNER GLOBAL LOGISTICS" WITH A FANCIFUL DESIGN OF A GLOBE AS THE LETTER "O" IN THE WORD "GLOBAL" AND THE WORDS "LOCAL LOGISTICS, APPLIED WORLDWIDE" APPEARING WITHIN A FANCIFUL ARROW DESIGN. THE WORD "WERNER" IS YELLOW. THE LETTERS "GL" AND "BAL" AND THE WORD "LOGISTICS" ARE BLUE. THE GLOBE IS BLUE WITH LIGHT BLUE AND WHITE CONTINENTS. THE WORDING "LOCAL LOGISTICS, APPLIED WORLDWIDE" IS WHITE. THE ARROW DESIGN APPEARS IN THREE SHADES OF BLUE.

FOR TRANSPORTATION LOGISTICS SERVICES, NAMELY, ARRANGING THE TRANSPORTATION OF GOODS FOR OTHERS (U.S. CLS. 100, 101 AND 102).

FIRST USE 6-30-2006; IN COMMERCE 6-30-2006.

3,568,095. GM WORLDWIDE ENTERTAINMENT, INC., LAS VEGAS, NV. SN 77-079,565. PUB. 3-18-2008, FILED 1-10-2007.



NO CLAIM IS MADE TO THE EXCLUSIVE RIGHT TO USE "WORLDWIDE ENTERTAINMENT", APART FROM THE MARK AS SHOWN.

THE MARK CONSISTS OF A GLOBE DESIGN, THE LETTERS "GM" IN A STYLIZED FONT AND THE WORDS "WORLDWIDE ENTERTAINMENT"

FOR TALENT CONSULTANT SERVICES, NAMELY, REPRESENTATION OF ALL TYPES OF CREATIVE TALENT (U.S. CLS. 100, 101 AND 102).

FIRST USE 12-1-2007; IN COMMERCE 12-1-2007.

3,568,097. MAZZEI, SARAH E., CHANDLER, AZ. SN 77-082,550. PUB. 8-28-2007, FILED 1-13-2007.

BikerLicious

THE MARK CONSISTS OF STANDARD CHARACTERS WITHOUT CLAIM TO ANY PARTICULAR FONT, STYLE, SIZE, OR COLOR.

FOR ONLINE RETAIL APPAREL STORE (U.S. CLS. 100, 101 AND 102).

FIRST USE 1-1-2007; IN COMMERCE 4-26-2007.

CLASS 35—(Continued).

3,568,100. IMPERIAL BIRD'S NEST INTERNATIONAL CO. LIMITED, MONGKOK, KOWLOON, HONG KONG. SN 77-085,291. PUB. 3-4-2008, FILED 1-18-2007.

CLASS 35—(Continued).

3,568,101. IMPERIAL BIRD'S NEST INTERNATIONAL CO. LIMITED, MONGKOK, KOWLOON, HONG KONG. SN 77-085,293. PUB. 3-4-2008, FILED 1-18-2007.

得起

夾
的

THE NON-LATIN CHARACTER(S) IN THE MARK TRANSLITERATES INTO DE GI, AND THIS MEANS ABLE TO OR UP TO IN ENGLISH.

FOR WHOLESALE DISTRIBUTORSHIPS FEATURING EDIBLES BIRD'S NESTS AND HEALTH FOODS; WHOLESALE ORDERING SERVICES IN THE FIELD OF EDIBLES BIRD'S NESTS AND HEALTH FOODS; WHOLESALE OR RETAIL STORES FEATURING EDIBLES BIRD'S NESTS AND HEALTH FOODS; ON-LINE RETAIL STORE SERVICES FEATURING EDIBLES BIRD'S NESTS AND HEALTH FOODS; DISTRIBUTORSHIPS IN THE FIELD OF EDIBLES BIRD'S NESTS AND HEALTH FOODS; MAIL ORDER SERVICES OF EDIBLES BIRD'S NESTS AND HEALTH FOODS; IMPORT AND EXPORT AGENCY SERVICES RELATING TO EDIBLE BIRD'S NESTS AND HEALTH FOODS; BUSINESS MANAGEMENT OF HEALTH FOODS RETAIL SHOPS (U.S. CLS. 100, 101 AND 102).

FIRST USE 9-1-2005; IN COMMERCE 5-15-2007.

3,568,178. LIMITED STORES, LLC, COLUMBUS, OH. SN 77-153,262. PUB. 10-2-2007, FILED 4-10-2007.

THE NON-LATIN CHARACTER(S) IN THE MARK TRANSLITERATES INTO JIA DI, AND THIS MEANS COMPRESS ON BOTH SIDES OR PICK UP WITH CHOPSTICKS AND TARGET IN ENGLISH.

FOR WHOLESALE DISTRIBUTORSHIPS FEATURING EDIBLES BIRD'S NESTS AND HEALTH FOODS; WHOLESALE ORDERING SERVICES IN THE FIELD OF EDIBLES BIRD'S NESTS AND HEALTH FOODS; WHOLESALE OR RETAIL STORES FEATURING EDIBLES BIRD'S NESTS AND HEALTH FOODS; ON-LINE RETAIL STORE SERVICES FEATURING EDIBLES BIRD'S NESTS AND HEALTH FOODS; DISTRIBUTORSHIPS IN THE FIELD OF EDIBLES BIRD'S NESTS AND HEALTH FOODS; MAIL ORDER SERVICES OF EDIBLES BIRD'S NESTS AND HEALTH FOODS; IMPORT AND EXPORT AGENCY SERVICES RELATING TO EDIBLE BIRD'S NESTS AND HEALTH FOODS; BUSINESS MANAGEMENT OF HEALTH FOODS RETAIL SHOPS (U.S. CLS. 100, 101 AND 102).

FIRST USE 9-1-2005; IN COMMERCE 2-15-2007.

BE THE GIFT

THE MARK CONSISTS OF STANDARD CHARACTERS WITHOUT CLAIM TO ANY PARTICULAR FONT, STYLE, SIZE, OR COLOR.

FOR RETAIL STORE SERVICES AND ON-LINE RETAIL STORE SERVICES FEATURING CLOTHING (U.S. CLS. 100, 101 AND 102).

FIRST USE 11-30-2007; IN COMMERCE 11-30-2007.

CLASS 35—(Continued).

3,568,203. VIRGINIA'S HERITAGE MUSIC TRAIL: THE CROOKED ROAD, INC., ABINGDON, VA. SN 77-176,435. PUB. 8-19-2008, FILED 5-9-2007.

THE CROOKED ROAD

THE MARK CONSISTS OF STANDARD CHARACTERS WITHOUT CLAIM TO ANY PARTICULAR FONT, STYLE, SIZE, OR COLOR.

FOR PROMOTING THE ECONOMIC DEVELOPMENT IN THE SOUTHWEST VIRGINIA REGION (U.S. CLS. 100, 101 AND 102).

FIRST USE 5-0-2008; IN COMMERCE 5-0-2008.

3,568,212. VCFO HOLDINGS, INC., AUSTIN, TX. SN 77-182,668. PUB. 11-6-2007, FILED 5-16-2007.

VCMO

THE MARK CONSISTS OF STANDARD CHARACTERS WITHOUT CLAIM TO ANY PARTICULAR FONT, STYLE, SIZE, OR COLOR.

FOR BUSINESS MARKETING CONSULTING SERVICES, MARKETING FOR BUSINESSES; MARKET ANALYSIS FOR OTHERS, MARKET PLAN PREPARATION FOR OTHERS, AND PUBLIC RELATIONS SERVICES (U.S. CLS. 100, 101 AND 102).

FIRST USE 5-16-2007; IN COMMERCE 11-17-2007.

3,568,259. HARPO, INC., CHICAGO, IL. SN 77-229,410. PUB. 12-25-2007, FILED 7-13-2007.

THE OPRAH STORE

THE MARK CONSISTS OF STANDARD CHARACTERS WITHOUT CLAIM TO ANY PARTICULAR FONT, STYLE, SIZE, OR COLOR.

OWNER OF U.S. REG. NO. 3,247,299.

NO CLAIM IS MADE TO THE EXCLUSIVE RIGHT TO USE "STORE", APART FROM THE MARK AS SHOWN.

THE NAME OPRAH IDENTIFIES A LIVING INDIVIDUAL WHOSE CONSENT IS OF RECORD.

FOR RETAIL STORE SERVICES FEATURING APPAREL, HOUSEHOLD ITEMS AND GIFTS; ONLINE STORE SERVICES FEATURING APPAREL, HOUSEHOLD ITEMS AND GIFTS (U.S. CLS. 100, 101 AND 102).

FIRST USE 1-29-2008; IN COMMERCE 1-29-2008.

CLASS 35—(Continued).

3,568,264. UNITED WAY OF AMERICA, ALEXANDRIA, VA. SN 77-235,051. PUB. 5-6-2008, FILED 7-20-2007.

GLOBAL CORPORATE LEADERSHIP

THE MARK CONSISTS OF STANDARD CHARACTERS WITHOUT CLAIM TO ANY PARTICULAR FONT, STYLE, SIZE, OR COLOR.

OWNER OF U.S. REG. NOS. 2,648,662, 3,051,281, AND OTHERS.

NO CLAIM IS MADE TO THE EXCLUSIVE RIGHT TO USE "GLOBAL CORPORATE", APART FROM THE MARK AS SHOWN.

FOR ASSOCIATION SERVICES, NAMELY, PROMOTING THE INTERESTS OF CORPORATIONS ENGAGED IN CHARITABLE FUND RAISING FOR HEALTH AND HUMAN SERVICES AGENCIES (U.S. CLS. 100, 101 AND 102).

FIRST USE 8-31-2007; IN COMMERCE 8-31-2007.

3,568,270. WESTON SOLUTIONS (IPR), INC., WEST CHESTER, PA. SN 77-239,540. PUB. 8-26-2008, FILED 7-26-2007.



NO CLAIM IS MADE TO THE EXCLUSIVE RIGHT TO USE "MINIT", APART FROM THE MARK AS SHOWN.

THE MARK CONSISTS OF THE WORD "MINIT" ENCLOSED WITHIN A HALF CIRCLE DESIGN FEATURING A MINUTE HAND OF A CLOCK.

FOR WEB-BASED AND NON WEB-BASED MANAGEMENT ASSISTANCE SERVICES, NAMELY, SECRETARIAL AND CLERICAL SERVICES; DOCUMENT MANAGEMENT SERVICES, NAMELY, DOCUMENT FORMATTING AND CONSOLIDATION FOR OTHERS, DOCUMENT TRACKING FOR OTHERS, AND DOCUMENT CATALOGING AND INDEXING FOR OTHERS; ADMINISTRATIVE RECORD DATABASE MANAGEMENT AND COMPILATION SERVICES, NAMELY, COMPILATION, ORGANIZATION, AND MANAGEMENT OF COMPUTERIZED DATABASES RELATING TO THE FIELDS OF ENVIRONMENTAL AND REGULATORY COMPLIANCE; PUBLIC COMMENT MANAGEMENT AND ANALYSIS SERVICES IN THE FIELDS OF ENVIRONMENTAL AND REGULATORY COMPLIANCE, NAMELY, COMPILATION OF COMMENTS SUBMITTED BY OTHERS VIA PUBLIC OPINION SURVEYS AND PUBLIC OPINION POLLS; DOCUMENT SEARCH SERVICES IN THE FIELDS OF ENVIRONMENTAL AND REGULATORY COMPLIANCE, NAMELY, PROVIDING SEARCHABLE DATABASES OF ADMINISTRATIVE RECORDS AND PUBLIC COMMENTS (U.S. CLS. 100, 101 AND 102).

FIRST USE 1-29-2007; IN COMMERCE 1-29-2007.

CLASS 35—(Continued).

3,568,274. ITALIAN ANGELS MOTORCYCLES BROTHERHOOD, INC., PALM HARBOR, FL. SN 77-242,017. PUB. 3-11-2008, FILED 7-30-2007.



NO CLAIM IS MADE TO THE EXCLUSIVE RIGHT TO USE "ITALIAN", APART FROM THE MARK AS SHOWN.

THE COLOR(S) RED, WHITE, BLACK, YELLOW AND GREEN IS/ARE CLAIMED AS A FEATURE OF THE MARK.

THE MARK CONSISTS OF THE WORDS "ITALIAN ANGELS" IN BLACK INSIDE A WHITE, RED AND GREEN DECORATIVE BANNER, FLYING ABOVE THE FRONT VIEW OF A RED, BLACK, WHITE AND YELLOW MOTORCYCLE, WITH HANDLE BARS AS BLACK AND WHITE ANGEL WINGS AND A WHITE, GOLD AND BLACK HALO ABOVE THE WINGS.

FOR CLUB SERVICES, NAMELY, PROMOTING THE INTERESTS OF ITALIAN MOTORCYCLE ENTHUSIASTS (U.S. CLS. 100, 101 AND 102).

FIRST USE 4-18-2001; IN COMMERCE 4-18-2001.

3,568,288. ALPHAGRAPHICS, INC., SALT LAKE CITY, UT. SN 77-254,058. PUB. 2-12-2008, FILED 8-13-2007.



OWNER OF U.S. REG. NOS. 1,132,841, 1,408,868, AND 1,621,183.

NO CLAIM IS MADE TO THE EXCLUSIVE RIGHT TO USE "MARKETING" AND "A DIVISION OF", APART FROM THE MARK AS SHOWN.

THE COLOR(S) BLACK AND RED IS/ARE CLAIMED AS A FEATURE OF THE MARK.

CLASS 35—(Continued).

THE MARK CONSISTS OF THE WORD "AGDIRECT" WITH THE LETTERS "A" AND "G" IN BLACK AND THE LETTERS "DIRECT" IN RED. THE WORD "MARKETING" IS BELOW THE LETTERS "DIRECT", AND THE WORD "MARKETING" IS IN BLACK LETTERS. THE WORDS "A DIVISION OF ALPHAGRAPHICS" ARE BELOW THE WORD "MARKETING". THE WORDS "A DIVISION OF ALPHAGRAPHICS" ARE IN BLACK LETTERS.

FOR ADVERTISING AND MARKETING; ADVERTISING, MARKETING AND PROMOTION SERVICES; ARRANGING AND CONDUCTING MARKETING PROMOTIONAL EVENTS FOR OTHERS; BUSINESS CONSULTATION AND MANAGEMENT REGARDING MARKETING ACTIVITIES AND LAUNCHING OF NEW PRODUCTS; BUSINESS MANAGEMENT CONSULTING WITH RELATION TO STRATEGY, MARKETING, PRODUCTION, PERSONNEL AND RETAIL SALE MATTERS; BUSINESS MARKETING AND DIRECT MAIL CONSULTING SERVICES; BUSINESS MARKETING CONSULTING SERVICES; BUSINESS MARKETING SERVICES; CREATIVE MARKETING DESIGN SERVICES; DEVELOPMENT OF MARKETING STRATEGIES AND CONCEPTS; DIRECT MARKETING ADVERTISING FOR OTHERS; DIRECT MARKETING SERVICES; GENERAL BUSINESS MERCHANDISING SERVICES, NAMELY, MARKETING; MARKETING CONSULTING; MARKETING PLAN DEVELOPMENT; PROMOTION AND MARKETING SERVICES AND RELATED CONSULTING (U.S. CLS. 100, 101 AND 102).

FIRST USE 1-3-2008; IN COMMERCE 1-3-2008.

3,568,300. BETTER BUSINESS BUREAU OF THE SOUTHLAND, INC., COLTON, CA. SN 77-260,720. PUB. 8-5-2008, FILED 8-21-2007.

TRUSTLINK

THE MARK CONSISTS OF STANDARD CHARACTERS WITHOUT CLAIM TO ANY PARTICULAR FONT, STYLE, SIZE, OR COLOR.

FOR PROVIDING INFORMATION, EVALUATION AND FEEDBACK OF BUSINESSES, PRODUCTS AND SERVICES, NAMELY, PROVIDING BUSINESS AND CONSUMER PRODUCTS AND SERVICES INFORMATION, DESCRIPTIONS, ASSESSMENTS, EVALUATIONS AND RANKINGS OF CONSUMER GOODS AND SERVICES AND BUSINESSES VIA THE INTERNET; PROVIDING A WEBSITE WHERE USERS CAN POST RATINGS, REVIEWS AND RECOMMENDATIONS ON PRODUCTS, SERVICES AND BUSINESSES; PROVIDING A WEBSITE FEATURING PRODUCT RATINGS OF THE CONSUMER GOODS AND SERVICES OF OTHERS IN A WIDE VARIETY OF FIELDS (U.S. CLS. 100, 101 AND 102).

FIRST USE 6-7-2008; IN COMMERCE 6-7-2008.

CLASS 35—(Continued).

3,568,315. UR-NEW HOME LLC, CENTERLINE, MI. SN 77-270,741. PUB. 3-18-2008, FILED 9-4-2007.

UR-NEW HOME

THE MARK CONSISTS OF STANDARD CHARACTERS WITHOUT CLAIM TO ANY PARTICULAR FONT, STYLE, SIZE, OR COLOR.

NO CLAIM IS MADE TO THE EXCLUSIVE RIGHT TO USE "HOME", APART FROM THE MARK AS SHOWN.

FOR REAL ESTATE SALES MANAGEMENT (U.S. CLS. 100, 101 AND 102).

FIRST USE 7-31-2008; IN COMMERCE 7-31-2008.

3,568,322. TUFENKIAN IMPORT/EXPORT VENTURES, INC., NEW YORK, NY. SN 77-274,514. PUB. 3-11-2008, FILED 9-7-2007.

TUFENKIAN ARCHIVE

THE MARK CONSISTS OF STANDARD CHARACTERS WITHOUT CLAIM TO ANY PARTICULAR FONT, STYLE, SIZE, OR COLOR.

OWNER OF U.S. REG. NO. 2,204,872.

FOR RETAIL STORE SERVICES FEATURING RUGS AND CARPETS; ON-LINE RETAIL STORE SERVICES FEATURING RUGS AND CARPETS (U.S. CLS. 100, 101 AND 102).

FIRST USE 11-30-2007; IN COMMERCE 11-30-2007.

3,568,349. V&S VIN & SPRIT AKTIEBOLAG (PUBL), STOCKHOLM, SWEDEN. SN 77-285,758. PUB. 4-1-2008, FILED 9-21-2007.



OWNER OF U.S. REG. NOS. 1,893,279, 3,020,896, AND OTHERS.

NO CLAIM IS MADE TO THE EXCLUSIVE RIGHT TO USE "GLOBAL COOLING", APART FROM THE MARK AS SHOWN.

THE MARK CONSISTS OF THE TERM "ABSOLUT" WHERE THE "O" IS REPRESENTED BY A GLOBE DESIGN, ALL OF WHICH IS POSITIONED ABOVE THE WORDS "GLOBAL COOLING".

CLASS 35—(Continued).

THE FOREIGN WORDING IN THE MARK TRANSLATES INTO ENGLISH AS "ABSOLUTE".

FOR PROMOTING PUBLIC AWARENESS OF CLIMATE CHANGE, ENVIRONMENT, ENERGY CONSERVATION AND NATURAL RESOURCE PROTECTION ISSUES; PUBLIC ADVOCACY TO PROMOTE AWARENESS OF CLIMATE CHANGE, ENVIRONMENT, ENERGY CONSERVATION AND NATURAL RESOURCE PROTECTION ISSUES; PUBLIC POLICY RESEARCH SERVICES; ORGANIZING AND CONDUCTING VOLUNTEER PROGRAMS AND COMMUNITY SERVICE PROJECTS; AND PROVIDING CONSUMER INFORMATION IN THE FIELDS OF CLIMATE CHANGE, ENVIRONMENT, ENERGY CONSERVATION AND NATURAL RESOURCE PROTECTION ISSUES (U.S. CLS. 100, 101 AND 102).

FIRST USE 2-0-2008; IN COMMERCE 2-0-2008.

3,568,354. RDTC, INC., DBA RONI DEUTCH TAX CENTER, NORTH HIGHLANDS, CA. SN 77-286,236. PUB. 3-11-2008, FILED 9-21-2007.

MAKE THE RIGHT CALL!

THE MARK CONSISTS OF STANDARD CHARACTERS WITHOUT CLAIM TO ANY PARTICULAR FONT, STYLE, SIZE, OR COLOR.

FOR INCOME TAX PREPARATION; TAX PREPARATION (U.S. CLS. 100, 101 AND 102).

FIRST USE 2-1-2008; IN COMMERCE 2-1-2008.

3,568,355. RDTC, INC., DBA RONI DEUTCH TAX CENTER, NORTH HIGHLANDS, CA. SN 77-286,253. PUB. 3-11-2008, FILED 9-21-2007.

WE KNOW TAXES!

THE MARK CONSISTS OF STANDARD CHARACTERS WITHOUT CLAIM TO ANY PARTICULAR FONT, STYLE, SIZE, OR COLOR.

NO CLAIM IS MADE TO THE EXCLUSIVE RIGHT TO USE "TAXES", APART FROM THE MARK AS SHOWN.

FOR INCOME TAX PREPARATION; TAX PREPARATION (U.S. CLS. 100, 101 AND 102).

FIRST USE 2-1-2008; IN COMMERCE 2-1-2008.

CLASS 35—(Continued).

3,568,360. BRILLIANT PRODUCTS, LLC, BILLINGS, MT. SN 77-287,521. PUB. 3-18-2008, FILED 9-24-2007.

BRILLIANT CONCEPTS

THE MARK CONSISTS OF STANDARD CHARACTERS WITHOUT CLAIM TO ANY PARTICULAR FONT, STYLE, SIZE, OR COLOR.

FOR RETAIL STORES FEATURING LIGHTING (U.S. CLS. 100, 101 AND 102).

FIRST USE 6-17-2008; IN COMMERCE 6-17-2008.

3,568,393. CRISTAL SOLUTIONS, INC., BEVERLY HILLS, CA. SN 77-298,656. PUB. 8-26-2008, FILED 10-8-2007.

SMARTGUY

THE MARK CONSISTS OF STANDARD CHARACTERS WITHOUT CLAIM TO ANY PARTICULAR FONT, STYLE, SIZE, OR COLOR.

FOR PROMOTING THE GOODS AND SERVICES OF OTHERS BY PROVIDING A WEBSITE WITH BUILT-IN LEAD GENERATION TECHNOLOGY TO PROVIDE SALES LEADS TO OTHERS; ADVERTISING AND MARKETING SERVICES; PROVIDING AN ONLINE BUSINESS DIRECTORY WHERE USERS CAN SEARCH FOR HOME SERVICE AND OTHER BUSINESS PROFESSIONALS; PROVIDING INFORMATION ABOUT BUSINESS PROFESSIONALS VIA THE INTERNET; MARKETING SERVICES, NAMELY, PROVIDING INFORMATIONAL WEB PAGES DESIGNED TO GENERATE SALES TRAFFIC VIA HYPERLINKS TO OTHER WEB SITES; MATCHING CONSUMERS WITH PROFESSIONALS IN THE FIELD OF RESIDENTIAL AND COMMERCIAL SERVICES VIA THE INTERNET (U.S. CLS. 100, 101 AND 102).

FIRST USE 10-1-2008; IN COMMERCE 10-1-2008.

3,568,398. JASBON, HUGO, DERRY, NH. SN 77-299,643. PUB. 3-11-2008, FILED 10-9-2007.

My Colombian Connection

THE MARK CONSISTS OF STANDARD CHARACTERS WITHOUT CLAIM TO ANY PARTICULAR FONT, STYLE, SIZE, OR COLOR.

CLASS 35—(Continued).

NO CLAIM IS MADE TO THE EXCLUSIVE RIGHT TO USE "COLOMBIAN", APART FROM THE MARK AS SHOWN.

FOR RETAIL STORE SERVICES AND ONLINE RETAIL STORE SERVICES FEATURING JEWELRY, ART, HANDCRAFT, LEATHER CLOTHING, LEATHER ACCESSORIES, CLOTHES, AND FOOD, ALL FROM COLOMBIA (U.S. CLS. 100, 101 AND 102).

FIRST USE 1-1-2008; IN COMMERCE 11-1-2008.

3,568,399. HYRAN MEDIA SERVICES, INC., WOODINVILLE, WA. SN 77-299,733. PUB. 3-25-2008, FILED 10-9-2007.

SNIPIT

THE MARK CONSISTS OF STANDARD CHARACTERS WITHOUT CLAIM TO ANY PARTICULAR FONT, STYLE, SIZE, OR COLOR.

FOR ADVERTISING SERVICES, NAMELY, PROVIDING INFORMATION ABOUT GOODS AND SERVICES OF OTHERS TO USERS OF WIRELESS TELEPHONE AND OTHER HAND-HELD COMMUNICATION DEVICES (U.S. CLS. 100, 101 AND 102).

FIRST USE 5-0-2007; IN COMMERCE 5-0-2007.

3,568,403. TSA CORPORATE SERVICES, INC., ENGLEWOOD, CO. SN 77-301,604. PUB. 4-1-2008, FILED 10-11-2007.

DEDICATED TO THE DEDICATED

THE MARK CONSISTS OF STANDARD CHARACTERS WITHOUT CLAIM TO ANY PARTICULAR FONT, STYLE, SIZE, OR COLOR.

FOR RETAIL STORE, MAIL ORDER, AND ONLINE RETAIL STORE SERVICES ALL IN THE FIELDS OF SPORTING GOODS AND EQUIPMENT, APPAREL, FOOTWEAR AND HEAD GEAR; AND ADVERTISING THE GOODS AND SERVICES OF OTHERS VIA PRINT PUBLICATIONS, TELEVISION, RADIO, DIRECT MAIL AND THE INTERNET (U.S. CLS. 100, 101 AND 102).

FIRST USE 11-12-2007; IN COMMERCE 11-12-2007.

CLASS 35—(Continued).

3,568,405. NATIONAL HEALTH PARTNERS, INC., HORSHAM, PA. SN 77-304,275. PUB. 4-1-2008, FILED 10-15-2007.

CAREXPRESS PLUS

THE MARK CONSISTS OF STANDARD CHARACTERS WITHOUT CLAIM TO ANY PARTICULAR FONT, STYLE, SIZE, OR COLOR.

OWNER OF U.S. REG. NOS. 3,206,259, 3,206,260, AND 3,209,005.

FOR ADMINISTRATION OF A DISCOUNT PROGRAM FOR ENABLING PARTICIPANTS TO OBTAIN DISCOUNTS ON HEALTH CARE GOODS AND SERVICES THROUGH USE OF A DISCOUNT MEMBERSHIP CARD (U.S. CLS. 100, 101 AND 102).

FIRST USE 6-30-2007; IN COMMERCE 6-30-2007.

3,568,475. THE PRUDENTIAL INSURANCE COMPANY OF AMERICA, NEWARK, NJ. SN 77-361,255. PUB. 5-13-2008, FILED 12-28-2007.

ROCK SOLID RELOCATION

THE MARK CONSISTS OF STANDARD CHARACTERS WITHOUT CLAIM TO ANY PARTICULAR FONT, STYLE, SIZE, OR COLOR.

NO CLAIM IS MADE TO THE EXCLUSIVE RIGHT TO USE "RELOCATION", APART FROM THE MARK AS SHOWN.

FOR PERSONNEL, BUSINESS AND EMPLOYEE RELOCATION SERVICES; REAL ESTATE REFERRAL SERVICES, NAMELY, REFERRALS IN THE FIELDS OF REAL ESTATE PURCHASES, SALES AND RENTALS, REAL ESTATE APPRAISALS AND ESCROW SERVICES, TITLE SEARCH AND TITLE INSURANCE SERVICES, FURNITURE MOVING AND STORAGE SERVICES, PACKAGING ARTICLES FOR TRANSPORTATION, AND RENTAL OR LEASING OF TRUCKS AND MOVING VANS; REAL ESTATE BROKERAGE FRANCHISE SERVICES, NAMELY, OFFERING TECHNICAL ASSISTANCE IN THE ESTABLISHMENT AND OPERATION OF REAL ESTATE BROKERAGES; BUSINESS CONSULTING SERVICES IN THE FIELD OF REAL ESTATE BROKERAGE MANAGEMENT AND OPERATIONS; CONSULTING SERVICES IN THE FIELD OF INTERNATIONAL BUSINESS PERSONNEL ASSIGNMENTS; PROMOTING THE GOODS AND SERVICES OF OTHERS BY PROVIDING INFORMATION TO REAL ESTATE BROKERS AND AGENTS CONCERNING PRODUCTS AND SERVICES AVAILABLE FOR PURCHASE FROM DESIGNATED VENDORS; ARRANGING FOR INCENTIVES OR DISCOUNTS ON THE GOODS OR SERVICES OF OTHERS RELATING TO REAL ESTATE PURCHASES, SALES AND RENTALS; PROVIDING INFORMATION IN THE FIELD OF RELOCATION BY MEANS OF A GLOBAL COMPUTER NETWORK (U.S. CLS. 100, 101 AND 102).

FIRST USE 3-31-2008; IN COMMERCE 3-31-2008.

CLASS 35—(Continued).

3,568,476. K2 MOTOR CORP, WALNUT, CA. SN 77-361,421. PUB. 6-17-2008, FILED 12-29-2007.

 The logo for SPEC-D Tuning features the word "SPEC-D" in a bold, black, sans-serif font. Below it, the word "Tuning" is written in a red, cursive script font.

NO CLAIM IS MADE TO THE EXCLUSIVE RIGHT TO USE "TUNING", APART FROM THE MARK AS SHOWN.

THE COLOR(S) BLACK AND RED IS/ARE CLAIMED AS A FEATURE OF THE MARK.

THE MARK CONSISTS OF WORD "SPEC-D" IN BLACK COLOR AND THE STYLIZED WORD "TUNING" IN RED COLOR.

FOR RETAIL STORE SERVICES FEATURING CLOTHING AND AUTO PARTS; WHOLESALE STORE SERVICES FEATURING CLOTHING AND AUTO PARTS; ONLINE-RETAIL STORE SERVICES FEATURING CLOTHING AND AUTO PARTS; ONLINE WHOLESALE STORE SERVICES FEATURING CLOTHING AND AUTO PARTS (U.S. CLS. 100, 101 AND 102).

FIRST USE 0-0-2007; IN COMMERCE 0-0-2007.

3,568,508. AMERICAN OF MARTINSVILLE, INC., MARTINSVILLE, VA. SN 77-399,970. PUB. 7-8-2008, FILED 2-19-2008.

 The logo for AOM Studios features the letters "AOM" in a large, bold, black, sans-serif font. A horizontal line is positioned above the "O" and "M", extending from the left side of the "A" and curving over the "O" and "M". Below "AOM", the word "STUDIOS" is written in a smaller, black, sans-serif font.

NO CLAIM IS MADE TO THE EXCLUSIVE RIGHT TO USE "STUDIOS", APART FROM THE MARK AS SHOWN.

THE MARK CONSISTS OF THE TERMS, AOM STUDIOS, IN STYLIZED FORM, WITH THE HORIZONTAL LINE OF THE "A" FORMED BY THE DESIGN OF TWO CURVED LINES JOINED AT THE BOTTOM.

FOR WHOLESALE DISTRIBUTORSHIP SERVICES FEATURING FURNITURE FOR HOTELS AND SENIOR LIVING FACILITIES (U.S. CLS. 100, 101 AND 102).

FIRST USE 1-31-2008; IN COMMERCE 1-31-2008.

3,568,529. O'REILLY MEDIA, INC., SEBASTOPOL, CA. SN 77-420,911. PUB. 8-12-2008, FILED 3-13-2008.

MAKER SHED

THE MARK CONSISTS OF STANDARD CHARACTERS WITHOUT CLAIM TO ANY PARTICULAR FONT, STYLE, SIZE, OR COLOR.

CLASS 35—(Continued).

OWNER OF U.S. REG. NO. 3,198,969.

FOR ONLINE RETAIL STORE SERVICES AND RETAIL STORE SERVICES FEATURING KITS, TOOLS, GADGETS, SUPPLIES, BOOKS, MAGAZINES, VIDEOS AND REFERENCE MATERIALS FOR DO-IT-YOURSELF PROJECTS IN THE FIELDS OF CRAFTS, TOYS, ELECTRONICS, COMPUTERS, PHOTOGRAPHY, RADIO, GARDENING, CHEMISTRY, COOKING, ROBOTICS, MUSIC, ASTRONOMY, BIOLOGY AND LIFE SCIENCES, PHYSICS, JEWELRY AND WEARABLE ACCESSORIES, CLOTHING, AND GAMES (U.S. CLS. 100, 101 AND 102).
FIRST USE 5-3-2008; IN COMMERCE 5-3-2008.

3,568,530. DAKITAB, INC., WEST BLOOMFIELD, MI. SN 77-422,342. PUB. 7-29-2008, FILED 3-14-2008.



THE MARK CONSISTS OF A DRAWING OF A MALE CHILD WITH HIS HANDS IN A SIDE-BY-SIDE POSITION MAKING A FOLDING MOVEMENT OF HIS HANDS FROM AN OPEN TO A CLOSED POSITION WITH THE WORD "DAKITAB" LOCATED OFF OF THE RIGHT SIDE OF THE CHILD'S FACE.

FOR ON-LINE RETAIL STORE SERVICES FEATURING BOOKS (U.S. CLS. 100, 101 AND 102).

FIRST USE 12-5-2008; IN COMMERCE 12-5-2008.

3,568,531. DYER PROPERTIES LLC, ST. PETERSBURG, FL. SN 77-424,468. PUB. 8-12-2008, FILED 3-18-2008.

THE COLOR(S) BLACK AND RED IS/ARE CLAIMED AS A FEATURE OF THE MARK.

THE MARK CONSISTS OF THE WORD "DYER" IN BLACK FOLLOWED BY AN EXCLAMATION POINT IN RED.

FOR AUTOMOBILE DEALERSHIPS (U.S. CLS. 100, 101 AND 102).

FIRST USE 2-1-2008; IN COMMERCE 5-22-2008.

CLASS 35—(Continued).

3,568,540. NEOPART, LLC, HONEY BROOK, PA. SN 77-433,666. PUB. 8-12-2008, FILED 3-27-2008.

NEOPART

THE MARK CONSISTS OF STANDARD CHARACTERS WITHOUT CLAIM TO ANY PARTICULAR FONT, STYLE, SIZE, OR COLOR.

FOR DISTRIBUTORSHIP SERVICES AND INVENTORY MANAGEMENT IN THE FIELD OF TRANSIT AND AUTOMOTIVE PARTS (U.S. CLS. 100, 101 AND 102).

FIRST USE 11-24-2008; IN COMMERCE 11-24-2008.

3,568,546. AVACORP, INC., NORCROSS, GA. SN 77-442,634. PUB. 8-26-2008, FILED 4-8-2008.

NO CLAIM IS MADE TO THE EXCLUSIVE RIGHT TO USE "INC.", APART FROM THE MARK AS SHOWN.

THE MARK CONSISTS OF THE WORDING "AVACORP, INC." SURROUNDED BY TWO CURVED LINES.

FOR RETAIL STORE SERVICES FEATURING ELECTRONICS; ONLINE RETAIL STORE SERVICES FEATURING ELECTRONICS (U.S. CLS. 100, 101 AND 102).

FIRST USE 10-1-2004; IN COMMERCE 10-1-2004.

3,568,563. DAY PITNEY LLP, NEW YORK, NY. SN 77-976,084. PUB. 12-25-2007, FILED 12-20-2006.

Day Pitney

THE MARK CONSISTS OF STANDARD CHARACTERS WITHOUT CLAIM TO ANY PARTICULAR FONT, STYLE, SIZE, OR COLOR.

FOR ASSOCIATION SERVICES, NAMELY, RECOGNIZING, PROMOTING AND ADVOCATING FOR THE IMPROVEMENT OF PERSONA, ECONOMIC AND PROFESSIONAL STATUS OF WOMEN THROUGH EDUCATIONAL, CHARITABLE AND MEMBER PROGRAMS (U.S. CLS. 100, 101 AND 102).

FIRST USE 1-1-2007; IN COMMERCE 1-1-2007.

CLASS 35—(Continued).

3,568,576. PAXANIC TAZOKA, LLC, CARSON CITY, NV. SN 78-389,562. PUB. 2-28-2006, FILED 3-23-2004.

CLASS 35—(Continued).

3,568,644. SUN WATER SYSTEMS, INC., FORT WORTH, TX. SN 78-816,836. PUB. 6-5-2007, FILED 2-16-2006.

**MARKET VOLUME
PROFIT**

THE MARK CONSISTS OF STANDARD CHARACTERS WITHOUT CLAIM TO ANY PARTICULAR FONT, STYLE, SIZE, OR COLOR.

FOR DISTRIBUTORSHIPS IN THE FIELD OF MEDICAL SUPPLIES, GENERAL CONSUMER MERCHANDISE, ELECTRONIC GOODS, HEALTH CARE PRODUCTS, HOUSEWARES AND HOUSEHOLD GOODS, OFFICE PRODUCTS, PERSONAL CARE PRODUCTS, AND FOOD PRODUCTS; BUSINESS CONSULTATION; BUSINESS DEVELOPMENT; BUSINESS MANAGEMENT; BUSINESS PLANNING; BUSINESS RESEARCH; BUSINESS ACQUISITION AND MERGER CONSULTATION; BUSINESS DEVELOPMENT SERVICES, NAMELY, PROVIDING START-UP SUPPORT FOR BUSINESSES OF OTHERS; BUSINESS MARKETING CONSULTING SERVICES; BUSINESS NETWORKING; BUSINESS ORGANIZATIONAL CONSULTATION; BUSINESS RELOCATION; BUSINESS RELOCATION CONSULTING (U.S. CLS. 100, 101 AND 102).
FIRST USE 9-30-2003; IN COMMERCE 9-30-2003.

SUNH2O

THE MARK CONSISTS OF STANDARD CHARACTERS WITHOUT CLAIM TO ANY PARTICULAR FONT, STYLE, SIZE, OR COLOR.

FOR ON-LINE RETAIL STORE SERVICES FEATURING DRINKING WATER FILTRATION EQUIPMENT, SHOWER FILTRATION EQUIPMENT AND REPLACEMENT WATER FILTERS (U.S. CLS. 100, 101 AND 102).
FIRST USE 3-1-2002; IN COMMERCE 3-1-2002.

3,568,652. POLA CHEMICAL INDUSTRIES INC., SHIZUOKA-KEN, JAPAN. SN 78-860,041. PUB. 9-4-2007, FILED 4-12-2006.

POLA KIREI

3,568,610. FERRELLGAS PARTNERS, L.P., OVERLAND PARK, KS. SN 78-661,672. PUB. 4-1-2008, FILED 6-30-2005.



THE COLOR(S) BLUE, WHITE AND BLACK IS/ARE CLAIMED AS A FEATURE OF THE MARK.

THE MARK CONSISTS OF THE TERM "ECONOGAS" WHICH APPEARS IN BLACK; A FLAME WHICH IS WHITE IN A BLUE CIRCLE AND IS POSITIONED TO THE LEFT OF THE TERM "ECONOGAS".

FOR RETAIL LIQUID PETROLEUM SUPPLY SERVICES (U.S. CLS. 100, 101 AND 102).
FIRST USE 8-0-2008; IN COMMERCE 8-0-2008.

THE MARK CONSISTS OF STANDARD CHARACTERS WITHOUT CLAIM TO ANY PARTICULAR FONT, STYLE, SIZE, OR COLOR.

OWNER OF U.S. REG. NOS. 755,665, 1,955,770, AND OTHERS.

THE JAPANESE WORDING IN THE MARK TRANSLATES INTO ENGLISH AS PRETTY, CLEAN, FAIR, BEAUTIFUL, NICE, TIDY, REFINED OR POLISHED.

FOR RETAIL STORE SERVICES IN THE FIELD OF SOAPS; RETAIL STORE SERVICES IN THE FIELD OF PERFUMERY; RETAIL STORE SERVICES IN THE FIELD OF ESSENTIAL OILS; RETAIL STORE SERVICES IN THE FIELD OF COSMETICS; RETAIL STORE SERVICES IN THE FIELD OF HAIR CARE PREPARATIONS; RETAIL STORE SERVICES IN THE FIELD OF SUPPLEMENTS; RETAIL STORE SERVICES IN THE FIELD OF HEALTH FOODS; RETAIL STORE SERVICES IN THE FIELD OF COSMETIC AND TOILET UTENSILS (U.S. CLS. 100, 101 AND 102).

FIRST USE 9-16-2006; IN COMMERCE 9-16-2006.

CLASS 35—(Continued).

3,568,662. MULTIENLACE S.A., MEDELLÍN, COLOMBIA. SN 78-910,649. PUB. 8-14-2007, FILED 6-17-2006.



NO CLAIM IS MADE TO THE EXCLUSIVE RIGHT TO USE "CONTACT CENTER", APART FROM THE MARK AS SHOWN.

THE MARK CONSISTS OF THREE CURVED LINES, POSITIONED HORIZONTALLY, ALL INTERRUPTED IN A DIFFERENT SPOT, TO THE LEFT SIDE OF THE WORDS "CONTACT CENTER MULTIENLACE SOLUCIONES PARA CONTACTOS EFECTIVOS".

THE FOREIGN WORDING IN THE MARK TRANSLATES INTO ENGLISH AS MULTILINK SOLUTIONS FOR EFFECTIVE CONTACTS.

FOR ASSISTANCE TO COMMERCIAL ENTERPRISES IN THE RUNNING OF THEIR BUSINESS AND BUSINESS MANAGEMENT AND CONSULTATION OF AN INDUSTRIAL OR COMMERCIAL ENTERPRISE; ADVERTISING, MANAGEMENT OF COMMERCIAL BUSINESSES, COMMERCIAL MANAGEMENT, PROVIDING OFFICE FUNCTIONS AND OUTSOURCING IN THE FIELD OF BUSINESS MANAGEMENT (U.S. CLS. 100, 101 AND 102).

FIRST USE 12-31-1997; IN COMMERCE 12-31-2005.

3,568,694. FOURSPOTS, INC., MARIETTA, GA. SN 78-960,842. PUB. 10-30-2007, FILED 8-25-2006.

FOURSPOTS

THE MARK CONSISTS OF STANDARD CHARACTERS WITHOUT CLAIM TO ANY PARTICULAR FONT, STYLE, SIZE, OR COLOR.

FOR ADVERTISING BY TRANSMISSION OF ONLINE PUBLICITY FOR THIRD PARTIES THROUGH ELECTRONIC COMMUNICATIONS NETWORKS; AND PREPARATION OF CUSTOM OR NON-CUSTOM ADVERTISING FOR BUSINESSES FOR DISSEMINATION VIA THE WEB, CD OR DVD FOR OPTIONAL UPLOAD OR DOWNLOAD TO A COMPUTER, TELEVISION, CELL PHONE, MOBILE DEVICE, APPLIANCE OR DIGITAL DISPLAY (U.S. CLS. 100, 101 AND 102).

FIRST USE 5-0-2007; IN COMMERCE 5-0-2007.

CLASS 35—(Continued).

3,568,699. REDFLY MOTORSPORTS, INC., VIROQUA, WI. SN 78-971,797. PUB. 9-25-2007, FILED 9-11-2006.



NO CLAIM IS MADE TO THE EXCLUSIVE RIGHT TO USE "MOTORSPORTS", APART FROM THE MARK AS SHOWN.

FOR ONLINE RETAIL STORE SERVICES FEATURING AUTOMOBILE RACING AND AFTERMARKET RACING AND PERFORMANCE AUTOMOBILE PRODUCTS AND ACCESSORIES THEREFOR, AND ACCESSORIES FOR AUTOMOBILE RACING, NAMELY, WATCHES, BACKPACKS, HELMET BAGS, ATHLETIC BAGS, OVERNIGHT BAGS, HELMETS AND UMBRELLAS, ALL OF WHICH ARE RELATED TO AUTOMOBILE RACING (U.S. CLS. 100, 101 AND 102).

FIRST USE 12-1-2008; IN COMMERCE 12-1-2008.

CLASS 36—INSURANCE AND FINANCIAL

3,568,001. SBLI USA MUTUAL LIFE INSURANCE COMPANY, INC., NEW YORK, NY. SN 76-611,124. PUB. 8-30-2005, FILED 9-13-2004.

FINANCIAL EMPOWERMENT PEOPLE

THE MARK CONSISTS OF STANDARD CHARACTERS WITHOUT CLAIM TO ANY PARTICULAR FONT, STYLE, SIZE, OR COLOR.

NO CLAIM IS MADE TO THE EXCLUSIVE RIGHT TO USE "FINANCIAL", APART FROM THE MARK AS SHOWN.

FOR INSURANCE AND FINANCIAL SERVICES, NAMELY, UNDERWRITING ANNUITIES AND UNDERWRITING LIFE, ACCIDENT, HEALTH, AND DISABILITY INSURANCE; BROKERAGE AND ADMINISTRATION SERVICES FOR ANNUITIES AND LIFE, HEALTH AND ACCIDENT INSURANCE (U.S. CLS. 100, 101 AND 102).

FIRST USE 11-16-2008; IN COMMERCE 11-16-2008.

CLASS 36—(Continued).

3,568,002. PIPELINE FINANCIAL GROUP, INC., NEW YORK, NY. SN 76-632,946. PUB. 4-3-2007, FILED 3-4-2005.

THE MARK CONSISTS OF STANDARD CHARACTERS WITHOUT CLAIM TO ANY PARTICULAR FONT, STYLE, SIZE, OR COLOR.

OWNER OF U.S. REG. NOS. 2,809,015 AND 2,965,671. NO CLAIM IS MADE TO THE EXCLUSIVE RIGHT TO USE "MARKET", APART FROM THE MARK AS SHOWN.

FOR COMPUTERIZED ONLINE TRADING SERVICES WHICH PROVIDE TRADERS WITH THE ABILITY TO COMPLETE TRADES ON VARIOUS EXCHANGES WITHIN THE SECURITIES, SECURITIES OPTIONS, SECURITIES INDEX FUTURES, COMMODITY FUTURES, OVERSEAS MARKET SECURITIES FUTURES AND DERIVATIVES MARKETS; AND PROVIDING INFORMATION IN THE FIELD OF SECURITIES, SECURITIES OPTIONS, SECURITIES INDEX FUTURES, COMMODITY FUTURES, OVERSEAS MARKET SECURITIES FUTURES AND DERIVATIVES; ALL BY MEANS OF A GLOBAL COMPUTER NETWORK (U.S. CLS. 100, 101 AND 102).

FIRST USE 3-1-2007; IN COMMERCE 3-1-2007.

3,568,082. AUTHOTECQ SYSTEMS, INC., SIGNAL HILL, CA. SN 77-067,913. PUB. 9-4-2007, FILED 12-19-2006.

PaymentSentinel

THE MARK CONSISTS OF STANDARD CHARACTERS WITHOUT CLAIM TO ANY PARTICULAR FONT, STYLE, SIZE, OR COLOR.

FOR PROVIDING SECURE ELECTRONIC PROCESSING OF CREDIT CARD TRANSACTIONS AND ELECTRONIC PAYMENTS VIA THE INTERNET TO FACILITATE CUSTOMERS' INTERNET PAYMENT AND PURCHASE TRANSACTIONS WHILE KEEPING THE MERCHANT BLIND TO CONSUMER CREDIT CARD DATA (U.S. CLS. 100, 101 AND 102).

FIRST USE 9-4-2007; IN COMMERCE 10-1-2007.

CLASS 36—(Continued).

3,568,083. TRANSACTIS, INC., BETHESDA, MD. SN 77-071,234. PUB. 1-8-2008, FILED 12-26-2006.

CLICK. VIEW. PAY.

THE MARK CONSISTS OF STANDARD CHARACTERS WITHOUT CLAIM TO ANY PARTICULAR FONT, STYLE, SIZE, OR COLOR.

FOR BILL AND INVOICE PRESENTMENT, PROCESSING AND PAYMENT VIA ELECTRONIC MAIL AND GLOBAL COMPUTER NETWORK (U.S. CLS. 100, 101 AND 102).

FIRST USE 2-1-2008; IN COMMERCE 2-1-2008.

3,568,094. COLORADO COMMUNITY LAND TRUST, DENVER, CO. SN 77-078,431. PUB. 8-21-2007, FILED 1-8-2007.

Your Partner in Affordable Housing

THE MARK CONSISTS OF STANDARD CHARACTERS WITHOUT CLAIM TO ANY PARTICULAR FONT, STYLE, SIZE, OR COLOR.

FOR HOUSING SERVICES, NAMELY, REAL PROPERTY ACQUISITION AND CONSUMER FINANCING TO FACILITATE HOME OWNERSHIP (U.S. CLS. 100, 101 AND 102).

FIRST USE 2-1-2007; IN COMMERCE 2-1-2007.

3,568,117. ARTHUR N CAPLE FOUNDATION, INC., LEXINGTON, KY. SN 77-102,342. PUB. 6-3-2008, FILED 2-8-2007.

Arthur N. Caple Foundation

THE MARK CONSISTS OF STANDARD CHARACTERS WITHOUT CLAIM TO ANY PARTICULAR FONT, STYLE, SIZE, OR COLOR.

NO CLAIM IS MADE TO THE EXCLUSIVE RIGHT TO USE "FOUNDATION", APART FROM THE MARK AS SHOWN.

THE NAME(S), PORTRAIT(S), AND/OR SIGNATURE(S) SHOWN IN THE MARK DOES NOT IDENTIFY A PARTICULAR LIVING INDIVIDUAL.

FOR PROVIDING EDUCATIONAL SCHOLARSHIPS (U.S. CLS. 100, 101 AND 102).

FIRST USE 9-1-2006; IN COMMERCE 9-1-2006.

CLASS 36—(Continued).

3,568,136. FISHER INVESTMENTS, INC., WOODSIDE, CA. SN 77-121,526. PUB. 2-26-2008, FILED 3-2-2007.

FISHER ASSET MANAGEMENT

THE MARK CONSISTS OF STANDARD CHARACTERS WITHOUT CLAIM TO ANY PARTICULAR FONT, STYLE, SIZE, OR COLOR.

NO CLAIM IS MADE TO THE EXCLUSIVE RIGHT TO USE "ASSET MANAGEMENT", APART FROM THE MARK AS SHOWN.

FOR INVESTMENT MANAGEMENT AND INVESTMENT ADVISORY SERVICES (U.S. CLS. 100, 101 AND 102).

FIRST USE 4-1-2005; IN COMMERCE 4-1-2005.

3,568,170. CC OPERATIONS, LLC, LOUISVILLE, KY. SN 77-145,539. PUB. 10-9-2007, FILED 3-31-2007.

ECHECKIT

THE MARK CONSISTS OF STANDARD CHARACTERS WITHOUT CLAIM TO ANY PARTICULAR FONT, STYLE, SIZE, OR COLOR.

FOR ELECTRONIC COMMERCE PAYMENT SERVICES, NAMELY, ESTABLISHING FUNDED ACCOUNTS USED TO PURCHASE GOODS AND SERVICES ON THE INTERNET (U.S. CLS. 100, 101 AND 102).

FIRST USE 8-26-2008; IN COMMERCE 8-26-2008.

3,568,182. WORLEY CLAIMS SERVICES, INC., HAMMOND, LA. SN 77-159,291. PUB. 4-1-2008, FILED 4-18-2007.

CERTAINTY IN A WORLD OF RISK

THE MARK CONSISTS OF STANDARD CHARACTERS WITHOUT CLAIM TO ANY PARTICULAR FONT, STYLE, SIZE, OR COLOR.

FOR PROPERTY AND CASUALTY CLAIMS ADJUSTING IN THE FIELD OF INSURANCE; INSURANCE CLAIMS ADMINISTRATION; INSURANCE RISK MANAGEMENT (U.S. CLS. 100, 101 AND 102).

FIRST USE 4-14-2002; IN COMMERCE 4-14-2002.

CLASS 36—(Continued).

3,568,247. THE PRUDENTIAL INSURANCE COMPANY OF AMERICA, NEWARK, NJ. SN 77-221,386. PUB. 4-1-2008, FILED 7-3-2007.

My term my time. my
insurance. my terms.

THE MARK CONSISTS OF STANDARD CHARACTERS WITHOUT CLAIM TO ANY PARTICULAR FONT, STYLE, SIZE, OR COLOR.

NO CLAIM IS MADE TO THE EXCLUSIVE RIGHT TO USE "TERM" AND "INSURANCE", APART FROM THE MARK AS SHOWN.

FOR LIFE INSURANCE UNDERWRITING AND POLICY ACQUISITION SERVICES RENDERED ENTIRELY VIA THE INTERNET, WITHOUT IMPOSING REQUIREMENT OF MEDICAL EXAMINATION, PROVIDING BENEFIT OF COVERAGE DECISION AND ISSUANCE OF POLICY VIA THE INTERNET (U.S. CLS. 100, 101 AND 102).

FIRST USE 9-15-2007; IN COMMERCE 9-15-2007.

3,568,248. THE PRUDENTIAL INSURANCE COMPANY OF AMERICA, NEWARK, NJ. SN 77-221,452. PUB. 4-1-2008, FILED 7-3-2007.



my time. my insurance. my terms.

NO CLAIM IS MADE TO THE EXCLUSIVE RIGHT TO USE "TERM" AND "INSURANCE", APART FROM THE MARK AS SHOWN.

THE COLOR(S) GREEN, ORANGE, PURPLE AND WHITE IS/ARE CLAIMED AS A FEATURE OF THE MARK.

THE COLOR GREEN APPEARS IN THE LARGER PORTION OF THE SQUARE BACKGROUND DESIGN AND IN THE WORDS "MY TERMS", THE COLOR ORANGE APPEARS IN THE SMALLER SPACE OF THE SQUARE BACKGROUND DESIGN AND IN THE WORDS "MY INSURANCE", THE COLOR PURPLE APPEARS IN "MY TIME", AND THE COLOR WHITE APPEARS IN "MY TERM".

FOR LIFE INSURANCE UNDERWRITING AND POLICY ACQUISITION SERVICES RENDERED ENTIRELY VIA THE INTERNET, WITHOUT IMPOSING REQUIREMENT OF MEDICAL EXAMINATION, PROVIDING BENEFIT OF COVERAGE DECISION AND ISSUANCE OF POLICY VIA THE INTERNET (U.S. CLS. 100, 101 AND 102).

FIRST USE 9-15-2007; IN COMMERCE 9-15-2007.

CLASS 36—(Continued).

3,568,252. CACHET BANQ, PASADENA, CA. SN 77-226,322. PUB. 3-11-2008, FILED 7-10-2007.

CLASS 36—(Continued).

3,568,287. FIRST NATIONAL OF NEBRASKA, INC., OMAHA, NE. SN 77-253,944. PUB. 4-1-2008, FILED 8-13-2007.

FLEXTRUST

THE MARK CONSISTS OF STANDARD CHARACTERS WITHOUT CLAIM TO ANY PARTICULAR FONT, STYLE, SIZE, OR COLOR.

FOR PAYROLL TAX PAYMENT PROCESSING AND PAYROLL TRUST MANAGEMENT SERVICES (U.S. CLS. 100, 101 AND 102).
FIRST USE 6-1-2008; IN COMMERCE 6-1-2008.



3,568,276. FETZER VINEYARDS, HOPLAND, CA. SN 77-244,297. PUB. 1-22-2008, FILED 8-1-2007.

SAVE A GODDESS

THE MARK CONSISTS OF STANDARD CHARACTERS WITHOUT CLAIM TO ANY PARTICULAR FONT, STYLE, SIZE, OR COLOR.

FOR CHARITABLE FUND RAISING FOR CANCER PATIENTS AND CANCER SURVIVORS (U.S. CLS. 100, 101 AND 102).
FIRST USE 9-27-2007; IN COMMERCE 9-27-2007.

OWNER OF U.S. REG. NOS. 1,270,238, 2,735,324, AND OTHERS.

NO CLAIM IS MADE TO THE EXCLUSIVE RIGHT TO USE "FIRST NATIONAL BANK IOWA", APART FROM THE MARK AS SHOWN.

THE MARK CONSISTS OF A DESIGN OF THE NUMERICAL ONE IN A CIRCLE AND THE WORDS "FIRST NATIONAL BANK IOWA"

FOR BANKING SERVICES (U.S. CLS. 100, 101 AND 102).
FIRST USE 6-30-2008; IN COMMERCE 6-30-2008.

3,568,278. ISO SERVICES, INC., JERSEY CITY, NJ. SN 77-244,711. PUB. 9-9-2008, FILED 8-1-2007.

A-PLUS VERIFIED

THE MARK CONSISTS OF STANDARD CHARACTERS WITHOUT CLAIM TO ANY PARTICULAR FONT, STYLE, SIZE, OR COLOR.

NO CLAIM IS MADE TO THE EXCLUSIVE RIGHT TO USE "VERIFIED", APART FROM THE MARK AS SHOWN.

FOR PROVIDING INFORMATION AND DATABASES OVER A GLOBAL COMPUTER INFORMATION NETWORK IN THE FIELD OF PROPERTY AND CASUALTY INSURANCE UNDERWRITING INFORMATION, NAMELY, INFORMATION ON PRIOR AND CURRENT INSURANCE COVERAGE STATUS (U.S. CLS. 100, 101 AND 102).

FIRST USE 9-23-2007; IN COMMERCE 9-23-2007.

3,568,304. SUPER CREW, INC., BROOMFIELD, CO. SN 77-263,880. PUB. 2-26-2008, FILED 8-24-2007.

OUR NETWORK INCREASES YOUR
NET WORTH

THE MARK CONSISTS OF STANDARD CHARACTERS WITHOUT CLAIM TO ANY PARTICULAR FONT, STYLE, SIZE, OR COLOR.

FOR FINANCIAL SERVICES FOR MERCHANTS IN THE NATURE OF CREDIT CARD TRANSACTIONS PROCESSING; FINANCIAL CONSULTATION FOR BANKING INSTITUTIONS; CHECK PAYMENT GUARANTEE SERVICES; CHECK CASHING, PROCESSING AND RECOVERY SERVICES (U.S. CLS. 100, 101 AND 102).

FIRST USE 2-15-2007; IN COMMERCE 2-15-2007.

CLASS 36—(Continued).

3,568,356. METROPOLITAN INDIANAPOLIS BOARD OF REALTORS, INDIANAPOLIS, IN. SN 77-286,748. PUB. 3-11-2008, FILED 9-24-2007.

BLC

THE MARK CONSISTS OF STANDARD CHARACTERS WITHOUT CLAIM TO ANY PARTICULAR FONT, STYLE, SIZE, OR COLOR.

FOR REAL ESTATE LISTING SERVICES (U.S. CLS. 100, 101 AND 102).

FIRST USE 11-19-2008; IN COMMERCE 11-19-2008.

3,568,387. FOUNTAINHEAD CAPITAL, LLC, DALLAS, TX. SN 77-295,721. PUB. 4-8-2008, FILED 10-4-2007.

FOUNTAINHEAD CAPITAL

THE MARK CONSISTS OF STANDARD CHARACTERS WITHOUT CLAIM TO ANY PARTICULAR FONT, STYLE, SIZE, OR COLOR.

NO CLAIM IS MADE TO THE EXCLUSIVE RIGHT TO USE "CAPITAL", APART FROM THE MARK AS SHOWN.

FOR REAL ESTATE ACQUISITION SERVICES; REAL ESTATE BROKERAGE; REAL ESTATE CONSULTATION; REAL ESTATE EQUITY SHARING, NAMELY, MANAGING AND ARRANGING FOR CO-OWNERSHIP OF REAL ESTATE; REAL ESTATE INVESTMENT; REAL ESTATE INVESTMENT SERVICES IN THE NATURE OF PURCHASING AND SELLING OF REAL ESTATE FOR OTHERS; REAL ESTATE LENDING SERVICES; REAL ESTATE MANAGEMENT; REAL ESTATE SYNDICATION; FINANCING OF DEVELOPMENT AND OPERATION OF MEDICAL IMAGING CENTERS; PROJECT FINANCING (U.S. CLS. 100, 101 AND 102).

FIRST USE 1-10-2008; IN COMMERCE 1-10-2008.

CLASS 36—(Continued).

3,568,395. LYFESYSTEMS, INC, SEATTLE, WA. SN 77-298,907. PUB. 6-3-2008, FILED 10-8-2007.

LYFEBANK

THE MARK CONSISTS OF STANDARD CHARACTERS WITHOUT CLAIM TO ANY PARTICULAR FONT, STYLE, SIZE, OR COLOR.

FOR FINANCIAL SERVICES, NAMELY, ASSISTING OTHERS WITH THE COMPLETION OF FINANCIAL TRANSACTIONS FOR HEALTH INSURANCE AND HEALTH SERVICES; FINANCIAL SERVICES, NAMELY, MANAGEMENT OF EMPLOYER FINANCIAL CONTRIBUTIONS FOR EMPLOYEE HEALTHCARE, HEALTH INSURANCE PAYMENTS BY EMPLOYEES AND RECEIPT BY INSURANCE CARRIERS; ELECTRONIC COMMERCE PAYMENT SERVICES, NAMELY, ESTABLISHING FUNDED ACCOUNTS USED TO PURCHASE HEALTH INSURANCE AND HEALTH SERVICES; ELECTRONIC PAYMENT, NAMELY, ELECTRONIC PROCESSING AND TRANSMISSION OF BILL PAYMENT DATA; ELECTRONIC PROCESSING OF INSURANCE PAYMENT DATA (U.S. CLS. 100, 101 AND 102).

FIRST USE 10-30-2007; IN COMMERCE 10-30-2007.

3,568,396. LYFESYSTEMS, INC, SEATTLE, WA. SN 77-298,918. PUB. 6-3-2008, FILED 10-8-2007.

LYFESYSTEMS

THE MARK CONSISTS OF STANDARD CHARACTERS WITHOUT CLAIM TO ANY PARTICULAR FONT, STYLE, SIZE, OR COLOR.

FOR INSURANCE BROKERAGE IN THE FIELD OF HEALTH INSURANCE; BROKERAGE IN THE FIELD OF HEALTH AND WELLNESS SERVICES; FINANCIAL SERVICES, NAMELY, ASSISTING OTHERS WITH THE COMPLETION OF FINANCIAL TRANSACTIONS FOR HEALTH INSURANCE AND HEALTH SERVICES; FINANCIAL SERVICES, NAMELY, MANAGEMENT OF EMPLOYER FINANCIAL CONTRIBUTIONS FOR EMPLOYEE HEALTHCARE, HEALTH INSURANCE PAYMENTS BY EMPLOYEES AND RECEIPT BY INSURANCE CARRIERS; ELECTRONIC COMMERCE PAYMENT SERVICES, NAMELY, ESTABLISHING FUNDED ACCOUNTS USED TO PURCHASE HEALTH INSURANCE AND HEALTH SERVICES; ELECTRONIC PAYMENT, NAMELY, ELECTRONIC PROCESSING AND TRANSMISSION OF BILL PAYMENT DATA (U.S. CLS. 100, 101 AND 102).

FIRST USE 10-30-2007; IN COMMERCE 10-30-2007.

CLASS 36—(Continued).

3,568,402. LINCOLN NATIONAL CORPORATION, RADNOR, PA. SN 77-301,411. PUB. 3-18-2008, FILED 10-11-2007.

FUTURESELF

THE MARK CONSISTS OF STANDARD CHARACTERS WITHOUT CLAIM TO ANY PARTICULAR FONT, STYLE, SIZE, OR COLOR.

FOR FINANCIAL SERVICES, NAMELY, LIFE INSURANCE AND ANNUITY UNDERWRITING SERVICES; FINANCIAL SERVICES IN THE NATURE OF ANNUITY INVESTMENT; ADMINISTRATION AND MANAGEMENT OF ANNUITY CONTRACTS; ADMINISTRATION OF ANNUITY CONTRACTS FOR OTHERS AND CONSULTATION IN THE FIELD OF DEVELOPING ANNUITY PRODUCTS FOR OTHERS; MUTUAL FUND SERVICES, NAMELY, MUTUAL FUND BROKERAGE, MUTUAL FUND DISTRIBUTION AND THE ADMINISTRATION AND MANAGEMENT OF MUTUAL FUNDS; FINANCIAL PLANNING AND INVESTMENT ADVISORY SERVICES; INSTITUTIONAL INVESTMENT MANAGEMENT SERVICES; INVESTMENT PLANNING SERVICES, NAMELY, INVESTMENT CONSULTATION AND ADVICE; ARRANGING DEFERRED COMPENSATION FOR PRIVATE, PUBLIC AND TAX EXEMPT EMPLOYERS AND THEIR EMPLOYEES, AND OFFERING INDIVIDUAL RETIREMENT ACCOUNTS FOR INDIVIDUAL RETIREMENT (U.S. CLS. 100, 101 AND 102).
FIRST USE 10-16-2007; IN COMMERCE 10-16-2007.

3,568,415. CHESWOLD CAPITAL GROUP LLC, PHILADELPHIA, PA. SN 77-313,448. PUB. 4-8-2008, FILED 10-25-2007.

CHESWOLD

THE MARK CONSISTS OF STANDARD CHARACTERS WITHOUT CLAIM TO ANY PARTICULAR FONT, STYLE, SIZE, OR COLOR.

FOR PENSION FUND, ENDOWMENT, FOUNDATION AND RETIREMENT PLAN MANAGEMENT SERVICES, NAMELY, INVESTMENT OF PENSION ENDOWMENT, FOUNDATION AND RETIREMENT FUNDS FOR OTHERS; INVESTMENT ADVISORY AND MANAGEMENT SERVICES; REAL ESTATE INVESTMENT MANAGEMENT SERVICES (U.S. CLS. 100, 101 AND 102).
FIRST USE 1-0-2008; IN COMMERCE 1-0-2008.

CLASS 36—(Continued).

3,568,450. NORTHLAND INSURANCE COMPANY, ST. PAUL, MN. SN 77-338,530. PUB. 4-29-2008, FILED 11-28-2007.

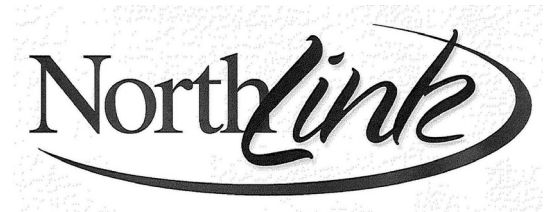

OWNER OF U.S. REG. NO. 3,136,889.
THE MARK CONSISTS OF THE WORD "NORTHLINK" WITH AN ELLIPSE.

FOR INSURANCE UNDERWRITING SERVICES, NAMELY, PROVIDING ONLINE QUOTING, RATING AND ISSUING OF INSURANCE POLICIES AND POLICYHOLDER INFORMATION (U.S. CLS. 100, 101 AND 102).
FIRST USE 2-14-2006; IN COMMERCE 2-14-2006.

3,568,465. CNL INTELLECTUAL PROPERTIES, INC., ORLANDO, FL. SN 77-354,303. PUB. 5-20-2008, FILED 12-18-2007.

CNL GLOBAL REAL ESTATE FUND

THE MARK CONSISTS OF STANDARD CHARACTERS WITHOUT CLAIM TO ANY PARTICULAR FONT, STYLE, SIZE, OR COLOR.

OWNER OF U.S. REG. NO. 1,478,007.
NO CLAIM IS MADE TO THE EXCLUSIVE RIGHT TO USE "GLOBAL REAL ESTATE FUND", APART FROM THE MARK AS SHOWN.

FOR REAL ESTATE INVESTMENT, BROKERAGE, CONSULTING, AND MANAGEMENT SERVICES; REAL ESTATE INVESTMENT TRUST SERVICES; BROKER AND DEALER SERVICES IN THE FIELD OF REAL ESTATE INVESTMENT SECURITIES; REAL ESTATE INVESTMENT AND FUND, ASSET, MUTUAL FUND, HEDGE FUND, AND MONEY MARKET INVESTMENT ADVISORY SERVICES; FINANCIAL ADVISORY SERVICES (U.S. CLS. 100, 101 AND 102).
FIRST USE 10-22-2007; IN COMMERCE 10-22-2007.

CLASS 36—(Continued).

3,568,466. CNL INTELLECTUAL PROPERTIES, INC., ORLANDO, FL. SN 77-354,364. PUB. 5-13-2008, FILED 12-18-2007.

THE CNL FUNDS

THE MARK CONSISTS OF STANDARD CHARACTERS WITHOUT CLAIM TO ANY PARTICULAR FONT, STYLE, SIZE, OR COLOR.

OWNER OF U.S. REG. NO. 1,478,007.

NO CLAIM IS MADE TO THE EXCLUSIVE RIGHT TO USE "FUNDS", APART FROM THE MARK AS SHOWN.

FOR REAL ESTATE INVESTMENT, BROKERAGE, CONSULTING, AND MANAGEMENT SERVICES; REAL ESTATE INVESTMENT TRUST SERVICES; BROKER AND DEALER SERVICES IN THE FIELD OF REAL ESTATE INVESTMENT SECURITIES; REAL ESTATE INVESTMENT AND FUND, ASSET, MUTUAL FUND, HEDGE FUND, AND MONEY MARKET INVESTMENT ADVISORY SERVICES; FINANCIAL ADVISORY SERVICES (U.S. CLS. 100, 101 AND 102).

FIRST USE 10-22-2007; IN COMMERCE 10-22-2007.

3,568,483. CNL INTELLECTUAL PROPERTIES, INC., ORLANDO, FL. SN 77-367,603. PUB. 5-27-2008, FILED 1-9-2008.



CNL GLOBAL REAL ESTATE FUND

OWNER OF U.S. REG. NO. 1,478,007.

NO CLAIM IS MADE TO THE EXCLUSIVE RIGHT TO USE "GLOBAL REAL ESTATE FUND", APART FROM THE MARK AS SHOWN.

THE MARK CONSISTS OF A PARTIAL GLOBE WITH CONTINENTS, MERIDIANS, PARALLELS AND THE WORDS "CNL GLOBAL REAL ESTATE FUND" PLACED BETWEEN TWO HORIZONTAL LINES.

FOR REAL ESTATE INVESTMENT, BROKERAGE, CONSULTING, AND MANAGEMENT SERVICES; REAL ESTATE INVESTMENT TRUST SERVICES; BROKER AND DEALER SERVICES IN THE FIELD OF REAL ESTATE INVESTMENT SECURITIES; REAL ESTATE INVESTMENT AND FUND, ASSET, MUTUAL FUND, HEDGE FUND, AND MONEY MARKET INVESTMENT ADVISORY SERVICES; FINANCIAL ADVISORY SERVICES (U.S. CLS. 100, 101 AND 102).

FIRST USE 10-22-2007; IN COMMERCE 10-22-2007.

CLASS 36—(Continued).

3,568,495. STATE EMPLOYEES' CREDIT UNION, RALEIGH, NC. SN 77-377,703. PUB. 7-8-2008, FILED 1-22-2008.



NO CLAIM IS MADE TO THE EXCLUSIVE RIGHT TO USE "CREDIT UNION INVESTMENT SERVICES", APART FROM THE MARK AS SHOWN.

FOR INVESTMENT ADVISORY SERVICES (U.S. CLS. 100, 101 AND 102).

FIRST USE 10-1-2007; IN COMMERCE 11-1-2007.

3,568,553. AMERICAN INTERNATIONAL GROUP, INC., NEW YORK, NY. SN 77-451,194. PUB. 8-19-2008, FILED 4-17-2008.

INSIDE EDGE

THE MARK CONSISTS OF STANDARD CHARACTERS WITHOUT CLAIM TO ANY PARTICULAR FONT, STYLE, SIZE, OR COLOR.

FOR ANNUITY UNDERWRITING; ISSUANCE AND ADMINISTRATION OF ANNUITIES (U.S. CLS. 100, 101 AND 102).

FIRST USE 5-0-2008; IN COMMERCE 5-0-2008.

3,568,582. WILLIAM B. MAY JR. FAMILY LIMITED PARTNERSHIP, CHESTERTOWN, MD. SN 78-421,131. PUB. 9-6-2005, FILED 5-18-2004.

WILLIAM B. MAY

THE MARK CONSISTS OF STANDARD CHARACTERS WITHOUT CLAIM TO ANY PARTICULAR FONT, STYLE, SIZE, OR COLOR.

THE NAME SHOWN IN THE MARK DOES NOT IDENTIFY A PARTICULAR LIVING INDIVIDUAL.

FOR REAL ESTATE SERVICES, NAMELY, REAL ESTATE BROKERAGE SERVICES (U.S. CLS. 100, 101 AND 102).

FIRST USE 11-26-2008; IN COMMERCE 11-26-2008.

CLASS 37—CONSTRUCTION AND REPAIR

CLASS 37—(Continued).

3,567,996. ROOFERS' SUCCESS INTERNATIONAL, LLC, ST. LOUIS, MO. SN 76-581,201. PUB. 8-23-2005, FILED 3-16-2004.

RHINO ROOFING

THE MARK CONSISTS OF STANDARD CHARACTERS WITHOUT CLAIM TO ANY PARTICULAR FONT, STYLE, SIZE, OR COLOR.

NO CLAIM IS MADE TO THE EXCLUSIVE RIGHT TO USE "ROOFING", APART FROM THE MARK AS SHOWN.

FOR REPAIR, MAINTENANCE, REPLACEMENT AND INSTALLATION SERVICES IN THE FIELD OF ROOFING (U.S. CLS. 100, 103 AND 106).

FIRST USE 5-31-2006; IN COMMERCE 5-31-2006.

3,568,022. COLAS, 92100 BOULOGNE-BILLANCOURT, FRANCE. SN 76-678,740. PUB. 12-11-2007, FILED 6-26-2007.

Fibredec

THE MARK CONSISTS OF STANDARD CHARACTERS WITHOUT CLAIM TO ANY PARTICULAR FONT, STYLE, SIZE, OR COLOR.

FOR SERVICES RELATING TO CONSTRUCTION, REPAIR, MAINTENANCE, RESTORATION AND RENOVATION OF ROADS, RUNWAYS, PATHS AND OTHER RUNNING AND TRAFFIC ROUTES AND SURFACES (U.S. CLS. 100, 103 AND 106).

FIRST USE 10-0-2003; IN COMMERCE 10-0-2003.

3,568,031. GUNTHER, JOHAN M., SANTA MONICA, CA. SN 76-684,461. PUB. 5-6-2008, FILED 11-29-2007.

MDM

THE MARK CONSISTS OF STANDARD CHARACTERS WITHOUT CLAIM TO ANY PARTICULAR FONT, STYLE, SIZE, OR COLOR.

FOR CONSTRUCTING IN-SITU PILINGS AND STRUCTURES (U.S. CLS. 100, 103 AND 106).

FIRST USE 9-29-2006; IN COMMERCE 9-29-2006.

CLASS 37—(Continued).

3,568,130. A. LEECHMAN HEATING & COOLING, INC., DES MOINES, IA. SN 77-116,940. PUB. 3-18-2008, FILED 2-27-2007.

SERVICE LEGENDS

THE MARK CONSISTS OF STANDARD CHARACTERS WITHOUT CLAIM TO ANY PARTICULAR FONT, STYLE, SIZE, OR COLOR.

NO CLAIM IS MADE TO THE EXCLUSIVE RIGHT TO USE "SERVICE", APART FROM THE MARK AS SHOWN.

FOR HEATING AND AIR CONDITIONING CONTRACTOR SERVICES, INCLUDING INSTALLATION, REPAIR, AND MAINTENANCE SERVICES; PLUMBING CONTRACTOR SERVICES, INCLUDING INSTALLATION, REPAIR, AND MAINTENANCE SERVICES; ELECTRICAL CONTRACTOR SERVICES, INCLUDING INSTALLATION, REPAIR, AND MAINTENANCE SERVICES (U.S. CLS. 100, 103 AND 106).

FIRST USE 2-1-2008; IN COMMERCE 2-1-2008.

3,568,209. LANDCAR AGENCY, INC., SANDY, UT. SN 77-181,132. PUB. 4-29-2008, FILED 5-15-2007.

LANDCAR PERSONAL CAR CARE

THE MARK CONSISTS OF STANDARD CHARACTERS WITHOUT CLAIM TO ANY PARTICULAR FONT, STYLE, SIZE, OR COLOR.

NO CLAIM IS MADE TO THE EXCLUSIVE RIGHT TO USE "PERSONAL CAR CARE", APART FROM THE MARK AS SHOWN.

FOR VEHICLE REPAIR AND MAINTENANCE SERVICES; VEHICLE MAINTENANCE PROGRAM (U.S. CLS. 100, 103 AND 106).

FIRST USE 11-0-2007; IN COMMERCE 11-0-2007.

CLASS 37—(Continued).

3,568,335. THE TRUSTEES OF THE RAUL J. WALTERS REVOCABLE LIVING TRUST TRUST, A MISSOURI TRUST, THE TRUSTEES COMPRISING RAUL J. WALTERS, A UNITED STATES CITIZEN, AND VICKI WALTERS, A UNITED STATES CITIZEN, COLUMBIA, MO. SN 77-279,016. PUB. 2-12-2008, FILED 9-13-2007.



FOR REAL ESTATE DEVELOPMENT (U.S. CLS. 100, 103 AND 106).
FIRST USE 2-29-2008; IN COMMERCE 2-29-2008.

3,568,630. PENCIL, LLC, LA JOLLA, CA. SN 78-773,066. PUB. 5-30-2006, FILED 12-14-2005.

Starfall

THE MARK CONSISTS OF STANDARD CHARACTERS WITHOUT CLAIM TO ANY PARTICULAR FONT, STYLE, SIZE, OR COLOR.

OWNER OF U.S. REG. NOS. 2,721,805, 2,883,345, AND OTHERS.

FOR INSTALLATION OF COMPUTER NETWORKS; INSTALLATION OF COMPUTER SYSTEMS; MAINTENANCE AND REPAIR OF COMPUTER HARDWARE; MAINTENANCE AND REPAIR OF COMPUTER NETWORKS (U.S. CLS. 100, 103 AND 106).

FIRST USE 12-1-2003; IN COMMERCE 12-1-2003.

3,568,658. DAVID POURBABA, LOS ANGELES, CA. SN 78-899,232. PUB. 1-9-2007, FILED 6-2-2006.

CIELO

THE MARK CONSISTS OF STANDARD CHARACTERS WITHOUT CLAIM TO ANY PARTICULAR FONT, STYLE, SIZE, OR COLOR.

CLASS 37—(Continued).

THE ENGLISH TRANSLATION OF CIELO IS "SKY OR HEAVEN".

FOR REAL ESTATE DEVELOPMENT (U.S. CLS. 100, 103 AND 106).

FIRST USE 3-1-2005; IN COMMERCE 3-1-2005.

CLASS 38—COMMUNICATION

3,568,166. FALCON IP/COMPLETE, LLC, MALDEN, MO. SN 77-141,472. PUB. 3-25-2008, FILED 3-27-2007.

Falcon IP/Complete

NO CLAIM IS MADE TO THE EXCLUSIVE RIGHT TO USE "IP", APART FROM THE MARK AS SHOWN.

THE COLOR(S) BLUE, WHITE, GREEN, AND RED IS/ARE CLAIMED AS A FEATURE OF THE MARK.

THE COLOR BLUE APPEARS IN THE WORDING "FALCON IP". THE STYLIZED REPRESENTATION OF A FLYING BIRD ON TOP OF THE LETTER O IN "FALCON" IS WHITE. THE COLOR GREEN APPEARS IN THE BACKSLASH AND THE WORDING "COMPLETE" IS RED.

FOR TELEVISION BROADCASTING AND TRANSMISSION SERVICES (U.S. CLS. 100, 101 AND 104).

FIRST USE 1-31-2007; IN COMMERCE 1-31-2007.

3,568,184. HSN LP, ST. PETERSBURG, FL. SN 77-163,087. PUB. 4-1-2008, FILED 4-23-2007.

HSN ON DEMAND

THE MARK CONSISTS OF STANDARD CHARACTERS WITHOUT CLAIM TO ANY PARTICULAR FONT, STYLE, SIZE, OR COLOR.

OWNER OF U.S. REG. NOS. 1,482,734, 1,998,814, AND OTHERS.

NO CLAIM IS MADE TO THE EXCLUSIVE RIGHT TO USE "ON DEMAND", APART FROM THE MARK AS SHOWN.

FOR BROADCASTING PRE-RECORDED CONSUMER PRODUCT PROGRAMMING VIA TELEVISION, INTERNET, SATELLITE AND CELL PHONES (U.S. CLS. 100, 101 AND 104).

FIRST USE 6-11-2007; IN COMMERCE 6-11-2007.

CLASS 38—(Continued).

3,568,211. EBAGS.COM, GREENWOOD VILLAGE, CO. SN 77-182,577. PUB. 3-18-2008, FILED 5-16-2007.

CLASS 38—(Continued).

3,568,341. DISHRANK LTD., TAIPEI CITY, TAIWAN. SN 77-281,439. PUB. 3-4-2008, FILED 9-17-2007.

BAGOPEDIA

DishRank

THE MARK CONSISTS OF STANDARD CHARACTERS WITHOUT CLAIM TO ANY PARTICULAR FONT, STYLE, SIZE, OR COLOR.

FOR ELECTRONIC DATA TRANSMISSION OF INFORMATION IN THE FIELD OF LUGGAGE, HANDBAGS AND APPAREL VIA A GLOBAL COMPUTER NETWORK; INFORMATION TRANSMISSION IN THE FIELD OF LUGGAGE, HANDBAGS AND APPAREL VIA ELECTRONIC COMMUNICATIONS NETWORKS, PROVIDING ON-LINE FORUMS FOR TRANSMISSION OF MESSAGES AMONG COMPUTER USERS CONCERNING LUGGAGE, HANDBAGS AND APPAREL (U.S. CLS. 100, 101 AND 104).

FIRST USE 3-10-2007; IN COMMERCE 5-3-2007.

FOR COMMUNICATION SERVICES, NAMELY, ELECTRONIC TRANSMISSION OF DATA AND DOCUMENTS AMONG USERS OF COMPUTERS; ELECTRONIC DATE INTERCHANGE (EDI) SERVICES; ELECTRONIC DATA INTERCHANGE; ELECTRONIC DATA TRANSMISSION; ELECTRONIC DELIVERY OF IMAGES AND PHOTOGRAPHS VIA A GLOBAL COMPUTER NETWORK; ELECTRONIC EXCHANGE OF DATA STORED IN DATABASES ACCESSIBLE VIA TELECOMMUNICATION NETWORKS; ELECTRONIC MAIL SERVICES; ELECTRONIC MAIL SENDING; ELECTRONIC MESSAGE TRANSMISSION; ELECTRONIC MESSAGING SYSTEM, NAMELY, ELECTRONIC QUEUING SERVICES; PROVIDING A HIGH SPEED ACCESS TO AREA NETWORKS AND A GLOBAL COMPUTER INFORMATION NETWORK; PROVIDING ACCESS TO TELECOMMUNICATION NETWORKS; PROVIDING ACCESS TO DATABASES; PROVIDING CO-LOCATION SERVICES FOR VOICE, VIDEO AND DATA COMMUNICATIONS APPLICATIONS; PROVIDING ELECTRONIC TELECOMMUNICATION CONNECTIONS; PROVIDING ELECTRONIC TRANSMISSION OF CREDIT CARD TRANSACTION DATA AND ELECTRONIC PAYMENT DATA VIA A GLOBAL COMPUTER NETWORK (U.S. CLS. 100, 101 AND 104).

FIRST USE 3-1-2008; IN COMMERCE 10-30-2008.

3,568,250. MAURY FRIEDMAN, AGOURA HILLS, CA. SN 77-224,149. PUB. 3-18-2008, FILED 7-7-2007.

3,568,392. YOUNG JEA SHIN, PLAINFIELD, IL. SN 77-297,918. PUB. 3-25-2008, FILED 10-6-2007.

Zumbox

JSTN

THE MARK CONSISTS OF STANDARD CHARACTERS WITHOUT CLAIM TO ANY PARTICULAR FONT, STYLE, SIZE, OR COLOR.

FOR PROVIDING ON-LINE ELECTRONIC BULLETIN BOARDS FOR TRANSMISSION OF MESSAGES AMONG COMPUTER USERS CONCERNING LOCAL NEWS, ACTIVITIES, AND EVENTS; ELECTRONIC MAIL SERVICES; ELECTRONIC TRANSMISSION OF MESSAGES AND DATA (U.S. CLS. 100, 101 AND 104).

FIRST USE 9-10-2007; IN COMMERCE 9-10-2007.

THE MARK CONSISTS OF STANDARD CHARACTERS WITHOUT CLAIM TO ANY PARTICULAR FONT, STYLE, SIZE, OR COLOR.

FOR BROADCAST OF CABLE TELEVISION PROGRAMMES (U.S. CLS. 100, 101 AND 104).

FIRST USE 6-30-2008; IN COMMERCE 6-30-2008.

CLASS 38—(Continued).

3,568,589. IGN ENTERTAINMENT, INC., BRISBANE, CA. SN 78-478,901. PUB. 4-17-2007, FILED 9-3-2004.

DIRECT2DRIVE

THE MARK CONSISTS OF STANDARD CHARACTERS WITHOUT CLAIM TO ANY PARTICULAR FONT, STYLE, SIZE, OR COLOR.

FOR DIGITAL TRANSMISSION OF DATA AND DOCUMENTS; VIDEO ON DEMAND TRANSMISSION SERVICES (U.S. CLS. 100, 101 AND 104).

FIRST USE 9-2-2004; IN COMMERCE 9-2-2004.

3,568,635. NORTHEAST IOWA TELEPHONE COMPANY, MONONA, IA. SN 78-787,629. PUB. 3-13-2007, FILED 1-9-2006.



FOR WIRELINE AND WIRELESS TELECOMMUNICATION ACCESS SERVICES; PROVIDING MULTIPLE USER DIAL-UP AND DEDICATED ACCESS TO THE INTERNET; AND CABLE TELEVISION TRANSMISSION (U.S. CLS. 100, 101 AND 104).

FIRST USE 11-4-2008; IN COMMERCE 11-4-2008.

3,568,666. PUBLIC BROADCASTING SERVICE, ARLINGTON, VA. SN 78-921,237. PUB. 2-27-2007, FILED 6-30-2006.

PBS TEACHERS

THE MARK CONSISTS OF STANDARD CHARACTERS WITHOUT CLAIM TO ANY PARTICULAR FONT, STYLE, SIZE, OR COLOR.

OWNER OF U.S. REG. NOS. 1,247,905, 2,707,600, AND OTHERS.

CLASS 38—(Continued).

NO CLAIM IS MADE TO THE EXCLUSIVE RIGHT TO USE "TEACHERS", APART FROM THE MARK AS SHOWN.

FOR PROVIDING AN ONLINE ELECTRONIC BULLETIN BOARD FOR TRANSMISSION OF MESSAGES AMONG COMPUTER USERS CONCERNING A WIDE RANGE OF INFORMATION IN THE FIELD OF EDUCATION; COMPUTER SERVICES, NAMELY, PROVIDING ONLINE CHAT ROOMS FOR TRANSMISSION OF MESSAGES AMONG COMPUTER USERS CONCERNING A WIDE RANGE OF INFORMATION IN THE FIELD OF EDUCATION; AND TRANSMISSION OF VIDEO STREAMING FROM VARIOUS SOURCES VIA THE INTERNET (U.S. CLS. 100, 101 AND 104).

FIRST USE 3-1-2007; IN COMMERCE 3-1-2007.

3,568,674. MIGUEL PEREZ COMMUNICATIONS, INC., MAITLAND, FL. SN 78-931,757. PUB. 3-13-2007, FILED 7-18-2006.



NO CLAIM IS MADE TO THE EXCLUSIVE RIGHT TO USE "CULTURAL PRESS" AND "CULTURAL JOURNALISM", APART FROM THE MARK AS SHOWN.

THE MARK CONSISTS OF STYLIZED TEXT OF THE WORDING "CULTURAL PRESS CULTURAL JOURNALISM WITHOUT FRONTIERS", WITH THE LETTERS "CP" IN THE UPPER LEFT ABOVE THE STYLIZED DEPICTION OF A FISHING NET.

FOR NEWS AGENCIES, NAMELY, THE TRANSMISSION OF NEWS ITEMS TO NEWS REPORTING ORGANIZATIONS (U.S. CLS. 100, 101 AND 104).

FIRST USE 6-5-2006; IN COMMERCE 6-5-2006.

CLASS 39—TRANSPORTATION AND STORAGE

3,568,110. GRAND CIRCLE LLC, BOSTON, MA. SN 77-100,011. PUB. 3-18-2008, FILED 2-6-2007.

GRAND CIRCLE SMALL SHIP CRUISES

THE MARK CONSISTS OF STANDARD CHARACTERS WITHOUT CLAIM TO ANY PARTICULAR FONT, STYLE, SIZE, OR COLOR.

OWNER OF U.S. REG. NO. 2,616,634.

CLASS 39—(Continued).

NO CLAIM IS MADE TO THE EXCLUSIVE RIGHT TO USE "SMALL SHIP CRUISES", APART FROM THE MARK AS SHOWN.

FOR TRAVEL CLUBS, TRAVEL GUIDE SERVICES, TRAVEL INFORMATION SERVICES, ARRANGING TRAVEL TOURS, AND TRAVEL AGENCY SERVICES, NAMELY, MAKING RESERVATIONS AND BOOKINGS FOR TRANSPORTATION (U.S. CLS. 100 AND 105).

FIRST USE 8-31-2007; IN COMMERCE 8-31-2007.



3,568,226. UNITED LAUNCH ALLIANCE, CENTENNIAL, CO. SN 77-195,707. PUB. 10-16-2007, FILED 6-1-2007.

PERFECT PRODUCT DELIVERY

THE MARK CONSISTS OF STANDARD CHARACTERS WITHOUT CLAIM TO ANY PARTICULAR FONT, STYLE, SIZE, OR COLOR.

NO CLAIM IS MADE TO THE EXCLUSIVE RIGHT TO USE "PRODUCT DELIVERY", APART FROM THE MARK AS SHOWN.

FOR LAUNCH AND PLACEMENT IN PRESCRIBED ORBIT OF SATELLITES OF OTHERS (U.S. CLS. 100 AND 105).

FIRST USE 12-4-2008; IN COMMERCE 12-4-2008.



3,568,289. YANGTZE RIVER EXPRESS AIRLINES COMPANY LIMITED, SHANGHAI, CHINA. SN 77-254,533. PUB. 4-22-2008, FILED 8-14-2007.

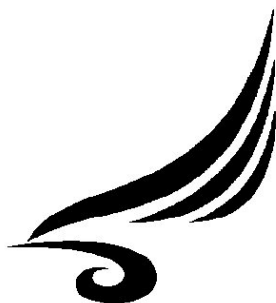

THE MARK CONSISTS OF THREE WAVY LINES AND A SWIRL LINE APPEARING UNDERNEATH.

FOR AIR TRANSPORT; TRANSPORT BY AUTOMOBILES; PARCEL DELIVERY; PACKAGING ARTICLES FOR TRANSPORTATION; DELIVERY OF A VARIETY OF INDUSTRIAL GOODS; PACKAGING ARTICLES FOR TRANSPORTATION; TRANSPORTATION AND STORAGE OF GOODS; FREIGHT TRANSPORTATION BY AIR FREIGHT AND BY LAND VEHICLE; COURIER SERVICES; WRAPPING SERVICES FOR BAGGAGE PROTECTION DURING TRAVEL (U.S. CLS. 100 AND 105).

FIRST USE 1-16-2007; IN COMMERCE 1-16-2007.

CLASS 39—(Continued).

3,568,312. CAPEL ENTERPRISES, LLC, CANDLER, NC. SN 77-269,269. PUB. 3-4-2008, FILED 8-31-2007.

777-JUNK
CONSIDER IT GONE

THE MARK CONSISTS OF STANDARD CHARACTERS WITHOUT CLAIM TO ANY PARTICULAR FONT, STYLE, SIZE, OR COLOR.

NO CLAIM IS MADE TO THE EXCLUSIVE RIGHT TO USE "777-JUNK", APART FROM THE MARK AS SHOWN.

FOR JUNK REMOVAL (U.S. CLS. 100 AND 105).

FIRST USE 10-6-2007; IN COMMERCE 10-6-2007.



3,568,342. FREIGHTLINER LLC, PORTLAND, OR. SN 77-281,501. PUB. 3-11-2008, FILED 9-17-2007.

SELECTLEASE

THE MARK CONSISTS OF STANDARD CHARACTERS WITHOUT CLAIM TO ANY PARTICULAR FONT, STYLE, SIZE, OR COLOR.

FOR LEASING OF USED TRUCKS (U.S. CLS. 100 AND 105).

FIRST USE 12-1-2008; IN COMMERCE 12-1-2008.



3,568,347. DOUGLASS, HARLEY C., COLBERT, WA. SN 77-284,311. PUB. 3-11-2008, FILED 9-20-2007.

PAY[™]PAK

THE MARK CONSISTS OF STYLIZED WORD(S) AND/OR LETTER(S).

FOR PROVIDING SELF-STORAGE FACILITIES AND WAREHOUSE STORAGE; LEASING, RENTING, AND MANAGING SELF-STORAGE FACILITIES AND WAREHOUSE STORAGE, NAMELY, PROVIDING SELF-STORAGE FACILITIES, CONDOMINIUM STORAGE UNITS, AND GARAGE STORAGE UNITS FOR OTHERS (U.S. CLS. 100 AND 105).

FIRST USE 7-1-2008; IN COMMERCE 7-1-2008.

CLASS 39—(Continued).

3,568,448. EXECTRANS, LLC, BELLEVUE, WA. SN 77-335,535. PUB. 5-20-2008, FILED 11-21-2007.

Mobile Boardroom

THE MARK CONSISTS OF STANDARD CHARACTERS WITHOUT CLAIM TO ANY PARTICULAR FONT, STYLE, SIZE, OR COLOR.

NO CLAIM IS MADE TO THE EXCLUSIVE RIGHT TO USE "MOBILE", APART FROM THE MARK AS SHOWN.

FOR TRANSPORT OF PASSENGERS; TRANSPORTATION OF PASSENGERS AND/OR GOODS BY MOTOR COACH; LIMOUSINE SERVICES (U.S. CLS. 100 AND 105).

FIRST USE 1-1-2004; IN COMMERCE 1-1-2004.

3,568,704. SCANA CORPORATION, COLUMBIA, SC. SN 78-980,740. PUB. 3-13-2007, FILED 8-31-2006.



OWNER OF U.S. REG. NOS. 2,249,684, 2,260,911, AND OTHERS.

NO CLAIM IS MADE TO THE EXCLUSIVE RIGHT TO USE "ENERGY.COM", APART FROM THE MARK AS SHOWN.

THE MARK CONSISTS OF THE WORDS "SCANA ENERGY.COM" PRECEDED BY A STYLIZED RENDITION OF AN EDGE. THE COLOR GRAY IS INTENDED TO SHOW SHADING OR CONTRAST ONLY.

FOR PUBLIC UTILITY SERVICES (U.S. CLS. 100 AND 105).

FIRST USE 9-11-2006; IN COMMERCE 9-11-2006.

CLASS 40—MATERIAL TREATMENT

3,568,314. PARTNER'S ROYALTIES, LLC, WOODSTOCK, GA. SN 77-270,385. PUB. 2-12-2008, FILED 9-3-2007.



THE COLOR(S) BLACK, GREEN AND YELLOW IS/ARE CLAIMED AS A FEATURE OF THE MARK.

CLASS 40—(Continued).

THE MARK CONSISTS OF THE WORD "PRECISIONJET" DISPLAYED WITH: (A) THE FIRST LETTER, "P", FORMED, OSTENSIBLY, BY YELLOW TURF FIBERS ARRANGED IN THE SHAPE OF A CAPITAL "P" AND SITUATED WITHIN A PATCH OF TURF FIBERS THAT IS OTHERWISE GREEN, WHEREIN SAID PATCH HAS A SHIELD-LIKE SHAPE WITH A BLACK BORDER AND PARTIALLY UNDERLAPS THE ADJACENT LETTER "R"; AND (B) THE REMAINING LETTERS "(RECI)SIONJET" IN OUTLINE FORMAT AND HAVING BLACK BORDERS.

FOR MANUFACTURE OF ARTIFICIAL TURF TO THE ORDER AND/OR SPECIFICATION OF OTHERS (U.S. CLS. 100, 103 AND 106).

FIRST USE 11-30-2007; IN COMMERCE 11-30-2007.

CLASS 41—EDUCATION AND ENTERTAINMENT

3,568,004. SOLJA LIFE RECORD INC., BRIDGE HAMPTON, NY. SN 76-646,472. PUB. 8-21-2007, FILED 9-8-2005.

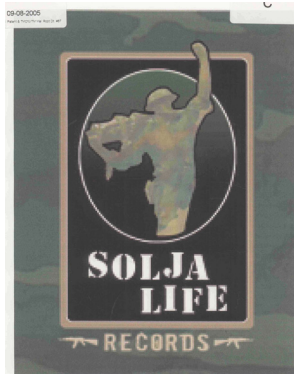

NO CLAIM IS MADE TO THE EXCLUSIVE RIGHT TO USE "RECORDS", APART FROM THE MARK AS SHOWN.

THE COLOR(S) BLACK, GREEN, BEIGE AND WHITE IS/ARE CLAIMED AS A FEATURE OF THE MARK.

THE COLOR BLACK APPEARS IN THE BACKGROUND, THE COLOR GREEN APPEARS IN THE CAMOUFLAGE PATTERN OF THE SOLDIER'S UNIFORM AND IN THE BACKGROUND THAT COMPRISES A CAMOUFLAGE PATTERN, THE COLOR BEIGE APPEARS IN THE BORDERLINE OF THE RECTANGLE, IN THE DESIGN OF THE RIFFLES AND IN THE WORD "RECORDS" AS WELL AS IN THE CAMOUFLAGE PATTERN OF THE SOLDIER'S UNIFORM AS IN THE BACKGROUND CAMOUFLAGE PATTERN, AND THE COLOR WHITE APPEARS IN THE OUTLINE OF THE CIRCLE AS WELL AS IN THE WORD "SOLJA LIFE".

FOR MUSIC PRODUCTION SERVICES (U.S. CLS. 100, 101 AND 107).

FIRST USE 8-16-2007; IN COMMERCE 8-16-2007.

CLASS 41—(Continued).

3,568,010. STARGAYZER, INC, CHARLOTTE, NC. SN 76-661,591. PUB. 7-1-2008, FILED 6-15-2006.

**LGBT-FRIENDLY CAMPUS
CLIMATE INDEX**

NO CLAIM IS MADE TO THE EXCLUSIVE RIGHT TO USE "LGBT" AND "INDEX", APART FROM THE MARK AS SHOWN.

FOR PROVIDING A WEB SITE AND DATABASE FEATURING EDUCATIONAL AND ACADEMIC INFORMATION CONCERNING THE LESBIAN GAY BISEXUAL AND TRANSEXUAL INCLUSIVE EDUCATIONAL AND ORGANIZATIONAL POLICIES AND PROGRAMS OF PARTICIPATING HIGHER LEARNING INSTITUTIONS; PROVIDING PARTICIPATING HIGHER LEARNING INSTITUTIONS ASSESSMENTS AND EDUCATIONAL BENCHMARKS TO EXAMINE THEIR INCLUSIVE EDUCATIONAL POLICIES AND PROGRAMS FOR LESBIAN GAY BISEXUAL AND TRANSEXUAL STUDENTS AND FOLLOW UP RECOMMENDATIONS FOR IMPROVEMENT (U.S. CLS. 100, 101 AND 107).

FIRST USE 9-15-2008; IN COMMERCE 9-15-2008.

3,568,011. STARGAYZER, INC, CHARLOTTE, NC. SN 76-661,710. PUB. 6-3-2008, FILED 6-16-2006.

GAY POINT AVERAGE

FOR EDUCATION AND ENTERTAINMENT SERVICES, NAMELY, PROVIDING MOTIVATIONAL AND EDUCATIONAL SPEAKING PROGRAM TO EDUCATE CAMPUS COMMUNITIES OF HIGHER EDUCATION ON LESBIAN, GAY, BISEXUAL AND TRANSGENDER INCLUSIVENESS; PROVIDING A WEB SITE AND DATABASE FEATURING EDUCATIONAL AND ACADEMIC INFORMATION CONCERNING THE LESBIAN GAY BISEXUAL AND TRANSEXUAL INCLUSIVE EDUCATIONAL AND ORGANIZATIONAL POLICIES AND PROGRAMS OF PARTICIPATING HIGHER LEARNING INSTITUTIONS; PROVIDING PARTICIPATING HIGHER LEARNING INSTITUTIONS ASSESSMENTS AND EDUCATIONAL BENCHMARKS TO EXAMINE THEIR INCLUSIVE EDUCATIONAL POLICIES AND PROGRAMS FOR LESBIAN GAY BISEXUAL AND TRANSEXUAL STUDENTS AND FOLLOW UP RECOMMENDATIONS FOR IMPROVEMENT (U.S. CLS. 100, 101 AND 107).

FIRST USE 9-15-1999; IN COMMERCE 9-15-2000.

CLASS 41—(Continued).

3,568,014. REDMOND, AMY C., BREAUX BRIDGE, LA. AND REDMOND, DANIEL J., BREAUX BRIDGE, LA. SN 76-670,388. PUB. 7-8-2008, FILED 12-15-2006.



FOR SERVICES HAVING THE BASIC AIM OF THE ENTERTAINMENT, AMUSEMENT AND RECREATION OF PEOPLE, NAMELY, MOTION PICTURE FILM PRODUCTION, DOCUMENTARY MOTION PICTURE PRODUCTION, TECHNICAL MOTION PICTURE FILM PRODUCTION, FIELD PHOTOGRAPHY, TELEVISION VIDEO AND TELEVISION FILM PRODUCTION, DIGITAL MOTION PICTURE FILM PRODUCTION; SPECIAL EVENT PLANNING, NAMELY, PLANNING EVENTS RELATED TO THE OPENING OF THEATRICAL PRODUCTIONS AND PLANNING EVENTS RELATED TO THE HOLIDAYS, SPECIAL OCCASIONS, CONVENTIONS, AND SOCIAL EVENTS; EDUCATION OF PEOPLE, NAMELY, THE PRODUCTION OF INSTRUCTIONAL MOTION PICTURES AIMED AT EDUCATING OR TEACHING IN THE FIELDS OF ARTS, CRAFTS, AND SUBJECTS OF EDUCATIONAL IMPORTANCE TO COLLEGES, UNIVERSITIES, HIGH SCHOOLS, OR GRADE SCHOOLS IN THE NATURE OF TECHNIQUES RELATED TO SPORTS, TRAVEL, LEISURE, COOKING, HOME REPAIR AND MAINTENANCE, AUTO MECHANICS, MILITARY MECHANICS, GOVERNMENT MILITARY TRAINING, BUSINESS OPERATIONS, BUSINESS STRATEGY, JOB TRAINING, PERSONAL RELATIONS, PERSONAL HYGIENE, MANNERS, DANCING, LANGUAGE, RELIGION, REAL ESTATE, TECHNICAL ASSISTANCE, AND JOB SKILLS, ALL FOR USE IN VARIOUS VIDEO SEMINARS, IN VIDEO CLASSES, IN EDUCATIONAL TELEVISION PROGRAMS, IN EDUCATIONAL PROGRAMS BROADCAST VIA THE INTERNET, AND IN VIDEO INSTRUCTIONAL COURSES (U.S. CLS. 100, 101 AND 107).

FIRST USE 8-23-2006; IN COMMERCE 12-7-2006.

3,568,015. THOMAS, STEPHEN, TOMS RIVER, NJ. SN 76-672,861. PUB. 3-18-2008, FILED 2-20-2007.

JUPITER JONES

THE NAME "JUPITER JONES" DOES NOT IDENTIFY A LIVING INDIVIDUAL.

FOR ENTERTAINMENT, NAMELY, LIVE PERFORMANCES BY A MUSICAL BAND (U.S. CLS. 100, 101 AND 107).

FIRST USE 2-10-2007; IN COMMERCE 2-25-2007.

CLASS 41—(Continued).

3,568,021. SOCIETY FOR HUMAN RESOURCE MANAGEMENT, ALEXANDRIA, VA. SN 76-677,596. PUB. 3-11-2008, FILED 5-30-2007.

CLASS 41—(Continued).

3,568,124. UNCLE SAM REALTY INC., SAN DIEGO, CA. SN 77-108,210. PUB. 8-14-2007, FILED 2-15-2007.

Be A Somebody



OWNER OF U.S. REG. NOS. 1,668,891, 3,108,608, AND OTHERS.

THE COLOR(S) BLUE AND WHITE IS/ARE CLAIMED AS A FEATURE OF THE MARK.

THE COLOR BLUE APPEARS IN THE BACKGROUND OF THE SQUARES. THE COLOR WHITE APPEARS IN THE WORD "SHRM" WHICH IS IN STYLIZED FORM WITH THE "H" AND "R" SHARING A COMMON BACKBONE WITHIN THREE SQUARES. THE "S" IS IN THE FIRST SQUARE, THE "HR" IS IN THE SECOND SQUARE AND THE "M" IS IN THE LAST SQUARE.

FOR ARRANGEMENT OF TRAINING COURSES; ARRANGING AND CONDUCTING EDUCATIONAL CONFERENCES, EXHIBITIONS, SEMINARS, PROFESSIONAL WORKSHOPS AND TRAINING COURSES; DEVELOPING EDUCATIONAL MANUALS AND MATERIALS FOR OTHERS, IN EACH CASE, IN THE FIELD OF HUMAN RESOURCE MANAGEMENT; EDUCATION IN THE FIELD OF HUMAN RESOURCE MANAGEMENT RENDERED THROUGH LIVE AND ONLINE CLASSES, SEMINARS, AND WORKSHOPS; EDUCATIONAL SERVICES, NAMELY, CONDUCTING INFORMAL ONLINE PROGRAMS IN THE FIELD OF HUMAN RESOURCE MANAGEMENT AND PRINTED MATERIALS DISTRIBUTED THEREWITH; INSTRUCTION IN THE FIELD OF HUMAN RESOURCE MANAGEMENT; MEETING AND SEMINAR ARRANGING; NEWSPAPER PUBLISHING; ONLINE PUBLICATIONS, NAMELY, ONLINE NEWSLETTERS, WRITTEN ARTICLES, WHITE PAPERS AND SURVEY REPORTS IN THE FIELD OF HUMAN RESOURCE MANAGEMENT; PROVIDING NEWSLETTERS IN THE FIELD OF HUMAN RESOURCE MANAGEMENT VIA EMAIL; PROVIDING ONLINE INFORMATION AND NEWS IN THE FIELD OF EMPLOYMENT TRAINING; PROVIDING RECOGNITION AND INCENTIVES BY WAY OF AWARDS TO DEMONSTRATE EXCELLENCE IN THE FIELD OF HUMAN RESOURCE MANAGEMENT; PUBLICATIONS, NAMELY, PROVIDING ONLINE MAGAZINES IN THE FIELD OF HUMAN RESOURCE MANAGEMENT; TEACHING IN THE FIELD OF HUMAN RESOURCE MANAGEMENT; TRAINING SERVICES IN THE FIELD OF HUMAN RESOURCE MANAGEMENT (U.S. CLS. 100, 101 AND 107).

FIRST USE 6-25-2007; IN COMMERCE 6-25-2007.

THE MARK CONSISTS OF STANDARD CHARACTERS WITHOUT CLAIM TO ANY PARTICULAR FONT, STYLE, SIZE, OR COLOR.

FOR ENTERTAINMENT IN THE NATURE OF ONGOING TELEVISION PROGRAMS IN THE FIELD OF VARIETY AND AMATEUR TALENT SHOWS; ENTERTAINMENT SERVICES, NAMELY, PROVIDING A TELEVISION PROGRAM IN THE FIELD OF VARIETY AND AMATEUR TALENT SHOWS VIA A GLOBAL COMPUTER NETWORK; ENTERTAINMENT SERVICES, NAMELY, PROVIDING A WEB SITE FEATURING MUSICAL PERFORMANCES, MUSICAL VIDEOS, RELATED FILM CLIPS, PHOTOGRAPHS, AND OTHER MULTIMEDIA MATERIALS; ENTERTAINMENT SERVICES, NAMELY, PROVIDING AN ON-LINE COMPUTER GAME (U.S. CLS. 100, 101 AND 107).

FIRST USE 11-15-2007; IN COMMERCE 11-15-2007.

3,568,132. SIMON WIESENTHAL CENTER, LOS ANGELES, CA. SN 77-118,317. PUB. 3-11-2008, FILED 2-28-2007.

UNDERSTANDING ROOM ONLY

THE MARK CONSISTS OF STANDARD CHARACTERS WITHOUT CLAIM TO ANY PARTICULAR FONT, STYLE, SIZE, OR COLOR.

FOR EDUCATIONAL SERVICES, NAMELY, CONDUCTING SEMINARS, WORKSHOPS AND DISCUSSIONS IN THE FIELD OF MULTI-CULTURAL, RACIAL, GENDER-BASED, SOCIOECONOMIC STATUS, SEXUAL PREFERENCE, RELIGIOUS DIVERSITY, AND TOLERANCE; AND PROVIDING PROGRAM GUIDES AND SOURCE BOOKS IN SUPPORT THEREOF (U.S. CLS. 100, 101 AND 107).

FIRST USE 3-1-2008; IN COMMERCE 10-28-2008.

CLASS 41—(Continued).

3,568,133. SIMON WIESENTHAL CENTER, LOS ANGELES, CA. SN 77-118,328. PUB. 3-11-2008, FILED 2-28-2007.

MOTIVATED

THE MARK CONSISTS OF STANDARD CHARACTERS WITHOUT CLAIM TO ANY PARTICULAR FONT, STYLE, SIZE, OR COLOR.

FOR EDUCATIONAL SERVICES, NAMELY, CONDUCTING SEMINARS, WORKSHOPS AND DISCUSSIONS IN THE FIELD OF MULTI-CULTURAL, RACIAL, GENDER-BASED, SOCIOECONOMIC STATUS, SEXUAL PREFERENCE, RELIGIOUS DIVERSITY, AND TOLERANCE; AND PROVIDING PROGRAM GUIDES AND SOURCE BOOKS IN SUPPORT THEREOF (U.S. CLS. 100, 101 AND 107).
FIRST USE 9-25-2008; IN COMMERCE 10-28-2008.

3,568,144. ONDECK RECORDS AND ASSOCIATES, INC., ATLANTA, GA. SN 77-127,460. PUB. 9-4-2007, FILED 3-9-2007.

SHOP BOYZ

THE MARK CONSISTS OF STANDARD CHARACTERS WITHOUT CLAIM TO ANY PARTICULAR FONT, STYLE, SIZE, OR COLOR.

NO CLAIM IS MADE TO THE EXCLUSIVE RIGHT TO USE "BOYS", APART FROM THE MARK AS SHOWN.
FOR ENTERTAINMENT SERVICES, NAMELY, PERFORMANCES BY A LIVE MUSICAL GROUP AND PROVIDING PRERECORDED MUSIC ONLINE AND INFORMATION REGARDING A MUSICAL GROUP ONLINE VIA A GLOBAL COMPUTER NETWORK (U.S. CLS. 100, 101 AND 107).
FIRST USE 6-19-2007; IN COMMERCE 6-19-2007.

3,568,189. DANIEL P. GAY, SAGINAW, MI. SN 77-168,044. PUB. 10-23-2007, FILED 4-27-2007.



THE MARK CONSISTS OF A STYLIZED LETTER "D" WITH TWO HANDWRITTEN LETTERS "E".
FOR LIVE PERFORMANCES BY A MUSICAL ARTIST; AUDIO RECORDING AND PRODUCTION SERVICES (U.S. CLS. 100, 101 AND 107).
FIRST USE 7-1-2008; IN COMMERCE 7-1-2008.

CLASS 41—(Continued).

3,568,198. BRENNAN, BRIAN A, CHICAGO, IL. SN 77-172,884. PUB. 7-29-2008, FILED 5-4-2007.

Patch of Grass Publishing

THE MARK CONSISTS OF STANDARD CHARACTERS WITHOUT CLAIM TO ANY PARTICULAR FONT, STYLE, SIZE, OR COLOR.

NO CLAIM IS MADE TO THE EXCLUSIVE RIGHT TO USE "PUBLISHING", APART FROM THE MARK AS SHOWN.
FOR BOOK PUBLISHING (U.S. CLS. 100, 101 AND 107).
FIRST USE 3-20-2006; IN COMMERCE 3-20-2006.

3,568,215. LIMETREE ENTERPRISES INC, LIVINGSTON, NJ. SN 77-185,585. PUB. 11-6-2007, FILED 5-20-2007.

Cashmere

THE MARK CONSISTS OF STANDARD CHARACTERS WITHOUT CLAIM TO ANY PARTICULAR FONT, STYLE, SIZE, OR COLOR.

FOR ENTERTAINMENT IN THE NATURE OF LIVE PERFORMANCES BY MUSICIANS AND SINGERS (U.S. CLS. 100, 101 AND 107).
FIRST USE 1-1-2008; IN COMMERCE 1-1-2008.

3,568,232. MAIN STREET PICTURES, INC., HOLLYWOOD, CA. SN 77-202,206. PUB. 5-20-2008, FILED 6-10-2007.

Main Street Pictures

THE MARK CONSISTS OF STANDARD CHARACTERS WITHOUT CLAIM TO ANY PARTICULAR FONT, STYLE, SIZE, OR COLOR.

NO CLAIM IS MADE TO THE EXCLUSIVE RIGHT TO USE "PICTURES", APART FROM THE MARK AS SHOWN.
FOR PRODUCTION AND DISTRIBUTION OF MOTION PICTURES AND TELEVISION PROGRAMS AND CONSULTING SERVICES IN THE FIELD OF DIGITAL MEDIA PRODUCTION (U.S. CLS. 100, 101 AND 107).
FIRST USE 11-28-2006; IN COMMERCE 5-22-2007.

CLASS 41—(Continued).

3,568,237. NSS MUSIC, INC., NEW YORK, NY. SN 77-207,935.
PUB. 5-6-2008, FILED 6-16-2007.

NSS MUSIC NOT JUST A LABEL

THE MARK CONSISTS OF STANDARD CHARACTERS WITHOUT CLAIM TO ANY PARTICULAR FONT, STYLE, SIZE, OR COLOR.

FOR ENTERTAINMENT SERVICES IN THE NATURE OF RECORDING, PRODUCTION AND POST-PRODUCTION SERVICES IN THE FIELD OF MUSIC; PROVIDING PRERECORDED MUSIC AND VIDEOS ON-LINE VIA A GLOBAL COMPUTER NETWORK (U.S. CLS. 100, 101 AND 107).

FIRST USE 9-1-2007; IN COMMERCE 9-1-2007.

3,568,238. RIMBACK, GRANT R., ROCKFORD, TN. AND RIMBACK, DANA S., MARYVILLE, TN. SN 77-209,101.
PUB. 6-24-2008, FILED 6-18-2007.



THE MARK CONSISTS OF A CIRCLE REPRESENTING THE PLANET EARTH, AN AIRPLANE WITH ITS JET STREAM WRAPPING AROUND THE PLANET EARTH CIRCLE, THE WORDS "GOD'S PLANET" WRAPPING AROUND CENTER OF PLANET EARTH CIRCLE.

FOR EDUCATIONAL SERVICES, NAMELY, DEVELOPING CURRICULUM FOR OTHERS IN THE FIELD OF RELIGIOUS EDUCATION (U.S. CLS. 100, 101 AND 107).

FIRST USE 4-5-2006; IN COMMERCE 9-15-2008.

3,568,254. VIACOM INTERNATIONAL INC., NEW YORK, NY. SN 77-227,240. PUB. 3-11-2008, FILED 7-11-2007.

MEET OR DELETE: MY NEW LIFE

THE MARK CONSISTS OF STANDARD CHARACTERS WITHOUT CLAIM TO ANY PARTICULAR FONT, STYLE, SIZE, OR COLOR.

CLASS 41—(Continued).

OWNER OF U.S. REG. NO. 3,209,211.

FOR ENTERTAINMENT SERVICES IN THE NATURE OF TELEVISION SERIES, FEATURING LIVE ACTION, COMEDY AND DRAMA; PROVIDING ONLINE INFORMATION IN THE FIELD OF ENTERTAINMENT CONCERNING TELEVISION PROGRAMS (U.S. CLS. 100, 101 AND 107).

FIRST USE 8-23-2007; IN COMMERCE 8-23-2007.

3,568,266. CULINAERIE DC LLC, WASHINGTON, DC. SN 77-236,480. PUB. 3-25-2008, FILED 7-23-2007.



NO CLAIM IS MADE TO THE EXCLUSIVE RIGHT TO USE "CULINARY" AND "FOOD & WINE INSTRUCTION", APART FROM THE MARK AS SHOWN.

THE COLOR(S) LIGHT GREEN AND DARK GREEN IS/ARE CLAIMED AS A FEATURE OF THE MARK.

THE MARK CONSISTS OF THE WORDS "CULINAERIE THE PINNACLE OF FOOD & WINE INSTRUCTION" IN DARK GREEN, STYLIZED, MIXED CASE TEXT, THE UPPERCASE LETTER "C" IN "CULIN" IS SUPERIMPOSED OVER A LIGHT GREEN, UPPERCASE STYLIZED "C" IN A LIGHT GREEN CURSIVE FONT. THE LOWERCASE LETTER "N" IN "CULIN" AND THE LEFT SIDE OF THE UPPERCASE LETTER "A" IN "AERIE" ARE SUPERIMPOSED OVER A STYLIZED IMAGE OF A PHEASANT WHERE THE PHEASANT'S WINGS AND TAIL FORM A LIGHT GREEN, UPPERCASE STYLIZED "A" IN A CURSIVE FONT. THE WORDS "THE PINNACLE OF FOOD & WINE INSTRUCTION" APPEAR BENEATH THE WORD "CULINAERIE" IN DARK GREEN, STYLIZED, MIXED CASE TEXT. THE COLOR WHITE REPRESENTS THE BACKGROUND AND IS NOT A FEATURE OF THE MARK.

FOR EDUCATIONAL SERVICES, NAMELY, CONDUCTING RECREATIONAL INSTRUCTIONAL CLASSES AND SINGLE-SESSION TEAM BUILDING CLASSES ON THE SUBJECTS OF THE CULINARY ARTS, COOKING, FOOD PREPARATION, WINE APPRECIATION, AND FOOD AND WINE PAIRING; AND ENTERTAINMENT SERVICES, NAMELY, ORGANIZING AND CONDUCTING RECREATIONAL AND SOCIAL EVENTS FEATURING COOKING DEMONSTRATIONS, COOKING COMPETITIONS AND FOOD AND WINE TASTINGS; AND CONDUCTING PRIVATE PARTIES FOR OTHERS IN THE CULINARY FIELD (U.S. CLS. 100, 101 AND 107).

FIRST USE 4-30-2008; IN COMMERCE 4-30-2008.

CLASS 41—(Continued).

3,568,305. WHITNEY INTERNATIONAL UNIVERSITY, LTD., HAMILTON, BERMUDA. SN 77-265,243. PUB. 2-26-2008, FILED 8-27-2007.

WHITNEY INTERNATIONAL UNIVERSITY SYSTEM

THE MARK CONSISTS OF STANDARD CHARACTERS WITHOUT CLAIM TO ANY PARTICULAR FONT, STYLE, SIZE, OR COLOR.

NO CLAIM IS MADE TO THE EXCLUSIVE RIGHT TO USE "INTERNATIONAL UNIVERSITY SYSTEM", APART FROM THE MARK AS SHOWN.

FOR PROVIDING COURSES OF INSTRUCTION AT THE COLLEGE AND POST GRADUATE LEVEL (U.S. CLS. 100, 101 AND 107).

FIRST USE 7-1-2006; IN COMMERCE 8-30-2006.

3,568,337. TELEVISA, S.A. DE C.V., COL. SANTA FE ZEDEC, MEXICO. SN 77-280,824. PUB. 3-4-2008, FILED 9-17-2007.

MUCHACHITAS COMO TU

THE MARK CONSISTS OF STANDARD CHARACTERS WITHOUT CLAIM TO ANY PARTICULAR FONT, STYLE, SIZE, OR COLOR.

THE FOREIGN WORDING IN THE MARK TRANSLATES INTO ENGLISH AS "LITTLE WOMEN LIKE YOU."

FOR ENTERTAINMENT SERVICES, NAMELY, AN ON-GOING DRAMATIC TELEVISION PROGRAM (U.S. CLS. 100, 101 AND 107).

FIRST USE 7-14-2008; IN COMMERCE 7-14-2008.

3,568,339. SULLIVAN, DON, LA QUINTA, CA. SN 77-281,213. PUB. 3-11-2008, FILED 9-17-2007.

DOGFATHER

THE MARK CONSISTS OF STANDARD CHARACTERS WITHOUT CLAIM TO ANY PARTICULAR FONT, STYLE, SIZE, OR COLOR.

FOR DOG TRAINING (U.S. CLS. 100, 101 AND 107). FIRST USE 5-28-2008; IN COMMERCE 5-28-2008.

CLASS 41—(Continued).

3,568,362. WORLD WRESTLING ENTERTAINMENT, INC., STAMFORD, CT. SN 77-288,072. PUB. 2-26-2008, FILED 9-25-2007.

THE HEARTBREAK KID

THE MARK CONSISTS OF STANDARD CHARACTERS WITHOUT CLAIM TO ANY PARTICULAR FONT, STYLE, SIZE, OR COLOR.

FOR ENTERTAINMENT SERVICES, NAMELY, WRESTLING EXHIBITIONS AND PERFORMANCES BY A PROFESSIONAL WRESTLER AND ENTERTAINER; PROVIDING WRESTLING NEWS AND INFORMATION VIA A GLOBAL COMPUTER NETWORK (U.S. CLS. 100, 101 AND 107).

FIRST USE 12-31-1991; IN COMMERCE 12-31-1991.

3,568,372. GREATER PHILADELPHIA TOURISM MARKETING CORPORATION, PHILADELPHIA, PA. SN 77-292,670. PUB. 3-18-2008, FILED 10-1-2007.

ILLADATES

THE MARK CONSISTS OF STANDARD CHARACTERS WITHOUT CLAIM TO ANY PARTICULAR FONT, STYLE, SIZE, OR COLOR.

FOR PROVIDING AN ONLINE PUBLICATION IN THE NATURE OF A GUIDE IN THE FIELD OF ENTERTAINMENT IN THE PHILADELPHIA REGION (U.S. CLS. 100, 101 AND 107).

FIRST USE 10-31-2007; IN COMMERCE 10-31-2007.

3,568,378. GRACE SCHOOLS, INC., WINONA LAKE, IN. SN 77-293,972. PUB. 3-18-2008, FILED 10-2-2007.



NO CLAIM IS MADE TO THE EXCLUSIVE RIGHT TO USE "ONLINE", APART FROM THE MARK AS SHOWN.

THE MARK CONSISTS OF STYLIZED LETTERING OF THE WORDS "GRACE ONLINE A WORLD OF LEARNING".

FOR EDUCATION SERVICES IN THE NATURE OF COURSES AT THE UNIVERSITY LEVEL (U.S. CLS. 100, 101 AND 107).

FIRST USE 5-1-2008; IN COMMERCE 5-1-2008.

CLASS 41—(Continued).

3,568,379. BIG NIGHT IN TENT, LLC, NEW YORK, NY. SN 77-294,027. PUB. 3-18-2008, FILED 10-2-2007.

BIG NIGHT IN TENT

THE MARK CONSISTS OF STANDARD CHARACTERS WITHOUT CLAIM TO ANY PARTICULAR FONT, STYLE, SIZE, OR COLOR.

FOR ENTERTAINMENT SERVICES, NAMELY, LIVE PERFORMANCES BY TRAVELING SPEAKERS, COMEDIANS, MUSICIANS, AUTHORS, STORYTELLERS, ACADEMICS AND CELEBRITIES (U.S. CLS. 100, 101 AND 107).

FIRST USE 7-0-2007; IN COMMERCE 2-0-2008.

3,568,386. VEROPEDIA, INC., ST. PETERSBURG, FL. SN 77-295,358. PUB. 3-18-2008, FILED 10-3-2007.

VEROPEDIA

THE MARK CONSISTS OF STANDARD CHARACTERS WITHOUT CLAIM TO ANY PARTICULAR FONT, STYLE, SIZE, OR COLOR.

FOR PROVIDING INFORMATION IN THE FIELD OF GENERAL ENCYCLOPEDIA KNOWLEDGE VIA THE INTERNET (U.S. CLS. 100, 101 AND 107).

FIRST USE 10-10-2007; IN COMMERCE 10-10-2007.

3,568,391. SCHOLASTIC INC., NEW YORK, NY. SN 77-297,506. PUB. 6-17-2008, FILED 10-5-2007.

AUTHOR TUBE

THE MARK CONSISTS OF STANDARD CHARACTERS WITHOUT CLAIM TO ANY PARTICULAR FONT, STYLE, SIZE, OR COLOR.

NO CLAIM IS MADE TO THE EXCLUSIVE RIGHT TO USE "AUTHOR", APART FROM THE MARK AS SHOWN.

FOR COMPUTER ON-LINE SERVICES, NAMELY, PROVIDING AN INTERNET WEBSITE FEATURING INTERACTIVE CHILDREN'S BOOK DISCUSSIONS AND ENTERTAINMENT AND EDUCATIONAL INFORMATION FEATURING FULL MOTION VIDEOS OF INTERVIEWS AND READINGS BY CHILDREN'S BOOK AUTHORS AND CHILDREN'S BOOK ILLUSTRATORS, AND VIDEO BOOK TALKS RELATING TO CHILDREN'S BOOKS, CHILDREN'S BOOK AUTHORS AND ILLUSTRATORS, AND READING (U.S. CLS. 100, 101 AND 107).

FIRST USE 1-30-2008; IN COMMERCE 1-30-2008.

CLASS 41—(Continued).

3,568,404. EBSCO INDUSTRIES, INC., BIRMINGHAM, AL. SN 77-304,095. PUB. 3-18-2008, FILED 10-15-2007.

BIG WATER ADVENTURES

THE MARK CONSISTS OF STANDARD CHARACTERS WITHOUT CLAIM TO ANY PARTICULAR FONT, STYLE, SIZE, OR COLOR.

FOR ENTERTAINMENT IN THE NATURE OF ONGOING TELEVISION PROGRAMS IN THE FIELD OF FISHING; ENTERTAINMENT, NAMELY, A CONTINUING FISHING SHOW BROADCAST OVER TELEVISION, SATELLITE, AND VIDEO MEDIA (U.S. CLS. 100, 101 AND 107).

FIRST USE 1-1-2007; IN COMMERCE 1-1-2007.

3,568,411. MARTIN, HELEN, STUART, FL. SN 77-309,823. PUB. 4-1-2008, FILED 10-22-2007.



THE COLOR(S) PINK AND BLACK IS/ARE CLAIMED AS A FEATURE OF THE MARK.

THE MARK CONSISTS OF FANCIFUL IMAGE OF A WOMAN SWINGING A GOLF CLUB IN PINK AND SHOWING THE SWING PATH IN BLACK.

FOR PROVIDING A WEBSITE THROUGH WHICH GOLFERS LOCATE GOLF INSTRUCTION INFORMATION AND INFORMATION ABOUT GOLF COURSES AND GOLF TOURNAMENTS; ENTERTAINMENT IN THE NATURE OF GOLF TOURNAMENTS; AND WORKSHOPS AND SEMINARS IN THE FIELD OF GOLF (U.S. CLS. 100, 101 AND 107).

FIRST USE 3-15-2006; IN COMMERCE 11-15-2007.

CLASS 41—(Continued).

3,568,414. NATIONAL ACADEMY OF RECORDING ARTS & SCIENCES, INC., SANTA MONICA, CA. SN 77-311,940. PUB. 4-8-2008, FILED 10-24-2007.

CLASS 41—(Continued).

3,568,434. SCHOLASTIC INC., NEW YORK, NY. SN 77-328,589. PUB. 7-29-2008, FILED 11-13-2007.

GRAMMY MUSEUM

THE MARK CONSISTS OF STANDARD CHARACTERS WITHOUT CLAIM TO ANY PARTICULAR FONT, STYLE, SIZE, OR COLOR.

OWNER OF U.S. REG. NOS. 2,630,880, 3,202,214, AND OTHERS.

NO CLAIM IS MADE TO THE EXCLUSIVE RIGHT TO USE "MUSEUM", APART FROM THE MARK AS SHOWN, FOR MUSEUM SERVICES (U.S. CLS. 100, 101 AND 107).

FIRST USE 12-3-2008; IN COMMERCE 12-3-2008.



3,568,418. SCHOLASTIC INC., NEW YORK, NY. SN 77-315,710. PUB. 2-26-2008, FILED 10-29-2007.

THE 39 CLUES

THE MARK CONSISTS OF STANDARD CHARACTERS WITHOUT CLAIM TO ANY PARTICULAR FONT, STYLE, SIZE, OR COLOR.

FOR ONLINE ACTIVITIES PROVIDING ONLINE EDUCATIONAL AND ENTERTAINMENT SERVICES, NAMELY, A WEBSITE FEATURING INFORMATION ABOUT A SERIES OF FICTION BOOKS FOR CHILDREN, INTERACTIVE GAMES, INTERACTIVE BOOKS, INTERACTIVE DIGITAL CARD GAMES AND LEARNING ACTIVITIES, NAMELY, USING CLUES TO SOLVE MYSTERIES (U.S. CLS. 100, 101 AND 107).

FIRST USE 9-18-2008; IN COMMERCE 9-18-2008.



SAMMY'S STORY SHOP

THE MARK CONSISTS OF STANDARD CHARACTERS WITHOUT CLAIM TO ANY PARTICULAR FONT, STYLE, SIZE, OR COLOR.

FOR ENTERTAINMENT SERVICES, NAMELY, AN ANIMATED TELEVISION PROGRAM FOR CHILDREN (U.S. CLS. 100, 101 AND 107).

FIRST USE 11-3-2008; IN COMMERCE 11-3-2008.



3,568,431. HATANAKA, MINORU, TOKYO, JAPAN. SN 77-327,835. PUB. 4-22-2008, FILED 11-13-2007.

3,568,435. SCHOLASTIC INC., NEW YORK, NY. SN 77-328,623. PUB. 7-29-2008, FILED 11-13-2007.

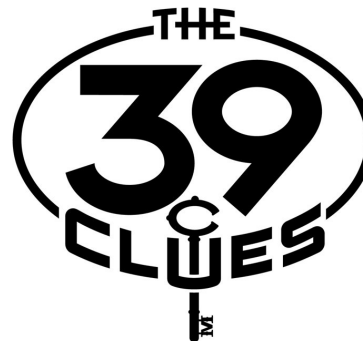

CARE-FIT

THE MARK CONSISTS OF STANDARD CHARACTERS WITHOUT CLAIM TO ANY PARTICULAR FONT, STYLE, SIZE, OR COLOR.

FOR PROVIDING TRAINING AND EDUCATION SERVICES, NAMELY, CLASSES, SEMINARS, WORKSHOPS AND PROGRAMS FOR FOSTERING THE PROFESSIONAL DEVELOPMENT OF CARETAKERS; EDUCATIONAL TESTING IN THE FIELD OF CARE-TAKING SKILLS (U.S. CLS. 100, 101 AND 107).

FIRST USE 11-1-1999; IN COMMERCE 6-22-2006.

THE MARK CONSISTS OF THE LITERAL ELEMENT ENCOMPASSED BY A CIRCLE DESIGN WITH A KEY DESIGN AT THE BASE.

FOR ONLINE ACTIVITIES PROVIDING ONLINE EDUCATIONAL AND ENTERTAINMENT SERVICES, NAMELY, A WEBSITE FEATURING INFORMATION ABOUT A SERIES OF FICTION BOOKS FOR CHILDREN, INTERACTIVE GAMES, INTERACTIVE BOOKS, INTERACTIVE DIGITAL CARD GAMES AND LEARNING ACTIVITIES, NAMELY, USING CLUES TO SOLVE MYSTERIES (U.S. CLS. 100, 101 AND 107).

FIRST USE 9-18-2008; IN COMMERCE 9-18-2008.

CLASS 41—(Continued).

3,568,436. NATIONAL ASSOCIATION FOR STOCK CAR AUTO RACING, INC., DAYTONA BEACH, FL. SN 77-328,902. PUB. 4-22-2008, FILED 11-14-2007.



OWNER OF U.S. REG. NO. 2,788,562.
NO CLAIM IS MADE TO THE EXCLUSIVE RIGHT TO USE "MEDIA GROUP", APART FROM THE MARK AS SHOWN.

THE MARK CONSISTS OF SLANTED BARS WITH THE WORD "NASCAR" INSIDE, CHECKERED FLAG AND THE WORDS "MEDIA GROUP" BELOW; ALL ENCLOSED BY A SLANTED BOX.

FOR MULTIMEDIA ENTERTAINMENT SERVICES IN THE NATURE OF RECORDING, PRODUCTION AND POST-PRODUCTION SERVICES IN THE FIELDS OF VIDEO AND FILMS (U.S. CLS. 100, 101 AND 107).
FIRST USE 1-1-2008; IN COMMERCE 1-1-2008.

3,568,456. THE FINLANDIA FOUNDATION, INC., PASADENA, CA. SN 77-342,560. PUB. 5-6-2008, FILED 12-3-2007.



NO CLAIM IS MADE TO THE EXCLUSIVE RIGHT TO USE "CAMP", APART FROM THE MARK AS SHOWN.

THE MARK CONSISTS OF THE WORD "SOIVA" SUPERIMPOSED OVER A MUSICAL STAFF WITH THE LETTER "S" DEPICTED AS A "G" CLEF AND THE LETTER "I" DOTTED WITH A QUARTER NOTE AND THE WORD "CAMP" BELOW THE BOTTOM RIGHT-HAND CORNER OF THE MUSICAL STAFF.

THE ENGLISH TRANSLATION OF THE WORD "SOIVA" IN THE MARK IS SOUNDING WITH A BEAUTIFUL RING.
FOR MUSIC CAMPS (U.S. CLS. 100, 101 AND 107).
FIRST USE 1-0-2008; IN COMMERCE 1-0-2008.

CLASS 41—(Continued).

3,568,496. LAXTON, TERRY, BELLEVUE, WA. SN 77-378,383. PUB. 7-22-2008, FILED 1-23-2008.

FAMILY LEGACY BANK

THE MARK CONSISTS OF STANDARD CHARACTERS WITHOUT CLAIM TO ANY PARTICULAR FONT, STYLE, SIZE, OR COLOR.

NO CLAIM IS MADE TO THE EXCLUSIVE RIGHT TO USE "FAMILY LEGACY", APART FROM THE MARK AS SHOWN.

FOR EDUCATIONAL SERVICES, NAMELY, WORKSHOPS AND SEMINARS IN THE FIELD OF VALUES, ATTITUDES AND BEHAVIORS IN ONE'S BACKGROUND OR ANCESTRY AND DISTRIBUTING COURSE MATERIALS, PROGRAM GUIDES AND MANUALS, BROCHURES, AND PRESENTATION HANDOUTS IN CONNECTION THEREWITH (U.S. CLS. 100, 101 AND 107).

FIRST USE 2-21-2007; IN COMMERCE 2-21-2007.

3,568,504. SWALLOW PRODUCTIONS, LLC, LAS VEGAS, NV. SN 77-396,291. PUB. 7-1-2008, FILED 2-13-2008.

NORP

THE MARK CONSISTS OF STANDARD CHARACTERS WITHOUT CLAIM TO ANY PARTICULAR FONT, STYLE, SIZE, OR COLOR.

FOR ENTERTAINMENT SERVICES, NAMELY, PROVIDING A WEB SITE FEATURING PHOTOGRAPHIC, AUDIO, VIDEO AND PROSE PRESENTATIONS FEATURING ADULT ENTERTAINMENT (U.S. CLS. 100, 101 AND 107).

FIRST USE 8-3-2007; IN COMMERCE 6-1-2008.

3,568,518. ENDGAME ENTERPRISES, LLC, WESTMINSTER, CO. SN 77-410,630. PUB. 7-15-2008, FILED 3-1-2008.

Letters From Us

THE MARK CONSISTS OF STANDARD CHARACTERS WITHOUT CLAIM TO ANY PARTICULAR FONT, STYLE, SIZE, OR COLOR.

FOR PROVIDING ON-LINE, NON-DOWNLOADABLE PUBLICATIONS IN THE NATURE OF CARTOON STRIPS ON TOPICS RELATED TO SPIRITUALITY, RELIGION, EVOLUTION AND NEUROPHILOSOPHY (U.S. CLS. 100, 101 AND 107).

FIRST USE 5-1-2008; IN COMMERCE 8-19-2008.

CLASS 41—(Continued).

3,568,519. COMPETITOR GROUP, INC., SAN DIEGO, CA. SN 77-411,388. PUB. 7-22-2008, FILED 3-3-2008.



NO CLAIM IS MADE TO THE EXCLUSIVE RIGHT TO USE "GROUP", APART FROM THE MARK AS SHOWN.

THE COLOR(S) BLACK, BLUE AND GRAY IS/ARE CLAIMED AS A FEATURE OF THE MARK.

THE MARK CONSISTS OF A CURVED BAND IN THE COLOR GRAY LOCATED ABOVE A CURVED BAND IN THE COLOR BLUE, BOTH CENTERED ABOVE THE WORDS "COMPETITOR" IN THE COLOR BLACK AND "GROUP" IN THE COLOR GRAY. THE COLOR WHITE CONSTITUTES BACKGROUND AND IS NOT PART OF THE MARK.

FOR ENTERTAINMENT IN THE NATURE OF ORGANIZING A SPORTING EVENT IN THE NATURE OF A RUNNING RACE AND RELATED SPORTING AND ENTERTAINMENT EVENTS, NAMELY, ORGANIZING COMMUNITY FAIRS FEATURING VENDOR BOOTHS OF FOOD AND RACE RELATED SPORTING GOODS, AND PLANNING PARTIES AND DINNERS (U.S. CLS. 100, 101 AND 107).

FIRST USE 10-15-2008; IN COMMERCE 10-15-2008.

3,568,550. THE RED BAND FILM COMPANY, WINTER HAVEN, FL. SN 77-446,824. PUB. 9-2-2008, FILED 4-12-2008.

**TOSSED OFF TRY TO SURVIVE
TRY NOT TO SUCK**

THE MARK CONSISTS OF STANDARD CHARACTERS WITHOUT CLAIM TO ANY PARTICULAR FONT, STYLE, SIZE, OR COLOR.

FOR ENTERTAINMENT, NAMELY, A CONTINUING SCRIPTED COMEDY SHOW BROADCAST OVER TELEVISION, SATELLITE, AUDIO, AND VIDEO MEDIA (U.S. CLS. 100, 101 AND 107).

FIRST USE 3-1-2008; IN COMMERCE 3-1-2008.

3,568,554. PARK, BRADLEE CRAIG, DBA AMERICA'S NEXT MOVIE STAR, DIAMOND BAR, CA. SN 77-451,228. PUB. 9-9-2008, FILED 4-17-2008.

AMERICA'S NEXT MOVIE STAR

THE MARK CONSISTS OF STANDARD CHARACTERS WITHOUT CLAIM TO ANY PARTICULAR FONT, STYLE, SIZE, OR COLOR.

CLASS 41—(Continued).

NO CLAIM IS MADE TO THE EXCLUSIVE RIGHT TO USE "AMERICA'S" AND "MOVIE STAR", APART FROM THE MARK AS SHOWN.

FOR TELEVISION PRODUCTION; TELEVISION PROGRAM SYNDICATION; TELEVISION SHOW PRODUCTION; ENTERTAINMENT SERVICES IN THE NATURE OF AN ON-GOING REALITY BASED TELEVISION PROGRAM; ENTERTAINMENT SERVICES, NAMELY, LIVE, TELEVISED AND MOVIE APPEARANCES BY A PROFESSIONAL ENTERTAINER (U.S. CLS. 100, 101 AND 107).

FIRST USE 10-15-2007; IN COMMERCE 3-1-2008.

3,568,569. SPORTS WIDOW ENTERTAINMENT LLC, SEATTLE, WA. SN 78-292,001. PUB. 9-13-2005, FILED 8-25-2003.

SPORTS WIDOW

OWNER OF U.S. REG. NO. 2,229,248.

NO CLAIM IS MADE TO THE EXCLUSIVE RIGHT TO USE "SPORTS", APART FROM THE MARK AS SHOWN.

FOR ENTERTAINMENT AND EDUCATIONAL SERVICES IN THE FIELD OF SPORTS, NAMELY, TELEVISION AND RADIO PROGRAMMING; PROGRAMMING IN THE FIELD OF SPORTS ON A GLOBAL COMPUTER NETWORK; PRODUCTION OF VIDEOTAPES, CD-ROM AND DVD DISCS CONTAINING PROGRAMMING IN THE FIELD OF SPORTS (U.S. CLS. 100, 101 AND 107).

FIRST USE 10-31-2008; IN COMMERCE 10-31-2008.

3,568,571. PROCTER & GAMBLE COMPANY, THE, CINCINNATI, OH. SN 78-292,348. PUB. 2-27-2007, FILED 8-26-2003.

HOME MADE SIMPLE

OWNER OF U.S. REG. NOS. 2,564,637, 2,599,648, AND OTHERS.

FOR ENTERTAINMENT IN THE NATURE OF ON-GOING TELEVISION PROGRAMS ABOUT HOME OWNERSHIP, CLEANING, COOKING, GARDENING, PAINTING, ORGANIZING, DECORATING AND OTHER RELATED HOME ACTIVITIES (U.S. CLS. 100, 101 AND 107).

FIRST USE 6-30-2006; IN COMMERCE 6-30-2006.

CLASS 41—(Continued).

3,568,605. AGRIMUM ADVANCED TECHNOLOGIES (U.S.) INC., SYLACAUGA, AL. SN 78-646,937. PUB. 5-15-2007, FILED 6-9-2005.

HORTICOLLEGE

THE MARK CONSISTS OF STANDARD CHARACTERS WITHOUT CLAIM TO ANY PARTICULAR FONT, STYLE, SIZE, OR COLOR.

FOR EDUCATIONAL SERVICES, NAMELY, PROVIDING CLASSES, SEMINARS, WORKSHOPS AND INSTRUCTION IN THE FIELD OF BEST MANAGEMENT PRACTICES FOR NURSERY PROFESSIONALS, AND DISTRIBUTING INSTRUCTIONAL MATERIAL IN CONNECTION THEREWITH (U.S. CLS. 100, 101 AND 107).
FIRST USE 0-0-2006; IN COMMERCE 0-0-2006.

3,568,618. SEROPIAN, HAGOP SEVAG, NICOSIA, CYPRUS. SN 78-717,100. PUB. 9-5-2006, FILED 9-20-2005.

KOHAR

THE MARK CONSISTS OF STANDARD CHARACTERS WITHOUT CLAIM TO ANY PARTICULAR FONT, STYLE, SIZE, OR COLOR.

FOR EDUCATIONAL SERVICES, NAMELY, CONDUCTING SEMINARS, CLASSES, SEMINARS, CONFERENCES, AND WORKSHOPS IN THE FIELD OF ARMENIAN CULTURAL HERITAGE; ENTERTAINMENT SERVICES, NAMELY, CONDUCTING FAIRS HONORING ARMENIAN CULTURE AND HERITAGE; ORGANIZING EXHIBITIONS FOR CULTURAL PURPOSES IN THE FIELD OF ARMENIAN HERITAGE (U.S. CLS. 100, 101 AND 107).
FIRST USE 1-1-2004; IN COMMERCE 1-1-2004.

CLASS 41—(Continued).

3,568,632. SANDLER SYSTEMS, INC., OWINGS MILLS, MD. SN 78-776,901. PUB. 3-11-2008, FILED 12-20-2005.



THE MARK CONSISTS OF A REPRESENTATION OF A FUNNEL WITH AN ARROW POINTING DOWN ON EACH SIDE OF THE TOP OF THE FUNNEL AND AN ARROW COMING OUT OF THE CENTER OF THE BOTTOM OF THE FUNNEL. THE WORDS "PAIN QUESTIONS" APPEAR ACROSS THE TOP OF THE FUNNEL AND THEN THE FOLLOWING SENTENCES ARE LISTED DOWN THE FRONT OF THE FUNNEL: "TELL ME MORE ABOUT THAT..CAN YOU BE MORE SPECIFIC? GIVE ME AN EXAMPLE. HOW LONG HAS THAT BEEN A PROBLEM? WHAT HAVE YOU TRIED TO DO ABOUT THAT? AND DID THAT WORK? HOW MUCH DO YOU THINK HAS COST YOU? HOW DO YOU FEEL ABOUT THAT? HAVE YOU GIVEN UP TRYING TO DEAL WITH THE PROBLEM?"

FOR BUSINESS TRAINING; TRAINING SERVICES IN THE FIELD OF SALES AND SALES MANAGEMENT (U.S. CLS. 100, 101 AND 107).
FIRST USE 8-15-2008; IN COMMERCE 8-15-2008.

3,568,637. GRADER, ROBERT, ELLICOTT CITY, MD. SN 78-795,401. PUB. 4-24-2007, FILED 1-19-2006.

THE CHEAP BASTARD

THE MARK CONSISTS OF STANDARD CHARACTERS WITHOUT CLAIM TO ANY PARTICULAR FONT, STYLE, SIZE, OR COLOR.

FOR TELEVISION PROGRAM SERIES IN THE FIELD OF INEXPENSIVE LIVING, TRAVELING, SHOPPING, EATING AND BARGAINS (U.S. CLS. 100, 101 AND 107).
FIRST USE 6-22-2000; IN COMMERCE 9-9-2002.

CLASS 41—(Continued).

3,568,670. AVYX, INC., HIGHLANDS RANCH, CO. SN 78-924,095. PUB. 4-24-2007, FILED 7-6-2006.

AVYX

THE MARK CONSISTS OF STANDARD CHARACTERS WITHOUT CLAIM TO ANY PARTICULAR FONT, STYLE, SIZE, OR COLOR.

FOR PUBLISHING SERVICES, NAMELY, PUBLICATION OF FLASH CARDS, WORKBOOKS, ACADEMIC TEXTS, CHILDREN'S BOOKS, CHILDREN'S ACTIVITY BOOKS, COLORING BOOKS, JOURNALS, NEWSLETTERS, MAGAZINES, FICTION BOOKS, AND NONFICTION BOOKS FEATURING EDUCATIONAL TOPICS IN THE AREAS OF MATH, READING, WRITING, SCIENCE, SOCIAL STUDIES, RELIGION, MUSIC, ART, FOREIGN LANGUAGES, AND PHYSICAL EDUCATION; ELECTRONIC PUBLISHING SERVICES, NAMELY, PUBLICATION OF TEXT AND GRAPHIC WORKS OF OTHERS ON CD AND DVD FEATURING EDUCATIONAL TOPICS IN THE AREAS OF MATH, READING, WRITING, SCIENCE, SOCIAL STUDIES, RELIGION, MUSIC, ART, FOREIGN LANGUAGES, AND PHYSICAL EDUCATION (U.S. CLS. 100, 101 AND 107).

FIRST USE 7-1-2007; IN COMMERCE 7-1-2007.

3,568,679. VIRGINIA K. FREYERMUTH, INC., CARVER, MA. SN 78-934,475. PUB. 3-6-2007, FILED 7-21-2006.

ART WHERE YOU ARE

THE MARK CONSISTS OF STANDARD CHARACTERS WITHOUT CLAIM TO ANY PARTICULAR FONT, STYLE, SIZE, OR COLOR.

NO CLAIM IS MADE TO THE EXCLUSIVE RIGHT TO USE "ART", APART FROM THE MARK AS SHOWN.

FOR EDUCATIONAL SERVICES, NAMELY, DEVELOPING AND PROVIDING INSTRUCTION AND INFORMATION BOTH ONLINE AND IN-PERSON TO ARTISTS, WRITERS, AND THE PUBLIC, PERTAINING TO THE ARTS, CREATIVITY DEVELOPMENT, AND WRITING; EDUCATIONAL SERVICES, NAMELY, CONDUCTING ON-LINE EXHIBITIONS AND DISPLAYS AND INTERACTIVE EXHIBITS IN THE FIELD OF ART; ART EXHIBITIONS; EDUCATIONAL SERVICES, NAMELY, CONDUCTING DISTANCE LEARNING INSTRUCTION AT THE ELEMENTARY, SECONDARY, COLLEGE, GRADUATE AND ADULT LEVELS; EDUCATIONAL SERVICES, NAMELY, CONDUCTING CLASSES, COURSES, SEMINARS, CONFERENCES, WORKSHOPS, AND ONLINE TRAINING IN THE FIELDS OF ART, CREATIVITY DEVELOPMENT, AND WRITING AND DISTRIBUTION OF COURSE MATERIAL IN CONNECTION THEREWITH; EDUCATION SERVICES NAMELY, MENTORING IN THE FIELDS OF ART, CREATIVITY DEVELOPMENT, AND WRITING; CUSTOM WRITING SERVICES; ON-LINE PUBLICATION OF ARTICLES, MAGAZINES, ESSAYS, BOOKLETS, BOOKS AND JOURNALS; PUBLICATION OF ARTICLES, MAGAZINES, ESSAYS, BOOKLETS, BOOKS AND JOURNALS (U.S. CLS. 100, 101 AND 107).

FIRST USE 11-8-2008; IN COMMERCE 11-8-2008.

CLASS 41—(Continued).

3,568,684. BLACK ENTERTAINMENT TELEVISION LLC, WASHINGTON, DC. SN 78-943,311. PUB. 8-28-2007, FILED 8-2-2006.

THE BET J LIST

THE MARK CONSISTS OF STANDARD CHARACTERS WITHOUT CLAIM TO ANY PARTICULAR FONT, STYLE, SIZE, OR COLOR.

OWNER OF U.S. REG. NOS. 1,511,259, 3,500,146, AND OTHERS.

NO CLAIM IS MADE TO THE EXCLUSIVE RIGHT TO USE "LIST", APART FROM THE MARK AS SHOWN.

FOR ENTERTAINMENT SERVICES, NAMELY, PROVIDING A TELEVISION PROGRAM IN THE FIELD OF MUSIC VIA THE INTERNET, TELEVISION, CABLE AND WIRELESS (U.S. CLS. 100, 101 AND 107).

FIRST USE 3-31-2006; IN COMMERCE 3-31-2006.

3,568,685. PHILHARMONIC SOCIETY OF ORANGE COUNTY, IRVINE, CA. SN 78-943,618. PUB. 9-18-2007, FILED 8-2-2006.

MUSICAL ME

THE MARK CONSISTS OF STANDARD CHARACTERS WITHOUT CLAIM TO ANY PARTICULAR FONT, STYLE, SIZE, OR COLOR.

FOR EDUCATIONAL SERVICES, NAMELY, CONDUCTING PROGRAMS IN THE FIELD OF MUSIC, CHILDREN'S MUSICAL INSTRUCTION, INSTRUCTION IN THE FIELD OF MUSIC AND DISTRIBUTING TEACHING MANUALS IN CONNECTION THEREWITH (U.S. CLS. 100, 101 AND 107).

FIRST USE 3-0-2007; IN COMMERCE 3-0-2007.

CLASS 41—(Continued).

3,568,691. SICA, DANIELE, SALERNO, ITALY. SN 78-952,545.
PUB. 9-25-2007, FILED 8-15-2006.

PROCORE & FIT

THE MARK CONSISTS OF STANDARD CHARACTERS WITHOUT CLAIM TO ANY PARTICULAR FONT, STYLE, SIZE, OR COLOR.

FOR PHYSICAL FITNESS CONSULTATION; PHYSICAL FITNESS INSTRUCTION; PROVIDING FITNESS AND EXERCISE FACILITIES; PERSONAL TRAINING SERVICES, NAMELY, STRENGTH AND CONDITIONING TRAINING; PERSONAL COACHING SERVICES IN THE FIELD OF PHYSICAL FITNESS AND PERSONAL TRAINING (U.S. CLS. 100, 101 AND 107).

FIRST USE 11-25-2008; IN COMMERCE 11-25-2008.

3,568,698. PPG INDUSTRIES OHIO, INC., CLEVELAND, OH.
SN 78-967,053. PUB. 3-20-2007, FILED 9-5-2006.

X-RAY REPAIR PLANNING

THE MARK CONSISTS OF STANDARD CHARACTERS WITHOUT CLAIM TO ANY PARTICULAR FONT, STYLE, SIZE, OR COLOR.

NO CLAIM IS MADE TO THE EXCLUSIVE RIGHT TO USE "REPAIR PLANNING", APART FROM THE MARK AS SHOWN.

FOR TRAINING SERVICES IN THE FIELD OF VEHICLE REPAIR (U.S. CLS. 100, 101 AND 107).

FIRST USE 3-17-2008; IN COMMERCE 3-17-2008.

3,568,701. THOU SHALT LAUGH, LLC, BURBANK, CA. SN
78-980,089. PUB. 7-10-2007, FILED 8-29-2006.

THOU SHALT LAUGH

THE MARK CONSISTS OF STANDARD CHARACTERS WITHOUT CLAIM TO ANY PARTICULAR FONT, STYLE, SIZE, OR COLOR.

FOR ENTERTAINMENT SERVICES, NAMELY, LIVE COMEDY SHOWS (U.S. CLS. 100, 101 AND 107).

FIRST USE 3-15-2006; IN COMMERCE 3-15-2006.

CLASS 41—(Continued).

3,568,707. FJR ADVISORS, LLC, NEWPORT BEACH, CA. SN
78-980,812. PUB. 2-14-2006, FILED 12-21-2004.

**NEVER COLD CALL
AGAIN**

THE MARK CONSISTS OF STANDARD CHARACTERS WITHOUT CLAIM TO ANY PARTICULAR FONT, STYLE, SIZE, OR COLOR.

FOR CONDUCTING SALES TRAINING SEMINARS AND DISTRIBUTING COURSE MATERIALS IN CONNECTION THEREWITH; INSTRUCTION IN THE FIELD OF SALES AND DISTRIBUTING COURSE MATERIALS IN CONNECTION THEREWITH; AND PERSONAL COACHING SERVICES IN THE FIELD OF SALES TRAINING (U.S. CLS. 100, 101 AND 107).

FIRST USE 5-26-2006; IN COMMERCE 5-26-2006.

**CLASS 42—SCIENTIFIC AND COMPUTER
SERVICES**

3,568,009. US TECHNOLOGY RESOURCES, LLC, ALISO
VIEJO, CA. SN 76-660,857. PUB. 1-2-2007, FILED 5-31-2006.

TRUST

THE MARK CONSISTS OF STANDARD CHARACTERS WITHOUT CLAIM TO ANY PARTICULAR FONT, STYLE, SIZE, OR COLOR.

FOR CONSULTING SERVICES IN THE FIELD OF TESTING COMPUTER SOFTWARE AND COMPUTER SOFTWARE SYSTEMS FOR OTHERS (U.S. CLS. 100 AND 101).

FIRST USE 0-0-2004; IN COMMERCE 0-0-2004.

3,568,023. OPEN COMPANIES, INC., THE, ASHEVILLE, NC.
SN 76-679,620. PUB. 6-10-2008, FILED 7-18-2007.

OPEN LEADS

THE MARK CONSISTS OF STANDARD CHARACTERS WITHOUT CLAIM TO ANY PARTICULAR FONT, STYLE, SIZE, OR COLOR.

CLASS 42—(Continued).

NO CLAIM IS MADE TO THE EXCLUSIVE RIGHT TO USE "LEADS", APART FROM THE MARK AS SHOWN.

FOR PROVIDING TEMPORARY USE OF ON-LINE NON-DOWNLOADABLE SOFTWARE FOR STORING, MANAGING, TRACKING AND ANALYZING DATA IN THE FIELD OF LEAD MANAGEMENT, MARKETING, PROMOTION, SALES, CUSTOMER INFORMATION MANAGEMENT, CUSTOMER SUPPORT SERVICES; PROVIDING TEMPORARY USE OF ON-LINE NON-DOWNLOADABLE SOFTWARE TO CREATE STATISTICAL AND MANAGEMENT REPORTS ON MARKETING, PROMOTION, SALES, CUSTOMER INFORMATION MANAGEMENT, CUSTOMER SUPPORT SERVICES AND EMPLOYEE EFFICIENCY PROVIDING TEMPORARY USE OF ON-LINE NON-DOWNLOADABLE MULTIMEDIA COMPUTER PROGRAM FOR COMMUNICATING WITH PEER PROFESSIONALS (U.S. CLS. 100 AND 101).

FIRST USE 6-15-2004; IN COMMERCE 6-15-2004.

CLASS 42—(Continued).

3,568,075. POET RESEARCH, INC., SIOUX FALLS, SD. SN 77-052,388. PUB. 11-13-2007, FILED 11-28-2006.



THE MARK CONSISTS OF A STYLIZED LETTER "O" WHICH RESEMBLES A LEAF.

FOR ENGINEERING AND DESIGN OF PLANT PROCESSING FACILITIES; RESEARCH AND DEVELOPMENT SERVICES IN THE FIELDS OF CORN, GRAINS, ETHANOL AND OTHER AGRICULTURAL PRODUCT FUELS, RENEWABLE AND ALTERNATIVE ENERGY, AND SYSTEMS, EQUIPMENT AND PROCESSES USED IN PRODUCTION AND CONVERSION OF ETHANOL AND ANIMAL FEED PRODUCTS, BIO-REFINING, ETHANOL AND / OR FEED TRANSPORTATION, GRAIN, STOVER, FIBER, CELLULOSE, BIOMASS, BIO-COMPOSITES, ORGANIC ACIDS, PLANT SEEDS, CORN, STARCH, PLANT MATERIAL, BIOFUELS, ETHANOLOGENS, FERMENTATION, DISTILLATION, GRAIN FRACTIONATION, GRAIN PROCESSING, ENZYME PRODUCTION, ENZYME PRODUCING AGENTS, EQUIPMENT AND PROCESSES RELATED TO ETHANOL, ANIMAL FEED PRODUCTS, BIOPOLYMERS, GRAIN FRACTIONATION, BIOMASS / CELLULOSE DEGRADATION, AND OIL EXTRACTION (U.S. CLS. 100 AND 101).

FIRST USE 7-0-2007; IN COMMERCE 7-0-2007.

3,568,045. AMERICAN SOCIETY FOR BARIATRIC SURGERY, GAINESVILLE, FL. SN 77-012,098. PUB. 9-25-2007, FILED 10-2-2006.

CBN

THE MARK CONSISTS OF STANDARD CHARACTERS WITHOUT CLAIM TO ANY PARTICULAR FONT, STYLE, SIZE, OR COLOR.

FOR ACCREDITATION SERVICES, NAMELY, DEVELOPING, EVALUATING, AND TESTING STANDARDS FOR BARIATRIC SURGICAL NURSING FOR THE PURPOSE OF ACCREDITATION (U.S. CLS. 100 AND 101).

FIRST USE 1-1-2007; IN COMMERCE 6-1-2007.

3,568,099. TABOOLA.COM LTD., BET DAGAN, ISRAEL. SN 77-083,695. PUB. 9-18-2007, FILED 1-16-2007.

MATCHRANK

3,568,061. TWENTIETH CENTURY FOX FILM CORPORATION, LOS ANGELES, CA. SN 77-031,523. PUB. 8-7-2007, FILED 10-27-2006.

MOCA

THE MARK CONSISTS OF STANDARD CHARACTERS WITHOUT CLAIM TO ANY PARTICULAR FONT, STYLE, SIZE, OR COLOR.

FOR DATA ENCRYPTION SERVICES (U.S. CLS. 100 AND 101).

FIRST USE 10-31-2008; IN COMMERCE 10-31-2008.

THE MARK CONSISTS OF STANDARD CHARACTERS WITHOUT CLAIM TO ANY PARTICULAR FONT, STYLE, SIZE, OR COLOR.

FOR APPLICATION SERVICE PROVIDER, NAMELY, PROVIDING, MANAGING AND MAINTAINING APPLICATIONS AND SOFTWARE IN THE FIELDS OF REMOTE DATA MANAGEMENT, INCLUDING AUDIO, AUDIOVISUAL AND VIDEO CONTENT (U.S. CLS. 100 AND 101).

FIRST USE 12-10-2008; IN COMMERCE 12-10-2008.

CLASS 42—(Continued).

3,568,104. DAYTON T. BROWN INC., BOHEMIA, NY. SN 77-092,272. PUB. 4-8-2008, FILED 1-26-2007.

A World of Engineering and Testing Under One Roof

THE MARK CONSISTS OF STANDARD CHARACTERS WITHOUT CLAIM TO ANY PARTICULAR FONT, STYLE, SIZE, OR COLOR.

FOR CONSUMER PRODUCT SAFETY TESTING; CONSUMER PRODUCT SAFETY TESTING AND CONSULTATION; DESIGN AND TESTING FOR NEW PRODUCT DEVELOPMENT; DESIGN AND TESTING OF NEW PRODUCTS FOR OTHERS; DESIGN SERVICES IN THE FIELD OF NAVAL SHIPBUILDING; ENGINEERING SERVICES, NAMELY, ENGINEERING FOR THE DESTRUCTIVE AND NON DESTRUCTIVE TESTING OF AUTOMOTIVE AND OFF ROAD VEHICLES, DEFENSE AND GOVERNMENT EQUIPMENT, AVIATION, AEROSPACE AND AVIONIC EQUIPMENT, CONSUMER AND COMMERCIAL PRODUCTS AND ELECTRONICS, TRANSPORTATION AND SHIPPING EQUIPMENT, MARITIME AND SHIPBOARD EQUIPMENT, RAIL AND MASS TRANSIT EQUIPMENT, MEDICAL EQUIPMENT AND TELECOM AND IT EQUIPMENT AND ENGINEERING CONSULTING TO COMMERCIAL AND GOVERNMENT ENTITIES; MATERIAL TESTING; MATERIALS TESTING AND ANALYZING; MATERIALS TESTING AND EVALUATION; PRODUCT SAFETY TESTING; TESTING OF FILTERS; TESTING OF RAW MATERIALS; TESTING OR RESEARCH ON CIVIL ENGINEERING; TESTING OR RESEARCH ON ELECTRICITY; TESTING OR RESEARCH ON MACHINES, APPARATUS AND INSTRUMENTS; TESTING, ANALYSIS AND EVALUATION OF THE GOODS AND SERVICES OF OTHERS FOR THE PURPOSE OF CERTIFICATION; TEXTILE TESTING (U.S. CLS. 100 AND 101).

FIRST USE 2-27-2007; IN COMMERCE 2-27-2007.

3,568,164. SURECOMP INTERNATIONAL LTD., BRIDGE-TOWN, BARBADOS. SN 77-140,062. PUB. 7-1-2008, FILED 3-26-2007.

ALLFAC

THE MARK CONSISTS OF STANDARD CHARACTERS WITHOUT CLAIM TO ANY PARTICULAR FONT, STYLE, SIZE, OR COLOR.

PRIORITY CLAIMED UNDER SEC. 44(D) ON ERP NCNTY TM OFC APPLICATION NO. 5723291, FILED 2-16-2007, REG. NO. 005723291, DATED 2-25-2008, EXPIRES 2-16-2017.

OWNER OF U.S. REG. NO. 3,083,702.
FOR PROVIDING TEMPORARY USE OF ON-LINE NON-DOWNLOADABLE COMPUTER SOFTWARE IN THE FIELD OF BANKING, NAMELY, SOFTWARE THAT FACILITATES NON-RECOURSE FACTORING, RECOURSE FACTORING, INVOICE DISCOUNTING, AGENCY FACTORING, DATA FACTORING, AND IMPORT/EXPORT FACTORING (U.S. CLS. 100 AND 101).

FIRST USE 7-0-2007; IN COMMERCE 7-0-2007.

CLASS 42—(Continued).

3,568,173. PONTICLARO INC., AUSTIN, TX. SN 77-147,720. PUB. 3-25-2008, FILED 4-3-2007.

PONTICLARO

THE MARK CONSISTS OF STANDARD CHARACTERS WITHOUT CLAIM TO ANY PARTICULAR FONT, STYLE, SIZE, OR COLOR.

THE MARK HAS NO MEANING IN ENGLISH.

FOR COMPUTER NETWORK DESIGN AND COMPUTER SOFTWARE DESIGN FOR ECOMMERCE, ONLINE ARTIST PORTFOLIOS, WEBSITE CONTENT MANAGEMENT, WEB DESIGN, EMAIL MAILING LIST MANAGEMENT, WEBHOSTING, CORPORATE COLLATERAL ORGANIZATION, CORPORATE INTRANET, INTEGRATION WITH EXISTING WEB APPLICATIONS AND APPLICATION PROGRAM INTERFACES, DATA BACKUP AND SYNCING, AND ONLINE PAYMENT PROCESSING; COMPUTER PROGRAMMING FOR OTHERS; COMPUTER SERVICES IN THE NATURE OF CUSTOMIZED WEB PAGES FEATURING USER-DEFINED INFORMATION, PERSONAL PROFILES AND INFORMATION; COMPUTER SERVICES, NAMELY, CREATING AND MAINTAINING WEBSITES FOR OTHERS; COMPUTER SERVICES, NAMELY, DESIGNING, MANAGING AND IMPLEMENTING WEBSITES FOR OTHERS; COMPUTER SERVICES, NAMELY, CREATING INDEXES OF INFORMATION, SITES AND OTHER RESOURCES AVAILABLE ON COMPUTER NETWORKS; COMPUTER SERVICES, NAMELY, HOSTING ONLINE INTERACTIVE CALENDARS THAT ALLOW MULTIPLE PARTICIPANTS TO SHARE EVENT SCHEDULES; COMPUTER SERVICES, NAMELY, COMPUTER SYSTEM ADMINISTRATION FOR OTHERS; COMPUTER SERVICES, NAMELY, HOSTING AND MAINTAINING AN ONLINE WEBSITE FOR OTHERS TO PURCHASE GOODS AND SERVICES, PUBLISH WORKS OF AUTHORSHIP, ORGANIZE CORPORATE COLLATERAL, GRAPHICS AND MARKETING MATERIALS, FACILITATE NEW CUSTOMER ACQUISITION, COMMUNICATE BRAND AND IDENTITY GOALS THROUGH WEB PAGES AND GRAPHICS, SUBSCRIBE AND UNSUBSCRIBE TO EMAIL MAILING LISTS, AND PROVIDE INFORMATION REGARDING THE CLIENT'S BUSINESS; COMPUTER SOFTWARE CONSULTATION; COMPUTER SOFTWARE DEVELOPMENT AND DESIGN FOR OTHERS; CONSULTING SERVICES IN THE FIELD OF DESIGN, SELECTION, IMPLEMENTATION AND USE OF COMPUTER HARDWARE AND SOFTWARE SYSTEMS FOR OTHERS; CUSTOMIZATION OF COMPUTER HARDWARE AND SOFTWARE; DESIGN OF INTERNET HOME PAGES, COMPUTER SOFTWARE AND WEBSITES; HOSTING THE WEBSITES OF OTHERS ON A COMPUTER SERVER FOR A GLOBAL COMPUTER NETWORK; PROVIDING ONLINE NON-DOWNLOADABLE SOFTWARE FOR USE IN ECOMMERCE, NAMELY, MANAGING ONLINE ARTIST PORTFOLIOS, WEBSITE CONTENT MANAGEMENT, WEB DESIGN, EMAIL MAILING LIST MANAGEMENT, WEBHOSTING, CORPORATE COLLATERAL ORGANIZATION, CORPORATE INTRANET DESIGN AND INTEGRATION WITH EXISTING WEB APPLICATIONS AND APPLICATION PROGRAM INTERFACES, DATA BACKUP AND SYNCING, AND POINT OF SALE AND ONLINE PAYMENT PROCESSING; AND PROVIDING TEMPORARY USE OF ONLINE NON-DOWNLOADABLE SOFTWARE FOR ECOMMERCE, NAMELY, MANAGING ONLINE ARTIST PORTFOLIOS, WEBSITE CONTENT MANAGEMENT, WEB DESIGN, EMAIL MAILING LIST MANAGEMENT, WEBHOSTING, CORPORATE COLLATERAL ORGANIZATION, CORPORATE INTRANET DESIGN AND INTEGRATION WITH EXISTING WEB APPLICATIONS AND APPLICATION PROGRAM INTERFACES, DATA BACKUP AND SYNCING, AND POINT OF SALE AND ONLINE PAYMENT PROCESSING (U.S. CLS. 100 AND 101).

FIRST USE 7-22-2006; IN COMMERCE 7-22-2006.

CLASS 42—(Continued).

3,568,214. JD SUPRA, LLC, MARSHALL, CA. SN 77-185,275. PUB. 4-8-2008, FILED 5-18-2007.

JDSUPRA

THE COLOR(S) BLACK AND RED IS/ARE CLAIMED AS A FEATURE OF THE MARK.

THE MARK CONSISTS OF THE PHRASE "JDSUPRA". ALL LETTERS ARE IN BLACK WITH THE EXCEPTION OF THE "S". THE "S" IS STYLIZED AND IS FORMED USING TWO CURVED ARROWS POINTING TOWARDS EACH OTHER. THE "S" IS IN RED.

FOR APPLICATION SERVICE PROVIDER FEATURING SOFTWARE TO ENABLE WEB SITE USERS TO UPLOAD, SEARCH AND DOWNLOAD INFORMATION AND WRITTEN MATERIALS RELATING TO LEGAL MATTERS (U.S. CLS. 100 AND 101).

FIRST USE 8-1-2007; IN COMMERCE 8-1-2007.

CLASS 42—(Continued).

3,568,298. DRAWLOOP TECHNOLOGIES, INC., TAMPA, FL. SN 77-259,047. PUB. 2-26-2008, FILED 8-20-2007.

LOOPEXCHANGE

THE MARK CONSISTS OF STANDARD CHARACTERS WITHOUT CLAIM TO ANY PARTICULAR FONT, STYLE, SIZE, OR COLOR.

NO CLAIM IS MADE TO THE EXCLUSIVE RIGHT TO USE "EXCHANGE", APART FROM THE MARK AS SHOWN.

FOR PROVIDING TEMPORARY USE OF ONLINE NON-DOWNLOADABLE COMPUTER SOFTWARE FOR LEASING BUSINESS METHOD WORKFLOWS FOR THE PURPOSE OF GENERATING AUTOMATED AND SEMI-AUTOMATED DOCUMENTS (U.S. CLS. 100 AND 101).

FIRST USE 11-0-2007; IN COMMERCE 11-0-2007.

3,568,268. BESTGROUP CONSULTING & SOFTWARE GMBH, BERLIN, FED REP GERMANY. SN 77-238,557. PUB. 1-8-2008, FILED 7-25-2007.

advaBEST

THE MARK CONSISTS OF STANDARD CHARACTERS WITHOUT CLAIM TO ANY PARTICULAR FONT, STYLE, SIZE, OR COLOR.

FOR COMPUTER SOFTWARE CONSULTANCY; COMPUTER SOFTWARE CONSULTATION; COMPUTER SOFTWARE DESIGN, COMPUTER PROGRAMMING, OR MAINTENANCE OF COMPUTER SOFTWARE; COMPUTER SOFTWARE DEVELOPMENT; DESIGN AND DEVELOPMENT OF COMPUTER HARDWARE AND SOFTWARE; DESIGN OF HOME PAGES, COMPUTER SOFTWARE AND WEB SITES; DESIGN, DEVELOPMENT AND IMPLEMENTATION OF SOFTWARE; PROVIDING TEMPORARY USE OF NON-DOWNLOADABLE COMPUTER SOFTWARE FOR PREPARING INVOICES OVER COMPUTER NETWORKS, INTRANETS AND THE INTERNET; PROVIDING TEMPORARY USE OF NON-DOWNLOADABLE COMPUTER SOFTWARE FOR PREPARING SHIPPING DOCUMENTS OVER COMPUTER NETWORKS, INTRANETS AND THE INTERNET; PROVIDING TEMPORARY USE OF NON-DOWNLOADABLE COMPUTER SOFTWARE FOR SHIPMENT PROCESSING OVER COMPUTER NETWORKS, INTRANETS AND THE INTERNET; PROVIDING TEMPORARY USE OF NON-DOWNLOADABLE COMPUTER SOFTWARE FOR TRACKING DOCUMENTS OVER COMPUTER NETWORKS, INTRANETS AND THE INTERNET; PROVIDING TEMPORARY USE OF NON-DOWNLOADABLE COMPUTER SOFTWARE FOR TRACKING FREIGHT OVER COMPUTER NETWORKS, INTRANETS AND THE INTERNET; PROVIDING TEMPORARY USE OF NON-DOWNLOADABLE COMPUTER SOFTWARE FOR TRACKING PACKAGES OVER COMPUTER NETWORKS, INTRANETS AND THE INTERNET; RENTAL OF APPLICATION SOFTWARE; TECHNICAL SUPPORT SERVICES, NAMELY, TROUBLESHOOTING OF COMPUTER SOFTWARE PROBLEMS; UP-DATING OF COMPUTER SOFTWARE (U.S. CLS. 100 AND 101).

FIRST USE 1-22-2008; IN COMMERCE 1-22-2008.

3,568,332. FORGENT NETWORKS, INC., AUSTIN, TX. SN 77-278,226. PUB. 3-18-2008, FILED 9-12-2007.

ASURE SOFTWARE

THE MARK CONSISTS OF STANDARD CHARACTERS WITHOUT CLAIM TO ANY PARTICULAR FONT, STYLE, SIZE, OR COLOR.

NO CLAIM IS MADE TO THE EXCLUSIVE RIGHT TO USE "SOFTWARE", APART FROM THE MARK AS SHOWN.

FOR PROVIDING TEMPORARY USE OF ON-LINE NON-DOWNLOADABLE SOFTWARE DESIGNED TO ALLOW EMPLOYEES ACCESS AND UPDATE INFORMATION REGARDING HUMAN RESOURCES, PAYROLL, TIMESHEETS, EXPENSE STATEMENTS AND ADMINISTRATION; PROVIDING TEMPORARY USE OF ON-LINE NON-DOWNLOADABLE SOFTWARE DESIGNED TO BE USED FOR MANAGING AND SCHEDULING MEETINGS AND SOFTWARE USED FOR THE MANAGEMENT AND TRACKING OF INFORMATION TECHNOLOGY AND FIXED ASSETS (U.S. CLS. 100 AND 101).

FIRST USE 9-13-2007; IN COMMERCE 9-13-2007.

CLASS 42—(Continued).

3,568,376. PAGLO LABS INC., PALO ALTO, CA. SN 77-293,473. PUB. 8-12-2008, FILED 10-2-2007.

PAGLO

THE MARK CONSISTS OF STANDARD CHARACTERS WITHOUT CLAIM TO ANY PARTICULAR FONT, STYLE, SIZE, OR COLOR.

FOR ONLINE COMPUTER SERVICES, NAMELY, PROVIDING NON-DOWNLOADABLE ON-LINE COMPUTER PROGRAMS FOR DISCOVERING, INDEXING, IDENTIFYING, SEARCHING, MANAGING AND COLLABORATING ON A WIDE VARIETY OF INFORMATION IN A VARIETY OF FIELDS (U.S. CLS. 100 AND 101).

FIRST USE 1-29-2008; IN COMMERCE 2-6-2008.

3,568,430. BIOSCIENCE LABORATORIES, INC., BOZEMAN, MT. SN 77-327,617. PUB. 3-11-2008, FILED 11-12-2007.

GOT BUGS? GET PAID!

THE MARK CONSISTS OF STANDARD CHARACTERS WITHOUT CLAIM TO ANY PARTICULAR FONT, STYLE, SIZE, OR COLOR.

FOR PRODUCT SAFETY TESTING IN THE HEALTHCARE, PHARMACEUTICAL, PERSONAL CARE AND CONSUMER PRODUCTS INDUSTRIES; LABORATORY RESEARCH IN THE FIELD OF HEALTHCARE, PHARMACEUTICAL, PERSON CARE AND CONSUMER PRODUCTS (U.S. CLS. 100 AND 101).

FIRST USE 11-10-2008; IN COMMERCE 11-10-2008.

3,568,485. ABBOTT LABORATORIES, ABBOTT PARK, IL. SN 77-369,963. PUB. 4-15-2008, FILED 1-11-2008.

EXTEND

THE MARK CONSISTS OF STANDARD CHARACTERS WITHOUT CLAIM TO ANY PARTICULAR FONT, STYLE, SIZE, OR COLOR.

FOR MEDICAL AND SCIENTIFIC RESEARCH, NAMELY, CONDUCTING PRECLINICAL AND CLINICAL TRIALS, AND PROVIDING MEDICAL AND SCIENTIFIC RESEARCH INFORMATION IN THE FIELD OF PHARMACEUTICAL PRECLINICAL AND CLINICAL TRIALS (U.S. CLS. 100 AND 101).

FIRST USE 2-2-2008; IN COMMERCE 2-2-2008.

CLASS 42—(Continued).

3,568,486. YOOPERSOFT, INC., ESCANABA, MI. SN 77-370,884. PUB. 8-12-2008, FILED 1-14-2008.

DecisionPlanner

THE MARK CONSISTS OF STANDARD CHARACTERS WITHOUT CLAIM TO ANY PARTICULAR FONT, STYLE, SIZE, OR COLOR.

FOR PROVIDING TEMPORARY USE OF ONLINE, NON-DOWNLOADABLE COMPUTER SOFTWARE FOR ASSISTING USERS IN THE DECISION MAKING PROCESS (U.S. CLS. 100 AND 101).

FIRST USE 10-1-2008; IN COMMERCE 10-1-2008.

3,568,493. MAJORS, MONICA, LONG BEACH, CA. SN 77-373,793. PUB. 6-3-2008, FILED 1-17-2008.

PAPER CUT INDUSTRIES

THE MARK CONSISTS OF STANDARD CHARACTERS WITHOUT CLAIM TO ANY PARTICULAR FONT, STYLE, SIZE, OR COLOR.

NO CLAIM IS MADE TO THE EXCLUSIVE RIGHT TO USE "INDUSTRIES", APART FROM THE MARK AS SHOWN.

FOR CUSTOM DESIGN OF PAPER GOODS BASED ON PERSONAL SELECTIONS MADE BY THE CUSTOMER (U.S. CLS. 100 AND 101).

FIRST USE 12-1-2007; IN COMMERCE 7-29-2008.

3,568,501. INSTRAS SCIENTIFIC LLC, TEANECK, NJ. SN 77-389,638. PUB. 7-22-2008, FILED 2-6-2008.

MyLIS

THE MARK CONSISTS OF STANDARD CHARACTERS WITHOUT CLAIM TO ANY PARTICULAR FONT, STYLE, SIZE, OR COLOR.

FOR ONLINE SCIENTIFIC RESEARCH (U.S. CLS. 100 AND 101).

FIRST USE 1-1-2008; IN COMMERCE 1-1-2008.

CLASS 42—(Continued).

3,568,526. AMERICAN ASSOCIATION OF PHYSICIAN SPECIALISTS, INC., TAMPA, FL. SN 77-418,486. PUB. 7-22-2008, FILED 3-11-2008.

CLASS 42—(Continued).

3,568,584. HOHENSEE, MATTHIAS, APTOS, CA. SN 78-427,345. PUB. 4-19-2005, FILED 5-28-2004.

ABFMO

Mobileo

FOR ACCREDITATION SERVICES, NAMELY, DEVELOPING, EVALUATING, AND TESTING STANDARDS FOR PHYSICIANS FOR THE PURPOSE OF ACCREDITATION (U.S. CLS. 100 AND 101).
FIRST USE 11-21-2008; IN COMMERCE 11-21-2008.

THE MARK CONSISTS OF STANDARD CHARACTERS WITHOUT CLAIM TO ANY PARTICULAR FONT, STYLE, SIZE, OR COLOR.

FOR COMPUTER SERVICES, NAMELY, PROVIDING TEMPORARY USE OF NON-DOWNLOADABLE COMPUTER INTERFACE SOFTWARE AVAILABLE OVER A NETWORK IN ORDER TO CREATE PERSONALIZED ON-LINE INFORMATION SERVICES; EXTRACTION AND RETRIEVAL OF INFORMATION AND DATA MINING BY MEANS OF GLOBAL COMPUTER NETWORKS; CREATING CUSTOMIZED USER-DEFINED INDEXES OF INFORMATION, INDEXES OF WEB SITES AND INDEXES OF OTHER INFORMATION SOURCES WHICH INCLUDE ONLINE WEB LINKS TO OTHER WEB SITES IN CONNECTION WITH GLOBAL COMPUTER NETWORKS; CUSTOMIZED SEARCHING SERVICES IN THE NATURE OF PROVIDING SPECIFIC INFORMATION AS REQUESTED BY CUSTOMERS FROM INDEXES OF INFORMATION, INDEXES OF WEB SITES AND INDEXES OF OTHER INFORMATION SOURCES VIA THE INTERNET; CUSTOMIZED SEARCHING SERVICES, NAMELY, PROVIDING SPECIFIC INFORMATION AS REQUESTED BY CUSTOMERS FROM SEARCHABLE INDEXES AND DATABASES OF INFORMATION, INCLUDING TEXT, ELECTRONIC DOCUMENTS, DATABASES, GRAPHICS AND AUDIO VISUAL INFORMATION, BY MEANS OF A GLOBAL COMPUTER INFORMATION NETWORK (U.S. CLS. 100 AND 101).
FIRST USE 2-18-2008; IN COMMERCE 2-18-2008.

3,568,541. GRAFE, JOACHIM K., JACKSONVILLE, FL. SN 77-436,667. PUB. 8-26-2008, FILED 4-1-2008.



3,568,668. ADP, INC., ROSELAND, NJ. SN 78-921,920. PUB. 6-19-2007, FILED 7-3-2006.

THE COLOR(S) GREEN, RED, BLACK IS/ARE CLAIMED AS A FEATURE OF THE MARK.

THE MARK CONSISTS OF A MARTINI GLASS IN BLACK OUTLINE WITH A GREEN AND RED OLIVE ON A BLACK TOOTHPICK INSIDE THE GLASS. TO THE RIGHT OF THE GLASS, THE WORDS "DOCTINI THE DOCUMENT MANAGEMENT SOLUTION WITH A TWIST." APPEAR IN BLACK.

FOR COMPUTER SOFTWARE DEVELOPMENT; DESIGN, MAINTENANCE, DEVELOPMENT AND UPDATING OF COMPUTER SOFTWARE; IMAGE PROCESSING SOFTWARE DESIGN (U.S. CLS. 100 AND 101).
FIRST USE 12-1-2007; IN COMMERCE 12-1-2007.

ADP CONNECTION

THE MARK CONSISTS OF STANDARD CHARACTERS WITHOUT CLAIM TO ANY PARTICULAR FONT, STYLE, SIZE, OR COLOR.

CLASS 42—(Continued).

OWNER OF U.S. REG. NOS. 1,128,022, 3,119,378, AND OTHERS.

FOR PROVIDING TEMPORARY USE OF ONLINE NON-DOWNLOADABLE SOFTWARE FOR PROVIDING EMPLOYERS WITH A COMPATIBLE INTERFACE BETWEEN PAYROLL PROCESSING SOFTWARE AND SOFTWARE FOR FINANCIAL MANAGEMENT AND MANAGEMENT OF HUMAN RESOURCES (U.S. CLS. 100 AND 101).

FIRST USE 3-31-2005; IN COMMERCE 3-31-2005.

3,568,677. SINCLAIR, LISBETH K., LOS ANGELES, CA. SN 78-933,391. PUB. 9-4-2007, FILED 7-19-2006.

One Zip Code At a Time

THE MARK CONSISTS OF STANDARD CHARACTERS WITHOUT CLAIM TO ANY PARTICULAR FONT, STYLE, SIZE, OR COLOR.

FOR CONSULTING SERVICES IN THE FIELD OF CITY AND REGIONAL PLANNING, NAMELY, PLANNING, DEVELOPMENT, AND TECHNICAL SUPPORT FOR COMMUNITIES (U.S. CLS. 100 AND 101).

FIRST USE 4-16-2006; IN COMMERCE 11-25-2008.

CLASS 43—HOTEL AND RESTAURANT SERVICES

3,568,151. MISSION DESIGN AND DEVELOPMENT, L.L.C., ANN ARBOR, MI. SN 77-130,818. PUB. 3-18-2008, FILED 3-14-2007.

BLUE TRACTOR

THE MARK CONSISTS OF STANDARD CHARACTERS WITHOUT CLAIM TO ANY PARTICULAR FONT, STYLE, SIZE, OR COLOR.

FOR RESTAURANT SERVICES (U.S. CLS. 100 AND 101).

FIRST USE 7-1-2006; IN COMMERCE 7-1-2006.

CLASS 43—(Continued).

3,568,187. RAVINIA FESTIVAL ASSOCIATION, HIGHLAND PARK, IL. SN 77-166,226. PUB. 4-1-2008, FILED 4-26-2007.

PARK VIEW RESTAURANT

THE MARK CONSISTS OF STANDARD CHARACTERS WITHOUT CLAIM TO ANY PARTICULAR FONT, STYLE, SIZE, OR COLOR.

NO CLAIM IS MADE TO THE EXCLUSIVE RIGHT TO USE "RESTAURANT", APART FROM THE MARK AS SHOWN.

FOR RESTAURANT SERVICES (U.S. CLS. 100 AND 101).

FIRST USE 7-1-2007; IN COMMERCE 7-1-2007.

3,568,233. HOT STUFF FOODS, LLC, SIOUX FALLS, SD. SN 77-203,111. PUB. 12-18-2007, FILED 6-11-2007.

LETTIERI'S

THE MARK CONSISTS OF STANDARD CHARACTERS WITHOUT CLAIM TO ANY PARTICULAR FONT, STYLE, SIZE, OR COLOR.

OWNER OF U.S. REG. NO. 2,915,735.

SEC. 2(F).

FOR RESTAURANTS AND CARRY-OUT FOOD SHOPS (U.S. CLS. 100 AND 101).

FIRST USE 2-0-1994; IN COMMERCE 2-0-1994.

3,568,306. AMERICAN PROPERTY MANAGEMENT CORPORATION, SAN DIEGO, CA. SN 77-265,426. PUB. 3-18-2008, FILED 8-27-2007.

Aqua Bloom

THE MARK CONSISTS OF STANDARD CHARACTERS WITHOUT CLAIM TO ANY PARTICULAR FONT, STYLE, SIZE, OR COLOR.

FOR HOTEL, BAR AND RESTAURANT SERVICES (U.S. CLS. 100 AND 101).

FIRST USE 4-1-2008; IN COMMERCE 4-1-2008.

CLASS 43—(Continued).

3,568,371. ARBY'S IP HOLDER TRUST, ATLANTA, GA. SN 77-291,592. PUB. 3-18-2008, FILED 9-28-2007.

A FRESH LOOK AT ARBY'S

THE MARK CONSISTS OF STANDARD CHARACTERS WITHOUT CLAIM TO ANY PARTICULAR FONT, STYLE, SIZE, OR COLOR.
 OWNER OF U.S. REG. NOS. 890,631, 3,146,765, AND OTHERS.
 FOR RESTAURANT SERVICES (U.S. CLS. 100 AND 101).
 FIRST USE 9-29-2007; IN COMMERCE 9-29-2007.

3,568,384. CALMEX, INC., MODESTO, CA. SN 77-294,086. PUB. 3-18-2008, FILED 10-2-2007.

FUZIO UNIVERSAL BISTRO

THE MARK CONSISTS OF STANDARD CHARACTERS WITHOUT CLAIM TO ANY PARTICULAR FONT, STYLE, SIZE, OR COLOR.
 OWNER OF U.S. REG. NOS. 2,248,206, 2,926,320, AND OTHERS.
 NO CLAIM IS MADE TO THE EXCLUSIVE RIGHT TO USE "BISTRO", APART FROM THE MARK AS SHOWN.
 FOR RESTAURANT SERVICES (U.S. CLS. 100 AND 101).
 FIRST USE 12-0-2007; IN COMMERCE 12-0-2007.

3,568,412. AMERICAN GIRL, LLC, EL SEGUNDO, CA. SN 77-310,453. PUB. 3-25-2008, FILED 10-22-2007.

IT'S A GIRL CELEBRATION EVERY DAY!

THE MARK CONSISTS OF STANDARD CHARACTERS WITHOUT CLAIM TO ANY PARTICULAR FONT, STYLE, SIZE, OR COLOR.
 FOR RESTAURANT AND CATERING SERVICES (U.S. CLS. 100 AND 101).
 FIRST USE 8-17-2007; IN COMMERCE 8-17-2007.

CLASS 43—(Continued).

3,568,441. CULINARY CONCEPTS, LLC, SAN ANTONIO, TX. SN 77-331,415. PUB. 4-29-2008, FILED 11-16-2007.



NO CLAIM IS MADE TO THE EXCLUSIVE RIGHT TO USE "HOT WINGS" AND "PIZZA RIBS & RINGS", APART FROM THE MARK AS SHOWN.
 THE COLOR(S) RED, ORANGE, YELLOW, BLACK, AND WHITE IS/ARE CLAIMED AS A FEATURE OF THE MARK.
 THE MARK CONSISTS OF RED, ORANGE, AND YELLOW FLAMES OUTLINED IN BLACK WITH THE BLACK WORD "HOT" OUTLINED IN WHITE INSIDE THE FLAMES. BELOW THE FLAMES IS THE WORD "WINGS" IN RED LETTERS OUTLINED IN BLACK AND WHITE. UNDERNEATH AND BELOW THAT, THERE IS A YELLOW CIRCLE OUTLINED IN BLACK AND WHITE WITH THE WORD "PLUS" IN RED OUTLINED IN BLACK AND WHITE. THE CIRCLE HAS TWO BLACK AND WHITE WINGS ON EACH SIDE. BELOW THE CIRCLE IN BLACK OUTLINED IN YELLOW IS THE WORD "PIZZA" TO THE RIGHT OF THAT IS A BULLET, THEN THE WORD "RIBS", AN AMPERSAND AND THE WORD "RINGS".
 FOR RESTAURANT SERVICES (U.S. CLS. 100 AND 101).
 FIRST USE 7-1-2008; IN COMMERCE 7-1-2008.

3,568,660. CTF DEVELOPMENT, INC., CORAL GABLES, FL. SN 78-905,152. PUB. 4-15-2008, FILED 6-9-2006.

PENTA

THE MARK CONSISTS OF STANDARD CHARACTERS WITHOUT CLAIM TO ANY PARTICULAR FONT, STYLE, SIZE, OR COLOR.
 FOR HOTEL SERVICES; MAKING HOTEL RESERVATIONS FOR OTHERS; PROVISION OF TEMPORARY ACCOMMODATION; HOTEL, MOTEL AND RESORT HOTEL ACCOMMODATION SERVICES; PROVIDING OF FOOD AND DRINK; RESTAURANT, BAR AND CATERING SERVICES; PROVISION OF FACILITIES FOR MEETINGS, CONFERENCES, EXHIBITIONS, CONGRESSES, SEMINARS, SYMPOSIUMS AND WORKSHOPS; RESERVATION SERVICES FOR HOTEL ACCOMMODATION AND OTHER ACCOMMODATION; FOOD AND BEVERAGE PREPARATION SERVICES (U.S. CLS. 100 AND 101).
 FIRST USE 9-23-2008; IN COMMERCE 9-23-2008.

CLASS 43—(Continued).

3,568,671. BENDER, TRACEY, SURREY, BRITISH COLUMBIA, CANADA. SN 78-927,156. PUB. 7-31-2007, FILED 7-11-2006.



NO CLAIM IS MADE TO THE EXCLUSIVE RIGHT TO USE "WOK" AND "FRESH ASIAN KITCHEN", APART FROM THE MARK AS SHOWN.

THE COLOR(S) RED, BLACK, ORANGE AND WHITE IS/ ARE CLAIMED AS A FEATURE OF THE MARK.

THE COLOR RED APPEARS IN THE WORDING "WOK BOX," AND THE COLOR BLACK APPEARS IN THE WORDING "FRESH ASIAN KITCHEN," THE COLOR ORANGE APPEARS IN THE CHOPSTICKS, THE COLORS ORANGE, BLACK AND WHITE APPEAR ON THE BOX.

FOR RESTAURANTS, SELF SERVICE RESTAURANTS; CAFES AND CAFETERIAS AND DELICATESSENS, COFFEE AND TEA HOUSES, CARRY-OUT RESTAURANTS AND RESTAURANTS FEATURING HOME DELIVERY (U.S. CLS. 100 AND 101).

FIRST USE 2-5-2008; IN COMMERCE 2-5-2008.

CLASS 44—(Continued).

3,568,159. EKISS, BRIAN, GRANITE BAY, CA. AND EKISS, MARY, GRANITE BAY, CA. SN 77-134,512. PUB. 4-15-2008, FILED 3-19-2007.

FACES365

THE MARK CONSISTS OF STANDARD CHARACTERS WITHOUT CLAIM TO ANY PARTICULAR FONT, STYLE, SIZE, OR COLOR.

FOR PROVIDING FACIALS; PROVIDING IN-PERSON MAKEUP CONSULTATION AND APPLICATION, SKIN ABRASION, LIGHT THERAPY, BODY WAXING SERVICES, AND SKIN CARE TREATMENTS, NAMELY, COLLAGEN TREATMENTS, VITAMIN THERAPY, EYE TREATMENTS BY APPLICATION OF SKIN CARE AGENTS TO THE SKIN AROUND THE EYE, LIP TREATMENTS BY APPLICATION OF SKIN CARE AGENTS TO THE LIPS, APPLICATION OF FACIAL MASKS, APPLYING SERUMS TO THE SKIN OF THE FACE, CLEANING OF SKIN PORES BY EXTRACTION OF DEPOSITS THEREFROM, AND APPLYING STEAM TO THE SKIN OF THE FACE (U.S. CLS. 100 AND 101).

FIRST USE 8-0-2007; IN COMMERCE 8-0-2007.

3,568,183. MIDWIVES ALLIANCE OF NORTH AMERICA, WASHINGTON, DC. SN 77-161,754. PUB. 2-26-2008, FILED 4-20-2007.

CLASS 44—MEDICAL, BEAUTY AND AGRICULTURAL SERVICES

3,568,111. RESOLUTION LASER, LLC, MINNETONKA, MN. SN 77-100,106. PUB. 3-25-2008, FILED 2-6-2007.

BREATHE LASER THERAPY

THE MARK CONSISTS OF STANDARD CHARACTERS WITHOUT CLAIM TO ANY PARTICULAR FONT, STYLE, SIZE, OR COLOR.

NO CLAIM IS MADE TO THE EXCLUSIVE RIGHT TO USE "LASER THERAPY", APART FROM THE MARK AS SHOWN.

FOR ADDICTION TREATMENT SERVICES, NAMELY, CRAVINGS MANAGEMENT SUPPORT SERVICES (U.S. CLS. 100 AND 101).

FIRST USE 1-10-2007; IN COMMERCE 2-26-2007.



NO CLAIM IS MADE TO THE EXCLUSIVE RIGHT TO USE "MOTHERS", APART FROM THE MARK AS SHOWN.

THE MARK CONSISTS OF THE LITERAL ELEMENT "MOTHERS NATURALLY." TO THE RIGHT OF THE LITERAL ELEMENT IS A CURVED BAND AND CIRCLE FORMING A SILHOUETTE OF AN EXPECTANT MOTHER.

FOR PROVIDING INFORMATION RELATING TO THE MIDWIFE PROFESSION AND MIDWIVES' ABILITY TO ASSIST IN THE BIRTHING PROCESS (U.S. CLS. 100 AND 101).

FIRST USE 10-19-2007; IN COMMERCE 10-19-2007.

CLASS 44—(Continued).

3,568,196. INTERNATIONAL ASSOCIATION OF ORAL AND MAXILLOFACIAL SURGEONS, OAK BROOK, IL. SN 77-170,781. PUB. 3-4-2008, FILED 5-2-2007.

IAOMS DIRECT

THE MARK CONSISTS OF STANDARD CHARACTERS WITHOUT CLAIM TO ANY PARTICULAR FONT, STYLE, SIZE, OR COLOR.

NO CLAIM IS MADE TO THE EXCLUSIVE RIGHT TO USE "DIRECT", APART FROM THE MARK AS SHOWN.

FOR PROVIDING A WEBSITE FEATURING INFORMATION RELATING TO ORAL AND MAXILLOFACIAL SURGERY AND LINKS TO WEBSITES OF OTHERS RELATING TO ORAL AND MAXILLOFACIAL SURGERY (U.S. CLS. 100 AND 101).

FIRST USE 7-3-2007; IN COMMERCE 7-3-2007.

CLASS 44—(Continued).

3,568,626. PRESTON BAILEY HOLDINGS, LLC, NEW YORK, NY. SN 78-763,046. PUB. 3-6-2007, FILED 11-29-2005.

PRESTON BAILEY

THE MARK CONSISTS OF STANDARD CHARACTERS WITHOUT CLAIM TO ANY PARTICULAR FONT, STYLE, SIZE, OR COLOR.

THE NAME(S), PORTRAIT(S), AND/OR SIGNATURE(S) SHOWN IN THE MARK IDENTIFIES THE NAME OF A PARTICULAR LIVING INDIVIDUAL, WHOSE CONSENT(S) TO REGISTER IS SUBMITTED.

FOR FLOWER ARRANGING; PROVIDING INFORMATION IN THE FIELD OF FLOWER ARRANGING (U.S. CLS. 100 AND 101).

FIRST USE 9-10-2005; IN COMMERCE 9-10-2005.

3,568,220. STORANDT PANN MARGOLIS, INC., LA GRANGE, IL. SN 77-189,215. PUB. 11-20-2007, FILED 5-24-2007.

DISCOVER MORE

THE MARK CONSISTS OF STANDARD CHARACTERS WITHOUT CLAIM TO ANY PARTICULAR FONT, STYLE, SIZE, OR COLOR.

FOR HOSPITAL AND HEALTHCARE SERVICES (U.S. CLS. 100 AND 101).

FIRST USE 10-7-2007; IN COMMERCE 10-7-2007.

3,568,700. VIVAX MEDICAL CORPORATION, TORRINGTON, CT. SN 78-975,565. PUB. 9-13-2005, FILED 1-23-2003.

SOMA

FOR MEDICAL EQUIPMENT CONSULTATION AND INFORMATION SERVICES IN THE FIELD OF MEDICAL ASSISTIVE TECHNOLOGY FOR PATIENTS IN ACUTE CARE, REHABILITATION, LONG TERM CARE FACILITIES AND HOME CARE PROGRAMS (U.S. CLS. 100 AND 101).

FIRST USE 7-22-2008; IN COMMERCE 7-22-2008.

CLASS 45—PERSONAL AND LEGAL SERVICES

3,568,505. WATTS, JAMIE, SAN MATEO, FL. SN 77-396,716. PUB. 7-22-2008, FILED 2-14-2008.

WHEN YOU SAY..."I JUST WANT CREMATION!" ...WE KNOW EXACTLY WHAT YOU MEAN!

3,568,503. BOYD GAMING CORPORATION, LAS VEGAS, NV. SN 77-395,923. PUB. 7-8-2008, FILED 2-13-2008.



THE MARK CONSISTS OF "B" IN A CIRCLE WITH THE WORD "CONNECTED" AFTER IT.

FOR HEALTH SPA SERVICES, NAMELY, COSMETIC BODY CARE SERVICES AND MASSAGE SERVICES FEATURING A FREQUENT PLAYERS CLUB INCENTIVE PROGRAM (U.S. CLS. 100 AND 101).

FIRST USE 10-30-2008; IN COMMERCE 10-30-2008.

THE MARK CONSISTS OF STANDARD CHARACTERS WITHOUT CLAIM TO ANY PARTICULAR FONT, STYLE, SIZE, OR COLOR.

NO CLAIM IS MADE TO THE EXCLUSIVE RIGHT TO USE "CREMATION", APART FROM THE MARK AS SHOWN.

FOR CREMATION (U.S. CLS. 100 AND 101).

FIRST USE 11-10-2008; IN COMMERCE 11-10-2008.

CLASS 45—(Continued).

3,568,708. THECIRCLE.ORG, LLC, CINCINNATI, OH. SN 78-980,829. PUB. 3-18-2008, FILED 8-9-2006.

MY CIRCLE

THE MARK CONSISTS OF STANDARD CHARACTERS WITHOUT CLAIM TO ANY PARTICULAR FONT, STYLE, SIZE, OR COLOR.

FOR PROVIDING A WEBSITE FEATURING INFORMATION IN THE FIELD OF PERSONAL IMPROVEMENT (U.S. CLS. 100 AND 101).

FIRST USE 6-29-2007; IN COMMERCE 6-29-2007.

* * * * *

PRIOR UNITED STATES CLASSIFICATION

APPLICATION IN ONE CLASS

COLLECTIVE MEMBERSHIP MARKS

CLASS 200—COLLECTIVE MEMBERSHIP

3,568,295. DELTA ALPHA CHI, INC., OKLAHOMA CITY, OK.
SN 77-257,922. PUB. 2-19-2008, FILED 8-17-2007.

DELTA ALPHA CHI

THE MARK CONSISTS OF STANDARD CHARACTERS WITHOUT CLAIM TO ANY PARTICULAR FONT, STYLE, SIZE, OR COLOR.

FOR INDICATING MEMBERSHIP IN A CHRISTIAN COLLEGIATE FRATERNAL ORGANIZATION (U.S. CL. 200).

FIRST USE 9-23-2005; IN COMMERCE 9-23-2005.

3,568,296. DELTA ALPHA CHI, INC., OKLAHOMA CITY, OK.
SN 77-257,949. PUB. 2-19-2008, FILED 8-17-2007.

Δ A X

THE MARK CONSISTS OF THE GREEK LETTERS DELTA ALPHA AND CHI.

FOR TO INDICATE MEMBERSHIP IN A CHRISTIAN COLLEGIATE FRATERNAL ORGANIZATION (U.S. CL. 200).

FIRST USE 9-23-2005; IN COMMERCE 9-23-2005.

3,568,583. IMPERIAL COUNCIL OF SHRINERS ANCIENT ARABIC ORDER NOBLES OF THE MYSTIC SHRINE (AAONMS) NATIONAL COMPACT USA, DAYTON, OH. SN 78-424,499. PUB. 8-22-2006, FILED 5-25-2004.



THE COLORS GRAY AND BLACK ARE CLAIMED AS A FEATURE OF THE MARK.

THE COLOR BLACK APPEARS AS THE OUTLINE OF THE HEAD DRESS, CHEST DRESS AND OTHER FACIAL FEATURES, AND GRAY APPEARS IN THE AREA BEING THE FACE AND NECK, IN THE AREA BEING THE SPHERE AND SIDE HEAD DRESS OF THE FACE, AND IN THE AREA BEING THE UPPER CHEST DRESS OF THE FACE, INCLUDING THE SEVEN SMALL CIRCLES FORMING AN ANCHOR PATTERN.

FOR INDICATING MEMBERSHIP IN A FRATERNAL SOCIETY (U.S. CL. 200).

FIRST USE 10-1-2004; IN COMMERCE 10-1-2004.

CERTIFICATION MARKS

CLASS B—SERVICES

3,568,175. SURGICAL OUTCOME SUPPORT, INC., PALM BEACH GARDENS, FL. SN 77-150,337. PUB. 9-4-2007, FILED 4-6-2007.

PCS

THE MARK CONSISTS OF STANDARD CHARACTERS WITHOUT CLAIM TO ANY PARTICULAR FONT, STYLE, SIZE, OR COLOR.

THE CERTIFICATION MARK, AS INTENDED TO BE USED BY AUTHORIZED PERSONS, IS INTENDED TO

CERTIFY THAT THESE PERSONS PROVIDE ADVANCED PERIOPERATIVE CARDIAC KNOWLEDGE AND QUALITY SERVICES TO ACHIEVE OPTIMAL SURGICAL OUTCOMES, AND THAT THESE PERSONS PROVIDE SUCH SERVICES WITH A CERTAIN EXPERTISE AS DEMONSTRATED BY THEIR RECEIVING EDUCATIONAL TRAINING IN THE FIELD PROVIDED BY THE CERTIFIER AND SUCCESSFULLY SATISFYING THE MINIMAL STANDARDS AND CRITERIA ESTABLISHED BY THE CERTIFIER.

FOR POST-SURGICAL AND PERIOPERATIVE CARDIAC HEALTHCARE AND SUPPORT SERVICES (U.S. CL. B).

FIRST USE 9-21-2007; IN COMMERCE 9-21-2007.

* * * * *

SUPPLEMENTAL REGISTER

These registrations are not subject to opposition.

SECTION 1.— INTERNATIONAL CLASSIFICATION

The short titles associated below with the international class numbers are terms designed merely for quick identification and are not an official part of the international classification. The full names of international classes are given in section 6.1 of the trademark rules of practice.

The designation "U.S. Cl." appearing in this section refers to the U.S. class in effect prior to Sep. 1, 1973 rather than the international class which applies to applications filed on or after that date. For adoption of international classification see notice in the OFFICIAL GAZETTE of Jun. 26, 1973 (911 O.G. TM 210).

Application in more than one class

3,568,710. FARRINGTON, ROBYN J., WESTFIELD, NJ. SN 76-682,114. FILED P.R. 9-20-2007; AM. S.R. 6-5-2008.

3,568,720. GVL INC., LITCHFIELD, MN. SN 77-206,529. FILED P.R. 6-14-2007; AM. S.R. 12-13-2008.

THE ORIGINAL FARMER DESIGNED

FARRINGTON

THE MARK CONSISTS OF STANDARD CHARACTERS WITHOUT CLAIM TO ANY PARTICULAR FONT, STYLE, SIZE, OR COLOR.

NO CLAIM IS MADE TO THE EXCLUSIVE RIGHT TO USE "THE ORIGINAL", APART FROM THE MARK AS SHOWN.

CLASS 7—MACHINERY

FOR CORN-HEAD GATHERER SHIELDS (U.S. CLS. 13, 19, 21, 23, 31, 34 AND 35).
FIRST USE 5-0-2003; IN COMMERCE 5-0-2003.

CLASS 35—ADVERTISING AND BUSINESS

FOR ON-LINE RETAIL STORE SERVICES AND WHOLESALE DISTRIBUTORSHIPS FEATURING CORN-HEAD GATHERER SHIELDS; CONDUCTING TRADE SHOWS IN THE FIELD OF CORN-HEAD GATHERER SHIELDS (U.S. CLS. 100, 101 AND 102).
FIRST USE 5-0-2003; IN COMMERCE 5-0-2003.

THE MARK CONSISTS OF STANDARD CHARACTERS WITHOUT CLAIM TO ANY PARTICULAR FONT, STYLE, SIZE, OR COLOR.

CLASS 8—HAND TOOLS

FOR ICE SCRAPERS AND SNOW SHOVEL WITH HEATING ELEMENTS (U.S. CLS. 23, 28 AND 44).
FIRST USE 9-27-2007; IN COMMERCE 9-27-2007.

CLASS 10—MEDICAL APPARATUS

FOR WALKERS, ROLLATORS, CRUTCHES WITH HEATING ELEMENTS (U.S. CLS. 26, 39 AND 44).
FIRST USE 9-27-2007; IN COMMERCE 9-27-2007.

CLASS 12—VEHICLES

FOR WHEELCHAIR AND NON-MOTORIZED SCOOTERS WITH HEATING ELEMENTS (U.S. CLS. 19, 21, 23, 31, 35 AND 44).
FIRST USE 9-27-2007; IN COMMERCE 9-27-2007.

CLASS 18—LEATHER GOODS

FOR UMBRELLAS, CANES AND WALKING STICKS, ALL WITH HEATING ELEMENTS (U.S. CLS. 1, 2, 3, 22 AND 41).
FIRST USE 9-27-2007; IN COMMERCE 9-27-2007.

3,568,724. SYMPATHYFOOD.COM, LLC, BOWLING GREEN, VA. SN 77-269,808. FILED P.R. 8-31-2007; AM. S.R. 12-17-2008.

SYMPATHYFOOD

THE MARK CONSISTS OF STANDARD CHARACTERS WITHOUT CLAIM TO ANY PARTICULAR FONT, STYLE, SIZE, OR COLOR.

CLASS 29—MEATS AND PROCESSED FOODS

FOR FOODS PROVIDED TO INDIVIDUALS FOR BEREAVED FRIENDS AND FAMILY, NAMELY, FROZEN, PREPARED AND PACKAGED ENTREES CONSISTING PRIMARILY OF MEAT, FISH, POULTRY OR VEGETABLES (U.S. CL. 46).
FIRST USE 7-1-2007; IN COMMERCE 1-15-2008.

CLASS 30—STAPLE FOODS

FOR FOODS PROVIDED TO INDIVIDUALS FOR BEREAVED FRIENDS AND FAMILY, NAMELY, FROZEN, PREPARED AND PACKAGED ENTREES CONSISTING PRIMARILY OF PASTA OR RICE (U.S. CL. 46).
FIRST USE 7-1-2007; IN COMMERCE 1-15-2008.

CLASS 31—NATURAL AGRICULTURAL PRODUCTS

FOR FOODS PROVIDED TO INDIVIDUALS FOR BEREAVED FRIENDS AND FAMILY, NAMELY, FRESH FRUITS, FRESH VEGETABLES, FRESH NUTS FRUIT SEEDS AND UNPROCESSED GRAINS AND FRESH HERBS (U.S. CLS. 1 AND 46).
FIRST USE 7-1-2007; IN COMMERCE 1-15-2008.

CLASS 35—ADVERTISING AND BUSINESS

FOR COMPUTERIZED ON-LINE RETAIL STORE SERVICES IN THE FIELD OF PROVIDING FOOD AND GIFTS TO INDIVIDUALS FOR BEREAVED FRIENDS AND FAMILY (U.S. CLS. 100, 101 AND 102).
FIRST USE 7-1-2007; IN COMMERCE 1-15-2008.

3,568,733. ASSOCIATION SERVICES OF AMERICA, INC., CENTERVILLE, MA. SN 77-308,027. FILED P.R. 10-18-2007; AM. S.R. 7-24-2008.

CHRISTIANSUSA

THE MARK CONSISTS OF STANDARD CHARACTERS WITHOUT CLAIM TO ANY PARTICULAR FONT, STYLE, SIZE, OR COLOR.

CLASS 35—ADVERTISING AND BUSINESS

FOR ASSOCIATION SERVICES, NAMELY, PROMOTING THE INTERESTS OF CHRISTIANS; ADMINISTERING A DISCOUNT PROGRAM THAT ENABLES MEMBERS TO OBTAIN DISCOUNTS ON CHRISTIAN-RELATED GOODS AND SERVICES, NAMELY, BOOKS, AUDIO AND VIDEO PROGRAMS, MAGAZINES, APPAREL, VEHICLE RENTAL, TRAVEL AND ENTERTAINMENT; PROMOTION OF CREDIT CARDS AND FINANCIAL AND INSURANCE SERVICES, ON BEHALF OF THIRD PARTIES (U.S. CLS. 100, 101 AND 102).
FIRST USE 7-1-2008; IN COMMERCE 7-1-2008.

CLASS 45—PERSONAL AND LEGAL SERVICES

FOR OPERATING A WEBSITE FOR ASSOCIATION MEMBERS FEATURING INFORMATION ABOUT MINISTERIAL SERVICES, NAMELY, CHURCHES, OTHER CHURCH-RELATED MINISTERIAL EVENTS, MINISTRIES, BIBLE TEACHINGS, SERMONS, AND LISTINGS OF RADIO AND TV PROGRAMS THAT FEATURE CHRISTIAN-BASED PROGRAMS (U.S. CLS. 100 AND 101).
FIRST USE 7-1-2008; IN COMMERCE 7-1-2008.

3,568,741. TOLSTOY, SVIATOSLAV G., BOSTON, MA. SN 77-388,418. FILED P.R. 2-5-2008; AM. S.R. 12-12-2008.

International String Trio

THE MARK CONSISTS OF STANDARD CHARACTERS WITHOUT CLAIM TO ANY PARTICULAR FONT, STYLE, SIZE, OR COLOR.

CLASS 9—ELECTRICAL AND SCIENTIFIC APPARATUS

FOR MUSIC-COMPOSITION SOFTWARE; MUSICAL SOUND RECORDINGS; MUSICAL VIDEO RECORDINGS; SOUND RECORDINGS FEATURING MUSICAL PERFORMANCES; VIDEO RECORDINGS FEATURING MUSICAL COMPOSITIONS, EDUCATIONAL MATERIALS IN THE FIELD OF MUSIC; VISUAL RECORDINGS AND AUDIO VISUAL RECORDINGS FEATURING MUSIC AND ANIMATION (U.S. CLS. 21, 23, 26, 36 AND 38).
FIRST USE 9-15-1999; IN COMMERCE 9-15-1999.

CLASS 41—EDUCATION AND ENTERTAINMENT

FOR COMPOSITION OF MUSIC FOR OTHERS; CONSULTATION AND ADVICE REGARDING MUSICAL SELECTIONS AND ARRANGEMENTS FOR SOUND RECORDINGS AND LIVE PERFORMANCES; EDUCATION IN THE FIELD OF MUSICAL COMPOSITIONS RENDERED THROUGH CORRESPONDENCE COURSES; EDUCATION IN THE FIELD OF MUSIC RENDERED THROUGH VIDEO CONFERENCE; EDUCATION IN THE FIELDS OF MUSIC RENDERED THROUGH CORRESPONDENCE COURSES; ENTERTAINMENT IN THE NATURE OF AN ON-GOING SPECIAL VARIETY, NEWS, MUSIC OR COMEDY SHOW FEATURING MUSIC BROADCAST OVER TELEVISION, SATELLITE, AUDIO, AND VIDEO MEDIA; ENTERTAINMENT IN THE NATURE OF VISUAL AND AUDIO PERFORMANCES, AND MUSICAL, VARIETY, NEWS AND COMEDY SHOWS; ENTERTAINMENT IN THE NATURE OF VISUAL AND AUDIO PERFORMANCES, NAMELY, MUSICAL BAND, ROCK GROUP, GYMNAS-TIC, DANCE, AND BALLET PERFORMANCES; ENTERTAINMENT IN THE NATURE OF LIVE MUSICAL PERFORMANCES AND CONCERTS; ENTERTAINMENT SERVICES IN THE NATURE OF LIVE MUSICAL PERFORMANCES; ENTERTAINMENT SERVICES, NAMELY, AN ONLINE ACTIVITY WHERE YOU CREATE YOUR OWN MUSIC VIDEOS; ENTERTAINMENT SERVICES, NAMELY, NON-DOWNLOADABLE RINGTONES, PRE-RECORDED MUSIC, VIDEO AND GRAPHICS PRESENTED TO MOBILE COMMUNICATIONS DEVICES VIA A GLOBAL COMPUTER NETWORK AND WIRELESS NETWORKS; ENTERTAINMENT SERVICES, NAMELY, PROVIDING A WEB SITE FEATURING MUSICAL PERFORMANCES, MUSICAL VIDEOS, RELATED

FILM CLIPS, PHOTOGRAPHS, AND OTHER MULTIMEDIA MATERIALS; ENTERTAINMENT SERVICES, NAMELY, PROVIDING ON-LINE REVIEWS OF MUSICAL COMPOSITIONS; ENTERTAINMENT SERVICES, NAMELY, PROVIDING PRERECORDED MUSIC, INFORMATION IN THE FIELD OF MUSIC, AND COMMENTARY AND ARTICLES ABOUT MUSIC, ALL ON-LINE VIA A GLOBAL COMPUTER NETWORK; ENTERTAINMENT, NAMELY, LIVE MUSIC CONCERTS; ENTERTAINMENT, NAMELY, LIVE PERFORMANCES BY A MUSICAL BAND; ENTERTAINMENT, NAMELY, LIVE PERFORMANCES BY MUSICAL BANDS; INSTRUCTION IN THE FIELD OF MUSIC; MULTIMEDIA ENTERTAINMENT SERVICES IN THE NATURE OF RECORDING, PRODUCTION AND POST-PRODUCTION SERVICES IN THE FIELDS OF MUSIC, VIDEO, AND FILMS; MULTIMEDIA PUBLISHING OF BOOKS, MAGAZINES, JOURNALS, SOFTWARE, GAMES, MUSIC, AND ELECTRONIC PUBLICATIONS; MUSIC COMPOSITION AND TRANSCRIPTION FOR OTHERS; MUSIC COMPOSITION FOR OTHERS; MUSIC PRODUCTION SERVICES; MUSIC PUBLISHING SERVICES; MUSIC SELECTION SERVICES FOR USE IN TV, FILM, RADIO AND VIDEO GAMES; MUSIC TRANSCRIPTION FOR OTHERS; MUSIC-HALLS; POST-PRODUCTION EDITING SERVICES IN THE FIELD OF MUSIC, VIDEOS AND FILMS; PRESENTATION OF MUSICAL PERFORMANCE; PRODUCTION OF SOUND AND MUSIC VIDEO RECORDINGS; PROVIDING FACILITIES FOR MOVIES, SHOWS, PLAYS, MUSIC OR EDUCATIONAL TRAINING; PUBLICATION OF MUSICAL TEXTS; RENTAL OF MUSICAL INSTRUMENTS; RENTAL OF PHONOGRAPHIC AND MUSIC RECORDINGS; TEACHING IN THE FIELD OF MUSIC (U.S. CLS. 100, 101 AND 107).
FIRST USE 9-15-1999; IN COMMERCE 9-15-1999.

3,568,755. WHITE CASTLE MANAGEMENT CO., COLUMBUS, OH. SN 77-430,882. FILED P.R. 3-25-2008; AM. S.R. 12-9-2008.

REAL GOOD COFFEE

THE MARK CONSISTS OF STANDARD CHARACTERS WITHOUT CLAIM TO ANY PARTICULAR FONT, STYLE, SIZE, OR COLOR.

NO CLAIM IS MADE TO THE EXCLUSIVE RIGHT TO USE "COFFEE", APART FROM THE MARK AS SHOWN.

CLASS 21—HOUSEWARES AND GLASS

FOR COFFEE CUPS, TEA CUPS AND MUGS (U.S. CLS. 2, 13, 23, 29, 30, 33, 40 AND 50).

FIRST USE 1-0-2001; IN COMMERCE 1-0-2001.

CLASS 30—STAPLE FOODS

FOR COFFEE (U.S. CL. 46).

FIRST USE 1-0-2001; IN COMMERCE 1-0-2001.

3,568,750. EMPOWEREDBENEFITS, LLC, CHARLOTTE, NC. SN 77-407,138. FILED P.R. 2-27-2008; AM. S.R. 12-10-2008.

3,568,756. LEVY, JEFFREY, THORNHILL, CANADA. SN 77-437,429. FILED 4-1-2008.

ProfessionalsInPractice

THE MARK CONSISTS OF STANDARD CHARACTERS WITHOUT CLAIM TO ANY PARTICULAR FONT, STYLE, SIZE, OR COLOR.

OWNER OF U.S. REG. NO. 3,495,089.

CLASS 35—ADVERTISING AND BUSINESS

FOR PROVIDING AN ONLINE DIRECTORY INFORMATION SERVICE FEATURING INFORMATION REGARDING GENERAL PROFESSIONAL SERVICES, THE SERVICE SECTOR AND SERVICES INDUSTRIES, ALL TYPES OF PRACTITIONERS AND PROVIDERS, ALL TYPES OF PROFESSIONALS AND PERSONNEL, ALL TYPES OF FACILITIES, INSTITUTIONS AND ORGANIZATIONS, CAREERS, RECRUITMENT AND EMPLOYMENT, PARTNERSHIPS AND JOINT VENTURES, CLASSIFIEDS, VIRTUAL COMMUNITY, PROFESSIONAL NETWORKING, SOCIAL NETWORKING, BUSINESS NETWORKING, ONLINE COMMUNICATIONS NETWORKING, PRACTICE MANAGEMENT INFORMATION SHARING, JOURNAL SHARING, ARTICLES AND FINDINGS SHARING, DISCUSSION FORUMS, PHOTO SHARING, AND TRANSMISSION OF PHOTOGRAPHIC IMAGES; ADVERTISING AND INFORMATION DISTRIBUTION SERVICES, NAMELY, PROVIDING ADVERTISING SPACE VIA THE GLOBAL COMPUTER NETWORK; PROMOTING THE GOODS AND SERVICES OF OTHERS OVER THE INTERNET; PROVIDING ONLINE COMPUTER DATABASES AND ONLINE SEARCHABLE DATABASES FEATURING COMMERCIAL DIRECTORY INFORMATION IN THE FIELDS OF GENERAL PROFESSIONAL SERVICES, THE SERVICE SECTOR AND SERVICES INDUSTRIES, ALL TYPES OF PRACTI-

CareCost

THE MARK CONSISTS OF STANDARD CHARACTERS WITHOUT CLAIM TO ANY PARTICULAR FONT, STYLE, SIZE, OR COLOR.

CLASS 9—ELECTRICAL AND SCIENTIFIC APPARATUS

FOR COMPUTER SOFTWARE FOR ESTIMATING THE COST OF MEDICAL PROCEDURES (U.S. CLS. 21, 23, 26, 36 AND 38).

FIRST USE 2-27-2008; IN COMMERCE 2-27-2008.

CLASS 42—SCIENTIFIC AND COMPUTER SERVICES

FOR APPLICATION SERVICE PROVIDER (ASP) FEATURING SOFTWARE FOR USE IN ESTIMATING THE COST OF MEDICAL PROCEDURES (U.S. CLS. 100 AND 101).

FIRST USE 2-27-2008; IN COMMERCE 2-27-2008.

TIONERS AND PROVIDERS, ALL TYPES OF PROFESSIONALS AND PERSONNEL, ALL TYPES OF FACILITIES, INSTITUTIONS AND ORGANIZATIONS, CAREERS, RECRUITMENT AND EMPLOYMENT, PARTNERSHIPS AND JOINT VENTURES, CLASSIFIEDS, VIRTUAL COMMUNITY, PROFESSIONAL NETWORKING, SOCIAL NETWORKING, BUSINESS NETWORKING, ONLINE COMMUNICATIONS NETWORKING, PRACTICE MANAGEMENT INFORMATION SHARING, JOURNAL SHARING, ARTICLES AND FINDINGS SHARING, DISCUSSION FORUMS, PHOTO SHARING, AND TRANSMISSION OF PHOTOGRAPHIC IMAGES; ONLINE REFERRALS AND BUSINESS NETWORKING SERVICES, NAMELY PROVIDING REFERRALS AND NETWORKING SERVICES FOR ALL TYPES OF PROFESSIONALS AND PERSONNEL AND ALL TYPES OF FACILITIES, INSTITUTIONS AND ORGANIZATIONS; PROVIDING LEAD GENERATION SERVICES IN THE NATURE OF BUSINESS NETWORKING AND REFERRAL SERVICES THROUGH A REFERRAL NETWORK FOR ALL TYPES OF PROFESSIONALS, PROVIDERS, PRACTITIONERS, AND PERSONNEL; PROVIDING REFERRAL INFORMATION ABOUT AND MAKING REFERRALS IN THE FIELD OF CONSUMER PRODUCTS AND PROVIDING REFERRAL SERVICES FOR RETAIL SERVICES CONCERNING PRODUCTS, SERVICES, EVENTS, ACTIVITIES, ATTRACTIONS AND FACILITIES IN PARTICULAR GEOGRAPHIC LOCATIONS; BUSINESS RESEARCH AND EVALUATIONS, NAMELY, RATING, RANKING, REVIEWING, VERIFYING, AND MONITORING THE QUALITY OF SERVICE, PROFESSIONALISM AND CREDENTIALS OF ALL TYPES OF PROFESSIONALS, PROVIDERS, PRACTITIONERS AND PERSONNEL; DISSEMINATION OF SCHEDULING AND APPOINTMENT SCHEDULING INFORMATION VIA A GLOBAL COMPUTER NETWORK; PROVIDING ONLINE SCHEDULING AND APPOINTMENT SCHEDULING REGISTRATION WITH ALL TYPES OF PROFESSIONALS, PROVIDERS, PRACTITIONERS, AND PERSONNEL; PROVIDING ONLINE REGISTRATIONS, SUBMISSION OF APPLICATIONS AND APPOINTMENT SCHEDULING WITH ALL TYPES OF FACILITIES, INSTITUTIONS AND ORGANIZATIONS FOR TEMPORARY, SHIFT-WORK, PART-TIME, FULL-TIME, CONTRACT, LOCUM, REPLACEMENT, SHORT-TERM AND LONG-TERM EMPLOYMENT AND FOR ASSOCIATESHIPS, PARTNERSHIPS, JOINT VENTURES AND BUSINESS OWNERSHIPS OR SHAREHOLDINGS; PROVIDING BUSINESS AND PROFESSIONAL BUSINESS CONSULTATION TO THE SERVICES INDUSTRIES IN THE FIELDS OF THE DEVELOPMENT AND IMPLEMENTATION OF POLICIES, PRACTICES, QUALITY ASSURANCE, MANAGEMENT, FINANCE, LAW, MEDIA AND PUBLICATIONS (U.S. CLS. 100, 101 AND 102).

FIRST USE 8-8-2007; IN COMMERCE 8-8-2007.

CLASS 38—COMMUNICATION

FOR PROVIDING A WEB SITE FEATURING AN ONLINE COMPUTER DATABASE AND ONLINE SEARCHABLE DATABASES FEATURING DISCUSSION FORUMS, ELECTRONIC BULLETIN BOARDS, CHAT ROOMS AND ELECTRONIC JOURNAL ENTRIES FOR USERS FOR TRANSMISSION OF MESSAGES, CONTENT, DISCOVERIES, FINDINGS, INFORMATION, PICTURES REGARDING GENERAL PROFESSIONAL SERVICES, THE SERVICE SECTOR AND SERVICES INDUSTRIES, ALL TYPES OF PRACTITIONERS AND PROVIDERS, ALL TYPES OF PROFESSIONALS AND PERSONNEL, ALL TYPES OF FACILITIES, INSTITUTIONS AND ORGANIZATIONS, CAREERS, RECRUITMENT AND EMPLOYMENT, PARTNERSHIPS AND JOINT VENTURES, CLASSIFIEDS, VIRTUAL COMMUNITY, PROFESSIONAL NETWORKING, SOCIAL NETWORKING, BUSINESS NETWORKING, ONLINE COMMUNICATIONS NETWORKING, PRACTICE MANAGEMENT INFORMATION SHARING, JOURNAL SHARING, ARTICLES AND FINDINGS SHARING, DISCUSSION FORUMS, PHOTO SHARING, AND TRANSMISSION OF PHOTOGRAPHIC IMAGES (U.S. CLS. 100, 101 AND 104).

FIRST USE 8-8-2007; IN COMMERCE 8-8-2007.

3,568,762. PAVE TECH, INC., PRIOR LAKE, MN. SN 77-474,453. FILED P.R. 5-14-2008; AM. S.R. 12-3-2008.

HARDSCAPE OUTFITTERS

THE MARK CONSISTS OF STANDARD CHARACTERS WITHOUT CLAIM TO ANY PARTICULAR FONT, STYLE, SIZE, OR COLOR.

NO CLAIM IS MADE TO THE EXCLUSIVE RIGHT TO USE "HARDSCAPE", APART FROM THE MARK AS SHOWN.

CLASS 1—CHEMICALS

FOR ADHESIVES USED FOR PAVING STONES, BLOCK WALLS AND OTHER HARDSCAPES (U.S. CLS. 1, 5, 6, 10, 26 AND 46).

FIRST USE 11-25-2008; IN COMMERCE 11-25-2008.

CLASS 2—PAINTS

FOR SEALER COATINGS USED FOR PAVING STONES, BLOCK WALLS AND OTHER HARDSCAPES (U.S. CLS. 6, 11 AND 16).

FIRST USE 11-25-2008; IN COMMERCE 11-25-2008.

CLASS 3—COSMETICS AND CLEANING PREPARATIONS

FOR CLEANING PREPARATIONS USED FOR PAVING STONES, BLOCK WALLS AND OTHER HARDSCAPES (U.S. CLS. 1, 4, 6, 50, 51 AND 52).

FIRST USE 11-25-2008; IN COMMERCE 11-25-2008.

CLASS 8—HAND TOOLS

FOR HAND TOOLS AND IMPLEMENTS USED FOR THE INSTALLATION AND MAINTENANCE OF PAVING STONES, WALL BLOCKS AND SLABS; NAMELY, PAVING STONE SPLITTERS, BLOCK SPLITTERS, SLAB SPLITTERS, PAVING STONE AND BLOCK EXTRACTORS, PAVING STONE AND BLOCK HAMMERS (U.S. CLS. 23, 28 AND 44).

FIRST USE 11-25-2008; IN COMMERCE 11-25-2008.

CLASS 11—ENVIRONMENTAL CONTROL APPARATUS

FOR LIGHTING COMPONENTS FOR SEGMENTAL PAVING AND WALL BLOCKS; NAMELY, TRANSLUCENT BLOCKS INCORPORATING AN INTERNAL LIGHTING SYSTEM (U.S. CLS. 13, 21, 23, 31 AND 34).

FIRST USE 11-25-2008; IN COMMERCE 11-25-2008.

SECTION 2.— INTERNATIONAL CLASSIFICATION

The short titles associated below with the international class numbers are terms designed merely for quick identification and are not an official part of the international classification. The full names of international classes are given in section 6.1 of the trademark rules of practice.

The designation "U.S. Cl." appearing in this section refers to the U.S. class in effect prior to Sep. 1, 1973 rather than the international class which applies to applications filed on or after that date. For adoption of international classification see notice in the OFFICIAL GAZETTE of Jun. 26, 1973 (911 O.G. TM 210).

Application in one class

CLASS 5—PHARMACEUTICALS

3,568,718. RISING PHARMACEUTICALS, INC., ALLENDALE, NJ. SN 77-186,802. FILED P.R. 5-22-2007; AM. S.R. 4-9-2008.



THE COLOR(S) LIGHT BLUE AND YELLOW IS/ARE CLAIMED AS A FEATURE OF THE MARK.

THE MARK CONSISTS OF A DEVICE DEPICTING A YELLOW SUN RISING AGAINST A BLUE SKY.

FOR PHARMACEUTICAL PREPARATIONS FOR THE TREATMENT OF DISEASES OF THE CENTRAL NERVOUS, CARDIOVASCULAR, GASTROINTESTINAL AND UPPER RESPIRATORY SYSTEMS AS WELL AS ALLERGIES, KIDNEY AND GALLSTONES, GOUT AND METABOLIC DISEASE; TOPICAL PREPARATIONS FOR THE TREATMENT OF A VARIETY OF SKIN IRRITATIONS AND SKIN DISEASES; ANTISEPTIC OINTMENT AND SKIN PROTECTANT; ANTI-ITCH CREAM; ANTI-INFLAMMATORY OINTMENT; DIETARY SUPPLEMENTS; NUTRITIONAL SUPPLEMENTS; ALLERGY MEDICATION; MULTI-VITAMIN PREPARATIONS; VITAMIN AND MINERAL SUPPLEMENTS; MEDICATED DIAPER RASH OINTMENT; ANTI-CAVITY DENTAL COATING PREPARATIONS CONTAINING FLUORIDE (U.S. CLS. 6, 18, 44, 46, 51 AND 52).

FIRST USE 6-24-2004; IN COMMERCE 6-24-2004.

CLASS 5—(Continued).

3,568,727. HONG SAM NARA, CORP., RIDGEFIELD, NJ. SN 77-288,879. FILED P.R. 9-25-2007; AM. S.R. 12-19-2008.



NO CLAIM IS MADE TO THE EXCLUSIVE RIGHT TO USE THE NON-LATIN CHARACTERS THAT MEAN "KOREAN RED GINSENG EXTRACT" AND "KOREAN RED GINSENG EXTRACT", APART FROM THE MARK AS SHOWN.

THE COLOR(S) GOLDEN YELLOW, WHITE, BURGUNDY IS/ARE CLAIMED AS A FEATURE OF THE MARK.

THE MARK CONSISTS OF A BURGUNDY COLORED BACKGROUND. THE LARGE CHINESE GOLDEN YELLOW CHARACTERS OF "DOK SAM TANG" ARE SITUATED IN THE MIDDLE OF THE MARK. THE WHITE KOREAN CHARACTERS OF "HONG SAM ACK" IS ON THE UPPER RIGHT OF THE MARK. "KOREAN RED GINSENG EXTRACT" IN GOLDEN YELLOW IS UNDERNEATH THE LARGE CHINESE CHARACTERS.

THE NON-LATIN CHARACTERS IN THE MARK TRANSLATE AS "KOREAN RED GINSENG EXTRACT".

THE MARK CONSISTS OF CHINESE CHARACTERS WHICH TRANSLITERATE AS "DOK SAM TANG"; THE KOREAN CHARACTERS AT THE TOP OF THE DRAWING TRANSLITERATE AS "HONG SAM ACK". THE NON-LATIN CHARACTERS SITUATED IN BETWEEN THE MARK'S CHINESE CHARACTERS TRANSLITERATE AS "DOK SAM TANG" IN KOREAN CHARACTERS.

FOR GINSENG FOR MEDICINAL USE; MEDICINAL HERB EXTRACTS; MEDICINAL HERBAL EXTRACTS FOR MEDICAL PURPOSES, ALL CONTAINING AN EXTRACT OF KOREAN RED GINSENG (U.S. CLS. 6, 18, 44, 46, 51 AND 52).

FIRST USE 12-14-2004; IN COMMERCE 12-14-2004.

CLASS 5—(Continued).

3,568,758. PERFICIO NETWORKS, IRVINE, CA. SN 77-462,007. FILED P.R. 4-30-2008; AM. S.R. 11-21-2008.

YOR ESSENTIAL VITAMIN

THE MARK CONSISTS OF STANDARD CHARACTERS WITHOUT CLAIM TO ANY PARTICULAR FONT, STYLE, SIZE, OR COLOR.

NO CLAIM IS MADE TO THE EXCLUSIVE RIGHT TO USE "ESSENTIAL VITAMIN", APART FROM THE MARK AS SHOWN.

FOR VITAMIN AND MINERAL SUPPLEMENTS; VITAMIN SUPPLEMENTS; VITAMINS; VITAMINS AND VITAMIN PREPARATIONS; STIMULATORY MEDICATIONS FOR USE IN WEIGHT REDUCTION PROGRAMS; THERAPEUTIC AGENTS FOR WEIGHT CONTROL AND APPETITE SUPPRESSION; DIET CAPSULES; DIET PILLS (U.S. CLS. 6, 18, 44, 46, 51 AND 52).

FIRST USE 4-1-2008; IN COMMERCE 4-14-2008.

CLASS 7—(Continued).

3,568,775. QUATRO AUTOMATION GROUP, LAGUNA HILLS, CA. SN 77-532,645. FILED P.R. 7-28-2008; AM. S.R. 11-14-2008.

USAutomation

THE MARK CONSISTS OF STANDARD CHARACTERS WITHOUT CLAIM TO ANY PARTICULAR FONT, STYLE, SIZE, OR COLOR.

FOR DIRECT CURRENT MOTORS; ELECTRIC MOTORS FOR MACHINES; LINEAR MOTORS; SYNCHRONOUS MOTORS NOT FOR LAND VEHICLES; ALTERNATING CURRENT MOTORS NOT FOR LAND VEHICLES; PLANETARY GEAR MOTORS; LINEAR ACTUATORS; LINEAR MOTIONS MACHINES FOR MOVING OBJECTS; MACHINE PARTS NAMELY, FLEXIBLE SHAFT COUPLINGS; MOTORS NOT FOR LAND VEHICLES; ALTERNATING CURRENT SERVO MOTORS; SHAFT COUPLINGS FOR MACHINES (U.S. CLS. 13, 19, 21, 23, 31, 34 AND 35).

FIRST USE 2-1-2003; IN COMMERCE 2-1-2003.

CLASS 6—METAL GOODS

3,568,737. BAUMANN RESEARCH & DEVELOPMENT CORP., SAN CLEMENTE, CA. SN 77-354,126. FILED P.R. 12-17-2007; AM. S.R. 12-18-2008.

WRG

THE MARK CONSISTS OF STANDARD CHARACTERS WITHOUT CLAIM TO ANY PARTICULAR FONT, STYLE, SIZE, OR COLOR.

FOR PREFORMED STEEL REINFORCEMENT MEMBERS FOR CONCRETE AND MASONRY CONSTRUCTION (U.S. CLS. 2, 12, 13, 14, 23, 25 AND 50).

FIRST USE 10-31-1997; IN COMMERCE 5-29-2002.

CLASS 9—ELECTRICAL AND SCIENTIFIC APPARATUS

3,568,723. POLYMORPH INSTRUMENTS, INC., SANTA CLARA, CA. SN 77-260,874. FILED P.R. 8-21-2007; AM. S.R. 11-25-2008.

MINI HOT BOX

THE MARK CONSISTS OF STANDARD CHARACTERS WITHOUT CLAIM TO ANY PARTICULAR FONT, STYLE, SIZE, OR COLOR.

NO CLAIM IS MADE TO THE EXCLUSIVE RIGHT TO USE "HOT BOX", APART FROM THE MARK AS SHOWN.

FOR LABORATORY APPARATUS FOR HEATING MATERIALS USING PRECISELY HEATED AIR, NAMELY, FLAMELESS ELECTRONIC GAS HEATERS FOR LABORATORY USE (U.S. CLS. 21, 23, 26, 36 AND 38).

FIRST USE 8-15-2007; IN COMMERCE 11-15-2007.

CLASS 7—MACHINERY

CLASS 9—(Continued).

3,568,728. SHEARDIGITAL INC., DBA GRAVITANT, INC., AUSTIN, TX. SN 77-293,731. FILED P.R. 10-2-2007; AM. S.R. 12-18-2008.

BusinessMatrix

THE MARK CONSISTS OF STANDARD CHARACTERS WITHOUT CLAIM TO ANY PARTICULAR FONT, STYLE, SIZE, OR COLOR.

FOR COMPUTER SOFTWARE FOR PLANNING AND DEFINING BUSINESS STRATEGY AND BUSINESS MODELS, AND FOR ANALYZING, MANAGING, MONITORING AND OPTIMIZING BUSINESS MODEL PERFORMANCE, CONTRACT PERFORMANCE, SERVICE LEVEL AGREEMENT PERFORMANCE AND COMPLIANCE, CORRECTIVE ACTIONS, OUTSOURCING RELATIONSHIPS AND VENDOR PERFORMANCE IN THE FIELD OF BUSINESS TRANSFORMATION MANAGEMENT (U.S. CLS. 21, 23, 26, 36 AND 38).

FIRST USE 10-1-2005; IN COMMERCE 12-1-2005.

CLASS 9—(Continued).

3,568,751. RMI CORPORATION, DBA RAZA MICROELECTRONICS, INC., CUPERTINO, CA. SN 77-411,097. FILED P.R. 3-3-2008; AM. S.R. 11-19-2008.

Home Media Player

THE MARK CONSISTS OF STANDARD CHARACTERS WITHOUT CLAIM TO ANY PARTICULAR FONT, STYLE, SIZE, OR COLOR.

FOR SEMICONDUCTOR CHIPS; SEMICONDUCTOR DEVICES; SEMICONDUCTORS; ELECTRONIC CHIPS FOR THE MANUFACTURER OF INTEGRATED CIRCUITS; ELECTRONIC INTEGRATED CIRCUITS; INTEGRATED CIRCUITS; INTEGRATED CIRCUITS AND INTEGRATED CIRCUIT CORES FOR USE IN WIRELESS COMMUNICATIONS AND WIRELESS COMMUNICATION EQUIPMENT AND APPARATI AND DIGITAL SIGNAL PROCESSORS (DSP); LARGE SCALE INTEGRATED CIRCUITS (U.S. CLS. 21, 23, 26, 36 AND 38).

FIRST USE 11-18-2008; IN COMMERCE 11-18-2008.

3,568,752. RMI CORPORATION, DBA RAZA MICROELECTRONICS, INC., CUPERTINO, CA. SN 77-411,102. FILED P.R. 3-3-2008; AM. S.R. 11-19-2008.

Home Media Processor

THE MARK CONSISTS OF STANDARD CHARACTERS WITHOUT CLAIM TO ANY PARTICULAR FONT, STYLE, SIZE, OR COLOR.

NO CLAIM IS MADE TO THE EXCLUSIVE RIGHT TO USE "PROCESSOR", APART FROM THE MARK AS SHOWN.

FOR SEMICONDUCTOR CHIPS; SEMICONDUCTOR DEVICES; SEMICONDUCTORS; ELECTRONIC CHIPS FOR THE MANUFACTURER OF INTEGRATED CIRCUITS; ELECTRONIC INTEGRATED CIRCUITS; INTEGRATED CIRCUITS; INTEGRATED CIRCUITS AND INTEGRATED CIRCUIT CORES FOR USE IN WIRELESS COMMUNICATIONS AND WIRELESS COMMUNICATION EQUIPMENT AND APPARATI AND DIGITAL SIGNAL PROCESSORS (DSP); LARGE SCALE INTEGRATED CIRCUITS (U.S. CLS. 21, 23, 26, 36 AND 38).

FIRST USE 11-18-2008; IN COMMERCE 11-18-2008.

3,568,742. INTERNATIONAL ENVIROGUARD SYSTEMS, INC., MESQUITE, TX. SN 77-397,871. FILED P.R. 2-15-2008; AM. S.R. 12-18-2008.

CHEMSPLASH

THE MARK CONSISTS OF STANDARD CHARACTERS WITHOUT CLAIM TO ANY PARTICULAR FONT, STYLE, SIZE, OR COLOR.

FOR PROTECTIVE CLOTHING (U.S. CLS. 21, 23, 26, 36 AND 38).

FIRST USE 8-13-2007; IN COMMERCE 9-10-2007.

CLASS 9—(Continued).

3,568,771. NATIONAL RURAL ELECTRIC COOPERATIVE ASSOCIATION, ARLINGTON, VA. SN 77-519,434. FILED P.R. 7-10-2008; AM. S.R. 12-10-2008.

**COOPERATIVE RESEARCH
NETWORK**

THE MARK CONSISTS OF STANDARD CHARACTERS WITHOUT CLAIM TO ANY PARTICULAR FONT, STYLE, SIZE, OR COLOR.

NO CLAIM IS MADE TO THE EXCLUSIVE RIGHT TO USE "RESEARCH NETWORK", APART FROM THE MARK AS SHOWN.

FOR DOWNLOADABLE ELECTRONIC PUBLICATIONS IN THE NATURE OF NEWSLETTERS, ARTICLES, BROCHURES, BOOKLETS, AND PAMPHLETS IN THE FIELD OF ELECTRICAL COOPERATIVES; DOWNLOADABLE COMPUTER SOFTWARE WITH A DATABASE FOR CONTACT MANAGEMENT AND CUSTOMER INFORMATION FOR ELECTRICAL COOPERATIVES; DIGITAL MATERIALS, NAMELY, CDS FEATURING INFORMATION IN THE FIELD OF ELECTRICAL COOPERATIVES (U.S. CLS. 21, 23, 26, 36 AND 38).

FIRST USE 1-13-2006; IN COMMERCE 1-13-2006.

3,568,788. LATASHA ANTOINETTE OBRIEN, DBA KIMMI KENNEDY, HOUSTON, TX. SN 77-566,986. FILED 9-10-2008.



THE MARK CONSISTS OF DOUBLE "K'S" ARRANGED BACK-TO-BACK WITH A SMALL TRIANGLE OVER THE MEETING PLACE OF THE TWO LETTERS, AND A FIVE-POINT STAR ON THE FAR RIGHT AND FAR LEFT WITH THE WORDS "KIMMI KENNEDY" DIRECTLY BENEATH THE ABOVE-DESCRIBED DESIGN.

FOR PRERECORDED DVD'S AND HIGH DEFINITION DIGITAL DISCS FEATURING POSES BY MODEL KIMMI KENNEDY DERIVED FROM PROFESSIONAL PHOTO-SHOOTS; DOWNLOADABLE GRAPHICS VIA A GLOBAL COMPUTER NETWORK AND WIRELESS DEVICES FEATURING POSES BY MODEL KIMMI KENNEDY DERIVED FROM PROFESSIONAL PHOTO-SHOOTS (U.S. CLS. 21, 23, 26, 36 AND 38).

FIRST USE 1-1-2006; IN COMMERCE 1-1-2006.

CLASS 10—MEDICAL APPARATUS**CLASS 10—(Continued).**

3,568,726. MYLNEK, DONALD A., OCEANSIDE, CA. SN 77-287,935. FILED 9-25-2007.

CTB

THE MARK CONSISTS OF STANDARD CHARACTERS WITHOUT CLAIM TO ANY PARTICULAR FONT, STYLE, SIZE, OR COLOR.

FOR EMERGENCY MEDICAL EQUIPMENT, NAMELY, COMBAT MEDICAL TRAUMA BAGS SOLD EMPTY (U.S. CLS. 26, 39 AND 44).

FIRST USE 6-1-2002; IN COMMERCE 6-1-2002.

3,568,730. MTS EUROPE GMBH, KONSTANZ, FED REP GERMANY. SN 77-304,824. FILED 10-16-2007.

VetGold

THE MARK CONSISTS OF STANDARD CHARACTERS WITHOUT CLAIM TO ANY PARTICULAR FONT, STYLE, SIZE, OR COLOR.

OWNER OF FED REP GERMANY REG. NO. 30735620, DATED 9-19-2007, EXPIRES 6-30-2017.

FOR SHOCKWAVE DEVICES, NAMELY, LITHOTRIPTER MEDICAL DEVICES FOR VETERINARIAN APPLICATIONS (U.S. CLS. 26, 39 AND 44).

CLASS 12—VEHICLES

3,568,766. CALIFORNIA MOTORS LLC, CAMARILLO, CA. SN 77-509,788. FILED P.R. 6-27-2008; AM. S.R. 12-11-2008.

GREEN PERFORMANCE

THE MARK CONSISTS OF STANDARD CHARACTERS WITHOUT CLAIM TO ANY PARTICULAR FONT, STYLE, SIZE, OR COLOR.

FOR MOTOR VEHICLES, NAMELY, AUTOMOBILES, ENGINES THEREFOR, AND STRUCTURAL PARTS THEREOF (U.S. CLS. 19, 21, 23, 31, 35 AND 44).

FIRST USE 5-15-2008; IN COMMERCE 5-15-2008.

CLASS 13—FIREARMS

CLASS 13—(Continued).

3,568,721. ROCK RIVER ARMS, INC., COLONA, IL. SN 77-212,257. FILED P.R. 6-21-2007; AM. S.R. 12-11-2008.

LAR-6.8

THE MARK CONSISTS OF STANDARD CHARACTERS WITHOUT CLAIM TO ANY PARTICULAR FONT, STYLE, SIZE, OR COLOR.
 OWNER OF U.S. REG. NO. 3,232,814.
 FOR FIREARMS, NAMELY, RIFLES AND SPARE PARTS AND REPLACEMENT PARTS FOR RIFLES (U.S. CLS. 2 AND 9).
 FIRST USE 1-0-2007; IN COMMERCE 1-0-2007.

CLASS 14—JEWELRY

3,568,729. CHOUVALIS, EMILY, BOCA RATON, FL. SN 77-296,562. FILED P.R. 10-4-2007; AM. S.R. 12-18-2008.

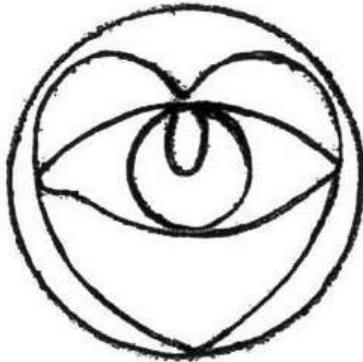

THE MARK CONSISTS OF AN IMAGE OF A CIRCLE SURROUNDING THE IMAGE OF A HEART SHAPE, INSIDE OF WHICH IS THE IMAGE OF AN EYE.
 FOR JEWELRY (U.S. CLS. 2, 27, 28 AND 50).
 FIRST USE 7-24-2008; IN COMMERCE 8-8-2008.

3,568,767. ACHOLI BEADS LLC, DBA ACHOLI BEADS, JAMUL, CA. SN 77-512,810. FILED P.R. 7-1-2008; AM. S.R. 12-11-2008.

Acholi Beads

THE MARK CONSISTS OF STANDARD CHARACTERS WITHOUT CLAIM TO ANY PARTICULAR FONT, STYLE, SIZE, OR COLOR.

CLASS 14—(Continued).

NO CLAIM IS MADE TO THE EXCLUSIVE RIGHT TO USE "BEADS", APART FROM THE MARK AS SHOWN.
 FOR BRACELETS; EARRINGS; JEWELRY; NECKLACES (U.S. CLS. 2, 27, 28 AND 50).
 FIRST USE 11-1-2007; IN COMMERCE 11-1-2007.

CLASS 16—PAPER GOODS AND PRINTED MATTER

3,568,717. CROW-ERICKSON, INC., ASHEVILLE, NC. SN 77-186,447. FILED P.R. 5-21-2007; AM. S.R. 10-13-2008.



THE COLOR(S) RED IS/ARE CLAIMED AS A FEATURE OF THE MARK.
 THE MARK CONSISTS OF RED END CAPS FOR PLACEMENT ON THE GOODS, NAMELY, CYLINDRICAL DOCUMENT HOLDERS. THE DASHED LINES ARE TO SHOW PLACEMENT AND ARE NOT PART OF THE CLAIMED MARK.
 FOR DOCUMENT HOLDERS (U.S. CLS. 2, 5, 22, 23, 29, 37, 38 AND 50).
 FIRST USE 12-0-1989; IN COMMERCE 12-0-1989.

3,568,740. ALBERT, ROCHEL, NORTH MIAMI BEACH, FL. SN 77-385,985. FILED P.R. 1-31-2008; AM. S.R. 11-18-2008.

Shower Marks

THE MARK CONSISTS OF STANDARD CHARACTERS WITHOUT CLAIM TO ANY PARTICULAR FONT, STYLE, SIZE, OR COLOR.
 NO CLAIM IS MADE TO THE EXCLUSIVE RIGHT TO USE "SHOWER", APART FROM THE MARK AS SHOWN.
 FOR SHOWER MARKERS IN THE NATURE OF SELF-ADHESIVE STICKERS FOR BATH AND SHOWER KNOBS TO MARK THE SPOT OF DESIRED WATER TEMPERATURE (U.S. CLS. 2, 5, 22, 23, 29, 37, 38 AND 50).
 FIRST USE 6-30-2008; IN COMMERCE 8-30-2008.

CLASS 16—(Continued).

3,568,743. NEW YORK CITY BALLET, INC., NEW YORK, NY. SN 77-398,434. FILED P.R. 2-15-2008; AM. S.R. 11-25-2008.

**NEW
YORK
CITY
BALLET**

OWNER OF U.S. REG. NO. 1,721,862.
THE COLOR(S) GRAY AND BLACK IS/ARE CLAIMED AS A FEATURE OF THE MARK.
THE MARK CONSISTS OF THE WORDS "NEW YORK CITY" IN DARKENING SHADES OF GRAY AND THE WORD "BALLET" IN BLACK.
FOR POSTERS (U.S. CLS. 2, 5, 22, 23, 29, 37, 38 AND 50).
FIRST USE 12-15-2007; IN COMMERCE 12-15-2007.

3,568,780. CYGNUS BUSINESS MEDIA, INC., FORT ATKINSON, WI. SN 77-561,406. FILED P.R. 9-3-2008; AM. S.R. 12-10-2008.

SECURITY EXECUTIVE

THE MARK CONSISTS OF STANDARD CHARACTERS WITHOUT CLAIM TO ANY PARTICULAR FONT, STYLE, SIZE, OR COLOR.
FOR MAGAZINES FEATURING INFORMATION IN THE FIELD OF PRIVATE SECURITY SERVICES AND THE CONTRACT SECURITY INDUSTRY (U.S. CLS. 2, 5, 22, 23, 29, 37, 38 AND 50).
FIRST USE 0-0-2005; IN COMMERCE 0-0-2005.

3,568,781. DREAMY CALENDARS LLC, LAS VEGAS, NV. SN 77-561,688. FILED P.R. 9-3-2008; AM. S.R. 12-12-2008.

Girls of Brazil

THE MARK CONSISTS OF STANDARD CHARACTERS WITHOUT CLAIM TO ANY PARTICULAR FONT, STYLE, SIZE, OR COLOR.
FOR CALENDARS (U.S. CLS. 2, 5, 22, 23, 29, 37, 38 AND 50).
FIRST USE 8-1-2008; IN COMMERCE 8-15-2008.

CLASS 16—(Continued).

3,568,787. GIZMAUX, LLC, BROOKLYN, NY. SN 77-565,846. FILED P.R. 9-9-2008; AM. S.R. 12-12-2008.

mustachios

THE MARK CONSISTS OF STANDARD CHARACTERS WITHOUT CLAIM TO ANY PARTICULAR FONT, STYLE, SIZE, OR COLOR.
OWNER OF U.S. REG. NO. 3,387,121.
FOR ANNOUNCEMENT CARDS; BLANK NOTE CARDS; CARDS BEARING UNIVERSAL GREETINGS; MOTIVATIONAL CARDS; OCCASION CARDS; POST CARDS; POSTCARDS AND GREETING CARDS; TRIVIA CARDS (U.S. CLS. 2, 5, 22, 23, 29, 37, 38 AND 50).
FIRST USE 6-19-2008; IN COMMERCE 6-19-2008.

3,568,793. A.C.S. USA, LLC, BROWNSTOWN, MI. SN 78-891,578. FILED P.R. 5-24-2006; AM. S.R. 12-16-2008.



FOR PRINTED MATTER, NAMELY, STICKERS, POSTERS (U.S. CLS. 2, 5, 22, 23, 29, 37, 38 AND 50).
FIRST USE 4-30-2006; IN COMMERCE 4-30-2006.

CLASS 16—(Continued).

3,568,794. VASE WRAPS, LLC, FRAMINGHAM, MA. SN 78-954,124. FILED P.R. 8-17-2006; AM. S.R. 10-24-2008.

VaseWraps

THE MARK CONSISTS OF STANDARD CHARACTERS WITHOUT CLAIM TO ANY PARTICULAR FONT, STYLE, SIZE, OR COLOR.

FOR DECORATIVE COVERS FOR FLOWER VASES AVAILABLE IN A WIDE VARIETY OF DESIGNS, COLORS, TEXTURES, AND MESSAGES, MADE OF SYNTHETIC PAPER (U.S. CLS. 2, 5, 22, 23, 29, 37, 38 AND 50).

FIRST USE 10-17-2006; IN COMMERCE 10-17-2006.

CLASS 19—NON-METALLIC BUILDING MATERIALS

3,568,753. SUSTAIN DANE, INC., MADISON, WI. SN 77-415,115. FILED 3-6-2008.

RAIN RESERVE

THE MARK CONSISTS OF STANDARD CHARACTERS WITHOUT CLAIM TO ANY PARTICULAR FONT, STYLE, SIZE, OR COLOR.

FOR SECONDARY MOISTURE DRAINAGE SYSTEM CONSISTING OF NON-METAL TROUGHS, COLLECTION BOXES AND NON-METAL BARRELS (U.S. CLS. 1, 12, 33 AND 50).

FIRST USE 6-22-2007; IN COMMERCE 6-22-2007.

CLASS 17—RUBBER GOODS

3,568,736. VISUAL WORKPLACE, LLC, BYRON CENTER, MI. SN 77-354,017. FILED P.R. 12-17-2007; AM. S.R. 11-20-2008.

FLOOR-MARK

THE MARK CONSISTS OF STANDARD CHARACTERS WITHOUT CLAIM TO ANY PARTICULAR FONT, STYLE, SIZE, OR COLOR.

FOR ADHESIVE TAPE FOR INDUSTRIAL AND COMMERCIAL USE (U.S. CLS. 1, 5, 12, 13, 35 AND 50).

FIRST USE 11-0-2007; IN COMMERCE 11-0-2007.

CLASS 20—FURNITURE AND ARTICLES NOT OTHERWISE CLASSIFIED

3,568,731. BATESVILLE SERVICES, INC., BATESVILLE, IN. SN 77-304,986. FILED P.R. 10-16-2007; AM. S.R. 10-30-2008.

TAILOR-MADE

THE MARK CONSISTS OF STANDARD CHARACTERS WITHOUT CLAIM TO ANY PARTICULAR FONT, STYLE, SIZE, OR COLOR.

FOR CASKETS (U.S. CLS. 2, 13, 22, 25, 32 AND 50).

FIRST USE 10-0-2007; IN COMMERCE 10-0-2007.

CLASS 18—LEATHER GOODS

3,568,735. THE BEGINNER'S BACKPACK L.L.C., NORTHVILLE, MI. SN 77-341,217. FILED P.R. 11-30-2007; AM. S.R. 10-6-2008.

BEGINNER'S BACKPACK

THE MARK CONSISTS OF STANDARD CHARACTERS WITHOUT CLAIM TO ANY PARTICULAR FONT, STYLE, SIZE, OR COLOR.

NO CLAIM IS MADE TO THE EXCLUSIVE RIGHT TO USE "BACKPACK", APART FROM THE MARK AS SHOWN. FOR BACKPACKS (U.S. CLS. 1, 2, 3, 22 AND 41).

FIRST USE 10-1-2007; IN COMMERCE 10-1-2007.

CLASS 21—HOUSEWARES AND GLASS

3,568,784. PAW WASH, LLC, LEAWOOD, KS. SN 77-564,662. FILED P.R. 9-8-2008; AM. S.R. 12-12-2008.

Brushless Paw Wash

THE MARK CONSISTS OF STANDARD CHARACTERS WITHOUT CLAIM TO ANY PARTICULAR FONT, STYLE, SIZE, OR COLOR.

FOR BRUSHLESS DOG PAW WASHING DEVICE, NAMELY, A PLASTIC CONTAINER IN THE SHAPE OF AN HOUR-GLASS FOR HOLDING CLEANING SOLUTION AND INTO WHICH DOG PAWS ARE INSERTED FOR CLEANING (U.S. CLS. 2, 13, 23, 29, 30, 33, 40 AND 50).

FIRST USE 3-30-2006; IN COMMERCE 8-29-2008.

CLASS 22—CORDAGE AND FIBERS

3,568,777. DAIGLE, RICHARD A., THIBODAUX, LA. SN 77-547,556. FILED P.R. 8-14-2008; AM. S.R. 12-7-2008.

SlingBag

THE MARK CONSISTS OF STANDARD CHARACTERS WITHOUT CLAIM TO ANY PARTICULAR FONT, STYLE, SIZE, OR COLOR.

FOR SACKS OR BAGS FOR THE TRANSPORTATION, LOADING, AND UNLOADING OF MATERIALS IN BULK (U.S. CLS. 1, 2, 7, 19, 22, 42 AND 50).

FIRST USE 1-1-2005; IN COMMERCE 1-1-2005.

CLASS 25—(Continued).

3,568,722. 88 INTERNATIONAL, INC., ALHAMBRA, CA. SN 77-259,710. FILED P.R. 8-20-2007; AM. S.R. 12-9-2008.

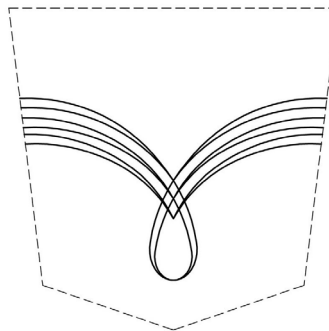

THE MARK CONSISTS OF STITCHING ON A POCKET. FOR CLOTHING, NAMELY, MEN, WOMEN AND CHILDREN'S SHIRTS, VESTS, JACKETS, SKIRTS AND PANTS (U.S. CLS. 22 AND 39).

FIRST USE 4-17-2007; IN COMMERCE 7-13-2007.

3,568,745. KENNETH L. MERRILL, SHERMAN OAKS, CA. SN 77-401,897. FILED P.R. 2-20-2008; AM. S.R. 12-2-2008.

CLASS 25—CLOTHING

3,568,711. JAFFERSON, INC., IRVING, TX. SN 76-686,350. FILED P.R. 1-31-2008; AM. S.R. 12-19-2008.

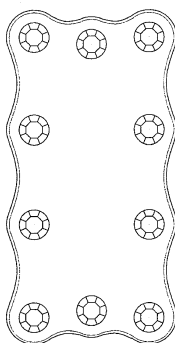

THE MARK CONSISTS OF A STYLIZED RECTANGLE DESIGN WITH WAVY SIDES AND THE STYLIZED DESIGN OF TEN SIMULATED GEMSTONES PLACED AROUND THE INSIDE EDGE OF THE STYLIZED RECTANGLE DESIGN.

FOR CLOTHING, NAMELY, BELTS (U.S. CLS. 22 AND 39).

FIRST USE 11-12-2006; IN COMMERCE 11-12-2006.

COCONUT TEASER

THE MARK CONSISTS OF STANDARD CHARACTERS WITHOUT CLAIM TO ANY PARTICULAR FONT, STYLE, SIZE, OR COLOR.

FOR SHORT-SLEEVED OR LONG-SLEEVED T-SHIRTS (U.S. CLS. 22 AND 39).

FIRST USE 12-1-2007; IN COMMERCE 12-1-2007.

3,568,746. KENNETH L. MERRILL, SHERMAN OAKS, CA. SN 77-401,956. FILED P.R. 2-20-2008; AM. S.R. 12-2-2008.

FM STATION LIVE

THE MARK CONSISTS OF STANDARD CHARACTERS WITHOUT CLAIM TO ANY PARTICULAR FONT, STYLE, SIZE, OR COLOR.

FOR LONG-SLEEVED SHIRTS; SHIRTS; SHORT-SLEEVED OR LONG-SLEEVED T-SHIRTS; SHORT-SLEEVED SHIRTS; T-SHIRTS; TEE SHIRTS (U.S. CLS. 22 AND 39).

FIRST USE 12-1-2007; IN COMMERCE 12-1-2007.

CLASS 25—(Continued).

3,568,747. KENNETH L. MERRILL, SHERMAN OAKS, CA. SN 77-402,022. FILED P.R. 2-20-2008; AM. S.R. 12-2-2008.

STARWOOD

THE MARK CONSISTS OF STANDARD CHARACTERS WITHOUT CLAIM TO ANY PARTICULAR FONT, STYLE, SIZE, OR COLOR.

FOR SHIRTS; SHORT-SLEEVED OR LONG-SLEEVED T-SHIRTS; SHORT-SLEEVED SHIRTS; T-SHIRTS; TEE SHIRTS; TOPS (U.S. CLS. 22 AND 39).

FIRST USE 12-1-2007; IN COMMERCE 12-1-2007.

CLASS 28—(Continued).

3,568,719. MARKER/VOLKL USA, INC., WEST LEBANON, NH. SN 77-193,142. FILED P.R. 5-30-2007; AM. S.R. 12-18-2008.

Chica

THE MARK CONSISTS OF STANDARD CHARACTERS WITHOUT CLAIM TO ANY PARTICULAR FONT, STYLE, SIZE, OR COLOR.

THE ENGLISH TRANSLATION OF THE WORD "CHICA" IN THE MARK IS GIRL.

FOR SNOW SKIS AND SNOWBOARDS (U.S. CLS. 22, 23, 38 AND 50).

FIRST USE 1-20-2007; IN COMMERCE 1-20-2007.

3,568,768. FERACI, JEREMY P., CAPE CORAL, FL. SN 77-514,109. FILED P.R. 7-2-2008; AM. S.R. 12-9-2008.

FERACI

THE MARK CONSISTS OF STANDARD CHARACTERS WITHOUT CLAIM TO ANY PARTICULAR FONT, STYLE, SIZE, OR COLOR.

FOR TIES (U.S. CLS. 22 AND 39).

FIRST USE 8-15-2008; IN COMMERCE 8-22-2008.

3,568,779. MICHAEL GIBSON, DBA FACTORY DIRECT MODELS, GILBERT, AZ. SN 77-560,874. FILED P.R. 9-2-2008; AM. S.R. 9-2-2008.

Factory Direct Models

THE MARK CONSISTS OF STANDARD CHARACTERS WITHOUT CLAIM TO ANY PARTICULAR FONT, STYLE, SIZE, OR COLOR.

NO CLAIM IS MADE TO THE EXCLUSIVE RIGHT TO USE "MODELS", APART FROM THE MARK AS SHOWN.

FOR SCALE MODEL AIRPLANES (U.S. CLS. 22, 23, 38 AND 50).

FIRST USE 8-21-2008; IN COMMERCE 8-21-2008.

3,568,773. PENDLETON WOOLEN MILLS, INC., PORTLAND, OR. SN 77-531,405. FILED P.R. 7-25-2008; AM. S.R. 12-12-2008.

PENDLETON

THE MARK CONSISTS OF STANDARD CHARACTERS WITHOUT CLAIM TO ANY PARTICULAR FONT, STYLE, SIZE, OR COLOR.

OWNER OF U.S. REG. NOS. 913,742, 2,059,665, AND OTHERS.

FOR FOOTWEAR (U.S. CLS. 22 AND 39).

FIRST USE 8-0-2006; IN COMMERCE 8-0-2006.

CLASS 30—STAPLE FOODS

3,568,774. EDIBLE ARRANGEMENTS, LLC, WALLINGFORD, CT. SN 77-532,417. FILED P.R. 7-28-2008; AM. S.R. 10-17-2008.

CINNAMON CHOCOLATE APPLE WEDGES

THE MARK CONSISTS OF STANDARD CHARACTERS WITHOUT CLAIM TO ANY PARTICULAR FONT, STYLE, SIZE, OR COLOR.

NO CLAIM IS MADE TO THE EXCLUSIVE RIGHT TO USE "CHOCOLATE" AND "APPLE WEDGES", APART FROM THE MARK AS SHOWN.

FOR CHOCOLATE COVERED FRUIT (U.S. CL. 46).

FIRST USE 7-1-2008; IN COMMERCE 7-1-2008.

CLASS 28—TOYS AND SPORTING GOODS

CLASS 32—LIGHT BEVERAGES

3,568,754. BARD'S TALE BEER COMPANY, LLC, EDINA, MN. SN 77-428,582. FILED P.R. 3-21-2008; AM. S.R. 12-10-2008.

THE ORIGINAL SORGHUM MALT
BEER

THE MARK CONSISTS OF STANDARD CHARACTERS WITHOUT CLAIM TO ANY PARTICULAR FONT, STYLE, SIZE, OR COLOR.

NO CLAIM IS MADE TO THE EXCLUSIVE RIGHT TO USE "MALT BEER", APART FROM THE MARK AS SHOWN.

FOR BEER (U.S. CLS. 45, 46 AND 48).

FIRST USE 11-30-2008; IN COMMERCE 11-30-2008.

SERVICE MARKS
CLASS 35—ADVERTISING AND BUSINESS

3,568,715. ITV MARKETING GROUP, INC., BEVERLY, MA. SN 77-087,465. FILED P.R. 1-21-2007; AM. S.R. 5-19-2008.

Direct Response Network
Marketing

THE MARK CONSISTS OF STANDARD CHARACTERS WITHOUT CLAIM TO ANY PARTICULAR FONT, STYLE, SIZE, OR COLOR.

NO CLAIM IS MADE TO THE EXCLUSIVE RIGHT TO USE "MARKETING", APART FROM THE MARK AS SHOWN.

FOR ADVERTISING AND MARKETING; ADVERTISING, MARKETING AND PROMOTION SERVICES; DIRECT MARKETING SERVICES; MULTI-LEVEL MARKETING BUSINESS SERVICES (U.S. CLS. 100, 101 AND 102).

FIRST USE 8-1-2006; IN COMMERCE 8-1-2006.

CLASS 35—(Continued).

3,568,744. PUCHALSKI, JEFFERY L., LAGUNA NIGUEL, CA. SN 77-398,674. FILED P.R. 2-15-2008; AM. S.R. 11-13-2008.

RISK LAYERING

THE MARK CONSISTS OF STANDARD CHARACTERS WITHOUT CLAIM TO ANY PARTICULAR FONT, STYLE, SIZE, OR COLOR.

FOR ACCOUNTING CONSULTATION; ACQUISITION AND MERGER CONSULTATION; BUSINESS ACQUISITION AND MERGER CONSULTATION; BUSINESS ACQUISITIONS CONSULTATION; BUSINESS ADMINISTRATION CONSULTANCY; BUSINESS ADVISORY SERVICES, CONSULTANCY AND INFORMATION; BUSINESS APPRAISAL CONSULTATION; BUSINESS CONSULTATION; BUSINESS CONSULTATION AND MANAGEMENT REGARDING MARKETING ACTIVITIES AND LAUNCHING OF NEW PRODUCTS; BUSINESS CONSULTATION IN THE FIELD OF TELECOMMUNICATIONS EXPENSE MANAGEMENT; BUSINESS CONSULTATION SERVICES; BUSINESS CONSULTING AND BUSINESS INFORMATION FOR ENTERPRISES; BUSINESS CONSULTING AND INFORMATION SERVICES; BUSINESS CONSULTING SERVICES IN THE FIELD OF ORGANIZATIONAL CHANGE MANAGEMENT; BUSINESS CONSULTING, MANAGEMENT, PLANNING AND SUPERVISION; BUSINESS MANAGEMENT AND CONSULTATION; BUSINESS MANAGEMENT CONSULTANCY AND ADVISORY SERVICES; BUSINESS MANAGEMENT CONSULTANCY AS WELL AS DEVELOPMENT OF PROCESSES FOR THE ANALYSIS AND THE IMPLEMENTATION OF STRATEGY PLANS AND MANAGEMENT PROJECTS; BUSINESS MANAGEMENT CONSULTANCY SERVICES; BUSINESS MANAGEMENT CONSULTATION; BUSINESS MANAGEMENT CONSULTATION IN THE FIELD OF EXECUTIVE AND LEADERSHIP DEVELOPMENT; BUSINESS MANAGEMENT CONSULTING; BUSINESS MANAGEMENT CONSULTING AND ADVISORY SERVICES; BUSINESS MANAGEMENT CONSULTING IN THE FIELD OF TEAM DEVELOPMENT; BUSINESS MARKETING CONSULTING SERVICES; BUSINESS MARKETING CONSULTING SERVICES TO CHILDCARE ORGANIZATIONS; BUSINESS MERGER CONSULTATION; BUSINESS ORGANIZATION AND MANAGEMENT CONSULTING SERVICES; BUSINESS ORGANIZATION CONSULTING; BUSINESS ORGANIZATION AND MANAGEMENT CONSULTING; BUSINESS ORGANIZATION AND OPERATION CONSULTANCY; BUSINESS ORGANIZATION CONSULTING; BUSINESS ORGANIZATIONAL CONSULTATION; BUSINESS RELOCATION CONSULTING; BUSINESS RESEARCH CONSULTATION; BUSINESS RISK MANAGEMENT CONSULTATION; BUSINESS VENTURE DEVELOPMENT AND FORMATION CONSULTING SERVICES FOR THE RENEWABLE ENERGY INDUSTRY; COMMERCIAL CONSULTANCY; COMPANY MANAGEMENT, INCLUDING CONSULTANCY IN DEMOGRAPHIC MATTERS; CONSULTANCY SERVICES REGARDING BUSINESS STRATEGIES; CONSULTATION IN THE FIELD OF BUSINESS ACQUISITIONS; CONSULTATION SERVICES IN THE FIELD OF COMPANY, BUSINESS SECTOR AND INDUSTRY DATA AND RESEARCH; CONSULTING SERVICES IN BUSINESS ORGANIZATION AND MANAGEMENT; CONSULTING SERVICES IN THE AREA OF SUSTAINABLE BUSINESS SOLUTIONS; CORPORATE IMAGE CONSULTING SERVICES; INDUSTRIAL MANAGEMENT CONSULTATION INCLUDING COST/YIELD ANALYSES; MARKET RESEARCH CONSULTATION;

CLASS 35—(Continued).

MARKET SEGMENTATION CONSULTATION; POLITICAL CONSULTANCY; PROFESSIONAL BUSINESS CONSULTATION; PROFESSIONAL BUSINESS CONSULTING; PROVIDING BUSINESS MANAGEMENT INFORMATION IN CONNECTION WITH CONSULTING AND ADVISORY SERVICES IN THE FIELD OF STRATEGIC PLANNING; PROVIDING ORGANIZATIONAL DEVELOPMENT CONSULTING SERVICES; TAX AND TAXATION PLANNING, ADVICE, INFORMATION AND CONSULTANCY SERVICES; TAX CONSULTATION; BUSINESS CONSULTING SERVICES, NAMELY, PROVIDING ASSISTANCE IN DEVELOPMENT BUSINESS STRATEGIES AND CREATIVE IDEATION; BUSINESS MANAGEMENT CONSULTING WITH RELATION TO STRATEGY, MARKETING, PRODUCTION, PERSONNEL AND RETAIL SALE MATTERS; CREATION OF MARKETING TOOLS DESIGNED TO INCREASE A CLIENT COMPANY'S KNOWLEDGE OF CUSTOMER NEEDS, AND ITS COMPETITORS' PRODUCTS AND SERVICES, PRICING, ADVERTISING STRATEGY AND SALES STRATEGY (U.S. CLS. 100, 101 AND 102).
FIRST USE 5-6-2008; IN COMMERCE 5-6-2008.

3,568,761. FEDERAL RESERVE BANK OF ATLANTA, ATLANTA, GA. SN 77-473,189. FILED P.R. 5-13-2008; AM. S.R. 12-9-2008.

AMERICAS CENTER

THE MARK CONSISTS OF STANDARD CHARACTERS WITHOUT CLAIM TO ANY PARTICULAR FONT, STYLE, SIZE, OR COLOR.
FOR PROMOTING INTERNATIONAL UNDERSTANDING, COOPERATION AND COORDINATION IN THE AREA OF BANKING, ECONOMICS, MONETARY POLICY AND REGIONAL PAYMENT PROCESSING (U.S. CLS. 100, 101 AND 102).
FIRST USE 6-0-2005; IN COMMERCE 6-0-2005.

3,568,769. SCHWARTZ & CO., LLC, MINNEAPOLIS, MN. SN 77-515,720. FILED P.R. 7-7-2008; AM. S.R. 12-12-2008.



OWNER OF U.S. REG. NO. 3,394,317.
NO CLAIM IS MADE TO THE EXCLUSIVE RIGHT TO USE "HEADHUNTERS", APART FROM THE MARK AS SHOWN.
THE COLOR(S) BLACK, BROWN AND WHITE IS/ARE CLAIMED AS A FEATURE OF THE MARK.
THE MARK CONSISTS OF A BROWN RECTANGULAR OVAL OUTLINED IN BLACK WITH THE WORDS "COPIER HEADHUNTERS" IN WHITE IN THE CENTER OF THE OVAL.
FOR EMPLOYMENT HIRING, RECRUITING, PLACEMENT, STAFFING AND CAREER NETWORKING SERVICES (U.S. CLS. 100, 101 AND 102).
FIRST USE 5-28-2008; IN COMMERCE 5-28-2008.

CLASS 35—(Continued).

3,568,770. SCHWARTZ & CO., LLC, MINNEAPOLIS, MN. SN 77-515,735. FILED P.R. 7-7-2008; AM. S.R. 12-12-2008.



OWNER OF U.S. REG. NO. 3,394,317.
NO CLAIM IS MADE TO THE EXCLUSIVE RIGHT TO USE "RECRUITERS", APART FROM THE MARK AS SHOWN.
THE COLOR(S) BLACK, BROWN AND WHITE IS/ARE CLAIMED AS A FEATURE OF THE MARK.
THE MARK CONSISTS OF A BROWN RECTANGULAR OVAL OUTLINED IN BLACK WITH THE WORDS "COPIER RECRUITERS" IN WHITE IN THE CENTER OF THE OVAL.
FOR EMPLOYMENT HIRING, RECRUITING, PLACEMENT, STAFFING AND CAREER NETWORKING SERVICES (U.S. CLS. 100, 101 AND 102).
FIRST USE 5-28-2008; IN COMMERCE 5-28-2008.

3,568,785. HEAR YOUR HOROSCOPE, LLC, LAGUNA BEACH, CA. SN 77-565,580. FILED 9-9-2008.

HEAR YOUR HOROSCOPE

THE MARK CONSISTS OF STANDARD CHARACTERS WITHOUT CLAIM TO ANY PARTICULAR FONT, STYLE, SIZE, OR COLOR.
FOR ON-LINE RETAIL STORE SERVICES FEATURING CUSTOM RECORDED DOWNLOADABLE DIGITAL AUDIO FILES OF PERSONAL HOROSCOPES (U.S. CLS. 100, 101 AND 102).
FIRST USE 7-18-2008; IN COMMERCE 7-18-2008.

3,568,790. URGENT CARE ASSOCIATION OF AMERICA, WARRENVILLE, IL. SN 77-567,590. FILED 9-11-2008.

URGENT CARE ASSOCIATION OF AMERICA

THE MARK CONSISTS OF STANDARD CHARACTERS WITHOUT CLAIM TO ANY PARTICULAR FONT, STYLE, SIZE, OR COLOR.
NO CLAIM IS MADE TO THE EXCLUSIVE RIGHT TO USE "URGENT CARE ASSOCIATION", APART FROM THE MARK AS SHOWN.
FOR ASSOCIATION SERVICES, NAMELY, PROMOTING THE INTEREST OF THE URGENT CARE INDUSTRY (U.S. CLS. 100, 101 AND 102).
FIRST USE 11-12-2004; IN COMMERCE 11-12-2004.

CLASS 35—(Continued).

3,568,791. CITY OF ANGELS - MELROSE, LLC, LOS ANGELES, CA. SN 77-976,209. FILED P.R. 9-17-2007; AM. S.R. 6-18-2008.

City of Angels Eyewear Company

THE MARK CONSISTS OF STANDARD CHARACTERS WITHOUT CLAIM TO ANY PARTICULAR FONT, STYLE, SIZE, OR COLOR.

NO CLAIM IS MADE TO THE EXCLUSIVE RIGHT TO USE "EYEWEAR COMPANY ", APART FROM THE MARK AS SHOWN.

FOR RETAIL STORE SERVICES, MAIL ORDER CATALOGS SERVICES, TELEPHONE SHOP AT HOME SERVICES AND ONLINE RETAIL STORE SERVICES FEATURING PRESCRIPTION AND NON-PRESCRIPTION EYEGLASSES AND SUNGLASSES, EYEWEAR ACCESSORIES INCLUDING FRAMES, LENSES, LENS CLEANERS, CASES, CORDS, AND STRAPS, CLOTHING, CLOTHING ACCESSORIES, LEATHER GOODS, BAGS, WATCHES, AND JEWELRY (U.S. CLS. 100, 101 AND 102).

FIRST USE 7-15-2007; IN COMMERCE 7-15-2007.

3,568,792. I D SERVICES, INC., COLUMBUS, GA. SN 78-671,606. FILED P.R. 7-15-2005; AM. S.R. 4-16-2008.

I D SERVICES, INC.

THE MARK CONSISTS OF STANDARD CHARACTERS WITHOUT CLAIM TO ANY PARTICULAR FONT, STYLE, SIZE, OR COLOR.

NO CLAIM IS MADE TO THE EXCLUSIVE RIGHT TO USE "SERVICES, INC.", APART FROM THE MARK AS SHOWN.

FOR MAIL ORDER, MAIL ORDER CATALOG, RETAIL STORE SERVICES AND WHOLESALE STORES, FEATURING SECURITY SUPPLIES, EQUIPMENT AND SYSTEMS, NAMELY, SECURITY BADGES AND CARDS, LAMINATES, LAMINATORS, BADGE DESIGN SOFTWARE, PROXIMITY AND ACCESS CONTROL CARDS, CARD HOLDERS AND ACCESSORIES, NAMELY, LANYARDS, BADGE REELS, BADGE HOLDERS, BADGE CLIPS, SLOT PUNCHES, PVC CARDS AND OVERLAYS, TRIPODS AND BACKDROPS (U.S. CLS. 100, 101 AND 102).

FIRST USE 6-12-1990; IN COMMERCE 6-12-1990.

CLASS 36—INSURANCE AND FINANCIAL**CLASS 36—(Continued).**

3,568,709. OPTIONSXPRESS HOLDINGS, INC., CHICAGO, IL. SN 76-680,607. FILED P.R. 8-10-2007; AM. S.R. 5-2-2008.

TRADEWIZARD

THE MARK CONSISTS OF STANDARD CHARACTERS WITHOUT CLAIM TO ANY PARTICULAR FONT, STYLE, SIZE, OR COLOR.

FOR SECURITIES TRADING AND INVESTING SERVICES FOR OTHERS VIA THE INTERNET (U.S. CLS. 100, 101 AND 102).

FIRST USE 2-14-2008; IN COMMERCE 2-14-2008.

3,568,725. METROPOLITAN LIFE INSURANCE COMPANY, LONG ISLAND CITY, NY. SN 77-274,673. FILED 9-7-2007.

providing insurance solutions

THE MARK CONSISTS OF STANDARD CHARACTERS WITHOUT CLAIM TO ANY PARTICULAR FONT, STYLE, SIZE, OR COLOR.

FOR UNDERWRITING AND ADMINISTRATION OF AUTO, HOME, APARTMENT, CONDOMINIUM, BOAT, VACATION AND RENTAL PROPERTY, RECREATIONAL VEHICLE, PERSONAL EXCESS LIABILITY, LANDLORD TENANT, MOBILE HOME, MOTORCYCLE AND DWELLING FIRE INSURANCE COVERAGE (U.S. CLS. 100, 101 AND 102).

FIRST USE 1-0-2002; IN COMMERCE 1-0-2002.

3,568,734. PINNACLES UNLIMITED LLC, STURGEON BAY, WI. SN 77-319,745. FILED P.R. 11-2-2007; AM. S.R. 12-19-2008.

SHOPCORPORATEHOUSING.COM

THE MARK CONSISTS OF STANDARD CHARACTERS WITHOUT CLAIM TO ANY PARTICULAR FONT, STYLE, SIZE, OR COLOR.

FOR PROVIDING REAL ESTATE LISTINGS AND REAL ESTATE INFORMATION VIA THE INTERNET; REAL ESTATE SERVICES, NAMELY, RENTAL OF SHORT-TERM FURNISHED APARTMENTS; RENTAL OF APARTMENTS; RENTAL OF HOMES (U.S. CLS. 100, 101 AND 102).

FIRST USE 10-25-2008; IN COMMERCE 10-25-2008.

CLASS 36—(Continued).

3,568,738. GALYA, SCOTT, MIAMI, FL. SN 77-356,710. FILED P.R. 12-20-2007; AM. S.R. 5-21-2008.

BRICKELL PROPERTY MANAGEMENT

THE MARK CONSISTS OF STANDARD CHARACTERS WITHOUT CLAIM TO ANY PARTICULAR FONT, STYLE, SIZE, OR COLOR.

NO CLAIM IS MADE TO THE EXCLUSIVE RIGHT TO USE "PROPERTY MANAGEMENT", APART FROM THE MARK AS SHOWN.

FOR LEASING OF COMMERCIAL AND RESIDENTIAL REAL ESTATE; REAL ESTATE MANAGEMENT (U.S. CLS. 100, 101 AND 102).

FIRST USE 10-20-2006; IN COMMERCE 10-20-2006.

3,568,765. MIRACLE RECREATION EQUIPMENT COMPANY, MONETT, MO. SN 77-479,929. FILED P.R. 5-21-2008; AM. S.R. 12-16-2008.

GRANTS FOR AMERICA'S SCHOOLS

THE MARK CONSISTS OF STANDARD CHARACTERS WITHOUT CLAIM TO ANY PARTICULAR FONT, STYLE, SIZE, OR COLOR.

OWNER OF U.S. REG. NOS. 841,174, 2,043,224, AND 2,988,973.

NO CLAIM IS MADE TO THE EXCLUSIVE RIGHT TO USE "GRANTS", APART FROM THE MARK AS SHOWN.

FOR PROVIDING GRANTS FOR THE PURCHASE OF PLAYGROUND EQUIPMENT (U.S. CLS. 100, 101 AND 102).

FIRST USE 5-0-2008; IN COMMERCE 5-0-2008.

CLASS 38—COMMUNICATION

3,568,782. CHRISTIAN BROADCASTING SYSTEM, LTD., FLINT, MI. SN 77-562,724. FILED P.R. 9-4-2008; AM. S.R. 12-11-2008.

Christian Broadcasting System

THE MARK CONSISTS OF STANDARD CHARACTERS WITHOUT CLAIM TO ANY PARTICULAR FONT, STYLE, SIZE, OR COLOR.

CLASS 38—(Continued).

NO CLAIM IS MADE TO THE EXCLUSIVE RIGHT TO USE "BROADCASTING SYSTEM", APART FROM THE MARK AS SHOWN.

FOR INTERNET BROADCASTING SERVICES; RADIO BROADCASTING (U.S. CLS. 100, 101 AND 104).
FIRST USE 12-1-2003; IN COMMERCE 12-1-2003.

CLASS 41—EDUCATION AND ENTERTAINMENT

3,568,716. OWOC, EILEEN, COOPER CITY, FL. SN 77-089,951. FILED P.R. 1-24-2007; AM. S.R. 11-7-2008.

MINDBODY CONNECTION

THE MARK CONSISTS OF STANDARD CHARACTERS WITHOUT CLAIM TO ANY PARTICULAR FONT, STYLE, SIZE, OR COLOR.

FOR PROVIDING FITNESS AND EXERCISE FACILITIES; PROVIDING PHYSICAL FITNESS INSTRUCTION AND CONSULTATION; PILATES INSTRUCTION, MEDITATION INSTRUCTION, YOGA INSTRUCTION, DANCE INSTRUCTION, AEROBICS INSTRUCTION; REIKI ENERGY HEALING INSTRUCTION; ARRANGING AND CONDUCTING CLASSES TEACHING SELF-HELP AND SELF-TRAINING IN THE FIELD OF LIFE QUALITY IMPROVEMENT; ALL THE AFOREMENTIONED SERVICES PROVIDED TO ADULTS, TEENS, AND CHILDREN (U.S. CLS. 100, 101 AND 107).

FIRST USE 2-0-2005; IN COMMERCE 2-0-2005.

3,568,749. LECTONARY HOMILETICS, INC., MIDLOTHIAN, VA. SN 77-406,811. FILED P.R. 2-26-2008; AM. S.R. 12-10-2008.

Festival of Homiletics

THE MARK CONSISTS OF STANDARD CHARACTERS WITHOUT CLAIM TO ANY PARTICULAR FONT, STYLE, SIZE, OR COLOR.

NO CLAIM IS MADE TO THE EXCLUSIVE RIGHT TO USE "FESTIVAL", APART FROM THE MARK AS SHOWN.

FOR ARRANGING AND CONDUCTING EDUCATIONAL CONFERENCES (U.S. CLS. 100, 101 AND 107).
FIRST USE 1-1-1993; IN COMMERCE 1-1-1993.

CLASS 41—(Continued).

3,568,759. LEAN ACCOUNTING NEWSLETTER LLC, CLEVELAND, OH. SN 77-467,921. FILED P.R. 5-7-2008; AM. S.R. 11-4-2008.

Lean Accounting News

THE MARK CONSISTS OF STANDARD CHARACTERS WITHOUT CLAIM TO ANY PARTICULAR FONT, STYLE, SIZE, OR COLOR.

NO CLAIM IS MADE TO THE EXCLUSIVE RIGHT TO USE "NEWS", APART FROM THE MARK AS SHOWN.

FOR PROVIDING NEWSLETTERS IN THE FIELD OF ACCOUNTING VIA E-MAIL; PROVIDING ON-LINE NEWSLETTERS IN THE FIELD OF ACCOUNTING (U.S. CLS. 100, 101 AND 107).

FIRST USE 8-1-2006; IN COMMERCE 8-1-2006.

3,568,776. ZOEZA GROUP, LLC, PHILADELPHIA, PA. SN 77-542,977. FILED P.R. 8-8-2008; AM. S.R. 12-11-2008.

Surrogate Mentoring and Responsible Transition

THE MARK CONSISTS OF STANDARD CHARACTERS WITHOUT CLAIM TO ANY PARTICULAR FONT, STYLE, SIZE, OR COLOR.

FOR MENTORING SERVICES, NAMELY, PROVIDING INTENSIVE, LONG-TERM, HIGH-TOUCH, PARENT-LIKE, COMPREHENSIVE MENTORING TO TARGETED SUBJECTS TO FACILITATE THE TRANSITION OF AT-RISK YOUTH INTO PRODUCTIVE CAREERS AND INDEPENDENT LIVING; EDUCATIONAL RESEARCH, NAMELY, DEVELOPING A TRAINING MODEL TO EFFECTUATE THE TRANSITION OF AT-RISK YOUTH INTO PRODUCTIVE CAREERS AND INDEPENDENT LIVING (U.S. CLS. 100, 101 AND 107).

FIRST USE 1-1-2005; IN COMMERCE 1-1-2005.

3,568,778. BUTLER, EVELYN G., PLYMOUTH, MI. SN 77-551,778. FILED P.R. 8-20-2008; AM. S.R. 12-12-2008.

The Legal Series

THE MARK CONSISTS OF STANDARD CHARACTERS WITHOUT CLAIM TO ANY PARTICULAR FONT, STYLE, SIZE, OR COLOR.

CLASS 41—(Continued).

NO CLAIM IS MADE TO THE EXCLUSIVE RIGHT TO USE LEGAL, APART FROM THE MARK AS SHOWN.

FOR EDUCATIONAL SERVICES, NAMELY, CONDUCTING SEMINARS IN THE FIELD OF LAW AND DISTRIBUTION OF COURSE MATERIAL IN CONNECTION THEREWITH (U.S. CLS. 100, 101 AND 107).

FIRST USE 6-17-2008; IN COMMERCE 7-15-2008.

3,568,789. OC TUTOR, SANTA ANA, CA. SN 77-567,173. FILED P.R. 9-10-2008; AM. S.R. 10-10-2008.

THE OC TUTOR PROOFREADER

THE MARK CONSISTS OF STANDARD CHARACTERS WITHOUT CLAIM TO ANY PARTICULAR FONT, STYLE, SIZE, OR COLOR.

NO CLAIM IS MADE TO THE EXCLUSIVE RIGHT TO USE "TUTOR" AND "PROOFREADER", APART FROM THE MARK AS SHOWN.

FOR TUTORING SERVICES FOR ELEMENTARY SCHOOL THROUGH UNIVERSITY STUDENTS, NAMELY, PROVIDING TUTORING IN THE FIELDS OF MATH, ENGLISH, SPANISH, JAPANESE, ITALIAN, PORTUGUESE, GERMAN, STATISTICS, SCIENCE AND HISTORY FOR ELEMENTARY, MIDDLE, HIGH-SCHOOL AND COLLEGE STUDENTS; PROOFREADING SERVICES FOR ELEMENTARY SCHOOL THROUGH UNIVERSITY STUDENTS, NAMELY, PROVIDING WRITTEN TEXT EDITING SERVICES CONCERNING PROPER GRAMMAR USAGE FOR ELEMENTARY, MIDDLE, HIGH-SCHOOL AND COLLEGE STUDENTS (U.S. CLS. 100, 101 AND 107).

FIRST USE 10-1-2008; IN COMMERCE 10-1-2008.

CLASS 42—SCIENTIFIC AND COMPUTER SERVICES

3,568,713. URBAN MAPPING, INC., SAN FRANCISCO, CA. SN 77-004,873. FILED P.R. 9-21-2006; AM. S.R. 11-25-2008.

URBAN MAPPING

THE MARK CONSISTS OF STANDARD CHARACTERS WITHOUT CLAIM TO ANY PARTICULAR FONT, STYLE, SIZE, OR COLOR.

NO CLAIM IS MADE TO THE EXCLUSIVE RIGHT TO USE "MAPPING", APART FROM THE MARK AS SHOWN.

FOR PROVIDING DATABASES FEATURING MAPS, SCIENTIFIC MAP DATA AND GEOSPATIAL INFORMATION (U.S. CLS. 100 AND 101).

FIRST USE 0-0-2001; IN COMMERCE 3-26-2002.

CLASS 42—(Continued).

3,568,714. SUBSURFACE IMAGING CORPORATION, ROCHESTER, NY. SN 77-007,690. FILED P.R. 9-26-2006; AM. S.R. 10-28-2008.

SUBSURFACE IMAGING

THE MARK CONSISTS OF STANDARD CHARACTERS WITHOUT CLAIM TO ANY PARTICULAR FONT, STYLE, SIZE, OR COLOR.

FOR CONSULTING SERVICES IN THE FIELD OF POWER QUALITY ANALYSIS; POWER QUALITY ANALYSIS SERVICES, NAMELY, INFRARED SCANNING OF ELECTRICAL AND MECHANICAL EQUIPMENT, INFRARED SCANNING OF BUILDINGS FOR HEAT LOSS, INFRARED SCANNING OF BUILDINGS FOR QUALITY CONTROL, INFRARED SCANNING OF FLAT ROOF SYSTEMS FOR MOISTURE DAMAGED SUBSTRATE, INFRARED SCANNING OF RESIDENTIAL HOMES FOR HEAT LOSS AND INSULATION VALUES, POWER QUALITY ANALYSIS OF ELECTRICAL AND MECHANICAL SYSTEMS, UNDERGROUND FAULT LOCATION AND TRACKING USING RF SCANNING, UNDERGROUND UTILITY AND ASSET MANAGEMENT AND GIS/GPS MAPPING, AERIAL INFRARED SCANNING, AND AERIAL SCANNING FOR ARCHITECTS AND ENGINEERS, UTILITY POWER ANALYSIS, ANALYSIS OF ELECTRICAL CIRCUITS FOR DEGRADATION, ANALYSIS OF BOAT HULLS FOR DAMAGE (U.S. CLS. 100 AND 101).

FIRST USE 3-0-2006; IN COMMERCE 3-0-2006.

3,568,739. LANDAUER, INC., GLENWOOD, IL. SN 77-385,394. FILED P.R. 1-31-2008; AM. S.R. 11-24-2008.

LIFETIME DOCUMENTATION OF RADIATION

THE MARK CONSISTS OF STANDARD CHARACTERS WITHOUT CLAIM TO ANY PARTICULAR FONT, STYLE, SIZE, OR COLOR.

FOR MEASUREMENT EVALUATIONS IN THE PERSONNEL RADIATION DOSIMETRY FIELD (U.S. CLS. 100 AND 101).

FIRST USE 2-29-2008; IN COMMERCE 2-29-2008.

CLASS 42—(Continued).

3,568,757. SYMBIOTIC ENGINEERING, LLC, BOULDER, CO. SN 77-461,341. FILED P.R. 4-29-2008; AM. S.R. 12-11-2008.

Carbon City

THE MARK CONSISTS OF STANDARD CHARACTERS WITHOUT CLAIM TO ANY PARTICULAR FONT, STYLE, SIZE, OR COLOR.

FOR PROVIDING ONLINE NON-DOWNLOADABLE COMPUTER SOFTWARE FOR THE CALCULATION AND REPORTING OF CARBON AND GREENHOUSE GAS EMISSIONS RESULTING FROM MUNICIPAL, INSTITUTIONAL, AND BUSINESS OPERATIONS (U.S. CLS. 100 AND 101).

FIRST USE 3-17-2008; IN COMMERCE 4-14-2008.

3,568,760. SYMBIOTIC ENGINEERING, LLC, BOULDER, CO. SN 77-468,705. FILED P.R. 5-7-2008; AM. S.R. 12-11-2008.

Carbon Campus

THE MARK CONSISTS OF STANDARD CHARACTERS WITHOUT CLAIM TO ANY PARTICULAR FONT, STYLE, SIZE, OR COLOR.

FOR PROVIDING ONLINE NON-DOWNLOADABLE COMPUTER SOFTWARE FOR THE CALCULATION AND REPORTING OF CARBON AND GREENHOUSE GAS EMISSIONS RESULTING FROM MUNICIPAL, INSTITUTIONAL, AND BUSINESS OPERATIONS (U.S. CLS. 100 AND 101).

FIRST USE 3-26-2008; IN COMMERCE 4-2-2008.

3,568,763. ZAVALA, AIMEE, DANVILLE, CA. SN 77-475,824. FILED P.R. 5-15-2008; AM. S.R. 12-10-2008.

GELINE GROUP

THE MARK CONSISTS OF STANDARD CHARACTERS WITHOUT CLAIM TO ANY PARTICULAR FONT, STYLE, SIZE, OR COLOR.

NO CLAIM IS MADE TO THE EXCLUSIVE RIGHT TO USE "GROUP", APART FROM THE MARK AS SHOWN.

FOR GRAPHIC DESIGN SERVICES (U.S. CLS. 100 AND 101).

FIRST USE 11-28-2008; IN COMMERCE 11-28-2008.

CLASS 42—(Continued).

3,568,783. DIVENAV, INC., TUSTIN, CA. SN 77-563,580. FILED P.R. 9-5-2008; AM. S.R. 12-12-2008.

EDIVING

THE MARK CONSISTS OF STANDARD CHARACTERS WITHOUT CLAIM TO ANY PARTICULAR FONT, STYLE, SIZE, OR COLOR.

FOR PROVIDING TEMPORARY USE OF NON-DOWNLOADABLE COMPUTER SOFTWARE FOR DIVING SIMULATOR OVER GLOBAL COMPUTER NETWORKS (U.S. CLS. 100 AND 101).

FIRST USE 11-6-2007; IN COMMERCE 11-6-2007.

CLASS 44—MEDICAL, BEAUTY AND AGRICULTURAL SERVICES

3,568,712. KIERNAN, JAMES E., ROCKAWAY PARK, NY. SN 76-687,461. FILED P.R. 3-7-2008; AM. S.R. 6-30-2008.

STRESS RELIEF METHOD

THE MARK CONSISTS OF STANDARD CHARACTERS WITHOUT CLAIM TO ANY PARTICULAR FONT, STYLE, SIZE, OR COLOR.

FOR MEDICAL ANALYSIS AND SERVICES FOR HUMAN OR ANIMAL RELATED TO THE TREATMENT OF STRESS INDUCED PAIN AND AFFLICTIONS IN DIFFERENT PARTS OF THE BODY (U.S. CLS. 100 AND 101).

FIRST USE 9-12-2006; IN COMMERCE 9-12-2006.

3,568,748. COAST TO COAST WOUND CARE SURGEONS, INC., SUNNY ISLES BEACH, FL. SN 77-402,961. FILED P.R. 2-21-2008; AM. S.R. 11-28-2008.

EAST COAST WOUND CARE

THE MARK CONSISTS OF STANDARD CHARACTERS WITHOUT CLAIM TO ANY PARTICULAR FONT, STYLE, SIZE, OR COLOR.

NO CLAIM IS MADE TO THE EXCLUSIVE RIGHT TO USE "WOUND CARE", APART FROM THE MARK AS SHOWN.

FOR MEDICAL SERVICES, NAMELY, PROVIDING SURGICAL MANAGEMENT OF WOUNDS FOR LONG-TERM-CARE FACILITIES (U.S. CLS. 100 AND 101).

FIRST USE 1-31-2004; IN COMMERCE 1-31-2004.

CLASS 45—PERSONAL AND LEGAL SERVICES**CLASS 45—(Continued).**

3,568,732. DOLAN MEDIA COMPANY, MINNEAPOLIS, MN. SN 77-306,534. FILED P.R. 10-17-2007; AM. S.R. 12-17-2008.

THE APPELLATE EXPERTS

THE MARK CONSISTS OF STANDARD CHARACTERS WITHOUT CLAIM TO ANY PARTICULAR FONT, STYLE, SIZE, OR COLOR.

FOR CONSULTING SERVICES FOR LEGAL DOCUMENT PREPARATION AND CONFORMING DOCUMENTS TO THE RULES OF COURTS AND ADMINISTRATIVE AGENCIES (U.S. CLS. 100 AND 101).

FIRST USE 12-31-2004; IN COMMERCE 12-31-2004.

3,568,764. SIGTRAN CONSULTING, DBA SPARKBLISS, BELLEVUE, WA. SN 77-477,426. FILED P.R. 5-18-2008; AM. S.R. 9-9-2008.

Private Online Dating

THE MARK CONSISTS OF STANDARD CHARACTERS WITHOUT CLAIM TO ANY PARTICULAR FONT, STYLE, SIZE, OR COLOR.

NO CLAIM IS MADE TO THE EXCLUSIVE RIGHT TO USE "DATING", APART FROM THE MARK AS SHOWN.

FOR INTERNET-BASED DATING, SOCIAL INTRODUCTION AND SOCIAL NETWORKING SERVICES (U.S. CLS. 100 AND 101).

FIRST USE 3-9-2008; IN COMMERCE 3-9-2008.

3,568,772. TRIGEMINAL NEURALGIA ASSOCIATION, INC., GAINESVILLE, FL. SN 77-529,756. FILED P.R. 7-23-2008; AM. S.R. 12-10-2008.

THE FACIAL PAIN ASSOCIATION

THE MARK CONSISTS OF STANDARD CHARACTERS WITHOUT CLAIM TO ANY PARTICULAR FONT, STYLE, SIZE, OR COLOR.

CLASS 45—(Continued).

CLASS 45—(Continued).

3,568,786. HEAR YOUR HOROSCOPE, LLC, LAGUNA BEACH, CA. SN 77-565,646. FILED 9-9-2008.

HEAR YOUR HOROSCOPE

NO CLAIM IS MADE TO THE EXCLUSIVE RIGHT TO USE "ASSOCIATION", APART FROM THE MARK AS SHOWN.

FOR CHARITABLE SERVICES, NAMELY, PROVIDING PERSONAL SUPPORT SERVICES IN THE NATURE OF SERVING AS AN ADVOCATE FOR PATIENTS LIVING WITH TRIGEMINAL NEURALGIA AND RELATED FACIAL PAIN CONDITIONS BY PROVIDING INFORMATION, ENCOURAGING RESEARCH AND OFFERING PERSONAL AND EMOTIONAL SUPPORT (U.S. CLS. 100 AND 101).

FIRST USE 11-5-2008; IN COMMERCE 11-5-2008.

THE MARK CONSISTS OF STANDARD CHARACTERS WITHOUT CLAIM TO ANY PARTICULAR FONT, STYLE, SIZE, OR COLOR.

NO CLAIM IS MADE TO THE EXCLUSIVE RIGHT TO USE "HOROSCOPE", APART FROM THE MARK AS SHOWN.

FOR HOROSCOPES; PROVIDING HOROSCOPE INFORMATION VIA COMPUTER NETWORKS (U.S. CLS. 100 AND 101).

FIRST USE 7-18-2008; IN COMMERCE 7-18-2008.

* * * * *

TRADEMARK REGISTRATIONS RENEWED

The designation "U.S. Cl." appearing in this section refers to the U.S. class in effect prior to Sep. 1, 1973 rather than the international class which applies to applications filed on or after that date. For adoption of international classification see notice in the OFFICIAL GAZETTE of Jun. 26, 1973 (911 O.G. TM 210).

69,224.	ROYAL (STYLIZED). U.S. CL. 46. (INT. CL. 30). REG. 5-26-1908.	861,528.	TRIBUTE. U.S. CL. 2. (INT. CL. 20). REG. 12-10-1968.
123,029.	SUPREME (STYLIZED). U.S. CL. 22. (INT. CL. 28). REG. 10-8-1918.	861,529.	REGAL. U.S. CL. 2. (INT. CL. 20). REG. 12-10-1968.
362,428.	NOFMA (STYLIZED). U.S. CL. 12. (INT. CL. 19). REG. 11-15-1938.	862,440.	CTBS. U.S. CL. 38. (INT. CL. 16). REG. 12-24-1968.
364,386.	BUG-GETA. U.S. CL. 6. (INT. CL. 5). REG. 1-31-1939.	863,734.	ISOLENE. U.S. CL. 1. (INT. CL. 17). REG. 1-21-1969.
442,636.	COLUMBIAN. U.S. CL. 2. (INT. CL. 16). REG. 5-3-1949.	864,323.	DOFINO. U.S. CL. 46. (INT. CLS. 1, 5, 29, 30, 31 AND 32). REG. 1-28-1969.
504,357.	DEPEND-A-BOND (STYLIZED). U.S. CL. 14. (INT. CL. 6). REG. 11-30-1948.	865,472.	QUELQUES FLEURS. U.S. CL. 51. (INT. CLS. 3 AND 5). REG. 2-25-1969.
504,751.	LONGHORN AND DESIGN. U.S. CL. 46. (INT. CL. 31). REG. 12-14-1948.	870,081.	GOLDEN RING. U.S. CL. 26. (INT. CL. 9). REG. 5-27-1969.
504,855.	CNW. U.S. CL. 105. (INT. CL. 39). REG. 12-14-1948.	872,480.	SONAGUARD (STYLIZED). U.S. CL. 21. (INT. CL. 9). REG. 7-8-1969.
506,303.	HARDING. U.S. CL. 42. (INT. CL. 24). REG. 2-1-1949.	877,162.	HOUBIGANT. U.S. CL. 51. (INT. CLS. 3 AND 5). REG. 9-16-1969.
508,189.	MACHINE DESIGN (STYLIZED). U.S. CL. 38. (INT. CL. 16). REG. 4-5-1949.	879,171.	LACOSTE. U.S. CL. 39. (INT. CL. 25). REG. 10-21-1969.
517,141.	MALTA (STYLIZED). U.S. CL. 46. (INT. CL. 31). REG. 11-1-1949.	880,269.	PANTHER CREEK. INT. CL. 1. (U.S. CL. 1). REG. 11-11-1969.
660,216.	MAKON. U.S. CL. 52. (INT. CL. 3). REG. 4-1-1958.	881,262.	TROLATEMP AND DESIGN. U.S. CL. 34. (INT. CL. 9). REG. 11-25-1969.
662,091.	PRO-FAX (STYLIZED). U.S. CL. 6. (INT. CL. 1). REG. 5-27-1958.	1,076,090.	GERBER (STYLIZED). INT. CL. 30. (U.S. CL. 46). REG. 10-25-1977.
663,264.	MISCELLANEOUS DESIGN. U.S. CL. 200. REG. 6-17-1958.	1,091,503.	DENVER DAN'S. INT. CL. 29. (U.S. CL. 46). REG. 5-16-1978.
668,477.	CALDWELL'S. U.S. CL. 49. (INT. CL. 33). REG. 10-14-1958.	1,096,932.	CIFUENTES. INT. CL. 34. (U.S. CL. 17). REG. 7-18-1978.
669,232.	GUILBERT. U.S. CL. 23. (INT. CL. 7). REG. 11-4-1958.	1,098,210.	STAR TREK. INT. CL. 25. (U.S. CLS. 22 AND 39). REG. 8-1-1978.
670,330.	KRAFT. U.S. CL. 46. (INT. CLS. 29, 30, 31 AND 32). REG. 11-25-1958.	1,099,267.	S AND DESIGN. INT. CLS. 9 AND 14 ONLY. (U.S. CLS. 2, 21, 23, 26, 27, 28, 36, 38 AND 50). REG. 8-15-1978.
670,566.	BOBCAT. U.S. CL. 23. (INT. CL. 7). REG. 12-2-1958.	1,103,652.	KOWA. INT. CL. 42. (U.S. CL. 100). REG. 10-3-1978.
670,993.	SKINNER AND DESIGN. U.S. CL. 46. (INT. CL. 30). REG. 12-9-1958.	1,103,805.	CHAMP-LOK. INT. CL. 9. (U.S. CL. 21). REG. 10-10-1978.
671,079.	ARMBURST AND DESIGN. U.S. CL. 13. (INT. CL. 6). REG. 12-16-1958.	1,103,810.	PRESSURE SYRINGE. INT. CL. 10. (U.S. CL. 44). REG. 10-10-1978.
671,422.	DULCOLAX. U.S. CL. 18. (INT. CL. 5). REG. 12-23-1958.	1,104,227.	FLEXI-BLOCK. INT. CL. 9. (U.S. CL. 21). REG. 10-17-1978.
672,023.	PENNSIZE. U.S. CL. 6. (INT. CL. 3). REG. 1-6-1959.	1,104,315.	PACEMAKER. INT. CL. 16. (U.S. CL. 38). REG. 10-17-1978.
673,154.	TOM THUMB (STYLIZED). U.S. CL. 23. (INT. CLS. 6, 7, 8, 9, 11, 12, 16, 21 AND 28). REG. 1-27-1959.	1,104,815.	SHEER MADNESS (STYLIZED). INT. CL. 25. (U.S. CL. 39). REG. 10-24-1978.
673,389.	THERMOWELD. U.S. CL. 14. (INT. CL. 6). REG. 2-3-1959.	1,105,291.	OC OFFICE COURT AND DESIGN. INT. CL. 36 ONLY. (U.S. CL. 100). REG. 10-31-1978.
677,140.	ECCOSPHERES. U.S. CL. 1. (INT. CL. 21). REG. 4-21-1959.	1,105,573.	PERFECTION. INT. CL. 11. (U.S. CL. 31). REG. 11-7-1978.
682,715.	AMCEL. U.S. CL. 1. (INT. CLS. 1 AND 17). REG. 8-4-1959.	1,105,776.	OFFICE COURT. INT. CL. 36 ONLY. (U.S. CL. 102). REG. 11-7-1978.
687,729.	SUPER GEL. INT. CL. 1. (U.S. CL. 1). REG. 11-10-1959.	1,105,842.	PERC. INT. CL. 1. (U.S. CL. 6). REG. 11-14-1978.
848,652.	HYDRO FLAME. U.S. CL. 34. (INT. CL. 11). REG. 5-7-1968.	1,106,410.	DANTOSPERSE. INT. CL. 1. (U.S. CL. 6). REG. 11-21-1978.
848,655.	QUIET-FLOW. U.S. CL. 34. (INT. CL. 11). REG. 5-7-1968.	1,106,411.	GLYCOWAX. INT. CL. 1. (U.S. CL. 6). REG. 11-21-1978.
850,915.	AITKEN (STYLIZED). U.S. CL. 21. (INT. CLS. 9 AND 11). REG. 6-18-1968.	1,106,412.	POLYALDO. INT. CL. 1. (U.S. CL. 6). REG. 11-21-1978.
853,369.	YVES SAINT LAURENT. U.S. CL. 51. (INT. CL. 3). REG. 7-23-1968.	1,107,119.	TOMORAD. INT. CL. 9. (U.S. CL. 26). REG. 11-28-1978.
856,234.	EXTERMITAL. U.S. CL. 103. (INT. CL. 37). REG. 9-3-1968.	1,107,248.	MISCELLANEOUS DESIGN. INT. CL. 42 ONLY. (U.S. CL. 100). REG. 11-28-1978.
856,829.	SUNNYSIDE. U.S. CLS. 6 AND 15. (INT. CLS. 1, 2, 3, 4 AND 5). REG. 9-17-1968.	1,107,688.	SUSTAIN. INT. CL. 3. (U.S. CL. 52). REG. 12-5-1978.
858,325.	OSTER. U.S. CL. 44. (INT. CLS. 7 AND 10). REG. 10-8-1968.	1,107,697.	PERT. INT. CL. 3. (U.S. CL. 52). REG. 12-5-1978.
859,007.	SPOON N' SERVE. U.S. CL. 46. (INT. CL. 29). REG. 10-22-1968.	1,107,717.	PANACUR. INT. CL. 5. (U.S. CL. 18). REG. 12-5-1978.
861,188.	NATIONAL SKI PATROL. U.S. CL. 200. REG. 11-26-1968.	1,107,778.	AQUA-VAC. INT. CL. 7. (U.S. CL. 23). REG. 12-5-1978.

- 1,107,860. HANG TEN. INT. CLS. 9, 14, 16, 18, 24 AND 25 ONLY. (U.S. CLS. 2, 3, 5, 22, 23, 26, 28, 29, 37, 38, 39, 42 AND 50). REG. 12-5-1978.
- 1,108,326. PANCOGENE. INT. CL. 1. (U.S. CL. 6). REG. 12-12-1978.
- 1,108,346. LK LAMBERT KAY (STYLIZED). INT. CL. 5 ONLY. (U.S. CLS. 6, 18, 44, 46, 51 AND 52). REG. 12-12-1978.
- 1,108,406. DIGITORK. INT. CL. 7. (U.S. CL. 23). REG. 12-12-1978.
- 1,108,706. CHINA SEAS. INT. CLS. 21 AND 27. (U.S. CLS. 13 AND 37). REG. 12-12-1978.
- 1,108,864. JERKY TREATS. INT. CL. 31. (U.S. CL. 46). REG. 12-12-1978.
- 1,109,241. PANAVID. INT. CL. 9. (U.S. CL. 26). REG. 12-19-1978.
- 1,109,271. HEET SHEET. INT. CL. 11. (U.S. CL. 34). REG. 12-19-1978.
- 1,109,290. QUIETURN. INT. CL. 11. (U.S. CL. 34). REG. 12-19-1978.
- 1,109,593. KRUSES PERFECTION. INT. CL. 31. (U.S. CL. 46). REG. 12-19-1978.
- 1,109,623. FRESCOBALDI (STYLIZED). INT. CL. 33. (U.S. CL. 47). REG. 12-19-1978.
- 1,110,470. MISCELLANEOUS DESIGN. INT. CL. 12. (U.S. CL. 23). REG. 1-2-1979.
- 1,110,632. NESTLE CRUNCH (STYLIZED). INT. CL. 30. (U.S. CL. 46). REG. 1-2-1979.
- 1,110,968. PEDRO GARCIA. INT. CL. 25. (U.S. CL. 39). REG. 1-9-1979.
- 1,111,160. UCARE. INT. CL. 1. (U.S. CL. 6). REG. 1-16-1979.
- 1,111,173. MERZ. INT. CL. 3 ONLY. (U.S. CL. 51). REG. 1-16-1979.
- 1,111,279. DIACORE. INT. CL. 11. (U.S. CL. 13). REG. 1-16-1979.
- 1,111,368. WOODPLAY. INT. CL. 28. (U.S. CL. 22). REG. 1-16-1979.
- 1,112,315. THERM-A-REST AND DESIGN. INT. CL. 20. (U.S. CL. 32). REG. 1-30-1979.
- 1,113,227. MCDONALD'S. INT. CL. 28. (U.S. CL. 22). REG. 2-13-1979.
- 1,113,733. MIXUPS (STYLIZED). INT. CL. 30. (U.S. CL. 46). REG. 2-20-1979.
- 1,118,152. ALDUTI-RUPTER. INT. CL. 9. (U.S. CL. 21). REG. 5-15-1979.
- 1,118,929. CASH MANAGEMENT ACCOUNT. INT. CL. 36. (U.S. CL. 102). REG. 5-22-1979.
- 1,119,513. FRESH AIR. INT. CL. 7. (U.S. CL. 23). REG. 6-5-1979.
- 1,122,521. DE KUYPER. INT. CL. 33. (U.S. CL. 49). REG. 7-17-1979.
- 1,127,341. ZBT AND DESIGN. U.S. CL. 200. REG. 12-4-1979.
- 1,127,342. ZBT 1898 AND DESIGN. U.S. CL. 200. REG. 12-4-1979.
- 1,465,583. ONLY IN USA AND DESIGN. INT. CL. 25. (U.S. CL. 39). REG. 11-17-1987.
- 1,482,127. MISCELLANEOUS DESIGN. INT. CLS. 5 AND 31. (U.S. CLS. 18 AND 46). REG. 3-29-1988.
- 1,483,980. MISCELLANEOUS DESIGN. INT. CLS. 5 AND 31. (U.S. CLS. 18 AND 46). REG. 4-12-1988.
- 1,484,054. IR&E. INT. CL. 7. (U.S. CL. 23). REG. 4-12-1988.
- 1,486,802. ULTRA-DURA. INT. CL. 9. (U.S. CL. 26). REG. 5-3-1988.
- 1,487,857. ROI 100 PLUS AND DESIGN. INT. CL. 41. (U.S. CL. 107). REG. 5-10-1988.
- 1,488,241. ERT. INT. CL. 9. (U.S. CLS. 21 AND 26). REG. 5-17-1988.
- 1,488,805. HOMEWORK IS WHAT WE DO BEST. INT. CL. 36. (U.S. CLS. 101 AND 102). REG. 5-17-1988.
- 1,489,393. CUDDLE TIME. INT. CL. 24 ONLY. (U.S. CL. 42). REG. 5-24-1988.
- 1,490,186. MONTEBELLO (STYLIZED). INT. CL. 18. (U.S. CL. 1). REG. 5-31-1988.
- 1,490,281. DI MORINI (STYLIZED). INT. CL. 25. (U.S. CL. 39). REG. 5-31-1988.
- 1,490,849. EZ-VAULT. INT. CL. 9. (U.S. CL. 26). REG. 6-7-1988.
- 1,491,450. TEMENOS AND DESIGN. INT. CL. 35. (U.S. CL. 101). REG. 6-7-1988.
- 1,492,914. DI-NA-CAL. INT. CLS. 7 AND 16. (U.S. CLS. 23 AND 38). REG. 6-21-1988.
- 1,494,682. TZADDI. INT. CL. 42. (U.S. CL. 100). REG. 6-28-1988.
- 1,495,834. HAWS AND DESIGN. INT. CL. 21. (U.S. CL. 2). REG. 7-12-1988.
- 1,496,296. MANIFESTO. INT. CL. 42. (U.S. CLS. 100, 101 AND 103). REG. 7-12-1988.
- 1,503,746. AUTOPIPE. INT. CL. 9. (U.S. CL. 38). REG. 9-13-1988.
- 1,504,747. THREE-WAY TRAY. INT. CL. 10. (U.S. CL. 44). REG. 9-20-1988.
- 1,507,307. HENRY-GRIFFITTS (STYLIZED). INT. CL. 28. (U.S. CL. 22). REG. 10-4-1988.
- 1,507,932. PORTA SYSTEMS (STYLIZED). INT. CL. 9. (U.S. CL. 21). REG. 10-11-1988.
- 1,508,425. THE ROYAL CHERRY. INT. CL. 29. (U.S. CL. 46). REG. 10-11-1988.
- 1,509,718. SUNPRENE. INT. CL. 1. (U.S. CL. 1). REG. 10-25-1988.
- 1,511,770. MAXFLEX. INT. CL. 17. (U.S. CL. 35). REG. 11-8-1988.
- 1,511,811. ASHTON-YORK. INT. CL. 20. (U.S. CL. 32). REG. 11-8-1988.
- 1,511,914. SANT AMBROEUS. INT. CLS. 29, 30 AND 42. (U.S. CLS. 46, 100 AND 101). REG. 11-8-1988.
- 1,512,254. TOPCAST. INT. CL. 1. (U.S. CL. 6). REG. 11-15-1988.
- 1,512,479. IMAGIFORCE. INT. CL. 9. (U.S. CL. 21). REG. 11-15-1988.
- 1,512,883. CHAR LU. INT. CL. 28. (U.S. CL. 22). REG. 11-15-1988.
- 1,512,983. LACE. INT. CL. 33. (U.S. CL. 47). REG. 11-15-1988.
- 1,513,278. LOEWE. INT. CLS. 3 AND 14. (U.S. CLS. 1, 2, 4, 6, 27, 28, 50, 51 AND 52). REG. 11-22-1988.
- 1,513,319. MARY KAY. INT. CL. 5. (U.S. CL. 18). REG. 11-22-1988.
- 1,513,367. PAGERWRITER (STYLIZED). INT. CL. 10 ONLY. (U.S. CL. 44). REG. 11-22-1988.
- 1,513,376. ERA. INT. CL. 9. (U.S. CLS. 26 AND 38). REG. 11-22-1988.
- 1,513,536. 10 AND DESIGN. INT. CLS. 16 AND 42. (U.S. CLS. 38 AND 101). REG. 11-22-1988.
- 1,514,013. PREAKNESS. INT. CL. 41. (U.S. CL. 107). REG. 11-22-1988.
- 1,514,093. HOUSEMASTER. INT. CL. 42. (U.S. CL. 100). REG. 11-22-1988.
- 1,514,164. CPIA PROFESSIONALISM SALES EXCELLENCE AND DESIGN. U.S. CL. 200. REG. 11-22-1988.
- 1,514,478. QUICK SQUARE. INT. CL. 9. (U.S. CL. 26). REG. 11-29-1988.
- 1,514,986. THE ORDER OF THE FISHERMEN MINISTRY. INT. CL. 42. (U.S. CL. 100). REG. 11-29-1988.
- 1,515,210. ELECTROX. INT. CL. 9. (U.S. CLS. 21 AND 26). REG. 12-6-1988.
- 1,515,484. SANIBEL. INT. CL. 25. (U.S. CL. 39). REG. 12-6-1988.
- 1,515,646. GIFT OF ELEGANCE SEE'S FAMOUS OLD TIME CANDIES AND DESIGN. INT. CL. 30. (U.S. CL. 46). REG. 12-6-1988.
- 1,515,752. WHERE WE STAND. INT. CL. 36. (U.S. CL. 102). REG. 12-6-1988.
- 1,515,959. POC PHYSICAL OPTICS CORPORATION AND DESIGN. INT. CL. 42. (U.S. CL. 100). REG. 12-6-1988.
- 1,515,970. FAMOUS FAMIGLIA PIZZERIA. INT. CL. 42. (U.S. CL. 100). REG. 12-6-1988.
- 1,515,982. SEE'S CANDIES QUALITY WITHOUT COMPROMISE AND DESIGN. INT. CL. 42. (U.S. CL. 101). REG. 12-6-1988.
- 1,515,983. SEE'S CANDIES. INT. CL. 42. (U.S. CL. 101). REG. 12-6-1988.
- 1,515,984. SEE'S. INT. CL. 42. (U.S. CL. 101). REG. 12-6-1988.
- 1,516,029. LIMN. INT. CL. 42. (U.S. CL. 101). REG. 12-6-1988.
- 1,516,118. BYBLOS (STYLIZED). INT. CLS. 3 AND 18. (U.S. CLS. 3, 51 AND 52). REG. 12-13-1988.
- 1,516,316. GT. INT. CL. 12. (U.S. CLS. 19, 21, 23, 31, 35 AND 44). REG. 12-13-1988.
- 1,516,351. THE SIGN OF SUCCESS. INT. CL. 16. (U.S. CL. 38). REG. 12-13-1988.
- 1,516,501. SEAFAIR. INT. CL. 26. (U.S. CLS. 40 AND 50). REG. 12-13-1988.
- 1,516,680. AMERICAN PRIDE AND DESIGN. INT. CL. 37. (U.S. CL. 103). REG. 12-13-1988.
- 1,516,758. TOLEDO ZOO. INT. CL. 41. (U.S. CL. 107). REG. 12-13-1988.
- 1,516,818. SKI MARKET. INT. CL. 42. (U.S. CL. 101). REG. 12-13-1988.
- 1,517,014. SCHWING. INT. CL. 7. (U.S. CL. 23). REG. 12-20-1988.

- 1,517,197. FENCECRETE AMERICASTANDARD CHARACTER MARK INT. CLS. 19 AND 37. (U.S. CLS. 12 AND 103). REG. 12-20-1988.
- 1,517,239. LOUNGE INTERNATIONAL. INT. CL. 25. (U.S. CLS. 22 AND 39). REG. 12-20-1988.
- 1,517,276. MISCELLANEOUS DESIGN. INT. CL. 25. (U.S. CL. 39). REG. 12-20-1988.
- 1,517,342. RUBY MIST. INT. CL. 30. (U.S. CL. 46). REG. 12-20-1988.
- 1,517,455. TASTE OF THE GROVE. INT. CL. 36. (U.S. CL. 102). REG. 12-20-1988.
- 1,517,460. ENERGY MACHINERY AND DESIGN. INT. CL. 37. (U.S. CL. 103). REG. 12-20-1988.
- 1,517,732. ABOVE. INT. CL. 3. (U.S. CL. 4). REG. 12-27-1988.
- 1,517,787. YMW. INT. CL. 7. (U.S. CL. 23). REG. 12-27-1988.
- 1,518,006. VHAF. INT. CL. 19. (U.S. CLS. 12 AND 42). REG. 12-27-1988.
- 1,518,065. GRIPGROOV. INT. CL. 25. (U.S. CL. 39). REG. 12-27-1988.
- 1,518,181. SEE'S CANDIES AND DESIGN. INT. CL. 30. (U.S. CL. 46). REG. 12-27-1988.
- 1,518,522. IMO'S PIZZA. INT. CL. 42. (U.S. CL. 100). REG. 12-27-1988.
- 1,518,637. SUPER SABER. INT. CL. 6. (U.S. CL. 13). REG. 1-3-1989.
- 1,518,874. VECTORVEST. INT. CL. 16. (U.S. CL. 38). REG. 1-3-1989.
- 1,519,039. GALASSO'S. INT. CL. 30. (U.S. CL. 46). REG. 1-3-1989.
- 1,520,204. THE TOKENS. INT. CL. 41. (U.S. CL. 107). REG. 1-10-1989.
- 1,520,430. PURE-FUME. INT. CL. 3. (U.S. CLS. 1, 4, 6, 50, 51 AND 52). REG. 1-17-1989.
- 1,520,742. BLACK-MINI. INT. CL. 10. (U.S. CL. 44). REG. 1-17-1989.
- 1,521,288. CHEMAWARE. INT. CL. 41. (U.S. CL. 107). REG. 1-17-1989.
- 1,521,422. SPECIFLEX. INT. CL. 1. (U.S. CL. 6). REG. 1-24-1989.
- 1,521,753. SPAIN GOURMETOUR FOOD, WINE & TRAVELS QUARTERLY MAGAZINE AND DESIGN. INT. CL. 16. (U.S. CL. 38). REG. 1-24-1989.
- 1,521,867. DEEP WATER. INT. CL. 21. (U.S. CLS. 2 AND 13). REG. 1-24-1989.
- 1,524,100. CONFIXOR. INT. CL. 3. (U.S. CL. 51). REG. 2-14-1989.
- 1,524,120. RALLY. INT. CL. 5. (U.S. CL. 6). REG. 2-14-1989.
- 1,524,442. SADOWSKY GUITARS (STYLIZED). INT. CL. 15. (U.S. CL. 36). REG. 2-14-1989.
- 1,524,639. OUTDOORS MAN. INT. CL. 25. (U.S. CL. 39). REG. 2-14-1989.
- 1,524,782. CRITICAL MASS MEDIA. INT. CL. 35. (U.S. CL. 101). REG. 2-14-1989.
- 1,525,716. TOTES. INT. CL. 21. (U.S. CL. 2). REG. 2-21-1989.
- 1,526,347. CIMTECH. INT. CL. 1. (U.S. CL. 6). REG. 2-28-1989.
- 1,526,700. EU. INT. CL. 10. (U.S. CL. 44). REG. 2-28-1989.
- 1,527,333. COLOTRUST. INT. CL. 36. (U.S. CLS. 101 AND 102). REG. 2-28-1989.
- 1,527,589. SORBOND. INT. CL. 1. (U.S. CL. 6). REG. 3-7-1989.
- 1,527,599. PRIME OIL (STYLIZED). INT. CL. 1. (U.S. CL. 6). REG. 3-7-1989.
- 1,528,120. TOTES. INT. CL. 11. (U.S. CL. 21). REG. 3-7-1989.
- 1,529,693. LEISURE. INT. CL. 16. (U.S. CL. 38). REG. 3-14-1989.
- 1,530,274. STATIONERY STATION. INT. CL. 42. (U.S. CL. 101). REG. 3-14-1989.
- 1,530,893. TOTES. INT. CL. 20. (U.S. CL. 32). REG. 3-21-1989.
- 1,531,342. UNITED STATES BALLROOM CHAMPIONSHIPS. INT. CL. 41. (U.S. CL. 107). REG. 3-21-1989.
- 1,531,762. ZUKEN AND DESIGN. INT. CL. 9. (U.S. CL. 38). REG. 3-28-1989.
- 1,531,997. U.S. SILICA AND DESIGN. INT. CL. 19. (U.S. CLS. 1 AND 12). REG. 3-28-1989.
- 1,532,879. FLEXXICON. INT. CL. 10. (U.S. CL. 44). REG. 4-4-1989.
- 1,533,078. SENSEMATIC AND DESIGN. INT. CL. 16. (U.S. CL. 37). REG. 4-4-1989.
- 1,533,590. JIMMY FUND. INT. CL. 36. (U.S. CL. 102). REG. 4-4-1989.
- 1,534,690. TEC-RO. INT. CLS. 40 AND 42. (U.S. CLS. 100 AND 106). REG. 4-11-1989.
- 1,535,009. PROVAC. INT. CL. 7. (U.S. CL. 23). REG. 4-18-1989.
- 1,540,726. TOOTIE FRUITIES. INT. CL. 30. (U.S. CL. 46). REG. 5-23-1989.
- 1,541,250. MISCELLANEOUS DESIGN. INT. CL. 9. (U.S. CL. 26). REG. 5-30-1989.
- 1,544,308. DOUBLE CASCADE SPOUT. INT. CL. 11. (U.S. CL. 13). REG. 6-20-1989.
- 1,547,216. CADD. INT. CL. 10. (U.S. CL. 44). REG. 7-11-1989.
- 1,549,853. OPTOTRAK. INT. CL. 9. (U.S. CLS. 21 AND 26). REG. 8-1-1989.
- 1,551,192. SOL. CERVEZA ESPECIAL IMPORTED BEER ORIZABA VERACRUZ. AND DESIGN. INT. CL. 32. (U.S. CL. 48). REG. 8-8-1989.
- 1,556,098. BUCKMASTERS. INT. CL. 36. (U.S. CLS. 101 AND 102). REG. 9-12-1989.
- 1,556,694. SURE-CAL. INT. CL. 10. (U.S. CL. 44). REG. 9-19-1989.
- 1,557,397. BUCKMASTERS AND DESIGN. U.S. CL. 200. REG. 9-19-1989.
- 1,558,569. TABLESCAPES. INT. CL. 42. (U.S. CL. 100). REG. 9-26-1989.
- 1,559,278. WORLDCLUBS. INT. CL. 39. (U.S. CL. 105). REG. 10-3-1989.
- 1,562,894. ENVIRO-TORQ. INT. CL. 1. (U.S. CL. 6). REG. 10-31-1989.
- 1,563,049. DOUBLELOCK (STYLIZED). INT. CL. 7. (U.S. CL. 23). REG. 10-31-1989.
- 1,563,711. AAA EMPLOYMENT. INT. CL. 35. (U.S. CL. 101). REG. 10-31-1989.
- 1,563,780. TRIM. INT. CL. 36. (U.S. CLS. 101 AND 102). REG. 10-31-1989.
- 1,564,986. AAA EMPLOYMENT AND DESIGN. INT. CL. 35. (U.S. CL. 101). REG. 11-7-1989.
- 1,565,977. WILSONART. INT. CL. 20. (U.S. CL. 32). REG. 11-14-1989.
- 1,566,474. ARGUS SECURITY GROUP, INC. AND DESIGN. INT. CL. 42. (U.S. CLS. 100 AND 101). REG. 11-14-1989.
- 1,568,805. TRIM-PLUS. INT. CL. 36. (U.S. CL. 102). REG. 11-28-1989.
- 1,569,917. TORNADO TUBE (STYLIZED). INT. CL. 28. (U.S. CLS. 22 AND 50). REG. 12-5-1989.
- 2,103,172. JUNIOR ASSEMBLIES. INT. CL. 41. (U.S. CLS. 100, 101 AND 107). REG. 10-7-1997.
- 2,103,391. DESIGN TRENDS FASHION SOFT SEATS. INT. CL. 11. (U.S. CLS. 13, 21, 23, 31 AND 34). REG. 10-7-1997.
- 2,123,411. MATSCO. INT. CL. 36. (U.S. CLS. 100, 101 AND 102). REG. 12-23-1997.
- 2,144,352. GO-QUAD. INT. CL. 12. (U.S. CLS. 19, 21, 23, 31, 35 AND 44). REG. 3-17-1998.
- 2,148,901. MAKHTESHIM AGAN AND DESIGN. INT. CL. 5. (U.S. CLS. 6, 18, 44, 46, 51 AND 52). REG. 4-7-1998.
- 2,149,651. PLANTMASTER. INT. CL. 1. (U.S. CLS. 1, 5, 6, 10, 26 AND 46). REG. 4-7-1998.
- 2,149,829. CORRECTION ROLLERBALL. INT. CL. 16. (U.S. CLS. 2, 5, 22, 23, 29, 37, 38 AND 50). REG. 4-7-1998.
- 2,154,329. SPIDER. INT. CL. 28. (U.S. CLS. 22, 23, 38 AND 50). REG. 4-28-1998.
- 2,155,674. FRED HAYMAN'S HOLLYWOOD. INT. CL. 3. (U.S. CLS. 1, 4, 6, 50, 51 AND 52). REG. 5-5-1998.
- 2,158,020. STABILZYME SELECT. INT. CL. 1. (U.S. CLS. 1, 5, 6, 10, 26 AND 46). REG. 5-19-1998.
- 2,158,094. PAPER MOON MILANO AND DESIGN. INT. CL. 42. (U.S. CLS. 100 AND 101). REG. 5-19-1998.
- 2,158,347. CELL SIGNAL ENHANCER. INT. CL. 5. (U.S. CLS. 6, 18, 44, 46, 51 AND 52). REG. 5-19-1998.
- 2,159,379. MEGASTORAGE. INT. CL. 9. (U.S. CLS. 21, 23, 26, 36 AND 38). REG. 5-19-1998.
- 2,159,609. ONLEX TECHNOLOGIES. INT. CL. 9. (U.S. CLS. 21, 23, 26, 36 AND 38). REG. 5-19-1998.
- 2,161,245. LL AND DESIGN. INT. CL. 5. (U.S. CLS. 6, 18, 44, 46, 51 AND 52). REG. 6-2-1998.
- 2,161,483. MISCELLANEOUS DESIGN. INT. CLS. 9 AND 42. (U.S. CLS. 21, 23, 26, 36, 38, 100 AND 101). REG. 6-2-1998.
- 2,161,487. TIKI AND DESIGN. INT. CLS. 4 AND 11. (U.S. CLS. 1, 6, 13, 15, 21, 23, 31 AND 34). REG. 6-2-1998.
- 2,162,367. MM KARTON AND DESIGN. INT. CL. 16. (U.S. CLS. 2, 5, 22, 23, 29, 37, 38 AND 50). REG. 6-2-1998.
- 2,163,052. MISCELLANEOUS DESIGN. INT. CL. 41. (U.S. CLS. 100, 101 AND 107). REG. 6-9-1998.

- 2,163,258. PAWS PRESENTS. INT. CL. 16 ONLY. (U.S. CLS. 2, 5, 22, 23, 29, 37, 38 AND 50). REG. 6-9-1998.
- 2,164,644. COMPREHAB. INT. CL. 42. (U.S. CLS. 100 AND 101). REG. 6-9-1998.
- 2,165,243. VERITECH. INT. CL. 9. (U.S. CLS. 21, 23, 26, 36 AND 38). REG. 6-16-1998.
- 2,166,250. ENDURANCE MCC. INT. CL. 1. (U.S. CLS. 1, 5, 6, 10, 26 AND 46). REG. 6-16-1998.
- 2,167,660. CREATIVITIES. INT. CL. 20. (U.S. CLS. 2, 13, 22, 25, 32 AND 50). REG. 6-23-1998.
- 2,168,372. MPBINGO. INT. CL. 41. (U.S. CLS. 100, 101 AND 107). REG. 6-23-1998.
- 2,169,649. CATHLON. INT. CL. 10. (U.S. CLS. 26, 39 AND 44). REG. 6-30-1998.
- 2,170,564. SUCCESSION SOLUTIONS. INT. CL. 36. (U.S. CLS. 100, 101 AND 102). REG. 6-30-1998.
- 2,170,682. BULLS & BRONCS. INT. CL. 41. (U.S. CLS. 100, 101 AND 107). REG. 7-7-1998.
- 2,172,033. GUILT FREE. INT. CL. 30. (U.S. CL. 46). REG. 7-7-1998.
- 2,174,706. PILOT BRANDS FOCUSED ON EXCELLENCE AND DESIGN. INT. CL. 29. (U.S. CL. 46). REG. 7-21-1998.
- 2,177,795. HOMETOWN HISTORY AND DESIGN. INT. CL. 16 ONLY. (U.S. CLS. 2, 5, 22, 23, 29, 37, 38 AND 50). REG. 8-4-1998.
- 2,179,867. HOMETOWN HISTORY. INT. CL. 16 ONLY. (U.S. CLS. 2, 5, 22, 23, 29, 37, 38 AND 50). REG. 8-11-1998.
- 2,180,103. LOGAN GLASS. INT. CL. 37. (U.S. CLS. 100, 103 AND 106). REG. 8-11-1998.
- 2,180,727. LOUISIANA STATE BAR ASSOCIATION AND DESIGN. INT. CL. 16. (U.S. CLS. 2, 5, 22, 23, 29, 37, 38 AND 50). REG. 8-11-1998.
- 2,180,890. J.M.WESTON. INT. CL. 25. (U.S. CLS. 22 AND 39). REG. 8-11-1998.
- 2,181,580. GUILT FREE. INT. CLS. 29, 30 AND 32. (U.S. CLS. 45, 46 AND 48). REG. 8-11-1998.
- 2,184,002. MONSTER. INT. CL. 9. (U.S. CLS. 21, 23, 26, 36 AND 38). REG. 8-25-1998.
- 2,184,065. BRIGHAM'S AND DESIGN. INT. CL. 42. (U.S. CLS. 100 AND 101). REG. 8-25-1998.
- 2,187,695. BRIGHAM'S (STYLIZED). INT. CL. 42. (U.S. CLS. 100 AND 101). REG. 9-8-1998.
- 2,190,163. EYES ON NATURE. INT. CL. 16. (U.S. CL. 38). REG. 9-22-1998.
- 2,191,735. MISCELLANEOUS DESIGN. INT. CL. 25. (U.S. CLS. 22 AND 39). REG. 9-29-1998.
- 2,194,908. BANCARD BULLETIN. INT. CL. 16. (U.S. CLS. 2, 5, 22, 23, 29, 37, 38 AND 50). REG. 10-13-1998.
- 2,195,210. VANTAGE. INT. CL. 9. (U.S. CLS. 21, 23, 26, 36 AND 38). REG. 10-13-1998.
- 2,195,640. STARLINE 2000. INT. CL. 17. (U.S. CLS. 1, 5, 12, 13, 35 AND 50). REG. 10-13-1998.
- 2,195,771. HDA. INT. CL. 1. (U.S. CLS. 1, 5, 6, 10, 26 AND 46). REG. 10-13-1998.
- 2,195,843. MAX2 AND DESIGN. INT. CL. 2. (U.S. CLS. 6, 11 AND 16). REG. 10-13-1998.
- 2,196,134. QPC. INT. CL. 42. (U.S. CLS. 100 AND 101). REG. 10-13-1998.
- 2,196,147. SOFTEX. INT. CL. 24. (U.S. CLS. 42 AND 50). REG. 10-13-1998.
- 2,196,275. NUCLEUS. INT. CL. 12. (U.S. CLS. 19, 21, 23, 31, 35 AND 44). REG. 10-13-1998.
- 2,196,444. GENERAL SEMICONDUCTOR. INT. CL. 9. (U.S. CLS. 21, 23, 26, 36 AND 38). REG. 10-13-1998.
- 2,196,488. HOUSTON COMETS AND DESIGN. INT. CL. 16. (U.S. CLS. 2, 5, 22, 23, 29, 37, 38 AND 50). REG. 10-13-1998.
- 2,196,970. AF ADVANTAGE. INT. CL. 36. (U.S. CLS. 100, 101 AND 102). REG. 10-20-1998.
- 2,197,250. CARE FORCE. INT. CL. 41. (U.S. CLS. 100, 101 AND 107). REG. 10-20-1998.
- 2,197,816. AMALA. INT. CL. 27. (U.S. CLS. 19, 20, 37, 42 AND 50). REG. 10-20-1998.
- 2,197,817. NIMA. INT. CL. 27. (U.S. CLS. 19, 20, 37, 42 AND 50). REG. 10-20-1998.
- 2,197,818. MISCELLANEOUS DESIGN. INT. CL. 27. (U.S. CLS. 19, 20, 37, 42 AND 50). REG. 10-20-1998.
- 2,197,819. ABU. INT. CL. 27. (U.S. CLS. 19, 20, 37, 42 AND 50). REG. 10-20-1998.
- 2,197,835. COMMUNITY ADVANTAGE NETWORK. INT. CL. 36. (U.S. CLS. 100, 101 AND 102). REG. 10-20-1998.
- 2,198,278. MID RIVER MINERALS AND DESIGN. INT. CL. 6. (U.S. CLS. 2, 12, 13, 14, 23, 25 AND 50). REG. 10-20-1998.
- 2,198,707. COMPANION CARE. INT. CLS. 3 AND 5. (U.S. CLS. 1, 4, 6, 18, 44, 46, 50, 51 AND 52). REG. 10-20-1998.
- 2,199,323. SAFEGUARD. INT. CL. 6. (U.S. CLS. 2, 12, 13, 14, 23, 25 AND 50). REG. 10-27-1998.
- 2,199,532. SHADOW MOUNTAIN RESORT & CLUB. INT. CLS. 35 AND 41. (U.S. CLS. 100, 101, 102 AND 107). REG. 10-27-1998.
- 2,199,764. LIMOWORLD. INT. CL. 39. (U.S. CLS. 100 AND 105). REG. 10-27-1998.
- 2,200,254. PRESCISSION (STYLIZED). INT. CL. 1. (U.S. CLS. 1, 5, 6, 10, 26 AND 46). REG. 10-27-1998.
- 2,201,261. LASER IMPRESSIONS. INT. CL. 6. (U.S. CLS. 2, 12, 13, 14, 23, 25 AND 50). REG. 11-3-1998.
- 2,202,053. INSIGNIA. INT. CL. 7. (U.S. CLS. 13, 19, 21, 23, 31, 34 AND 35). REG. 11-3-1998.
- 2,202,129. WOODS HOLE OCEANOGRAPHIC INSTITUTION 1930 AND DESIGN. INT. CLS. 9, 16, 18, 21, 25 AND 41 ONLY. (U.S. CLS. 1, 2, 3, 5, 13, 21, 22, 23, 26, 29, 30, 33, 36, 37, 38, 39, 40, 41, 50, 100, 101 AND 107). REG. 11-3-1998.
- 2,202,629. PRINTANYWHERE. INT. CL. 9. (U.S. CLS. 21, 23, 26, 36 AND 38). REG. 11-10-1998.
- 2,202,638. NATIONAL CENTER FOR MISSING & EXPLOITED CHILDREN. INT. CL. 42. (U.S. CLS. 100 AND 101). REG. 11-10-1998.
- 2,202,652. COMMSOFT. INT. CL. 42. (U.S. CLS. 100 AND 101). REG. 11-10-1998.
- 2,202,666. MET HOME. INT. CLS. 16 AND 42. (U.S. CLS. 2, 5, 22, 23, 29, 37, 38, 50, 100 AND 101). REG. 11-10-1998.
- 2,202,684. WALKING THE WORLD. INT. CLS. 16 AND 25. (U.S. CLS. 2, 5, 22, 23, 29, 37, 38, 39 AND 50). REG. 11-10-1998.
- 2,202,844. IDI AND DESIGN. INT. CLS. 36 AND 37. (U.S. CLS. 100, 101, 102, 103 AND 106). REG. 11-10-1998.
- 2,202,871. FAMOUS MUSIC AND DESIGN. INT. CL. 16. (U.S. CLS. 2, 5, 22, 23, 29, 37, 38 AND 50). REG. 11-10-1998.
- 2,202,872. FAMOUS MUSIC AND DESIGN. INT. CL. 41. (U.S. CLS. 100, 101 AND 107). REG. 11-10-1998.
- 2,202,923. THATCH-LESS. INT. CL. 1. (U.S. CLS. 1, 5, 6, 10, 26 AND 46). REG. 11-10-1998.
- 2,203,094. DENTALIS. INT. CL. 5. (U.S. CLS. 6, 18, 44, 46, 51 AND 52). REG. 11-10-1998.
- 2,203,342. JUICE BAR. INT. CL. 3. (U.S. CLS. 1, 4, 6, 50, 51 AND 52). REG. 11-10-1998.
- 2,203,453. CACI INTERNATIONAL AND DESIGN. INT. CL. 3. (U.S. CLS. 1, 4, 6, 50, 51 AND 52). REG. 11-17-1998.
- 2,203,512. BIOKINETICS. INT. CLS. 37 AND 42. (U.S. CLS. 100, 101, 103 AND 106). REG. 11-17-1998.
- 2,203,822. TROIKA DIALOG. INT. CLS. 36 AND 42. (U.S. CLS. 100, 101 AND 102). REG. 11-17-1998.
- 2,203,823. ADVANCE TABCO AND DESIGN. INT. CLS. 11 AND 20. (U.S. CLS. 2, 13, 21, 22, 23, 25, 31, 32, 34 AND 50). REG. 11-17-1998.
- 2,203,846. T R O N E X AND DESIGN. INT. CL. 8. (U.S. CLS. 23, 28 AND 44). REG. 11-17-1998.
- 2,203,881. WEALTHQUEST. INT. CL. 36. (U.S. CLS. 100, 101 AND 102). REG. 11-17-1998.
- 2,203,910. SPERZEL. INT. CL. 15. (U.S. CLS. 2, 21 AND 36). REG. 11-17-1998.
- 2,203,950. CRITTER CLIPS. INT. CL. 10. (U.S. CLS. 26, 39 AND 44). REG. 11-17-1998.
- 2,204,294. MISCELLANEOUS DESIGN. INT. CL. 5. (U.S. CLS. 6, 18, 44, 46, 51 AND 52). REG. 11-17-1998.
- 2,204,396. DYNAGRIP. INT. CL. 8. (U.S. CLS. 23, 28 AND 44). REG. 11-17-1998.
- 2,204,464. CUSTOMERS FOR LIFE. INT. CL. 37. (U.S. CLS. 100, 103 AND 106). REG. 11-17-1998.
- 2,204,518. JIMTEX. INT. CL. 23. (U.S. CL. 43). REG. 11-17-1998.
- 2,204,577. NATURE'S RAGE. INT. CL. 9. (U.S. CLS. 21, 23, 26, 36 AND 38). REG. 11-17-1998.
- 2,204,950. MOTOROLA. INT. CLS. 9, 11, 14, 16, 18, 20, 21, 24 AND 25 ONLY. (U.S. CLS. 1, 2, 3, 5, 13, 21, 22, 23, 25, 26, 27, 28, 29, 30, 31, 32, 33, 34, 36, 37, 38, 39, 40, 41, 42 AND 50). REG. 11-24-1998.
- 2,205,005. PREMIUM PLUS. INT. CL. 19. (U.S. CLS. 1, 12, 33 AND 50). REG. 11-24-1998.

- 2,205,193. HUEY AND DESIGN. INT. CL. 25. (U.S. CLS. 22 AND 39). REG. 11-24-1998.
- 2,205,396. FERN AND DESIGN. INT. CL. 4. (U.S. CLS. 1, 6 AND 15). REG. 11-24-1998.
- 2,205,626. LEMONHEAD. INT. CL. 25. (U.S. CLS. 22 AND 39). REG. 11-24-1998.
- 2,205,692. STAKARE. INT. CL. 42. (U.S. CLS. 100 AND 101). REG. 11-24-1998.
- 2,206,059. TOP OF THE MARK AND DESIGN. INT. CL. 42. (U.S. CLS. 100 AND 101). REG. 11-24-1998.
- 2,206,385. CERASET. INT. CL. 1 ONLY. (U.S. CLS. 1, 5, 6, 10, 26 AND 46). REG. 12-1-1998.
- 2,206,408. SLIME. INT. CL. 28. (U.S. CLS. 22, 23, 38 AND 50). REG. 12-1-1998.
- 2,206,497. AAMI. INT. CLS. 16, 41 AND 42. (U.S. CLS. 2, 5, 22, 23, 29, 37, 38, 50, 100, 101 AND 107). REG. 12-1-1998.
- 2,206,585. PUTTING PATIENTS FIRST. INT. CLS. 16 AND 41. (U.S. CLS. 2, 5, 22, 23, 29, 37, 38, 50, 100, 101 AND 107). REG. 12-1-1998.
- 2,206,586. MACKAY GUARDIAN. INT. CL. 9. (U.S. CLS. 21, 23, 26, 36 AND 38). REG. 12-1-1998.
- 2,206,643. JIM DANDY TATTOO MACHINE AND DESIGN. INT. CL. 7. (U.S. CLS. 13, 19, 21, 23, 31, 34 AND 35). REG. 12-1-1998.
- 2,206,771. CAN-PULSE. INT. CL. 9. (U.S. CLS. 21, 23, 26, 36 AND 38). REG. 12-1-1998.
- 2,207,212. RENU MULTIPLUS. INT. CL. 5. (U.S. CLS. 6, 18, 44, 46, 51 AND 52). REG. 12-1-1998.
- 2,207,329. TCS. INT. CL. 16. (U.S. CLS. 2, 5, 22, 23, 29, 37, 38 AND 50). REG. 12-1-1998.
- 2,207,409. MISCELLANEOUS DESIGN. INT. CL. 25. (U.S. CLS. 22 AND 39). REG. 12-1-1998.
- 2,207,731. GIANT POP. INT. CL. 31. (U.S. CLS. 1 AND 46). REG. 12-1-1998.
- 2,207,818. USA ADMINISTRATION SERVICES, INC. AND DESIGN. INT. CL. 36. (U.S. CLS. 100, 101 AND 102). REG. 12-8-1998.
- 2,208,059. DOUBLETEX. INT. CL. 24. (U.S. CLS. 42 AND 50). REG. 12-8-1998.
- 2,208,164. SWRI AND DESIGN. U.S. CL. A. REG. 12-8-1998.
- 2,208,171. SECURIS. INT. CL. 9. (U.S. CLS. 21, 23, 26, 36 AND 38). REG. 12-8-1998.
- 2,208,193. MAGNUM. INT. CL. 3. (U.S. CLS. 1, 4, 6, 50, 51 AND 52). REG. 12-8-1998.
- 2,208,219. JUST FACE IT. INT. CL. 25. (U.S. CLS. 22 AND 39). REG. 12-8-1998.
- 2,208,262. PATENT, TRADEMARK & COPYRIGHT JOURNAL. INT. CL. 42. (U.S. CLS. 100 AND 101). REG. 12-8-1998.
- 2,208,330. TRADEMARKSMAN AND DESIGN. INT. CL. 35. (U.S. CLS. 100, 101 AND 102). REG. 12-8-1998.
- 2,208,341. FIRSTUNITED (STYLIZED). INT. CL. 36. (U.S. CLS. 100, 101 AND 102). REG. 12-8-1998.
- 2,208,422. BUYOUTS. INT. CL. 16. (U.S. CLS. 2, 5, 22, 23, 29, 37, 38 AND 50). REG. 12-8-1998.
- 2,208,512. HE AMERICAN ASSOCIATION FOR HEALTH EDUCATION AND DESIGN. INT. CLS. 16 AND 41. (U.S. CLS. 2, 5, 22, 23, 29, 37, 38, 50, 100, 101 AND 107). REG. 12-8-1998.
- 2,208,597. TENNIS ELBOW. INT. CL. 5. (U.S. CLS. 6, 18, 44, 46, 51 AND 52). REG. 12-8-1998.
- 2,208,761. GRYPHICS. INT. CL. 9. (U.S. CLS. 21, 23, 26, 36 AND 38). REG. 12-8-1998.
- 2,208,925. AGRIMASTER AND DESIGN. INT. CL. 31. (U.S. CLS. 1 AND 46). REG. 12-8-1998.
- 2,208,949. NORTHWOODS. INT. CL. 1. (U.S. CLS. 1, 5, 6, 10, 26 AND 46). REG. 12-8-1998.
- 2,208,959. PLUSH NOTES. INT. CLS. 16 AND 28. (U.S. CLS. 2, 5, 22, 23, 29, 37, 38 AND 50). REG. 12-8-1998.
- 2,209,093. CANDY AND DANDY. INT. CL. 28. (U.S. CLS. 22, 23, 38 AND 50). REG. 12-8-1998.
- 2,209,120. MISCELLANEOUS DESIGN. INT. CL. 42. (U.S. CLS. 100 AND 101). REG. 12-8-1998.
- 2,209,131. NERDS. INT. CL. 30. (U.S. CL. 46). REG. 12-8-1998.
- 2,209,226. LOP.CLIP.SAW.SNIP!. INT. CL. 35. (U.S. CLS. 100, 101 AND 102). REG. 12-8-1998.
- 2,209,245. FLUOROFLEX. INT. CL. 28. (U.S. CLS. 22, 23, 38 AND 50). REG. 12-8-1998.
- 2,209,259. SIL-OU-ET. INT. CL. 29. (U.S. CL. 46). REG. 12-8-1998.
- 2,209,260. NEIMAN MARCUS. INT. CL. 36. (U.S. CLS. 100, 101 AND 102). REG. 12-8-1998.
- 2,209,347. THE ATHLETE'S FOOT. INT. CL. 25. (U.S. CLS. 22 AND 39). REG. 12-8-1998.
- 2,209,405. DUAL II MAGNUM. INT. CL. 5. (U.S. CLS. 6, 18, 44, 46, 51 AND 52). REG. 12-8-1998.
- 2,209,503. FLAVOR GLO. INT. CL. 1. (U.S. CLS. 1, 5, 6, 10, 26 AND 46). REG. 12-8-1998.
- 2,209,529. NARCIS-VAN-HET-JAAR. INT. CL. 31. (U.S. CLS. 1 AND 46). REG. 12-8-1998.
- 2,209,603. SO DE LA RENTA. INT. CL. 3. (U.S. CLS. 1, 4, 6, 50, 51 AND 52). REG. 12-8-1998.
- 2,209,634. HAZTEX. INT. CL. 11. (U.S. CLS. 13, 21, 23, 31 AND 34). REG. 12-8-1998.
- 2,209,683. TRI-DENT. INT. CL. 6. (U.S. CLS. 2, 12, 13, 14, 23, 25 AND 50). REG. 12-8-1998.
- 2,209,767. ART 2000. INT. CL. 14. (U.S. CLS. 2, 27, 28 AND 50). REG. 12-8-1998.
- 2,210,263. MISCELLANEOUS DESIGN. INT. CL. 41. (U.S. CLS. 100, 101 AND 107). REG. 12-15-1998.
- 2,210,286. EXS. INT. CL. 9. (U.S. CLS. 21, 23, 26, 36 AND 38). REG. 12-15-1998.
- 2,210,309. A/X. INT. CL. 35. (U.S. CLS. 100, 101 AND 102). REG. 12-15-1998.
- 2,210,349. ASCD. INT. CLS. 9, 16, 35 AND 41 ONLY. (U.S. CLS. 2, 5, 21, 22, 23, 26, 29, 36, 37, 38, 50, 100, 101, 102 AND 107). REG. 12-15-1998.
- 2,210,524. PLUSCON. INT. CL. 9. (U.S. CLS. 21, 23, 26, 36 AND 38). REG. 12-15-1998.
- 2,210,613. ORGULLO HISPANO. INT. CL. 41. (U.S. CLS. 100, 101 AND 107). REG. 12-15-1998.
- 2,210,631. TRUE. INT. CL. 28. (U.S. CLS. 22, 23, 38 AND 50). REG. 12-15-1998.
- 2,210,663. FUSERBLOC. INT. CL. 9. (U.S. CLS. 21, 23, 26, 36 AND 38). REG. 12-15-1998.
- 2,210,664. SIRCO. INT. CL. 9. (U.S. CLS. 21, 23, 26, 36 AND 38). REG. 12-15-1998.
- 2,210,708. ECOTIP. INT. CL. 9. (U.S. CLS. 21, 23, 26, 36 AND 38). REG. 12-15-1998.
- 2,210,825. OTOCLIP. INT. CL. 10. (U.S. CLS. 26, 39 AND 44). REG. 12-15-1998.
- 2,210,837. CADILLAC. INT. CL. 8. (U.S. CLS. 23, 28 AND 44). REG. 12-15-1998.
- 2,210,939. TRACE NUTRITION. INT. CL. 5. (U.S. CLS. 6, 18, 44, 46, 51 AND 52). REG. 12-15-1998.
- 2,210,961. SEA-12. INT. CL. 17. (U.S. CLS. 1, 5, 12, 13, 35 AND 50). REG. 12-15-1998.
- 2,211,105. IASP PRESS. INT. CL. 41. (U.S. CLS. 100, 101 AND 107). REG. 12-15-1998.
- 2,211,106. IASP. INT. CL. 42. (U.S. CLS. 100 AND 101). REG. 12-15-1998.
- 2,211,386. TIMETAG. INT. CL. 20. (U.S. CLS. 2, 13, 22, 25, 32 AND 50). REG. 12-15-1998.
- 2,211,393. USA CURLING AND DESIGN. INT. CLS. 14, 16, 24, 25, 26 AND 41 ONLY. (U.S. CLS. 2, 5, 22, 23, 27, 28, 29, 37, 38, 39, 40, 42, 50, 100, 101 AND 107). REG. 12-15-1998.
- 2,211,415. SWANK. INT. CL. 14. (U.S. CLS. 2, 27, 28 AND 50). REG. 12-15-1998.
- 2,211,452. TAILGATE AND CELEBRATE. INT. CL. 30. (U.S. CL. 46). REG. 12-15-1998.
- 2,211,774. NHIN. INT. CL. 42. (U.S. CLS. 100 AND 101). REG. 12-15-1998.
- 2,211,785. TRIND. INT. CL. 9. (U.S. CLS. 21, 23, 26, 36 AND 38). REG. 12-15-1998.
- 2,211,838. LABEL BUDDY. INT. CL. 16. (U.S. CLS. 2, 5, 22, 23, 29, 37, 38 AND 50). REG. 12-15-1998.
- 2,211,869. PRO/CLEAN. INT. CL. 9. (U.S. CLS. 21, 23, 26, 36 AND 38). REG. 12-15-1998.
- 2,211,910. CLASSIC MELTS. INT. CL. 29. (U.S. CL. 46). REG. 12-15-1998.
- 2,212,032. MEDICAL ADVISORS. INT. CL. 42. (U.S. CL. 100). REG. 12-22-1998.
- 2,212,062. ASH. INT. CL. 42. (U.S. CLS. 100 AND 101). REG. 12-22-1998.
- 2,212,398. SAGE AND DESIGN. INT. CL. 42. (U.S. CLS. 100 AND 101). REG. 12-22-1998.
- 2,212,578. TOGGLER. INT. CLS. 7 AND 8. (U.S. CLS. 13, 19, 21, 23, 28, 31, 34, 35 AND 44). REG. 12-22-1998.
- 2,212,589. MINNESOTA TIMBERWOLVES AND DESIGN. INT. CL. 18. (U.S. CLS. 1, 2, 3, 22 AND 41). REG. 12-22-1998.
- 2,212,657. TACTIC REPLY CARD. INT. CL. 16. (U.S. CLS. 2, 5, 22, 23, 29, 37, 38 AND 50). REG. 12-22-1998.
- 2,212,711. PROJECTSYNC. INT. CL. 9. (U.S. CLS. 21, 23, 26, 36 AND 38). REG. 12-22-1998.
- 2,212,925. JSC. INT. CL. 25. (U.S. CLS. 22 AND 39). REG. 12-22-1998.

- 2,213,025. UNCLE RAY'S DAIRYLAND. INT. CL. 42. (U.S. CLS. 100 AND 101). REG. 12-22-1998.
- 2,213,049. HG AND DESIGN. INT. CL. 35. (U.S. CLS. 100, 101 AND 102). REG. 12-22-1998.
- 2,213,226. WORLD GOLF VILLAGE AND DESIGN. INT. CL. 16. (U.S. CLS. 2, 5, 22, 23, 29, 37, 38 AND 50). REG. 12-22-1998.
- 2,213,312. NORITATE. INT. CL. 5. (U.S. CLS. 6, 18, 44, 46, 51 AND 52). REG. 12-22-1998.
- 2,213,340. FIT FOR THE FUTURE AND DESIGN. INT. CL. 16. (U.S. CLS. 2, 5, 22, 23, 29, 37, 38 AND 50). REG. 12-22-1998.
- 2,213,390. US NANOCORP. INT. CL. 1. (U.S. CLS. 1, 5, 6, 10, 26 AND 46). REG. 12-22-1998.
- 2,213,402. MISCELLANEOUS DESIGN. INT. CL. 9. (U.S. CLS. 21, 23, 26, 36 AND 38). REG. 12-22-1998.
- 2,213,425. CLINIMIX E. INT. CL. 5. (U.S. CLS. 6, 18, 44, 46, 51 AND 52). REG. 12-22-1998.
- 2,213,455. ACCUCOAT. INT. CL. 30. (U.S. CL. 46). REG. 12-22-1998.
- 2,213,495. ITZAKADOOZIE. INT. CL. 30. (U.S. CL. 46). REG. 12-22-1998.
- 2,213,785. FAMILY CHRISTIAN STORES. INT. CL. 35. (U.S. CLS. 100, 101 AND 102). REG. 12-29-1998.
- 2,213,837. TOP TEST AND DESIGN. INT. CL. 9. (U.S. CLS. 21, 23, 26, 36 AND 38). REG. 12-29-1998.
- 2,213,914. V FORCE. INT. CL. 7. (U.S. CLS. 13, 19, 21, 23, 31, 34 AND 35). REG. 12-29-1998.
- 2,214,203. CHECKPOINT. INT. CL. 36. (U.S. CLS. 100, 101 AND 102). REG. 12-29-1998.
- 2,214,275. WATCHCRAFT. INT. CL. 14. (U.S. CLS. 2, 27, 28 AND 50). REG. 12-29-1998.
- 2,214,434. SERVSAFE. INT. CLS. 9 AND 16. (U.S. CLS. 2, 5, 21, 22, 23, 26, 29, 36, 37, 38 AND 50). REG. 12-29-1998.
- 2,214,519. MERLYN AND DESIGN. INT. CL. 37. (U.S. CLS. 100, 103 AND 106). REG. 12-29-1998.
- 2,214,528. ORDERPOINT. INT. CL. 42. (U.S. CLS. 100 AND 101). REG. 12-29-1998.
- 2,214,563. FIDELITY ADVISOR FUNDS. INT. CL. 36. (U.S. CLS. 100, 101 AND 102). REG. 12-29-1998.
- 2,214,583. J. ROBERT SCOTT. INT. CL. 35. (U.S. CLS. 100, 101 AND 102). REG. 12-29-1998.
- 2,214,794. JAMES W. BRINE. INT. CLS. 18 AND 25. (U.S. CLS. 1, 2, 3, 22, 39 AND 41). REG. 12-29-1998.
- 2,214,849. CLINIMIX. INT. CL. 5. (U.S. CLS. 6, 18, 44, 46, 51 AND 52). REG. 12-29-1998.
- 2,214,966. WORLD GOLF VILLAGE AND DESIGN. INT. CL. 21. (U.S. CLS. 2, 13, 23, 29, 30, 33, 40 AND 50). REG. 12-29-1998.
- 2,215,092. CITY OF NEW BRAUNFELS, TEXAS FOUNDED 1845 AND DESIGN. INT. CLS. 6, 14, 16, 21, 25, 26 AND 28. (U.S. CLS. 2, 5, 12, 13, 14, 22, 23, 25, 27, 28, 29, 30, 33, 37, 38, 39, 40, 42 AND 50). REG. 12-29-1998.
- 2,215,104. CALUME (STYLIZED). INT. CL. 34. (U.S. CLS. 2, 8, 9 AND 17). REG. 12-29-1998.
- 2,215,172. FLASHLITE. INT. CL. 9. (U.S. CLS. 21, 23, 26, 36 AND 38). REG. 12-29-1998.
- 2,215,348. REEBOK. INT. CL. 16. (U.S. CLS. 2, 5, 22, 23, 29, 37, 38 AND 50). REG. 12-29-1998.
- 2,215,353. PROWLER. INT. CL. 7. (U.S. CLS. 13, 19, 21, 23, 31, 34 AND 35). REG. 12-29-1998.
- 2,215,512. EN FUEGO. INT. CL. 42. (U.S. CLS. 100 AND 101). REG. 12-29-1998.
- 2,215,593. RADIUS TRACK. INT. CL. 6. (U.S. CLS. 2, 12, 13, 14, 23, 25 AND 50). REG. 12-29-1998.
- 2,215,663. AMERICA'S BEST. INT. CL. 25. (U.S. CLS. 22 AND 39). REG. 1-5-1999.
- 2,215,794. CYCLE TOUGH. INT. CL. 20. (U.S. CLS. 2, 13, 22, 25, 32 AND 50). REG. 1-5-1999.
- 2,215,800. LES WASTE. INT. CL. 41. (U.S. CLS. 100, 101 AND 107). REG. 1-5-1999.
- 2,215,802. AMERICAN ELECTRIC POWER. INT. CL. 39. (U.S. CLS. 100 AND 105). REG. 1-5-1999.
- 2,216,095. LIFE ON THE FARM. INT. CL. 28. (U.S. CLS. 22, 23, 38 AND 50). REG. 1-5-1999.
- 2,216,326. LOVE AT FIRST SLICE (STYLIZED). INT. CL. 42. (U.S. CLS. 100 AND 101). REG. 1-5-1999.
- 2,216,327. FEED THE PLANET (STYLIZED). INT. CL. 42. (U.S. CLS. 100 AND 101). REG. 1-5-1999.
- 2,216,377. MERCER MAYER'S LITTLE CRITTER AND DESIGN. INT. CL. 16. (U.S. CLS. 2, 5, 22, 23, 29, 37, 38 AND 50). REG. 1-5-1999.
- 2,217,013. DARLINGTON TOO TOUGH TO TAME AND DESIGN. INT. CLS. 16, 21, 24, 25 AND 28. (U.S. CLS. 2, 5, 13, 22, 23, 29, 30, 33, 37, 38, 39, 40, 42 AND 50). REG. 1-12-1999.
- 2,217,122. CERTIFIED FIRST ASSISTANT. U.S. CL. B. REG. 1-12-1999.
- 2,217,286. DENTAL FLEX. INT. CL. 17. (U.S. CLS. 1, 5, 12, 13, 35 AND 50). REG. 1-12-1999.
- 2,217,297. ATTRAK AND DESIGN. INT. CL. 25. (U.S. CLS. 22 AND 39). REG. 1-12-1999.
- 2,217,315. KIDDIE KORRAL. INT. CL. 25. (U.S. CLS. 22 AND 39). REG. 1-12-1999.
- 2,217,316. BABY KORRAL. INT. CL. 25. (U.S. CLS. 22 AND 39). REG. 1-12-1999.
- 2,217,458. BANROCK STATION. INT. CL. 33. (U.S. CLS. 47 AND 49). REG. 1-12-1999.
- 2,217,466. ACTICOAT. INT. CL. 2. (U.S. CLS. 6, 11 AND 16). REG. 1-12-1999.
- 2,217,766. WIND STORM. INT. CL. 9. (U.S. CLS. 21, 23, 26, 36 AND 38). REG. 1-12-1999.
- 2,217,949. THE BUBBLE FACTORY. INT. CL. 41 ONLY. (U.S. CLS. 100, 101 AND 107). REG. 1-12-1999.
- 2,217,950. THE BUBBLE FACTORY AND DESIGN. INT. CL. 41 ONLY. (U.S. CLS. 100, 101 AND 107). REG. 1-12-1999.
- 2,217,981. MACHOST. INT. CL. 42. (U.S. CLS. 100 AND 101). REG. 1-12-1999.
- 2,218,001. WEEKEND JOURNAL. INT. CL. 16. (U.S. CLS. 2, 5, 22, 23, 29, 37, 38 AND 50). REG. 1-12-1999.
- 2,218,357. INALFA. INT. CLS. 12 AND 40. (U.S. CLS. 19, 21, 23, 31, 35, 44, 100, 103 AND 106). REG. 1-19-1999.
- 2,218,383. CORONADO GROUP, LTD.. INT. CL. 42. (U.S. CLS. 100 AND 101). REG. 1-19-1999.
- 2,218,420. HYDRO QUEBEC. INT. CL. 39. (U.S. CLS. 100 AND 105). REG. 1-19-1999.
- 2,218,821. TIA MARIA. INT. CL. 33. (U.S. CLS. 47 AND 49). REG. 1-19-1999.
- 2,218,920. SNELL & WILMER. INT. CL. 42. (U.S. CLS. 100 AND 101). REG. 1-19-1999.
- 2,219,473. SIMPLE PLEASURES AND DESIGN. INT. CL. 31. (U.S. CLS. 1 AND 46). REG. 1-19-1999.
- 2,219,628. ALTA OFFICE SERVICES AND DESIGN. INT. CL. 42. (U.S. CLS. 100 AND 101). REG. 1-19-1999.
- 2,219,891. MISCELLANEOUS DESIGN. INT. CLS. 6 AND 12. (U.S. CLS. 2, 12, 13, 14, 19, 21, 23, 25, 31, 35, 44 AND 50). REG. 1-26-1999.
- 2,220,183. TENZO. INT. CLS. 7, 11 AND 12. (U.S. CLS. 13, 19, 21, 23, 31, 34, 35 AND 44). REG. 1-26-1999.
- 2,220,313. SAMOVAR. INT. CL. 27. (U.S. CLS. 19, 20, 37, 42 AND 50). REG. 1-26-1999.
- 2,220,610. HYDRA FRESH. INT. CL. 3. (U.S. CLS. 1, 4, 6, 50, 51 AND 52). REG. 1-26-1999.
- 2,220,651. TECHONLINE. INT. CLS. 35 AND 42. (U.S. CLS. 100, 101 AND 102). REG. 1-26-1999.
- 2,220,731. DURA-LOC. INT. CL. 27. (U.S. CLS. 19, 20, 37, 42 AND 50). REG. 1-26-1999.
- 2,220,745. LMA-CLASSIC. INT. CL. 10. (U.S. CLS. 26, 39 AND 44). REG. 1-26-1999.
- 2,221,401. ARTISTA. INT. CL. 21. (U.S. CLS. 2, 13, 23, 29, 30, 33, 40 AND 50). REG. 2-2-1999.
- 2,221,496. FLEX FOIL. INT. CL. 8. (U.S. CLS. 23, 28 AND 44). REG. 2-2-1999.
- 2,221,514. DEMINOR. INT. CLS. 36 AND 42. (U.S. CLS. 100, 101 AND 102). REG. 2-2-1999.
- 2,221,753. WEST COAST WINE COMPETITION AND DESIGN. INT. CL. 41. (U.S. CLS. 100, 101 AND 107). REG. 2-2-1999.
- 2,221,955. HI-VAP. INT. CL. 31. (U.S. CLS. 1 AND 46). REG. 2-2-1999.
- 2,222,216. POLYSAT. INT. CL. 21. (U.S. CLS. 2, 13, 23, 29, 30, 33, 40 AND 50). REG. 2-9-1999.
- 2,222,341. ARIZONA PRECISION SHEET METAL. INT. CLS. 40 AND 42. (U.S. CLS. 100, 101, 103 AND 106). REG. 2-9-1999.
- 2,222,572. SLICE. INT. CL. 12. (U.S. CLS. 19, 21, 23, 31, 35 AND 44). REG. 2-9-1999.
- 2,223,227. CENEGENICS. INT. CL. 42. (U.S. CLS. 100 AND 101). REG. 2-9-1999.
- 2,224,011. ORIGINAL RESEARCH MAKES A DIFFERENCE. INT. CL. 36. (U.S. CLS. 100, 101 AND 102). REG. 2-16-1999.
- 2,224,107. QUICKSNAP. INT. CL. 9. (U.S. CLS. 21, 23, 26, 36 AND 38). REG. 2-16-1999.
- 2,224,180. PATENT CENTRAL. INT. CL. 42. (U.S. CLS. 100 AND 101). REG. 2-16-1999.

- 2,224,447. HEINZ. INT. CL. 31. (U.S. CLS. 1 AND 46). REG. 2-16-1999.
- 2,224,765. TECHSTOC. INT. CLS. 16 AND 20. (U.S. CLS. 2, 5, 13, 22, 23, 25, 29, 32, 37, 38 AND 50). REG. 2-16-1999.
- 2,224,795. BARIAIR. INT. CL. 10. (U.S. CLS. 26, 39 AND 44). REG. 2-16-1999.
- 2,225,519. TELEBELT (STYLIZED). INT. CL. 7. (U.S. CLS. 13, 19, 21, 23, 31, 34 AND 35). REG. 2-23-1999.
- 2,225,537. PERFECT JOINT SUPPORT. INT. CL. 5. (U.S. CLS. 6, 18, 44, 46, 51 AND 52). REG. 2-23-1999.
- 2,226,124. VERSAWIPE. INT. CL. 21. (U.S. CLS. 2, 13, 23, 29, 30, 33, 40 AND 50). REG. 2-23-1999.
- 2,227,016. TRIDEL. INT. CLS. 35, 37 AND 42 ONLY. (U.S. CLS. 100, 101, 102, 103 AND 106). REG. 3-2-1999.
- 2,227,129. THE GREAT WHITE AND DESIGN. INT. CL. 41. (U.S. CLS. 100, 101 AND 107). REG. 3-2-1999.
- 2,227,589. MISCELLANEOUS DESIGN. INT. CL. 42. (U.S. CLS. 100 AND 101). REG. 3-2-1999.
- 2,227,709. NCB CO-OP 100. INT. CL. 16. (U.S. CLS. 2, 5, 22, 23, 29, 37, 38 AND 50). REG. 3-2-1999.
- 2,228,741. DANCING DOG. INT. CL. 28. (U.S. CLS. 22, 23, 38 AND 50). REG. 3-2-1999.
- 2,229,109. HEINZ AND DESIGN. INT. CL. 31. (U.S. CLS. 1 AND 46). REG. 3-2-1999.
- 2,230,692. GEL-DS TRAINER. INT. CL. 25. (U.S. CLS. 22 AND 39). REG. 3-9-1999.
- 2,231,021. HUNTSMAN AND DESIGN. INT. CL. 1. (U.S. CLS. 1, 5, 6, 10, 26 AND 46). REG. 3-9-1999.
- 2,231,050. STELLARIS. INT. CLS. 41 AND 42. (U.S. CLS. 100, 101 AND 107). REG. 3-9-1999.
- 2,231,124. NOVAQUEST. INT. CL. 35. (U.S. CLS. 100, 101 AND 102). REG. 3-9-1999.
- 2,231,507. 3DEEP. INT. CL. 20. (U.S. CLS. 2, 13, 22, 25, 32 AND 50). REG. 3-16-1999.
- 2,231,631. HIP VIP. INT. CL. 36. (U.S. CLS. 100, 101 AND 102). REG. 3-16-1999.
- 2,231,810. CTSNET. INT. CL. 42. (U.S. CLS. 100 AND 101). REG. 3-16-1999.
- 2,232,642. LIDOS. INT. CL. 9. (U.S. CLS. 21, 23, 26, 36 AND 38). REG. 3-16-1999.
- 2,233,056. WORLD PROFESSIONAL DANCE SPORT CHAMPIONSHIPS. INT. CL. 41. (U.S. CLS. 100, 101 AND 107). REG. 3-16-1999.
- 2,233,100. DECISION-BASED MANAGEMENT. INT. CL. 35. (U.S. CLS. 100, 101 AND 102). REG. 3-16-1999.
- 2,233,209. LEM (STYLIZED). INT. CL. 9. (U.S. CLS. 21, 23, 26, 36 AND 38). REG. 3-23-1999.
- 2,233,320. HOMECARE. INT. CLS. 16 AND 42. (U.S. CLS. 2, 5, 22, 23, 29, 37, 38, 50, 100 AND 101). REG. 3-23-1999.
- 2,233,432. POWERDESIGNER. INT. CL. 9. (U.S. CLS. 21, 23, 26, 36 AND 38). REG. 3-23-1999.
- 2,233,448. FIX AUTO AND DESIGN. INT. CL. 37. (U.S. CLS. 100, 103 AND 106). REG. 3-23-1999.
- 2,233,465. INDUSTRIAL AIR TOOL AND DESIGN. INT. CLS. 35 AND 37. (U.S. CLS. 100, 101, 102, 103 AND 106). REG. 3-23-1999.
- 2,234,260. CAT AND DESIGN. INT. CL. 25. (U.S. CLS. 22 AND 39). REG. 3-23-1999.
- 2,234,261. CATERPILLAR AND DESIGN. INT. CL. 25. (U.S. CLS. 22 AND 39). REG. 3-23-1999.
- 2,234,823. E.P.R AND DESIGN. INT. CL. 30. (U.S. CL. 46). REG. 3-23-1999.
- 2,235,151. QUICK SCOPE. INT. CL. 9. (U.S. CLS. 21, 23, 26, 36 AND 38). REG. 3-23-1999.
- 2,235,693. MISCELLANEOUS DESIGN. INT. CLS. 9 AND 41. (U.S. CLS. 21, 23, 26, 36, 38, 100, 101 AND 107). REG. 3-30-1999.
- 2,236,684. HARTFORD COMPUTER GROUP. INT. CL. 35. (U.S. CLS. 100, 101 AND 102). REG. 4-6-1999.
- 2,236,851. SIMPLE SEAL. INT. CL. 16. (U.S. CLS. 2, 5, 22, 23, 29, 37, 38 AND 50). REG. 4-6-1999.
- 2,236,876. VEAT. INT. CL. 29. (U.S. CL. 46). REG. 4-6-1999.
- 2,237,200. SUBS. INT. CL. 20. (U.S. CLS. 2, 13, 22, 25, 32 AND 50). REG. 4-6-1999.
- 2,237,393. NOAH'S BLEND. INT. CL. 30. (U.S. CL. 46). REG. 4-6-1999.
- 2,237,905. GRIZZLY'S GRILL N' SALOON. INT. CL. 42. (U.S. CLS. 100 AND 101). REG. 4-13-1999.
- 2,238,139. SURGEON'S SKIN SECRET. INT. CL. 3. (U.S. CLS. 1, 4, 6, 50, 51 AND 52). REG. 4-13-1999.
- 2,238,785. MERCHANDISE SHOW PGA PROFESSIONAL GOLFERS' ASSOCIATION OF AMERICA 1916 AND DESIGN. INT. CL. 35. (U.S. CLS. 100, 101 AND 102). REG. 4-13-1999.
- 2,239,290. ELMER'S. INT. CLS. 8 AND 16. (U.S. CLS. 2, 5, 22, 23, 28, 29, 37, 38, 44 AND 50). REG. 4-13-1999.
- 2,239,571. PRIMA TERRA. INT. CL. 33. (U.S. CLS. 47 AND 49). REG. 4-13-1999.
- 2,239,840. VILEDA. INT. CL. 21. (U.S. CLS. 2, 13, 23, 29, 30, 33, 40 AND 50). REG. 4-13-1999.
- 2,239,866. PERIMETER EDGE. INT. CL. 20. (U.S. CLS. 2, 13, 22, 25, 32 AND 50). REG. 4-13-1999.
- 2,240,992. HERD MAKER. INT. CLS. 5 AND 31. (U.S. CLS. 1, 6, 18, 44, 46, 51 AND 52). REG. 4-20-1999.
- 2,242,231. DIVORCED WOMAN MAGAZINE AND DESIGN. INT. CL. 16. (U.S. CLS. 2, 5, 22, 23, 29, 37, 38 AND 50). REG. 4-27-1999.
- 2,243,175. ERGOCENTRIC SEATING SYSTEM AND DESIGN. INT. CL. 20. (U.S. CLS. 2, 13, 22, 25, 32 AND 50). REG. 5-4-1999.
- 2,243,604. GULF MAID. INT. CL. 29. (U.S. CL. 46). REG. 5-4-1999.
- 2,243,900. SPOTLIGHT ON SAFETY. INT. CL. 16. (U.S. CLS. 2, 5, 22, 23, 29, 37, 38 AND 50). REG. 5-4-1999.
- 2,244,046. AMERICAN FAMILY FOUNDATION. INT. CL. 36. (U.S. CLS. 100, 101 AND 102). REG. 5-4-1999.
- 2,244,223. D3EA CERTIFIED CONSISTENT WITH FEDERAL SAFETY STANDARDS AND DESIGN. U.S. CL. A. REG. 5-11-1999.
- 2,244,861. NO SOLICITATION. INT. CL. 38. (U.S. CLS. 100, 101 AND 104). REG. 5-11-1999.
- 2,244,904. ERGOCENTRIC. INT. CL. 20. (U.S. CLS. 2, 13, 22, 25, 32 AND 50). REG. 5-11-1999.
- 2,245,256. CODE SCANNER. INT. CL. 9. (U.S. CLS. 21, 23, 26, 36 AND 38). REG. 5-18-1999.
- 2,245,542. MISCELLANEOUS DESIGN. INT. CL. 14. (U.S. CLS. 2, 27, 28 AND 50). REG. 5-18-1999.
- 2,246,272. ELMER'S. INT. CLS. 1, 2 AND 16. (U.S. CLS. 1, 2, 5, 6, 10, 11, 16, 22, 23, 26, 29, 37, 38, 46 AND 50). REG. 5-18-1999.
- 2,246,946. LUBE OIL ANALYSIS MANAGEMENT SYSTEM (LOAMS). INT. CL. 9. (U.S. CLS. 21, 23, 26, 36 AND 38). REG. 5-25-1999.
- 2,247,157. NAVICARE. INT. CL. 9. (U.S. CLS. 21, 23, 26, 36 AND 38). REG. 5-25-1999.
- 2,247,880. MISCELLANEOUS DESIGN. INT. CL. 14. (U.S. CLS. 2, 27, 28 AND 50). REG. 5-25-1999.
- 2,248,502. LOAMS (STYLIZED). INT. CL. 9. (U.S. CLS. 21, 23, 26, 36 AND 38). REG. 6-1-1999.
- 2,248,562. WEBFOCUS. INT. CL. 9. (U.S. CLS. 21, 23, 26, 36 AND 38). REG. 6-1-1999.
- 2,248,575. PROCENTER (STYLIZED). INT. CL. 9. (U.S. CLS. 21, 23, 26, 36 AND 38). REG. 6-1-1999.
- 2,249,300. ARROW EXTERMINATING CO. INC.. INT. CL. 37. (U.S. CLS. 100, 103 AND 106). REG. 6-1-1999.
- 2,250,122. BEMIS AND DESIGN. INT. CLS. 10 AND 11 ONLY. (U.S. CLS. 13, 21, 23, 26, 31, 34, 39 AND 44). REG. 6-1-1999.
- 2,251,926. HONEY BUZZERS. INT. CL. 30. (U.S. CL. 46). REG. 6-8-1999.
- 2,256,723. ANI. INT. CL. 29. (U.S. CL. 46). REG. 6-29-1999.
- 2,257,329. SHERMAN FAMILY FOODS. INT. CL. 29. (U.S. CL. 46). REG. 6-29-1999.
- 2,258,080. LIGHTNOTE BLEND. INT. CL. 30. (U.S. CL. 46). REG. 6-29-1999.
- 2,258,655. KNOVATION. INT. CL. 42. (U.S. CLS. 100 AND 101). REG. 7-6-1999.
- 2,260,710. AGRILABS AND DESIGN. INT. CL. 5. (U.S. CLS. 6, 18, 44, 46, 51 AND 52). REG. 7-13-1999.
- 2,261,125. EMSOURCE. INT. CL. 36. (U.S. CLS. 100, 101 AND 102). REG. 7-13-1999.
- 2,261,406. VACUCAM. INT. CL. 7. (U.S. CLS. 13, 19, 21, 23, 31, 34 AND 35). REG. 7-13-1999.
- 2,263,692. HANDY MAN'S CHOICE. INT. CL. 9. (U.S. CLS. 21, 23, 26, 36 AND 38). REG. 7-20-1999.
- 2,263,764. APPLE CRUNCHIES. INT. CL. 30. (U.S. CL. 46). REG. 7-20-1999.
- 2,264,371. QUEVISION. INT. CL. 9. (U.S. CLS. 21, 23, 26, 36 AND 38). REG. 7-27-1999.
- 2,264,451. WARRIORVISION. INT. CL. 9. (U.S. CLS. 21, 23, 26, 36 AND 38). REG. 7-27-1999.
- 2,266,149. RITEN CENTERS. INT. CL. 7. (U.S. CLS. 13, 19, 21, 23, 31, 34 AND 35). REG. 8-3-1999.
- 2,266,442. AIR-WEIGH. INT. CL. 42. (U.S. CLS. 100 AND 101). REG. 8-3-1999.

- 2,266,514. WEBEDGE. INT. CL. 42. (U.S. CLS. 100 AND 101). REG. 8-3-1999.
- 2,266,884. TIBURON. INT. CL. 12. (U.S. CLS. 19, 21, 23, 31, 35 AND 44). REG. 8-3-1999.
- 2,267,355. BACTRASAN. INT. CL. 5. (U.S. CLS. 6, 18, 44, 46, 51 AND 52). REG. 8-3-1999.
- 2,269,174. MIAMI DAILY BUSINESS REVIEW. INT. CL. 16. (U.S. CLS. 2, 5, 22, 23, 29, 37, 38 AND 50). REG. 8-10-1999.
- 2,269,721. SMASH-UP DERBY. INT. CL. 28. (U.S. CLS. 22, 23, 38 AND 50). REG. 8-10-1999.
- 2,270,911. GCN INTERNATIONAL. INT. CL. 42. (U.S. CLS. 100 AND 101). REG. 8-17-1999.
- 2,271,534. MECL. INT. CL. 35. (U.S. CLS. 100, 101 AND 102). REG. 8-24-1999.
- 2,271,957. DECA AN ASSOCIATION OF MARKETING STUDENTS AND DESIGN. INT. CL. (U.S. CLS.). U.S. CL. 200. REG. 8-24-1999.
- 2,272,875. INTOWN SUITES AND DESIGN. INT. CL. 42. (U.S. CLS. 100 AND 101). REG. 8-24-1999.
- 2,272,927. WRAP ART. INT. CL. 22. (U.S. CLS. 1, 2, 7, 19, 22, 42 AND 50). REG. 8-24-1999.
- 2,273,959. FAST ACTION. INT. CL. 3. (U.S. CLS. 1, 4, 6, 50, 51 AND 52). REG. 8-31-1999.
- 2,274,165. ENER-LYTE. INT. CL. 5. (U.S. CLS. 6, 18, 44, 46, 51 AND 52). REG. 8-31-1999.
- 2,275,636. PVS NET. INT. CL. 9. (U.S. CLS. 21, 23, 26, 36 AND 38). REG. 9-7-1999.
- 2,275,700. SUPERCCELL. INT. CL. 7. (U.S. CLS. 13, 19, 21, 23, 31, 34 AND 35). REG. 9-7-1999.
- 2,277,807. GOTHRU. INT. CL. 8. (U.S. CLS. 23, 28 AND 44). REG. 9-14-1999.
- 2,279,026. C-WALK. INT. CL. 10. (U.S. CLS. 26, 39 AND 44). REG. 9-21-1999.
- 2,279,082. DURAWEAWE. INT. CL. 24. (U.S. CLS. 42 AND 50). REG. 9-21-1999.
- 2,279,368. YOU CAN DEPEND ON PROTECTIVE. INT. CL. 36. (U.S. CLS. 100, 101 AND 102). REG. 9-21-1999.
- 2,280,457. COMSO. INT. CL. 42. (U.S. CLS. 100 AND 101). REG. 9-28-1999.
- 2,280,665. OX-OUT. INT. CL. 3. (U.S. CLS. 1, 4, 6, 50, 51 AND 52). REG. 9-28-1999.
- 2,280,843. FOXY'S. INT. CL. 41. (U.S. CLS. 100, 101 AND 107). REG. 9-28-1999.
- 2,280,927. C-LEG. INT. CL. 10. (U.S. CLS. 26, 39 AND 44). REG. 9-28-1999.
- 2,281,045. CARLSON. INT. CL. 3. (U.S. CLS. 1, 4, 6, 50, 51 AND 52). REG. 9-28-1999.
- 2,281,088. WEATHER STICKER. INT. CL. 42. (U.S. CLS. 100 AND 101). REG. 9-28-1999.
- 2,281,354. SUCCESSFUL EVENTS. INT. CL. 42. (U.S. CLS. 100 AND 101). REG. 9-28-1999.
- 2,281,433. R EQUAL (STYLIZED). INT. CL. 20 ONLY. (U.S. CLS. 2, 13, 22, 25, 32 AND 50). REG. 9-28-1999.
- 2,281,718. SHRIMP ON THE HALF-SHELL. INT. CL. 29. (U.S. CL. 46). REG. 9-28-1999.
- 2,283,586. WCOMPVISON. INT. CL. 9. (U.S. CLS. 21, 23, 26, 36 AND 38). REG. 10-5-1999.
- 2,283,624. 76 AND DESIGN. INT. CL. 16. (U.S. CLS. 2, 5, 22, 23, 29, 37, 38 AND 50). REG. 10-5-1999.
- 2,283,625. 76 AND DESIGN. INT. CL. 25. (U.S. CLS. 22 AND 39). REG. 10-5-1999.
- 2,283,626. NETS AND DESIGN. INT. CL. 18. (U.S. CLS. 1, 2, 3, 22 AND 41). REG. 10-5-1999.
- 2,284,072. THE ORIGINAL MUCK BOOT COMPANY AND DESIGN. INT. CL. 25. (U.S. CLS. 22 AND 39). REG. 10-5-1999.
- 2,286,604. D AND DESIGN. INT. CL. 41. (U.S. CLS. 100, 101 AND 107). REG. 10-12-1999.
- 2,287,624. HYDRO-LANCE. INT. CL. 11. (U.S. CLS. 13, 21, 23, 31 AND 34). REG. 10-19-1999.
- 2,287,852. NEUTROPHIL PLUS. INT. CL. 5. (U.S. CLS. 6, 18, 44, 46, 51 AND 52). REG. 10-19-1999.
- 2,288,601. DATACAST. INT. CL. 42. (U.S. CLS. 100 AND 101). REG. 10-26-1999.
- 2,289,015. KERNEL SEASON'S. INT. CL. 30. (U.S. CL. 46). REG. 10-26-1999.
- 2,289,062. CROSSBOW. INT. CL. 3. (U.S. CLS. 1, 4, 6, 50, 51 AND 52). REG. 10-26-1999.
- 2,290,262. NUTRA-SUPPORT. INT. CL. 5. (U.S. CLS. 6, 18, 44, 46, 51 AND 52). REG. 11-2-1999.
- 2,290,589. APPLE ZINGS. INT. CL. 30. (U.S. CL. 46). REG. 11-2-1999.
- 2,291,187. MEAT MATE (STYLIZED). INT. CL. 30. (U.S. CL. 46). REG. 11-9-1999.
- 2,291,271. BESTPOSSIBLE. INT. CL. 42. (U.S. CLS. 100 AND 101). REG. 11-9-1999.
- 2,291,503. GLUTATHIONE BOOSTER. INT. CL. 5. (U.S. CLS. 6, 18, 44, 46, 51 AND 52). REG. 11-9-1999.
- 2,291,885. MIGHTY MANGO. INT. CL. 32. (U.S. CLS. 45, 46 AND 48). REG. 11-16-1999.
- 2,291,909. FRED TALLEY'S. INT. CL. 42. (U.S. CLS. 100 AND 101). REG. 11-16-1999.
- 2,292,338. CCP. U.S. CL. B. REG. 11-16-1999.
- 2,292,705. PRO EDI AND DESIGN. INT. CL. 9. (U.S. CLS. 21, 23, 26, 36 AND 38). REG. 11-16-1999.
- 2,293,238. HENNEPIN. INT. CL. 32. (U.S. CLS. 45, 46 AND 48). REG. 11-16-1999.
- 2,293,768. RUTHERFORD HILLSIDE RESERVE. INT. CL. 33. (U.S. CLS. 47 AND 49). REG. 11-16-1999.
- 2,293,865. SURE-WRAP. INT. CL. 10. (U.S. CLS. 26, 39 AND 44). REG. 11-23-1999.
- 2,294,633. REVOLUTION. INT. CL. 5. (U.S. CLS. 6, 18, 44, 46, 51 AND 52). REG. 11-23-1999.
- 2,295,113. ADD-A-ZONE. INT. CL. 9. (U.S. CLS. 21, 23, 26, 36 AND 38). REG. 11-30-1999.
- 2,296,096. APEX 2000. INT. CL. 16. (U.S. CLS. 2, 5, 22, 23, 29, 37, 38 AND 50). REG. 11-30-1999.
- 2,296,130. SKILCRAFT. INT. CL. 8. (U.S. CLS. 23, 28 AND 44). REG. 11-30-1999.
- 2,296,131. SKILCRAFT. INT. CL. 5. (U.S. CLS. 6, 18, 44, 46, 51 AND 52). REG. 11-30-1999.
- 2,296,342. ZENIQUIN. INT. CL. 5. (U.S. CLS. 6, 18, 44, 46, 51 AND 52). REG. 11-30-1999.
- 2,296,428. BOSTON MILLENNIA PARTNERS. INT. CL. 36. (U.S. CLS. 100, 101 AND 102). REG. 11-30-1999.
- 2,297,683. THE WEATHER UNDERGROUND. INT. CL. 42. (U.S. CLS. 100 AND 101). REG. 12-7-1999.
- 2,297,936. POWER PLANTER. INT. CL. 7. (U.S. CLS. 13, 19, 21, 23, 31, 34 AND 35). REG. 12-7-1999.
- 2,298,331. GUITTARD. INT. CL. 30. (U.S. CL. 46). REG. 12-7-1999.

* * * * *

TRADEMARK REGISTRATIONS CANCELED

The designation "U.S. Cl." appearing in this section refers to the U.S. class in effect prior to Sep. 1, 1973 rather than the international class which applies to applications filed on or after that date. For adoption of international classification see notice in the OFFICIAL GAZETTE of Jun. 26, 1973 (911 O.G. TM 210).

SECTION 7(D)

- 1,391,849. FIDELITY UNION LIFE AND DESIGN. INT. CL. 36. REG. 4-29-1986.
2,827,355. GUARDIAN ANGEL. INT. CL. 36. REG. 3-30-2004.
3,283,902. INSIGNIA STANDARD CHARACTER MARK INT. CL. 29. REG. 8-21-2007.
3,315,437. TEMPERFLOW STANDARD CHARACTER MARK INT. CL. 20. REG. 10-23-2007.

SECTION 8

- 1,091,464. TRU. INT. CL. 25. REG. 5-16-1978.
1,099,267. S AND DESIGN. INT. CLS. 7 AND 20 ONLY. REG. 8-15-1978.
1,105,291. OC OFFICE COURT AND DESIGN. INT. CLS. 37 AND 42 ONLY. REG. 10-31-1978.
1,105,776. OFFICE COURT. INT. CLS. 37 AND 42 ONLY. REG. 11-7-1978.
1,107,248. MISCELLANEOUS DESIGN. INT. CL. 16 ONLY. REG. 11-28-1978.
1,480,310. ONYX. INT. CL. 1. REG. 3-15-1988.
1,480,312. RE ACT. INT. CL. 1. REG. 3-15-1988.
1,480,315. BATESVILLE MARBLE. INT. CL. 1. REG. 3-15-1988.
1,480,317. ULTRA-KOR. INT. CL. 1. REG. 3-15-1988.
1,480,319. BIOCRYL. INT. CL. 1. REG. 3-15-1988.
1,480,331. AQUA GUM. INT. CL. 1. REG. 3-15-1988.
1,480,332. IMCERA. INT. CL. 1. REG. 3-15-1988.
1,480,335. MINUTE DE-ICER. INT. CL. 1. REG. 3-15-1988.
1,480,344. HORSEY-SET PRODUCTS AND DESIGN. INT. CL. 2. REG. 3-15-1988.
1,480,349. IRON. INT. CL. 3. REG. 3-15-1988.
1,480,354. LUSTRE MAGIC. INT. CL. 3. REG. 3-15-1988.
1,480,371. SIAI AND DESIGN. INT. CL. 3. REG. 3-15-1988.
1,480,377. CULTIVATOR AND DESIGN. INT. CL. 3. REG. 3-15-1988.
1,480,382. F-239. INT. CL. 3. REG. 3-15-1988.
1,480,385. MISCELLANEOUS DESIGN. INT. CL. 3. REG. 3-15-1988.
1,480,389. MISCELLANEOUS DESIGN. INT. CL. 3. REG. 3-15-1988.
1,480,390. POLACLEAR. INT. CL. 3. REG. 3-15-1988.
1,480,393. SH. INT. CL. 4. REG. 3-15-1988.
1,480,394. CODY'S AND DESIGN. INT. CL. 4. REG. 3-15-1988.
1,480,395. MULTITEST CMI. INT. CL. 5. REG. 3-15-1988.
1,480,397. BARYTGEN. INT. CL. 5. REG. 3-15-1988.
1,480,398. RICOLA NATURAL HERB COUGH DROPS SOOTHES THE THROAT - RELIEVES COUGHS NATURALLY WITH 100% NATURAL HERBS FROM SWITZERLAND AND DESIGN. INT. CLS. 5 AND 30. REG. 3-15-1988.
1,480,404. RUG AROMA. INT. CL. 5. REG. 3-15-1988.
1,480,405. GRADE AID. INT. CL. 5. REG. 3-15-1988.
1,480,415. MRS. GOOCH'S AND DESIGN. INT. CLS. 5, 16, 25, 29, 30, 31 AND 32. REG. 3-15-1988.
1,480,416. S AND DESIGN. INT. CL. 5. REG. 3-15-1988.
1,480,417. SUPERTWIN. INT. CL. 5. REG. 3-15-1988.
1,480,427. WE CAN HELP YOU LOVE YOUR LENSES. INT. CL. 5. REG. 3-15-1988.
1,480,432. RAPIDOL. INT. CL. 5. REG. 3-15-1988.
1,480,436. MISCELLANEOUS DESIGN. INT. CL. 5. REG. 3-15-1988.
1,480,441. HARRISON ALLOYS INC. HA AND DESIGN. INT. CLS. 6 AND 9. REG. 3-15-1988.
1,480,442. TUFLITE (STYLIZED). INT. CL. 6. REG. 3-15-1988.
1,480,454. SPIRA-DISC. INT. CL. 7. REG. 3-15-1988.
1,480,455. LIFT CONVEYOR AND DESIGN. INT. CL. 7. REG. 3-15-1988.
1,480,466. BUR-BEAVER. INT. CL. 7. REG. 3-15-1988.
1,480,467. TAIMATRON. INT. CLS. 7 AND 9. REG. 3-15-1988.
1,480,469. GOOD WILL AND DESIGN. INT. CL. 7. REG. 3-15-1988.
1,480,472. POWERPUMP. INT. CL. 7. REG. 3-15-1988.
1,480,476. W AND DESIGN. INT. CL. 7. REG. 3-15-1988.
1,480,477. POLYSPEDE (STYLIZED). INT. CL. 7. REG. 3-15-1988.
1,480,482. BENACO. INT. CL. 7. REG. 3-15-1988.
1,480,487. FLYING ARROW AND DESIGN. INT. CLS. 8 AND 9. REG. 3-15-1988.
1,480,493. TECTYL. INT. CLS. 8, 25 AND 34. REG. 3-15-1988.
1,480,494. CEMENTEX. INT. CLS. 8 AND 40. REG. 3-15-1988.
1,480,496. YELLOW TAILS. INT. CL. 8. REG. 3-15-1988.
1,480,503. OTEC. INT. CL. 9. REG. 3-15-1988.
1,480,505. INTELLIGENT MEDICAL SYSTEMS. INT. CL. 9. REG. 3-15-1988.
1,480,506. COMPUTER ASSOCIATES (STYLIZED). INT. CL. 9. REG. 3-15-1988.
1,480,511. KRAFT (STYLIZED). INT. CL. 9. REG. 3-15-1988.
1,480,520. OMS (STYLIZED). INT. CL. 9. REG. 3-15-1988.
1,480,522. EZC EXTRA. INT. CL. 9. REG. 3-15-1988.
1,480,523. LUTH INTERNATIONAL AND DESIGN. INT. CL. 9. REG. 3-15-1988.
1,480,527. FACE SAVER. INT. CL. 9. REG. 3-15-1988.
1,480,539. MINICOM. INT. CL. 9. REG. 3-15-1988.
1,480,541. CONCEPTSTATION (STYLIZED). INT. CL. 9. REG. 3-15-1988.
1,480,552. CYLINK. INT. CL. 9. REG. 3-15-1988.
1,480,553. ROLLAWAY. INT. CL. 9. REG. 3-15-1988.
1,480,558. VAC-TEC (STYLIZED). INT. CL. 9. REG. 3-15-1988.
1,480,559. C-POWER AND DESIGN. INT. CL. 9. REG. 3-15-1988.
1,480,563. MAURICE BOLLE (STYLIZED). INT. CL. 9. REG. 3-15-1988.
1,480,565. MICRO-MAGNETIC. INT. CL. 9. REG. 3-15-1988.
1,480,566. MANIFOLD TECHNOLOGY. INT. CL. 9. REG. 3-15-1988.
1,480,567. DARA. INT. CL. 9. REG. 3-15-1988.
1,480,568. NBI (STYLIZED). INT. CL. 9. REG. 3-15-1988.
1,480,570. RANGING. INT. CL. 9. REG. 3-15-1988.
1,480,572. TRUE SOUND AND DESIGN. INT. CL. 9. REG. 3-15-1988.
1,480,575. DRAGONWRITER. INT. CL. 9. REG. 3-15-1988.
1,480,577. ONE TOUCH. INT. CL. 9. REG. 3-15-1988.
1,480,578. BLUE CHIP SOFTWARE. INT. CL. 9. REG. 3-15-1988.
1,480,584. PETROFLEX. INT. CL. 9. REG. 3-15-1988.

- 1,480,586. CHURCH TRAC C AND DESIGN. INT. CL. 9. REG. 3-15-1988.
- 1,480,594. CONWAY ENGINEERING. INT. CL. 9. REG. 3-15-1988.
- 1,480,598. COMTRAN. INT. CL. 9. REG. 3-15-1988.
- 1,480,599. MULTI-MEDIA MANEUVER. INT. CL. 9. REG. 3-15-1988.
- 1,480,603. JOINT CALL. INT. CL. 9. REG. 3-15-1988.
- 1,480,604. XYDOC. INT. CL. 9. REG. 3-15-1988.
- 1,480,606. JAMES DEAN. INT. CL. 9. REG. 3-15-1988.
- 1,480,608. SKILMATCH AND DESIGN. INT. CL. 9. REG. 3-15-1988.
- 1,480,617. JAMES DEAN AND DESIGN. INT. CL. 9. REG. 3-15-1988.
- 1,480,622. EI AND DESIGN. INT. CL. 9. REG. 3-15-1988.
- 1,480,632. CURTIS. INT. CL. 9. REG. 3-15-1988.
- 1,480,646. TECHWOOD. INT. CL. 9. REG. 3-15-1988.
- 1,480,647. IMHEX. INT. CL. 9. REG. 3-15-1988.
- 1,480,648. EVERALERT. INT. CL. 9. REG. 3-15-1988.
- 1,480,649. ORCHESTRADE. INT. CL. 9. REG. 3-15-1988.
- 1,480,650. GRAPHVIEW. INT. CL. 9. REG. 3-15-1988.
- 1,480,651. AGENT ACCESS. INT. CL. 9. REG. 3-15-1988.
- 1,480,658. MISCELLANEOUS DESIGN. INT. CL. 9. REG. 3-15-1988.
- 1,480,661. RUSTRONIC AND DESIGN. INT. CL. 9. REG. 3-15-1988.
- 1,480,675. MALVERN (STYLIZED). INT. CL. 9. REG. 3-15-1988.
- 1,480,678. GMIC. INT. CL. 9. REG. 3-15-1988.
- 1,480,679. GVAC. INT. CL. 9. REG. 3-15-1988.
- 1,480,685. BHSM. INT. CL. 9. REG. 3-15-1988.
- 1,480,688. USMC (STYLIZED). INT. CL. 10. REG. 3-15-1988.
- 1,480,697. ACTIVE-SHIELD. INT. CL. 10. REG. 3-15-1988.
- 1,480,698. PETSIELD. INT. CL. 10. REG. 3-15-1988.
- 1,480,701. NUCLEOTOME AND DESIGN. INT. CL. 10. REG. 3-15-1988.
- 1,480,705. INTRO-FLEX. INT. CL. 10. REG. 3-15-1988.
- 1,480,707. SABER. INT. CL. 10. REG. 3-15-1988.
- 1,480,718. EIKO AND DESIGN. INT. CL. 11. REG. 3-15-1988.
- 1,480,719. SAMSON JUNIOR. INT. CL. 11. REG. 3-15-1988.
- 1,480,727. GENESIS. INT. CL. 12. REG. 3-15-1988.
- 1,480,730. BP BIAS PLY (STYLIZED). INT. CL. 12. REG. 3-15-1988.
- 1,480,737. ATLAS A/R RADIAL. INT. CL. 12. REG. 3-15-1988.
- 1,480,740. BECAUSE SO MUCH IS RIDING ON YOUR TIRES. INT. CL. 12. REG. 3-15-1988.
- 1,480,742. MITSUBA. INT. CL. 12. REG. 3-15-1988.
- 1,480,743. PUMA. INT. CL. 12. REG. 3-15-1988.
- 1,480,744. COUGAR. INT. CL. 12. REG. 3-15-1988.
- 1,480,746. FORTIS HARWOOD AND DESIGN. INT. CL. 14. REG. 3-15-1988.
- 1,480,747. 1 STAR CREDIT (STYLIZED). INT. CL. 14. REG. 3-15-1988.
- 1,480,750. THE LEGEND OF BACCHUS. INT. CL. 14. REG. 3-15-1988.
- 1,480,757. DIRECT LINE AND DESIGN. INT. CL. 16. REG. 3-15-1988.
- 1,480,760. STORIES THAT LIVE AND DESIGN. INT. CL. 16. REG. 3-15-1988.
- 1,480,762. DYNIS. INT. CLS. 16 AND 42. REG. 3-15-1988.
- 1,480,765. SELTEL (STYLIZED). INT. CLS. 16, 35 AND 41. REG. 3-15-1988.
- 1,480,769. DRAGONWRITER. INT. CL. 16. REG. 3-15-1988.
- 1,480,770. DRAGON SYSTEMS. INT. CL. 16. REG. 3-15-1988.
- 1,480,772. TORK AND DESIGN. INT. CLS. 16 AND 21. REG. 3-15-1988.
- 1,480,774. GOLD C VALUES. INT. CL. 16. REG. 3-15-1988.
- 1,480,776. PAPERWARE. INT. CL. 16. REG. 3-15-1988.
- 1,480,777. PHOTIQUE. INT. CL. 16. REG. 3-15-1988.
- 1,480,780. YOUR PRINTING SOLUTION. INT. CL. 16. REG. 3-15-1988.
- 1,480,781. ALERT LINE. INT. CL. 16. REG. 3-15-1988.
- 1,480,782. INSPIRATIONAL PRESS IP AND DESIGN. INT. CL. 16. REG. 3-15-1988.
- 1,480,787. PADSTAT. INT. CL. 16. REG. 3-15-1988.
- 1,480,788. Z AND DESIGN. INT. CL. 16. REG. 3-15-1988.
- 1,480,792. FP AND DESIGN. INT. CL. 16. REG. 3-15-1988.
- 1,480,793. SCANTEMP. INT. CL. 16. REG. 3-15-1988.
- 1,480,802. WEI. INT. CL. 17. REG. 3-15-1988.
- 1,480,803. CROSS TUFF. INT. CL. 17. REG. 3-15-1988.
- 1,480,805. ANDE (STYLIZED). INT. CL. 18. REG. 3-15-1988.
- 1,480,814. METROMAC. INT. CL. 19. REG. 3-15-1988.
- 1,480,816. GREAT SHAPES. INT. CL. 19. REG. 3-15-1988.
- 1,480,817. HOMEFREE. INT. CL. 19. REG. 3-15-1988.
- 1,480,819. WHITTTLER'S MOTHER. INT. CL. 20. REG. 3-15-1988.
- 1,480,820. KINDEROCKER. INT. CL. 20. REG. 3-15-1988.
- 1,480,821. THE HIP BED AND DESIGN. INT. CL. 20. REG. 3-15-1988.
- 1,480,825. LIL' ANGEL BASSINETS. INT. CL. 20. REG. 3-15-1988.
- 1,480,826. CELEBRITY. INT. CL. 20. REG. 3-15-1988.
- 1,480,827. FAS'NER AND DESIGN. INT. CL. 20. REG. 3-15-1988.
- 1,480,830. ONE OF A KIND AND DESIGN. INT. CL. 20. REG. 3-15-1988.
- 1,480,833. 1838 TIRSCHENREUTH BAVARIA AND DESIGN. INT. CL. 21. REG. 3-15-1988.
- 1,480,837. CRISP-E-DISH. INT. CL. 21. REG. 3-15-1988.
- 1,480,839. DRINK CHILL. INT. CL. 21. REG. 3-15-1988.
- 1,480,841. THE PROFESSIONAL. INT. CL. 21. REG. 3-15-1988.
- 1,480,845. ACCENTS. INT. CL. 21. REG. 3-15-1988.
- 1,480,847. SPC (STYLIZED). INT. CL. 22. REG. 3-15-1988.
- 1,480,849. CROWN-FLEXXX. INT. CL. 24. REG. 3-15-1988.
- 1,480,853. MISCELLANEOUS DESIGN. INT. CL. 25. REG. 3-15-1988.
- 1,480,864. KAREN KANE SKETCHBOOK. INT. CL. 25. REG. 3-15-1988.
- 1,480,865. MISCELLANEOUS DESIGN. INT. CL. 25. REG. 3-15-1988.
- 1,480,878. ESLEEP (STYLIZED). INT. CL. 25. REG. 3-15-1988.
- 1,480,879. DA-GUYZ. INT. CL. 25. REG. 3-15-1988.
- 1,480,880. DA-KIDZ. INT. CL. 25. REG. 3-15-1988.
- 1,480,881. KITCHEN & BATH DELIGHTS (STYLIZED). INT. CL. 27. REG. 3-15-1988.
- 1,480,884. THE MASTERS COLLECTION AND DESIGN. INT. CL. 27. REG. 3-15-1988.
- 1,480,891. ODYSSEE. INT. CL. 28. REG. 3-15-1988.
- 1,480,900. R ROYAL AND DESIGN. INT. CL. 28. REG. 3-15-1988.
- 1,480,920. OLD FASHIONED AND PROUD OF IT. INT. CL. 29. REG. 3-15-1988.
- 1,480,923. SNAPPYS. INT. CL. 29. REG. 3-15-1988.
- 1,480,933. HEART'S WHEY. INT. CL. 29. REG. 3-15-1988.
- 1,480,939. HICKORY HAMS AND DESIGN. INT. CL. 29. REG. 3-15-1988.
- 1,480,942. WESTWOOD. INT. CL. 29. REG. 3-15-1988.
- 1,480,946. SPRING VALLEY FARMS. INT. CL. 29. REG. 3-15-1988.
- 1,480,951. HOLIDAYS. INT. CL. 30. REG. 3-15-1988.
- 1,480,952. COCO D'OR AND DESIGN. INT. CL. 30. REG. 3-15-1988.
- 1,480,954. ROMAN. INT. CL. 30. REG. 3-15-1988.
- 1,480,961. AM PM MINI MARKET AND DESIGN. INT. CL. 30. REG. 3-15-1988.
- 1,480,963. SLENDER GOURMET. INT. CLS. 30 AND 42. REG. 3-15-1988.
- 1,480,965. CRISMINTS. INT. CL. 30. REG. 3-15-1988.
- 1,480,971. POTEET TEXAS STRAWBERRY AND DESIGN. INT. CL. 30. REG. 3-15-1988.
- 1,480,974. GOD BLESS YOU.. INT. CL. 30. REG. 3-15-1988.
- 1,480,976. BROAD STREET BAKERY AND DESIGN. INT. CL. 30. REG. 3-15-1988.
- 1,480,982. DB AND DESIGN. INT. CL. 30. REG. 3-15-1988.
- 1,480,984. SUPER BUNNY SB AND DESIGN. INT. CL. 31. REG. 3-15-1988.
- 1,480,986. PANAMA GOLD AND DESIGN. INT. CL. 31. REG. 3-15-1988.
- 1,480,989. FRANKLIN GROVES AND DESIGN. INT. CL. 32. REG. 3-15-1988.
- 1,480,998. NATURAL UTOPIA AND PURE AND DESIGN. INT. CL. 32. REG. 3-15-1988.
- 1,481,000. "HOW ABOUT A NICE HAWAIIAN PUNCH?". INT. CL. 32. REG. 3-15-1988.
- 1,481,004. PAUL DUGENAI. INT. CL. 33. REG. 3-15-1988.

- 1,481,005. LIFE IS TOO SHORT TO BE BORED BY YOUR 'USUAL'. INT. CL. 33. REG. 3-15-1988.
- 1,481,010. SUNHEALTH. INT. CLS. 35, 41 AND 42. REG. 3-15-1988.
- 1,481,022. CONTRACT APPAREL NETWORK (STYLIZED). INT. CL. 35. REG. 3-15-1988.
- 1,481,024. C-TEC (STYLIZED). INT. CLS. 35, 37, 38 AND 42. REG. 3-15-1988.
- 1,481,026. THE LOCAL FIRM WITH A NATIONAL REPUTATION. INT. CL. 35. REG. 3-15-1988.
- 1,481,027. SEA LIFE OUR WAY AND DESIGN. INT. CL. 35. REG. 3-15-1988.
- 1,481,028. ASSIST. INT. CL. 35. REG. 3-15-1988.
- 1,481,035. KAHN MANIERRE. INT. CL. 36. REG. 3-15-1988.
- 1,481,039. MISCELLANEOUS DESIGN. INT. CL. 36. REG. 3-15-1988.
- 1,481,040. FIDELITY INVESTMENTS AND DESIGN. INT. CL. 36. REG. 3-15-1988.
- 1,481,041. THE SEED CORPS. INT. CL. 36. REG. 3-15-1988.
- 1,481,042. USA FEDERAL CREDIT UNION AND DESIGN. INT. CL. 36. REG. 3-15-1988.
- 1,481,046. BARRISTERS CLUB. INT. CL. 36. REG. 3-15-1988.
- 1,481,047. TRANSITION COVERAGE. INT. CL. 36. REG. 3-15-1988.
- 1,481,052. RIVERCENTER (STYLIZED). INT. CL. 36. REG. 3-15-1988.
- 1,481,053. R RIVERCENTER AND DESIGN. INT. CL. 36. REG. 3-15-1988.
- 1,481,056. PARTNERS IN SAFETY RANGER INSURANCE AND DESIGN. INT. CL. 36. REG. 3-15-1988.
- 1,481,058. WHITE EAGLE EST. 1911 AND DESIGN. INT. CL. 36. REG. 3-15-1988.
- 1,481,065. TROWELON. INT. CL. 37. REG. 3-15-1988.
- 1,481,067. PCB-GONE. INT. CL. 37. REG. 3-15-1988.
- 1,481,075. APT (STYLIZED). INT. CL. 38. REG. 3-15-1988.
- 1,481,080. WUPR. INT. CL. 38. REG. 3-15-1988.
- 1,481,082. KZFX. INT. CL. 38. REG. 3-15-1988.
- 1,481,087. COSMOS. INT. CL. 39. REG. 3-15-1988.
- 1,481,092. LAST CALL. INT. CL. 39. REG. 3-15-1988.
- 1,481,101. "GIVING FINANCIAL PLANNERS A COMPETITIVE EDGE". INT. CL. 41. REG. 3-15-1988.
- 1,481,106. MERRYHILL COUNTRY SCHOOL. INT. CL. 41. REG. 3-15-1988.
- 1,481,111. HAR-TECH AND DESIGN. INT. CL. 41. REG. 3-15-1988.
- 1,481,112. MISCELLANEOUS DESIGN. INT. CL. 41. REG. 3-15-1988.
- 1,481,116. J.PAUL'S A DINING SALOON AND DESIGN. INT. CL. 42. REG. 3-15-1988.
- 1,481,120. THEY KNOW ME AT APPLEBEE'S (STYLIZED). INT. CL. 42. REG. 3-15-1988.
- 1,481,135. SHEPHERDS OF AUSTRALIA. INT. CL. 42. REG. 3-15-1988.
- 1,481,136. PRINTERS PLUS AND DESIGN. INT. CL. 42. REG. 3-15-1988.
- 1,481,137. SUPERCARE. INT. CL. 42. REG. 3-15-1988.
- 1,481,141. MEMS (STYLIZED). INT. CL. 42. REG. 3-15-1988.
- 1,481,150. BREAKATIONS. INT. CL. 42. REG. 3-15-1988.
- 1,481,156. HIGH-TECH SEARCH. INT. CL. 42. REG. 3-15-1988.
- 1,481,157. RAM DYNAMICS. INT. CL. 42. REG. 3-15-1988.
- 1,481,166. LITSEARCH. INT. CL. 42. REG. 3-15-1988.
- 1,481,167. QC-MED. INT. CL. 42. REG. 3-15-1988.
- 1,481,176. N AND DESIGN. INT. CL. 42. REG. 3-15-1988.
- 1,481,180. PUFFIN' BILLY'S HAMBURGERS AND DESIGN. INT. CL. 42. REG. 3-15-1988.
- 1,481,181. COLONIAL SPORTSHOE CENTER. INT. CL. 42. REG. 3-15-1988.
- 1,481,183. B.B.Q'S GALORE. INT. CL. 42. REG. 3-15-1988.
- 1,481,185. MISCELLANEOUS DESIGN. U.S. CL. 200. REG. 3-15-1988.
- 1,481,190. POWERPOST. INT. CL. 9. REG. 3-15-1988.
- 1,481,191. U.S. GASLIGHT. INT. CL. 11. REG. 3-15-1988.
- 1,481,194. DESIGNER HOME PLANS. INT. CL. 16. REG. 3-15-1988.
- 1,481,199. HOMESTYLE. INT. CL. 30. REG. 3-15-1988.
- 1,481,206. PROFESSIONAL SECRETARIES WEEK. INT. CL. 42. REG. 3-15-1988.
- 1,481,209. POWER DRIVES. INT. CL. 42. REG. 3-15-1988.
- 1,489,393. CUDDLE TIME. INT. CL. 25 ONLY. REG. 5-24-1988.
- 1,513,367. PAGEWRIter (STYLIZED). INT. CL. 9 ONLY. REG. 11-22-1988.
- 1,706,955. CUSTOM SURF SERIES (STYLIZED). INT. CL. 28. REG. 8-11-1992.
- 2,045,625. WOLF AND COHEN. INT. CL. 36. REG. 3-18-1997.
- 2,125,112. VAL GLO. INT. CL. 16. REG. 12-30-1997.
- 2,143,772. SS (STYLIZED). INT. CL. 5. REG. 3-17-1998.
- 2,143,783. NCLEX-RN. INT. CL. 9. REG. 3-17-1998.
- 2,143,801. NORSTAN'S OPTIMA PLUS. INT. CL. 38. REG. 3-17-1998.
- 2,143,804. CARDINALS CORRAL. INT. CL. 42. REG. 3-17-1998.
- 2,143,812. SPEEDSTER. INT. CL. 3. REG. 3-17-1998.
- 2,143,829. Z ZELLWEGER ANALYTICS AND DESIGN. INT. CL. 9. REG. 3-17-1998.
- 2,143,835. MISCELLANEOUS DESIGN. INT. CL. 7. REG. 3-17-1998.
- 2,143,840. ULTIMA AND DESIGN. INT. CL. 7. REG. 3-17-1998.
- 2,143,843. FNI AND DESIGN. INT. CL. 17. REG. 3-17-1998.
- 2,143,857. NUCLEAR MEDICINE MANAGER. INT. CL. 9. REG. 3-17-1998.
- 2,143,858. CZECHOSLOVAKIAN ORIGINAL LAGER BEER AND DESIGN. INT. CL. 32. REG. 3-17-1998.
- 2,143,881. CREATING COOL. INT. CL. 16. REG. 3-17-1998.
- 2,143,887. CAPITAL BUSINESS CREDIT. INT. CL. 36. REG. 3-17-1998.
- 2,143,892. RENT NET. INT. CL. 42. REG. 3-17-1998.
- 2,143,919. CANDLESHTICK AND DESIGN. INT. CL. 4. REG. 3-17-1998.
- 2,143,932. GREENBEST. INT. CLS. 9 AND 21. REG. 3-17-1998.
- 2,143,939. HEAVENLY ELECTRONICS. INT. CL. 9. REG. 3-17-1998.
- 2,143,944. SAFEFIT AND DESIGN. INT. CL. 12. REG. 3-17-1998.
- 2,143,946. TRAVELER'S EMERGENCY NETWORK TEN AND DESIGN. INT. CL. 39. REG. 3-17-1998.
- 2,143,950. 2NIGHT AND DESIGN. INT. CL. 41. REG. 3-17-1998.
- 2,143,953. BAYKAL. INT. CL. 7. REG. 3-17-1998.
- 2,143,958. LYRIS. INT. CL. 9. REG. 3-17-1998.
- 2,143,986. ADDTRON AND DESIGN. INT. CL. 9. REG. 3-17-1998.
- 2,143,991. LIVEWIRE YOUR LINK TO NEWS..AS IT HAPPENS AND DESIGN. INT. CL. 9. REG. 3-17-1998.
- 2,143,995. INTRAMALL. INT. CL. 35. REG. 3-17-1998.
- 2,144,001. PAGEMART. INT. CL. 9. REG. 3-17-1998.
- 2,144,004. CRESTECH. INT. CL. 9. REG. 3-17-1998.
- 2,144,005. SOMNOTRAC. INT. CL. 10. REG. 3-17-1998.
- 2,144,017. CIPO. INT. CL. 36. REG. 3-17-1998.
- 2,144,024. R TEC (STYLIZED). INT. CL. 9. REG. 3-17-1998.
- 2,144,030. WIZ DIRECT. INT. CL. 35. REG. 3-17-1998.
- 2,144,031. PRIMEVAL PROACTIVE INTEGRATED MAINTENANCE EVALUATION AND DESIGN. INT. CL. 41. REG. 3-17-1998.
- 2,144,034. COMMAND ADVANTAGE AND DESIGN. INT. CLS. 41 AND 42. REG. 3-17-1998.
- 2,144,038. FORESIGHT. INT. CL. 16. REG. 3-17-1998.
- 2,144,039. THE SOUTHERN FAIRFIELD COUNTY BODY SHOP ASSOCIATION, INC. AND DESIGN. INT. CL. 42. REG. 3-17-1998.
- 2,144,045. KINEMATE. INT. CL. 9. REG. 3-17-1998.
- 2,144,047. FIRST CHOICE. INT. CL. 35. REG. 3-17-1998.
- 2,144,048. STRONG INTERNATIONAL. INT. CLS. 9 AND 11. REG. 3-17-1998.
- 2,144,051. JOINT ENDEAVOR. INT. CL. 42. REG. 3-17-1998.
- 2,144,057. MACBOMB AND DESIGN. INT. CL. 42. REG. 3-17-1998.
- 2,144,062. 1-800-LEARN MS. INT. CL. 36. REG. 3-17-1998.
- 2,144,070. A/OGEO. INT. CL. 35. REG. 3-17-1998.
- 2,144,077. WHISTLER. INT. CL. 9. REG. 3-17-1998.
- 2,144,088. GROUTSTICK. INT. CL. 8. REG. 3-17-1998.

- 2,144,094. PERFORMANCE PUMPS. INT. CL. 7. REG. 3-17-1998.
- 2,144,099. ROTO FLO AND DESIGN. INT. CL. 7. REG. 3-17-1998.
- 2,144,111. CLEARPROOF. INT. CL. 9. REG. 3-17-1998.
- 2,144,115. ITC 55 BROAD NEW YORK INFORMATION TECHNOLOGY CENTER JUST PLUG IN! AND DESIGN. INT. CLS. 35, 36, 37, 38 AND 42. REG. 3-17-1998.
- 2,144,130. GOLDEN PEANUT. INT. CL. 29. REG. 3-17-1998.
- 2,144,144. CAMINO. INT. CLS. 19, 20 AND 24. REG. 3-17-1998.
- 2,144,146. TOOLS FOR SUCCESSFUL RETAILING!. INT. CL. 35. REG. 3-17-1998.
- 2,144,150. YOU ARE THE MAGIC AND DESIGN. INT. CL. 41. REG. 3-17-1998.
- 2,144,156. ARCO IRIS. INT. CL. 41. REG. 3-17-1998.
- 2,144,159. NEOVASTAT. INT. CL. 5. REG. 3-17-1998.
- 2,144,171. PAYLIX (STYLIZED). INT. CL. 9. REG. 3-17-1998.
- 2,144,189. CUSTOMER CONNECTION. INT. CL. 9. REG. 3-17-1998.
- 2,144,201. MAGADA INT'L AND DESIGN. INT. CLS. 9, 35 AND 41. REG. 3-17-1998.
- 2,144,206. WINTERSTICK. INT. CLS. 18 AND 25. REG. 3-17-1998.
- 2,144,219. SWEDTURN. INT. CL. 7. REG. 3-17-1998.
- 2,144,230. "THE PRODUCE TIP OF THE DAY". INT. CL. 41. REG. 3-17-1998.
- 2,144,246. DIPPIN' PIZZA. INT. CL. 30. REG. 3-17-1998.
- 2,144,258. BBI. INT. CLS. 1, 5 AND 42. REG. 3-17-1998.
- 2,144,269. THE DO SOMETHING BRICK AWARD. INT. CL. 42. REG. 3-17-1998.
- 2,144,280. COTTAGE INDUSTRY. INT. CLS. 25 AND 35. REG. 3-17-1998.
- 2,144,282. GABBAY. INT. CL. 21. REG. 3-17-1998.
- 2,144,285. TRUSTED IN THE FIELD. INT. CL. 31. REG. 3-17-1998.
- 2,144,298. SUCCESSMASTER (STYLIZED). INT. CL. 9. REG. 3-17-1998.
- 2,144,322. MISCELLANEOUS DESIGN. INT. CL. 25. REG. 3-17-1998.
- 2,144,328. H (STYLIZED). INT. CLS. 35 AND 37. REG. 3-17-1998.
- 2,144,341. DELTASOL. INT. CL. 1. REG. 3-17-1998.
- 2,144,369. R & B PACKOBAIL. INT. CL. 31. REG. 3-17-1998.
- 2,144,371. STARMATE. INT. CL. 42. REG. 3-17-1998.
- 2,144,378. LEISURE. INT. CL. 8. REG. 3-17-1998.
- 2,144,416. LOAD 'N GO. INT. CL. 39. REG. 3-17-1998.
- 2,144,417. LOAD 'N GO AND DESIGN. INT. CL. 39. REG. 3-17-1998.
- 2,144,439. SECURESMART. INT. CL. 9. REG. 3-17-1998.
- 2,144,455. MOTION ALERT. INT. CL. 11. REG. 3-17-1998.
- 2,144,464. THE HALLOWEEN ZONE. INT. CL. 35. REG. 3-17-1998.
- 2,144,473. MISCELLANEOUS DESIGN. INT. CL. 3. REG. 3-17-1998.
- 2,144,483. FITNESS FAN. INT. CL. 11. REG. 3-17-1998.
- 2,144,491. HYGLO FOR KIDS. INT. CL. 8. REG. 3-17-1998.
- 2,144,495. TV GUIDE ENTERTAINMENT NETWORK AND DESIGN. INT. CL. 42. REG. 3-17-1998.
- 2,144,526. THE WRITE WOMAN AND DESIGN. INT. CLS. 35 AND 42. REG. 3-17-1998.
- 2,144,529. ATA NET FARES. INT. CL. 39. REG. 3-17-1998.
- 2,144,539. SEAVID. INT. CLS. 9 AND 41. REG. 3-17-1998.
- 2,144,548. THE MOOSIC SUPERSTORE. INT. CL. 35. REG. 3-17-1998.
- 2,144,557. AIRDATE. INT. CL. 38. REG. 3-17-1998.
- 2,144,560. TIME:CARE. INT. CL. 9. REG. 3-17-1998.
- 2,144,563. PUT'EM PINS. INT. CL. 14. REG. 3-17-1998.
- 2,144,574. AR-LON 6100. INT. CL. 6. REG. 3-17-1998.
- 2,144,577. MIRAMAR SECURITIES, LLC. INT. CL. 36. REG. 3-17-1998.
- 2,144,581. ULTRA CROWN. INT. CL. 20. REG. 3-17-1998.
- 2,144,585. ANORANZAS (STYLIZED). INT. CL. 42. REG. 3-17-1998.
- 2,144,589. THE INITIATOR AND DESIGN. INT. CL. 36. REG. 3-17-1998.
- 2,144,598. MODIBOND. INT. CL. 19. REG. 3-17-1998.
- 2,144,599. COMMUNITY CAPITAL. INT. CL. 41. REG. 3-17-1998.
- 2,144,602. THE GOOD LIFE. INT. CL. 16. REG. 3-17-1998.
- 2,144,608. IKOS. INT. CL. 9. REG. 3-17-1998.
- 2,144,610. SILENTDRIVE (STYLIZED). INT. CL. 9. REG. 3-17-1998.
- 2,144,620. QUICK & REILLY. INT. CL. 36. REG. 3-17-1998.
- 2,144,623. AUREOLE GOOD TASTE. INT. CL. 30. REG. 3-17-1998.
- 2,144,624. ASTRA. INT. CL. 42. REG. 3-17-1998.
- 2,144,632. SUM-IT. INT. CL. 28. REG. 3-17-1998.
- 2,144,640. PLAYSONGS. INT. CL. 9. REG. 3-17-1998.
- 2,144,646. DESKJOCKEY. INT. CL. 9. REG. 3-17-1998.
- 2,144,652. REASONING ADVANTAGE. INT. CL. 42. REG. 3-17-1998.
- 2,144,656. FULLDISCLOSURE. INT. CL. 42. REG. 3-17-1998.
- 2,144,657. VICTORIA MEADOW. INT. CL. 4. REG. 3-17-1998.
- 2,144,664. HERBAL ECSTASY. INT. CL. 5. REG. 3-17-1998.
- 2,144,675. SUPREME II. INT. CL. 10. REG. 3-17-1998.
- 2,144,701. SCORPION BAY OUT THERE MAS FINA AND DESIGN. INT. CL. 32. REG. 3-17-1998.
- 2,144,704. DA CONSULTING GROUP. INT. CLS. 41 AND 42. REG. 3-17-1998.
- 2,144,706. MISCELLANEOUS DESIGN. INT. CL. 41. REG. 3-17-1998.
- 2,144,707. THE INDIAN GARDEN. INT. CL. 42. REG. 3-17-1998.
- 2,144,712. VARIL (STYLIZED). INT. CL. 9. REG. 3-17-1998.
- 2,144,716. ZUGGLESNOOKS. INT. CL. 28. REG. 3-17-1998.
- 2,144,717. S STUDIO EIGHTY-FOUR AND DESIGN. INT. CL. 20. REG. 3-17-1998.
- 2,144,729. REACHING TODAY'S STUDENTS. INT. CLS. 16 AND 41. REG. 3-17-1998.
- 2,144,734. BEST-4-BREAKFAST. INT. CL. 42. REG. 3-17-1998.
- 2,144,742. UNCLE RALPH'S MAGIC SAUCE. INT. CL. 30. REG. 3-17-1998.
- 2,144,754. MAKING IT IN AMERICA STARTS HERE AND DESIGN. INT. CL. 35. REG. 3-17-1998.
- 2,144,760. BIMINI BRONZE. INT. CL. 3. REG. 3-17-1998.
- 2,144,766. CHANGING THE WAY THE WORLD SHOPS. INT. CL. 35. REG. 3-17-1998.
- 2,144,772. WARNER'S THE NAKED TRUTH. INT. CL. 25. REG. 3-17-1998.
- 2,144,775. RUGRATS. INT. CL. 30. REG. 3-17-1998.
- 2,144,779. JOBSHIFT. INT. CL. 41. REG. 3-17-1998.
- 2,144,794. MISCELLANEOUS DESIGN. INT. CL. 28. REG. 3-17-1998.
- 2,144,796. MAGGIE BRANCH. INT. CL. 25. REG. 3-17-1998.
- 2,144,799. MISCELLANEOUS DESIGN. INT. CL. 9. REG. 3-17-1998.
- 2,144,801. NOBODY BEATS THE WIZ. INT. CLS. 9, 14, 16, 25 AND 28. REG. 3-17-1998.
- 2,144,869. CONCORD. INT. CL. 11. REG. 3-17-1998.
- 2,144,872. OPTIMUM. INT. CL. 20. REG. 3-17-1998.
- 2,144,882. NUTRI MATE. INT. CL. 9. REG. 3-17-1998.
- 2,144,887. CONTOUR FIT. INT. CL. 20. REG. 3-17-1998.
- 2,144,888. SAFETY INTERLOCK. INT. CL. 13. REG. 3-17-1998.
- 2,144,900. MAYA FOOTWEAR. INT. CL. 25. REG. 3-17-1998.
- 2,144,908. PREMAIR. INT. CL. 11. REG. 3-17-1998.
- 2,144,946. INSIDERS' GUIDE ONLINE. INT. CL. 42. REG. 3-17-1998.
- 2,144,952. STAINSHIELD. INT. CL. 1. REG. 3-17-1998.
- 2,144,955. NEXTNET. INT. CL. 35. REG. 3-17-1998.
- 2,144,968. CAPTAIN KID. INT. CL. 3. REG. 3-17-1998.
- 2,144,975. E-PAK. INT. CLS. 12 AND 37. REG. 3-17-1998.
- 2,144,976. NICKELS DELUXE. INT. CL. 9. REG. 3-17-1998.
- 2,144,978. HOMESTEAD. INT. CL. 6. REG. 3-17-1998.
- 2,144,982. KISS YOUR ICE GOODBYE. INT. CL. 1. REG. 3-17-1998.
- 2,144,983. BUDWEISER AND DESIGN. INT. CL. 21. REG. 3-17-1998.
- 2,144,988. PRIVATE LESSONS. INT. CLS. 9 AND 41. REG. 3-17-1998.
- 2,144,990. E-TAP. INT. CL. 9. REG. 3-17-1998.
- 2,144,994. ATT.NET. INT. CLS. 38 AND 42. REG. 3-17-1998.
- 2,145,000. COUPLES IN CRISIS. INT. CL. 42. REG. 3-17-1998.

- 2,145,004. G 10 AND DESIGN. INT. CL. 9. REG. 3-17-1998.
 2,145,008. HGTV HOME & GARDEN TELEVISION AND DESIGN. INT. CL. 9. REG. 3-17-1998.
 2,145,022. THE HARD SOFT DRINK. INT. CL. 33. REG. 3-17-1998.
 2,145,027. ELANTE INTERNATIONAL (STYLIZED). INT. CL. 27. REG. 3-17-1998.
 2,145,054. WATER & ENVIROSTRUCTURE INTERNATIONAL. INT. CL. 42. REG. 3-17-1998.
 2,145,055. ELITE. INT. CL. 6. REG. 3-17-1998.
 2,145,060. SECURITY FOR A CONNECTED WORLD. INT. CL. 9. REG. 3-17-1998.
 2,145,061. WILD! LIFE ADVENTURES AND DESIGN. INT. CL. 41. REG. 3-17-1998.
 2,145,062. DATA CO-OP. INT. CL. 9. REG. 3-17-1998.
 2,145,068. YOUR SALAD'S READY. INT. CL. 29. REG. 3-17-1998.
 2,145,080. AIRSHIP BRAND AND DESIGN. INT. CL. 31. REG. 3-17-1998.
 2,145,083. SAVOROME. INT. CL. 30. REG. 3-17-1998.
 2,145,085. JAPAN COMMERCE NETWORK. INT. CL. 42. REG. 3-17-1998.
 2,145,088. MISCELLANEOUS DESIGN. INT. CLS. 35 AND 41. REG. 3-17-1998.
 2,145,098. CON-WAY NOW. INT. CL. 39. REG. 3-17-1998.
 2,145,110. MISS SAIGON AND DESIGN. INT. CL. 3. REG. 3-17-1998.
 2,145,111. RAMLOC. INT. CL. 9. REG. 3-17-1998.
 2,145,117. SHIELDNET. INT. CL. 9. REG. 3-17-1998.
 2,145,126. AUTHORITY FROM MATTHEW BENDER. INT. CL. 9. REG. 3-17-1998.
 2,145,130. NAUTIC PRO. INT. CL. 4. REG. 3-17-1998.
 2,145,138. WORKFONE. INT. CL. 9. REG. 3-17-1998.
 2,145,161. TREES UP AND DESIGN. INT. CL. 28. REG. 3-17-1998.
 2,145,162. BASSCAR AND DESIGN. INT. CL. 28. REG. 3-17-1998.
 2,145,163. CPRNET. INT. CLS. 9, 41 AND 42. REG. 3-17-1998.
 2,145,168. EARTHGRAINS AND DESIGN. INT. CL. 30. REG. 3-17-1998.
 2,145,178. ERGO PEN. INT. CL. 16. REG. 3-17-1998.
 2,145,185. FRAUD SENTINEL. INT. CL. 42. REG. 3-17-1998.
 2,145,188. COLOR BY DESIGN. INT. CL. 24. REG. 3-17-1998.
 2,145,191. ACTRA. INT. CL. 25. REG. 3-17-1998.
 2,145,208. REBATEDSS. INT. CL. 9. REG. 3-17-1998.
 2,145,218. SLEEPSAFE. INT. CL. 20. REG. 3-17-1998.
 2,145,245. ROVER. INT. CL. 20. REG. 3-17-1998.
 2,145,252. FIZZ SAVER. INT. CL. 20. REG. 3-17-1998.
 2,145,277. CASE CATALYST. INT. CL. 9. REG. 3-17-1998.
 2,145,285. DREAMPORT. INT. CL. 35. REG. 3-17-1998.
 2,145,295. SUPER 40. INT. CL. 12. REG. 3-17-1998.
 2,145,312. MISCELLANEOUS DESIGN. INT. CL. 36. REG. 3-17-1998.
 2,145,318. BAYOU BLEND. INT. CL. 30. REG. 3-17-1998.
 2,145,320. FREEDOM HITCH. INT. CL. 12. REG. 3-17-1998.
 2,145,325. HARD DRIVE. INT. CL. 38. REG. 3-17-1998.
 2,145,334. VOLUNTEER. INT. CL. 38. REG. 3-17-1998.
 2,145,344. KIDS FEET. INT. CL. 42. REG. 3-17-1998.
 2,145,345. LFT. INT. CL. 36. REG. 3-17-1998.
 2,145,351. AEROBIC LOUNGE. INT. CL. 28. REG. 3-17-1998.
 2,145,356. M AND DESIGN. INT. CL. 28. REG. 3-17-1998.
 2,145,359. "TCBY" TREATS (STYLIZED). INT. CL. 30. REG. 3-17-1998.
 2,145,362. "TCBY" TREATS (STYLIZED). INT. CL. 30. REG. 3-17-1998.
 2,145,371. SYNCCAM. INT. CL. 9. REG. 3-17-1998.
 2,145,374. CARROT-BONE. INT. CL. 31. REG. 3-17-1998.
 2,145,376. HOT SHOT. INT. CL. 11. REG. 3-17-1998.
 2,145,389. FRESH POINT. INT. CL. 41. REG. 3-17-1998.
 2,145,393. LAUREL GARDENS. INT. CLS. 35, 37 AND 42. REG. 3-17-1998.
 2,145,416. DECORATE MY WORLD. INT. CL. 16. REG. 3-17-1998.
 2,145,421. BAY HARBOR. INT. CLS. 39 AND 41. REG. 3-17-1998.
 2,145,428. JOHNNIE WALKER. INT. CL. 18. REG. 3-17-1998.
 2,145,435. FRUIT FORTUNE. INT. CL. 9. REG. 3-17-1998.
 2,145,446. MISCELLANEOUS DESIGN. INT. CL. 1. REG. 3-17-1998.
 2,145,448. HOMESTEAD. INT. CL. 19. REG. 3-17-1998.
 2,145,465. SILENT RAIN. INT. CL. 25. REG. 3-17-1998.
 2,145,471. SPOON. INT. CL. 14. REG. 3-17-1998.
 2,145,472. JEWEL. INT. CL. 23. REG. 3-17-1998.
 2,145,473. SCRATCHEX SUPER SPRAY. INT. CL. 5. REG. 3-17-1998.
 2,145,484. PEANUT ROASTERS. INT. CL. 29. REG. 3-17-1998.
 2,145,486. MEGA CLUB. INT. CL. 12. REG. 3-17-1998.
 2,145,506. FLEXBGA (STYLIZED). INT. CL. 9. REG. 3-17-1998.
 2,145,509. VERMILION. INT. CL. 12. REG. 3-17-1998.
 2,145,510. LOG JAM. INT. CL. 30. REG. 3-17-1998.
 2,145,511. SPORTS BLAST. INT. CL. 32. REG. 3-17-1998.
 2,145,514. DREAMCARD. INT. CL. 36. REG. 3-17-1998.
 2,145,522. TRITECH. INT. CL. 9. REG. 3-17-1998.
 2,145,525. BANPRESTO AND DESIGN. INT. CL. 28. REG. 3-17-1998.
 2,145,531. FLORIDA SUN. INT. CL. 32. REG. 3-17-1998.
 2,145,540. JANE. INT. CL. 16. REG. 3-17-1998.
 2,145,542. MISCELLANEOUS DESIGN. INT. CLS. 3 AND 5. REG. 3-17-1998.
 2,163,258. PAWS PRESENTS. INT. CL. 9 ONLY. REG. 6-9-1998.
 2,177,795. HOMETOWN HISTORY AND DESIGN. INT. CL. 41 ONLY. REG. 8-4-1998.
 2,179,867. HOMETOWN HISTORY. INT. CL. 41 ONLY. REG. 8-11-1998.
 2,202,129. WOODS HOLE OCEANOGRAPHIC INSTITUTION 1930 AND DESIGN. INT. CL. 28 ONLY. REG. 11-3-1998.
 2,204,950. MOTOROLA. INT. CLS. 6, 8, 26 AND 28 ONLY. REG. 11-24-1998.
 2,206,385. CERASET. INT. CL. 2 ONLY. REG. 12-1-1998.
 2,210,349. ASCD. INT. CL. 38 ONLY. REG. 12-15-1998.
 2,217,949. THE BUBBLE FACTORY. INT. CLS. 9 AND 16 ONLY. REG. 1-12-1999.
 2,217,950. THE BUBBLE FACTORY AND DESIGN. INT. CLS. 9 AND 16 ONLY. REG. 1-12-1999.
 2,227,016. TRIDEL. INT. CL. 36 ONLY. REG. 3-2-1999.
 2,250,122. BEMIS AND DESIGN. INT. CLS. 19, 20 AND 21 ONLY. REG. 6-1-1999.
 2,281,433. R EQUAL (STYLIZED). INT. CL. 6 ONLY. REG. 9-28-1999.
 2,354,632. LOUISVILLE SLUGGER (STYLIZED). INT. CL. 1 ONLY. REG. 6-6-2000.
 2,396,947. MAISON LA CORNUE. INT. CLS. 8, 14, 20, 21 AND 38 ONLY. REG. 10-24-2000.
 2,523,439. D.O.G. DEPEND ON GOD. INT. CL. 6 ONLY. REG. 12-25-2001.
 2,545,486. ULTRASUN PROFESSIONAL AND DESIGN. INT. CL. 11. REG. 3-12-2002.
 2,545,487. MISCELLANEOUS DESIGN. INT. CL. 11. REG. 3-12-2002.
 2,545,488. FASTRAX. INT. CL. 28. REG. 3-12-2002.
 2,545,489. QUICK SCAN PSC AND DESIGN. INT. CL. 9. REG. 3-12-2002.
 2,545,490. C.I.S. CROSS INDUSTRIE SOFTWARE. INT. CL. 9. REG. 3-12-2002.
 2,545,491. ART OF ESPRESSO. INT. CL. 42. REG. 3-12-2002.
 2,545,492. TURBOMAX. INT. CL. 7. REG. 3-12-2002.
 2,545,497. SUMMERWIND. INT. CL. 3. REG. 3-12-2002.
 2,545,499. CATALINA. INT. CL. 9. REG. 3-12-2002.
 2,545,500. SNETQUOTE AND DESIGN. INT. CL. 35. REG. 3-12-2002.
 2,545,501. GOSIA. INT. CL. 42. REG. 3-12-2002.
 2,545,502. ALL STAR AND DESIGN. INT. CL. 1. REG. 3-12-2002.
 2,545,503. HORNSTREAM. INT. CL. 7. REG. 3-12-2002.
 2,545,504. MANTA. INT. CL. 20. REG. 3-12-2002.
 2,545,505. COAT TAIL. INT. CL. 20. REG. 3-12-2002.
 2,545,507. SMARTHIRE. INT. CL. 9. REG. 3-12-2002.
 2,545,508. TIMEHIT. INT. CL. 28. REG. 3-12-2002.
 2,545,509. TTWIN. INT. CL. 9. REG. 3-12-2002.
 2,545,510. @HOME NETWORK AND DESIGN. INT. CL. 38. REG. 3-12-2002.

- 2,545,511. STABLE SUGAR. INT. CL. 5. REG. 3-12-2002.
2,545,513. JUNGO. INT. CL. 9. REG. 3-12-2002.
2,545,514. GERRY AND DAVE'S OLD FASHIONED ITALIAN ICE WARM-N-SERVE AND DESIGN. INT. CL. 30. REG. 3-12-2002.
2,545,516. MARGARI-TIA'S. INT. CL. 33. REG. 3-12-2002.
2,545,517. CARN-AIDS. INT. CL. 5. REG. 3-12-2002.
2,545,518. SAFESUN (STYLIZED). INT. CL. 9. REG. 3-12-2002.
2,545,519. DIE TRYING AND DESIGN. INT. CL. 25. REG. 3-12-2002.
2,545,520. PERSONAL SEARCH AGENT. INT. CL. 35. REG. 3-12-2002.
2,545,521. ACUTOUCH (STYLIZED). INT. CL. 10. REG. 3-12-2002.
2,545,523. CMX. INT. CLS. 3, 9, 14, 16, 18, 25 AND 28. REG. 3-12-2002.
2,545,524. MODIFIER-STIX. INT. CL. 6. REG. 3-12-2002.
2,545,525. ODE. INT. CL. 33. REG. 3-12-2002.
2,545,526. LIP PAINT. INT. CL. 3. REG. 3-12-2002.
2,545,527. SOURCEDOC. INT. CL. 9. REG. 3-12-2002.
2,545,528. L THE STERLINGATE SIGNATURE (STYLIZED). INT. CL. 27. REG. 3-12-2002.
2,545,529. QBS. INT. CLS. 9, 41 AND 42. REG. 3-12-2002.
2,545,530. TRIPT-OH. INT. CL. 5. REG. 3-12-2002.
2,545,534. IRG AND DESIGN. INT. CL. 35. REG. 3-12-2002.
2,545,537. BATTERIES FOR SMART PEOPLE. INT. CL. 9. REG. 3-12-2002.
2,545,539. S.M.A.R.T. DESK. INT. CL. 39. REG. 3-12-2002.
2,545,540. IZEX. INT. CL. 10. REG. 3-12-2002.
2,545,541. WEBFACER (STYLIZED). INT. CLS. 9 AND 42. REG. 3-12-2002.
2,545,542. TELIA INNOVATIONCAPITAL. INT. CLS. 35, 37, 38 AND 42. REG. 3-12-2002.
2,545,543. INNOVATIONCAPITAL. INT. CLS. 35, 37, 38 AND 42. REG. 3-12-2002.
2,545,544. PARTIES PICNICS & PROMOS AND DESIGN. INT. CL. 41. REG. 3-12-2002.
2,545,547. MEDWARE AND DESIGN. INT. CL. 35. REG. 3-12-2002.
2,545,548. MEDLEY. INT. CL. 16. REG. 3-12-2002.
2,545,549. TECHNICA. INT. CLS. 9 AND 42. REG. 3-12-2002.
2,545,550. ALLEGRO. INT. CL. 9. REG. 3-12-2002.
2,545,552. CINAMORE. INT. CL. 30. REG. 3-12-2002.
2,545,553. PYTHEAS SOFTWARE & SERVICES AND DESIGN. INT. CLS. 9, 41 AND 42. REG. 3-12-2002.
2,545,555. BK GIULINI CHEMIE AND DESIGN. INT. CLS. 1, 2, 3, 5, 19, 29 AND 30. REG. 3-12-2002.
2,545,558. PRIORITIES. INT. CL. 16. REG. 3-12-2002.
2,545,560. BIOCERAMIDES VI. INT. CL. 3. REG. 3-12-2002.
2,545,563. ENERGY USER NEWS. INT. CL. 42. REG. 3-12-2002.
2,545,564. FPM AND DESIGN. INT. CL. 37. REG. 3-12-2002.
2,545,566. FREEZE FRAME. INT. CL. 16. REG. 3-12-2002.
2,545,568. URBANSTONE. INT. CL. 19. REG. 3-12-2002.
2,545,569. AIGLE AND DESIGN. INT. CL. 14. REG. 3-12-2002.
2,545,576. GLOBEGROUND. INT. CLS. 37 AND 42. REG. 3-12-2002.
2,545,578. VOICE HOME PAGE. INT. CL. 35. REG. 3-12-2002.
2,545,579. MOBEX COMMUNICATIONS, INC. MOBILE EXCELLENCE. INT. CLS. 35, 37 AND 38. REG. 3-12-2002.
2,545,580. ZAPP APP. INT. CL. 36. REG. 3-12-2002.
2,545,581. JUICE-TREE SQUEEZED FRESH DAILY AND DESIGN. INT. CL. 42. REG. 3-12-2002.
2,545,582. POWER TECHNOLOGY ASSOCIATES. INT. CL. 35. REG. 3-12-2002.
2,545,583. NETIK. INT. CL. 9. REG. 3-12-2002.
2,545,592. PHAS. INT. CLS. 3 AND 5. REG. 3-12-2002.
2,545,593. COOP. JESUS DEL PERDON AND DESIGN. INT. CL. 33. REG. 3-12-2002.
2,545,594. CHARACTER CUBS AND DESIGN. INT. CL. 16. REG. 3-12-2002.
2,545,596. MARTINTATE. INT. CL. 41. REG. 3-12-2002.
2,545,598. SANXTENDER. INT. CL. 9. REG. 3-12-2002.
2,545,601. MORELAW. INT. CLS. 35 AND 42. REG. 3-12-2002.
2,545,603. ARMSTRONGS. INT. CL. 35. REG. 3-12-2002.
2,545,604. VOILE MAGIQUE. INT. CL. 24. REG. 3-12-2002.
2,545,608. HAIRLEZZZ. INT. CLS. 3, 9, 10 AND 42. REG. 3-12-2002.
2,545,609. THE HSCA PHARMACY MONITOR. INT. CLS. 16 AND 42. REG. 3-12-2002.
2,545,611. JTA AND DESIGN. INT. CL. 42. REG. 3-12-2002.
2,545,612. NEED AN ANSWER ? ASK JPA! AND DESIGN. INT. CL. 35. REG. 3-12-2002.
2,545,614. REPORCIN. INT. CL. 5. REG. 3-12-2002.
2,545,615. FLOW STOP. INT. CL. 11. REG. 3-12-2002.
2,545,618. CME STOCKER CATTLE INDEX. INT. CL. 41. REG. 3-12-2002.
2,545,619. NEWS VENTURER AND DESIGN. INT. CL. 9. REG. 3-12-2002.
2,545,622. ORANGE COUNTY BAR FOUNDATION AND DESIGN. INT. CL. 41. REG. 3-12-2002.
2,545,624. VACCARI VILLEROY & BOCH GROUP AND DESIGN. INT. CL. 19. REG. 3-12-2002.
2,545,627. OLAF'S HARLEM, NYC EST. 1977 AND DESIGN. INT. CLS. 25 AND 28. REG. 3-12-2002.
2,545,631. DUCA D'AOSTA AND DESIGN. INT. CL. 25. REG. 3-12-2002.
2,545,632. ESN ESUPPORTNOW AND DESIGN. INT. CL. 35. REG. 3-12-2002.
2,545,633. DOMAINE DES TERRES ROUGES AND DESIGN. INT. CLS. 29 AND 30. REG. 3-12-2002.
2,545,634. WINDMAN. INT. CLS. 7 AND 9. REG. 3-12-2002.
2,545,635. FLETCHER'S FINE FOODS SINCE 1917 VERY TENDER AND DESIGN. INT. CL. 29. REG. 3-12-2002.
2,545,636. COLLABTECH. INT. CLS. 35 AND 42. REG. 3-12-2002.
2,545,638. CELLULAR ENGINES BY SIEMENS AND DESIGN. INT. CLS. 9 AND 42. REG. 3-12-2002.
2,545,639. AII. INT. CLS. 9, 16, 35, 37, 38, 41 AND 42. REG. 3-12-2002.
2,545,640. SPIKENARD M A G D A L E N A (STYLIZED). INT. CL. 3. REG. 3-12-2002.
2,545,641. IMPACTO AIR. INT. CL. 25. REG. 3-12-2002.
2,545,642. CONVERGENCE. INT. CL. 9. REG. 3-12-2002.
2,545,644. MYCATALOG. INT. CL. 35. REG. 3-12-2002.
2,545,645. MAXI STUDIO ISIS. INT. CL. 9. REG. 3-12-2002.
2,545,647. ZOTE. INT. CL. 17. REG. 3-12-2002.
2,545,648. TIS. INT. CL. 19. REG. 3-12-2002.
2,545,649. ESP PROMO ZONE. INT. CL. 35. REG. 3-12-2002.
2,545,650. SERDAS. INT. CL. 1. REG. 3-12-2002.
2,545,653. STATEN ISLAND NOW WWW.SINOW.COM AND DESIGN. INT. CL. 35. REG. 3-12-2002.
2,545,655. RV ALLIANCE AMERICA THE RV INSURANCE SPECIALIST (STYLIZED). INT. CL. 36. REG. 3-12-2002.
2,545,656. COSMETIC WORLD. INT. CL. 16. REG. 3-12-2002.
2,545,657. IEM INTEGRATED ENGINEERING MANAGEMENT BY SIEMENS AND DESIGN. INT. CLS. 35, 37 AND 42. REG. 3-12-2002.
2,545,660. PC BEACON. INT. CL. 9. REG. 3-12-2002.
2,545,661. BEEZ OIL. INT. CL. 2. REG. 3-12-2002.
2,545,662. LOHMANN RAUSCHER AND DESIGN. INT. CLS. 3, 5, 10, 24, 25, 35, 39 AND 42. REG. 3-12-2002.
2,545,665. BELLARROSTO. INT. CL. 29. REG. 3-12-2002.
2,545,667. WORD START THE EARLY READING ADVANTAGE AND DESIGN. INT. CL. 16. REG. 3-12-2002.
2,545,675. BIZONTHE.NET. INT. CLS. 35 AND 42. REG. 3-12-2002.
2,545,677. OMSTAR D-1280X. INT. CL. 4. REG. 3-12-2002.
2,545,682. HUNT ASSISTED LIVING. INT. CL. 42. REG. 3-12-2002.
2,545,683. RIGHTCLINICAL. INT. CL. 36. REG. 3-12-2002.
2,545,685. STARTEK.COM. INT. CLS. 35 AND 42. REG. 3-12-2002.
2,545,688. SPRAYMIST. INT. CL. 1. REG. 3-12-2002.
2,545,689. N AND DESIGN. INT. CL. 42. REG. 3-12-2002.
2,545,690. ERUDITE CORPORATION AND DESIGN. INT. CL. 41. REG. 3-12-2002.
2,545,692. DOCUSMART. INT. CL. 9. REG. 3-12-2002.

- 2,545,694. HEALTHDIRECTOR.COM. INT. CL. 42. REG. 3-12-2002.
- 2,545,696. LADY GREEN. INT. CL. 30. REG. 3-12-2002.
- 2,545,698. AVADA. INT. CLS. 1 AND 42. REG. 3-12-2002.
- 2,545,699. MAXBLAST (STYLIZED). INT. CL. 32. REG. 3-12-2002.
- 2,545,702. EVENTURE MEDIA THAT MEANS BUSINESS. AND DESIGN. INT. CLS. 9 AND 35. REG. 3-12-2002.
- 2,545,704. PULSFRAC. INT. CL. 9. REG. 3-12-2002.
- 2,545,705. SYNERGYLINK. INT. CL. 9. REG. 3-12-2002.
- 2,545,710. WASTEWATER BIOLOGICAL SOLUTIONS CORP. THE ULTIMATE WASTEWATER MANAGEMENT SOLUTIONS FOR EVERY INDUSTRY AND DESIGN. INT. CL. 40. REG. 3-12-2002.
- 2,545,712. PERM ENERGY. INT. CL. 3. REG. 3-12-2002.
- 2,545,714. ASTRAL-ESSENCE. INT. CL. 3. REG. 3-12-2002.
- 2,545,715. OVAVIEW AND DESIGN. INT. CL. 5. REG. 3-12-2002.
- 2,545,716. AMERICANCAPITALONLINE.COM. INT. CL. 36. REG. 3-12-2002.
- 2,545,719. VCALLAPOOZA. INT. CL. 36. REG. 3-12-2002.
- 2,545,720. 21ST CENTURY BUSINESS TOOLS. INT. CL. 35. REG. 3-12-2002.
- 2,545,721. MAINWAY FRESH BAKERY AND DESIGN. INT. CLS. 29, 30 AND 35. REG. 3-12-2002.
- 2,545,722. ONE 2 ONE. INT. CL. 38. REG. 3-12-2002.
- 2,545,723. MISCELLANEOUS DESIGN. INT. CL. 5. REG. 3-12-2002.
- 2,545,724. EVA SIGNAL. INT. CL. 9. REG. 3-12-2002.
- 2,545,725. PHONE ON-HOLD. INT. CLS. 9 AND 41. REG. 3-12-2002.
- 2,545,726. JUMPER. INT. CL. 28. REG. 3-12-2002.
- 2,545,727. SCOOTERNATION "SCOOT OVER AMERICA" AND DESIGN. INT. CL. 12. REG. 3-12-2002.
- 2,545,729. CYBERDOCS. INT. CL. 42. REG. 3-12-2002.
- 2,545,733. MISCELLANEOUS DESIGN. INT. CL. 38. REG. 3-12-2002.
- 2,545,735. INVISIO. INT. CL. 42. REG. 3-12-2002.
- 2,545,736. SAVVIEST SCROOGE. INT. CL. 41. REG. 3-12-2002.
- 2,545,739. GLASSVISION. INT. CL. 9. REG. 3-12-2002.
- 2,545,740. TUTORING CLUB WHERE LEARNING IS FUN! AND DESIGN. INT. CL. 41. REG. 3-12-2002.
- 2,545,741. R4. INT. CL. 9. REG. 3-12-2002.
- 2,545,742. VENETIAN STONE. INT. CLS. 20 AND 21. REG. 3-12-2002.
- 2,545,743. KAMOURASKA, LA BOTTERIE. INT. CL. 25. REG. 3-12-2002.
- 2,545,746. FLYING BULL. INT. CLS. 32, 33 AND 42. REG. 3-12-2002.
- 2,545,747. P AND DESIGN. INT. CLS. 9 AND 35. REG. 3-12-2002.
- 2,545,748. ONLINEMRO.COM AND DESIGN. INT. CL. 35. REG. 3-12-2002.
- 2,545,749. QUALIOPE (STYLIZED). INT. CLS. 35, 38 AND 42. REG. 3-12-2002.
- 2,545,751. RH AND DESIGN. INT. CL. 8. REG. 3-12-2002.
- 2,545,753. TOP CUT. INT. CL. 35. REG. 3-12-2002.
- 2,545,754. THE TECHNOLOGY OF CARING. INT. CL. 10. REG. 3-12-2002.
- 2,545,755. PDS AND DESIGN. INT. CL. 35. REG. 3-12-2002.
- 2,545,758. PENNIES FROM HEAVEN. INT. CL. 42. REG. 3-12-2002.
- 2,545,759. AHEC TRACK. INT. CL. 9. REG. 3-12-2002.
- 2,545,764. FIELDPRO. INT. CL. 9. REG. 3-12-2002.
- 2,545,768. OC THE OWNERS CLUB AND DESIGN. INT. CL. 36. REG. 3-12-2002.
- 2,545,773. EYVIND EARLE AND DESIGN. INT. CL. 16. REG. 3-12-2002.
- 2,545,774. EYVIND EARLE AND DESIGN. INT. CL. 9. REG. 3-12-2002.
- 2,545,776. MISCELLANEOUS DESIGN. INT. CL. 5. REG. 3-12-2002.
- 2,545,777. NAT'S AND DESIGN. INT. CLS. 18 AND 25. REG. 3-12-2002.
- 2,545,789. REVIVRE. INT. CL. 3. REG. 3-12-2002.
- 2,545,790. ACCULASER. INT. CL. 40. REG. 3-12-2002.
- 2,545,792. CLICK 4 WHAT YOU NEED. INT. CL. 42. REG. 3-12-2002.
- 2,545,793. PRICEIT. INT. CL. 9. REG. 3-12-2002.
- 2,545,797. THE BED AND BREAKFAST CHANNEL. INT. CL. 42. REG. 3-12-2002.
- 2,545,798. FIRECRACKER. INT. CL. 9. REG. 3-12-2002.
- 2,545,799. TURKEY DOLLARS. INT. CL. 35. REG. 3-12-2002.
- 2,545,800. GPULSE AND DESIGN. INT. CL. 10. REG. 3-12-2002.
- 2,545,801. TALIAH WAAJID BLACK EARTH PRODUCTS S.T.E.P.S. PROTECTIVE MIST BODIFIER AND DESIGN. INT. CL. 3. REG. 3-12-2002.
- 2,545,802. MISCELLANEOUS DESIGN. INT. CL. 25. REG. 3-12-2002.
- 2,545,807. ALUPROTECT. INT. CL. 7. REG. 3-12-2002.
- 2,545,808. FINDER (STYLIZED). INT. CL. 9. REG. 3-12-2002.
- 2,545,816. ES KILL TIME. INT. CL. 18. REG. 3-12-2002.
- 2,545,819. SORDINA TECHNOLOGY SERVING LIFE TECHNOLOGIA PER LA VITA AND DESIGN. INT. CLS. 10 AND 11. REG. 3-12-2002.
- 2,545,820. THE INVISIBLE CIRCUS. INT. CL. 41. REG. 3-12-2002.
- 2,545,829. EC ENERGY AND DESIGN. INT. CL. 32. REG. 3-12-2002.
- 2,545,832. TOOTHY THE TOOTH FAIRY KIT AND DESIGN. INT. CL. 16. REG. 3-12-2002.
- 2,545,833. DATA ON AND DESIGN. INT. CL. 9. REG. 3-12-2002.
- 2,545,834. COREACTIVE. INT. CL. 42. REG. 3-12-2002.
- 2,545,838. CONQUERING FEAR ONE ADVENTURE AT A TIME. INT. CL. 9. REG. 3-12-2002.
- 2,545,839. CYBERCARE. INT. CL. 38. REG. 3-12-2002.
- 2,545,840. CYBER-CARE. INT. CL. 38. REG. 3-12-2002.
- 2,545,844. ASAPARTNER. INT. CLS. 41 AND 42. REG. 3-12-2002.
- 2,545,845. BOONDOGS. INT. CL. 41. REG. 3-12-2002.
- 2,545,846. OILTRASH.COM. INT. CLS. 35 AND 40. REG. 3-12-2002.
- 2,545,847. HOMEOWNERS.COM AND DESIGN. INT. CLS. 35, 36 AND 42. REG. 3-12-2002.
- 2,545,848. COMMUNITY COACHES. INT. CL. 41. REG. 3-12-2002.
- 2,545,849. AMERICAN METAL WARE AND DESIGN. INT. CLS. 11 AND 21. REG. 3-12-2002.
- 2,545,851. V- (STYLIZED). INT. CLS. 9, 28 AND 38. REG. 3-12-2002.
- 2,545,852. CONNECTIONS CORPORATION AND DESIGN. INT. CL. 35. REG. 3-12-2002.
- 2,545,853. LAND OF I. INT. CL. 35. REG. 3-12-2002.
- 2,545,856. DQMACROS. INT. CL. 9. REG. 3-12-2002.
- 2,545,858. THE LEARNING PROJECT. INT. CL. 41. REG. 3-12-2002.
- 2,545,862. MULLER. INT. CLS. 29 AND 30. REG. 3-12-2002.
- 2,545,870. TRANSPLUS. INT. CL. 9. REG. 3-12-2002.
- 2,545,873. NATURAL MATTERS. INT. CL. 30. REG. 3-12-2002.
- 2,545,874. UV-LIGHT BY ORIGINAL HANAU AND DESIGN. INT. CLS. 9 AND 10. REG. 3-12-2002.
- 2,545,875. PL-X.COM. INT. CLS. 35, 36 AND 42. REG. 3-12-2002.
- 2,545,876. MYLUNCH@SCHOOL (STYLIZED). INT. CL. 42. REG. 3-12-2002.
- 2,545,879. UWG. INT. CLS. 35, 39 AND 42. REG. 3-12-2002.
- 2,545,880. SPOT.CC AND DESIGN. INT. CL. 42. REG. 3-12-2002.
- 2,545,882. MISCELLANEOUS DESIGN. INT. CL. 7. REG. 3-12-2002.
- 2,545,885. SPANISH GOLF ADVENTURES. INT. CL. 39. REG. 3-12-2002.
- 2,545,886. NATIONAL TAXIDERMISTS ASSOCIATION CERTIFIED TAXIDERMIST. U.S. CL. B. REG. 3-12-2002.
- 2,545,887. GOSPEL TRUELITES. INT. CL. 25. REG. 3-12-2002.
- 2,545,888. ROSCOE SURF CO. AND DESIGN. INT. CL. 25. REG. 3-12-2002.
- 2,545,889. THERECORD.NET. INT. CL. 42. REG. 3-12-2002.

- 2,545,892. A CUT ABOVE. INT. CL. 8. REG. 3-12-2002.
 2,545,893. ANPI ASSOCIATED NETWORK PARTNERS, INC. AND DESIGN. INT. CL. 38. REG. 3-12-2002.
 2,545,894. TIMEZONE. INT. CL. 41. REG. 3-12-2002.
 2,545,896. HEAT UP. COOL DOWN.. INT. CLS. 7, 9, 11, 12 AND 37. REG. 3-12-2002.
 2,545,898. LEHUALE AND DESIGN. INT. CL. 13. REG. 3-12-2002.
 2,545,899. CULMO. INT. CL. 1. REG. 3-12-2002.
 2,545,904. LIQUID BLUE AND DESIGN. INT. CL. 41. REG. 3-12-2002.
 2,545,906. DK (STYLIZED). INT. CL. 9. REG. 3-12-2002.
 2,545,908. MISCELLANEOUS DESIGN. INT. CL. 29. REG. 3-12-2002.
 2,545,909. NATIONAL INFORMATION CORPORATION. INT. CLS. 16, 35 AND 41. REG. 3-12-2002.
 2,545,910. STANGL/FULPER COLLECTORS CLUB AND DESIGN. INT. CLS. 35, 41 AND 42. REG. 3-12-2002.
 2,545,911. LEER AND DESIGN. INT. CLS. 12 AND 25. REG. 3-12-2002.
 2,545,914. SHOCKWAVE PICTURES. INT. CL. 41. REG. 3-12-2002.
 2,545,915. DATING911. INT. CL. 41. REG. 3-12-2002.
 2,545,917. LTV (STYLIZED). INT. CL. 41. REG. 3-12-2002.
 2,545,920. MISCELLANEOUS DESIGN. INT. CLS. 18, 25 AND 35. REG. 3-12-2002.
 2,545,922. COSTCO.COM. INT. CL. 38. REG. 3-12-2002.
 2,545,923. COOLFORCE MANUFACTURING COMPANY TEMPERATURE CONTROL PARTS AND DESIGN. INT. CLS. 7, 9 AND 11. REG. 3-12-2002.
 2,545,924. CAFE EXPRESSO. INT. CL. 3. REG. 3-12-2002.
 2,545,926. STS SYSTEMS (STYLIZED). INT. CLS. 9, 16, 41 AND 42. REG. 3-12-2002.
 2,545,927. CANDLE THERAPY. INT. CL. 42. REG. 3-12-2002.
 2,545,932. CUSTOMER-AWARE. INT. CLS. 35 AND 42. REG. 3-12-2002.
 2,545,933. PIN. INT. CL. 42. REG. 3-12-2002.
 2,545,936. VABFN. INT. CL. 35. REG. 3-12-2002.
 2,545,937. VAB. INT. CL. 35. REG. 3-12-2002.
 2,545,938. MARTINI & ROSSI MARTINI AND DESIGN. INT. CL. 33. REG. 3-12-2002.
 2,545,939. WACCAMAW FACTORY SHOPPES AND DESIGN. INT. CL. 36. REG. 3-12-2002.
 2,545,940. INZYME. INT. CL. 40. REG. 3-12-2002.
 2,545,942. MAXPRIME. INT. CL. 2. REG. 3-12-2002.
 2,545,943. ICES ETHICS AND EXCELLENCE IN EXAMINATIONS AND DESIGN. INT. CLS. 41 AND 42. REG. 3-12-2002.
 2,545,944. MISCELLANEOUS DESIGN. INT. CL. 35. REG. 3-12-2002.
 2,545,945. JUST FOOD, INC.. INT. CLS. 35 AND 41. REG. 3-12-2002.
 2,545,946. LABEYRIE AND DESIGN. INT. CL. 29. REG. 3-12-2002.
 2,545,948. XMETAL. INT. CL. 9. REG. 3-12-2002.
 2,545,951. MISCELLANEOUS DESIGN. INT. CL. 36. REG. 3-12-2002.
 2,545,952. FRIJPOUR AND DESIGN. INT. CLS. 20 AND 21. REG. 3-12-2002.
 2,545,955. LOCALE SYSTEMS. INT. CL. 35. REG. 3-12-2002.
 2,545,957. ROWOSHIELD. INT. CL. 17. REG. 3-12-2002.
 2,545,958. REALLYKNOW. INT. CL. 35. REG. 3-12-2002.
 2,545,960. GIVE PEACH A CHANCE. INT. CL. 30. REG. 3-12-2002.
 2,545,961. BOOB TOOB. INT. CL. 25. REG. 3-12-2002.
 2,545,962. BRIDGES (STYLIZED). INT. CL. 16. REG. 3-12-2002.
 2,545,963. CRUSADER LANDSCAPE MANAGEMENT, INC. "KEEPING YOUR INVESTMENT GROWING" AND DESIGN. INT. CL. 42. REG. 3-12-2002.
 2,545,964. FRESH AND DESIGN. INT. CL. 29. REG. 3-12-2002.
 2,545,966. QUEST FOR THE PRESIDENCY. INT. CLS. 16 AND 42. REG. 3-12-2002.
 2,545,967. MISCELLANEOUS DESIGN. INT. CL. 35. REG. 3-12-2002.
 2,545,970. C CITIZENS COMMERCIAL REAL ESTATE GROUP, INC. AND DESIGN. INT. CL. 36. REG. 3-12-2002.
 2,545,971. STEAM BOY. INT. CL. 28. REG. 3-12-2002.
 2,545,973. MYSAP.COM. INT. CL. 25. REG. 3-12-2002.
 2,545,974. BRANDQUERY. INT. CLS. 35 AND 42. REG. 3-12-2002.
 2,545,975. WHITE RIBBON. INT. CL. 3. REG. 3-12-2002.
 2,545,976. CASCADE COMMUNICATIONS VENTURES. INT. CL. 36. REG. 3-12-2002.
 2,545,977. FRRROZEN HOT CHOCOLATE AND DESIGN. INT. CL. 30. REG. 3-12-2002.
 2,545,980. AMEGA AND DESIGN. INT. CL. 16. REG. 3-12-2002.
 2,545,982. SILVERHEELS. INT. CL. 35. REG. 3-12-2002.
 2,545,984. GT2 RACING WHEEL AND DESIGN. INT. CL. 9. REG. 3-12-2002.
 2,545,986. EL REGALO.COM AND DESIGN. INT. CL. 35. REG. 3-12-2002.
 2,545,987. EASTERN OUTLOOK (STYLIZED). INT. CL. 42. REG. 3-12-2002.
 2,545,990. CTR PAYROLL. INT. CL. 42. REG. 3-12-2002.
 2,545,991. THE VALUE CREATION COMPANY. INT. CLS. 36 AND 37. REG. 3-12-2002.
 2,545,994. SPORTS JEOPARDY! ONLINE AND DESIGN. INT. CL. 41. REG. 3-12-2002.
 2,545,996. COFFEE FLOWERS. INT. CL. 31. REG. 3-12-2002.
 2,545,997. CHANCELLOR. INT. CL. 12. REG. 3-12-2002.
 2,546,000. 5 O'CLOCK EYE. INT. CL. 9. REG. 3-12-2002.
 2,546,004. CARDIAC TELECOM. INT. CL. 42. REG. 3-12-2002.
 2,546,005. THE SMART INVESTORS' WEB SITE. INT. CLS. 35 AND 36. REG. 3-12-2002.
 2,546,006. CON-WAY CANADA EXPRESS. INT. CL. 39. REG. 3-12-2002.
 2,546,007. PORTALSPHERE. INT. CL. 9. REG. 3-12-2002.
 2,546,008. CUSTOMER ACTION LINK. INT. CL. 36. REG. 3-12-2002.
 2,546,010. BRO'...SAVE ME A SEAT - GOD. INT. CL. 42. REG. 3-12-2002.
 2,546,011. CHILL...DON'T KILL.-GOD. INT. CL. 42. REG. 3-12-2002.
 2,546,012. FACTSAFE AND DESIGN. INT. CL. 9. REG. 3-12-2002.
 2,546,013. TH@T AND DESIGN. INT. CL. 36. REG. 3-12-2002.
 2,546,014. MY PAL BUILDING BLOCKS FOR LITTLE WARDROBES. AND DESIGN. INT. CL. 25. REG. 3-12-2002.
 2,546,016. DOMINION RESOURCES AND DESIGN. INT. CLS. 37, 39, 40 AND 42. REG. 3-12-2002.
 2,546,017. THE BRIDGE NEWS WAYFARER AND DESIGN. INT. CL. 25. REG. 3-12-2002.
 2,546,023. JEWELTONES. INT. CL. 11. REG. 3-12-2002.
 2,546,025. LITTLE JOHNNY. INT. CLS. 9, 28 AND 41. REG. 3-12-2002.
 2,546,027. AXIOM. INT. CL. 9. REG. 3-12-2002.
 2,546,028. STRESS YOUR SYSTEM. NOT YOUR CUSTOMERS.. INT. CLS. 9 AND 42. REG. 3-12-2002.
 2,546,030. SCHUMACHER. INT. CLS. 1, 7, 11 AND 17. REG. 3-12-2002.
 2,546,033. MISCELLANEOUS DESIGN. INT. CL. 42. REG. 3-12-2002.
 2,546,035. EIDOS SPORTS. INT. CLS. 16, 25 AND 28. REG. 3-12-2002.
 2,546,040. FLORAPLEX. INT. CL. 35. REG. 3-12-2002.
 2,546,043. SUSHI. INT. CL. 9. REG. 3-12-2002.
 2,546,045. MISCELLANEOUS DESIGN. INT. CL. 41. REG. 3-12-2002.
 2,546,046. SONICTRADING AND DESIGN. INT. CL. 36. REG. 3-12-2002.
 2,546,052. JITI BUILDER AND DESIGN. INT. CL. 9. REG. 3-12-2002.
 2,546,054. SUMMERHILL'S (STYLIZED). INT. CL. 30. REG. 3-12-2002.
 2,546,055. TOP HEALTH. INT. CLS. 5 AND 42. REG. 3-12-2002.

- 2,546,059. WINNIPESAUKEE SUMMER PALE ALE. INT. CL. 32. REG. 3-12-2002.
- 2,546,061. SECS. INT. CLS. 9, 14 AND 25. REG. 3-12-2002.
- 2,546,062. GET YOUR SKILLS ON OUR GEAR. INT. CL. 41. REG. 3-12-2002.
- 2,546,063. VISION CHECK. INT. CL. 9. REG. 3-12-2002.
- 2,546,067. MSBCD.COM. INT. CL. 35. REG. 3-12-2002.
- 2,546,073. THE HACK SHACK. INT. CLS. 35 AND 37. REG. 3-12-2002.
- 2,546,074. E-PLANTCOMMERCE.COM. INT. CL. 35. REG. 3-12-2002.
- 2,546,075. ASD GLOBAL. INT. CL. 35. REG. 3-12-2002.
- 2,546,077. PI AND DESIGN. INT. CLS. 12 AND 25. REG. 3-12-2002.
- 2,546,079. ROBOTOUCH. INT. CL. 9. REG. 3-12-2002.
- 2,546,083. TRAFFIC VIEW. INT. CL. 9. REG. 3-12-2002.
- 2,546,084. MYFREEI. INT. CL. 42. REG. 3-12-2002.
- 2,546,085. YOUR ON-LINE WINDOW COVERING SUPERSTORE. INT. CL. 35. REG. 3-12-2002.
- 2,546,086. SENIOR SLANT AND DESIGN. INT. CL. 42. REG. 3-12-2002.
- 2,546,091. BANK AT YOUR FINGERTIPS. INT. CL. 36. REG. 3-12-2002.
- 2,546,093. SAINT BY SARAH JANE AND DESIGN. INT. CL. 14. REG. 3-12-2002.
- 2,546,096. DIVERSE PUBLIC RADIO. INT. CLS. 21, 25, 38 AND 41. REG. 3-12-2002.
- 2,546,097. ELIMINATE YOUR ROOFING WORRIES FOREVER !. INT. CL. 37. REG. 3-12-2002.
- 2,546,098. ROOF YOUR HOME FOR THE LAST TIME!. INT. CL. 37. REG. 3-12-2002.
- 2,546,100. TOVA.CALM. INT. CLS. 3 AND 4. REG. 3-12-2002.
- 2,546,105. USPSA. INT. CL. 42. REG. 3-12-2002.
- 2,546,107. LOGOTRADE. INT. CL. 35. REG. 3-12-2002.
- 2,546,108. GAMES FOR THE COMMONWEALTH. INT. CLS. 16, 25, 26, 35 AND 41. REG. 3-12-2002.
- 2,546,109. OMNISTAR. INT. CL. 9. REG. 3-12-2002.
- 2,546,110. MISCELLANEOUS DESIGN. INT. CL. 42. REG. 3-12-2002.
- 2,546,114. STEAM ENGINE. INT. CL. 30. REG. 3-12-2002.
- 2,546,116. TACKIM. INT. CL. 21. REG. 3-12-2002.
- 2,546,122. LITI. INT. CLS. 16 AND 42. REG. 3-12-2002.
- 2,546,123. LITI HOLOGRAPHICS. INT. CLS. 16 AND 42. REG. 3-12-2002.
- 2,546,124. B4C. INT. CL. 35. REG. 3-12-2002.
- 2,546,125. SQUIBNET. INT. CL. 9. REG. 3-12-2002.
- 2,546,132. TEENMAIL.COM AND DESIGN. INT. CL. 35. REG. 3-12-2002.
- 2,546,134. FLCD. INT. CL. 9. REG. 3-12-2002.
- 2,546,137. SAGE, THE SYSTEM ADMINISTRATORS' GUILD. INT. CLS. 41 AND 42. REG. 3-12-2002.
- 2,546,138. EUROPADISK (STYLIZED). INT. CL. 40. REG. 3-12-2002.
- 2,546,142. MISCELLANEOUS DESIGN. INT. CL. 37. REG. 3-12-2002.
- 2,546,143. LUNCHWICH. INT. CL. 30. REG. 3-12-2002.
- 2,546,145. AESTHETICOM. INT. CLS. 35 AND 41. REG. 3-12-2002.
- 2,546,148. RULES OF THE ROAD. INT. CLS. 16 AND 41. REG. 3-12-2002.
- 2,546,149. WHAT'S TICKING ON WALL STREET. INT. CL. 41. REG. 3-12-2002.
- 2,546,150. DE-COURSEBUILDER. INT. CL. 41. REG. 3-12-2002.
- 2,546,154. DRTS. INT. CL. 10. REG. 3-12-2002.
- 2,546,155. WASATCH PHARMACEUTICAL. INT. CL. 42. REG. 3-12-2002.
- 2,546,156. DEL FERRO METHOD. INT. CLS. 41 AND 42. REG. 3-12-2002.
- 2,546,157. EXTREMESPORTS.COM AND DESIGN. INT. CL. 35. REG. 3-12-2002.
- 2,546,158. QUAD STRIKE. INT. CL. 30. REG. 3-12-2002.
- 2,546,161. SENSIRION THE SENSOR COMPANY AND DESIGN. INT. CLS. 9 AND 42. REG. 3-12-2002.
- 2,546,164. ANNETTE HIMSTEDT-KINDER PUPPEN AND DESIGN. INT. CLS. 16 AND 28. REG. 3-12-2002.
- 2,546,165. MISCELLANEOUS DESIGN. INT. CLS. 38 AND 42. REG. 3-12-2002.
- 2,546,166. ROCK CITY. INT. CL. 16. REG. 3-12-2002.
- 2,546,168. AQUA BIOTRONIC.COM "COMBINING ELECTRONICS AND BIOLOGY TO CLEAN WASTE WATER // DELIVERING VALUE THAT PAYS FOR ITSELF" AND DESIGN. INT. CL. 40. REG. 3-12-2002.
- 2,546,169. ISSAC CLASS. INT. CL. 25. REG. 3-12-2002.
- 2,546,170. IPAXS. INT. CL. 9. REG. 3-12-2002.
- 2,546,171. THE THRESHOLD.COM. INT. CL. 38. REG. 3-12-2002.
- 2,546,173. RADICAND SOLUTIONS AND DESIGN. INT. CLS. 40 AND 42. REG. 3-12-2002.
- 2,546,174. GUTTER RAT. INT. CLS. 35 AND 42. REG. 3-12-2002.
- 2,546,176. QUIET STORM RECORDS. INT. CL. 9. REG. 3-12-2002.
- 2,546,177. GARELICK FARMS AND DESIGN. INT. CLS. 29 AND 32. REG. 3-12-2002.
- 2,546,181. IPSX 9000. INT. CL. 9. REG. 3-12-2002.
- 2,546,182. ESCHEMA. INT. CL. 9. REG. 3-12-2002.
- 2,546,183. EA (STYLIZED). INT. CLS. 9 AND 42. REG. 3-12-2002.
- 2,546,185. DECOMPRAS.COM AND DESIGN. INT. CL. 35. REG. 3-12-2002.
- 2,546,190. W4. INT. CL. 38. REG. 3-12-2002.
- 2,546,191. W4.NET. INT. CL. 38. REG. 3-12-2002.
- 2,546,192. LUCILLE (STYLIZED). INT. CL. 41. REG. 3-12-2002.
- 2,546,197. BONECOM. INT. CL. 9. REG. 3-12-2002.
- 2,546,198. SOCKSCAP. INT. CL. 9. REG. 3-12-2002.
- 2,546,201. BUMONGOUS (STYLIZED). INT. CL. 28. REG. 3-12-2002.
- 2,546,207. YOU CARE AND DESIGN. INT. CL. 42. REG. 3-12-2002.
- 2,546,209. BUTTERFIELDS. INT. CL. 35. REG. 3-12-2002.
- 2,546,212. NATURAL BUSINESS. INT. CLS. 16 AND 41. REG. 3-12-2002.
- 2,546,216. M.A.CH. 10/100. INT. CL. 9. REG. 3-12-2002.
- 2,546,217. PWL/WELLINK. INT. CLS. 38 AND 42. REG. 3-12-2002.
- 2,546,219. MESSAGEPILOT. INT. CL. 38. REG. 3-12-2002.
- 2,546,222. MARLENA (STYLIZED). INT. CLS. 3 AND 35. REG. 3-12-2002.
- 2,546,224. NUTRI VIVE. INT. CL. 3. REG. 3-12-2002.
- 2,546,225. KNOWLEDGE INFRASTRUCTURE. INT. CL. 41. REG. 3-12-2002.
- 2,546,226. CHAMPIONS OF SMALL BUSINESS. INT. CL. 42. REG. 3-12-2002.
- 2,546,227. FLORIDA LIFE, YOUR STYLE.. INT. CL. 42. REG. 3-12-2002.
- 2,546,228. WHERE FLORIDA LIVES ... AND PLAYS.. INT. CL. 42. REG. 3-12-2002.
- 2,546,230. WHERE FLORIDA LIVES.. INT. CL. 36. REG. 3-12-2002.
- 2,546,231. WHERE FLORIDA LIVES.. INT. CL. 39. REG. 3-12-2002.
- 2,546,232. THE LIST. INT. CL. 41. REG. 3-12-2002.
- 2,546,234. ITALIAN CAFE BLEND. INT. CL. 30. REG. 3-12-2002.
- 2,546,235. CONNECTICUT STONE AND DESIGN. INT. CLS. 19 AND 35. REG. 3-12-2002.
- 2,546,236. DOUBLE CLIC. INT. CL. 3. REG. 3-12-2002.
- 2,546,237. HOUSTON. INT. CL. 9. REG. 3-12-2002.
- 2,546,238. MICRO IMAGING TECHNOLOGY AND DESIGN. INT. CL. 9. REG. 3-12-2002.
- 2,546,240. MPDX. INT. CLS. 9 AND 10. REG. 3-12-2002.
- 2,546,241. BRIGADE. INT. CLS. 35 AND 42. REG. 3-12-2002.
- 2,546,242. THE BOOGIE MAN. INT. CL. 41. REG. 3-12-2002.
- 2,546,244. ONE TOUCH TO GREAT FRAGRANCE. INT. CL. 5. REG. 3-12-2002.
- 2,546,246. BEAUTY WELLNESS. INT. CL. 41. REG. 3-12-2002.
- 2,546,247. KOMA AND DESIGN. INT. CL. 11. REG. 3-12-2002.
- 2,546,248. KOMA. INT. CL. 11. REG. 3-12-2002.
- 2,546,251. KIDS, CRITTERS CAUGHT ON TAPE. INT. CL. 41. REG. 3-12-2002.

- 2,546,252. WWW.CLEARSTATION.COM. INT. CLS. 9, 21 AND 25. REG. 3-12-2002.
- 2,546,253. MPDX AND DESIGN. INT. CLS. 9 AND 10. REG. 3-12-2002.
- 2,546,254. MPDX M E G A P I X E L D I A G N O S T I C S AND DESIGN. INT. CLS. 9 AND 10. REG. 3-12-2002.
- 2,546,256. WHAT A STRIKING ... !. INT. CLS. 3, 29, 30 AND 33. REG. 3-12-2002.
- 2,546,258. GREATLOVERS.COM. INT. CL. 42. REG. 3-12-2002.
- 2,546,259. NAKUZ. INT. CL. 25. REG. 3-12-2002.
- 2,546,261. /AXA FINANCIAL AND DESIGN. INT. CL. 36. REG. 3-12-2002.
- 2,546,262. /AXA ADVISORS AND DESIGN. INT. CL. 36. REG. 3-12-2002.
- 2,546,266. VEGUEROS AND DESIGN. INT. CL. 3. REG. 3-12-2002.
- 2,546,268. SBIRWORLD. INT. CL. 42. REG. 3-12-2002.
- 2,546,270. RAPIDTEXT. INT. CLS. 9, 35, 41 AND 42. REG. 3-12-2002.
- 2,546,271. ALMOST-EPI. INT. CL. 9. REG. 3-12-2002.
- 2,546,272. STRENGTH AEROBICS AND DESIGN. INT. CL. 41. REG. 3-12-2002.
- 2,546,273. PREFERRED PLUS DEEDS OF TRUST. INT. CL. 36. REG. 3-12-2002.
- 2,546,274. A SUMMER SUNDAY. INT. CL. 36. REG. 3-12-2002.
- 2,546,275. GRAND PAVILION. INT. CL. 27. REG. 3-12-2002.
- 2,546,278. MISCELLANEOUS DESIGN. INT. CL. 35. REG. 3-12-2002.
- 2,546,280. LOST SHEEP. INT. CL. 33. REG. 3-12-2002.
- 2,546,281. I DO AND DESIGN. INT. CL. 42. REG. 3-12-2002.
- 2,546,282. 4-BALL. INT. CL. 41. REG. 3-12-2002.
- 2,546,285. COMFORT PROTECTION PLAN. INT. CL. 37. REG. 3-12-2002.
- 2,546,288. L'ALFABETO DEL VIVENTE. INT. CLS. 9, 16, 41 AND 42. REG. 3-12-2002.
- 2,546,289. YOURAIRSTORE. INT. CL. 35. REG. 3-12-2002.
- 2,546,291. PROJECT LIGHTHOUSE. INT. CL. 9. REG. 3-12-2002.
- 2,546,292. OCTOBER COM AN OCTOBERKAT COMPANY AND DESIGN. INT. CL. 39. REG. 3-12-2002.
- 2,546,293. BLACK FAMILY TELEVISION NETWORK INC. BFTN AND DESIGN. INT. CL. 38. REG. 3-12-2002.
- 2,546,297. PERMEON. INT. CL. 17. REG. 3-12-2002.
- 2,546,298. DEVOTION. INT. CL. 3. REG. 3-12-2002.
- 2,546,301. WAVEDAEMON AND DESIGN. INT. CL. 9. REG. 3-12-2002.
- 2,546,304. LOOK WHO'S TALKING ABOUT REITS AND PUBLICLY TRADED REAL ESTATE. INT. CL. 16. REG. 3-12-2002.
- 2,546,305. NIPR NATIONAL INSURANCE PRODUCER REGISTRY AND DESIGN. INT. CL. 36. REG. 3-12-2002.
- 2,546,306. LIMP DINC. INT. CL. 32. REG. 3-12-2002.
- 2,546,307. N AND DESIGN. INT. CL. 35. REG. 3-12-2002.
- 2,546,308. IDENTITYWATCH. INT. CL. 42. REG. 3-12-2002.
- 2,546,309. MISCELLANEOUS DESIGN. INT. CL. 1. REG. 3-12-2002.
- 2,546,310. MELCUT. INT. CL. 7. REG. 3-12-2002.
- 2,546,311. NICKELODEON GAS GAMES AND SPORTS FOR KIDS AND DESIGN. INT. CL. 38. REG. 3-12-2002.
- 2,546,312. A (STYLIZED). INT. CL. 9. REG. 3-12-2002.
- 2,546,313. TEEN LINK. INT. CLS. 16 AND 35. REG. 3-12-2002.
- 2,546,315. ALPHA AND OMEGA SOLUTIONS. INT. CL. 35. REG. 3-12-2002.
- 2,546,316. EASTRAL (STYLIZED). INT. CL. 42. REG. 3-12-2002.
- 2,546,318. ONE AND DESIGN. INT. CL. 35. REG. 3-12-2002.
- 2,546,321. THEFUNNIEST. INT. CL. 41. REG. 3-12-2002.
- 2,546,323. THE INTERNET IS THE EXCHANGE. INT. CL. 9. REG. 3-12-2002.
- 2,546,328. MISS VENEZUELA. INT. CL. 38. REG. 3-12-2002.
- 2,546,329. CODE OF THE WEST AND DESIGN. INT. CLS. 25 AND 41. REG. 3-12-2002.
- 2,546,341. C COWAN (STYLIZED). INT. CL. 39. REG. 3-12-2002.
- 2,546,343. EXTREME LOTTO AND DESIGN. INT. CL. 41. REG. 3-12-2002.
- 2,546,345. ONTOE.COM. INT. CL. 42. REG. 3-12-2002.
- 2,546,346. GATORBACK. INT. CL. 28. REG. 3-12-2002.
- 2,546,348. QUICK PITCH. INT. CL. 9. REG. 3-12-2002.
- 2,546,350. THE RAPID KNOWLEDGE TRANSFER SYSTEM. INT. CL. 35. REG. 3-12-2002.
- 2,546,351. MOBILE SNIPS AND DESIGN. INT. CL. 42. REG. 3-12-2002.
- 2,546,352. MISCELLANEOUS DESIGN. INT. CL. 36. REG. 3-12-2002.
- 2,546,354. HAN JOO RESTAURANT. INT. CL. 42. REG. 3-12-2002.
- 2,546,355. ENVENUE. INT. CL. 35. REG. 3-12-2002.
- 2,546,356. ZEBWARE AND DESIGN. INT. CL. 9. REG. 3-12-2002.
- 2,546,358. QCIP. INT. CL. 38. REG. 3-12-2002.
- 2,546,359. W WELLS (STYLIZED). INT. CL. 20. REG. 3-12-2002.
- 2,546,361. FEISTY FEATHERS AND DESIGN. INT. CL. 31. REG. 3-12-2002.
- 2,546,362. PRO SPEED LIGHTNING CUES AND DESIGN. INT. CL. 28. REG. 3-12-2002.
- 2,546,363. THE FIRST 30 MINUTES. INT. CL. 16. REG. 3-12-2002.
- 2,546,364. EMPOWERING CLIENTS WITH INNOVATIVE INVESTMENT SOLUTIONS. INT. CL. 36. REG. 3-12-2002.
- 2,546,366. INTRIGUE. INT. CL. 26. REG. 3-12-2002.
- 2,546,367. ALTALEARNING.COM. INT. CL. 35. REG. 3-12-2002.
- 2,546,369. SCORPION AND DESIGN. INT. CL. 9. REG. 3-12-2002.
- 2,546,370. CULINARY MASTERS. INT. CL. 35. REG. 3-12-2002.
- 2,546,371. STANDARD & POOR'S IQ. INT. CL. 36. REG. 3-12-2002.
- 2,546,375. CAMBRIDGE TECHNOLOGY PARTNERS AND DESIGN. INT. CLS. 35 AND 42. REG. 3-12-2002.
- 2,546,376. LAURA LAVALLE. INT. CL. 14. REG. 3-12-2002.
- 2,546,377. DRILLET. INT. CL. 9. REG. 3-12-2002.
- 2,546,378. ISOVIA. INT. CL. 42. REG. 3-12-2002.
- 2,546,380. MISCELLANEOUS DESIGN. INT. CL. 41. REG. 3-12-2002.
- 2,546,381. WHAT ARE YOU DEALING WITH?. INT. CL. 41. REG. 3-12-2002.
- 2,546,384. HEALTHY NEGOTIATION. INT. CL. 41. REG. 3-12-2002.
- 2,546,386. MISCELLANEOUS DESIGN. INT. CL. 28. REG. 3-12-2002.
- 2,546,388. QCSI. INT. CLS. 35, 36 AND 42. REG. 3-12-2002.
- 2,546,389. DIAMOND IMAGE. INT. CL. 35. REG. 3-12-2002.
- 2,546,391. ESPINA. INT. CL. 16. REG. 3-12-2002.
- 2,546,392. HOMEVISION. INT. CL. 9. REG. 3-12-2002.
- 2,546,393. BAGEL SHOP QUALITY BOSTON BAGEL AND DESIGN. INT. CL. 30. REG. 3-12-2002.
- 2,546,394. REALMINDER.COM AND DESIGN. INT. CL. 42. REG. 3-12-2002.
- 2,546,395. LAST MINUTE TOUR AND DESIGN. INT. CLS. 16, 39 AND 42. REG. 3-12-2002.
- 2,546,396. X LOTTO AND DESIGN. INT. CL. 41. REG. 3-12-2002.
- 2,546,400. SWICH AND DESIGN. INT. CL. 5. REG. 3-12-2002.
- 2,546,401. BEST PRACTICES DATABASE. INT. CL. 35. REG. 3-12-2002.
- 2,546,404. LESSON ONE: SKILLS FOR LIFE. INT. CLS. 16 AND 41. REG. 3-12-2002.
- 2,546,405. LESSON ONE. INT. CLS. 16 AND 41. REG. 3-12-2002.
- 2,546,407. VECTIV. INT. CL. 42. REG. 3-12-2002.
- 2,546,410. FURITITAN (STYLIZED). INT. CL. 8. REG. 3-12-2002.
- 2,546,412. MISCELLANEOUS DESIGN. INT. CL. 36. REG. 3-12-2002.

- 2,546,413. A AAM THE AMERICAN ASSOCIATION OF MUSEUMS AFFINITY PROGRAMS AND DESIGN. INT. CL. 42. REG. 3-12-2002.
- 2,546,414. PANTHEON. INT. CLS. 6 AND 7. REG. 3-12-2002.
- 2,546,415. MISCELLANEOUS DESIGN. INT. CL. 36. REG. 3-12-2002.
- 2,546,416. CLESTORE.COM. INT. CL. 41. REG. 3-12-2002.
- 2,546,421. HDDGOD AND DESIGN. INT. CL. 9. REG. 3-12-2002.
- 2,546,423. M.I.E. MODELING IN EUROPE. INT. CL. 35. REG. 3-12-2002.
- 2,546,424. FMS AND DESIGN. INT. CL. 9. REG. 3-12-2002.
- 2,546,425. DOVEBID WEBCAST NETWORK. INT. CL. 35. REG. 3-12-2002.
- 2,546,429. C (STYLIZED). INT. CL. 41. REG. 3-12-2002.
- 2,546,434. "TOUGH AS A PARROT'S BEAK". INT. CL. 2. REG. 3-12-2002.
- 2,546,435. CORUS AND DESIGN. INT. CLS. 35, 41 AND 42. REG. 3-12-2002.
- 2,546,439. MOLDER ACTION NETWORK. INT. CL. 42. REG. 3-12-2002.
- 2,546,442. EARN WHILE YOU LEARN. INT. CL. 35. REG. 3-12-2002.
- 2,546,443. LONE STAR THE NATIONAL BEER OF TEXAS AND DESIGN. INT. CL. 32. REG. 3-12-2002.
- 2,546,446. CORUM MYSTERY. INT. CL. 14. REG. 3-12-2002.
- 2,546,447. EXECUTIVE MYSTIC. INT. CL. 42. REG. 3-12-2002.
- 2,546,452. CVS SURF CLUB AND DESIGN. INT. CL. 28. REG. 3-12-2002.
- 2,546,456. THINK YOU COULD DO BETTER THAN HOLLYWOOD? SO DO WE.. INT. CL. 41. REG. 3-12-2002.
- 2,546,458. HAWTHORN CENTER. INT. CLS. 35 AND 36. REG. 3-12-2002.
- 2,546,459. COCKTAIL CHARITIES AND DESIGN. INT. CL. 36. REG. 3-12-2002.
- 2,546,460. COCKTAIL CHARITIES. INT. CL. 36. REG. 3-12-2002.
- 2,546,464. MAKE ALL YOUR THOUGHTS COME THROUGH. INT. CL. 35. REG. 3-12-2002.
- 2,546,465. DRAGONBALL Z. INT. CLS. 11, 14, 18, 20, 21, 24 AND 30. REG. 3-12-2002.
- 2,546,467. RAMPART. INT. CLS. 9 AND 42. REG. 3-12-2002.
- 2,546,468. TDS. INT. CL. 1. REG. 3-12-2002.
- 2,546,469. S S://SCAPE AND DESIGN. INT. CL. 35. REG. 3-12-2002.
- 2,546,470. SELAVIE AND DESIGN. INT. CL. 30. REG. 3-12-2002.
- 2,546,472. Q SUCCEED WITH QIMIQ AND DESIGN. INT. CLS. 29 AND 30. REG. 3-12-2002.
- 2,546,473. HUSKER FEVER. INT. CLS. 16, 25, 35 AND 41. REG. 3-12-2002.
- 2,546,474. COURSEMASTER. INT. CL. 16. REG. 3-12-2002.
- 2,546,475. HAZEL BISHOP. INT. CL. 3. REG. 3-12-2002.
- 2,546,477. REGENCY PLAYERS SOCIETY. INT. CL. 41. REG. 3-12-2002.
- 2,546,478. EX-CENTRIC SOUND SYSTEM. INT. CL. 41. REG. 3-12-2002.
- 2,546,480. THE EVERYDAY WEB. INT. CL. 36. REG. 3-12-2002.
- 2,546,481. PERFORMANCE BY DESIGN!. INT. CL. 11. REG. 3-12-2002.
- 2,546,482. TOPIIS. INT. CL. 9. REG. 3-12-2002.
- 2,546,483. THE COMMUNICATION ZONE AND DESIGN. INT. CL. 16. REG. 3-12-2002.
- 2,546,484. CENTERSOURCE MAXCEL AND DESIGN. INT. CL. 5. REG. 3-12-2002.
- 2,546,485. YWCA WEEK WITHOUT VIOLENCE AND DESIGN. INT. CLS. 16, 25 AND 41. REG. 3-12-2002.
- 2,546,487. GLOBAL HEALTHED AND DESIGN. INT. CL. 41. REG. 3-12-2002.
- 2,546,488. GEOSITESERVER. INT. CL. 9. REG. 3-12-2002.
- 2,546,489. GEOGLOBSERVER. INT. CL. 42. REG. 3-12-2002.
- 2,546,491. PROJECT AIM. INT. CL. 41. REG. 3-12-2002.
- 2,546,493. THE K.G.B.. INT. CLS. 9 AND 41. REG. 3-12-2002.
- 2,546,496. TONOS AND DESIGN. INT. CL. 41. REG. 3-12-2002.
- 2,546,497. POWERMID. INT. CLS. 16 AND 30. REG. 3-12-2002.
- 2,546,500. LAMO GENUINE SHEEPSKIN AND DESIGN. INT. CL. 12. REG. 3-12-2002.
- 2,546,501. THE BULL-A-TON. INT. CL. 16. REG. 3-12-2002.
- 2,546,504. FASTLAMPS.COM. INT. CL. 35. REG. 3-12-2002.
- 2,546,505. REFINDER. INT. CL. 22. REG. 3-12-2002.
- 2,546,506. MSP-LINER. INT. CL. 17. REG. 3-12-2002.
- 2,546,509. NEON BEACH. INT. CL. 30. REG. 3-12-2002.
- 2,546,512. ZEEN (STYLIZED). INT. CLS. 10 AND 25. REG. 3-12-2002.
- 2,546,513. PHARMAPATH. INT. CLS. 35 AND 42. REG. 3-12-2002.
- 2,546,514. MISCELLANEOUS DESIGN. INT. CL. 35. REG. 3-12-2002.
- 2,546,515. 750 MUSIC INC.. INT. CL. 41. REG. 3-12-2002.
- 2,546,516. CULT OPTICS. INT. CL. 9. REG. 3-12-2002.
- 2,546,517. LIAN RECORDS. INT. CL. 9. REG. 3-12-2002.
- 2,546,521. SIGNATURE SILVER. INT. CL. 41. REG. 3-12-2002.
- 2,546,522. SCHOOL PRODUCT GUIDE.COM AND DESIGN. INT. CL. 35. REG. 3-12-2002.
- 2,546,523. MISCELLANEOUS DESIGN. INT. CL. 35. REG. 3-12-2002.
- 2,546,527. EZD. INT. CL. 35. REG. 3-12-2002.
- 2,546,528. BAG DEPOT. INT. CLS. 18, 22 AND 35. REG. 3-12-2002.
- 2,546,529. INPRIMIS TECHNOLOGIES AND DESIGN. INT. CL. 42. REG. 3-12-2002.
- 2,546,534. TOP Q AND DESIGN. INT. CL. 29. REG. 3-12-2002.
- 2,546,535. FRIENDSHIP CUBA. INT. CL. 42. REG. 3-12-2002.
- 2,546,536. REDNECK CARPORT. INT. CL. 22. REG. 3-12-2002.
- 2,546,537. ROCKETSNAIL. INT. CLS. 41 AND 42. REG. 3-12-2002.
- 2,546,538. MISCELLANEOUS DESIGN. INT. CL. 42. REG. 3-12-2002.
- 2,546,543. DR. HOWIE DO-IT. INT. CL. 41. REG. 3-12-2002.
- 2,546,545. EXPLORE THE VERTICAL. INT. CL. 41. REG. 3-12-2002.
- 2,546,546. NUTRABEAUTICALS. INT. CL. 3. REG. 3-12-2002.
- 2,546,551. VALLEY BROOK FARMS. INT. CL. 30. REG. 3-12-2002.
- 2,546,557. ZEIGLER (STYLIZED). INT. CL. 31. REG. 3-12-2002.
- 2,546,558. EL SIGLO (STYLIZED). INT. CL. 16. REG. 3-12-2002.
- 2,546,559. KWGC AND DESIGN. INT. CLS. 35 AND 42. REG. 3-12-2002.
- 2,546,560. KWGC. INT. CLS. 35 AND 42. REG. 3-12-2002.
- 2,546,561. NEW-EYES. INT. CL. 42. REG. 3-12-2002.
- 2,546,562. SOMERSET. INT. CL. 25. REG. 3-12-2002.
- 2,546,564. LOTION P50. INT. CLS. 3 AND 5. REG. 3-12-2002.
- 2,546,565. CASHMANAGEMENTSUPPLY.COM YOUR SOURCE FOR THE ITEMS YOU NEED TO MOVE YOUR MONEY AND DESIGN. INT. CL. 35. REG. 3-12-2002.
- 2,546,566. TOTAL ASSURANCE GUARANTEE (TAG). INT. CL. 40. REG. 3-12-2002.
- 2,546,568. DELANO GROUP SECURITIES AND DESIGN. INT. CL. 36. REG. 3-12-2002.
- 2,546,569. SOFTEEZ. INT. CL. 30. REG. 3-12-2002.
- 2,546,571. THE KNOWLEDGE AROUND YOU. INT. CL. 42. REG. 3-12-2002.
- 2,546,572. X104.5.COM AND DESIGN. INT. CL. 38. REG. 3-12-2002.
- 2,546,573. NATIONWIDE PRIVATE INVESTIGATIONS AND DESIGN. INT. CL. 42. REG. 3-12-2002.
- 2,546,577. LEATHERIQUE. INT. CL. 3. REG. 3-12-2002.
- 2,546,578. MASTRONET. INT. CL. 35. REG. 3-12-2002.
- 2,546,579. FRENCH MARKET DOUBLE VANILLA WHOLE BEAN NEW ORLEANS FAMOUS PREMIUM SPECIALTY COFFEES MARDI GRAS SINCE 1890 AND DESIGN. INT. CL. 30. REG. 3-12-2002.
- 2,546,584. AVER3-PORT. INT. CL. 9. REG. 3-12-2002.
- 2,546,585. AVERDV. INT. CL. 9. REG. 3-12-2002.

- 2,546,587. REVENUE TECHNOLOGIES AND DESIGN. INT. CL. 35. REG. 3-12-2002.
- 2,546,588. LES BEBES DU PARADIS. INT. CL. 24. REG. 3-12-2002.
- 2,546,589. LAUNCH POWER AND DESIGN. INT. CL. 35. REG. 3-12-2002.
- 2,546,594. MISCELLANEOUS DESIGN. INT. CL. 25. REG. 3-12-2002.
- 2,546,595. MISCELLANEOUS DESIGN. INT. CL. 25. REG. 3-12-2002.
- 2,546,596. MISCELLANEOUS DESIGN. INT. CL. 25. REG. 3-12-2002.
- 2,546,597. MISCELLANEOUS DESIGN. INT. CL. 25. REG. 3-12-2002.
- 2,546,599. ATLANTA NOW. INT. CL. 16. REG. 3-12-2002.
- 2,546,603. MOTOSK8. INT. CL. 28. REG. 3-12-2002.
- 2,546,614. COMMUNICATION ECOLOGY. INT. CL. 35. REG. 3-12-2002.
- 2,546,618. BAYADERA. INT. CL. 41. REG. 3-12-2002.
- 2,546,624. WORLDWIDEDATAGROUP.COM. INT. CL. 35. REG. 3-12-2002.
- 2,546,625. PROJECTBINDER. INT. CL. 9. REG. 3-12-2002.
- 2,546,626. TEXAS MUSIC HALL OF FAME AND DESIGN. INT. CL. 41. REG. 3-12-2002.
- 2,546,628. VALLEY BROOK FARMS AND DESIGN. INT. CL. 30. REG. 3-12-2002.
- 2,546,631. DAZEL. INT. CL. 42. REG. 3-12-2002.
- 2,546,632. TREAD-1 AND DESIGN. INT. CL. 9. REG. 3-12-2002.
- 2,546,634. NNC AND DESIGN. INT. CL. 42. REG. 3-12-2002.
- 2,546,635. NETEXEL. INT. CL. 42. REG. 3-12-2002.
- 2,546,636. LIGHTNING RIDGE AND DESIGN. INT. CL. 14. REG. 3-12-2002.
- 2,546,637. ADVANOUS ADVANTAGE THROUGH INTELLIGENCE AND DESIGN. INT. CL. 35. REG. 3-12-2002.
- 2,546,638. SNAPPLE BEANS AND DESIGN. INT. CL. 30. REG. 3-12-2002.
- 2,546,639. SNAPPLE FRUITS AND DESIGN. INT. CL. 30. REG. 3-12-2002.
- 2,546,640. MISCELLANEOUS DESIGN. INT. CLS. 18 AND 25. REG. 3-12-2002.
- 2,546,643. MAXBACKUP. INT. CL. 42. REG. 3-12-2002.
- 2,546,644. GEOMATICA AND DESIGN. INT. CL. 9. REG. 3-12-2002.
- 2,546,645. ITT INDUSTRIES ENGINEERED FOR LIFE AND DESIGN. INT. CL. 37. REG. 3-12-2002.
- 2,546,646. EFAPAUSE. INT. CL. 5. REG. 3-12-2002.
- 2,546,647. PETNET. INT. CLS. 38 AND 42. REG. 3-12-2002.
- 2,546,650. TERVIS TUMBLER MADE FOR LIFE AND DESIGN. INT. CL. 21. REG. 3-12-2002.
- 2,546,653. FIBERSENTRY. INT. CL. 11. REG. 3-12-2002.
- 2,546,654. JETSCRIPT AND DESIGN. INT. CL. 16. REG. 3-12-2002.
- 2,546,660. VOYAGES OF REDISCOVERY. INT. CL. 41. REG. 3-12-2002.
- 2,546,665. NB NEBRASKA BEEF AT ITS BEST AND DESIGN. INT. CL. 40. REG. 3-12-2002.
- 2,546,668. NMT POWERED SOLUTIONS. INT. CLS. 9 AND 42. REG. 3-12-2002.
- 2,546,669. S AND DESIGN. INT. CL. 36. REG. 3-12-2002.
- 2,546,670. PORTAPETS. INT. CL. 9. REG. 3-12-2002.
- 2,546,671. HELPS YOU MANAGE YOUR WORLD. INT. CL. 36. REG. 3-12-2002.
- 2,546,673. MY REAL ESTATE BOOK AND DESIGN. INT. CL. 36. REG. 3-12-2002.
- 2,546,676. HOT BODS & TAIL PIPE VIDEO MAGAZINE: THE SERIES. INT. CL. 9. REG. 3-12-2002.
- 2,546,677. WHAT'S NEW. INT. CL. 16. REG. 3-12-2002.
- 2,546,678. BETTER SOLUTIONS FOR YOUR HEALTH. INT. CLS. 36 AND 42. REG. 3-12-2002.
- 2,546,681. KION AND DESIGN. INT. CL. 1. REG. 3-12-2002.
- 2,546,682. HISTORIC JONESBOROUGH TENNESSEE'S OLDEST TOWN. INT. CL. 35. REG. 3-12-2002.
- 2,546,684. BSK. INT. CL. 35. REG. 3-12-2002.
- 2,546,685. TRAC. INT. CL. 42. REG. 3-12-2002.
- 2,546,686. TRAC TRACKING AGREEMENTS AND CONTACTS AND DESIGN. INT. CL. 42. REG. 3-12-2002.
- 2,546,687. LOADED WITH PRIDE. INT. CL. 39. REG. 3-12-2002.
- 2,546,688. APOTHE 'CURE NUTRITIONALS. INT. CL. 5. REG. 3-12-2002.
- 2,546,692. LUMABED. INT. CL. 35. REG. 3-12-2002.
- 2,546,693. SHIRASAGI X-7100. INT. CL. 1. REG. 3-12-2002.
- 2,546,696. PROFIX 2000. INT. CL. 17. REG. 3-12-2002.
- 2,546,697. KING SCHOOLS AND DESIGN. INT. CL. 9. REG. 3-12-2002.
- 2,546,698. LETSSTAYINTOUCH.COM. INT. CL. 42. REG. 3-12-2002.
- 2,546,702. IDIRECT. INT. CL. 36. REG. 3-12-2002.
- 2,546,706. IWA (STYLIZED). INT. CLS. 35, 39 AND 41. REG. 3-12-2002.
- 2,546,708. EPANEL. INT. CL. 41. REG. 3-12-2002.
- 2,546,714. MISCELLANEOUS DESIGN. INT. CL. 36. REG. 3-12-2002.
- 2,546,715. THE THIRD HAND COPY HOLDER. INT. CL. 16. REG. 3-12-2002.
- 2,546,717. MUNICIPALTRADE AND DESIGN. INT. CL. 36. REG. 3-12-2002.
- 2,546,720. ACCURATE CODING, INC. AND DESIGN. INT. CL. 35. REG. 3-12-2002.
- 2,546,722. QUIET POWER. INT. CL. 20. REG. 3-12-2002.
- 2,546,728. EQUITY CAPITAL NETWORK. INT. CL. 36. REG. 3-12-2002.
- 2,546,731. STRESS: BEYOND COPING. INT. CL. 16. REG. 3-12-2002.
- 2,546,736. GO WITH THE EXPERIENCED LEADER. INT. CLS. 35 AND 42. REG. 3-12-2002.
- 2,546,737. NLCM. INT. CL. 36. REG. 3-12-2002.
- 2,546,738. EBH CAPITAL TRUST I. INT. CL. 36. REG. 3-12-2002.
- 2,546,739. LEVELS XP. INT. CLS. 35 AND 42. REG. 3-12-2002.
- 2,546,741. CROOKBOOK. INT. CL. 9. REG. 3-12-2002.
- 2,546,743. NUTRIDHEA. INT. CL. 3. REG. 3-12-2002.
- 2,546,744. D AND DESIGN. INT. CLS. 35 AND 42. REG. 3-12-2002.
- 2,546,748. TRAC E AND DESIGN. INT. CL. 9. REG. 3-12-2002.
- 2,546,749. MEXLINK. INT. CL. 39. REG. 3-12-2002.
- 2,546,753. FSV FUNCTION SPACE VERIFICATION PROFESSIONAL CONVENTION MANAGEMENT ASSOCIATION AND DESIGN. U.S. CL. B. REG. 3-12-2002.
- 2,546,754. BRICK-ANEW MAKING MASONRY MIRACLES POSSIBLE! AND DESIGN. INT. CL. 2. REG. 3-12-2002.
- 2,546,758. GEOGAIN. INT. CL. 9. REG. 3-12-2002.
- 2,546,765. CLOUD 9. INT. CL. 41. REG. 3-12-2002.
- 2,546,768. LES LEARNING ENVIRONMENT SPECIALIST PROFESSIONAL CONVENTION MANAGEMENT ASSOCIATION AND DESIGN. U.S. CL. B. REG. 3-12-2002.
- 2,546,770. SECUREWALL AND DESIGN. INT. CL. 19. REG. 3-12-2002.
- 2,546,774. CAUTRE ENTERPRISE AND DESIGN. INT. CLS. 29 AND 30. REG. 3-12-2002.
- 2,546,775. GEORGIA BABY & KIDS. INT. CL. 35. REG. 3-12-2002.
- 2,546,776. UP YOUR ADS. INT. CL. 35. REG. 3-12-2002.
- 2,546,777. GELATELLI. INT. CL. 30. REG. 3-12-2002.
- 2,546,779. X-TECH. INT. CL. 18. REG. 3-12-2002.
- 2,546,782. THE ULTIMATE CONSERVATION MINDED CULLING SYSTEM. INT. CL. 28. REG. 3-12-2002.
- 2,546,783. DYNASWING. INT. CL. 28. REG. 3-12-2002.
- 2,546,785. DISCOVERY DAYS. INT. CL. 35. REG. 3-12-2002.
- 2,546,786. DAKOTA LAMB NATURALLY (STYLIZED). INT. CL. 29. REG. 3-12-2002.
- 2,546,787. GO 4 EXPRESS. INT. CL. 39. REG. 3-12-2002.
- 2,546,788. MISCELLANEOUS DESIGN. INT. CL. 35. REG. 3-12-2002.
- 2,546,789. MAGIC MIND FINDER (STYLIZED). INT. CL. 20. REG. 3-12-2002.

- 2,546,790. HILLSDALE. INT. CL. 35. REG. 3-12-2002.
2,546,792. UNDERDRIVE. INT. CL. 41. REG. 3-12-2002.
2,546,794. NCMIC DENTAL SOLUTIONS. INT. CL. 36. REG. 3-12-2002.
2,546,795. SAFENET CLUB. INT. CL. 9. REG. 3-12-2002.
2,546,797. ODORMAT. INT. CL. 5. REG. 3-12-2002.
2,546,798. CHIKA. INT. CL. 25. REG. 3-12-2002.
2,546,799. MINI-MOLE. INT. CL. 7. REG. 3-12-2002.
2,546,800. MISCELLANEOUS DESIGN. INT. CLS. 35 AND 36. REG. 3-12-2002.
2,546,801. CYBERGENICS FOR HARD GAINERS. INT. CL. 5. REG. 3-12-2002.
2,546,802. AMS AND DESIGN. INT. CL. 39. REG. 3-12-2002.
2,546,806. YADACARD. INT. CL. 9. REG. 3-12-2002.
2,546,809. WALDEN TOO. INT. CL. 35. REG. 3-12-2002.
2,546,810. EARTH STAR CONNECTION AND DESIGN. INT. CL. 35. REG. 3-12-2002.
2,546,811. THE PROFESSIONAL STANDARD. INT. CL. 16. REG. 3-12-2002.
2,546,815. FIRST UNION SECURITIES FINANCIAL NETWORK. INT. CL. 36. REG. 3-12-2002.
2,546,818. EMP EXPERIENCE MUSIC PROJECT AND DESIGN. INT. CL. 9. REG. 3-12-2002.
2,546,819. EMP EXPERIENCE MUSIC PROJECT AND DESIGN. INT. CL. 42. REG. 3-12-2002.
2,546,823. SCUMBUGS AND DESIGN. INT. CL. 7. REG. 3-12-2002.
2,546,824. CITYSKILLS. INT. CL. 35. REG. 3-12-2002.
2,546,825. AS4000. INT. CL. 9. REG. 3-12-2002.
2,546,831. A AND DESIGN. INT. CLS. 9 AND 42. REG. 3-12-2002.
2,546,832. APPRAISAL ACADEMY CONTINUING EDUCATION FOR REAL ESTATE PROFESSIONALS AND DESIGN. INT. CL. 41. REG. 3-12-2002.
2,546,833. ENERGY ATLANTIC. INT. CL. 35. REG. 3-12-2002.
2,546,836. CHILD CARE CENTRAL. INT. CLS. 41 AND 42. REG. 3-12-2002.
2,546,839. SESTECH. INT. CL. 35. REG. 3-12-2002.
2,546,840. ZINGLE-BERRY. INT. CL. 20. REG. 3-12-2002.
2,546,842. GOPROAUDIO. INT. CL. 35. REG. 3-12-2002.
2,546,847. OUT TO LUNCH. INT. CL. 41. REG. 3-12-2002.
2,546,849. EXPLORIA, EXPLORING INNOVATIVE CONCEPTS IN ANIMATION AND DESIGN. INT. CL. 41. REG. 3-12-2002.
2,546,850. LOS GOODNITES PRODUCEN UN BUEN DESPERTAR. INT. CL. 16. REG. 3-12-2002.
2,546,851. I LOVE PAN BECAUSE I PLAY PAN. INT. CL. 41. REG. 3-12-2002.
2,546,852. BIANCA PREMIER. INT. CL. 24. REG. 3-12-2002.
2,546,853. BIANCA JACQUARD. INT. CL. 24. REG. 3-12-2002.
2,546,856. BRITISH HERITAGE ONLINE. INT. CLS. 35, 38 AND 42. REG. 3-12-2002.
2,546,857. ESCENTUALS. INT. CL. 3. REG. 3-12-2002.
2,546,860. GOOF TOYS. INT. CL. 35. REG. 3-12-2002.
2,546,861. MAUI USA INC. AND DESIGN. INT. CL. 37. REG. 3-12-2002.
2,546,864. CODA FILTER SYSTEM AND DESIGN. INT. CL. 9. REG. 3-12-2002.
2,546,865. THE ANTICIPATING CHANGE WORKSHOP. INT. CL. 41. REG. 3-12-2002.
2,546,866. NUVEX INGREDIENTS INC.. INT. CL. 40. REG. 3-12-2002.
2,546,867. PASSOFATOR. INT. CLS. 11, 12 AND 13. REG. 3-12-2002.
2,546,869. THE ANSWER BED. INT. CL. 24. REG. 3-12-2002.
2,546,870. SMARTSTART. INT. CL. 41. REG. 3-12-2002.
2,546,873. THRONE. INT. CL. 41. REG. 3-12-2002.
2,546,875. NEAR & FAR FINDINGS FOR YOUR HOME. INT. CL. 35. REG. 3-12-2002.
2,546,877. COCKTAIL CHARMS. INT. CL. 14. REG. 3-12-2002.
2,546,880. ARIZONA BABIES. INT. CL. 3. REG. 3-12-2002.
2,546,881. SILVER SNOW CRYSTAL. INT. CL. 14. REG. 3-12-2002.
2,546,882. CALCULABLE CONTRACTS. INT. CL. 40. REG. 3-12-2002.
2,546,884. THE TRADER'S OASIS. INT. CL. 41. REG. 3-12-2002.
2,546,885. ACCU-QUIP. INT. CL. 7. REG. 3-12-2002.
2,546,886. GAY MONEY, STRAIGHT ADVICE.. INT. CL. 36. REG. 3-12-2002.
2,546,889. PAYOR. INT. CL. 25. REG. 3-12-2002.
2,546,891. MISCELLANEOUS DESIGN. INT. CL. 42. REG. 3-12-2002.
2,546,901. PAS. INT. CL. 38. REG. 3-12-2002.
2,546,904. IF THE SHOE FITS. INT. CL. 20. REG. 3-12-2002.
2,546,905. POT O' COLD. INT. CL. 32. REG. 3-12-2002.
2,546,911. GOPROAUDIO.COM AND DESIGN. INT. CL. 35. REG. 3-12-2002.
2,546,913. STARCREST. INT. CL. 25. REG. 3-12-2002.
2,546,915. FAST TRACK FUNDING. INT. CL. 36. REG. 3-12-2002.
2,546,920. THE VOODOO KINGS. INT. CL. 41. REG. 3-12-2002.
2,546,921. TINY SOFTWARE. INT. CL. 9. REG. 3-12-2002.
2,546,923. CITY CENTER VOICES! OF THE AMERICAN THEATER. INT. CL. 41. REG. 3-12-2002.
2,546,924. SYNAPS. INT. CL. 42. REG. 3-12-2002.
2,546,926. MULTISYS. INT. CL. 10. REG. 3-12-2002.
2,546,927. MULTISIS. INT. CL. 10. REG. 3-12-2002.
2,546,928. ASHLYN DESIGNS. INT. CL. 26. REG. 3-12-2002.
2,546,929. IKERIANE. INT. CLS. 3 AND 5. REG. 3-12-2002.
2,546,932. INDUSTRYTRAIN. INT. CLS. 9 AND 41. REG. 3-12-2002.
2,546,934. 21ST AND STONE (STYLIZED). INT. CL. 14. REG. 3-12-2002.
2,546,935. MENINASTAR ANN-TENNA. INT. CL. 20. REG. 3-12-2002.
2,546,936. CHICAGOLAND'S BIG SHOW. INT. CL. 41. REG. 3-12-2002.
2,546,938. XELLERATE ENTERPRISE. INT. CL. 9. REG. 3-12-2002.
2,546,939. NATURAL EXCELLENCE. INT. CL. 29. REG. 3-12-2002.
2,546,940. PIPELINE POLISH. INT. CL. 37. REG. 3-12-2002.
2,546,941. JUJU. INT. CL. 14. REG. 3-12-2002.
2,546,942. INDIVISUAL. INT. CL. 41. REG. 3-12-2002.
2,546,943. MICROTEx. INT. CL. 24. REG. 3-12-2002.
2,546,944. POWERED BY AHA DATA AND DESIGN. INT. CL. 35. REG. 3-12-2002.
2,546,945. WORLDNET GEAR. INT. CL. 25. REG. 3-12-2002.
2,546,946. EX-T.C.. INT. CL. 25. REG. 3-12-2002.
2,546,947. MISCELLANEOUS DESIGN. INT. CL. 35. REG. 3-12-2002.
2,546,948. AA AND DESIGN. INT. CL. 42. REG. 3-12-2002.
2,546,949. ALWAYS UP2DATE GUARANTEE. INT. CL. 38. REG. 3-12-2002.
2,546,954. BANKLISTENER. INT. CL. 35. REG. 3-12-2002.
2,546,956. MEDIALISTENER. INT. CL. 35. REG. 3-12-2002.
2,546,957. AUCTIONLISTENER. INT. CL. 35. REG. 3-12-2002.
2,546,958. STUDENTLISTENER. INT. CL. 35. REG. 3-12-2002.
2,546,959. TRADELISTENER. INT. CL. 35. REG. 3-12-2002.
2,546,960. TRADEASSOCIATIONLISTENER. INT. CL. 35. REG. 3-12-2002.
2,546,961. WSFR. INT. CL. 42. REG. 3-12-2002.
2,546,962. WINE&SPIRITSLISTENER. INT. CL. 35. REG. 3-12-2002.
2,546,963. C AND DESIGN. INT. CLS. 25 AND 42. REG. 3-12-2002.
2,546,964. THE MEDICINE BEHIND THE IMAGE. INT. CL. 42. REG. 3-12-2002.
2,546,967. PRONGO. INT. CL. 41. REG. 3-12-2002.
2,546,968. WORLD TRADE SPACE COAST COUNCIL AND DESIGN. INT. CL. 41. REG. 3-12-2002.
2,546,971. BODY MACHINE. INT. CL. 25. REG. 3-12-2002.
2,546,972. LIFT. INT. CL. 36. REG. 3-12-2002.
2,546,976. DYNAMICWELLNESS AND DESIGN. INT. CL. 42. REG. 3-12-2002.
2,546,979. ARC-D-TECT. INT. CL. 9. REG. 3-12-2002.
2,546,982. SLAYMEISTER. INT. CL. 28. REG. 3-12-2002.

- 2,546,988. CONTEMPORARY DIAGNOSIS AND MANAGEMENT OF ALZHEIMER'S DISEASE. INT. CL. 16. REG. 3-12-2002.
- 2,546,989. FINANCECORE (STYLIZED). INT. CL. 36. REG. 3-12-2002.
- 2,546,990. STAT PUMP. INT. CL. 7. REG. 3-12-2002.
- 2,546,991. GOOD FOR THE PEOPLE. GOOD FOR THE PLANET.. INT. CL. 30. REG. 3-12-2002.
- 2,546,993. HOPE'S GIFT - INTERNATIONAL. INT. CL. 35. REG. 3-12-2002.
- 2,546,995. COMPLIANCEFLASH. INT. CL. 42. REG. 3-12-2002.
- 2,546,996. ROSSFORD. INT. CLS. 16, 20 AND 21. REG. 3-12-2002.
- 2,546,997. ME THE MENACE ENTERTAINMENT GROUP LLC. AND DESIGN. INT. CL. 9. REG. 3-12-2002.
- 2,546,999. WHERE IT COSTS LESS TO CATCH MORE. INT. CL. 28. REG. 3-12-2002.
- 2,547,000. CHAIN REACTION. INT. CL. 41. REG. 3-12-2002.
- 2,547,001. TOYOYAMA USA. INT. CL. 7. REG. 3-12-2002.
- 2,547,002. PETFOOD2U. INT. CL. 35. REG. 3-12-2002.
- 2,547,004. CAFE MONDIAL AND DESIGN. INT. CL. 30. REG. 3-12-2002.
- 2,547,008. UMLAA. INT. CLS. 36 AND 42. REG. 3-12-2002.
- 2,547,010. US LANDRUSH.COM AND DESIGN. INT. CL. 36. REG. 3-12-2002.
- 2,547,011. FUTURE OLYMPIAN. INT. CL. 20. REG. 3-12-2002.
- 2,547,012. MEGA FORCE TEAM AND DESIGN. INT. CL. 41. REG. 3-12-2002.
- 2,547,013. BLACK ROSE ANTIQUES & COLLECTIBLES AND DESIGN. INT. CL. 35. REG. 3-12-2002.
- 2,547,015. GIGANTIC ANT.COM AND DESIGN. INT. CLS. 35 AND 42. REG. 3-12-2002.
- 2,547,017. FLEXTAC. INT. CL. 16. REG. 3-12-2002.
- 2,547,019. FANSTEEL ESCAST. INT. CL. 6. REG. 3-12-2002.
- 2,547,020. MISCELLANEOUS DESIGN. INT. CL. 8. REG. 3-12-2002.
- 2,547,022. BIOREWARDS. INT. CL. 35. REG. 3-12-2002.
- 2,547,023. EQUIDITY AND DESIGN. INT. CL. 42. REG. 3-12-2002.
- 2,547,024. THERMOFLUTE. INT. CLS. 16 AND 21. REG. 3-12-2002.
- 2,547,031. DIRT DETECTIVES. INT. CL. 41. REG. 3-12-2002.
- 2,547,032. JAYA (STYLIZED). INT. CL. 41. REG. 3-12-2002.
- 2,547,034. MISCELLANEOUS DESIGN. INT. CL. 28. REG. 3-12-2002.
- 2,547,036. TINY TOUCH. INT. CL. 28. REG. 3-12-2002.
- 2,547,038. CTB WIRELESS, INC. DISTRIBUTOR OF CELLULAR PHONES AND ACCESSORIES FOR THE CORPORATE AND WIRELESS WORLD (STYLIZED). INT. CL. 35. REG. 3-12-2002.
- 2,547,040. ENGINEERING STAR COLLABORATIVE AND DESIGN. INT. CL. 42. REG. 3-12-2002.
- 2,547,041. MILLENNIA AND DESIGN. INT. CL. 5. REG. 3-12-2002.
- 2,547,043. BCD FORUM AND DESIGN. INT. CL. 42. REG. 3-12-2002.
- 2,547,044. MISCELLANEOUS DESIGN. INT. CLS. 35, 41 AND 42. REG. 3-12-2002.
- 2,547,046. CLARK/BARDES CONSULTING. INT. CL. 36. REG. 3-12-2002.
- 2,547,047. TECHNOLOGY ON PREMISES. INT. CL. 37. REG. 3-12-2002.
- 2,547,049. THE LITTLE CITY THAT BUILDS BIG IMAGINATIONS. INT. CL. 41. REG. 3-12-2002.
- 2,547,053. MR. HIRE. INT. CL. 35. REG. 3-12-2002.
- 2,547,057. MONEYJINGLE.COM. INT. CL. 35. REG. 3-12-2002.
- 2,547,060. MERLIN. INT. CL. 9. REG. 3-12-2002.
- 2,547,062. UTAH STARZZ AND DESIGN. INT. CL. 38. REG. 3-12-2002.
- 2,547,064. RUSTIC RECORDS. INT. CL. 9. REG. 3-12-2002.
- 2,547,065. JENNER & BLOCK, LLC. INT. CL. 42. REG. 3-12-2002.
- 2,547,066. IVANO BIAGI. INT. CL. 25. REG. 3-12-2002.
- 2,547,067. IVANO BIAGI MODA ITALIANA AND DESIGN. INT. CL. 25. REG. 3-12-2002.
- 2,547,068. E STICK E. WEB AND DESIGN. INT. CLS. 35 AND 42. REG. 3-12-2002.
- 2,547,069. ATHENA. INT. CL. 28. REG. 3-12-2002.
- 2,547,070. SLUMPERS. INT. CL. 28. REG. 3-12-2002.
- 2,547,071. VIRGIL. INT. CL. 28. REG. 3-12-2002.
- 2,547,073. KILOJOLTS CONSULTING GROUP AND DESIGN. INT. CLS. 16, 35 AND 42. REG. 3-12-2002.
- 2,547,076. RADIOLOGY ADVOCACY ALLIANCE AND DESIGN. INT. CLS. 16 AND 42. REG. 3-12-2002.
- 2,547,077. JEFRI JEANS. INT. CL. 25. REG. 3-12-2002.
- 2,547,078. BUTTER SLICK SHINE AND DESIGN. INT. CL. 3. REG. 3-12-2002.
- 2,547,081. FRANK KENT FK MOTOR COMPANY AND DESIGN. INT. CL. 35. REG. 3-12-2002.
- 2,547,082. THE MIGHTY DINOSAUR. INT. CL. 28. REG. 3-12-2002.
- 2,547,085. VITA NUTRICS. INT. CL. 35. REG. 3-12-2002.
- 2,547,087. INNOVATIVE SOLUTIONS, EFFECTIVE SECURITY. INT. CL. 42. REG. 3-12-2002.
- 2,547,089. PHARMATACTICAL. INT. CL. 35. REG. 3-12-2002.
- 2,547,090. RED BEAR. INT. CL. 3. REG. 3-12-2002.
- 2,547,093. NATURASE. INT. CL. 1. REG. 3-12-2002.
- 2,547,095. AIDS VACCINE RIDE. INT. CL. 36. REG. 3-12-2002.
- 2,547,096. AIDS VACCINE RIDES. INT. CL. 36. REG. 3-12-2002.
- 2,547,098. U C HOW. INT. CL. 42. REG. 3-12-2002.
- 2,547,102. EXPERIENCE THE CHASE...CHASE THE EXPERIENCE. INT. CL. 28. REG. 3-12-2002.
- 2,547,104. MISCELLANEOUS DESIGN. INT. CL. 21. REG. 3-12-2002.
- 2,547,105. PULL-OAR. INT. CL. 12. REG. 3-12-2002.
- 2,547,106. SKATER AID. INT. CL. 5. REG. 3-12-2002.
- 2,547,109. REFERRALS BY DESIGN. INT. CL. 41. REG. 3-12-2002.
- 2,547,112. FRIENDSHIP FAIRIES. INT. CL. 28. REG. 3-12-2002.
- 2,547,113. FUSE'M BEADS. INT. CL. 28. REG. 3-12-2002.
- 2,547,115. SOHO MAGIC. INT. CL. 28. REG. 3-12-2002.
- 2,547,116. PUNCTUR-GUARD REVOLUTION. INT. CL. 10. REG. 3-12-2002.
- 2,547,120. SENIOR INSIGHTS. INT. CL. 35. REG. 3-12-2002.
- 2,547,122. NEWS YOU CARE ABOUT. INT. CL. 41. REG. 3-12-2002.
- 2,547,123. CALMING ORGANIC CAMOMILE. INT. CL. 30. REG. 3-12-2002.
- 2,547,125. ASSOCIATED NEW AMERICAN COLLEGES. INT. CL. 42. REG. 3-12-2002.
- 2,547,127. CHRONICLES OF THE BOLD & CURIOUS. INT. CL. 16. REG. 3-12-2002.
- 2,547,134. MATERIAL HANDLING & LOGISTICS PORTAL AND DESIGN. INT. CL. 42. REG. 3-12-2002.
- 2,547,135. MEZZIA DEMAND PLANNER. INT. CL. 42. REG. 3-12-2002.
- 2,547,137. VERILINK ONLINE TECHNICAL SUPPORT. INT. CL. 42. REG. 3-12-2002.
- 2,547,141. TOE-LASSO. INT. CL. 14. REG. 3-12-2002.
- 2,547,142. WIRED NEWS. INT. CL. 42. REG. 3-12-2002.
- 2,547,143. WEE-WEE A GO-GO. INT. CL. 3. REG. 3-12-2002.
- 2,547,144. NANOLINE. INT. CL. 9. REG. 3-12-2002.
- 2,547,145. DIRECTV PARA TODOS ESTE MES. INT. CL. 16. REG. 3-12-2002.
- 2,547,149. TUKACUT. INT. CL. 7. REG. 3-12-2002.
- 2,547,153. SHU-GLO. INT. CL. 3. REG. 3-12-2002.
- 2,547,154. BIANCA EMBELLISHED. INT. CL. 24. REG. 3-12-2002.
- 2,547,155. SPEEDLE AND DESIGN. INT. CL. 26. REG. 3-12-2002.
- 2,547,157. ARE THERE ANY HOLES IN YOUR PRESENT OR FUTURE?. INT. CL. 7. REG. 3-12-2002.
- 2,547,160. SMART SETS. INT. CL. 20. REG. 3-12-2002.
- 2,547,161. TAAS CONNECTION. INT. CL. 16. REG. 3-12-2002.
- 2,547,162. BEAUTY SPIRAL. INT. CL. 3. REG. 3-12-2002.
- 2,547,167. TELL IT RECORDS. INT. CL. 9. REG. 3-12-2002.
- 2,547,171. COMPANION AIR. INT. CL. 39. REG. 3-12-2002.
- 2,547,176. XLEARDENT. INT. CL. 30. REG. 3-12-2002.

- 2,547,178. GRANDMA LA MURE'S SPICE 'N SLICE. INT. CL. 30. REG. 3-12-2002.
- 2,547,179. BRASIF SHOPPING. INT. CL. 35. REG. 3-12-2002.
- 2,547,181. BRINGING HOPE TO SINGLE MOMS AND DESIGN. INT. CL. 41. REG. 3-12-2002.
- 2,547,182. SOUNDKNOWLEDGE. INT. CL. 9. REG. 3-12-2002.
- 2,547,183. 20TH CENTURY FOX AND DESIGN. INT. CL. 9. REG. 3-12-2002.
- 2,547,184. ETORIA E ETORIA AND DESIGN. INT. CL. 12. REG. 3-12-2002.
- 2,547,185. PROMECON. INT. CL. 9. REG. 3-12-2002.
- 2,547,187. EARLYBLOOMERS.COM. INT. CL. 35. REG. 3-12-2002.
- 2,547,190. THE DAILY COUGAR. INT. CL. 16. REG. 3-12-2002.
- 2,547,191. E AND DESIGN. INT. CL. 42. REG. 3-12-2002.
- 2,547,192. THE DAILY COUGAR ONLINE. INT. CL. 42. REG. 3-12-2002.
- 2,547,197. A WASH COME TRUE. INT. CL. 3. REG. 3-12-2002.
- 2,547,202. ACTIONPATH. INT. CL. 9. REG. 3-12-2002.
- 2,547,203. W C DESIGNS AND DESIGN. INT. CL. 12. REG. 3-12-2002.
- 2,547,204. HALF BIRTHDAY. INT. CLS. 21 AND 28. REG. 3-12-2002.
- 2,547,206. SANI-VAP. INT. CL. 5. REG. 3-12-2002.
- 2,547,210. NUTRECONOMICS. INT. CL. 42. REG. 3-12-2002.
- 2,547,212. ACRO AND DESIGN. INT. CL. 35. REG. 3-12-2002.
- 2,547,213. ACRO AND DESIGN. INT. CL. 37. REG. 3-12-2002.
- 2,547,214. POWER CIRCLE. INT. CL. 28. REG. 3-12-2002.
- 2,547,217. ISAC COMMUNICATIONS. INT. CLS. 37 AND 42. REG. 3-12-2002.
- 2,547,218. DURANGO & SILVERTON NARROW GAUGE RAILROAD. INT. CL. 41. REG. 3-12-2002.
- 2,547,219. DURANGO & SILVERTON NARROW GAUGE RAILROAD. INT. CL. 25. REG. 3-12-2002.
- 2,547,220. APPLIED CAREER TRAINING THE ALLIED HEALTH SCHOOL AND DESIGN. INT. CL. 41. REG. 3-12-2002.
- 2,547,221. ROUNDUP. INT. CL. 21. REG. 3-12-2002.
- 2,547,222. MEMXPLUS. INT. CL. 5. REG. 3-12-2002.
- 2,547,223. G SPOT. INT. CL. 30. REG. 3-12-2002.
- 2,547,224. ELEGANCE (STYLIZED). INT. CL. 19. REG. 3-12-2002.
- 2,547,230. IMPACT BODYGEAR. INT. CL. 25. REG. 3-12-2002.
- 2,547,232. COLOSOURCE. INT. CL. 35. REG. 3-12-2002.
- 2,547,234. EXTREMESPIN. INT. CL. 35. REG. 3-12-2002.
- 2,547,237. E-FOAM. INT. CL. 20. REG. 3-12-2002.
- 2,547,238. KARISTRAK. INT. CL. 9. REG. 3-12-2002.
- 2,547,241. SHOWROOM SEVEN. INT. CL. 35. REG. 3-12-2002.
- 2,547,242. WISCONSIN PASTURELANDS. INT. CL. 29. REG. 3-12-2002.
- 2,547,247. CRUDBUSTERS. INT. CL. 37. REG. 3-12-2002.
- 2,547,250. TAKE YOUR LIFE FROM MONOCHROME TO TECHNICOLOR. INT. CL. 41. REG. 3-12-2002.
- 2,547,252. GORILLA POWDERCOATING. INT. CL. 40. REG. 3-12-2002.
- 2,547,253. WIRESONG JEWELRY. INT. CL. 14. REG. 3-12-2002.
- 2,547,260. SKY BARON BALL. INT. CL. 36. REG. 3-12-2002.
- 2,547,261. CAVIT. INT. CL. 9. REG. 3-12-2002.
- 2,547,265. USERMAIL.COM. INT. CL. 38. REG. 3-12-2002.
- 2,547,267. OSH ORCHARD SUPER HARDWARE AND DESIGN. INT. CL. 35. REG. 3-12-2002.
- 2,547,269. DINE ON THE DASH BUT STASH YOUR TRASH. INT. CL. 35. REG. 3-12-2002.
- 2,547,273. WASHUGYU. INT. CL. 29. REG. 3-12-2002.
- 2,547,274. INDIVIDUALS (STYLIZED). INT. CL. 20. REG. 3-12-2002.
- 2,547,278. FOWL LANGUAGE. INT. CL. 28. REG. 3-12-2002.
- 2,547,291. MISCELLANEOUS DESIGN. INT. CL. 42. REG. 3-12-2002.
- 2,547,299. FIVE BROTHERS HARVEST RESERVE. INT. CL. 30. REG. 3-12-2002.
- 2,547,300. COMMUNITY COMMONS. INT. CL. 16. REG. 3-12-2002.
- 2,547,301. MINTEK (STYLIZED). INT. CL. 9. REG. 3-12-2002.
- 2,547,304. SHADOWMARCH. INT. CL. 9. REG. 3-12-2002.
- 2,547,306. AUTOENCRYPTAUR. INT. CL. 9. REG. 3-12-2002.
- 2,547,307. CHELSEY & JACK. INT. CL. 25. REG. 3-12-2002.
- 2,547,309. ACUITY. INT. CLS. 35 AND 42. REG. 3-12-2002.
- 2,547,313. CHEMICAL PRODUCTS TECHNOLOGIES. INT. CL. 5. REG. 3-12-2002.
- 2,547,316. PEACE CREATURES. INT. CL. 42. REG. 3-12-2002.
- 2,547,317. PEACE CREATURES. INT. CL. 41. REG. 3-12-2002.
- 2,547,319. CAYMAN. INT. CL. 9. REG. 3-12-2002.
- 2,547,320. MISCELLANEOUS DESIGN. INT. CL. 30. REG. 3-12-2002.
- 2,547,321. PEPPERWOOD GROVE AND DESIGN. INT. CL. 33. REG. 3-12-2002.
- 2,547,324. MAJOR, HAGEN & AFRICA. INT. CL. 35. REG. 3-12-2002.
- 2,547,327. URINCHEK. INT. CL. 5. REG. 3-12-2002.
- 2,547,335. NFQHA. INT. CL. 42. REG. 3-12-2002.
- 2,547,338. CHEAP BUT NEVER CHEEZY. INT. CL. 28. REG. 3-12-2002.
- 2,547,340. SKY-BYTE. INT. CL. 28. REG. 3-12-2002.
- 2,547,342. THE CAPITAL CHART ROOM LLC. INT. CL. 36. REG. 3-12-2002.
- 2,547,344. SPLATTERDOME. INT. CL. 16. REG. 3-12-2002.
- 2,547,345. CTF CONFIGURE TO FIT AND DESIGN. INT. CL. 35. REG. 3-12-2002.
- 2,547,346. CTF CONFIGURE TO FIT AND DESIGN. INT. CL. 42. REG. 3-12-2002.
- 2,547,347. R2I. INT. CL. 9. REG. 3-12-2002.
- 2,547,348. MISCELLANEOUS DESIGN. INT. CL. 3. REG. 3-12-2002.
- 2,547,349. LAB SEAL. INT. CL. 9. REG. 3-12-2002.
- 2,547,350. PERFECT WAVE SURF SHOP. INT. CL. 35. REG. 3-12-2002.
- 2,547,351. LUXEVAN AND DESIGN. INT. CL. 3. REG. 3-12-2002.
- 2,547,357. MISCELLANEOUS DESIGN. INT. CL. 14. REG. 3-12-2002.
- 2,547,358. SYSTALEX. INT. CL. 42. REG. 3-12-2002.
- 2,547,359. GREAT CHEFS. INT. CL. 16. REG. 3-12-2002.
- 2,547,362. WM AND DESIGN. INT. CL. 35. REG. 3-12-2002.
- 2,547,364. ONE HEART LIGHTMIST. INT. CL. 3. REG. 3-12-2002.
- 2,547,365. GUARDEX. INT. CL. 42. REG. 3-12-2002.
- 2,547,366. MAYO CLINIC. INT. CL. 9. REG. 3-12-2002.
- 2,547,370. LOS GREYS. INT. CL. 9. REG. 3-12-2002.
- 2,547,371. COMMSTART. INT. CL. 5. REG. 3-12-2002.
- 2,547,378. ANCOTECH. INT. CL. 6. REG. 3-12-2002.
- 2,547,379. MENTAT. INT. CL. 9. REG. 3-12-2002.
- 2,547,382. PAMLICO. INT. CL. 20. REG. 3-12-2002.
- 2,547,383. AR (STYLIZED). INT. CL. 35. REG. 3-12-2002.
- 2,547,384. BOOM. INT. CL. 9. REG. 3-12-2002.
- 2,547,388. OPTIRAD. INT. CL. 9. REG. 3-12-2002.
- 2,547,391. PURE FOCUS. INT. CL. 5. REG. 3-12-2002.
- 2,547,394. DO IT ON THE ROCKS. INT. CL. 32. REG. 3-12-2002.
- 2,547,395. LIVPUR AND DESIGN. INT. CL. 41. REG. 3-12-2002.
- 2,547,400. PRO X. INT. CL. 12. REG. 3-12-2002.
- 2,547,402. VIM AND DESIGN. INT. CL. 5. REG. 3-12-2002.
- 2,547,404. LECTURE. INT. CL. 9. REG. 3-12-2002.
- 2,547,405. CVBDESIGNS. INT. CL. 42. REG. 3-12-2002.
- 2,547,409. MASSAGEWARE (STYLIZED). INT. CL. 9. REG. 3-12-2002.
- 2,547,411. ANNA CHUNG SAN FRANCISCO AND DESIGN. INT. CL. 25. REG. 3-12-2002.
- 2,547,412. OTG SOFTWARE. INT. CL. 42. REG. 3-12-2002.
- 2,547,413. 2C NETWORK. INT. CL. 42. REG. 3-12-2002.
- 2,547,414. BLUE MAX AND DESIGN. INT. CL. 9. REG. 3-12-2002.
- 2,547,416. THE GIVING WEB DESIGN THAT MAKES A DIFFERENCE AND DESIGN. INT. CL. 42. REG. 3-12-2002.
- 2,547,417. CYTRANZ. INT. CL. 42. REG. 3-12-2002.

- 2,547,418. WA WIRELESS APPLICATIONS, CORP. CONNECTING WIRELESS... AND DESIGN. INT. CL. 42. REG. 3-12-2002.
- 2,547,420. NUBAR. INT. CL. 3. REG. 3-12-2002.
- 2,547,421. ANU-VIEW. INT. CL. 42. REG. 3-12-2002.
- 2,547,422. HELLONOW. INT. CL. 38. REG. 3-12-2002.
- 2,547,424. GRANT REED. INT. CL. 9. REG. 3-12-2002.
- 2,547,425. MISCELLANEOUS DESIGN. INT. CL. 25. REG. 3-12-2002.
- 2,547,428. THE LEGENDS OF DOOWOP. INT. CL. 41. REG. 3-12-2002.
- 2,547,429. WE PUT THE IMAGE IN IMAGINATION. INT. CLS. 35, 41 AND 42. REG. 3-12-2002.
- 2,547,431. R.E.G.R.O.U.P. REMOTE EXECUTIVE GOAL REVIEW AND OPPORTUNITY UNCOVERING PROCESS. INT. CL. 41. REG. 3-12-2002.
- 2,547,432. IT INGLES TOTAL. INT. CLS. 9, 16 AND 41. REG. 3-12-2002.
- 2,547,433. START ABROAD. INT. CL. 35. REG. 3-12-2002.
- 2,547,434. WEB DESIGN ETC. INT. CL. 42. REG. 3-12-2002.
- 2,547,437. MICROSAFE. INT. CL. 23. REG. 3-12-2002.
- 2,547,439. DSBWDIRECT. INT. CL. 36. REG. 3-12-2002.
- 2,547,442. INNER BALANCE. INT. CL. 42. REG. 3-12-2002.
- 2,547,444. MADISON REALTY. INT. CL. 36. REG. 3-12-2002.
- 2,547,446. SAFE SIDE SHEETS BE ON THE SAFE SIDE. INT. CL. 24. REG. 3-12-2002.
- 2,547,447. NATURE'S FINEST. INT. CL. 14. REG. 3-12-2002.
- 2,547,448. UNDIS FUNDAY. INT. CL. 42. REG. 3-12-2002.
- 2,547,452. NUTRISOL. INT. CL. 1. REG. 3-12-2002.
- 2,547,453. KANIKA KULTURE AND DESIGN. INT. CL. 21. REG. 3-12-2002.
- 2,547,455. IMMEDIATOOLS. INT. CL. 9. REG. 3-12-2002.
- 2,547,457. JONES NEW YORK ESSENTIALS. INT. CL. 25. REG. 3-12-2002.
- 2,547,460. CHOLESBLOCK. INT. CL. 5. REG. 3-12-2002.
- 2,547,462. VIVOMAN. INT. CL. 25. REG. 3-12-2002.
- 2,547,463. VAN-ACTION. INT. CLS. 12 AND 37. REG. 3-12-2002.
- 2,547,464. MUD KING. INT. CL. 7. REG. 3-12-2002.
- 2,547,467. B BETA STEEL AND DESIGN. INT. CL. 6. REG. 3-12-2002.
- 2,547,468. DECOR EXPRESS AND DESIGN. INT. CL. 24. REG. 3-12-2002.
- 2,547,469. DECATHLON. INT. CLS. 9 AND 28. REG. 3-12-2002.
- 2,547,470. MISCELLANEOUS DESIGN. INT. CL. 25. REG. 3-12-2002.
- 2,547,472. MR. RICE. INT. CL. 11. REG. 3-12-2002.
- 2,547,476. CARE NAVIGATOR. INT. CL. 9. REG. 3-12-2002.
- 2,547,478. ROADNET AND DESIGN. INT. CL. 9. REG. 3-12-2002.
- 2,547,479. POWERPULSE. INT. CL. 12. REG. 3-12-2002.
- 2,547,480. FLOWSURE AND DESIGN. INT. CL. 9. REG. 3-12-2002.
- 2,547,482. ACNIELSEN. INT. CL. 42. REG. 3-12-2002.
- 2,547,483. AUTHORITY AND DESIGN. INT. CL. 5. REG. 3-12-2002.
- 2,547,485. ORCA. INT. CL. 9. REG. 3-12-2002.
- 2,547,486. ENERGY DEPOT. INT. CLS. 35 AND 37. REG. 3-12-2002.
- 2,547,487. INDRA'S NET. INT. CL. 42. REG. 3-12-2002.
- 2,547,488. LIFTMAN. INT. CL. 39. REG. 3-12-2002.
- 2,547,490. GOALMINDER. INT. CL. 9. REG. 3-12-2002.
- 2,547,491. CLASSORIENTOR. INT. CLS. 7 AND 40. REG. 3-12-2002.
- 2,547,493. VOICENET. INT. CL. 9. REG. 3-12-2002.
- 2,547,494. LASERBRUSH. INT. CL. 21. REG. 3-12-2002.
- 2,547,496. VHR. INT. CL. 35. REG. 3-12-2002.
- 2,547,497. VHR (STYLIZED). INT. CL. 35. REG. 3-12-2002.
- 2,547,498. PANAVUE. INT. CL. 9. REG. 3-12-2002.
- 2,547,499. MAGNAPONICS. INT. CL. 9. REG. 3-12-2002.
- 2,547,501. GEOMETRAY. INT. CL. 21. REG. 3-12-2002.
- 2,547,503. STORYSPINNERS. INT. CL. 16. REG. 3-12-2002.
- 2,547,504. STORYSPINNERS. INT. CL. 9. REG. 3-12-2002.
- 2,547,506. SMART FLOORING. INT. CL. 19. REG. 3-12-2002.
- 2,547,510. CHERISHMENT. INT. CLS. 41 AND 42. REG. 3-12-2002.
- 2,547,512. FUJIEXE. INT. CL. 28. REG. 3-12-2002.
- 2,547,513. SHERWOOD (STYLIZED). INT. CL. 19. REG. 3-12-2002.
- 2,547,515. FAMILY BUSINESS SUCCESSION THE SUCCESSION ACADEMY A DIVISION OF THE FAMILY BUSINESS RESOURCE CENTER STRATEGIC FINANCIAL AND DESIGN. INT. CLS. 35 AND 41. REG. 3-12-2002.
- 2,547,516. THE OPENING ACT. INT. CLS. 9 AND 41. REG. 3-12-2002.
- 2,547,517. SUPER GRIPPER. INT. CL. 6. REG. 3-12-2002.
- 2,547,518. ORLANDO RAYS AND DESIGN. INT. CL. 6. REG. 3-12-2002.
- 2,547,522. INTELLIGENT STOCK. INT. CL. 42. REG. 3-12-2002.
- 2,547,525. TECHNOCODE. INT. CL. 42. REG. 3-12-2002.
- 2,547,526. ASPECT AND DESIGN. INT. CLS. 39, 41 AND 42. REG. 3-12-2002.
- 2,547,530. WIDOWWEAR. INT. CL. 25. REG. 3-12-2002.
- 2,547,533. MILLWORK. INT. CL. 35. REG. 3-12-2002.
- 2,547,534. ROBO HAMMER. INT. CL. 8. REG. 3-12-2002.
- 2,547,536. KNOW BRAINER AND DESIGN. INT. CL. 9. REG. 3-12-2002.
- 2,547,537. MISCELLANEOUS DESIGN. INT. CL. 41. REG. 3-12-2002.
- 2,547,542. SUPER PACK'R KITCHEN TRASH SMASHER. INT. CL. 8. REG. 3-12-2002.
- 2,547,544. MISCELLANEOUS DESIGN. INT. CL. 25. REG. 3-12-2002.
- 2,547,545. MAGIC SOCKS. INT. CL. 25. REG. 3-12-2002.
- 2,547,546. DREAMFIGHTER. INT. CL. 41. REG. 3-12-2002.
- 2,547,547. ROCK CONCERT FROM HELL. INT. CL. 41. REG. 3-12-2002.
- 2,547,548. ENGINE DYNAMICS. INT. CL. 7. REG. 3-12-2002.
- 2,547,549. WE'D RATHER NOT MEET THIS WAY. INT. CL. 16. REG. 3-12-2002.
- 2,547,550. GUAPO. INT. CL. 25. REG. 3-12-2002.
- 2,547,553. AQUAQUICK. INT. CL. 12. REG. 3-12-2002.
- 2,547,554. CYBORG GAMES. INT. CL. 41. REG. 3-12-2002.
- 2,547,555. BASIC ELEMENTS. INT. CL. 14. REG. 3-12-2002.
- 2,547,556. K.I.D.S. K-12 INTERNET DELIVERY SYSTEM AND DESIGN. INT. CL. 9. REG. 3-12-2002.
- 2,547,558. BILENIATECH. INT. CL. 42. REG. 3-12-2002.
- 2,547,562. VULCAN DIRECT. INT. CL. 9. REG. 3-12-2002.
- 2,547,563. TEDDIES & TALES AND DESIGN. INT. CL. 40. REG. 3-12-2002.
- 2,547,564. PENTIUM. INT. CL. 42. REG. 3-12-2002.
- 2,547,565. INTEL INSIDE AND DESIGN. INT. CL. 42. REG. 3-12-2002.
- 2,547,576. MISCELLANEOUS DESIGN. INT. CL. 3. REG. 3-12-2002.
- 2,547,577. WESCONE AND DESIGN. INT. CL. 7. REG. 3-12-2002.
- 2,547,578. MEDIA MAX. INT. CL. 7. REG. 3-12-2002.
- 2,547,580. C'EST LA VIE. INT. CL. 31. REG. 3-12-2002.
- 2,547,581. ZEBRA SCREEN. INT. CL. 7. REG. 3-12-2002.
- 2,547,582. ZEBRA. INT. CL. 7. REG. 3-12-2002.
- 2,547,583. DIME.QUOTE (STYLIZED). INT. CL. 36. REG. 3-12-2002.
- 2,547,584. ANGEL CHILD. INT. CL. 20. REG. 3-12-2002.
- 2,547,585. TINOFAST. INT. CL. 1. REG. 3-12-2002.
- 2,547,586. ECONO TAINER. INT. CL. 6. REG. 3-12-2002.
- 2,547,587. BUSINESS BENEFIT ADVANTAGE. INT. CL. 36. REG. 3-12-2002.
- 2,547,588. CROWN CRAFTERS. INT. CL. 42. REG. 3-12-2002.
- 2,547,589. ATACLICK. INT. CLS. 35 AND 38. REG. 3-12-2002.
- 2,547,590. CORR-CHECK. INT. CL. 40. REG. 3-12-2002.
- 2,547,592. ARC INTERNATIONAL FUND. INT. CL. 36. REG. 3-12-2002.
- 2,547,593. EQUISOURCE. INT. CL. 16. REG. 3-12-2002.
- 2,547,594. SYMBOLS AND CELEBRATIONS. INT. CL. 35. REG. 3-12-2002.
- 2,547,595. DANELLE. INT. CL. 25. REG. 3-12-2002.
- 2,547,596. DELIVERYMAN. INT. CL. 9. REG. 3-12-2002.
- 2,547,597. PANEX. INT. CL. 6. REG. 3-12-2002.
- 2,547,598. METROWASH. INT. CL. 7. REG. 3-12-2002.
- 2,547,599. ADVANCENET PLUS. INT. CL. 9. REG. 3-12-2002.
- 2,547,601. MAGIC TRAP. INT. CL. 11. REG. 3-12-2002.

- 2,547,602. HEMASURE R AND DESIGN. INT. CL. 10. REG. 3-12-2002.
- 2,547,604. EXPERIENCE YOU!. INT. CL. 41. REG. 3-12-2002.
- 2,547,605. CARDIOQUANT. INT. CL. 5. REG. 3-12-2002.
- 2,547,606. GROOVE NETWORKS. INT. CLS. 9, 38, 39, 41 AND 42. REG. 3-12-2002.
- 2,547,607. TECH SOLUTIONS. INT. CL. 9. REG. 3-12-2002.
- 2,547,609. CHA CHA. INT. CL. 12. REG. 3-12-2002.
- 2,547,611. HOGS HAT. INT. CL. 21. REG. 3-12-2002.
- 2,547,614. FORTREL COLORPLUS. INT. CL. 22. REG. 3-12-2002.
- 2,547,615. TEAR SAVER. INT. CL. 10. REG. 3-12-2002.
- 2,547,617. H & C AND DESIGN. INT. CL. 28. REG. 3-12-2002.
- 2,547,618. PULSE REENGINEERING AND DESIGN. INT. CL. 39. REG. 3-12-2002.
- 2,547,619. STUD & CENTER. INT. CL. 9. REG. 3-12-2002.
- 2,547,624. THERMAL SAFE AND DESIGN. INT. CL. 19. REG. 3-12-2002.
- 2,547,625. SMURFIT-STONE CONTAINER CORPORATION. INT. CL. 17. REG. 3-12-2002.
- 2,547,626. ... IT'S POSSIBLE, IT'S DONE!. INT. CL. 36. REG. 3-12-2002.
- 2,547,627. CLASS OF YOUR OWN. INT. CL. 35. REG. 3-12-2002.
- 2,547,629. SOFTWARE SCIENTIFIC. INT. CL. 9. REG. 3-12-2002.
- 2,547,632. SMARTPAK. INT. CL. 21. REG. 3-12-2002.
- 2,547,633. LL LORD (STYLIZED). INT. CL. 9. REG. 3-12-2002.
- 2,547,635. I'M NOT SORRY AND DESIGN. INT. CL. 16. REG. 3-12-2002.
- 2,547,639. GENERATION. INT. CLS. 25 AND 41. REG. 3-12-2002.
- 2,547,641. SW STATION CALL. INT. CL. 9. REG. 3-12-2002.
- 2,547,643. SEAM-GARD. INT. CL. 9. REG. 3-12-2002.
- 2,547,645. FAST TRACK SOLUTIONS. INT. CLS. 37 AND 42. REG. 3-12-2002.
- 2,547,646. LIMO. INT. CL. 12. REG. 3-12-2002.
- 2,547,648. HYPER DRIVE. INT. CL. 7. REG. 3-12-2002.
- 2,547,650. STIRRUP STEP. INT. CL. 12. REG. 3-12-2002.
- 2,547,652. MR. BILL AND DESIGN. INT. CL. 25. REG. 3-12-2002.
- 2,547,653. BDPROBETEC AND DESIGN. INT. CLS. 1 AND 9. REG. 3-12-2002.
- 2,547,654. MR. BILL AND DESIGN. INT. CL. 9. REG. 3-12-2002.
- 2,547,655. CHATEAU CALIFA (STYLIZED). INT. CL. 33. REG. 3-12-2002.
- 2,547,656. EFFERVESCENT PAK. INT. CL. 1. REG. 3-12-2002.
- 2,547,658. NATURALCARE. INT. CL. 42. REG. 3-12-2002.
- 2,547,660. IQEVENT ENGINE. INT. CL. 9. REG. 3-12-2002.
- 2,547,662. PUNALU'U BAKESHOP AND DESIGN. INT. CL. 30. REG. 3-12-2002.
- 2,547,663. BABY SONOMA. INT. CL. 25. REG. 3-12-2002.
- 2,547,664. TOTALBANK YOUR PERSONAL BANK AND DESIGN. INT. CL. 36. REG. 3-12-2002.
- 2,547,666. JONPRO. INT. CL. 3. REG. 3-12-2002.
- 2,547,667. GRILL AND DESIGN. INT. CL. 42. REG. 3-12-2002.
- 2,547,668. CSE AND DESIGN. INT. CL. 36. REG. 3-12-2002.
- 2,547,669. MORGAN STANLEY DEAN WITTER BASKET LINK. INT. CL. 36. REG. 3-12-2002.
- 2,547,670. MISCELLANEOUS DESIGN. INT. CLS. 9, 16, 25, 41 AND 42. REG. 3-12-2002.
- 2,547,672. DEQOTEC (STYLIZED). INT. CL. 7. REG. 3-12-2002.
- 2,547,673. BALATON. INT. CLS. 3 AND 4. REG. 3-12-2002.
- 2,547,675. FORD CREDIT CERTIFIED AND DESIGN. INT. CL. 36. REG. 3-12-2002.
- 2,547,679. NARDI'S THE BEST EVER CHILI DOGS AND DESIGN. INT. CL. 42. REG. 3-12-2002.
- 2,547,680. E Q U I N O X AND DESIGN. INT. CL. 36. REG. 3-12-2002.
- 2,547,681. MARSHALLS WOMEN IN COMEDY. INT. CL. 41. REG. 3-12-2002.
- 2,547,682. WALDEN (STYLIZED). INT. CL. 36. REG. 3-12-2002.
- 2,547,684. MISCELLANEOUS DESIGN. INT. CL. 36. REG. 3-12-2002.
- 2,547,685. SUTER OF ARGENTINA WHITE TORRONTES AND DESIGN. INT. CL. 33. REG. 3-12-2002.
- 2,547,687. LITE-SPY. INT. CL. 8. REG. 3-12-2002.
- 2,547,689. PAPER GUARDIAN. INT. CL. 3. REG. 3-12-2002.
- 2,547,690. RESULTS ORIENTED SERVICES. INT. CLS. 37, 40 AND 42. REG. 3-12-2002.
- 2,547,692. ULTRASTREAM. INT. CLS. 7 AND 9. REG. 3-12-2002.
- 2,547,694. ONE WASH. INT. CLS. 2 AND 42. REG. 3-12-2002.
- 2,547,695. BLOW-MATIC. INT. CL. 7. REG. 3-12-2002.
- 2,547,698. IMAGENATION ON BOARD. INT. CL. 9. REG. 3-12-2002.
- 2,547,699. ON TAP. INT. CL. 37. REG. 3-12-2002.
- 2,547,700. ROSWELL CONSPIRACIES ALIENS MYTHS & LEGENDS. INT. CL. 41. REG. 3-12-2002.
- 2,547,701. LOOSIE SLOTS. INT. CL. 25. REG. 3-12-2002.
- 2,547,703. TC GIRL. INT. CLS. 16, 18, 24 AND 25. REG. 3-12-2002.
- 2,547,704. TOOLNET6. INT. CL. 9. REG. 3-12-2002.
- 2,547,705. APPLETRAP (STYLIZED). INT. CL. 9. REG. 3-12-2002.
- 2,547,707. SHOPWISE. INT. CL. 16. REG. 3-12-2002.
- 2,547,709. WHERE EXPERIENCE ADDS VALUE. INT. CL. 16. REG. 3-12-2002.
- 2,547,710. PURSUIT PARK BY BRASS EAGLE AND DESIGN. INT. CL. 41. REG. 3-12-2002.
- 2,547,712. CLUB REPUB. INT. CL. 25. REG. 3-12-2002.
- 2,547,713. PERIPHERAL TECHNOLOGY FROM THE HEART. INT. CL. 10. REG. 3-12-2002.
- 2,547,714. E-DENTIFICATION (STYLIZED). INT. CL. 42. REG. 3-12-2002.
- 2,547,716. AZ AZECT (STYLIZED). INT. CL. 12. REG. 3-12-2002.
- 2,547,717. EASY STREET. INT. CL. 28. REG. 3-12-2002.
- 2,547,719. BLUE MARTINI. INT. CL. 9. REG. 3-12-2002.
- 2,547,721. STEADFAST. INT. CL. 11. REG. 3-12-2002.
- 2,547,722. NEXTVISION. INT. CL. 9. REG. 3-12-2002.
- 2,547,723. GE CAPITAL PARTNERS. INT. CL. 36. REG. 3-12-2002.
- 2,547,724. TOUCHWOOD SUPERIOR. INT. CL. 2. REG. 3-12-2002.
- 2,547,725. MARINE POOL SPIRIT OF THE OCEAN AND DESIGN. INT. CL. 9. REG. 3-12-2002.
- 2,547,726. MIKE TRYKE AND DESIGN. INT. CL. 12. REG. 3-12-2002.
- 2,547,727. A-1 COMPONENTS AND DESIGN. INT. CLS. 7, 11 AND 16. REG. 3-12-2002.
- 2,547,728. VISUAL QUICKPRO GUIDE AND DESIGN. INT. CL. 16. REG. 3-12-2002.
- 2,547,729. LA LONGAGRIBUSINESS AND DESIGN. INT. CLS. 6, 7 AND 12. REG. 3-12-2002.
- 2,547,730. ZONDERKIDZ (STYLIZED). INT. CL. 16. REG. 3-12-2002.
- 2,547,738. NO. INT. CL. 35. REG. 3-12-2002.
- 2,547,740. TECHNIQUES FOR A HIGH PERFORMANCE WORKFORCE. INT. CL. 41. REG. 3-12-2002.
- 2,547,742. MISTER LISTER. INT. CL. 35. REG. 3-12-2002.
- 2,547,743. CLASSIC LEGENDS. INT. CL. 18. REG. 3-12-2002.
- 2,547,745. HYDRABLOC. INT. CL. 11. REG. 3-12-2002.
- 2,547,746. DISCOVERY TOOLS. INT. CL. 9. REG. 3-12-2002.
- 2,547,750. SWEET INSPIRATIONS. INT. CL. 28. REG. 3-12-2002.
- 2,547,751. VALUMINDER. INT. CL. 35. REG. 3-12-2002.
- 2,547,752. ATOM. INT. CL. 9. REG. 3-12-2002.
- 2,547,753. ATOM AND DESIGN. INT. CL. 9. REG. 3-12-2002.
- 2,547,757. GIGAPOWER. INT. CLS. 4 AND 11. REG. 3-12-2002.
- 2,547,759. PROFIL. INT. CL. 1. REG. 3-12-2002.
- 2,547,761. KOFRICA RECORDS. INT. CL. 41. REG. 3-12-2002.
- 2,547,763. USA TENNIS 1.2.3 AND DESIGN. INT. CL. 41. REG. 3-12-2002.
- 2,547,765. REVERSE ALERT. INT. CL. 9. REG. 3-12-2002.
- 2,547,767. TAYLOR MADE AND DESIGN. INT. CLS. 18, 24, 25 AND 28. REG. 3-12-2002.
- 2,547,769. ORCHID THRIVE. INT. CL. 1. REG. 3-12-2002.

- 2,547,770. ANGEL OF PEACE. INT. CL. 28. REG. 3-12-2002.
2,547,771. JAKE & EARL'S. INT. CL. 42. REG. 3-12-2002.
2,547,774. MATCHMAKER 2000 AND DESIGN. INT. CL. 9. REG. 3-12-2002.
2,547,776. SAMBUCA JAZZ CAFES AND DESIGN. INT. CL. 39. REG. 3-12-2002.
2,547,777. SAMBUCA JAZZ CAFES. INT. CL. 39. REG. 3-12-2002.
2,547,778. THIS END UP MOTORSPORTS. INT. CL. 41. REG. 3-12-2002.
2,547,781. LUMINEX LIGHTING. INT. CL. 11. REG. 3-12-2002.
2,547,782. MISCELLANEOUS DESIGN. INT. CLS. 36 AND 37. REG. 3-12-2002.
2,547,783. WEB FACTORY. INT. CL. 42. REG. 3-12-2002.
2,547,784. V-GRAM AND DESIGN. INT. CL. 9. REG. 3-12-2002.
2,547,785. PEOPLE WHO THINK. PEOPLE WHO DO. PEOPLE WHO GET IT.. INT. CLS. 37 AND 42. REG. 3-12-2002.
2,547,788. IPVERSE. INT. CLS. 9 AND 38. REG. 3-12-2002.
2,547,791. WNBA ALL-STAR GAME. INT. CL. 28. REG. 3-12-2002.
2,547,792. EXPERTSERVER.NET. INT. CLS. 35, 41 AND 42. REG. 3-12-2002.
2,547,796. MAESTRO CONNECTION. INT. CL. 35. REG. 3-12-2002.
2,547,799. LSA AND DESIGN. INT. CL. 9. REG. 3-12-2002.
2,547,800. TD IMAGES. INT. CL. 35. REG. 3-12-2002.
2,547,802. STRIKELINE ON-LINE. INT. CL. 42. REG. 3-12-2002.
2,547,803. NO NAME. INT. CL. 35. REG. 3-12-2002.
2,547,804. BLU.JIO. INT. CL. 9. REG. 3-12-2002.
2,547,806. CHRISTIANITY IS MY CROWN A TRIBUTE TO A GLORIOUS FAITH AND DESIGN. INT. CL. 16. REG. 3-12-2002.
2,547,807. J.B. FABRICS. INT. CL. 35. REG. 3-12-2002.
2,547,809. BLUEJ. INT. CL. 9. REG. 3-12-2002.
2,547,810. LIBERATE. INT. CL. 41. REG. 3-12-2002.
2,547,811. FORTRESS. INT. CL. 17. REG. 3-12-2002.
2,547,812. THE NATURAL EDITION. INT. CL. 35. REG. 3-12-2002.
2,547,813. MYHEALTH. INT. CLS. 9 AND 16. REG. 3-12-2002.
2,547,818. GARDEN LIFE. INT. CL. 20. REG. 3-12-2002.
2,547,819. UNIKING. INT. CL. 6. REG. 3-12-2002.
2,547,824. SHAGADELIC. INT. CL. 16. REG. 3-12-2002.
2,547,825. QUICKPCI. INT. CL. 9. REG. 3-12-2002.
2,547,826. INTERNET GYM. INT. CLS. 25 AND 35. REG. 3-12-2002.
2,547,827. WB STAGE 16 RESTAURANT AND DESIGN. INT. CL. 42. REG. 3-12-2002.
2,547,830. AERO COMPOSITES INC. AND DESIGN. INT. CL. 12. REG. 3-12-2002.
2,547,831. C-SPHERE. INT. CL. 14. REG. 3-12-2002.
2,547,832. OFFICE RIZ AND DESIGN. INT. CL. 20. REG. 3-12-2002.
2,547,834. VERSABLANKET. INT. CL. 24. REG. 3-12-2002.
2,547,837. PRIMUS CERTIFIED. INT. CL. 36. REG. 3-12-2002.
2,547,838. EMERALD BAY FIERY PAPAYA SPREAD. INT. CL. 3. REG. 3-12-2002.
2,547,839. RAIDSHUTTLE. INT. CL. 9. REG. 3-12-2002.
2,547,840. TRIALTECH TIMS. INT. CLS. 9 AND 16. REG. 3-12-2002.
2,547,843. ROCK STAND BY WARWICK (STYLIZED). INT. CLS. 9 AND 15. REG. 3-12-2002.
2,547,844. E! THE MAGAZINE. INT. CL. 16. REG. 3-12-2002.
2,547,846. ITEMX. INT. CL. 35. REG. 3-12-2002.
2,547,848. SURFCREDITS. INT. CL. 35. REG. 3-12-2002.
2,547,849. HARTLAND EXPRESS AND DESIGN. INT. CL. 35. REG. 3-12-2002.
2,547,850. LADONZA. INT. CLS. 9 AND 16. REG. 3-12-2002.
2,547,852. ALTARATIONS. INT. CL. 20. REG. 3-12-2002.
2,547,854. ADMARK. INT. CL. 42. REG. 3-12-2002.
2,547,860. THE 1909 LINEN CO.. INT. CL. 24. REG. 3-12-2002.
2,547,861. SPACELABS BURDICK. INT. CL. 9. REG. 3-12-2002.
2,547,863. UBQB. INT. CL. 32. REG. 3-12-2002.
2,547,864. MKIRISK. INT. CLS. 9, 35, 36, 38, 41 AND 42. REG. 3-12-2002.
2,547,865. ENGINE. INT. CL. 18. REG. 3-12-2002.
2,547,866. PURE COUNTRY. INT. CL. 29. REG. 3-12-2002.
2,547,869. *ICRO-FAZE AND DESIGN. INT. CL. 4. REG. 3-12-2002.
2,547,870. AUSA FINANCIAL FREEDOM BUILDER. INT. CL. 36. REG. 3-12-2002.
2,547,871. PUTTIN' ON THE DOG. INT. CL. 3. REG. 3-12-2002.
2,547,876. N-TEK. INT. CL. 28. REG. 3-12-2002.
2,547,877. MISCELLANEOUS DESIGN. INT. CLS. 37, 39, 40, 41 AND 42. REG. 3-12-2002.
2,547,878. PARKING PAD. INT. CL. 27. REG. 3-12-2002.
2,547,879. 1D FIRST DATA OUR CLIENTS. OUR RESPONSIBILITY. AND DESIGN. INT. CL. 35. REG. 3-12-2002.
2,547,883. XTREME TRUCKS. INT. CL. 28. REG. 3-12-2002.
2,547,884. BEHIND THE MUSIC. INT. CL. 16. REG. 3-12-2002.
2,547,885. MEDTAC. INT. CL. 41. REG. 3-12-2002.
2,547,888. IBB TECHNOLOGY. INT. CLS. 9 AND 42. REG. 3-12-2002.
2,547,889. SCRATCHEES. INT. CL. 28. REG. 3-12-2002.
2,547,892. KWIK-CLIK PANIC MASTER. INT. CL. 28. REG. 3-12-2002.
2,547,893. SORGENTE MEZZATORRE AND DESIGN. INT. CL. 3. REG. 3-12-2002.
2,547,894. EMBARK. INT. CLS. 36, 41 AND 42. REG. 3-12-2002.
2,547,895. MISCELLANEOUS DESIGN. INT. CL. 9. REG. 3-12-2002.
2,547,898. THE INTELLIGENT SPRING SYSTEM. INT. CL. 20. REG. 3-12-2002.
2,547,899. INTELICENT INC.. INT. CL. 42. REG. 3-12-2002.
2,547,900. EOSHEALTH, INC.. INT. CL. 42. REG. 3-12-2002.
2,547,901. ENDURANCE. INT. CL. 11. REG. 3-12-2002.
2,547,902. MILLENNIA MADNESS. INT. CL. 26. REG. 3-12-2002.
2,547,905. THE SCOTTS ADVANTAGE. INT. CL. 1. REG. 3-12-2002.
2,547,906. GDP (STYLIZED). INT. CL. 38. REG. 3-12-2002.
2,547,909. SHAPE UP AND DROP TEN. INT. CL. 42. REG. 3-12-2002.
2,547,910. MANNANLIFE AND DESIGN. INT. CL. 30. REG. 3-12-2002.
2,547,913. BEAVERGEAR. INT. CL. 25. REG. 3-12-2002.
2,547,915. AUTOMOTIVE AND DESIGN. INT. CLS. 37, 40 AND 42. REG. 3-12-2002.
2,547,916. ETEACHER. INT. CL. 41. REG. 3-12-2002.
2,547,917. NICKEL PAINTING AND DESIGN. INT. CL. 37. REG. 3-12-2002.
2,547,918. VERNA'S HOME CARE PRODUCTS. INT. CL. 21. REG. 3-12-2002.
2,547,920. AK AOKANG AND DESIGN. INT. CL. 25. REG. 3-12-2002.
2,547,921. E*TRADE BOND CENTER. INT. CL. 36. REG. 3-12-2002.
2,547,923. LINCOLN. AMERICAN LUXURY.. INT. CL. 35. REG. 3-12-2002.
2,547,924. BLUESKY WESTERN AND DESIGN. INT. CL. 24. REG. 3-12-2002.
2,547,926. CASUAL FRIDAY AND DESIGN. INT. CL. 3. REG. 3-12-2002.
2,547,928. OSHIMA GUN. INT. CL. 25. REG. 3-12-2002.
2,547,929. PVS. INT. CL. 10. REG. 3-12-2002.
2,547,930. TUFF MATE. INT. CL. 20. REG. 3-12-2002.
2,547,931. SUPER FISH SCALER AND DESIGN. INT. CL. 7. REG. 3-12-2002.
2,547,933. SUREHEAT. INT. CL. 11. REG. 3-12-2002.
2,547,940. WHO WOULD YOU LIKE TO CALL. INT. CL. 9. REG. 3-12-2002.
2,547,941. PRODUCER TEMPLATE BUILDER. INT. CL. 9. REG. 3-12-2002.
2,547,942. ALASKA AIDS VACCINE RIDE. INT. CL. 25. REG. 3-12-2002.

- 2,547,943. EVERYDAY HEROES. INT. CL. 16. REG. 3-12-2002.
- 2,547,944. DOLLARNOW.COM. INT. CL. 35. REG. 3-12-2002.
- 2,547,945. PHALANX. INT. CL. 7. REG. 3-12-2002.
- 2,547,946. POWERCOLOR (STYLIZED). INT. CL. 9. REG. 3-12-2002.
- 2,547,949. PINFEEL. INT. CL. 9. REG. 3-12-2002.
- 2,547,951. SISSY AND SMOOCH. INT. CL. 28. REG. 3-12-2002.
- 2,547,952. TOUR SOLE. INT. CL. 28. REG. 3-12-2002.
- 2,547,953. SANDY' S CLOSET. INT. CL. 20. REG. 3-12-2002.
- 2,547,954. SHISEIDO STUDIO. INT. CLS. 41 AND 42. REG. 3-12-2002.
- 2,547,955. SUPACHILL. INT. CL. 42. REG. 3-12-2002.
- 2,547,956. INTELLIMATCH (STYLIZED). INT. CL. 35. REG. 3-12-2002.
- 2,547,959. MAGIC MEGAN. INT. CL. 28. REG. 3-12-2002.
- 2,547,961. ASPEN WEBMODELS. INT. CL. 42. REG. 3-12-2002.
- 2,547,964. AIRCOBRA. INT. CL. 11. REG. 3-12-2002.
- 2,547,967. "WHO WOULD YOU LIKE TO CALL?" SAM-SUNG VOICE DIALING AND DESIGN. INT. CL. 9. REG. 3-12-2002.
- 2,547,969. BINGO VAULT. INT. CL. 28. REG. 3-12-2002.
- 2,547,970. FUNTRONICS. INT. CL. 28. REG. 3-12-2002.
- 2,547,972. ONE CLICK, ONE CALL, ONE CUSTOMER. INT. CL. 9. REG. 3-12-2002.
- 2,547,974. THE EDWARD LOWE REPORT. INT. CL. 16. REG. 3-12-2002.
- 2,547,975. PFWSPORTS.COM. INT. CL. 41. REG. 3-12-2002.
- 2,547,976. AMELIARIZER. INT. CL. 9. REG. 3-12-2002.
- 2,547,980. CARE CHAIR CLASSIC. INT. CL. 12. REG. 3-12-2002.
- 2,547,981. INTELICENT WHERE BUSINESS MEETS TECHNOLOGY. AND DESIGN. INT. CL. 42. REG. 3-12-2002.
- 2,547,982. GALAXY UNLIMITED. INT. CL. 35. REG. 3-12-2002.
- 2,547,983. PANACYA. INT. CL. 9. REG. 3-12-2002.
- 2,547,985. THE CUTTING EDGE AND DESIGN. INT. CL. 42. REG. 3-12-2002.
- 2,547,988. ON THE COUNTRYSIDE OF ORLANDO. INT. CL. 35. REG. 3-12-2002.
- 2,547,989. N AND DESIGN. INT. CL. 42. REG. 3-12-2002.
- 2,547,991. DECKSTER. INT. CL. 35. REG. 3-12-2002.
- 2,547,993. MYEXPORTS.COM. INT. CL. 16. REG. 3-12-2002.
- 2,547,994. GCS PREMIER. INT. CL. 9. REG. 3-12-2002.
- 2,547,995. HOUSE OF TREASURE ACTION PLANNING GOALS TREASURE TRUTH AND DESIGN. INT. CL. 41. REG. 3-12-2002.
- 2,547,996. SAFED CANDLES. INT. CL. 4. REG. 3-12-2002.
- 2,547,997. NER ZION. INT. CL. 4. REG. 3-12-2002.
- 2,547,999. SOFTWARE IS THE SOUL OF E-BUSINESS. INT. CL. 16. REG. 3-12-2002.
- 2,548,001. CODE. INT. CL. 36. REG. 3-12-2002.
- 2,548,002. STEAM FAST AND DESIGN. INT. CL. 9. REG. 3-12-2002.
- 2,548,003. GRAINGER CONNECT. INT. CL. 42. REG. 3-12-2002.
- 2,548,004. EASIER MORNINGS POPPIN' RIGHT UP. INT. CL. 30. REG. 3-12-2002.
- 2,548,009. SUPERVISING PEOPLE, NOT CASES. INT. CL. 42. REG. 3-12-2002.
- 2,548,011. CYBRANT. INT. CL. 9. REG. 3-12-2002.
- 2,548,012. ONE STEP. INT. CL. 7. REG. 3-12-2002.
- 2,548,013. MEDPOOL (STYLIZED). INT. CL. 35. REG. 3-12-2002.
- 2,548,014. PURCHASEPOINT (STYLIZED). INT. CL. 9. REG. 3-12-2002.
- 2,548,018. ULTRAPIECE. INT. CL. 10. REG. 3-12-2002.
- 2,548,019. ROCK SLIDE. INT. CL. 15. REG. 3-12-2002.
- 2,548,023. SOUNDPETS. INT. CL. 9. REG. 3-12-2002.
- 2,548,024. OMNI WAVE COOKING SYSTEM. INT. CL. 11. REG. 3-12-2002.
- 2,548,027. FRESH-FLO. INT. CL. 20. REG. 3-12-2002.
- 2,548,028. DIMAHO. INT. CL. 9. REG. 3-12-2002.
- 2,548,030. ICARUMBA. INT. CLS. 35, 37 AND 42. REG. 3-12-2002.
- 2,548,033. YOUR HAIR DESERVES PHYTO. INT. CL. 3. REG. 3-12-2002.
- 2,548,037. CMI WHERE INNOVATION TAKES SHAPE AND DESIGN. INT. CL. 27. REG. 3-12-2002.
- 2,548,038. SARNAFIL ECO BOND ROOF. INT. CL. 19. REG. 3-12-2002.
- 2,548,039. CUACCOUNTING E AND DESIGN. INT. CL. 9. REG. 3-12-2002.
- 2,548,040. HUNGRY MINDS. INT. CLS. 16 AND 41. REG. 3-12-2002.
- 2,548,042. LOST TERRAIN. INT. CL. 25. REG. 3-12-2002.
- 2,548,043. INTEGREGYTED CONSULTANTS. INT. CL. 42. REG. 3-12-2002.
- 2,548,045. UNIQUE MINDS PROGRAM E (STYLIZED). INT. CLS. 9 AND 16. REG. 3-12-2002.
- 2,548,046. RINGLING SKYPIGS AND DESIGN. INT. CL. 25. REG. 3-12-2002.
- 2,548,047. FORMOSA AND DESIGN. INT. CL. 19. REG. 3-12-2002.
- 2,548,049. HEAVY DUTY POWERLINKS. INT. CL. 27. REG. 3-12-2002.
- 2,548,050. M3. INT. CL. 9. REG. 3-12-2002.
- 2,548,053. CIMC AND DESIGN. INT. CL. 6. REG. 3-12-2002.
- 2,548,059. PERMACASE. INT. CL. 9. REG. 3-12-2002.
- 2,548,060. COUNTRYWIDE EASY RATE REDUCTION PLAN. INT. CL. 36. REG. 3-12-2002.
- 2,548,064. ICENTER (STYLIZED). INT. CL. 9. REG. 3-12-2002.
- 2,548,066. FOR THE FEEL OF FIT. INT. CL. 28. REG. 3-12-2002.
- 2,548,071. WORLDNAMES.NET. INT. CLS. 35 AND 42. REG. 3-12-2002.
- 2,548,074. CULTURAL QUOTIENT (CQ). INT. CL. 35. REG. 3-12-2002.
- 2,548,078. SOLESOURCE. INT. CLS. 9 AND 35. REG. 3-12-2002.
- 2,548,080. FULL IS FRESH VEND EXPRESS LANCE FRESHNESS AND DESIGN. INT. CL. 35. REG. 3-12-2002.
- 2,548,081. TRIUMPH. INT. CL. 20. REG. 3-12-2002.
- 2,548,082. THE ARMCHAIR SCIENTIST. INT. CL. 42. REG. 3-12-2002.
- 2,548,084. CHOOSE TO QRUZE. INT. CL. 28. REG. 3-12-2002.
- 2,548,085. THE WEALTH ENJOYMENT SYSTEM. INT. CL. 36. REG. 3-12-2002.
- 2,548,089. MISCELLANEOUS DESIGN. INT. CL. 42. REG. 3-12-2002.
- 2,548,091. CLIMA-STAR. INT. CL. 19. REG. 3-12-2002.
- 2,548,093. FACT LINE. INT. CLS. 35 AND 38. REG. 3-12-2002.
- 2,548,094. PERSONAL VALET AND DESIGN. INT. CLS. 9, 20 AND 21. REG. 3-12-2002.
- 2,548,096. PREPARE. INT. CL. 9. REG. 3-12-2002.
- 2,548,099. FACING RETIREMENT. INT. CL. 16. REG. 3-12-2002.
- 2,548,101. LOGON FOR LIFE. INT. CL. 42. REG. 3-12-2002.
- 2,548,103. CANDLENET. INT. CLS. 9, 35, 38 AND 42. REG. 3-12-2002.
- 2,548,105. FLEXEPHANT. INT. CL. 21. REG. 3-12-2002.
- 2,548,106. SHURE (STYLIZED). INT. CL. 9. REG. 3-12-2002.
- 2,548,111. ESYLVAN. INT. CL. 41. REG. 3-12-2002.
- 2,548,113. POWER ELITE. INT. CL. 7. REG. 3-12-2002.
- 2,548,114. RIG RAGS. INT. CL. 25. REG. 3-12-2002.
- 2,548,115. VIVIDENCE AND DESIGN. INT. CL. 35. REG. 3-12-2002.
- 2,548,117. "RELATIONSHIP" CALL CENTER. INT. CL. 35. REG. 3-12-2002.
- 2,548,120. GENE-LINK. INT. CL. 1. REG. 3-12-2002.
- 2,548,121. MICROB-LINK. INT. CL. 1. REG. 3-12-2002.
- 2,548,122. NEEDAPRODUCT. INT. CL. 35. REG. 3-12-2002.
- 2,548,123. ABAMAX. INT. CL. 35. REG. 3-12-2002.
- 2,548,124. VERSATRAC 27. INT. CL. 6. REG. 3-12-2002.
- 2,548,125. DIPUC. INT. CLS. 9, 16, 25, 28 AND 41. REG. 3-12-2002.
- 2,548,126. MAXIMUM SPEED. INT. CL. 28. REG. 3-12-2002.
- 2,548,127. MAPSTATION. INT. CL. 9. REG. 3-12-2002.
- 2,548,129. MISCELLANEOUS DESIGN. INT. CL. 25. REG. 3-12-2002.
- 2,548,130. WORLD KID. INT. CL. 16. REG. 3-12-2002.

- 2,548,131. LIFECARE CONVERSATIONS. INT. CLS. 41 AND 42. REG. 3-12-2002.
- 2,548,133. WINNING THE TALENT WARS. INT. CLS. 16 AND 41. REG. 3-12-2002.
- 2,548,134. TOFFEE BREAK. INT. CLS. 30 AND 35. REG. 3-12-2002.
- 2,548,135. NORMAN R. WOLFORD SCHOOL OF NURSE ANESTHESIA. INT. CL. 41. REG. 3-12-2002.
- 2,548,136. IFINISH. INT. CL. 9. REG. 3-12-2002.
- 2,548,137. WE'RE ON THAT. INT. CL. 38. REG. 3-12-2002.
- 2,548,140. LAY EASY DUDE. INT. CL. 22. REG. 3-12-2002.
- 2,548,142. GRINGOTTS. INT. CL. 16. REG. 3-12-2002.
- 2,548,143. MAGAZINE CONNECTION. INT. CL. 35. REG. 3-12-2002.
- 2,548,144. VOCAB LAB. INT. CL. 41. REG. 3-12-2002.
- 2,548,146. SIDESHO (STYLIZED). INT. CL. 7. REG. 3-12-2002.
- 2,548,148. IMPLI. INT. CLS. 35, 41 AND 42. REG. 3-12-2002.
- 2,548,150. REAL ROBOTICS. INT. CL. 9. REG. 3-12-2002.
- 2,548,153. AIFY (STYLIZED). INT. CL. 9. REG. 3-12-2002.
- 2,548,154. THRILL RIDE. INT. CL. 9. REG. 3-12-2002.
- 2,548,155. COMBISMART. INT. CL. 9. REG. 3-12-2002.
- 2,548,157. HEADMINDER. INT. CLS. 9 AND 42. REG. 3-12-2002.
- 2,548,159. TUMBLE BEARS. INT. CL. 28. REG. 3-12-2002.
- 2,548,160. GAME FACE. INT. CL. 9. REG. 3-12-2002.
- 2,548,161. RADIAL GRIP. INT. CL. 9. REG. 3-12-2002.
- 2,548,162. IMIX (STYLIZED). INT. CL. 3. REG. 3-12-2002.
- 2,548,170. SCREEN WIZARD. INT. CLS. 6 AND 19. REG. 3-12-2002.
- 2,548,171. JAGUAR RACING. INT. CL. 28. REG. 3-12-2002.
- 2,548,173. MATRIX. INT. CL. 16. REG. 3-12-2002.
- 2,548,174. ARTHROMAX. INT. CL. 5. REG. 3-12-2002.
- 2,548,177. PSYCHOPTIONS. INT. CL. 42. REG. 3-12-2002.
- 2,548,179. EMOTIONAL POWER. INT. CL. 9. REG. 3-12-2002.
- 2,548,180. SENIORPLANET. INT. CLS. 35, 41 AND 42. REG. 3-12-2002.
- 2,548,183. PREMIUM SERVICES AND DESIGN. INT. CL. 35. REG. 3-12-2002.
- 2,548,186. OAKLAND. INT. CL. 21. REG. 3-12-2002.
- 2,548,187. QUIK STIK. INT. CL. 9. REG. 3-12-2002.
- 2,548,188. DENTEMP'S. INT. CL. 5. REG. 3-12-2002.
- 2,548,190. MASTER AND DESIGN. INT. CL. 19. REG. 3-12-2002.
- 2,548,192. TBWE3. INT. CL. 19. REG. 3-12-2002.
- 2,548,194. 2MINUS1.COM. INT. CLS. 9 AND 36. REG. 3-12-2002.
- 2,548,195. EDWARDS WHERE DESSERT COMES FIRST! AND DESIGN. INT. CL. 30. REG. 3-12-2002.
- 2,548,197. GUTTERHOE. INT. CL. 8. REG. 3-12-2002.
- 2,548,198. FAMOUSMARKETS.COM. INT. CL. 35. REG. 3-12-2002.
- 2,548,199. HOTCHO NACHO. INT. CL. 29. REG. 3-12-2002.
- 2,548,201. GREAT EXPERIENCES PROGRAM. INT. CLS. 16 AND 35. REG. 3-12-2002.
- 2,548,202. TGS TOPGUN SUSPENSION AND DESIGN. INT. CL. 12. REG. 3-12-2002.
- 2,548,203. Z AND DESIGN. INT. CL. 5. REG. 3-12-2002.
- 2,548,204. CIRCUIT. INT. CL. 9. REG. 3-12-2002.
- 2,548,207. PRECIOUS MOUSE. INT. CL. 9. REG. 3-12-2002.
- 2,548,208. RESHAPING VISION CORRECTION. INT. CL. 42. REG. 3-12-2002.
- 2,548,211. SHOPFINGER. INT. CL. 35. REG. 3-12-2002.
- 2,548,215. SACAGAWEA. INT. CL. 14. REG. 3-12-2002.
- 2,548,216. ARIBA. INT. CL. 10. REG. 3-12-2002.
- 2,548,218. NAKED TAN. INT. CLS. 3 AND 25. REG. 3-12-2002.
- 2,548,219. ¡ AND DESIGN. INT. CL. 16. REG. 3-12-2002.
- 2,548,220. SNOWQUEST. INT. CL. 42. REG. 3-12-2002.
- 2,548,221. MORE SCIENCE. LESS PAPER. IT'S ABOUT TIME.. INT. CL. 9. REG. 3-12-2002.
- 2,548,222. GRAB A MILLER LITE. IT'S MILLER TIME. INT. CL. 32. REG. 3-12-2002.
- 2,548,223. IMPROVENET AND DESIGN. INT. CL. 37. REG. 3-12-2002.
- 2,548,224. AMERICART. INT. CL. 12. REG. 3-12-2002.
- 2,548,226. PROLURE. INT. CL. 9. REG. 3-12-2002.
- 2,548,227. ISLAND STYLE BOOK. INT. CL. 39. REG. 3-12-2002.
- 2,548,230. LAURI SIMONE AND DESIGN. INT. CL. 24. REG. 3-12-2002.
- 2,548,231. AGRI-TREAT. INT. CL. 7. REG. 3-12-2002.
- 2,548,234. FRESH CHECK AND DESIGN. INT. CL. 9. REG. 3-12-2002.
- 2,548,237. HERITAGE FARM. INT. CL. 30. REG. 3-12-2002.
- 2,548,239. SCRUNCHY AND DESIGN. INT. CLS. 28, 30 AND 32. REG. 3-12-2002.
- 2,548,240. STEREOJET. INT. CLS. 9, 16, 17 AND 42. REG. 3-12-2002.
- 2,548,242. HEARTH-SIDE EXPRESSIONS. INT. CLS. 4 AND 14. REG. 3-12-2002.
- 2,548,244. CXS21. INT. CL. 25. REG. 3-12-2002.
- 2,548,251. ACCU-REFLEX. INT. CL. 16. REG. 3-12-2002.
- 2,548,253. URBAN DEFENSE. INT. CL. 3. REG. 3-12-2002.
- 2,548,259. POLYCAP. INT. CL. 6. REG. 3-12-2002.
- 2,548,262. PRO ANABOLIC. INT. CL. 5. REG. 3-12-2002.
- 2,548,265. UNIVERSAL COIL MFG AND DESIGN. INT. CL. 40. REG. 3-12-2002.
- 2,548,267. TRANS TECH. INT. CL. 16. REG. 3-12-2002.
- 2,548,268. SOCIOWARE. INT. CL. 42. REG. 3-12-2002.
- 2,548,269. MEDAPPRISE. INT. CL. 35. REG. 3-12-2002.
- 2,548,270. COMPASSION CREDIT CARD. INT. CL. 35. REG. 3-12-2002.
- 2,548,271. E-VOLVING @ THE SPEED OF IDEAS. INT. CL. 35. REG. 3-12-2002.
- 2,548,272. G BULLET. INT. CL. 13. REG. 3-12-2002.
- 2,548,276. TECHKNOWLAW. INT. CL. 35. REG. 3-12-2002.
- 2,548,277. AT&T ALL IN ONE AND DESIGN. INT. CL. 38. REG. 3-12-2002.
- 2,548,278. AT&T ALL IN ONE AND DESIGN AND DESIGN. INT. CL. 38. REG. 3-12-2002.
- 2,548,279. FASTDRAW. INT. CL. 10. REG. 3-12-2002.
- 2,548,285. YOGA CLASSICS AND DESIGN. INT. CL. 28. REG. 3-12-2002.
- 2,548,286. CENTER FOR TECHNOLOGY FREEDOM. INT. CL. 16. REG. 3-12-2002.
- 2,548,289. CN AND DESIGN. INT. CL. 41. REG. 3-12-2002.
- 2,548,290. ASTAFACOR. INT. CL. 5. REG. 3-12-2002.
- 2,548,291. THE JAPANESE GARDENS S.F.L.V.. INT. CL. 35. REG. 3-12-2002.
- 2,548,292. GRAB-IT WAX. INT. CL. 3. REG. 3-12-2002.
- 2,548,293. EASY DETAIL. INT. CL. 3. REG. 3-12-2002.
- 2,548,294. T-SPORT. INT. CL. 12. REG. 3-12-2002.
- 2,548,295. GENERALCOLOGNE RE. INT. CLS. 36 AND 42. REG. 3-12-2002.
- 2,548,296. FIRSTXPRESS.COM. INT. CL. 36. REG. 3-12-2002.
- 2,548,299. DESIGNING BUTTER. INT. CL. 3. REG. 3-12-2002.
- 2,548,300. IT'S A SURPRISE!. INT. CL. 41. REG. 3-12-2002.
- 2,548,301. AIRSHOWM@IL. INT. CL. 38. REG. 3-12-2002.
- 2,548,302. MENO-POSSIBILITIES. INT. CL. 16. REG. 3-12-2002.
- 2,548,306. YESTERDAYS' CHILD. INT. CL. 20. REG. 3-12-2002.
- 2,548,307. VISION. INT. CL. 36. REG. 3-12-2002.
- 2,548,310. SHAKLEE DR (STYLIZED). INT. CL. 5. REG. 3-12-2002.
- 2,548,311. ERGOPERSPECTIVE. INT. CL. 42. REG. 3-12-2002.
- 2,548,314. QUIK TECH. INT. CL. 35. REG. 3-12-2002.
- 2,548,315. GIT LIT. INT. CL. 12. REG. 3-12-2002.
- 2,548,316. PARENTS (STYLIZED). INT. CL. 28. REG. 3-12-2002.
- 2,548,317. ECONOPAN. INT. CL. 8. REG. 3-12-2002.
- 2,548,321. PLAYBACK MEDIA. INT. CL. 41. REG. 3-12-2002.
- 2,548,322. PLAY BACK AND DESIGN. INT. CL. 41. REG. 3-12-2002.
- 2,548,323. E-CUTLETS.YUM. INT. CL. 29. REG. 3-12-2002.
- 2,548,324. COVERT OPS ESSENTIALS. INT. CL. 9. REG. 3-12-2002.
- 2,548,325. LIFETIME ADVANTAGE. INT. CL. 20. REG. 3-12-2002.
- 2,548,326. TRUFLEX. INT. CL. 9. REG. 3-12-2002.
- 2,548,327. DOORKEEPER. INT. CL. 27. REG. 3-12-2002.
- 2,548,328. CUT YOUR HANDICAP (STYLIZED). INT. CL. 41. REG. 3-12-2002.

- 2,548,329. WIZ WHEEL. INT. CL. 28. REG. 3-12-2002.
- 2,548,330. SQUARE AND DRAW. INT. CL. 41. REG. 3-12-2002.
- 2,548,331. SQUARE AND CUT. INT. CL. 41. REG. 3-12-2002.
- 2,548,332. CONSERVATOR. INT. CL. 9. REG. 3-12-2002.
- 2,548,333. MEADWARE. INT. CL. 16. REG. 3-12-2002.
- 2,548,334. ARCWHITE. INT. CL. 11. REG. 3-12-2002.
- 2,548,336. NOTWIRED. INT. CLS. 9 AND 42. REG. 3-12-2002.
- 2,548,340. AFX. INT. CL. 10. REG. 3-12-2002.
- 2,548,343. TECHSTAR MOLDING (STYLIZED). INT. CL. 40. REG. 3-12-2002.
- 2,548,344. VESTIGO. INT. CLS. 16 AND 36. REG. 3-12-2002.
- 2,548,346. MISCELLANEOUS DESIGN. INT. CLS. 9 AND 42. REG. 3-12-2002.
- 2,548,347. EQUIPCOAT. INT. CL. 2. REG. 3-12-2002.
- 2,548,348. TELEVPN. INT. CL. 9. REG. 3-12-2002.
- 2,548,350. ALL SOURCE. INT. CL. 38. REG. 3-12-2002.
- 2,548,351. ACTIVATOR. INT. CL. 3. REG. 3-12-2002.
- 2,548,352. ARE YOU GETTING ENOUGH?. INT. CL. 41. REG. 3-12-2002.
- 2,548,353. SMARTSORB. INT. CL. 28. REG. 3-12-2002.
- 2,548,357. JO SCRUB. INT. CL. 25. REG. 3-12-2002.
- 2,548,358. TOPPS FUSION. INT. CL. 16. REG. 3-12-2002.
- 2,548,359. BRUSH-PRO. INT. CL. 9. REG. 3-12-2002.
- 2,548,360. THE MATTRESS WITH THE JUST-RIGHT-FEELING. INT. CL. 20. REG. 3-12-2002.
- 2,548,363. NINPRO. INT. CL. 16. REG. 3-12-2002.
- 2,548,365. INTAGLIO. INT. CLS. 3 AND 4. REG. 3-12-2002.
- 2,548,370. SCARLETT FEVER. INT. CL. 35. REG. 3-12-2002.
- 2,548,372. MISCELLANEOUS DESIGN. INT. CL. 20. REG. 3-12-2002.
- 2,548,374. SEESCAN AND DESIGN. INT. CL. 9. REG. 3-12-2002.
- 2,548,375. CLASSIC. INT. CL. 15. REG. 3-12-2002.
- 2,548,378. PURE TOUCH. INT. CL. 28. REG. 3-12-2002.
- 2,548,379. XTERMINATOR. INT. CL. 28. REG. 3-12-2002.
- 2,548,382. ONE-UP. INT. CL. 28. REG. 3-12-2002.
- 2,548,385. GLOBAL CUSTOMER SOLUTIONS. INT. CL. 35. REG. 3-12-2002.
- 2,548,386. HYPERPATCH. INT. CL. 19. REG. 3-12-2002.
- 2,548,387. SPIRITPOINT. INT. CL. 41. REG. 3-12-2002.
- 2,548,388. CHA CHA. INT. CL. 20. REG. 3-12-2002.
- 2,548,391. FLASHLINK. INT. CL. 9. REG. 3-12-2002.
- 2,548,392. CHILDHOOD REMEMBERED (STYLIZED). INT. CL. 16. REG. 3-12-2002.
- 2,548,393. ILLUMINATING MEMORIES. INT. CL. 16. REG. 3-12-2002.
- 2,548,394. TAXICABS USA AND DESIGN. INT. CL. 39. REG. 3-12-2002.
- 2,548,396. NECK TOP COMPUTING. INT. CL. 35. REG. 3-12-2002.
- 2,548,398. ARE YOU CRAZY ENOUGH TO TRY IT?. INT. CL. 32. REG. 3-12-2002.
- 2,548,399. FUCHSIA. INT. CL. 3. REG. 3-12-2002.
- 2,548,401. KRINGLE'S VILLAGE. INT. CL. 20. REG. 3-12-2002.
- 2,548,402. ACTI-GAUZ. INT. CL. 5. REG. 3-12-2002.
- 2,548,406. HOME AMONG FAMILY AND FRIENDS. INT. CL. 27. REG. 3-12-2002.
- 2,548,407. SUPER SLABBER. INT. CL. 8. REG. 3-12-2002.
- 2,548,410. ONE ADVANTAGE LINE OF CREDIT. INT. CL. 36. REG. 3-12-2002.
- 2,548,411. U CONNECT CONFERENCE WHERE SOLUTIONS MEET THE SUPPLY CHAIN AND DESIGN. INT. CL. 41. REG. 3-12-2002.
- 2,548,412. OVERCOME OBJECTIONS. INT. CL. 28. REG. 3-12-2002.
- 2,548,413. OMNITRAK. INT. CL. 9. REG. 3-12-2002.
- 2,548,414. JUST IN CASE. INT. CL. 9. REG. 3-12-2002.
- 2,548,415. TURNTABLE. INT. CL. 42. REG. 3-12-2002.
- 2,548,416. IDEAS ARE VALUABLE... INT. CL. 42. REG. 3-12-2002.
- 2,548,418. THE GROOMER. INT. CL. 3. REG. 3-12-2002.
- 2,548,419. SEE YOURSELF SUCCEEDING. INT. CL. 36. REG. 3-12-2002.
- 2,548,426. TELEXCHANGE. INT. CL. 39. REG. 3-12-2002.
- 2,548,427. USEFULJOBS.COM AND DESIGN. INT. CL. 35. REG. 3-12-2002.
- 2,548,429. PERIJET. INT. CL. 9. REG. 3-12-2002.
- 2,548,430. RACK PRO. INT. CL. 5. REG. 3-12-2002.
- 2,548,431. DEER CHUM. INT. CL. 5. REG. 3-12-2002.
- 2,548,434. THE ONE CAR. INT. CL. 36. REG. 3-12-2002.
- 2,548,435. TRU-TRAC. INT. CL. 7. REG. 3-12-2002.
- 2,548,436. CHESSCAT. INT. CL. 9. REG. 3-12-2002.
- 2,548,437. DIRECT TO YOU. INT. CL. 16. REG. 3-12-2002.
- 2,548,438. FLEXERS. INT. CL. 36. REG. 3-12-2002.
- 2,548,440. INTENSITY. INT. CL. 11. REG. 3-12-2002.
- 2,548,441. EV CLASSIC SPIN. INT. CL. 28. REG. 3-12-2002.
- 2,548,443. SPECTRAMAZE. INT. CL. 28. REG. 3-12-2002.
- 2,548,445. BOSSA. INT. CL. 42. REG. 3-12-2002.
- 2,548,446. LAN-MINDER. INT. CL. 9. REG. 3-12-2002.
- 2,548,447. HOPSCOTCH LOUNGE. INT. CL. 42. REG. 3-12-2002.
- 2,548,450. RELIASERVER. INT. CL. 9. REG. 3-12-2002.
- 2,548,453. SIMULITE. INT. CL. 9. REG. 3-12-2002.
- 2,548,457. SOCNET. INT. CL. 41. REG. 3-12-2002.
- 2,548,458. WAVESCOPE (STYLIZED). INT. CL. 9. REG. 3-12-2002.
- 2,548,459. MEGAREWARDS. INT. CL. 36. REG. 3-12-2002.
- 2,548,462. A PERFECT LIFE. INT. CL. 41. REG. 3-12-2002.
- 2,548,463. SIMPLY SOFT. INT. CL. 10. REG. 3-12-2002.
- 2,548,467. GENEROSITY. INT. CL. 16. REG. 3-12-2002.
- 2,548,468. NO LEAK IS A GOOD LEAK. INT. CL. 16. REG. 3-12-2002.
- 2,548,470. RALPH. INT. CL. 3. REG. 3-12-2002.
- 2,548,473. LIGO. INT. CL. 42. REG. 3-12-2002.
- 2,548,474. VASELINE INTENSIVE CARE RENEW & PROTECT AND DESIGN. INT. CL. 3. REG. 3-12-2002.
- 2,548,480. LASTING IMPRESSION. INT. CL. 3. REG. 3-12-2002.
- 2,548,481. NATURE'S UPDATE. INT. CL. 27. REG. 3-12-2002.
- 2,548,485. PAGEPOD. INT. CL. 16. REG. 3-12-2002.
- 2,548,486. UNETE AL TRI. INT. CL. 32. REG. 3-12-2002.
- 2,548,487. GET MOVING CARE PACKAGE. INT. CL. 28. REG. 3-12-2002.
- 2,548,490. APPLES TO APPLES. INT. CL. 36. REG. 3-12-2002.
- 2,548,492. MEDIAMARC. INT. CL. 9. REG. 3-12-2002.
- 2,548,496. LOANBUY. INT. CL. 36. REG. 3-12-2002.
- 2,548,497. SNIP SNIP BUZZ. INT. CL. 42. REG. 3-12-2002.
- 2,548,498. TIME VECTORS. INT. CL. 28. REG. 3-12-2002.
- 2,548,499. BAYMOUNT. INT. CL. 36. REG. 3-12-2002.
- 2,548,500. MOONLIGHT GRAHAM PLAYING BALL SINCE 1839 MG 1839 AND DESIGN. INT. CL. 25. REG. 3-12-2002.
- 2,548,503. SMARTART. INT. CL. 41. REG. 3-12-2002.
- 2,548,504. G G - UP AND DESIGN. INT. CL. 32. REG. 3-12-2002.
- 2,548,505. CRITTER MAGNET. INT. CL. 28. REG. 3-12-2002.
- 2,548,506. FREEZER CARRIER. INT. CL. 21. REG. 3-12-2002.
- 2,548,510. ANANDA BALLROOM. INT. CL. 41. REG. 3-12-2002.
- 2,548,520. POWERPROFILER. INT. CL. 9. REG. 3-12-2002.
- 2,548,521. WIN THE HOLE THING. INT. CL. 28. REG. 3-12-2002.
- 2,548,524. SYSMATRIX. INT. CL. 38. REG. 3-12-2002.
- 2,548,525. SMART CAN. INT. CL. 21. REG. 3-12-2002.
- 2,548,527. YOUTHFUL AGING.COM. INT. CL. 42. REG. 3-12-2002.
- 2,548,531. OURPAPER. INT. CL. 16. REG. 3-12-2002.
- 2,548,533. EVEN-WIND. INT. CLS. 20 AND 21. REG. 3-12-2002.
- 2,548,536. FAMILYNET. INT. CL. 38. REG. 3-12-2002.
- 2,548,537. MISCELLANEOUS DESIGN. INT. CL. 3. REG. 3-12-2002.
- 2,548,538. NETPEN. INT. CLS. 9 AND 16. REG. 3-12-2002.
- 2,548,539. GAME INTEGRATED ADVERTISING. INT. CL. 35. REG. 3-12-2002.
- 2,548,540. SPATIAL TECHNOLOGY (STYLIZED). INT. CL. 9. REG. 3-12-2002.
- 2,548,542. GLOSSBELT. INT. CL. 7. REG. 3-12-2002.
- 2,548,547. E-ELDERCARE. INT. CL. 35. REG. 3-12-2002.
- 2,548,548. WORLD-CARRIER. INT. CL. 38. REG. 3-12-2002.
- 2,548,549. ACTION PLAN PROPOSAL REPORT. INT. CL. 36. REG. 3-12-2002.
- 2,548,555. XL IMAGES. INT. CL. 42. REG. 3-12-2002.

- 2,548,557. MUNISTATEMENTS.COM. INT. CL. 36. REG. 3-12-2002.
- 2,548,559. CYBER TRADING. INT. CL. 42. REG. 3-12-2002.
- 2,548,561. E-TEL CORPORATION (STYLIZED). INT. CLS. 9 AND 42. REG. 3-12-2002.
- 2,548,562. ONCE-AT-NIGHT. INT. CL. 5. REG. 3-12-2002.
- 2,548,563. FINANCIALLY ENGINEERED PORTFOLIOS. INT. CL. 36. REG. 3-12-2002.
- 2,548,564. STRAPLESS LOCKING ACTION SHOULDER HOLSTER. INT. CL. 13. REG. 3-12-2002.
- 2,548,565. IT'S THE BEST GAME IN TOWN. INT. CL. 41. REG. 3-12-2002.
- 2,548,566. MIGRATING BUSINESS. INT. CLS. 9 AND 42. REG. 3-12-2002.
- 2,548,568. TV LINK CREATOR. INT. CL. 9. REG. 3-12-2002.
- 2,548,569. U-SAND. INT. CL. 7. REG. 3-12-2002.
- 2,548,570. PHYSICIAN DESKTOP MANAGER. INT. CL. 35. REG. 3-12-2002.
- 2,548,571. GARMENTRACK. INT. CL. 35. REG. 3-12-2002.
- 2,548,573. APRONSTYLE. INT. CL. 35. REG. 3-12-2002.
- 2,548,575. GLOBAL BRAND MANAGER. INT. CLS. 35 AND 39. REG. 3-12-2002.
- 2,548,577. TOTAL MANAGED SECURITY. INT. CL. 9. REG. 3-12-2002.
- 2,548,579. THERMOSCALE. INT. CL. 9. REG. 3-12-2002.
- 2,548,581. MISCELLANEOUS DESIGN. INT. CL. 30. REG. 3-12-2002.
- 2,548,582. STUDIOAUCTIONS.COM. INT. CL. 35. REG. 3-12-2002.
- 2,548,583. INSTITUTE FOR TRAUMA AND ADDICTIVE DISORDERS. INT. CL. 41. REG. 3-12-2002.
- 2,548,584. LUREBOX AND DESIGN. INT. CL. 28. REG. 3-12-2002.
- 2,548,585. DIRECTMAILSOURCE.COM. INT. CL. 35. REG. 3-12-2002.
- 2,548,588. ACCURATE SORTING AND QUALITY INDUSTRIALSERVICES. INT. CLS. 40 AND 42. REG. 3-12-2002.
- 2,548,589. BATIZ.COM. INT. CL. 42. REG. 3-12-2002.
- 2,548,590. CHOICE COVERAGE. INT. CL. 36. REG. 3-12-2002.
- 2,548,595. AMERICAN CAPITAL EXCHANGE. INT. CL. 36. REG. 3-12-2002.
- 2,548,596. BEACH BUGGY. INT. CL. 18. REG. 3-12-2002.
- 2,548,597. RAPID RAKE. INT. CL. 8. REG. 3-12-2002.
- 2,548,598. LONE STAR PIZZA WORKS. INT. CL. 42. REG. 3-12-2002.
- 2,548,601. THE BEST OPTION. INT. CL. 42. REG. 3-12-2002.
- 2,548,604. THE SOUTHERN DESIGNER. INT. CL. 42. REG. 3-12-2002.
- 2,548,607. TEACHERINFO.COM. INT. CL. 41. REG. 3-12-2002.
- 2,548,610. LCDARMS.COM. INT. CL. 9. REG. 3-12-2002.
- 2,548,611. STORYTELLER ONLINE. INT. CL. 41. REG. 3-12-2002.
- 2,548,612. BRASWELL. INT. CLS. 9 AND 41. REG. 3-12-2002.
- 2,548,613. MOBILE BLOCKER. INT. CL. 9. REG. 3-12-2002.
- 2,548,614. GLOBAL HR. INT. CL. 16. REG. 3-12-2002.
- 2,548,616. ELECTRICBINGO. INT. CL. 41. REG. 3-12-2002.
- 2,548,620. OUTPATIENT SURGERY MAGAZINE. INT. CLS. 9 AND 42. REG. 3-12-2002.
- 2,548,621. NYCGIGS.COM AND DESIGN. INT. CL. 35. REG. 3-12-2002.
- 2,548,622. OPTIMAL CONTROL DESIGNER. INT. CL. 9. REG. 3-12-2002.
- 2,548,623. BLACK FOREST FRUITS DINNERWARE. INT. CL. 21. REG. 3-12-2002.
- 2,548,625. NORTHERN CALIFORNIA / SILICON VALLEY MACHINE TOOL SHOW. INT. CL. 35. REG. 3-12-2002.
- 2,548,627. FLAVORKAKES. INT. CL. 30. REG. 3-12-2002.
- 2,548,628. REFRACTIVE SURGERY QUARTERLY. INT. CL. 16. REG. 3-12-2002.
- 2,548,629. INSHORE FISHING. INT. CL. 16. REG. 3-12-2002.
- 2,548,630. KINGFISHING. INT. CL. 16. REG. 3-12-2002.
- 2,548,632. EFM BINGO. INT. CL. 28. REG. 3-12-2002.
- 2,548,635. GIRL TOOLS. INT. CL. 8. REG. 3-12-2002.
- 2,548,637. HIGHLANDEXPLORER.COM. INT. CL. 41. REG. 3-12-2002.
- 2,548,639. MISCELLANEOUS DESIGN. INT. CL. 16. REG. 3-12-2002.
- 2,553,038. BROUGH SUPERIOR. INT. CLS. 12 AND 25. REG. 3-26-2002.
- 2,566,190. GLANCE. INT. CL. 36. REG. 4-30-2002.
- 2,570,877. TANISTRY. INT. CL. 42. REG. 5-21-2002.
- 2,576,906. MAILLE 1747 QUEMAILLE. 1747 QUE MAILLE AND DESIGN. INT. CL. 29 ONLY. REG. 6-11-2002.
- 2,577,805. F FORLADY AND DESIGN. INT. CL. 20. REG. 6-11-2002.
- 2,582,408. PARODONTAX. INT. CL. 21 ONLY. REG. 6-18-2002.
- 2,591,823. PRIMEDIA. INT. CL. 41 ONLY. REG. 7-9-2002.
- 2,595,588. HARVEST SPICE. INT. CL. 4 ONLY. REG. 7-16-2002.
- 2,622,564. FLOWTITE. INT. CL. 11 ONLY. REG. 9-24-2002.
- 2,628,580. WATKINS GLEN NEW YORK'S THUNDER ROAD AND DESIGN. INT. CLS. 16 AND 28 ONLY. REG. 10-1-2002.
- 2,644,946. MANDERLEY. INT. CL. 42 ONLY. REG. 11-5-2002.
- 2,654,121. ON ICE TOUR AND DESIGN. INT. CL. 16 ONLY. REG. 11-26-2002.
- 2,657,519. FEMAIL. INT. CLS. 9 AND 39 ONLY. REG. 12-10-2002.
- 2,659,022. MAX GREY. INT. CL. 21 ONLY. REG. 12-10-2002.
- 2,659,387. JOJO COLLECTION. INT. CLS. 14 AND 21 ONLY. REG. 12-10-2002.
- 2,659,758. CHEF'S MARK PREFERRED QUALITY AND DESIGN. INT. CL. 24 ONLY. REG. 12-10-2002.
- 2,659,870. SWIMSAFE. INT. CLS. 9 AND 37 ONLY. REG. 12-10-2002.
- 2,661,048. MISCELLANEOUS DESIGN. INT. CL. 6 ONLY. REG. 12-17-2002.
- 2,661,439. TW PERRY. INT. CL. 37 ONLY. REG. 12-17-2002.
- 2,661,529. THE WORLD FOR WOMEN. INT. CLS. 9, 16 AND 28 ONLY. REG. 12-17-2002.
- 2,661,691. WELCOME HOUSE. INT. CL. 35 ONLY. REG. 12-17-2002.
- 2,662,988. UNITED STATES RACQUETBALL ASSOCIATION. INT. CL. 41 ONLY. REG. 12-17-2002.
- 2,665,097. ARTANGELS. INT. CL. 36 ONLY. REG. 12-24-2002.
- 2,665,353. VLIP. INT. CLS. 1, 5 AND 9 ONLY. REG. 12-24-2002.
- 2,667,582. GIMMI. INT. CL. 5 ONLY. REG. 12-31-2002.
- 2,667,970. ENSTO. INT. CL. 7 ONLY. REG. 12-31-2002.
- 2,668,046. LOWVISION AND DESIGN. INT. CLS. 16, 35 AND 41 ONLY. REG. 12-31-2002.
- 2,669,995. A LA ZING AND DESIGN. INT. CL. 35 ONLY. REG. 12-31-2002.
- 2,672,456. SUSTAINABLE SEAS EXPEDITIONS. INT. CLS. 9 AND 16 ONLY. REG. 1-7-2003.
- 2,672,518. SUSTAINABLE SEAS EXPEDITIONS AND DESIGN. INT. CLS. 9 AND 16 ONLY. REG. 1-7-2003.
- 2,685,926. AUTO MOTIVE BIBLE. INT. CL. 42 ONLY. REG. 2-11-2003.
- 2,695,831. ANSR. INT. CL. 41 ONLY. REG. 3-11-2003.
- 2,704,736. DIGITAL DAILIES. INT. CL. 35 ONLY. REG. 4-8-2003.
- 2,723,383. PLATINI. INT. CLS. 35 AND 40 ONLY. REG. 6-10-2003.
- 2,743,448. LL LAMPERTZ AND DESIGN. INT. CL. 16 ONLY. REG. 7-29-2003.
- 2,763,432. ECOPREP. INT. CL. 4 ONLY. REG. 9-16-2003.
- 2,774,391. COMNEON. INT. CLS. 35 AND 38 ONLY. REG. 10-21-2003.
- 2,774,564. COMNEON AND DESIGN. INT. CLS. 35 AND 38 ONLY. REG. 10-21-2003.

2,775,069. THINK BLUE YOU'RE THE SOLUTION TO STORM DRAIN POLLUTION. PROTECTING OUR BEACHES, BAYS, AND WATERSHEDS AND DESIGN. INT. CL. 16 ONLY. REG. 10-21-2003.

SECTION 18

1,490,301. JBJ. INT. CL. 25. REG. 5-31-1988.
 2,300,699. GUILTY. INT. CL. 25. REG. 12-14-1999.
 2,310,252. H2O TO GO. INT. CLS. 11 AND 35. REG. 1-25-2000.
 2,623,813. CHOCOLOGIE. INT. CL. 30. REG. 9-24-2002.
 2,672,394. KOSKA HELVACISI MERTER AND DESIGN. INT. CLS. 29 AND 30. REG. 1-7-2003.
 2,733,257. RATE BUSTER. INT. CL. 36. REG. 7-1-2003.
 2,915,795. MMA INSIDER. INT. CL. 41. REG. 1-4-2005.

3,018,570. KM RACE LINE AND DESIGN. INT. CL. 25. REG. 11-22-2005.
 3,095,304. CITYBLOCK AND DESIGN. INT. CL. 36. REG. 5-23-2006.
 3,115,461. LEDESMA CLASSICSTANDARD CHARACTER MARK INT. CL. 16. REG. 7-11-2006.
 3,122,507. VERONA AND DESIGN. INT. CL. 34. REG. 8-1-2006.
 3,276,969. THE COOKIE STORE AND DESIGN. INT. CL. 30. REG. 8-7-2007.
 3,280,262. NEXWAVE. INT. CLS. 9 AND 42. REG. 8-14-2007.
 3,309,604. ISLAND HEALTH FOODSSTANDARD CHARACTER MARK INT. CL. 35. REG. 10-9-2007.
 3,335,873. SAFEEXITSSTANDARD CHARACTER MARK INT. CL. 11. REG. 11-13-2007.
 3,406,336. 2CJCSTANDARD CHARACTER MARK INT. CL. 14. REG. 4-1-2008.
 3,483,285. CLICK HERE TO WATCH EVENTS NOW AND DESIGN. INT. CL. 38. REG. 8-12-2008.

* * * * *

TRADEMARK REGISTRATIONS AMENDED, CORRECTED, ETC.

The designation "U.S. Cl." appearing in this section refers to the U.S. class in effect prior to Sep. 1, 1973 rather than the international class which applies to applications filed on or after that date. For adoption of international classification see notice in the OFFICIAL GAZETTE of Jun. 26, 1973 (911 O.G. TM 210).

Any change to the registration will be indicated at the bottom of each entry under ELEMENTS AMENDED, CORRECTED OR RESTRICTED. With the exception of changes to the goods and services, additions to the registration will appear in asterisks and deletions of the registration will appear in brackets. Elements which are only changed will be listed with no punctuation. As to the goods/services statement, amendments to the goods/services will appear in asterisks and deletions will appear in brackets. In addition if any change to the goods/services occurs, the element "Goods/Services" will be listed under ELEMENTS AMENDED, CORRECTED OR RESTRICTED.

1,428,720. REG. 2-10-1987. WFC HOLDINGS CORPORATION (DELAWARE CORPORATION) SIX AND MARQUETTE, 1700 WELLS FARGO CENTER, MAC N9305-176, MINNEAPOLIS, MN, 55479, SN 73-584,438. FILED 2-24-1986. PRINCIPAL REGISTER.

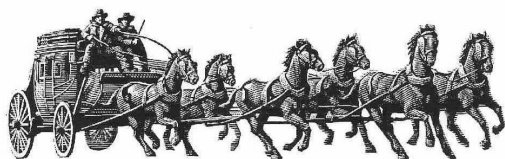

OWNER OF U.S. REG. NOS. 743,913, 1,151,228 AND OTHERS.

THE LINING SHOWN IN THE MARK ON THE DRAWING IS A FEATURE OF THE MARK AND DOES NOT REPRESENT COLOR.

INT. CL. 36/U.S. CL. 102

FOR BANKING AND TRUST SERVICES.
FIRST USE 1-22-1986; IN COMMERCE 1-22-1986.

ELEMENTS AMENDED

OWNER ADDRESS

ASSIGNMENT/NAME CHANGE
MARK

2,507,610. REG. 11-13-2001. BROTHERHOOD MUTUAL INSURANCE COMPANY (INDIANA CORPORATION) 6400 BROTHERHOOD WAY PO BOX 2227, FT. WAYNE, IN, 468012227, SN 75-670,793. FILED 4-1-1999. PRINCIPAL REGISTER.

INTERNATIONAL INSURANCE PROTECTION FOR TRAVELERS WITH A MISSION

NO CLAIM IS MADE TO THE EXCLUSIVE RIGHT TO USE "INTERNATIONAL INSURANCE PROTECTION FOR TRAVELERS", APART FROM THE MARK AS SHOWN.
INT. CL. 36/U.S. CLS. 100, 101 AND 102

FOR INSURANCE SERVICES, NAMELY, [INSURANCE BROKERAGE SERVICES,] INSURANCE UNDERWRITING IN THE FIELD OF LIABILITY, [LIFE,] FIRE, TRAVEL, [UNEMPLOYMENT] AND ACCIDENT INSURANCE; AND INSURANCE CONSULTATION.
FIRST USE 11-30-1999; IN COMMERCE 11-30-1999.

ELEMENTS AMENDED
GOODS/SERVICES

2,507,611. REG. 11-13-2001. BROTHERHOOD MUTUAL INSURANCE COMPANY (INDIANA CORPORATION) 6400 BROTHERHOOD WAY PO BOX 2227, FT. WAYNE, IN, 468012227, SN 75-670,794. FILED 4-1-1999. PRINCIPAL REGISTER.

PASSPORT TO MINISTRY

INT. CL. 36/U.S. CLS. 100, 101 AND 102

FOR INSURANCE SERVICES, NAMELY, [INSURANCE BROKERAGE SERVICES;] INSURANCE UNDERWRITING IN THE FIELD OF LIABILITY, [LIFE,] FIRE, TRAVEL, [UNEMPLOYMENT] AND ACCIDENT INSURANCE; AND INSURANCE CONSULTATION.
FIRST USE 11-30-1999; IN COMMERCE 11-30-1999.

ELEMENTS AMENDED
GOODS/SERVICES

2,539,765. REG. 2-19-2002. BROTHERHOOD MUTUAL INSURANCE COMPANY (INDIANA CORPORATION) 6400 BROTHERHOOD WAY, P.O. BOX 2227, FT. WAYNE, IN, 468012227, SN 76-121,651. FILED 8-30-2000. PRINCIPAL REGISTER.

BROTHERHOOD MUTUAL

NO CLAIM IS MADE TO THE EXCLUSIVE RIGHT TO USE "MUTUAL", APART FROM THE MARK AS SHOWN.

INT. CL. 36/U.S. CLS. 100, 101 AND 102

FOR INSURANCE SERVICES, NAMELY, [INSURANCE BROKERAGE SERVICES,] INSURANCE UNDERWRITING IN THE FIELD OF LIABILITY, [LIFE,] FIRE, TRAVEL, [UNEMPLOYMENT] AND ACCIDENT INSURANCE; AND INSURANCE CONSULTATION.
FIRST USE 8-20-1935; IN COMMERCE 8-20-1935.

ELEMENTS AMENDED
GOODS/SERVICES

2,582,239. REG. 6-18-2002. RISE CLUB, INC. (MASSACHUSETTS CORPORATION) 306 STUART STREET, BOSTON, MA, 02116, SN 76-329,218. FILED 10-22-2001. PRINCIPAL REGISTER.

RISE

INT. CL. 41/U.S. CLS. 100, 101 AND 107
FOR AFTER-HOURS NIGHT CLUB.
FIRST USE 6-0-1998; IN COMMERCE 6-0-1998.

ELEMENTS AMENDED
GOODS/SERVICES
INTERNATIONAL CLASS(ES)
DATE OF FIRST USE
DATE OF FIRST USE IN COMMERCE

2,626,723. REG. 9-24-2002. NINE WEST DEVELOPMENT CORP (DELAWARE CORPORATION) 1007 ORANGE STREET, SUITE 225, WILMINGTON, DE, 19801, SN 78-063,827. FILED 5-16-2001. PRINCIPAL REGISTER.

NINE & CO.

THE MARK CONSISTS OF STANDARD CHARACTERS WITHOUT CLAIM TO ANY PARTICULAR FONT, STYLE, SIZE, OR COLOR.

INT. CL. 14/U.S. CLS. 2, 27, 28 AND 50
FOR JEWELRY.
FIRST USE 3-1-2001; IN COMMERCE 3-1-2001.

ELEMENTS AMENDED
MARK

2,655,425. REG. 12-3-2002. BORROWED TIME, INC. (TEXAS CORPORATION) P.O. BOX 202785, AUSTIN, TX, 787202785, SN 76-024,990. FILED 4-12-2000. PRINCIPAL REGISTER.

BORROWED TIME

NO CLAIM IS MADE TO THE EXCLUSIVE RIGHT TO USE "INC.", APART FROM THE MARK AS SHOWN.

INT. CL. 9/U.S. CLS. 21, 23, 26, 36 AND 38
FOR BUSINESS CLASS APPLICATIONS SOFTWARE FOR OTHERS, *NAMELY,* FOR DATABASE AND INFORMATION MANIPULATION, STORAGE, AND TRANSMITTAL, [NAMELY, BUSINESS CLASS APPLICATIONS SOFTWARE FOR OTHERS,] FOR INFORMATION SECURITY PROVIDING AUTHENTICATION, ENCRYPTION AND AUDITING; BUSINESS CLASS APPLICATIONS SOFTWARE FOR OTHERS, NAMELY, FOR REAL-TIME ELECTRONIC COMMERCE USAGE FOR THE PROCESSING OF CREDIT, DEBIT, WIRE AND OTHER TRANSACTIONAL PROCESSING.

FIRST USE 8-31-1995; IN COMMERCE 8-31-1995.
INT. CL. 42/U.S. CLS. 100 AND 101
FOR COMPUTER SERVICES FOR OTHERS, NAMELY, CUSTOMIZATION OF COMPUTERS, COMPUTER PERIPHERALS AND GENERAL DEVICE CONTROL LOGIC.
FIRST USE 8-31-1995; IN COMMERCE 8-31-1995.

ELEMENTS AMENDED
GOODS/SERVICES
MARK

2,656,218. REG. 12-3-2002. ADCO INDUSTRIES - TECHNOLOGIES, L.P. (TEXAS LIMITED PARTNERSHIP) 11333 PAGEMILL ROAD, DALLAS, TX, 75243, SN 76-324,349. FILED 10-11-2001. PRINCIPAL REGISTER.

PRO-TECT 2000

INT. CL. 8/U.S. CLS. 23, 28 AND 44
FOR HAND TOOLS, NAMELY, SAFETY BOX CUTTERS USED FOR OPENING CASES OF MERCHANDISE WITHOUT DAMAGING THE PRODUCT WITHIN.
FIRST USE 1-17-2000; IN COMMERCE 1-24-2000.

ELEMENTS CORRECTED
OWNER NAME
OWNER ADDRESS

2,657,637. REG. 12-10-2002. CABO WABO LLC (DELAWARE LIMITED LIABILITY COMPANY) 1 BEACH STREET, SUITE 300, SAN FRANCISCO, CA, 94133, SN 75-833,279. FILED 10-27-1999. PRINCIPAL REGISTER.

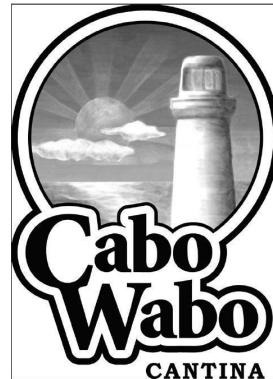

INT. CL. 25/U.S. CLS. 22 AND 39
FOR SHORTS, SHIRTS, SWEATSHIRTS, CHILDREN'S SWEATSHIRTS, T-SHIRTS, CHILDREN'S T-SHIRTS.
FIRST USE 6-18-1999; IN COMMERCE 6-18-1999.

ELEMENTS AMENDED
MARK

2,911,896. REG. 12-21-2004. ENTRIQ INC. (DELAWARE CORPORATION) 1013 CENTRE ROAD, WILMINGTON, DE, 19805, SN 75-922,887. FILED 2-18-2000. PRINCIPAL REGISTER.

ENTRIQ

OWNER OF BENELUX REG. NO. 691208, DATED 1-25-2000.
INT. CL. 35/U.S. CLS. 100, 101 AND 102

FOR ADVERTISING AND BUSINESS SERVICES AND ADVERTISING AND BUSINESS SERVICES PROVIDED THROUGH A GLOBAL COMPUTER NETWORK, NAMELY, ADVERTISING AGENCIES; PROMOTION AGENCIES, NAMELY, PROMOTING THE SERVICES OF COMMUNICATIONS COMPANIES THROUGH THE DISTRIBUTION OF PRINTED AND AUDIO PROMOTIONAL MATERIALS AND BY RENDERING SALES PROMOTION ADVICE; RENTAL OF ADVERTISING SPACE; BUSINESS MANAGEMENT SERVICES; ACCOUNTING SERVICES; BUSINESS PLANNING AND CONSULTATION SERVICE; BUSINESS INFORMATION SERVICES, NAMELY, INFORMATION ON BUILDING BUSINESS THROUGH NETWORKING AND MARKET RESEARCH SERVICES; BILLING SERVICES; [PUBLICITY AGENT AND PUBLIC RELATIONS SERVICES;] BUSINESS CONSULTATION, BUSINESS MANAGEMENT AND BUSINESS INFORMATION SERVICES IN THE FIELD OF SUBSCRIPTIONS TO MULTI-MEDIA SERVICES, NAMELY, CABLE TELEVISION; [ARRANGING AND CONDUCTING TRADE SHOWS AND EXHIBITIONS IN THE FIELD OF GLOBAL COMMUNICATIONS; DISSEMINATION OF ADVERTISING AND PROMOTIONAL MATTER FOR OTHERS;] RETAIL AND WHOLESALE STORE AND MAIL ORDER AND DISTRIBUTORSHIP SERVICES IN THE FIELD OF MULTI-MEDIA EDUCATIONAL AND ENTERTAINMENT PRODUCTS.

FIRST USE : IN COMMERCE .

INT. CL. 38/U.S. CLS. 100, 101 AND 104

FOR VOICE, DATA, SOUND AND IMAGE COMMUNICATIONS SERVICES, NAMELY, THE ELECTRONIC TRANSMISSION OF MESSAGES AND DATA, TELEPHONE COMMUNICATIONS, RADIO COMMUNICATIONS, AUDIO AND VIDEO TELECONFERENCING, AND ELECTRONIC MAIL SERVICES; TELECOMMUNICATIONS AND TELECOMMUNICATIONS GATEWAY SERVICES, NAMELY, LONG DISTANCE TELEPHONE SERVICES AND PROVIDING GATEWAY LINKS FOR PERSONAL COMMUNICATIONS AND ISDN; RADIO, TELEVISION, SATELLITE AND CABLE BROADCASTING SERVICES; NEWS AGENCIES, NAMELY, THE GATHERING AND DISSEMINATION OF NEWS; TELEVISION, RADIO AND CABLE BROADCASTING SERVICES FEATURING LIVE PERFORMANCES AND EVENTS; RENTAL AND LEASING OF TELECOMMUNICATIONS EQUIPMENT; SUBSCRIPTION TELEVISION BROADCASTING SERVICES; PROVISION OF TELECOMMUNICATIONS CONNECTIONS TO A GLOBAL COMPUTER NETWORK; PROVIDING MULTIPLE USER ACCESS TO A GLOBAL COMPUTER INFORMATION NETWORK FOR THE TRANSFER AND DISSEMINATION OF A WIDE RANGE OF INFORMATION.

FIRST USE : IN COMMERCE .

INT. CL. 41/U.S. CLS. 100, 101 AND 107

FOR EDUCATION AND ENTERTAINMENT SERVICES, NAMELY, PRODUCTION AND RECORDING OF RADIO, TELEVISION, VIDEO, SATELLITE AND CABLE PROGRAMS; ENTERTAINMENT AND EDUCATIONAL SERVICES, NAMELY, PRODUCTION AND AUDIO AND VIDEO RECORDING OF LIVE PERFORMANCES, SHOWS, EVENTS, CONCERTS, MUSICAL, DRAMA AND COMEDY THEATRE PRODUCTIONS; ORGANIZING EVENTS IN THE FIELD OF SPORTS ACTIVITIES, NAMELY, PROFESSIONAL, COLLEGE, HIGH SCHOOL AND AMATEUR FOOTBALL, SOCCER, BASEBALL, CRICKET, HOCKEY, BASKETBALL, TENNIS, VOLLEYBALL, RUGBY, BADMINTON, HURLING, GYMNASTICS, SKIING, SWIMMING, BOATING, DIVING, ICE SKATING, LUGE, RUNNING, BIATHLON, TRIATHLON AND DECATHLON COMPETITIONS, GAMES, MEETS AND TOURNAMENTS; PRODUCTION AND RECORDING OF PUBLIC EVENTS, NAMELY, MUSICAL RECITALS, DEBATES, PUBLIC AND PRIVATE GATHERINGS, CULTURAL ACTIVITIES AND EVENTS, CONFERENCES, MEETINGS, RALLIES AND DISPLAYS; RENTAL OF CINEMA FILMS, VIDEO RECORDINGS, AUDIO RECORDINGS AND CD-ROMS IN THE FIELD OF ENTERTAINMENT; RENTAL AND LEASING OF APPARATUS AND INSTRUMENTS, NAMELY, CINEMA, FILM AND MOVIE PROJECTOR APPARATUS AND ACCESSORIES AND TAPE RECORDING EQUIPMENT; PUBLICATION OF BOOKS, MANUALS, MAGAZINES AND TEXTS; PRODUCTION AND DISTRIBUTION OF MOTION PICTURES; VIDEOTAPE PRODUCTION; AUDIO AND MULTIMEDIA RECORDING AND PRODUCTION.

FIRST USE : IN COMMERCE .

INT. CL. 42/U.S. CLS. 100 AND 101

FOR RESTAURANTS, [NIGHT CLUBS,] BARS, CAFETERIAS; PROVIDING AN ON-LINE ELECTRONIC DATABASE AND LEASING ACCESS TIME TO COMPUTER DATABASES IN THE FIELD OF INFORMATION TECHNOLOGY; [COMPUTER RENTAL;] COMPUTER SERVICES, NAMELY, DESIGNING AND IMPLEMENTING WEB SITES FOR OTHERS; AND NEWS AGENCIES, NAMELY, THE GATHERING AND DISSEMINATION OF NEWS; PROVIDING ELECTRONIC ON-LINE PUBLICATIONS IN THE NATURE OF GENERAL FEATURE MAGAZINES AND NEWSLETTERS.

FIRST USE : IN COMMERCE .

ELEMENTS AMENDED
GOODS/SERVICES

3,037,348. REG. 1-3-2006. VALUE DRYCLEANERS OF AMERICA, LLC (MARYLAND LIMITED LIABILITY COMPANY) 7500 GREENWAY CENTER DRIVE, GREENBELT, MD, 20770, SN 76-613,820. FILED 9-27-2004. PRINCIPAL REGISTER.



OWNER OF U.S. REG. NO. 2,762,741.

NO CLAIM IS MADE TO THE EXCLUSIVE RIGHT TO USE "DRY CLEANERS", APART FROM THE MARK AS SHOWN.

THE MARK CONSISTS OF THE WORDS "ZIPS DRY CLEANERS". THE "Z" IS STYLIZED AND EACH LETTER OF THE WORD "ZIPS" APPEARS INSIDE A CIRCLE. THE FOUR CIRCLES ARE TOUCHING IN A HORIZONTAL ROW. BELOW THE WORD "ZIPS" APPEAR THE WORDS "DRY CLEANERS" WITH A BLACK OVAL BEHIND "DRY CLEANERS".

INT. CL. 37/U.S. CLS. 100, 103 AND 106

FOR DRY CLEANING SERVICES.

FIRST USE 10-14-2002; IN COMMERCE 10-14-2002.

ELEMENTS AMENDED
DESCRIPTION OF MARK
OWNER ADDRESS
MARK

3,107,144. REG. 6-20-2006. DEF CON COMMUNICATIONS, INC. (WASHINGTON CORPORATION) SUITE 406, 2606 2ND AVE, SEATTLE, WA, 98121, SN 76-172,548. FILED 11-29-2000. PRINCIPAL REGISTER.

DEF CON

INT. CL. 9/U.S. CLS. 21, 23, 26, 36 AND 38

FOR COMPUTER SOFTWARE, NAMELY, COMPUTER SOFTWARE USED FOR ENHANCING COMPUTER SECURITY; COMPUTER SOFTWARE, NAMELY, SOFTWARE USED FOR ENHANCING INTERNET SECURITY; ANTI-VIRUS SOFTWARE; COMPUTER SOFTWARE FOR TROUBLE-SHOOTING OF COMPUTER HARDWARE AND SOFTWARE PROBLEMS; NETWORK SECURITY ENHANCEMENT SOFTWARE AND USER MANUALS SOLD THEREWITH.

FIRST USE 7-23-2005; IN COMMERCE 7-23-2005.

ELEMENTS CORRECTED
OWNER NAME

3,151,117. REG. 10-3-2006. EBWE PHARMA GES.M.B.H. NFG. KG (AUSTRIA LIMITED PARTNERSHIP) MONDSEESTRASSE 11, A-4866 UNTERACH, AUSTRIA., SN 79-003,807. FILED 4-20-2004. PRINCIPAL REGISTER.



PRIORITY DATE OF 12-4-2003 IS CLAIMED.
 OWNER OF INTERNATIONAL REGISTRATION 0828661 DATED 4-20-2004, EXPIRES 4-20-2014.
 OWNER OF U.S. REG. NO. 1,921,442 AND OTHERS.
 NO CLAIM IS MADE TO THE EXCLUSIVE RIGHT TO USE PHARMA, APART FROM THE MARK AS SHOWN.
 INT. CL. 5/U.S. CLS. 6, 18, 44, 46, 51 AND 52
 FOR PHARMACEUTICAL AND VETERINARY PREPARATIONS USED FOR TREATMENT OF CANCER, CENTRAL NERVOUS SYSTEM DISEASES; IMMUNOLOGICAL DEFICIENCIES AND HEART AND CIRCULATORY PROBLEMS; FOOD SUPPLEMENTS FOR MEDICAL USE.
 FIRST USE ; IN COMMERCE .

ELEMENTS CORRECTED
 CITIZENSHIP
 ENTITY

3,294,338. REG. 9-18-2007. DE MATTEIS AGROALIMENTARE S.P.A. (ITALY CORPORATION) VIA AMORETTA, PARCO SAN NICOLA, 6/E; I-83100 AVELLINO, ITALY., SN 79-032,735. FILED 10-9-2006. PRINCIPAL REGISTER.



Anima e Sapore

OWNER OF INTERNATIONAL REGISTRATION 0908134 DATED 10-9-2006, EXPIRES 10-9-2016.
 NO CLAIM IS MADE TO THE EXCLUSIVE RIGHT TO USE SAPORE, APART FROM THE MARK AS SHOWN.
 THE ENGLISH TRANSLATION OF BARONIA ANIMA E SAPORE IN THE MARK IS BARONY SOUL AND FLAVOR.
 INT. CL. 29/U.S. CL. 46
 FOR OLIVE OIL; [CANNED TOMATOES; PEELED TOMATOES;] TINNED TOMATOES; [TOMATO PUREE;] TOMATO SAUCE.
 FIRST USE ; IN COMMERCE .

ELEMENTS CORRECTED
 GOODS/SERVICES
 [INTERNATIONAL CLASS(ES)]

3,275,119. REG. 8-7-2007. LAUFER BATINOVICH, SARA (UNITED STATES INDIVIDUAL) P.O. BOX 4872, FEDERAL WAY, WA, 980634872, SN 78-941,800. FILED 7-31-2006. PRINCIPAL REGISTER.

WHATGIRL

THE MARK CONSISTS OF STANDARD CHARACTERS WITHOUT CLAIM TO ANY PARTICULAR FONT, STYLE, SIZE, OR COLOR.
 INT. CL. 35/U.S. CLS. 100, 101 AND 102
 FOR DEMOGRAPHIC CONSULTATION AND STUDIES IN THE DISABILITY DOMAIN, SPECIFICALLY RELATING TO ISSUES OF HEARING LOSS AND HEARING HEALTH CARE .
 FIRST USE 7-5-2005; IN COMMERCE 7-21-2006.

ELEMENTS AMENDED
 OWNER NAME
 OWNER ADDRESS
 CITIZENSHIP
 ENTITY

3,311,629. REG. 10-16-2007. ELDORADO STONE OPERATIONS, LLC (UTAH LIMITED LIABILITY COMPANY) 10653 S. RIVER FRONT PARKWAY, SUITE 300, SOUTH JORDAN, UT, 84095, SN 78-119,003. FILED 4-2-2002. PRINCIPAL REGISTER.

CLIFFSTONE

THE MARK CONSISTS OF STANDARD CHARACTERS WITHOUT CLAIM TO ANY PARTICULAR FONT, STYLE, SIZE, OR COLOR.
 INT. CL. 19/U.S. CLS. 1, 12, 33 AND 50
 FOR BUILDING PRODUCTS, NAMELY MANUFACTURED STONE VENEERS FOR EXTERIOR OR INTERIOR VERTICAL SURFACES OF WALLS AND BUILDINGS .
 FIRST USE 6-30-2001; IN COMMERCE 6-30-2001.

ELEMENTS CORRECTED
 OWNER ADDRESS
 CITIZENSHIP
 ASSIGNMENT/NAME CHANGE
 MARK

3,365,751. REG. 1-8-2008. JAPAN POST HOLDINGS CO., LTD. (JAPAN CORPORATION) 3-2 KASUMIGASEKI, 1-CHOME, CHIYODA-KU, TOKYO 100-8798, JAPAN., SN 78-855,630. FILED 4-6-2006. PRINCIPAL REGISTER.

JAPAN POST

THE MARK CONSISTS OF STANDARD CHARACTERS WITHOUT CLAIM TO ANY PARTICULAR FONT, STYLE, SIZE, OR COLOR.

OWNER OF JAPAN REG. NO. 4910081, DATED 11-25-2005, EXPIRES 11-25-2013.

OWNER OF JAPAN REG. NO. 4725340, DATED 11-14-2003, EXPIRES 11-14-2013.

NO CLAIM IS MADE TO THE EXCLUSIVE RIGHT TO USE "JAPAN", APART FROM THE MARK AS SHOWN.

INT. CL. 36/U.S. CLS. 100, 101 AND 102

FOR FINANCIAL SERVICES, NAMELY, THE ACCEPTANCE OF DEPOSITS FOR THE PURCHASE OF SUBSTITUTE BONDS; ACCEPTANCE OF FIXED INTERVAL INSTALLMENT DEPOSITS * FOR SAVINGS ACCOUNT *; LOANS FINANCING AND DISCOUNT OF BILLS; DOMESTIC FINANCIAL EXCHANGE SERVICES; SECURITIES LENDING; ACQUISITION AND TRANSFER OF MONETARY CLAIMS; SAFE DEPOSIT SERVICES FOR THE SAFEKEEPING OF VALUABLES, NAMELY, SECURITIES AND PRECIOUS METALS; CURRENCY EXCHANGE SERVICES; TRUSTEESHIP REPRESENTATIVES OF MONEY, SECURITIES, * SECURITIES IN THE NATURE OF FINANCIAL FUTURES CONTRACTS, * MONETARY CLAIMS, PERSONAL PROPERTY, LAND, RIGHTS ON LAND FIXTURES, SURFACE RIGHTS OR LEASE ON LAND; AGENCIES FOR BOND SUBSCRIPTIONS; FOREIGN EXCHANGE TRANSACTIONS; BROKERAGE FOR HIRE-PURCHASE; ISSUE OF TOKENS OF VALUE; AGENCIES FOR COLLECTING GAS OR ELECTRIC POWER UTILITY PAYMENTS; CHARITABLE FUND RAISING; LIFE INSURANCE BROKERAGE; LIFE INSURANCE UNDERWRITING; AGENCIES FOR NON-LIFE INSURANCE; CLAIM ADJUSTMENT FOR NON-LIFE INSURANCE; NON-LIFE INSURANCE UNDERWRITING; INSURANCE PREMIUM RATE COMPUTING.

FIRST USE ; IN COMMERCE .

INT. CL. 39/U.S. CLS. 100 AND 105

FOR RAILWAY TRANSPORT; CAR TRANSPORT; VESSEL TRANSPORT; AIR TRANSPORT.

FIRST USE ; IN COMMERCE .

ELEMENTS CORRECTED
GOODS/SERVICES

3,385,776. REG. 2-19-2008. QUIBOS S.R.L. (ITALY A LIMITED LIABILITY COMPANY) VIA DANTE ALIGHIERI, 23/A, I-36065 MUSSOLENTE (VICENZA), ITALY., SN 79-037,080. FILED 7-6-2006. PRINCIPAL REGISTER.

MYBIKE

OWNER OF INTERNATIONAL REGISTRATION 0563340 DATED 12-6-1990, EXPIRES 12-6-2010.
INT. CL. 25/U.S. CLS. 22 AND 39

FOR MEN, WOMEN AND CHILDREN'S CLOTHING, NAMELY, JACKETS, JERSEYS, TIGHTS, BIB-TIGHTS, WAISTCOATS, RIPSTOP VESTS, WATERPROOF VEST, BIB-KNICKERS, TROUSERS AND PANTS, T-SHIRTS, SWEATERS, BODICES, TOPS, SHORTS AND ACCESSORIES FOR CYCLISM CLOTHING, NAMELY, GLOVES, HATS AND CAPS, NECKWARMERS, HEADBANDS, BALACLAVAS, ARMWARMERS, KNEE WARMERS, LEG WARMERS, SOCKS AND SHOES COVERS; UNDERWEAR.

FIRST USE ; IN COMMERCE .

ELEMENTS CORRECTED
GOODS/SERVICES

3,396,810. REG. 3-11-2008. TIME DOLLAR INSTITUTE (D.C. CORPORATION) 5500 39TH ST NW, WASHINGTON, DC, 20015, SN 78-977,789. FILED P.R. 7-19-2004; AM. S.R. 2-5-2008. SUPPLEMENTAL REGISTER.

Time Banks

THE MARK CONSISTS OF STANDARD CHARACTERS WITHOUT CLAIM TO ANY PARTICULAR FONT, STYLE, SIZE, OR COLOR.

INT. CL. 35/U.S. CLS. 100, 101 AND 102

FOR ADMINISTERING A TAX-EXEMPT TIME CREDIT EXCHANGE REWARDS PROGRAM WHEREBY PARTICIPANTS WHO PARTICIPATE IN VOLUNTEER AND COMMUNITY SERVICE INITIATIVES CAN ACCUMULATE CREDIT THAT CAN BE USED TO PURCHASE MERCHANDISE ITEMS AND SERVICES PROVIDED BY OTHER MEMBERS.

FIRST USE 1-3-2000; IN COMMERCE 1-3-2000.

ELEMENTS CORRECTED
CITIZENSHIP

3,405,304. REG. 4-1-2008. TOTO LTD. (JAPAN CORPORATION) NO. 1-1 NAKASHIMA 2-CHOME, KOKURAKITAKU, KITAKYUSHU-SHI, JAPAN., SN 78-580,607. FILED 3-4-2005. PRINCIPAL REGISTER.

FOR (BASED ON FOREIGN REG #1027893) MEASURING APPARATUS AND INSTRUMENTS AND THEIR PARTS AND ACCESSORIES, NAMELY, HIGH-PRECISION LARGE-SIZE STRAIGHT EDGES, SURFACE PLATES, NAMELY, CERAMIC SURFACE PLATES FOR PROVIDING AN ACCURATE REFERENCE PLANE FOR WORK INSPECTION AND FOR WORK LAYOUT AND T-SQUARES; DRAFTING SQUARES, GUIDE SHAFTS FOR COORDINATE MEASURING MACHINES, AND PORTABLE STRAIGHTNESS TESTERS; CONNECTORS FOR OPTICAL FIBER CABLES AND THEIR COMPONENT PARTS, OPTICAL FIBER CABLES AND THEIR COMPONENT PARTS.

FIRST USE ; IN COMMERCE .

TOTO

OWNER OF JAPAN REG. NO. 1488448, DATED 4-30-1996, EXPIRES 4-30-2016.

OWNER OF JAPAN REG. NO. 3005051, DATED 9-30-1994, EXPIRES 9-30-2014.

OWNER OF JAPAN REG. NO. 3044724, DATED 5-31-1995, EXPIRES 5-31-2015.

OWNER OF JAPAN REG. NO. 1413992, DATED 4-30-1980, EXPIRES 4-30-2010.

OWNER OF JAPAN REG. NO. 2705688, DATED 3-31-1995, EXPIRES 3-31-2015.

OWNER OF JAPAN REG. NO. 998594, DATED 2-5-1973, EXPIRES 2-5-2013.

OWNER OF JAPAN REG. NO. 1027893, DATED 8-20-1973, EXPIRES 8-20-2013.

OWNER OF JAPAN REG. NO. 4360259, DATED 2-10-2000, EXPIRES 2-10-2010.

OWNER OF JAPAN REG. NO. 4042553, DATED 8-15-1997, RENEWED AS REG. NO. 4042553, DATED 3-13-2007, EXPIRES 8-15-2017.

OWNER OF JAPAN REG. NO. 1741315, DATED 1-23-1985, EXPIRES 1-23-2015.

OWNER OF U.S. REG. NOS. 1,140,338, 1,473,016 AND OTHERS.

INT. CL. 1/U.S. CLS. 1

FOR (BASED ON FOREIGN REG #1741315) ANTI-TARNISHING CHEMICALS FOR VEHICLE WINDOWS.

FIRST USE ; IN COMMERCE .

INT. CL. 2/U.S. CLS. 6, 11 AND 16

FOR (BASED ON FOREIGN REG #4042553) CLEAR AND PIGMENTED COATINGS USED IN THE NATURE OF PAINTS, PAINTS; COATINGS IN THE NATURE OF AUTOMOBILE FINISHING.

FIRST USE ; IN COMMERCE .

INT. CL. 6/U.S. CLS. 2, 12, 13, 14, 23, 25 AND 50

FOR (BASED ON FOREIGN REG #4360259) HAND RAILS OF METAL; METAL PIPES.

FIRST USE ; IN COMMERCE .

INT. CL. 7/U.S. CLS. 13, 19, 21, 23, 31, 34 AND 35

FOR (BASED ON FOREIGN REG #1408448) MACHINE PARTS, NAMELY, ELECTROSTATIC CHUCKS FOR USE IN THE PRODUCTION OF SEMICONDUCTOR WAFERS; DISHWASHERS, GARBAGE DISPOSALS, DISPOSAL SYSTEM FOR WASTE CONSISTING OF DISPOSERS, DRAIN PIPES AND DRAINAGE TREATMENT EQUIPMENT, NAMELY, WASTEWATER PURIFICATION MACHINES USED FOR COMPLEX HOUSING, DRAINAGE TREATMENT EQUIPMENT, NAMELY, WASTEWATER PURIFICATION MACHINES, HOT WATER HEATERS; MACHINE PARTS, NAMELY, CLACK VALVES AND VALVES; REGULATORS BEING PARTS OF MACHINES, NAMELY, FEED WATER REGULATORS; SEMICONDUCTOR MANUFACTURING MACHINES AND STRUCTURAL PARTS AND ACCESSORIES THEREFOR, LIQUID CRYSTAL MANUFACTURING MACHINES AND STRUCTURAL PARTS AND ACCESSORIES THEREFOR; METAL MACHINE PARTS, NAMELY, PIPE HOLDERS; HARD DISK DRIVE MANUFACTURING MACHINES.

FIRST USE ; IN COMMERCE .

INT. CL. 9/U.S. CLS. 21, 23, 26, 36 AND 38

INT. CL. 11/U.S. CLS. 13, 21, 23, 31 AND 34

FOR (BASED ON FOREIGN REG #998594) WATER CLOSETS, GAS WATER HEATERS, ELECTRIC HOT AIR HAND DRYER FOR WASHROOMS, ELECTRIC APPARATUS FOR BATHROOM FOR HEATING, DRYING AND VENTILATING, NAMELY, AIR-CONDITIONING MACHINES INSTALLED ONTO BATHROOM CEILINGS, WATER PURIFYING APPARATUS, SOLAR WATER HEATERS; ACCESSORIES FOR BATHTUBS AND BATHROOM, NAMELY, SHOWERS; PLUMBING AND BATHROOM FITTINGS, NAMELY, BALL TAPS FOR USE WITH WATER CLOSET TANK, LEVEL CONTROLLING VALVES IN TANKS, WATER TREATMENT TANKS FOR HOUSEHOLD PURPOSES, AUTOMATICALLY FLUSHING APPARATUS FOR TOILETS ACTIVATED BY A SENSOR CONSISTING OF SENSORS, FLUSHMETERS AND CONTROLLERS, AERATORS IN THE NATURE OF BUBBLE MAKERS FIXED TO FAUCETS; PLUMBING FITTINGS, NAMELY, SAFETY VALVES, DECOMPRESSION VALVES, WATER STOPPING VALVES, AUTOMATIC SEAT TOILET PAPER DISPENSER, AUTOMATIC WASH-HAND BOWLS, WASH-HAND BASINS, SHOWER BOOTH, GAS BURNER, FLUSH VALVES, SHOWER PANS, LAMPS; PLUMBING FITTINGS, NAMELY, PLASTIC DRAIN TRAPS AND VALVES; INFLOW AND OUTFLOW PLUMBING FITTINGS, NAMELY, PLASTIC WATER PIPE VALVES; PLUMPING FITTINGS, NAMELY, DRAIN COCKS.

FIRST USE ; IN COMMERCE .

INT. CL. 19/U.S. CLS. 1, 12, 33 AND 50

FOR (BASED ON FOREIGN REG #1413992) TILES, NOT OF METAL.

FIRST USE ; IN COMMERCE .

INT. CL. 35/U.S. CLS. 100, 101 AND 102

FOR (BASED ON FOREIGN REG #3044724) ADVERTISING AGENCY SERVICES; PLANNING AND CONDUCTING EXHIBITIONS FOR COMMERCIAL OR ADVERTISING PURPOSES; PROVISION OF BUSINESS INFORMATION OF INSTALLATIONS FOR KITCHENS, BATHS, TOILETS VIA INTERNET.

FIRST USE ; IN COMMERCE .

INT. CL. 42/U.S. CLS. 100 AND 101

FOR (BASED ON FOREIGN REG #3005051) ENGINEERING.

FIRST USE ; IN COMMERCE .

ELEMENTS CORRECTED
FOREIGN REG. NO.

3,448,131. REG. 6-17-2008. THE GENERAL COUNCIL OF THE ASSEMBLIES OF GOD (MISSOURI CORPORATION) 1445 NORTH BOONVILLE AVENUE, SPRINGFIELD, MO, 65802, SN 77-221,882. FILED 7-3-2007. PRINCIPAL REGISTER.

HONOR BOUND

THE MARK CONSISTS OF STANDARD CHARACTERS WITHOUT CLAIM TO ANY PARTICULAR FONT, STYLE, SIZE, OR COLOR.

OWNER OF U.S. REG. NO. 2,166,912.
INT. CL. 45/U.S. CLS. 100 AND 101
FOR MINISTERIAL SERVICES.
FIRST USE 6-7-1996; IN COMMERCE 6-7-1996.

ELEMENTS CORRECTED
OWNER NAME



3,468,285. REG. 7-15-2008. LOMOGRAPHISCHE AG (AUSTRIA PUBLIC LIMITED COMPANY) HOLLERGASSE 41, A-1150 WIEN, AUSTRIA., SN 79-044,479. FILED 7-30-2007. PRINCIPAL REGISTER.

LOMOGRAPHY

THE MARK CONSISTS OF STANDARD CHARACTERS WITHOUT CLAIM TO ANY PARTICULAR FONT, STYLE, SIZE, OR COLOR.

PRIORITY DATE OF 2-14-2007 IS CLAIMED.
OWNER OF INTERNATIONAL REGISTRATION 0939100 DATED 7-30-2007, EXPIRES 7-30-2017.
OWNER OF U.S. REG. NOS. 299,576 AND 2,593,671.

INT. CL. 18/U.S. CLS. 1, 2, 3, 22 AND 41
FOR TRAVELING TRUNKS AND VALISES, BRIEF-CASES, BEACH BAGS, WALLETS, CAMPING BAGS, DOCUMENTS CASES, CANVAS SHOPPING BAGS, KEY CASES, HANDBAGS, TRAVELING BAGS, RUCKSACKS, UMBRELLAS, PARASOLS, ROLL BAGS, BABY CARRYING BAGS.
FIRST USE ; IN COMMERCE .

ELEMENTS CORRECTED
[GOODS/SERVICES]
[INTERNATIONAL CLASS(ES)]



3,484,442. REG. 8-12-2008. NATIONAL CUTTING HORSE ASSOCIATION (TEXAS CORPORATION) 260 BAILEY AVENUE, FORT WORTH, TX, 76107, SN 77-368,875. FILED 1-10-2008. PRINCIPAL REGISTER.



INT. CL. 16/U.S. CLS. 2, 5, 22, 23, 29, 37, 38 AND 50

FOR PRINTED TRADE AND HOBBY JOURNALS IN THE FIELD OF CUTTING HORSES; PRINTED PROGRAMS AND GUIDES FOR CUTTING HORSE EVENTS AND COMPETITIONS; PRINTED MANUALS FEATURING RULES AND BY-LAWS OF THE NATIONAL CUTTING HORSE ASSOCIATION; PRINTED INSTRUCTIONAL, EDUCATIONAL AND TEACHING MATERIALS IN THE FIELD OF CUTTING HORSES.

FIRST USE 2-1-1983; IN COMMERCE 2-1-1983.
INT. CL. 35/U.S. CLS. 100, 101 AND 102
FOR ASSOCIATION SERVICES, NAMELY, PROMOTING THE INTERESTS OF CUTTING HORSES AND CUTTING HORSE COMPETITIONS.

FIRST USE 2-1-1983; IN COMMERCE 2-1-1983.
INT. CL. 41/U.S. CLS. 100, 101 AND 107

FOR CONDUCTING COMPETITIONS IN THE FIELD OF CUTTING HORSES; PROVIDING COURSES ABOUT THE SPORT OF CUTTING HORSE COMPETITIONS AS IT RELATES TO HORSE CARE, RIDERS, TRAINERS, JUDGES AND OTHERS INVOLVED IN HORSE CUTTING COMPETITIONS; PROVIDING INFORMATION ABOUT HORSE CUTTING COMPETITIONS; PROVIDING ONLINE INFORMATION ABOUT HORSE CUTTING COMPETITIONS.
FIRST USE 2-1-1983; IN COMMERCE 2-1-1983.

ELEMENTS CORRECTED
OWNER NAME



3,485,306. REG. 8-12-2008. EVA DENMARK A/S (DENMARK PLC) MALØV TEKNIKERBY 18-20, DK-2760 MALØV, DENMARK., SN 79-046,018. FILED 10-9-2007. PRINCIPAL REGISTER.

EVA SOLO

OWNER OF INTERNATIONAL REGISTRATION 0942992 DATED 10-9-2007, EXPIRES 10-9-2017.

THE NAME(S), PORTRAIT(S), AND/OR SIGNATURE(S) SHOWN IN THE MARK DOES NOT IDENTIFY A PARTICULAR LIVING INDIVIDUAL.

INT. CL. 6/U.S. CLS. 2, 12, 13, 14, 23, 25 AND 50
FOR CREDIT CARD HOLDERS OF METAL, HOOKS OF METAL; NOTICE AND MESSAGE BOARDS OF METAL.
INT. CL. 8/U.S. CLS. 23, 28 AND 44

FOR NUTCRACKERS NOT OF PRECIOUS METALS; MALLETS, NAMELY, NUTHAMMERS NOT OF PRECIOUS METALS; NON-ELECTRIC FRUIT PEELERS; PARING KNIVES; FRUIT KNIVES; POME CORERS; HAND-OPERATED VEGETABLE SHREDDERS; NON-ELECTRIC TIN CAN OPENERS; NON-ELECTRIC PARSLEY MINCERS; NON-ELECTRIC PIZZA CUTTERS; NON-ELECTRIC CHEESE SLICERS; KNIFE STANDS; KNIFE MAGNETS.

INT. CL. 11/U.S. CLS. 13, 21, 23, 31 AND 34
FOR BARBECUE GRILLS; ELECTRIC GRILLS; ROASTING JACKS WITH SPITS.

INT. CL. 14/U.S. CLS. 2, 27, 28 AND 50
FOR BATTERY-POWERED CLOCKS.
INT. CL. 20/U.S. CLS. 2, 13, 22, 25, 32 AND 50
FOR WINE RACKS.

INT. CL. 21/U.S. CLS. 2, 13, 23, 29, 30, 33, 40 AND 50

FOR VASES NOT OF PRECIOUS METAL; FLOWER-POTS; FLOWERPOT COVERS NOT OF PAPER; CARAFES AND JUGS OF GLASS; VACUUM JUGS AND FLASKS; ICE BUCKETS; ICE CUBE MOLDS FOR REFRIGERATORS; CUPS, SAUCERS AND DRINKING GLASSES NOT OF PRECIOUS METALS; SPICE JARS; COFFEE AND TEA POTS, NOT ELECTRIC AND NOT OF PRECIOUS METALS; NON-ELECTRIC COFFEE MAKERS; NON-ELECTRIC WHISKS; LADLES FOR COOKING; SPATULAS; CAKE AND PIE SERVERS; FRUIT AND GARLIC PRESSES; NON-ELECTRIC GRATERS FOR KITCHEN PURPOSES; UTENSILS FOR BARBECUES, NAMELY, FORKS, TONGS, AND TURNERS; CHOPPING BOARDS FOR KITCHEN USE; BREAD BOXES; POT HOLDERS OF SILICONE; FEEDING TROUGHS AND TABLES FOR ANIMALS; NONE OF THE AFORESAID GOODS IN THE FORM OF DISPOSABLE GOODS OR REUSABLE DISPOSABLE GOODS.

INT. CL. 28/U.S. CLS. 22, 23, 38 AND 50

FOR PLAYING CARDS AND PLAYING CARD HOLDERS.

INT. CL. 34/U.S. CLS. 2, 8, 9 AND 17

FOR ASHTRAYS NOT OF PRECIOUS METALS FOR SMOKERS.

ELEMENTS CORRECTED
[GOODS/SERVICES]
[INTERNATIONAL CLASS(ES)]

3,502,340. REG. 9-16-2008. DREAMWORKS ANIMATION L.L.C. (DELAWARE LIMITED LIABILITY COMPANY) 1000 FLOWER STREET, GLENDALE, CA, 91201, SN 77-122,626. FILED 3-5-2007. PRINCIPAL REGISTER.



3,487,996. REG. 8-19-2008. NATIONAL CUTTING HORSE ASSOCIATION (TEXAS CORPORATION) 260 BAILEY AVENUE, FORT WORTH, TX, 76107, SN 77-368,459. FILED 1-10-2008. PRINCIPAL REGISTER.

NCHA WORLD CHAMPIONSHIP
FUTURITY

THE MARK CONSISTS OF STANDARD CHARACTERS WITHOUT CLAIM TO ANY PARTICULAR FONT, STYLE, SIZE, OR COLOR.

NO CLAIM IS MADE TO THE EXCLUSIVE RIGHT TO USE "WORLD CHAMPIONSHIP FUTURITY", APART FROM THE MARK AS SHOWN.

INT. CL. 41/U.S. CLS. 100, 101 AND 107

FOR ENTERTAINMENT SERVICES, IN PARTICULAR, SPONSORING CUTTING HORSE COMPETITIONS AND EXHIBITIONS.

FIRST USE 12-5-1980; IN COMMERCE 12-5-1980.

ELEMENTS CORRECTED
OWNER ADDRESS

OWNER OF U.S. REG. NOS. 2,596,916, 2,644,242 AND 2,665,088.

NO CLAIM IS MADE TO THE EXCLUSIVE RIGHT TO USE "ANIMATION", APART FROM THE MARK AS SHOWN.

THE MARK CONSISTS OF A BOY FISHING IN THE MOON ABOVE THE WORDS "DREAMWORKS ANIMATION SKG".

INT. CL. 9/U.S. CLS. 21, 23, 26, 36 AND 38

FOR COMPUTER GAME CARTRIDGES, VIDEO GAME CARTRIDGES, COMPUTER GAME DISCS AND VIDEO GAME DISCS; COMPUTER GAME PROGRAMS.

FIRST USE 4-1-2005; IN COMMERCE 4-1-2005.

INT. CL. 16/U.S. CLS. 2, 5, 22, 23, 29, 37, 38 AND 50

FOR CHILDREN'S ACTIVITY BOOKS, CHILDREN'S STORYBOOKS, COLORING BOOKS, CALENDARS, STICKER ALBUMS, STICKERS, TRADING CARDS, PAINTING SETS FOR CHILDREN; AND ACTIVITY KITS CONSISTING OF STICKERS AND RUBBER STAMPS.

FIRST USE 4-1-2005; IN COMMERCE 4-1-2005.

INT. CL. 25/U.S. CLS. 22 AND 39

FOR SHIRTS AND TOPS, PANTS, TROUSERS, JEANS, SHORTS, ROMPERS, OVERALLS, SWEATSHIRTS AND SWEAT PANTS, SWEATSUITS, CAPS AND HATS, TIES, HOSIERY, SHOES, BOOTS, SLIPPERS, PAJAMAS, SLEEPSHIRTS, SLEEPWEAR, UNDERWEAR, HALLOWEEN COSTUMES, AND CLOTH BABY BIBS.

FIRST USE 4-1-2005; IN COMMERCE 4-1-2005.

INT. CL. 28/U.S. CLS. 22, 23, 38 AND 50

FOR ACTION FIGURES AND ACCESSORIES THEREFOR, KITES, BOARD GAMES, HAND-HELD UNIT FOR PLAYING ELECTRONIC GAMES, DIE CAST MINIATURE TOY VEHICLES, DOLLS, DOLL ACCESSORIES, BEAN BAG DOLLS, FLYING DISCS, JIGSAW PUZZLES, PLUSH TOYS, STUFFED TOYS, TOY VEHICLES.

FIRST USE 4-1-2005; IN COMMERCE 4-1-2005.

INT. CL. 41/U.S. CLS. 100, 101 AND 107

FOR ENTERTAINMENT SERVICES, NAMELY, THE PRODUCTION AND DISTRIBUTION OF ANIMATED MOTION PICTURES AND ANIMATED TELEVISION PROGRAMS.

FIRST USE 4-30-2007; IN COMMERCE 4-30-2007.

ELEMENTS CORRECTED
MARK

3,508,653. REG. 9-30-2008. AURIC TECHNOLOGIES LIMITED (NEW ZEALAND CORPORATION) 75 WEST TAMAKI ROAD, GLEN INNES, AUCKLAND, NEW ZEALAND., SN 78-584,957. FILED 3-10-2005. PRINCIPAL REGISTER.

EMIW

THE MARK CONSISTS OF STANDARD CHARACTERS WITHOUT CLAIM TO ANY PARTICULAR FONT, STYLE, SIZE, OR COLOR.

PRIORITY CLAIMED UNDER SEC. 44(D) ON NEW ZEALAND APPLICATION NO. 718331, FILED 9-10-2004, REG. NO. 718331, DATED 9-10-2004. INT. CL. 6/U.S. CLS. 2, 12, 13, 14, 23, 25 AND 50

FOR [COMMON METALS AND THEIR ALLOYS,] * GALVANIZED METAL PRODUCTS, * NAMELY, * GALVANIZED * WIRE, * GALVANIZED * SHEET METAL, * GALVANIZED * PIPES, * GALVANIZED * TUBES AND * GALVANIZED * CASINGS; [NON-ELECTRICAL CABLES AND WIRES OF COMMON METAL; SMALL ITEMS OF METAL HARDWARE, NAMELY, NUTS, BOLTS, NAILS AND WASHERS].

FIRST USE ; IN COMMERCE .
INT. CL. 9/U.S. CLS. 21, 23, 26, 36 AND 38

FOR ELECTRICAL APPARATUS, NAMELY, GALVANIZING MACHINES; ELECTRICAL, ELECTRONIC AND ELECTROMAGNETIC APPARATUS, INSTRUMENTS AND COMPONENTS, NAMELY, * ELECTRICAL, ELECTRONIC AND ELECTROMAGNETIC * GALVANIZING MACHINES FOR THE TRANSFORMATION, CONVERSION, TRANSMISSION, DISTRIBUTION, CONTROL AND UTILIZATION OF ELECTRO-MAGNETIC ENERGY; GALVANIZING APPARATUS, NAMELY, MACHINES FOR GALVANIZING WIRE, SHEET METAL, PIPES, TUBES AND CASINGS; COMPONENTS, PARTS AND FITTINGS FOR THE AFOREMENTIONED GOODS.

FIRST USE ; IN COMMERCE .
INT. CL. 40/U.S. CLS. 100, 103 AND 106

FOR [TREATMENT] * GALVANIZING TREATMENTS * OF METALS, NAMELY, WIRE, PIPES, TUBE, PLATE AND SHEET METALS; METAL PLATING TREATMENTS; GALVANIZING TREATMENTS; METAL LAMINATING SERVICES; SURFACE COATING OF METALS. FIRST USE ; IN COMMERCE .

ELEMENTS AMENDED
GOODS/SERVICES

3,509,743. REG. 9-30-2008. SOCIÉTÉ DES PRODUITS NESTLÉ S.A. (SWITZERLAND SOCIÉTÉ ANONYME (SA)) INTELLECTUAL PROPERTY DEPARTMENT, CASE POSTALE 353, VEVEY, SWITZERLAND, 1800, SN 77-277,984. FILED 9-12-2007. PRINCIPAL REGISTER.

SNACKIN SLICES

THE MARK CONSISTS OF STANDARD CHARACTERS WITHOUT CLAIM TO ANY PARTICULAR FONT, STYLE, SIZE, OR COLOR.

NO CLAIM IS MADE TO THE EXCLUSIVE RIGHT TO USE "SLICES", APART FROM THE MARK AS SHOWN.

INT. CL. 31/U.S. CLS. 1 AND 46
FOR PET FOOD .
FIRST USE 7-1-2008; IN COMMERCE 7-1-2008.

ELEMENTS CORRECTED
MARK

* * * * *

TRADEMARK REGISTRATIONS—NEW CERTIFICATES

New Certificates issued under section 7(d) of the Trademark Act of 1946 for the unexpired term of the original registrations.

3,167,894. CODE 6 AND DESIGN. INT. CL. 41. FIGLIU-
LO, JOSEPH A, MANHASSET, NY. NADEAU, JOHN J,
MASPETH, NY. ALTHAUS, GEORGE, FLUSHING, NY. REG. 11-7-2006. NEW CERT. SEC. 7(D) TO REGISTRANT.

* * * * *

INDEX OF REGISTRANTS

JANUARY 27, 2009

(Registered; Renewed; Canceled; Amended, Corrected, etc.; New Certificates; 12c Publications.)

The designation "U.S. Cl." appearing in this section refers to the U.S. class in effect prior to Sep. 1, 1973 rather than the international class which applies to applications filed on or after that date. For adoption of international classification see notice in the OFFICIAL GAZETTE of Jun. 26, 1973 (911 O.G. TM 210).

/PHIL MUSUMECI AND BARNEY LANGNER, JR., SANTA CRUZ, CA:
3,567,175, PUB. 11-11-2008. INT. CL. 25.

"I. XARMANI-X. XRISTOULAKIS O.E"; CRETA LAND OF PLENTY, GREECE:
3,567,819, PUB. 11-11-2008. INT. CL. 3.

ÇAK TEXTILE B.V., NETHERLANDS:
3,567,847, PUB. 11-11-2008. MULTIPLE CLASS, INT. CLS. 9, 14, 18 AND 25.

A & D CREATIVE BOUTIQUE, INC., MIAMI, FL:
3,567,352, PUB. 11-11-2008. MULTIPLE CLASS, INT. CLS. 35 AND 42.

A & E GROUP, LLC, ST. CHARLES, MO:
2,548,357, CANC. INT. CL. 25.

A & H SPORTSWEAR CO., INC., STOCKERTOWN, PA:
3,567,998, INT. CL. 25.

A & M CONSULTING SERVICES, INC., CHULUOTA, FL, DBA SOX IN A BOX:
3,566,936, PUB. 11-11-2008. INT. CL. 25.

A. LEECHMAN HEATING & COOLING, INC., DES MOINES, IA:
3,568,130, INT. CL. 37.

A. SCHWEIZER GMBH OPTISCHE FABRIK, 91301 FORCHHEIM, FED REP GERMANY:
2,668,046, CANC. MULTIPLE CLASS, INT. CLS. 16, 35 AND 41.

A.C. NIELSEN COMPANY, SCHAUMBURG, IL:
2,547,482, CANC. INT. CL. 42.

A.C.S. USA, LLC, BROWNSTOWN, MI:
3,568,793, INT. CL. 16.

A.M. COMMUNICATIONS SPECIALISTS, INC., BOCA RATON, FL:
2,288,601, REN. 12-20-08. INT. CL. 42.

A.N. DERINGER, INC., ST. ALBANS, VT:
2,546,278, CANC. INT. CL. 35.

A.T. CROSS LIMITED, BALLINASLOE, COUNTY GALWAY, IRELAND:
2,548,538, CANC. MULTIPLE CLASS, INT. CLS. 9 AND 16.

A&E TELEVISION NETWORKS, NEW YORK, NY:
2,177,795, REN. 12-23-08. INT. CL. 16.
2,177,795, CANC. INT. CL. 41.
2,179,867, REN. 12-23-08. INT. CL. 16.
2,179,867, CANC. INT. CL. 41.
2,545,566, CANC. INT. CL. 16.
3,566,640, PUB. 11-11-2008. MULTIPLE CLASS, INT. CLS. 35 AND 41.

A&R PARTNERS INC., SAN MATEO, CA:
2,547,383, CANC. INT. CL. 35.

A&S CAPITAL ADVISORS, INC., RICHMOND, VA:
2,548,499, CANC. INT. CL. 36.

A/OGEO PRODUCTS, INC., GREER, SC:
2,144,070, CANC. INT. CL. 35.

AAÖ NORDIC AB, SE-112 23 STOCKHOLM, SWEDEN:
3,567,831, PUB. 11-11-2008. MULTIPLE CLASS, INT. CLS. 3, 16, 18 AND 28.

AAF-MCQUAY INC., LOUISVILLE, KY:
2,547,964, CANC. INT. CL. 11.
3,568,098, INT. CL. 11.

AB HÄLLDE MASKINER, KISTA, SWEDEN:
3,567,958, PUB. 11-11-2008. INT. CL. 7.

AB HOLDINGS, LLC, BOISE, ID:
2,209,503, REN. 12-22-08. INT. CL. 1.

AB&C GROUP, INC., MCLEAN, VA:
2,548,117, CANC. INT. CL. 35.

ABBOTT CARDIOVASCULAR SYSTEMS, INC., SANTA CLARA, CA:
2,547,713, CANC. INT. CL. 10.

ABBOTT DIABETES CARE INC., ABBOTT PARK, IL:
2,545,754, CANC. INT. CL. 10.

ABBOTT LABORATORIES, ABBOTT PARK, IL:
3,568,485, INT. CL. 42.

ABIFF MANUFACTURING CORPORATION, DENVER, CO:
2,547,695, CANC. INT. CL. 7.

ABNB FEDERAL CREDIT UNION, CHESAPEAKE, VA:
3,567,768, PUB. 11-11-2008. INT. CL. 36.

ABROL, INC., METUCHEN, NJ:
3,567,738, PUB. 12-5-2006. INT. CL. 35.

ABS PUMPS, INC., MERIDEN, CT:
2,143,840, CANC. INT. CL. 7.

ABSTRACT ENTERTAINMENT INC., SYOSSET, NY:
3,567,075, PUB. 11-11-2008. INT. CL. 41.

ACCESS TECHNOLOGIES GROUP, INC., NORWALK, CT:
2,546,932, CANC. MULTIPLE CLASS, INT. CLS. 9 AND 41.

ACCESSORY NETWORK GROUP, INC., NEW YORK, NY:
2,548,414, CANC. INT. CL. 9.

ACCO BRANDS CORPORATION, LINCOLNSHIRE, IL:
2,547,689, CANC. INT. CL. 3.
3,566,915, PUB. 11-11-2008. INT. CL. 16.
3,566,916, PUB. 11-11-2008. INT. CL. 16.

ACCOUNTING FIRMS ASSOCIATED, INC., GAINESVILLE, FL:
2,170,564, REN. 12-22-08. INT. CL. 36.

ACCULASER TECHNOLOGIES, INC., SWANSEA, MA:
2,545,790, CANC. INT. CL. 40.

ACCURATE CODING INC., PALM HARBOR, FL:
2,546,720, CANC. INT. CL. 35.

ACCUSERVE VENTURES, INC., GRANDVILLE, MI:
2,548,588, CANC. MULTIPLE CLASS, INT. CLS. 40 AND 42.

ACE MOTORCYCLE CORPORATION, NEW YORK, NY:
2,547,479, CANC. INT. CL. 12.

ACECAPE, INC., PARAMUS, NJ:
3,566,611, PUB. 11-11-2008. INT. CL. 38.
3,566,612, PUB. 11-11-2008. INT. CL. 38.

ACHOLI BEADS LLC, JAMUL, CA, DBA ACHOLI BEADS:
3,568,767, INT. CL. 14.

ACM ADVANCED CURRENCY MARKETS SA, CH-1204 GENÈVE, SWITZERLAND:
3,567,908, PUB. 11-11-2008. INT. CL. 36.

ACROHELIPRO GLOBAL SERVICES, INC., RICHMOND, BRITISH COLUMBIA, CANADA:
2,547,212, CANC. INT. CL. 35.
2,547,213, CANC. INT. CL. 37.

ACTARIS SAS, FRANCE:
3,567,848, PUB. 11-11-2008. MULTIPLE CLASS, INT. CLS. 9, 35 AND 38.

ACTIFI, INC., PLYMOUTH, MN:
3,567,083, PUB. 11-11-2008. INT. CL. 42.

ACTION CANDY COMPANY LTD, CONCORD, ONTARIO, CANADA:
3,568,283, MULTIPLE CLASS, INT. CLS. 5 AND 30.

- ACTIVE ANKLE SYSTEMS, INC., JEFFERSONVILLE, IN:
3,568,401, INT. CL. 28.
3,568,422, INT. CL. 28.
3,568,423, INT. CL. 28.
- ACTIVE MINERALS INTERNATIONAL, LLC, HUNT VALLEY, MD:
3,566,736, PUB. 11-11-2008. INT. CL. 1.
- ACUITY, DECATUR, GA:
2,547,309, CANC. MULTIPLE CLASS, INT. CLS. 35 AND 42.
- ACUSHNET COMPANY, FAIRHAVEN, MA:
2,154,329, REN. 12-20-08. INT. CL. 28.
3,568,120, MULTIPLE CLASS, INT. CLS. 18, 25 AND 28.
- ADAPTIVE NETWORK SOLUTIONS RESEARCH, INC., LOS ALAMOS, NM:
2,695,831, CANC. INT. CL. 41.
- ADHESIVE ENGINEERING & SUPPLY, INC., RAYMOND, NH:
3,568,648, INT. CL. 1.
- ADHESIVE TECHNOLOGIES, INC., HAMPTON, NH:
2,143,835, CANC. INT. CL. 7.
- ADIR INTERNATIONAL, LLC, LOS ANGELES, CA:
3,567,322, PUB. 11-11-2008. INT. CL. 35.
- ADMINISTRADORA DE MARCAS RD. S. DE R.L. DE C.V., C.P. 11320, MEXICO, D.F., MEXICO:
3,567,745, PUB. 11-11-2008. MULTIPLE CLASS, INT. CLS. 9, 16, 25, 35, 38 AND 41.
- ADMIRAL WINE & LIQUOR CO., CEDAR GROVE, NJ:
1,481,004, CANC. INT. CL. 33.
- ADN MEDIA, LLC., WILMINGTON, DE:
3,566,399, PUB. 11-11-2008. INT. CL. 42.
- ADORABLE ORIGINALS, INC., PHOENIX, AZ:
3,566,997, PUB. 11-11-2008. INT. CL. 28.
- ADP, INC., ROSELAND, NJ:
2,144,560, CANC. INT. CL. 9.
3,568,668, INT. CL. 42.
- ADT SERVICES AG, SCHAFFHAUSEN CH-8200, SWITZERLAND:
1,099,267, REN. 12-19-08. MULTIPLE CLASS, INT. CLS. 9 AND 14.
1,099,267, CANC. MULTIPLE CLASS, INT. CLS. 7 AND 20.
- ADTECH CAPITAL GROUP, INC., CITY OF INDUSTRY, CA:
3,568,447, MULTIPLE CLASS, INT. CLS. 6 AND 16.
- ADVANCE MAGAZINE PUBLISHERS INC., NEW YORK, NY:
2,145,540, CANC. INT. CL. 16.
2,547,142, CANC. INT. CL. 42.
3,568,035, INT. CL. 35.
- ADVANCED CIRCULATORY SYSTEMS, INC., EDEN PRAIRIE, MN:
3,568,280, INT. CL. 10.
- ADVANCED ENERGY INDUSTRIES, INC., FORT COLLINS, CO:
3,568,410, INT. CL. 9.
- ADVANCED INSTRUCTIONAL SYSTEMS, INC., RALEIGH, NC:
3,567,584, PUB. 11-11-2008. INT. CL. 42.
- ADVANCED MEDICAL OPTICS, INC. UNITED STATES:
3,567,805, PUB. 11-11-2008. INT. CL. 10.
- ADVANCED MICRO DEVICES, INC., SUNNYVALE, CA:
3,566,470, PUB. 11-11-2008. MULTIPLE CLASS, INT. CLS. 16 AND 41.
- ADVANCED PSYCHIATRY, P.A., CLEARWATER, FL:
3,567,024, PUB. 11-11-2008. MULTIPLE CLASS, INT. CLS. 41 AND 44.
- ADVANCED RESTORATION TECHNOLOGIES INC., PHOENIX, AZ, DBA HAIRGENESIS:
3,567,177, PUB. 11-11-2008. INT. CL. 5.
- ADVANCED SOFTWARE APPLICATIONS CORP., BRIDGEVILLE, PA:
3,568,236, INT. CL. 9.
- ADVANOUS, INC., GLEN ALLEN, VA:
2,546,637, CANC. INT. CL. 35.
- ADVERTISING SPECIALTY INSTITUTE INC., TREVOSE, PA:
2,545,649, CANC. INT. CL. 35.
2,548,078, CANC. MULTIPLE CLASS, INT. CLS. 9 AND 35.
- ADVOC LIMITED, EXETOR, ENGLAND:
3,566,605, PUB. 11-11-2008. MULTIPLE CLASS, INT. CLS. 35 AND 45.
3,566,607, PUB. 11-11-2008. MULTIPLE CLASS, INT. CLS. 35 AND 45.
- AEGIS ANALYTICAL CORPORATION, LAFAYETTE, CO:
2,546,831, CANC. MULTIPLE CLASS, INT. CLS. 9 AND 42.
- AEGON EQUITY GROUP, INC., LARGO, FL:
2,547,684, CANC. INT. CL. 36.
- AEGON USA, INC., BALTIMORE, MD:
2,547,870, CANC. INT. CL. 36.
- AERO COMPOSITES INC., DOYLESTOWN, PA:
2,547,830, CANC. INT. CL. 12.
- AERO PRODUCTS INTERNATIONAL, INC., SCHAUMBURG, IL:
3,568,585, MULTIPLE CLASS, INT. CLS. 20 AND 28.
- AEROGROW INTERNATIONAL, INC., BOULDER, CO:
3,568,085, INT. CL. 28.
3,568,213, INT. CL. 11.
- AESCHLIMANN, BILL, HURLEY, SD:
2,546,786, CANC. INT. CL. 29.
- AESTHETICOM, INC., NEW YORK, NY:
2,546,145, CANC. MULTIPLE CLASS, INT. CLS. 35 AND 41.
- AETERNA ZENTARIS, INC., QUEBEC, QUEBEC:
2,144,159, CANC. INT. CL. 5.
- AFEC PUMPS EUROPE B.V., NETHERLANDS:
3,567,930, PUB. 11-11-2008. INT. CL. 35.
- AFFINION PUBLISHING, INC., LAS VEGAS, NV:
2,548,201, CANC. MULTIPLE CLASS, INT. CLS. 16 AND 35.
- AFTON SCIENTIFIC CORPORATION, CHARLOTTESVILLE, VA:
3,566,660, PUB. 11-11-2008. MULTIPLE CLASS, INT. CLS. 20, 40 AND 42.
- AFX, INC., FREMONT, CA:
2,548,340, CANC. INT. CL. 10.
- AGAMATRIX, INC., SALEM, NH:
3,568,687, INT. CL. 9.
- AGAPE COUNTRY MINISTRIES, INC., PHOENIX, AZ:
2,548,412, CANC. INT. CL. 28.
- AGAVE ENVIRONMENTAL CONTRACTING, INC., GLENDALE, AZ:
3,566,823, PUB. 11-11-2008. INT. CL. 44.
- AGILIS GROUP INC., SAN DIEGO, CA:
3,568,221, INT. CL. 18.
- AGNES SCOTT COLLEGE, INC., DECATUR, GA:
2,661,529, CANC. MULTIPLE CLASS, INT. CLS. 9, 16 AND 28.
- AGRI LABORATORIES, LTD., ST. JOSEPH, MO:
2,260,710, REN. 12-23-08. INT. CL. 5.
- AGRIUM ADVANCED TECHNOLOGIES (U.S.) INC., SYLCAUGA, AL:
3,568,605, INT. CL. 41.
- AGUIAR, JOSE V., MIAMI, FL:
1,480,432, CANC. INT. CL. 5.
- AHMED, LESLIE, NEW YORK, NY:
2,547,421, CANC. INT. CL. 42.
- AID THROUGH TRADE, INC., ANNAPOLIS, MD:
3,566,301, PUB. 11-11-2008. INT. CL. 14.
- AIGLE INTERNATIONAL S.A., BOULOGNE-BILLANCOURT, FRANCE:
2,545,569, CANC. INT. CL. 14.
- AIR-CURE DYNAMICS, INC., STRONGSVILLE, OH, DBA CEILCOTE AIR POLLUTION CONTROL:
3,566,657, PUB. 11-11-2008. INT. CL. 11.
- AIR-EZE LTD., WEST SUSSEX, UNITED KINGDOM:
3,566,506, PUB. 11-11-2008. INT. CL. 7.
- AIRBORNE ENTERTAINMENT INC., MONTREAL, QUEBEC:
2,546,321, CANC. INT. CL. 41.

AIRCRAFT OWNERS AND PILOTS ASSOCIATION, FREDERICK, MD:
3,567,667, PUB. 11-11-2008. MULTIPLE CLASS, INT. CLS. 9 AND 16.
3,567,668, PUB. 11-11-2008. MULTIPLE CLASS, INT. CLS. 9 AND 16.
3,567,673, PUB. 11-11-2008. INT. CL. 9.

AIRE SERV HEATING & AIR CONDITIONING, INC., WACO, TX:
2,546,285, CANC. INT. CL. 37.

AIRSHOW, INC., TUSTIN, CA:
2,548,301, CANC. INT. CL. 38.

AIRTIME GEAR, LLC, BEAVERTON, OR:
3,568,217, INT. CL. 25.
3,568,218, INT. CL. 25.
3,568,219, INT. CL. 25.

AIRWAY MACHINE COMPANY, INC., IDAHO FALLS, ID:
3,567,108, PUB. 11-11-2008. INT. CL. 6.

AITKEN PRODUCTS, INC., GENEVA, OH:
850,915, REN. 12-23-08. U.S. CL. 21 (INT. CLS. 9 AND 11).

AK, TUNC, LOS ANGELES, CA:
3,568,604, INT. CL. 9.

AL DUCA D'AOSTA S.P.A., 30124 VENEZIA, ITALY:
2,545,631, CANC. INT. CL. 25.

ALABAMA EDUCATIONAL TELEVISION FOUNDATION AUTHORITY, BIRMINGHAM, AL, DBA ALABAMA PUBLIC TELEVISION:
1,481,075, CANC. INT. CL. 38.

ALAN GIBBY PRODUCTIONS, INC., DANA POINT, CA, DBA DYNOCOMM SPORTS:
2,546,157, CANC. INT. CL. 35.

ALBANY INTERNATIONAL CORP., ALBANY, NY:
2,548,542, CANC. INT. CL. 7.

ALBANY LAW SCHOOL OF UNION UNIVERSITY, ALBANY, NY:
2,546,870, CANC. INT. CL. 41.

ALBERT, KIMBERLY R., GULFPORT, FL:
2,547,141, CANC. INT. CL. 14.

ALBERT, ROCHEL, NORTH MIAMI BEACH, FL:
3,568,740, INT. CL. 16.

ALBERTO-CULVER USA, INC., MELROSE PARK, IL:
2,548,299, CANC. INT. CL. 3.

ALBION LABORATORIES, INC., CLEARFIELD, UT:
1,480,405, CANC. INT. CL. 5.

ALCOA OF AUSTRALIA LIMITED, MELBOURNE, VICTORIA 3000, AUSTRALIA:
2,145,062, CANC. INT. CL. 9.

ALCON MANUFACTURING, LTD., FORT WORTH, TX:
1,480,427, CANC. INT. CL. 5.

ALCON RESEARCH, LTD., FORT WORTH, TX:
3,566,854, PUB. 11-11-2008. INT. CL. 16.

ALESSIO-WAY, JEANETTE, LA MESA, CA:
3,566,901, PUB. 11-11-2008. MULTIPLE CLASS, INT. CLS. 35 AND 41.

ALEXANDER BABBAGE, INC., ATLANTA, GA:
3,567,410, PUB. 11-11-2008. INT. CL. 35.

ALEXANDRIA REAL ESTATE EQUITIES, INC., PASADENA, CA:
3,568,139, MULTIPLE CLASS, INT. CLS. 36 AND 37.
3,568,180, MULTIPLE CLASS, INT. CLS. 35 AND 36.

ALFA METAIS INDUSTRIA E COMERCIO LTDA, CURITIBA PR 81270-200, BRAZIL:
1,480,743, CANC. INT. CL. 12.

ALFORD, DAVID RANDALL, LAFAYETTE, CO:
3,567,025, PUB. 11-11-2008. INT. CL. 42.

ALFRED CLOUTIER LTD., ST. EMILE, PROVINCE OF QUEBEC, CANADA:
2,545,743, CANC. INT. CL. 25.

ALGETA ASA, BLINDERN, OSLO, NORWAY:
3,567,992, INT. CL. 5.

ALIWALK INTERNATIONAL S.A., ZONA FRANCA FLORIDA, URUGUAY:
3,567,033, PUB. 11-11-2008. MULTIPLE CLASS, INT. CLS. 35 AND 43.

ALL SPORTS CONDITIONING, INC., VENICE, CA:
3,567,138, PUB. 11-11-2008. INT. CL. 28.

ALL WEATHER SAFETY WHISTLE CO., ST. LOUIS, MO:
2,217,766, REN. 12-22-08. INT. CL. 9.

ALLBUSINESS.COM, INC., SAN FRANCISCO, CA:
2,546,226, CANC. INT. CL. 42.

ALLEN, KATHY O., SANTA FE, NM:
2,547,530, CANC. INT. CL. 25.

ALLGOODE NATURAL FOOD & BEVERAGES, INC., SANTA BARBARA, CA:
2,546,991, CANC. INT. CL. 30.

ALLIANZ LIFE INSURANCE CO OF NORTH AMERICA, MINNEAPOLIS, MN:
1,391,849, CANC. INT. CL. 36.

ALLIANZ SE, FED REP GERMANY:
3,567,844, PUB. 11-11-2008. MULTIPLE CLASS, INT. CLS. 35 AND 36.

ALLIES IN HEALTHCARE PUBLISHING, LLC, ST. LOUIS, MO:
3,568,272, MULTIPLE CLASS, INT. CLS. 16 AND 44.

ALLSTATE FLORAL & CRAFT, INC., CERRITOS, CA:
3,567,179, PUB. 11-11-2008. INT. CL. 26.

ALLTEL COMMUNICATIONS, LLC, LITTLE ROCK, AR:
2,546,949, CANC. INT. CL. 38.

ALM PROPERTIES, INC., NEW YORK, NY, NLP IP COMPANY, WILMINGTON, DE:
2,269,174, REN. 12-19-08. INT. CL. 16.

ALMADA, ANTHONY, APTOS, CA:
2,547,210, CANC. INT. CL. 42.

ALPACA REGISTRY, INC., LINCOLN, NE:
3,566,885, PUB. 11-11-2008. U.S. CL. A.

ALPHA MEDIA GROUP, INC., NEW YORK, NY:
3,567,183, PUB. 11-11-2008. INT. CL. 41.
3,567,187, PUB. 11-11-2008. INT. CL. 41.

ALPHA REVIEW CORPORATION, NAPERVILLE, IL:
3,566,686, PUB. 11-11-2008. INT. CL. 35.

ALPHAGRAPHICS, INC., SALT LAKE CITY, UT:
3,568,288, INT. CL. 35.

ALTARATIONS, LLC, FAYETTEVILLE, NC:
2,547,852, CANC. INT. CL. 20.

ALTEC, INC., BROUSSARD, LA:
3,568,138, INT. CL. 9.

ALTRO LIMITED, UNITED KINGDOM:
3,567,837, PUB. 11-11-2008. INT. CL. 27.

ALUMINAL OBERFLACHENTECHIK GMBH, D-53842 TROISDORF SPICH, FED REP GERMANY:
2,545,807, CANC. INT. CL. 7.

ALVAREZ OLMEDO, ANGEL, INGLEWOOD, CA:
3,567,131, PUB. 11-11-2008. INT. CL. 41.

ALVARO DOMEQ, S.L., CADIZ, SPAIN:
3,567,221, PUB. 11-11-2008. INT. CL. 30.

AMAZON TECHNOLOGIES, INC., RENO, NV:
3,567,583, PUB. 11-11-2008. INT. CL. 41.
3,567,585, PUB. 11-11-2008. INT. CL. 41.
3,567,586, PUB. 11-11-2008. INT. CL. 41.
3,567,587, PUB. 11-11-2008. INT. CL. 41.
3,567,589, PUB. 11-11-2008. INT. CL. 41.
3,567,590, PUB. 11-11-2008. INT. CL. 41.

AMCOL INTERNATIONAL CORPORATION, HOFFMAN ESTATES, IL:
687,729, REN. 12-19-08. U.S. CL. 1 (INT. CL. 1).
880,269, REN. 12-19-08. U.S. CL. 1 (INT. CL. 1).
1,527,589, REN. 12-19-08. INT. CL. 1.

AMCOR INDUSTRIES, INC., LOS ANGELES, CA:
3,566,327, PUB. 11-11-2008. INT. CL. 12.

AMEGA LABELS LIMITED, OLDHAM, OLI 3RR, UNITED KINGDOM:
2,545,980, CANC. INT. CL. 16.

AMERICA'S BEST, INC., WEST DES MOINES, IA:
2,215,663, REN. 12-22-08. INT. CL. 25.

AMERICAN ACADEMY OF ORTHOPAEDIC SURGEONS, ROSEMONT, IL:
3,568,053, MULTIPLE CLASS, INT. CLS. 9, 16, 35 AND 41.

AMERICAN AIRLINES, INC., DFW AIRPORT, TX:
2,548,183, CANC. INT. CL. 35.

AMERICAN ALLIANCE FOR HEALTH, PHYSICAL EDUCATION, RECREATION AND DANCE, THE, RESTON, VA:
2,208,512, REN. 12-19-08. MULTIPLE CLASS, INT. CLS. 16 AND 41.

- AMERICAN ASSOCIATION OF MUSEUMS, WASHINGTON, DC:
2,546,413, CANC. INT. CL. 42.
- AMERICAN ASSOCIATION OF PHYSICIAN SPECIALISTS, INC., TAMPA, FL:
3,568,526, INT. CL. 42.
- AMERICAN AUTOMOBILE ASSOCIATION, INC., HEATHROW, FL:
3,567,712, PUB. 11-11-2008. INT. CL. 37.
- AMERICAN BALLROOM CO., CAROL GABLES, FL:
2,233,056, REN. 12-20-08. INT. CL. 41.
- AMERICAN BALLROOM COMPANY, INC., ROLLING HILLS ESTATES, CA:
1,531,342, REN. 12-20-08. INT. CL. 41.
- AMERICAN BOOKSELLERS ASSOCIATION, INC., TARRYTOWN, NY:
3,567,565, PUB. 11-11-2008. INT. CL. 25.
3,567,571, PUB. 11-11-2008. INT. CL. 16.
3,567,576, PUB. 11-11-2008. INT. CL. 35.
3,567,598, PUB. 11-11-2008. INT. CL. 35.
- AMERICAN CANCER SOCIETY, ATLANTA, GA:
2,547,260, CANC. INT. CL. 36.
- AMERICAN CANCER SOCIETY, INC., ATLANTA, GA:
3,566,457, PUB. 11-11-2008. INT. CL. 35.
3,566,458, PUB. 11-11-2008. INT. CL. 35.
- AMERICAN CAPITAL EXCHANGE, INC., ORLANDO, FL:
2,548,595, CANC. INT. CL. 36.
- AMERICAN CAPITAL, LTD., BETHESDA, MD:
2,545,716, CANC. INT. CL. 36.
- AMERICAN COFFEE COMPANY, INC., NEW ORLEANS, LA:
2,546,579, CANC. INT. CL. 30.
- AMERICAN DAIRY QUEEN CORPORATION, EDINA, MN:
1,481,199, CANC. INT. CL. 30.
- AMERICAN ELECTRIC POWER COMPANY, INC., COLUMBUS, OH:
2,215,802, REN. 12-20-08. INT. CL. 39.
- AMERICAN FAMILY FOUNDATION, INC., BIRMINGHAM, AL:
2,244,046, REN. 12-22-08. INT. CL. 36.
- AMERICAN FARM BUREAU FEDERATION, WASHINGTON, DC:
3,567,994, INT. CL. 35.
- AMERICAN FIDELITY ASSURANCE COMPANY, OKLAHOMA CITY, OK:
2,196,970, REN. 12-20-08. INT. CL. 36.
- AMERICAN GIRL, LLC, EL SEGUNDO, CA:
3,568,412, INT. CL. 43.
- AMERICAN HANDLING SYSTEMS, INC., LAURENS, IA, DBA POSITECH CORPORATION:
3,566,599, PUB. 11-11-2008. INT. CL. 7.
3,566,601, PUB. 11-11-2008. INT. CL. 7.
3,566,608, PUB. 11-11-2008. INT. CL. 7.
3,566,613, PUB. 11-11-2008. INT. CL. 40.
- AMERICAN HEARING SYSTEMS INC., BLOOMINGTON, MN, DBA INTERTON INC.:
3,568,260, INT. CL. 10.
- AMERICAN HOSPITAL ASSOCIATION, CHICAGO, IL:
2,546,944, CANC. INT. CL. 35.
- AMERICAN IMPRESSIONS, LLC, STRATFORD, CT:
2,548,351, CANC. INT. CL. 3.
- AMERICAN INSURANCE MARKETING AND SALES SOCIETY, RICHMOND, VA:
1,514,164, REN. 12-22-08. U.S. CL. 200.
- AMERICAN INTERNATIONAL GROUP, INC., NEW YORK, NY:
3,568,553, INT. CL. 36.
- AMERICAN INVESTMENT BANK, N.A., SALT LAKE CITY, UT:
2,546,412, CANC. INT. CL. 36.
- AMERICAN INVESTMENT FINANCIAL, MIDVALE, UT:
2,546,415, CANC. INT. CL. 36.
- AMERICAN MACHINE TOOL DISTRIBUTORS' ASSOCIATION, ROCKVILLE, MD:
2,548,625, CANC. INT. CL. 35.
- AMERICAN MIDWIFERY CERTIFICATION BOARD, LINTHICUM, MD:
3,567,752, PUB. 11-11-2008. MULTIPLE CLASS, INT. CLS. 16, 35 AND 41.
- AMERICAN MOMENTUM BANK, TAMPA, FL:
3,566,391, PUB. 11-11-2008. INT. CL. 36.
3,566,392, PUB. 11-11-2008. INT. CL. 36.
- AMERICAN MOVING & STORAGE CO., INC., MONTEBELLO, CA:
2,546,802, CANC. INT. CL. 39.
- AMERICAN NATIONAL INSURANCE COMPANY, GALVESTON, TX:
2,203,881, REN. 12-22-08. INT. CL. 36.
- AMERICAN NATURE PHARMACEUTICAL, INC., IRVINE, CA:
2,548,174, CANC. INT. CL. 5.
- AMERICAN OF MARTINSVILLE, INC., MARTINSVILLE, VA:
3,568,507, MULTIPLE CLASS, INT. CLS. 20 AND 35.
3,568,508, INT. CL. 35.
- AMERICAN PIN & FASTENER CORPORATION, TEMPE, AZ:
2,144,491, CANC. INT. CL. 8.
- AMERICAN PRIDE, INC., RALEIGH, NC:
1,516,680, REN. 12-19-08. INT. CL. 37.
- AMERICAN PRODUCTIVITY & QUALITY CENTER, HOUSTON, TX:
2,546,401, CANC. INT. CL. 35.
- AMERICAN PROPERTY MANAGEMENT CORPORATION, SAN DIEGO, CA:
3,568,306, INT. CL. 43.
- AMERICAN PSYCHOLOGICAL ASSOCIATION, WASHINGTON, DC:
3,566,280, PUB. 11-11-2008. INT. CL. 16.
3,566,302, PUB. 11-11-2008. INT. CL. 16.
- AMERICAN SADDLEBRED REGISTRY, INC., LEXINGTON, KY:
3,567,475, PUB. 11-11-2008. INT. CL. 35.
- AMERICAN SATELLITE & ENTERTAINMENT, INC., CONCORD, NH:
2,548,122, CANC. INT. CL. 35.
- AMERICAN SECURITY SYSTEMS, INC., LONG ISLAND CITY, NY:
3,566,395, PUB. 12-4-2007. INT. CL. 45.
- AMERICAN SOCCER COMPANY, INC., WILMINGTON, CA:
3,568,449, INT. CL. 25.
- AMERICAN SOCIETY FOR BARIATRIC SURGERY, GAINESVILLE, FL:
3,568,045, INT. CL. 42.
- AMERICAN SOCIETY FOR THE PREVENTION OF CRUELTY TO ANIMALS, THE, NEW YORK, NY:
3,567,753, PUB. 11-11-2008. MULTIPLE CLASS, INT. CLS. 41 AND 45.
- AMERICAN SPORTS LICENSING, INC., WILMINGTON, DE:
3,568,471, INT. CL. 28.
- AMERICAN TOOL COMPANIES, INC., HOFFMAN ESTATES, IL:
2,545,892, CANC. INT. CL. 8.
- AMERICAN TRANS AIR, INC., INDIANAPOLIS, IN:
2,144,529, CANC. INT. CL. 39.
- AMERIVINE, INC., SANTA ROSA, CA:
3,567,488, PUB. 11-11-2008. INT. CL. 33.
- AMICAS, INC., NEWTON, MA:
2,546,312, CANC. INT. CL. 9.
- AMID, JANET, TOLEDO, OH:
2,144,371, CANC. INT. CL. 42.
- AMKOR ELECTRONICS, INC., WEST CHESTER, PA TO AMKOR ELECTRONICS, INC., WEST CHESTER, PA:
2,145,506, CANC. INT. CL. 9.
- AMLIN PLC, UNITED KINGDOM:
3,567,799, PUB. 11-11-2008. INT. CL. 36.
- AMM INDUSTRIES, INC., FORT LAUDERDALE, FL, DBA JORGEN & WINNERS CLUB:
2,547,348, CANC. INT. CL. 3.
- AMN HEALTHCARE, INC., SAN DIEGO, CA:
3,567,030, PUB. 11-11-2008. INT. CL. 35.
- AMOREPACIFIC CORPORATION, SEOUL, REPUBLIC OF KOREA:
3,568,199, INT. CL. 3.

AMPAC PACKAGING LLC, CINCINNATI, OH:
2,296,096, REN. 12-19-08. INT. CL. 16.

AMPC ACQUISITION, INC., ROCKFORD, IL:
3,567,303, PUB. 11-11-2008. INT. CL. 35.

AMPEREX TECHNOLOGY LIMITED CORPORATION,
TSUEN WAN, N.T., HONG KONG:
3,566,354, PUB. 11-11-2008. INT. CL. 9.

AMR TRAINING GROUP, INC., DFW AIRPORT, TX:
2,546,442, CANC. INT. CL. 35.

AMSTAR SURFACE TECHNOLOGY, LTD., HOUSTON, TX:
3,566,975, PUB. 11-11-2008. INT. CL. 40.
3,566,976, PUB. 11-11-2008. INT. CL. 40.
3,566,977, PUB. 11-11-2008. INT. CL. 6.
3,566,978, PUB. 11-11-2008. INT. CL. 1.

AMTRUST BANK, CLEVELAND, OH:
3,567,757, PUB. 11-11-2008. INT. CL. 36.

AMUROL CONFECTIONS COMPANY, YORKVILLE, IL:
2,546,509, CANC. INT. CL. 30.

AMY LAMPERTI, MORRIS PLAINS, NJ, DBA THE PLAY-
GROUND GUIDE:
3,566,732, PUB. 11-11-2008. INT. CL. 16.

ANALYSTS, INC., TORRANCE, CA:
2,233,209, REN. 12-20-08. INT. CL. 9.
2,246,946, REN. 12-20-08. INT. CL. 9.
2,248,502, REN. 12-20-08. INT. CL. 9.

ANANDA ACADEMY OF CLASSICAL BALLET AND CON-
TEMPORARY DANCE, THE, BOULDER, CO:
2,548,510, CANC. INT. CL. 41.

ANCO-TECH INC., DEARBORN HEIGHTS, MI:
2,547,378, CANC. INT. CL. 6.

ANCRA INTERNATIONAL, LLC., HAWTHORNE, CA:
3,567,709, PUB. 11-11-2008. INT. CL. 8.
3,567,710, PUB. 11-11-2008. INT. CL. 8.

ANDERSEN MANUFACTURING, INC., IDAHO FALLS, ID:
3,568,143, INT. CL. 12.

ANDERSEN STERILIZERS, INC., HAW RIVER, NC:
3,568,613, INT. CL. 10.

ANDERSEN, KENNETH W., SAN DIEGO, CA:
3,568,145, INT. CL. 7.

ANDRADE & ASSOCIATES, IRVINE, CA:
2,546,948, CANC. INT. CL. 42.

ANDREA OBSTON MARKETING COMMUNICATIONS,
LLC, BLOOMFIELD, CT:
3,568,070, INT. CL. 35.

ANDRITZ INC., ALPHARETTA, GA:
2,546,653, CANC. INT. CL. 11.

ANELVA CORPORATION, TOKYO 183, JAPAN:
2,545,503, CANC. INT. CL. 7.

ANGEL THERAPY, INC., LAGUNA BEACH, CA:
3,567,133, PUB. 11-11-2008. U.S. CL. B.

ANGELL BRIDGE INCORPORATED, PAWTUCKET, RI:
3,568,346, INT. CL. 18.

ANHEUSER-BUSCH, INCORPORATED, ST. LOUIS, MO:
2,144,983, CANC. INT. CL. 21.
2,547,394, CANC. INT. CL. 32.

ANIXTER INC., GLENVIEW, IL:
2,546,739, CANC. MULTIPLE CLASS, INT. CLS. 35 AND
42.

ANJI LIANFENG FURNITURE CO., LTD., CHINA:
3,567,984, PUB. 11-11-2008. INT. CL. 20.

ANORANZAS NITE CLUB, INC., JACKSON HEIGHTS, NY:
2,144,585, CANC. INT. CL. 42.

ANSON & HIGGINS PLASTIC SURGERY ASSOCIATES,
LLP, LAS VEGAS, NV:
3,566,560, PUB. 4-1-2008. INT. CL. 44.

ANTIOCH PUBLISHING COMPANY, THE, YELLOW
SPRINGS, OH:
1,480,777, CANC. INT. CL. 16.

ANTIOCH UNIVERSITY, YELLOW SPRINGS, OH:
3,566,877, PUB. 11-11-2008. INT. CL. 41.
3,566,879, PUB. 11-11-2008. INT. CL. 41.
3,566,880, PUB. 11-11-2008. INT. CL. 41.
3,566,881, PUB. 11-11-2008. INT. CL. 41.

AOKANG GROUP CO., LTD., ZHEJIANG PROVINCE,
CHINA:
2,547,920, CANC. INT. CL. 25.

AOL LLC, DULLES, VA:
2,144,656, CANC. INT. CL. 42.

AOS THERMAL COMPOUNDS, LLC, EATONTOWN, NJ:
2,547,869, CANC. INT. CL. 4.

APHEREA, INC., BROOKLYN, NY:
3,566,769, PUB. 11-11-2008. MULTIPLE CLASS, INT. CLS.
20 AND 24.

APMSAFE.COM, INC., PASADENA, CA:
2,547,306, CANC. INT. CL. 9.

APOTHECURE, INC., DALLAS, TX:
2,546,688, CANC. INT. CL. 5.

APPLEBEE'S INTERNATIONAL, INC., OVERLAND PARK,
KS:
1,481,120, CANC. INT. CL. 42.

APPLIANCE REPAIR SOLUTIONS, LLC, CORYDON, IN:
3,567,201, PUB. 11-11-2008. INT. CL. 35.
3,567,723, PUB. 11-11-2008. INT. CL. 35.

APPLICA GMBH ANGEWANDTE; CHEMISCHE ANALY-
TIK, FED REP GERMANY:
3,567,875, PUB. 11-11-2008. MULTIPLE CLASS, INT. CLS.
41, 42 AND 44.

APPLICANT, AUDIO VISUAL IMAGINEERING, INC., THE,
ORLANDO, FL:
2,546,109, CANC. INT. CL. 9.

APPLIED AESTHETICS, INC., JUNO BEACH, FL, DBA
HAND-WROUGHT JEWELRY, INC.:
3,568,429, MULTIPLE CLASS, INT. CLS. 14 AND 35.

APPLIED CAREER TRAINING, INC., ARLINGTON, VA:
2,547,220, CANC. INT. CL. 41.

APPLIED RESEARCH & TECHNOLOGY, INC., TOWSON,
MD, DBA CYBERSYSTEM TECHNOLOGIES:
2,143,995, CANC. INT. CL. 35.

APR, LLC., SANTA ANA, CA:
2,546,860, CANC. INT. CL. 35.

APRONSTYLE.COM INC., WYCKOFF, NJ:
2,548,573, CANC. INT. CL. 35.

AQUA PARTNERS, LTD., BEAUMONT, TX:
2,546,481, CANC. INT. CL. 11.

AQUABIOTRONIC.COM, LLC, LOS ANGELES, CA:
2,546,168, CANC. INT. CL. 40.

AQUASEARCH, INC., KAILUA-KONA, HI:
2,548,290, CANC. INT. CL. 5.

AQUATRON INC., DELRAY BEACH, FL:
3,567,339, PUB. 11-11-2008. INT. CL. 7.

ARABESQUE S.R.L., ARCORE, ITALY:
3,566,655, PUB. 11-11-2008. MULTIPLE CLASS, INT. CLS.
9, 12 AND 25.

ARBOR VINEYARDS, INC., VICTOR, CA, DBA METTLER
FAMILY VINEYARDS:
3,566,450, PUB. 11-11-2008. INT. CL. 33.

ARBY'S IP HOLDER TRUST, ATLANTA, GA:
3,568,371, INT. CL. 43.

ARC CAPITAL PARTNERS, LTD., CLIFTON, NJ:
2,547,592, CANC. INT. CL. 36.

ARC LUXE LLC, CHARLOTTE, NC:
3,568,438, INT. CL. 20.

ARCHER-DANIELS-MIDLAND COMPANY, DECATUR, IL:
3,568,572, INT. CL. 1.

ARCHITECTURAL IMPORTS, LLC, DORAL, FL:
3,566,961, PUB. 11-11-2008. INT. CL. 40.

ARCOSOFT INC., RICHMOND HILL, CANADA:
3,567,503, PUB. 11-11-2008. INT. CL. 9.

ARENA PHARMACEUTICALS GMBH, CH-4800 ZOFIN-
GEN, SWITZERLAND:
3,567,065, PUB. 11-11-2008. INT. CL. 5.

ARES TRADING S.A., AUBONNE, SWITZERLAND:
3,566,755, PUB. 11-11-2008. INT. CL. 5.

ARGOSY GAMING COMPANY, ALTON, IL:
2,548,565, CANC. INT. CL. 41.

ARGUS SECURITY GROUP, INC., EAST HARTFORD, CT:
1,566,474, REN. 12-23-08. INT. CL. 42.

ARIES TECHNOLOGY, INC., LOWELL, MA:
1,480,541, CANC. INT. CL. 9.

ARISTOCRAT TECHNOLOGIES AUSTRALIA PTY LTD,
LANE COVE, NSW 2066, AUSTRALIA:
3,566,384, PUB. 9-2-2008. INT. CL. 9.

ARISTOCRAT TECHNOLOGIES AUSTRALIA PTY LTD,
LANE COVE, NSW, AUSTRALIA:
3,566,406, PUB. 9-2-2008. INT. CL. 9.

- ARIZONA BABIES, LLC, GILBERT, AZ:
2,546,880, CANC. INT. CL. 3.
- ARIZONA CARDINALS FOOTBALL CLUB, INC., PHOENIX, AZ:
2,143,804, CANC. INT. CL. 42.
- ARIZONA GRAND RESORT, LLC, PHOENIX, AZ:
3,566,894, PUB. 11-11-2008. MULTIPLE CLASS, INT. CLS. 41 AND 44.
- ARIZONA PRECISION SHEET METAL, INC., PHOENIX, AZ:
2,222,341, REN. 12-20-08. MULTIPLE CLASS, INT. CLS. 40 AND 42.
- ARJUN SEN INC., CENTENNIAL, CO, DBA RESTAURANT MARKETING GROUP:
3,567,099, PUB. 11-11-2008. INT. CL. 35.
- ARKOS CAPITAL S.A., SWITZERLAND:
3,567,836, PUB. 11-11-2008. INT. CL. 36.
- ARLA FOODS AMBA, VIBY J DK-8260, DENMARK, DOFO, A.M.B.A. (DANSKE OSTEMEJERIES FAELLESSALG OG OSTEEKSPORT), HADERSLEV, DENMARK:
864,323, REN. 12-24-08. U.S. CL. 46 (INT. CLS. 1, 5, 29, 30, 31 AND 32).
- ARLOTTA, ALEXANDRE, ORLANDO, FL:
3,567,082, PUB. 11-11-2008. INT. CL. 29.
- ARMAMENT SYSTEMS AND PROCEDURES, INC., APPLETON, WI:
2,548,393, CANC. INT. CL. 16.
- ARMBRUST INTERNATIONAL LTD., PROVIDENCE, RI, ARMBRUST CHAIN COMPANY, PROVIDENCE, RI:
671,079, REN. 12-19-08. U.S. CL. 13 (INT. CL. 6).
- ARMCHAIR SCIENTIST, THE, SAN DIEGO, CA:
2,548,082, CANC. INT. CL. 42.
- ARMOR A11/STP PRODUCTS COMPANY, THE, OAKLAND, CA:
2,547,699, CANC. INT. CL. 37.
- ARMS BUILDING & MAINTENANCE, INC., LONGVIEW, TX:
3,568,675, INT. CL. 27.
- ARROW EXTERMINATING CO. INC., LYNNBROOK, NY:
2,249,300, REN. 12-20-08. INT. CL. 37.
- ARROWHEAD BRASS PRODUCTS, LLC, LOS ANGELES, CA:
3,568,291, INT. CL. 11.
- ARTANGELS.ORG INC., SAN FRANCISCO, CA:
2,665,097, CANC. INT. CL. 36.
- ARTHUR LANSKY LEVINE & ASSOCIATES, INC., HENDERSON, NV, DBA LANSKY SHARPENERS:
3,567,388, PUB. 11-11-2008. INT. CL. 8.
3,567,412, PUB. 11-11-2008. INT. CL. 8.
3,567,415, PUB. 11-11-2008. INT. CL. 8.
3,567,418, PUB. 11-11-2008. INT. CL. 8.
- ARTHUR LANSKY LEVINE & ASSOCIATES, INC., HENDERSON, NV, DBA LANSKY SHARPENERS:
3,567,652, PUB. 11-11-2008. INT. CL. 8.
- ARTHUR N CAPLE FOUNDATION, INC., LEXINGTON, KY:
3,568,117, INT. CL. 36.
- ARZADON, ROBERT ANTHONY, KIRKLAND, WA:
2,547,350, CANC. INT. CL. 35.
- ASA ENTERPRISES, LLC, CINNAMINSON, NJ:
3,567,403, PUB. 11-11-2008. INT. CL. 20.
- ASAHI KASEI KURARAY MEDICAL CO., LTD., TOKYO, JAPAN:
3,566,442, PUB. 11-11-2008. INT. CL. 10.
- ASC MINERAL PROCESSING CO INC, ALLERTON, IL AND MINERAL PROCESSING CO, CAREY, OH:
3,567,473, PUB. 11-11-2008. INT. CL. 1.
- ASC MINERAL PROCESSING CO. INC., ALLERTON, IL AND MINERAL PROCESSING CO, CAREY, IL:
3,567,471, PUB. 11-11-2008. INT. CL. 1.
- ASC SEAFOOD, INC., LARGO, FL:
2,243,604, REN. 12-20-08. INT. CL. 29.
- ASD GLOBAL INC., SAN FRANCISCO, CA:
2,546,074, CANC. INT. CL. 35.
2,546,075, CANC. INT. CL. 35.
- ASD.COM, INC., MURFREESBORO, TN:
2,546,522, CANC. INT. CL. 35.
- ASH & BURN LLC, NASHUA, NH:
3,567,378, PUB. 11-11-2008. MULTIPLE CLASS, INT. CLS. 18 AND 34.
- ASHBY & ASSOCIATES, INC., ALEXANDRIA, VA:
2,547,429, CANC. MULTIPLE CLASS, INT. CLS. 35, 41 AND 42.
- ASHLAND OIL, INC., ASHLAND, KY:
1,480,493, CANC. MULTIPLE CLASS, INT. CLS. 8, 25 AND 34.
1,481,137, CANC. INT. CL. 42.
- ASHLEY FURNITURE INDUSTRIES, INC., ARCADIA, WI:
1,511,811, REN. 12-23-08. INT. CL. 20.
2,144,872, CANC. INT. CL. 20.
- ASI GLOBAL, L.L.C., HOUSTON, TX:
3,566,813, PUB. 11-11-2008. MULTIPLE CLASS, INT. CLS. 35, 41, 44 AND 45.
- ASIA FACTORY DIRECT, INC, MIAMI, FL:
3,568,079, INT. CL. 19.
- ASICS CORPORATION, KOBE 650-8555, JAPAN:
2,230,692, REN. 12-23-08. INT. CL. 25.
- ASOLO S.P.A., TREVISO, ITALY:
3,566,366, PUB. 4-15-2008. MULTIPLE CLASS, INT. CLS. 18 AND 25.
- ASPECT INTERNATIONAL LANGUAGE SCHOOLS II BV, 2514 AC THE HAGUE, NETHERLANDS:
2,547,526, CANC. MULTIPLE CLASS, INT. CLS. 39, 41 AND 42.
- ASPEN TECHNOLOGY, INC., CAMBRIDGE, MA:
2,547,961, CANC. INT. CL. 42.
- ASPEN VETERINARY RESOURCES, LTD, GREELEY, CO:
2,267,355, REN. 12-19-08. INT. CL. 5.
- ASPEN VETERINARY RESOURCES, LTD., GREELEY, CO:
2,274,165, REN. 12-19-08. INT. CL. 5.
- ASSEMBLED PRODUCTS CORPORATION, ROGERS, AR:
2,547,980, CANC. INT. CL. 12.
- ASSOCIATED NETWORK PARTNERS, INC., SPRINGFIELD, IL:
2,545,893, CANC. INT. CL. 38.
- ASSOCIATED NEWSPAPERS LIMITED, KENSINGTON, LONDON W8 5TT, ENGLAND:
2,657,519, CANC. MULTIPLE CLASS, INT. CLS. 9 AND 39.
- ASSOCIATES IN MEDICAL MARKETING CO., INC., NEWTOWN, PA:
2,546,988, CANC. INT. CL. 16.
- ASSOCIATION FOR SUPERVISION AND CURRICULUM DEVELOPMENT, ALEXANDRIA, VA:
2,210,349, REN. 12-23-08. MULTIPLE CLASS, INT. CLS. 9, 16, 35 AND 41.
2,210,349, CANC. INT. CL. 38.
- ASSOCIATION FOR THE ADVANCEMENT OF MEDICAL INSTRUMENTATION, ARLINGTON, VA:
2,206,497, REN. 12-22-08. MULTIPLE CLASS, INT. CLS. 16, 41 AND 42.
- ASSOCIATION OF INSURANCE AND REINSURANCE RUN-OFF COMPANIES, ALPHARETTA, GA, DBA AIRROC:
3,568,269, MULTIPLE CLASS, INT. CLS. 35 AND 41.
- ASSOCIATION OF PROFESSIONAL ANIMAL WASTE SPECIALISTES, INC., SANTA CLARITA, CA:
3,566,970, PUB. 11-11-2008. INT. CL. 35.
- ASSOCIATION SERVICES OF AMERICA, INC., CENTERVILLE, MA:
3,568,733, MULTIPLE CLASS, INT. CLS. 35 AND 45.
- ASSOCIATIONS FOR ESTABLISHMENT; OF EVIDENCE IN INTERVENTIONS, JAPAN:
3,567,982, PUB. 11-11-2008. INT. CL. 42.
- ASSURED EQUITIES, INC., BOISE, ID:
2,548,563, CANC. INT. CL. 36.
- ASTRAL PROPERTY PTY LIMITED, CHATSWOOD, AUSTRALIA:
3,566,898, PUB. 11-11-2008. INT. CL. 19.
- AT&T INTELLECTUAL PROPERTY II, L.P., RENO, NV:
2,144,994, CANC. MULTIPLE CLASS, INT. CLS. 38 AND 42.
2,547,589, CANC. MULTIPLE CLASS, INT. CLS. 35 AND

38.
2,548,277, CANC. INT. CL. 38.
2,548,278, CANC. INT. CL. 38.
2,548,350, CANC. INT. CL. 38.
- ATARI EUROPE SAS, 69252 LYON CEDEX 9, FRANCE:
2,545,851, CANC. MULTIPLE CLASS, INT. CLS. 9, 28
AND 38.
- ATHENS FOODS, INC., CLEVELAND, OH:
3,567,413, PUB. 11-11-2008. INT. CL. 30.
- ATHLETE'S FOOT BRANDS, LLC, KENNESAW, GA:
2,209,347, REN. 12-20-08. INT. CL. 25.
- ATHOME.NET, MOUNTAIN VIEW, CA:
2,545,510, CANC. INT. CL. 38.
- ATICO INTERNATIONAL USA INC., FORT LAUDERDALE,
FL:
2,548,242, CANC. MULTIPLE CLASS, INT. CLS. 4 AND
14.
- ATLANTA CONVENTION AND VISITORS BUREAU, INC.,
ATLANTA, GA:
2,546,599, CANC. INT. CL. 16.
- ATLANTIC RICHFIELD COMPANY, LOS ANGELES, CA:
1,480,961, CANC. INT. CL. 30.
- ATLAS SUPPLY COMPANY, SPRINGFIELD, NJ:
1,480,737, CANC. INT. CL. 12.
- ATLAST GROUP CIE, TORONTO ONTARIO, CANADA:
3,566,270, PUB. 11-11-2008. INT. CL. 35.
- ATOM ENTERTAINMENT, INC., SAN FRANCISCO, CA:
2,547,752, CANC. INT. CL. 9.
2,547,753, CANC. INT. CL. 9.
- ATRAVERDA LIMITED, UNITED KINGDOM:
3,567,802, PUB. 11-11-2008. MULTIPLE CLASS, INT. CLS.
1 AND 9.
- ATTAR, ALI MOVAHEDIAN, DUBAI, UNITED ARAB
EMIR.:
3,567,037, PUB. 11-11-2008. INT. CL. 36.
- ATWATER, BARBARA BRENT, SOUTHERN PINES, NC:
3,566,699, PUB. 11-11-2008. INT. CL. 16.
- ATWOOD MOBILE PRODUCTS, LLC, ELKHART, IN:
848,652, REN. 12-23-08. U.S. CL. 34 (INT. CL. 11).
- AUBURN UNIVERSITY, AUBURN, AL:
3,567,414, PUB. 11-11-2008. MULTIPLE CLASS, INT. CLS.
14 AND 25.
3,567,658, PUB. 11-11-2008. MULTIPLE CLASS, INT. CLS.
25, 30, 35 AND 41.
- AUER AGENCY LLC, CHARLOTTE, NC:
3,566,878, PUB. 11-11-2008. INT. CL. 35.
- AUGUST TOEPFER & CO. (GMBH & CO.), HAMBURG, FED
REP GERMANY:
2,546,470, CANC. INT. CL. 30.
- AURIC TECHNOLOGIES LIMITED, AUCKLAND, NEW
ZEALAND:
3,508,653, AM. MULTIPLE CLASS, INT. CLS. 6, 9 AND
40.
- AUSTRALIAN GOLD, INC., INDIANAPOLIS, IN:
2,273,959, REN. 12-20-08. INT. CL. 3.
2,548,440, CANC. INT. CL. 11.
- AUSTRALIAN VINTAGE LTD., PARKSIDE, AUSTRALIA:
3,566,505, PUB. 11-11-2008. INT. CL. 33.
- AUTEFA AUTOMATION GMBH, FED REP GERMANY:
3,567,820, PUB. 11-11-2008. MULTIPLE CLASS, INT. CLS.
6, 7 AND 42.
- AUTHORIZE.NET HOLDINGS, INC., MARLBOROUGH,
MA:
2,145,185, CANC. INT. CL. 42.
- AUTHOTECQ SYSTEMS, INC., SIGNAL HILL, CA:
3,568,082, INT. CL. 36.
- AUTO INSURANCE SPECIALISTS INCORPORATED, EL
SEGUNDO, CA:
2,545,655, CANC. INT. CL. 36.
- AUTOMATED CUSTOMER MANAGEMENT SERVICES,
INC., BEND, OR, DBA ACMS, INC.:
2,144,189, CANC. INT. CL. 9.
- AUTOTECH ACCESSORIES, INC., SANTA CLARITA, CA:
2,220,183, REN. 12-20-08. MULTIPLE CLASS, INT. CLS. 7,
11 AND 12.
- AUTOTOTE SYSTEMS, INC., NEWARK, DE:
2,145,435, CANC. INT. CL. 9.
- AUTOTRANS, INC., EDMONTON, ALBERTA, CANADA:
2,144,975, CANC. MULTIPLE CLASS, INT. CLS. 12 AND
37.
- AUTOTRONIC CONTROLS CORPORATION, EL PASO, TX:
2,547,548, CANC. INT. CL. 7.
- AUTOZONE, INC., MEMPHIS, TN:
3,567,993, INT. CL. 8.
- AVACORP, INC., NORCROSS, GA:
3,568,546, INT. CL. 35.
- AVAGO TECHNOLOGIES GENERAL IP (SINGAPORE) PTE.
LTD., SINGAPORE, SINGAPORE:
3,567,537, PUB. 11-11-2008. INT. CL. 9.
- AVC DISTRIBUTOR, LLC, DENVER, CO:
3,567,049, PUB. 11-11-2008. INT. CL. 35.
- AVEDA CORPORATION, MINNEAPOLIS, MN:
1,520,430, REN. 12-19-08. INT. CL. 3.
- AVEDA CORPORATION, MINNEAPOLIS, MN:
1,524,100, REN. 12-19-08. INT. CL. 3.
- AVEL PTY LTD, WELSHPOOL, WESTERN AUSTRALIA,
AUSTRALIA:
2,545,894, CANC. INT. CL. 41.
- AVENTIS PHARMACEUTICALS INC., BRIDGEWATER, NJ:
2,213,312, REN. 12-20-08. INT. CL. 5.
- AVERMEDIA TECHNOLOGIES, INC., JONG-HO CITY,
TAIPEI, TAIWAN:
2,546,584, CANC. INT. CL. 9.
2,546,585, CANC. INT. CL. 9.
- AVM, L.P., WEST PALM BEACH, FL:
2,145,345, CANC. INT. CL. 36.
- AVYX, INC., HIGHLANDS RANCH, CO:
3,568,670, INT. CL. 41.
- AXA, 75008 PARIS, FRANCE:
2,546,261, CANC. INT. CL. 36.
2,546,262, CANC. INT. CL. 36.
- AXIOM NAVIGATION, INC., ANAHEIM, CA:
2,546,027, CANC. INT. CL. 9.
- AZHAK, HUSSAM, GARDEN GROVE, CA:
3,566,273, PUB. 11-11-2008. INT. CL. 3.
- AZIA CO. LTD., YORO-GUN, GIFU, JAPAN:
2,547,716, CANC. INT. CL. 12.
- AZTECH SOFTWARE, INC., GREELEY, CO:
3,567,289, PUB. 11-11-2008. INT. CL. 9.
- B+ EQUIPMENT, GEMENOS, FRANCE:
3,567,194, PUB. 11-11-2008. INT. CL. 7.
- BACARDI & COMPANY LIMITED, NASSAU, BAHAMAS:
3,567,732, PUB. 8-2-2005. INT. CL. 33.
- BACARDI & COMPANY LIMITED, LIECHTENSTEIN:
3,567,907, PUB. 11-11-2008. INT. CL. 33.
- BACK QUALITY USA, BZ DEN HAAG, NETHERLANDS:
3,568,442, INT. CL. 20.
3,568,443, INT. CL. 20.
3,568,444, INT. CL. 20.
- BAE SYSTEMS NATIONAL SECURITY SOLUTIONS INC.,
SAN DIEGO, CA:
2,213,837, REN. 12-23-08. INT. CL. 9.
- BAG-EM PRODUCTS LLC, FLINT, MI:
2,546,782, CANC. INT. CL. 28.
- BAGSTER, LLC, ATLANTA, GA:
3,567,568, PUB. 11-11-2008. INT. CL. 39.
3,567,569, PUB. 11-11-2008. INT. CL. 39.
- BAIER & MICHELS GMBH & CO. KG, OBER-RAMSTADT,
FED REP GERMANY:
3,567,914, PUB. 11-11-2008. MULTIPLE CLASS, INT. CLS.
6 AND 20.
- BAILEY'S INC., LAYTONVILLE, CA:
3,567,371, PUB. 11-11-2008. INT. CL. 4.
- BAKER HUGHES INCORPORATED, HOUSTON, TX:
2,547,464, CANC. INT. CL. 7.
- BAKER, KAREN R., WASHINGTON, DC:
2,546,274, CANC. INT. CL. 36.
- BALANCED CARE FOR WOMEN OF ST. LOUIS, P.C.,
CREVE COEUR, MO:
3,567,213, PUB. 11-11-2008. INT. CL. 44.
- BALLANTRAE HEALTHCARE, LLC, NEW YORK, NY:
2,548,089, CANC. INT. CL. 42.
- BALLANTYNE OF OMAHA, INC., OMAHA, NE:
2,144,048, CANC. MULTIPLE CLASS, INT. CLS. 9 AND
11.

- BANANZA AIR MANAGEMENT SYSTEMS, INC., KENTWOOD, MI:
2,145,376, CANC. INT. CL. 11.
- BANCFIRST OHIO CORP., ZANESVILLE, OH:
2,546,352, CANC. INT. CL. 36.
- BANCFIRST OHIO CORPORATION, ZANESVILLE, OH:
2,546,091, CANC. INT. CL. 36.
2,548,296, CANC. INT. CL. 36.
- BANCWARE LLC, BOSTON, MA:
2,545,642, CANC. INT. CL. 9.
- BANDAI VISUAL KABUSHIKI KAISHA, TAITO-KU, TOKYO, JAPAN:
2,545,971, CANC. INT. CL. 28.
- BANGHAM, DAVID, LAS VEGAS, NV:
3,566,288, PUB. 11-11-2008. INT. CL. 3.
- BANK OF AMERICA CORPORATION, CHARLOTTE, NC:
1,481,039, CANC. INT. CL. 36.
1,481,046, CANC. INT. CL. 36.
- BANKATLANTIC BANCORP, INC., FT. LAUDERDALE, FL:
3,566,252, PUB. 11-11-2008. INT. CL. 36.
3,566,253, PUB. 11-11-2008. INT. CL. 36.
- BANKERS TRUST COMPANY, NEW YORK, NY:
2,546,364, CANC. INT. CL. 36.
- BANPRESTO CO., LTD., TOKYO, JAPAN:
2,145,525, CANC. INT. CL. 28.
- BARBERI, ELIZABETH H., GULF BREEZE, FL:
3,567,182, PUB. 11-11-2008. INT. CL. 18.
- BARD'S TALE BEER COMPANY, LLC, EDINA, MN:
3,568,536, INT. CL. 32.
3,568,754, INT. CL. 32.
- BARER ENGINEERING COMPANY OF AMERICA, BURLINGTON, VT:
2,143,953, CANC. INT. CL. 7.
- BARILLA G. E. R. FRATELLI - SOCIETÀ PER AZIONI, PARMA, ITALY:
3,566,568, PUB. 8-19-2008. INT. CL. 30.
- BARLIER, PIERRE J., PARIS, FRANCE:
2,548,506, CANC. INT. CL. 21.
- BARNEL INTERNATIONAL, INC., PORTLAND, OR:
2,209,226, REN. 12-20-08. INT. CL. 35.
- BARNETT FITNESS, INC., BATON ROUGE, LA:
2,280,843, REN. 12-23-08. INT. CL. 41.
- BARNETT, ROBERT L., COSTA MESA, CA:
3,567,637, PUB. 11-11-2008. INT. CL. 12.
- BARNEY'S BLING, SANTA MONICA, CA:
3,568,537, INT. CL. 14.
- BARNHART, JOHN DAVID, ALBUQUERQUE, NM:
2,548,498, CANC. INT. CL. 28.
- BARNIE'S II, INC., ORLANDO, FL:
3,567,039, PUB. 11-11-2008. INT. CL. 21.
3,567,040, PUB. 11-11-2008. INT. CL. 30.
- BARON, MICHAEL W., NEW YORK, NY:
2,548,496, CANC. INT. CL. 36.
- BARONE, MAURIZIO, SAN FRANCISCO, CA, DBA COTTAGE INDUSTRY:
2,144,280, CANC. MULTIPLE CLASS, INT. CLS. 25 AND 35.
- BARONESS SMALL ESTATES, INC., DENVER, CO:
3,568,556, INT. CL. 33.
3,568,557, INT. CL. 33.
3,568,558, INT. CL. 33.
- BARRETT, MARILYN, LOS ANGELES, CA:
3,568,472, INT. CL. 25.
- BARTL-SCHÖLL, ANDREA, VOHENASTRAUSS, FED REP GERMANY:
3,566,890, PUB. 11-11-2008. MULTIPLE CLASS, INT. CLS. 16 AND 44.
- BASELL N.V., HOOFDDORP, NETHERLANDS, HERCULES POWDER COMPANY, WILMINGTON, DE:
662,091, REN. 12-22-08. U.S. CL. 6 (INT. CL. 1).
- BASELL N.V., HOOFDDORP, NETHERLANDS:
3,567,735, PUB. 11-11-2008. INT. CL. 1.
- BASEMENT TECHNOLOGIES, INC., NEEDHAM, MA:
3,566,363, PUB. 11-11-2008. INT. CL. 19.
- BASF CATALYSTS LLC, ISELIN, NJ:
2,144,908, CANC. INT. CL. 11.
- BATES ADVERTISING USA, INC., NEW YORK, NY:
2,546,313, CANC. MULTIPLE CLASS, INT. CLS. 16 AND 35.
- BATESVILLE SERVICES, INC., BATESVILLE, IN:
3,568,731, INT. CL. 20.
- BATH & BODY WORKS BRAND MANAGEMENT, INC., REYNOLDSBURG, OH:
3,568,627, MULTIPLE CLASS, INT. CLS. 3 AND 35.
- BATIZ.COM, VISTA, CA:
2,548,589, CANC. INT. CL. 42.
- BATTERY TECHNOLOGIES INC., RICHMOND HILL, ONTARIO M4B 1C3, CANADA:
2,545,537, CANC. INT. CL. 9.
- BAUMANN RESEARCH & DEVELOPMENT CORP., SAN CLEMENTE, CA:
3,568,737, INT. CL. 6.
- BAUMEISTER, JEANNIE DOWNS, PRAIRIEVILLE, LA:
3,566,591, PUB. 11-11-2008. MULTIPLE CLASS, INT. CLS. 16 AND 25.
- BAUSCH & LOMB INCORPORATED, ROCHESTER, NY:
2,207,212, REN. 12-20-08. INT. CL. 5.
- BAXTER INTERNATIONAL INC., DEERFIELD, IL:
1,480,705, CANC. INT. CL. 10.
2,213,425, REN. 12-22-08. INT. CL. 5.
- BAXTER INTERNATIONAL INC., DEERFIELD, IL, BAXTER INTERNATIONAL INC., DEERFIELD, IL:
2,214,849, REN. 12-20-08. INT. CL. 5.
- BAXTERBEAR LIMITED, EDINBURGH, SCOTLAND, UNITED KINGDOM:
3,567,956, PUB. 11-11-2008. MULTIPLE CLASS, INT. CLS. 9, 16, 24, 25 AND 28.
- BAY CITY TELEVISION, INC., SAN DIEGO, CA:
2,145,389, CANC. INT. CL. 41.
- BAY HARBOR COMPANY, L.L.C., SOUTHFIELD, MI:
2,145,421, CANC. MULTIPLE CLASS, INT. CLS. 39 AND 41.
- BAYERISCHE STAATSBRAUEREI; WEIHENSTEPHAN, FED REP GERMANY:
3,567,852, PUB. 11-11-2008. INT. CL. 32.
- BAYLESS, LEE A., VALENCIA, CA:
2,548,140, CANC. INT. CL. 22.
- BCD TRAVEL GERMANY HOLDING GMBH, FED REP GERMANY:
3,567,900, PUB. 11-11-2008. MULTIPLE CLASS, INT. CLS. 9, 38 AND 42.
- BE INSPIRED JEWELRY, LLC, WESTMINSTER, CO:
3,567,429, PUB. 11-11-2008. INT. CL. 14.
- BECTON DICKINSON AND COMPANY, FRANKLIN LAKES, NJ:
2,547,653, CANC. MULTIPLE CLASS, INT. CLS. 1 AND 9.
- BECTON, DICKINSON AND COMPANY, FRANKLIN LAKES, NJ TO ANSELL LIMITED, RICHMOND, AUSTRALIA:
1,480,584, CANC. INT. CL. 9.
- BECTON, DICKINSON AND COMPANY, FRANKLIN LAKES, NJ:
3,568,253, INT. CL. 10.
- BEHAR MARKETING, INC., EDMONDS, WA:
2,547,105, CANC. INT. CL. 12.
- BEHAVIORAL TECHNOLOGY, INC., MEMPHIS, TN:
1,480,608, CANC. INT. CL. 9.
- BEHR GMBH & CO., D-70449 STUTTGART, FED REP GERMANY:
2,545,896, CANC. MULTIPLE CLASS, INT. CLS. 7, 9, 11, 12 AND 37.
- BEIERSDORF AG, FED REP GERMANY:
3,567,828, PUB. 11-11-2008. INT. CL. 1.
- BEK ROYALTY TRUST, FORT WORTH, TX, KEITH, BEN E., FT. WORTH, TX, DBA BEN E. KEITH COMPANY:
504,751, REN. 12-19-08. U.S. CL. 46 (INT. CL. 31).
- BEL AIR LIGHTING, INC., VALENCIA, CA AND BEL AIR LIGHTING, INC., VALENCIA, CA:
3,566,577, PUB. 11-11-2008. INT. CL. 11.
- BELDEN TECHNOLOGIES, INC., ST. LOUIS, MO:
2,145,117, CANC. INT. CL. 9.
2,547,599, CANC. INT. CL. 9.
- BELFOR USA GROUP INC., BIRMINGHAM, MI:
3,568,282, MULTIPLE CLASS, INT. CLS. 39 AND 42.

- BELL BIZ INC., OCEANSIDE, NY, DBA COMPUTER EVOLUTION:
3,567,222, PUB. 11-11-2008. INT. CL. 42.
- BEMIS MANUFACTURING COMPANY, SHEBOYGAN FALLS, WI:
2,250,122. REN. 12-22-08. MULTIPLE CLASS, INT. CLS. 10 AND 11.
2,250,122, CANC. MULTIPLE CLASS, INT. CLS. 19, 20 AND 21.
- BENACO TOOLING RESEARCH & DEVELOPMENT CORP., PAINESVILLE, OH:
1,480,482, CANC. INT. CL. 7.
- BENDER, TRACEY, SURREY, BRITISH COLUMBIA, CANADA:
3,568,671, INT. CL. 43.
- BENEFIT INSIGHTS, INC., NEW BERN, NC:
3,566,876, PUB. 11-11-2008. INT. CL. 38.
- BENETIZ, ANTONIO, CULVER CITY, CA:
3,567,557, PUB. 11-11-2008. INT. CL. 41.
- BENJAMIN, CLEVELAND, BROOKLYN, NY:
3,567,514, PUB. 11-11-2008. INT. CL. 35.
- BENNING READERS FOUNDATION, INC., MT. VERNON, NY:
2,545,667, CANC. INT. CL. 16.
- BENNINGTON MARINE, LLC, ELKHART, IN:
3,568,462, INT. CL. 12.
- BENTON, JAMES K., BLOOMFIELD, MI:
2,208,219. REN. 12-19-08. INT. CL. 25.
- BERBERIAN, ONNIG, SOUTH EL MONTE, CA, DBA BIG BAG COMPANY, AKA NICK BERIAN:
2,546,528, CANC. MULTIPLE CLASS, INT. CLS. 18, 22 AND 35.
- BERECIBAR, RAUL EDUARDO, CORDOBA, ARGENTINA:
3,018,570, CANC. INT. CL. 25.
- BERGQUIST, DIANN JUDITH, PLYMOUTH, MI:
3,568,535, INT. CL. 3.
- BERKELEY EDUCATIONAL SERVICES OF NEW JERSEY, INC., PARAMUS, NJ:
2,144,034, CANC. MULTIPLE CLASS, INT. CLS. 41 AND 42.
- BERKSHIRE LABELS LTD, UNITED KINGDOM:
3,567,965, PUB. 11-11-2008. INT. CL. 16.
- BERMAN, IRA, FOREST HILLS, NY:
2,548,621, CANC. INT. CL. 35.
- BERMAN, ROGER H., BASKING RIDGE, NJ, SLC FASHION CORPORATION, NEW YORK, NY:
1,104,815. REN. 12-23-08. INT. CL. 25.
- BERNAL, DEAN, E., CAMPBELL, CA:
2,659,387, CANC. MULTIPLE CLASS, INT. CLS. 14 AND 21.
- BERNHARD, PAUL, HOUSTON, TX:
2,546,543, CANC. INT. CL. 41.
- BEST MILK PRODUCERS COOPERATIVE, TROUT RUN, PA:
2,547,866, CANC. INT. CL. 29.
- BEST VENDORS MANAGEMENT COMPANY, INC., MINNEAPOLIS, MN:
3,568,041, INT. CL. 9.
- BEST VENDORS MANAGEMENT, INC., MINNEAPOLIS, MN:
3,568,357, INT. CL. 9.
- BESTGROUP CONSULTING & SOFTWARE GMBH, BERLIN, FED REP GERMANY:
3,568,268, INT. CL. 42.
- BETA STEEL CORP., PORTAGE, IN:
2,547,467, CANC. INT. CL. 6.
- BETTER BUSINESS BUREAU OF THE SOUTHLAND, INC., COLTON, CA:
3,568,300, INT. CL. 35.
- BETTER LIFE TECHNOLOGY, L.L.C., LENEXA, KS:
2,547,878, CANC. INT. CL. 27.
- BETTER SLEEP, INC., BERKELEY HEIGHTS, NJ:
1,521,867. REN. 12-22-08. INT. CL. 21.
- BEXCO ENTERPRISES, INC., MONTEBELLO, CA:
3,567,050, PUB. 11-11-2008. INT. CL. 20.
- BEYOND COFFEE & CAPPUCCINO LLC, FREDERICKSBURG, VA:
3,568,480, INT. CL. 30.
- BFS DIVERSIFIED PRODUCTS, LLC, INDIANAPOLIS, IN:
3,568,071, INT. CL. 6.
- BFTV, LLC, LOS ANGELES, CA:
3,567,711, PUB. 11-11-2008. INT. CL. 41.
- BIAGINI, DAVID, SAN FRANCISCO, CA:
2,546,881, CANC. INT. CL. 14.
- BIANCA USA, INC., NEW BRUNSWICK, NJ:
2,546,852, CANC. INT. CL. 24.
2,546,853, CANC. INT. CL. 24.
2,547,154, CANC. INT. CL. 24.
- BIC ACQUISITION, LLC, LYNNFIELD, MA:
2,184,065. REN. 12-23-08. INT. CL. 42.
2,187,695. REN. 12-23-08. INT. CL. 42.
- BIG AMAZON FISH, LLC, LINDON, UT:
3,567,795, PUB. 11-11-2008. MULTIPLE CLASS, INT. CLS. 39 AND 41.
- BIG MUNGA DEVELOPMENT, LLC, LOS ANGELES, CA:
3,566,702, PUB. 11-11-2008. INT. CL. 36.
- BIG NIGHT IN TENT, LLC, NEW YORK, NY:
3,568,379, INT. CL. 41.
- BIG TRAIN, INC., RANCHO SANTA MARGARITA, CA:
2,546,114, CANC. INT. CL. 30.
- BIG Z SPORTS, LLC, YUKON, OK:
3,566,860, PUB. 11-11-2008. INT. CL. 28.
- BIGELOW MOUNTAIN PARTNERS LLC, FREEPORT, ME:
2,144,206, CANC. MULTIPLE CLASS, INT. CLS. 18 AND 25.
- BIJUR LUBRICATING CORPORATION, BENNINGTON, VT:
2,545,688, CANC. INT. CL. 1.
- BILENIATECH, L.P., PHILADELPHIA, PA:
2,547,558, CANC. INT. CL. 42.
- BINAURA CORPORATION, MENLO PARK, CA:
2,548,023, CANC. INT. CL. 9.
- BINDRUP, TROY VERL, LOGAN, UT:
2,180,103. REN. 12-23-08. INT. CL. 37.
- BIO-BOTANICA, INC., HAUPPAUGE, NY:
3,568,676, INT. CL. 1.
- BIO-PLEXUS, INC., VERNON, CT:
2,547,116, CANC. INT. CL. 10.
- BIOCENTRIC SOLUTIONS, INC., MADISON, WI:
2,548,155, CANC. INT. CL. 9.
- BIOKINETICS, INC., PHILADELPHIA, PA:
2,203,512. REN. 12-24-08. MULTIPLE CLASS, INT. CLS. 37 AND 42.
- BIOLASE TECHNOLOGY, INC., SAN CLEMENTE, CA:
2,547,494, CANC. INT. CL. 21.
- BIOMED COMM, INC., SEATTLE, WA:
2,158,347. REN. 12-23-08. INT. CL. 5.
- BIOSCIENCE LABORATORIES, INC., BOZEMAN, MT:
3,568,430, INT. CL. 42.
- BIOSIGNIA, INC., DURHAM, NC:
3,567,321, PUB. 11-11-2008. INT. CL. 42.
- BIOTA BITKISEL KOZMETIK; LABORATUARLARI; TICARET LIMITED SIRKETI, TURKEY:
3,567,966, PUB. 11-11-2008. INT. CL. 3.
- BIOTAGE AB, SE-753 18 UPPSALA, SWEDEN:
2,548,639, CANC. INT. CL. 16.
- BIOTECHNOLOGY INSTITUTE, S.L., 01005 VITORIA (ALAVA), SPAIN:
3,566,514, PUB. 11-11-2008. INT. CL. 9.
- BIOTICS RESEARCH CORPORATION, ROSENBERG, TX:
2,287,852. REN. 12-20-08. INT. CL. 5.
- BIRDELL, JOHN A., FLAGSTAFF, AZ AND BIRDELL, DAWN, FLAGSTAFF, AZ:
3,566,990, PUB. 11-11-2008. INT. CL. 35.
- BIRNEY, JAMES M., HOUSTON, TX:
2,547,682, CANC. INT. CL. 36.
- BISCAYNE AQUACULTURE, INC., AUSTIN, TX:
3,567,391, PUB. 11-11-2008. INT. CL. 37.
- BISHOP OF THE CHURCH OF TZADDI, THE, PETALUMA, CA:
1,494,682. REN. 12-22-08. INT. CL. 42.
- BITTLER, VIRGINIA LEE, VANCOUVER, WA:
2,546,754, CANC. INT. CL. 2.
- BIZNESSHOSTING, INC., HOLLYWOOD, FL, DBA VOLICO:
3,567,180, PUB. 11-11-2008. INT. CL. 42.

- BK GIULINI GMBH, D-67065 LUDWIGSHAFEN, FED REP GERMANY:
2,545,555, CANC. MULTIPLE CLASS, INT. CLS. 1, 2, 3, 5, 19, 29 AND 30.
- BKN INTERNATIONAL AG, COLOGNE, FED REP GERMANY:
2,547,700, CANC. INT. CL. 41.
- BLACK BUFFALO ARTWORKS, INC., NEW YORK, NY:
3,568,292, MULTIPLE CLASS, INT. CLS. 35 AND 40.
- BLACK ENTERTAINMENT TELEVISION LLC, WASHINGTON, DC:
3,568,684, INT. CL. 41.
- BLACK FIVES, INC., GREENWICH, CT:
3,566,448, PUB. 11-11-2008. INT. CL. 25.
- BLACK ROCK RESEARCH, INC., MINDEN, NV:
2,548,637, CANC. INT. CL. 41.
- BLAIN HYDRAULICS GMBH, 74078 HEILBRONN, FED REP GERMANY:
2,145,111, CANC. INT. CL. 9.
- BLAIN SUPPLY, INC., JANESVILLE, WI:
2,208,925. REN. 12-20-08. INT. CL. 31.
- BLAKE, MICHAEL J., PLAINFIELD, IL:
2,546,797, CANC. INT. CL. 5.
- BLINDS TO GO INC., MONTREAL, QUEBEC, CANADA:
2,144,144, CANC. MULTIPLE CLASS, INT. CLS. 19, 20 AND 24.
- BLINDSIGHT CLOTHING, WOODLAND HILLS, CA:
3,566,886, PUB. 11-11-2008. INT. CL. 25.
- BLONDELL, HARRY W., NOTTINGHAM, MD AND MUNSON, ROBERT B., NOTTINGHAM, MD AND NACE, MICHAEL S., NOTTINGHAM, MD:
3,566,981, PUB. 11-11-2008. MULTIPLE CLASS, INT. CLS. 36 AND 38.
- BLUE BOX TOY FACTORY LIMITED, EAST KOWLOON, HONG KONG:
3,568,076, INT. CL. 28.
- BLUE BUFFALO COMPANY, LLC, WILTON, CT:
3,568,453, INT. CL. 31.
- BLUE COAT SYSTEMS, INC., SUNNYVALE, CA:
3,566,585, PUB. 11-11-2008. INT. CL. 42.
- BLUE GROTTO TECHNOLOGIES, INC., PLYMOUTH MEETING, PA:
3,568,636, MULTIPLE CLASS, INT. CLS. 9 AND 35.
- BLUE MARTINI SOFTWARE, INC., SAN DIEGO, CA:
2,548,011, CANC. INT. CL. 9.
- BLUE MARTINI, LLC, SAN MATEO, CA:
2,547,719, CANC. INT. CL. 9.
- BLUE MAX TECHNOLOGY, INC., NEWBURY PARK, CA:
2,547,414, CANC. INT. CL. 9.
- BLUE RIDGE INTERNATIONAL PRODUCTS COMPANY, FREEPORT, FL:
2,143,944, CANC. INT. CL. 12.
- BLUEFLY, INC., NEW YORK, NY:
2,545,644, CANC. INT. CL. 35.
- BLUGRIND, JEFFREY RUSSELL, LADERA RANCH, CA:
2,144,646, CANC. INT. CL. 9.
- BMC WEST CORPORATION, BOISE, ID:
2,546,790, CANC. INT. CL. 35.
- BNK INVEST, INC., LOCUST VALLEY, NY:
3,567,574, PUB. 11-11-2008. INT. CL. 41.
- BNP MEDIA II, LLC, TROY, MI:
2,545,563, CANC. INT. CL. 42.
- BNSF RAILWAY COMPANY, FORT WORTH, TX:
3,567,163, PUB. 11-11-2008. INT. CL. 39.
- BNY CONVERGEX EXECUTION SOLUTIONS LLC, NEW YORK, NY:
2,546,046, CANC. INT. CL. 36.
- BOARD OF TRUSTEES OF THE CALIFORNIA STATE UNIVERSITY, ARCATA, CA:
2,546,096, CANC. MULTIPLE CLASS, INT. CLS. 21, 25, 38 AND 41.
- BOARDMAN MOLDED PRODUCTS, INC., YOUNGSTOWN, OH:
2,548,049, CANC. INT. CL. 27.
- BOARDROOM COMMUNICATIONS, INC., PLANTATION, FL:
3,566,559, PUB. 11-11-2008. INT. CL. 35.
- BOATTEST.COM, LLC, STAMFORD, CT:
3,566,669, PUB. 11-11-2008. INT. CL. 35.
- BOB EVANS RESTAURANTS OF MICHIGAN, INC., ANN ARBOR, MI:
3,566,446, PUB. 4-1-2008. INT. CL. 35.
- BOB JONES UNIVERSITY, GREENVILLE, SC:
2,144,706, CANC. INT. CL. 41.
- BOBCAD-CAM INCORPORATED, CLEARWATER, FL:
3,566,275, PUB. 11-11-2008. INT. CL. 9.
- BOBOL & PINCO, B.V., 6524 KL NIJMEGEN, NETHERLANDS:
2,546,256, CANC. MULTIPLE CLASS, INT. CLS. 3, 29, 30 AND 33.
- BOC GROUP, INC., THE, NEW PROVIDENCE, NJ:
2,144,952, CANC. INT. CL. 1.
- BOC GROUP, INC., THE, MURRAY HILL, NEW PROVIDENCE, NJ:
2,145,446, CANC. INT. CL. 1.
- BOCHASANWASI SHRI AKSHAR PURUSHOTTAM SWAMINARAYAN SANSTHA, INC., PISCATAWAY, NJ:
3,567,480, PUB. 11-11-2008. MULTIPLE CLASS, INT. CLS. 35 AND 43.
- BODEGAS EMILIO MORO, S.L., DE DUERO 47315, SPAIN:
3,568,469, INT. CL. 33.
3,568,470, INT. CL. 33.
- BODEGAS FINCA LA ESTACADA, S.L., TARANCON, SPAIN:
3,566,949, PUB. 11-11-2008. INT. CL. 33.
- BODIES IN BALANCE SEATTLE, LLC, SEATTLE, WA:
3,567,248, PUB. 11-11-2008. INT. CL. 41.
- BODY MOTION PHYSICAL THERAPY INC., SANTA MONICA, CA, DBA BODY MOTION PHYSICAL THERAPY:
3,566,687, PUB. 11-11-2008. INT. CL. 44.
- BOEHRINGER INGELHEIM INTERNATIONAL GMBH, GERMANY, FED REP GERMANY:
671,422. REN. 12-19-08. U.S. CL. 18 (INT. CL. 5).
- BOGGEAR LLC, FREDERICKSBURG, TX:
3,566,887, PUB. 11-11-2008. INT. CL. 9.
- BOLDWEAR CLOTHING, LLC, ATLANTA, GA:
3,568,336, INT. CL. 25.
- BOLLE AMERICA, INC.:
1,480,563, CANC. INT. CL. 9.
- BOMBARDIER RECREATIONAL PRODUCTS INC., VALCOURT, CANADA:
2,145,130, CANC. INT. CL. 4.
3,567,765, PUB. 11-11-2008. INT. CL. 12.
- BONFIRE PRODUCTIONS, INC., BELLEVUE, WA:
3,568,273, INT. CL. 9.
- BONNIE FOLEY DBA VIZCAYA, BRIMINGHAM, MI:
3,567,129, PUB. 11-11-2008. INT. CL. 25.
- BONNOUVRIER, GISELE, 75008 PARIS, FRANCE:
2,546,423, CANC. INT. CL. 35.
- BOOB TOOB APPAREL, INC., NEW YORK, NY:
2,545,961, CANC. INT. CL. 25.
- BOOK FAIRY, INC., OMAHA, NE:
3,568,321, INT. CL. 12.
- BOONDOGS, L.L.C., LITTLE ROCK, AR:
2,545,845, CANC. INT. CL. 41.
- BOREALIS AG, AUSTRIA:
3,567,874, PUB. 11-11-2008. MULTIPLE CLASS, INT. CLS. 1, 17 AND 19.
- BORROWED TIME, INC., AUSTIN, TX:
2,655,425, AM. MULTIPLE CLASS, INT. CLS. 9 AND 42.
- BOSCH SECURITY SYSTEMS, INC., FAIRPORT, NY:
2,145,522, CANC. INT. CL. 9.
- BOSTON BAGEL INC., QUINCY, MA:
2,546,393, CANC. INT. CL. 30.
- BOSTON BIOMEDICA, INC., WEST BRIDGEWATER, MA:
2,144,258, CANC. MULTIPLE CLASS, INT. CLS. 1, 5 AND 42.
- BOSTON MILLENNIA PARTNERS LIMITED PARTNERSHIP, BOSTON, MA, BOSTON MILLENNIA PARTNERS LIMITED PARTNERSHIP, BOSTON, MA:
2,296,428. REN. 12-22-08. INT. CL. 36.
- BOTICA COMERCIAL FARMACEUTICA S.A., SAO JOSE DOS PINHAIS, PARANA, BRAZIL:
3,568,664, INT. CL. 3.

BOULDER APPAREL LIMITED, NELSON, NEW ZEALAND:
3,566,808, PUB. 11-11-2008. INT. CL. 25.

BOULEVARD COMPUTER SYSTEMS INC., TORONTO,
ONTARIO, CANADA:
1,480,503, CANC. INT. CL. 9.

BOYD GAMING CORPORATION, LAS VEGAS, NV:
3,568,503, INT. CL. 44.

BOYDS COLLECTION, LTD., THE, MCSHERRYSTOWN,
PA:
2,548,306, CANC. INT. CL. 20.

BOYDS COLLECTION, LTD, THE, MCSHERRYSTOWN, PA:
2,548,401, CANC. INT. CL. 20.

BOYT BRANDS, INC., IOWA FALLS, IA:
3,568,534, INT. CL. 18.

BP AMOCO P.L.C., LONDON SW1Y 4PD, UNITED KING-
DOM:
2,545,698, CANC. MULTIPLE CLASS, INT. CLS. 1 AND
42.

BPI CARPETS, INC., MEMPHIS, TN TO BUILDING PLAS-
TICS, INC., MEMPHIS, IN:
1,480,884, CANC. INT. CL. 27.

BR PHARMA LIMITED, BOREHAMWOOD, HERFORDS.,
UNITED KINGDOM:
3,568,424, MULTIPLE CLASS, INT. CLS. 35, 39, 40 AND
44.

BRAD RAMBO & ASSOCIATES, INC., SAN CLEMENTE, CA:
3,567,155, PUB. 11-11-2008. INT. CL. 25.

BRAGG, LARRY M., LANCASTER, PA:
2,546,889, CANC. INT. CL. 25.

BRANDED LLC, DALLAS, TX:
2,548,159, CANC. INT. CL. 28.

BRASIF TAX FREE INC., MIAMI, FL:
2,547,179, CANC. INT. CL. 35.

BRAUDE JEWELRY CORP., CHICAGO, IL:
2,545,603, CANC. INT. CL. 35.

BRAVE NEW GIRLS LIMITED, LLC, NASHVILLE, TN:
3,567,294, PUB. 11-11-2008. INT. CL. 16.
3,567,295, PUB. 11-11-2008. INT. CL. 25.
3,567,296, PUB. 11-11-2008. INT. CL. 9.

BRAVO SPORTS, SANTA FE SPRINGS, CA:
2,210,631, REN. 12-24-08. INT. CL. 28.

BREAK THE CURSE KIT, INC., WHEATON, IL:
3,566,499, PUB. 3-25-2008. INT. CL. 28.

BREAKTHROUGH TO LITERACY, INC., CORALVILLE, IA:
2,547,044, CANC. MULTIPLE CLASS, INT. CLS. 35, 41
AND 42.

BRENNAN, BRIAN A, CHICAGO, IL:
3,568,198, INT. CL. 41.

BRENNER, ARNOLD, BROOKLYN, NY:
2,145,000, CANC. INT. CL. 42.

BRENNTAG LATIN AMERICA, INC., HOUSTON, TX:
2,144,341, CANC. INT. CL. 1.

BREWER INTERNATIONAL, INCORPORATED, VERO
BEACH, FL:
1,480,382, CANC. INT. CL. 3.

BREWER, JAMES T., MELBOURNE, FL:
2,546,982, CANC. INT. CL. 28.

BREWING MARKET, LTD., BOULDER, CO:
2,546,234, CANC. INT. CL. 30.

BREWSTER WALLPAPER CORP., RANDOLPH, MA:
2,548,481, CANC. INT. CL. 27.

BRIANNA, INC., PLANO, TX:
2,546,389, CANC. INT. CL. 35.

BRIARWOOD PRESBYTERIAN CHURCH, BIRMINGHAM,
AL:
2,546,963, CANC. MULTIPLE CLASS, INT. CLS. 25 AND
42.

BRICKELL FINANCIAL SERVICES MOTOR CLUB, INC.,
MIAMI, FL:
3,566,515, PUB. 11-11-2008. INT. CL. 37.

BRIDEN, PATRICIA G., VIRGINIA BEACH, VA:
3,568,543, INT. CL. 18.

BRIDEN, PAUL, AGUANGA, CA:
2,546,783, CANC. INT. CL. 28.

BRIDGESTONE SPORTS CO., LTD., TOKYO, JAPAN:
2,548,441, CANC. INT. CL. 28.

BRIDGET RAYMOND, RUTHERFORD, CA:
3,567,234, PUB. 11-11-2008. INT. CL. 33.

BRIGADE CORPORATION, SAN FRANCISCO, CA:
2,546,241, CANC. MULTIPLE CLASS, INT. CLS. 35 AND
42.

BRILLARTE S.R.L., 32040 LOZZO DI CADORE (BL), ITALY:
2,547,633, CANC. INT. CL. 9.

BRILLIANT PRODUCTS, LLC, BILLINGS, MT:
3,568,359, INT. CL. 11.
3,568,360, INT. CL. 35.

BRISTOL-MYERS SQUIBB PHARMA COMPANY, WIL-
MINGTON, DE:
2,143,857, CANC. INT. CL. 9.

BRITTLE, CHARLES LEWIS, STERLING, VA:
2,547,247, CANC. INT. CL. 37.

BROADBAND CONTENT DELIVERY FORUM, INC.,
MOUNTAIN VIEW, CA:
2,547,043, CANC. INT. CL. 42.

BROOK, ADAM M., JACKSON, MS:
3,568,615, INT. CL. 16.

BROOKHAVEN RETREAT, LLC, SEYMOUR, TN:
3,567,631, PUB. 11-11-2008. INT. CL. 16.

BROOKS, CATHERINE, SOLANA BEACH, CA:
3,568,249, INT. CL. 10.

BROTHER MAX LIMITED, BOREHAMWOOD, UNITED
KINGDOM:
3,566,807, PUB. 11-11-2008. INT. CL. 21.

BROTHERHOOD MUTUAL INSURANCE COMPANY, FT.
WAYNE, IN:
2,507,610, AM. INT. CL. 36.
2,507,611, AM. INT. CL. 36.
2,539,765, AM. INT. CL. 36.

BROUWERIJ BELAME, LTD., COOPERSTOWN, NY:
2,293,238, REN. 12-22-08. INT. CL. 32.

BROWN STREET INTERIORS, LLC, GREENVILLE, SC:
3,566,998, PUB. 11-11-2008. INT. CL. 35.

BROWN-FORMAN CORPORATION, LOUISVILLE, KY:
3,568,275, INT. CL. 33.

BROWN, DANIEL R., SALINAS, CA, DBA COALITION
CRAWLERS AND SHERMAN, SAGE, CARMEL, CA:
3,566,957, PUB. 11-11-2008. INT. CL. 35.

BROWN, PAUL ROBERT, SAN FRANCISCO, CA:
3,566,370, PUB. 11-11-2008. INT. CL. 41.

BROWNSTONE PUBLISHING, LLC, INDIANAPOLIS, IN:
3,566,414, PUB. 11-11-2008. INT. CL. 35.

BROX, LLC, VIRGINIA BEACH, VA:
3,568,297, INT. CL. 3.

BROYHILL FURNITURE INDUSTRIES, INC., LENOIR, NC:
2,547,382, CANC. INT. CL. 20.

BRUCE KUMAR FRANTZIS, FAIRFAX, CA:
3,566,750, PUB. 11-11-2008. INT. CL. 41.

BRUEL, SAMUEL, NORTH YARMOUTH, ME:
3,567,558, PUB. 11-11-2008. INT. CL. 5.

BRUNO'S SUPERMARKETS, INC., BIRMINGHAM, AL:
2,545,799, CANC. INT. CL. 35.

BRUNSWICK CORPORATION, TULSA, OK:
2,547,648, CANC. INT. CL. 7.

BRUYERE, MICHAEL A, SARASOTA, FL, DBA MRMIKES:
3,567,604, PUB. 11-11-2008. INT. CL. 12.

BRYAN, EUGENE L., BEND, OR:
2,291,271, REN. 12-22-08. INT. CL. 42.

BRYSON, ANDREW F, PADTHAWAY, AUSTRALIA AND
BRYSON, CLIVE, PADTHAWAY, AUSTRALIA AND
BRYSON, ELIZABETH M, PADTHAWAY, AUSTRALIA
AND BRYSON, PAUL W, PADTHAWAY, AUSTRALIA:
3,567,777, PUB. 11-11-2008. INT. CL. 33.

BSH BOSCH UND SIEMENS HAUSGERAETE GMBH,
MUNICH, FED REP GERMANY:
3,566,751, PUB. 11-11-2008. INT. CL. 7.

BUBBLE FACTORY, L.L.C., THE, BEVERLY HILLS, CA:
2,217,949, REN. 12-23-08. INT. CL. 41.
2,217,949, CANC. MULTIPLE CLASS, INT. CLS. 9 AND
16.

BUBBLE FACTORY, LLC, THE, BEVERLY HILLS, CA:
2,217,950, REN. 12-24-08. INT. CL. 41.
2,217,950, CANC. MULTIPLE CLASS, INT. CLS. 9 AND
16.

BUCKEYE INTERNATIONAL, INC., MARYLAND
HEIGHTS, MO:
2,289,062, REN. 12-19-08. INT. CL. 3.

- BUCKMASTERS, LTD., MONTGOMERY, AL, BUCKMASTER, INC., MONTGOMERY, AL:
1,556,098. REN. 12-20-08. INT. CL. 36.
- BUCKMASTERS, LTD., MONTGOMERY, AL:
1,557,397. REN. 12-20-08. U.S. CL. 200.
- BUCKSHOT, INC., WILMINGTON, NC:
2,546,386. CANC. INT. CL. 28.
- BUDGET BOOK SERVICE, INC., NEW YORK, NY:
1,480,782. CANC. INT. CL. 16.
- BUFF & COAT INTERNATIONAL, INC., EAGAN, MN:
3,567,462. PUB. 11-11-2008. INT. CL. 37.
- BUFKOR, INCORPORATED, CLEARWATER, FL:
3,567,047. PUB. 11-11-2008. MULTIPLE CLASS, INT. CLS. 14, 16 AND 20.
- BUILD IT GREEN, INC., BERKELEY, CA:
3,566,523. PUB. 11-11-2008. INT. CL. 41.
3,566,524. PUB. 11-11-2008. INT. CL. 42.
- BULGARI S.P.A., I-00187 ROMA, ITALY:
3,567,954. PUB. 11-11-2008. INT. CL. 3.
- BULLSEYE BRANDING, LLC, GREENVILLE, SC:
3,567,518. PUB. 11-11-2008. INT. CL. 25.
- BULOVA CORPORATION, WOODSIDE, NY:
3,568,152. INT. CL. 14.
- BUNGIE, LLC, KIRKLAND, WA:
3,567,644. PUB. 11-11-2008. INT. CL. 42.
- BUREAU OF NATIONAL AFFAIRS, INC., THE, ARLINGTON, VA:
2,208,262. REN. 12-22-08. INT. CL. 42.
- BURGETT, INCORPORATED, SACRAMENTO, CA:
2,144,610. CANC. INT. CL. 9.
- BURGOS, JOSE A., SAN JUAN, PUERTO RICO:
2,547,807. CANC. INT. CL. 35.
- BURLESON, CARESSA, VICTORIA, APPLETON, WI:
2,547,405. CANC. INT. CL. 42.
- BURNHAM, CRAIG C., SALEM, MA:
1,569,917. REN. 12-22-08. INT. CL. 28.
- BUSINESS INTEGRITY LIMITED, LONDON, UNITED KINGDOM:
3,568,608. MULTIPLE CLASS, INT. CLS. 9, 41 AND 42.
- BUSINESS METHODOLOGIES INTERNATIONAL, LTD., WARRENVILLE, IL:
3,566,341. PUB. 11-11-2008. INT. CL. 16.
3,566,342. PUB. 11-11-2008. INT. CL. 16.
3,566,343. PUB. 11-11-2008. INT. CL. 41.
3,566,344. PUB. 11-11-2008. INT. CL. 41.
- BUSINESSVOICE, INC., TOLEDO, OH:
3,566,635. PUB. 11-11-2008. INT. CL. 42.
- BUTCHER COMPANY, THE, STURTEVANT, WI, BUTCHER POLISH COMPANY, THE, MARLBORO, MA:
1,517,732. REN. 12-20-08. INT. CL. 3.
- BUTLER, EVELYN G., PLYMOUTH, MI:
3,568,778. INT. CL. 41.
- BUTTERFIELD & BUTTERFIELD AUCTIONEERS CORPORATION, SAN FRANCISCO, CA:
2,546,209. CANC. INT. CL. 35.
- BYONG-JIN, JOO, SEOUL, REPUBLIC OF KOREA:
3,566,409. PUB. 11-11-2008. INT. CL. 35.
- B2 NETWORKS, INC., DALLAS, TX:
3,483,285. CANC. INT. CL. 38.
- B2B ITS CORP., LAWRENCEVILLE, NJ:
3,566,760. PUB. 11-11-2008. MULTIPLE CLASS, INT. CLS. 9 AND 42.
- B601 FOGGY BOTTOM LLC, HOBOKEN, NJ:
3,568,116. INT. CL. 16.
- C. R. BARD, INC., MURRAY HILL, NJ:
1,532,879. REN. 12-20-08. INT. CL. 10.
- C.I.S. CROSS INDUSTRIE SOFTWARE AG, D - 30880 LAATZEN, FED REP GERMANY:
2,545,490. CANC. INT. CL. 9.
- C.S.F. CORP., WILMINGTON, DE:
3,566,468. PUB. 11-11-2008. MULTIPLE CLASS, INT. CLS. 35 AND 36.
- C-TEC CORPORATION, WILKES-BARRE, PA TO T.M.H., INC., WILMINGTON, DE:
1,481,024. CANC. MULTIPLE CLASS, INT. CLS. 35, 37, 38 AND 42.
- CA, INC., ISLANDIA, NY:
2,546,921. CANC. INT. CL. 9.
- CABALLERO, FRANCISCO, VAN NUYS, CA:
2,547,370. CANC. INT. CL. 9.
- CABLE NEWS NETWORK, INC., ATLANTA, GA:
3,567,666. PUB. 11-11-2008. INT. CL. 16.
- CABO WABO LLC, SAN FRANCISCO, CA:
2,657,637. AM. INT. CL. 25.
- CABRERA, FRANCISCO DLG, SAIPAN, UNITED STATES:
3,566,485. PUB. 11-11-2008. INT. CL. 25.
- CACHE INC., NEW YORK, NY:
2,548,399. CANC. INT. CL. 3.
- CACHET BANQ, PASADENA, CA:
3,568,252. INT. CL. 36.
- CAE INC., QUEBEC, CANADA:
3,567,725. PUB. 11-11-2008. MULTIPLE CLASS, INT. CLS. 9 AND 42.
- CAJOLEBEN, INC., MIRA LOMA, CA, DBA GALASSO BROTHERS:
1,519,039. REN. 12-20-08. INT. CL. 30.
- CALIFORNIA EXOTIC NOVELTIES LLC, CHINO, CA:
3,567,665. PUB. 11-11-2008. INT. CL. 10.
3,567,698. PUB. 11-11-2008. INT. CL. 10.
3,567,699. PUB. 11-11-2008. INT. CL. 10.
- CALIFORNIA FRUIT COMPANY, LA JOLLA, CA:
3,566,501. PUB. 11-11-2008. INT. CL. 31.
- CALIFORNIA INSTITUTE OF TECHNOLOGY, PASADENA, CA:
2,548,473. CANC. INT. CL. 42.
- CALIFORNIA MOTORS LLC, CAMARILLO, CA:
3,568,766. INT. CL. 12.
- CALIFORNIA RESOURCES AND TRAINING, OAKLAND, CA:
3,566,645. PUB. 11-11-2008. INT. CL. 41.
3,566,650. PUB. 11-11-2008. INT. CL. 41.
- CALIFORNIA SUNCARE, INC., LOS ANGELES, CA:
2,547,838. CANC. INT. CL. 3.
- CALLAWAY, THOMAS, ATLANTA, GA:
3,566,566. PUB. 11-11-2008. MULTIPLE CLASS, INT. CLS. 9 AND 41.
- CALLIPER LIFE SCIENCES, INC., MOUNTAIN VIEW, CA:
2,545,550. CANC. INT. CL. 9.
- CALMEX, INC., MODESTO, CA:
3,568,384. INT. CL. 43.
- CALZATURIFICIO SELENIA S.R.L., 63015 MONTE URANO (AP), ITALY:
2,545,777. CANC. MULTIPLE CLASS, INT. CLS. 18 AND 25.
- CAMBRIDGE CONSULTANTS LIMITED, CAMBRIDGE, ENGLAND CB4 4DW, UNITED KINGDOM:
2,545,619. CANC. INT. CL. 9.
- CAMBRIDGE DISPLAY TECHNOLOGY LIMITED, CAMBRIDGESHIRE, UNITED KINGDOM:
3,566,401. PUB. 6-3-2008. INT. CL. 9.
3,566,402. PUB. 6-3-2008. INT. CL. 9.
- CAMBRIDGE TECHNOLOGY PARTNERS (MASSACHUSETTS), INC., CAMBRIDGE, MA:
2,546,375. CANC. MULTIPLE CLASS, INT. CLS. 35 AND 42.
- CAMECO CORPORATION, SASKATOON, SASKATCHEWAN, CANADA:
2,547,357. CANC. INT. CL. 14.
- CAMM T, INC., CITY OF INDUSTRY, CA, DBA SKINNY DIP:
3,567,790. PUB. 11-11-2008. INT. CL. 25.
- CAMPAGNIE PLASTIC OMNIUM, LEVALLOIS CEDEX, FRANCE:
2,546,297. CANC. INT. CL. 17.
- CAMPBELL, GLENNIA R., PALO ALTO, CA AND BUTLER, STEFANIA P., PALO ALTO, CA:
3,567,301. PUB. 11-11-2008. INT. CL. 41.
- CAMPO, ANTHONY L., SANDY, UT:
2,547,995. CANC. INT. CL. 41.
- CAMPOS JR., JOSE, BROOKLYN, NY:
3,567,193. PUB. 11-11-2008. INT. CL. 35.
- CANADA BREAD FROZEN BAKERY LTD., LAVAL, CANADA:
3,567,755. PUB. 11-11-2008. INT. CL. 30.
3,567,756. PUB. 11-11-2008. INT. CL. 30.

CANADA CORDAGE INC., KITCHENER, ONTARIO, CANADA:
2,547,759, CANC. INT. CL. 1.

CANADUS POWER SYSTEMS, WARRENSVILLE, OH:
2,206,771, REN. 12-19-08. INT. CL. 9.

CANDELSHTICK, INC., NEW YORK, NY:
2,143,919, CANC. INT. CL. 4.

CANFIELD SCIENTIFIC, INC., FAIRFIELD, NJ:
3,567,516, PUB. 11-11-2008. INT. CL. 9.

CANNANDALE BICYCLE CORPORATION, BETHEL, CT:
2,222,572, REN. 12-20-08. INT. CL. 12.

CANTRELL, MARK EDWIN, WHEAT RIDGE, CO:
2,144,632, CANC. INT. CL. 28.

CANVAS CORP LLC, SPRINGDALE, AR:
3,566,631, PUB. 11-11-2008. MULTIPLE CLASS, INT. CLS. 16 AND 18.

CANYON CAPITAL ADVISORS LLC, LOS ANGELES, CA:
3,567,547, PUB. 11-11-2008. INT. CL. 36.

CAPEL ENTERPRISES, LLC, CANDLER, NC:
3,568,312, INT. CL. 39.

CAPINTEC, INC., RAMSEY, NJ:
1,107,119, REN. 12-20-08. INT. CL. 9.

CAPITAL BANCORP, MIAMI, FL TO REGIONS ASSET COMPANY, WILMINGTON, DE:
2,143,887, CANC. INT. CL. 36.

CAPITAL CHART ROOM LLC, THE, ARLINGTON, TX:
2,547,342, CANC. INT. CL. 36.

CAR CARE PARTS CORP., TAMPA, FL:
2,545,923, CANC. MULTIPLE CLASS, INT. CLS. 7, 9 AND 11.

CAR-MON PRODUCTS, INC., ELGIN, IL:
3,568,090, INT. CL. 7.

CARABINA, JAMES M., HINGHAM, MA:
2,545,723, CANC. INT. CL. 5.

CARDIFF ADVISORS, INC., DEL MAR, CA:
3,568,200, INT. CL. 25.

CARDINAL LABORATORIES, INC., BALDWIN PARK, CA:
3,566,330, PUB. 11-11-2008. MULTIPLE CLASS, INT. CLS. 3 AND 18.

CARDIOVASCULAR ASSOCIATES, P.C., KINGSPORT, TN:
3,566,921, PUB. 11-11-2008. INT. CL. 44.

CARE ON CALL FRANCHISE, INC., REDWOOD CITY, CA:
3,567,348, PUB. 11-11-2008. INT. CL. 45.

CAREERBUILDER, INC., RESTON, VA:
2,545,520, CANC. INT. CL. 35.

CARGILL, INCORPORATED, WAYZATA, MN:
2,213,455, REN. 12-23-08. INT. CL. 30.

CARL FREUDENBERG K.G., D-69469 WEINHEIM, FED REP GERMANY:
2,239,840, REN. 12-24-08. INT. CL. 21.

CARLSON LABORATORIES, ARLINGTON HEIGHTS, IL:
2,291,503, REN. 12-22-08. INT. CL. 5.

CAROLINA COTTON CANDY, LTD., SUMMERVILLE, SC:
3,567,404, PUB. 11-11-2008. INT. CL. 30.

CARPENTER, JOSEPH L., LAS VEGAS, NV:
3,568,160, MULTIPLE CLASS, INT. CLS. 35 AND 38.
3,568,161, MULTIPLE CLASS, INT. CLS. 35 AND 38.

CARRIAGE FUNERAL HOLDINGS, INC., HOUSTON, TX:
2,291,909, REN. 12-20-08. INT. CL. 42.

CARRIER, JANET, LEWISVILLE, TX:
2,547,012, CANC. INT. CL. 41.

CARTER, SHAWN, NEW YORK, NY:
3,568,293, INT. CL. 25.
3,568,294, INT. CL. 9.

CARVAJAL S.A., CALI, COLOMBIA:
3,568,665, INT. CL. 16.

CAS MEDICAL SYSTEMS, INC., BRANFORD, CT:
3,566,265, PUB. 11-11-2008. INT. CL. 10.

CASCADE COMMUNICATIONS VENTURES, L.L.C., LARK-SPUR, CA:
2,545,976, CANC. INT. CL. 36.

CASCADE DESIGNS, INC., SEATTLE, WA:
1,112,315, REN. 12-20-08. INT. CL. 20.

CASCADE YARNS, INC., TUKWILA, WA:
3,567,628, PUB. 11-11-2008. INT. CL. 23.

CASEY KURUTZ, NEW CASTLE, PA:
3,567,202, PUB. 11-11-2008. INT. CL. 25.
3,567,203, PUB. 11-11-2008. INT. CL. 25.

CASIMIR A. SWINGER, M.D., NEW YORK, NY:
3,566,672, PUB. 11-11-2008. INT. CL. 25.

CASIO KEISANKI KABUSHIKI KAISHA, SHINJUKU-KU, TOKYO, JAPAN, DBA CASIO COMPUTER CO., LTD.:
1,480,559, CANC. INT. CL. 9.

CASIO KEISANKI KABUSHIKI KAISHA, TOKYO, JAPAN, DBA CASIO COMPUTER CO., LTD.:
2,547,831, CANC. INT. CL. 14.

CASSARA, FRANK, RIVERHEAD, NY:
3,566,464, PUB. 11-11-2008. INT. CL. 9.

CASTER, 75008 PARIS, FRANCE:
2,548,033, CANC. INT. CL. 3.

CASTLE SPRINGS, LLC, MOULTONBOROUGH, NH:
2,546,059, CANC. INT. CL. 32.

CATACEL CORP., GARRETTSVILLE, OH:
3,568,176, INT. CL. 11.

CATERPILLAR INC., PEORIA, IL:
2,234,260, REN. 12-22-08. INT. CL. 25.
2,234,261, REN. 12-22-08. INT. CL. 25.

CAUTRE ENTERPRISE, HO CHI MINH CITY, VIETNAM:
2,546,774, CANC. MULTIPLE CLASS, INT. CLS. 29 AND 30.

CAVANAUGH, LUCILLE, LAS VEGAS, NV, DBA CHAR LU:
1,512,883, REN. 12-23-08. INT. CL. 28.

CBOCS PROPERTIES, INC., BELLEVILLE, MI:
3,566,675, PUB. 11-11-2008. MULTIPLE CLASS, INT. CLS. 29 AND 43.

CBS CORPORATION, NEW YORK, NY:
3,567,461, PUB. 11-11-2008. INT. CL. 38.

CBS STUDIOS INC., NEW YORK, NY:
1,098,210, REN. 12-19-08. INT. CL. 25.

CBT SUPPLY, INC., HIBERNIA, NJ:
3,568,244, INT. CL. 20.

CC OPERATIONS, LLC, LOUISVILLE, KY:
3,568,170, INT. CL. 36.

CCA GLOBAL PARTNERS, INC., EARTH CITY, MO:
2,145,027, CANC. INT. CL. 27.
3,566,786, PUB. 11-11-2008. INT. CL. 35.

CCM IP, S.A., CH-1005 LAUSANNE, SWITZERLAND:
1,551,192, REN. 12-19-08. INT. CL. 32.

CDMR, INC., CARLSBAD, CA:
3,568,516, INT. CL. 9.
3,568,517, INT. CL. 9.

CDT AUDIO, INC., BUELLTON, CA:
3,567,011, PUB. 11-11-2008. INT. CL. 9.

CECCHETTI SEBASTIANI CELLAR, INC., SONOMA, CA:
2,547,321, CANC. INT. CL. 33.

CELL SIGNALING TECHNOLOGY, INC., DANVERS, MA:
3,568,012, INT. CL. 1.

CELLHIRE PLC, YORK, UNITED KINGDOM:
3,566,408, PUB. 11-11-2008. MULTIPLE CLASS, INT. CLS. 9, 38 AND 41.

CELLULARSWAP, L.L.C., AUSTIN, TX:
3,566,295, PUB. 11-11-2008. INT. CL. 35.

CELTIC LIFE INSURANCE COMPANY, CHICAGO, IL:
1,481,047, CANC. INT. CL. 36.

CEMENTEX PRODUCTS, INC., BURLINGTON, NJ:
1,480,494, CANC. MULTIPLE CLASS, INT. CLS. 8 AND 40.

CENEGENICS LLC, LAS VEGAS, NV:
2,223,227, REN. 12-20-08. INT. CL. 42.

CENRO USA, LLC, HUNTSVILLE, AL:
3,568,545, INT. CL. 20.

CENTER FOR THE STUDY OF EXPERTISE IN TEACHING AND LEARNING, INC., FLORAL PARK, NY, DBA COMMUNITIES FOR LEARNING: LEADING LASTING CHANGE:
3,568,389, MULTIPLE CLASS, INT. CLS. 35 AND 41.

CENTER OF EXCELLENCE MEDIA, LLC, JAMESBURG, NJ:
3,567,112, PUB. 11-11-2008. INT. CL. 41.
3,567,116, PUB. 11-11-2008. INT. CL. 41.

CENTERSOURCE LIFESYSTEMS, ZANESVILLES, OH:
2,546,484, CANC. INT. CL. 5.

CENTIGAL INCORPORATED, ELK GROVE, CA, DBA HUGGABLE ME:
3,567,483, PUB. 11-11-2008. INT. CL. 35.

- CENTRAL BROADCASTING CORP., UTUADO, PUERTO RICO:
1,481,080, CANC. INT. CL. 38.
- CENTRAL CITY PRODUCTIONS, INC., CHICAGO, IL:
2,546,293, CANC. INT. CL. 38.
- CENTRAL COAST CHARTERS, INC., SAUSALITO, CA:
2,546,660, CANC. INT. CL. 41.
- CENTRAL FREIGHT LINES, INC., WACO, TX:
2,546,687, CANC. INT. CL. 39.
- CENTRAL GARDEN & PET COMPANY, WALNUT CREEK, CA:
2,208,949, REN. 12-19-08. INT. CL. 1.
- CENTRAL NEW MEXICO COMMUNITY COLLEGE, ALBUQUERQUE, NM:
3,567,254, PUB. 11-11-2008. INT. CL. 41.
- CENTRE NATIONAL D'ÉTUDES SPATIALES, PARIS, FRANCE:
3,567,816, PUB. 11-11-2008. MULTIPLE CLASS, INT. CLS. 9, 12, 38 AND 42.
- CENTURY INCORPORATED, MIDWEST CITY, OK:
2,548,285, CANC. INT. CL. 28.
- CEO SOFTWARE INCORPORATED, GLENDALE, CA, DBA STORYTELLER ONLINE:
2,548,611, CANC. INT. CL. 41.
- CERNICK, MATT, ENCINITAS, CA:
2,547,913, CANC. INT. CL. 25.
- CERRÉTA FOODS, GLENDALE, AZ:
2,291,187, REN. 12-20-08. INT. CL. 30.
- CERTAINTEED CORPORATION:
1,480,816, CANC. INT. CL. 19.
- CERVECERIA MODELO, S.A. DE C.V., MEXICO, D.F., MEXICO:
3,567,209, PUB. 11-11-2008. INT. CL. 32.
- CFS HOLDINGS B.V., NETHERLANDS:
3,567,810, PUB. 11-11-2008. MULTIPLE CLASS, INT. CLS. 7, 11, 16 AND 42.
- CHAMISAL VINEYARDS, LLC, NAPA, CA:
2,547,655, CANC. INT. CL. 33.
- CHAMPION MARKETING GROUP, LLC, HANOVER, MA:
3,567,245, PUB. 11-11-2008. INT. CL. 36.
- CHAMPION REALTY, LTD., LOS ANGELES, CA:
3,567,080, PUB. 11-11-2008. MULTIPLE CLASS, INT. CLS. 36 AND 37.
3,567,092, PUB. 11-11-2008. MULTIPLE CLASS, INT. CLS. 36 AND 37.
- CHANEY, KELLY COSTELLO, PITTSBURGH, PA:
3,568,377, INT. CL. 31.
- CHANG YOUNG CO., LTD., SEOUL, REPUBLIC OF KOREA:
2,545,508, CANC. INT. CL. 28.
- CHANG-TUH CORPORATION, SOUTH SALEM, OR:
2,547,320, CANC. INT. CL. 30.
- CHANG, LAWRENCE, HSINCHU HSIEN, TAIWAN:
2,548,153, CANC. INT. CL. 9.
- CHANGXING CHANGSHENG BATTERY CO., LTD, CHINA:
3,567,942, PUB. 11-11-2008. INT. CL. 9.
- CHANNEL ENABLERS USA, LLC, DUBLIN, CA:
3,566,405, PUB. 11-11-2008. INT. CL. 41.
3,566,407, PUB. 11-11-2008. INT. CL. 16.
- CHARLES RIVER APPAREL, INC., MEDFORD, MA:
3,568,055, INT. CL. 25.
3,568,056, INT. CL. 25.
3,568,057, INT. CL. 25.
- CHARTPAK, INC., MELVILLE, NY:
2,195,843, REN. 12-20-08. INT. CL. 2.
- CHEMCLEAN CORPORATION, MINEOLA, NY:
2,280,665, REN. 12-22-08. INT. CL. 3.
- CHEMCRAFT, INC., OVERLAND PARK, KS:
2,149,651, REN. 12-20-08. INT. CL. 1.
- CHEMDIV, INC., SAN DIEGO, CA, DBA CHEMICAL DIVERSITY:
3,566,637, PUB. 11-11-2008. MULTIPLE CLASS, INT. CLS. 1 AND 42.
- CHEMICAL PRODUCTS TECHNOLOGIES, LLC, CARTERSVILLE, GA:
2,547,313, CANC. INT. CL. 5.
- CHEN, QIU, CAMPBISENZIO FIRENZE, ITALY:
3,566,638, PUB. 11-11-2008. INT. CL. 18.
- CHEN, SHERI L., SOMERSET, NJ:
3,568,168, INT. CL. 25.
- CHERI'S FOODS, INC., NORCROSS, GA TO HICKORY HAMS, INC., ATLANTA, GA:
1,480,939, CANC. INT. CL. 29.
- CERRYHILL MANUFACTURING, CORP., PENN RUN, PA:
2,548,569, CANC. INT. CL. 7.
- CHERVON (CHINA) TRADING CO., LTD., CHINA:
3,567,963, PUB. 11-11-2008. INT. CL. 7.
- CHESAPEAKE WALLCOVERINGS CORPORATION, UPPER MARLBORO, MD:
2,548,406, CANC. INT. CL. 27.
- CHESWOLD CAPITAL GROUP LLC, PHILADELPHIA, PA:
3,568,415, INT. CL. 36.
- CHEVRON INTELLECTUAL PROPERTY LLC, SAN RAMON, CA:
3,568,107, INT. CL. 25.
- CHICAGO CUSTOM FOODS, ELK GROVE VILLAGE, IL:
2,289,015, REN. 12-24-08. INT. CL. 30.
- CHICAGO MERCANTILE EXCHANGE, CHICAGO, IL:
2,545,618, CANC. INT. CL. 41.
- CHICK-N-JOY SYSTEMS LIMITED, TORONTO, ONTARIO, CANADA:
3,567,736, PUB. 10-4-2005. INT. CL. 43.
- CHIEF EXECUTIVES ORGANIZATION, INC., BETHESDA, MD:
3,567,692, PUB. 11-11-2008. INT. CL. 41.
- CHILTON, SHAWN, WOODLAND HILLS, CA AND RUSSELL, RUSTY, WOODLAND HILLS, CA:
2,545,888, CANC. INT. CL. 25.
- CHIN, LILY, NEW YORK, NY:
3,568,578, INT. CL. 23.
- CHINA CLUB, LTD., NEW YORK, NY:
1,480,865, CANC. INT. CL. 25.
- CHINA INTERNATIONAL MARINE CONTAINERS (GROUP) CO., LTD., SHENZHEN CITY, GUANGDONG PROVINCE, CHINA:
2,548,053, CANC. INT. CL. 6.
- CHINA NATIONAL MACHINERY IMPORT & EXPORT CORPORATION, BEIJING BRANCH, BEIJING, CHINA:
1,480,487, CANC. MULTIPLE CLASS, INT. CLS. 8 AND 9.
- CHIQUITA BRANDS, INC., CINCINNATI, OH:
2,145,511, CANC. INT. CL. 32.
- CHLOE FOODS CORP., BROOKLYN, NY:
3,276,969, CANC. INT. CL. 30.
- CHOICEPOINT ASSET COMPANY LLC, ALPHARETTA, GA:
2,214,528, REN. 12-19-08. INT. CL. 42.
- CHORDIANT SOFTWARE, INC., CUPERTINO, CA:
2,547,972, CANC. INT. CL. 9.
- CHOUVALIS, EMILY, BOCA RATON, FL:
3,568,729, INT. CL. 14.
- CHOW, WARREN K., MASPETH, NY AND NADEAU, JOHN, MASPETH, NY:
3,167,894 NEW CERT. 1-27-2009. INT. CL. 41.
- CHR. HANSEN A/S, HORSHOLM, DENMARK:
1,482,127, REN. 12-24-08. MULTIPLE CLASS, INT. CLS. 5 AND 31.
1,483,980, REN. 12-23-08. MULTIPLE CLASS, INT. CLS. 5 AND 31.
- CHRIS EAGAN INVENTIONS, INC., LAS VEGAS, NV:
2,547,687, CANC. INT. CL. 8.
- CHRISTIAN BROADCASTING SYSTEM, LTD., FLINT, MI:
3,568,782, INT. CL. 38.
- CHRISTOPHER STREET FINANCIAL, INC., NEW YORK, NY:
2,546,886, CANC. INT. CL. 36.
- CHRISTOPHER YEE, MORTON GROVE, IL:
3,568,234, INT. CL. 14.
- CHS INC., INVER GROVE HEIGHTS, MN:
3,567,257, PUB. 11-11-2008. INT. CL. 42.
- CHURCH & DWIGHT CO., INC., PRINCETON, NJ:
1,108,346, REN. 12-23-08. INT. CL. 5.

- CIBA SPECIALTY CHEMICAL CORPORATION, TARRY-TOWN, NY:
2,547,585, CANC. INT. CL. 1.
- CIGARETTES CHEAPER!, BENICIA, CA:
2,546,523, CANC. INT. CL. 35.
- CIGNA INTELLECTUAL PROPERTY, INC., WILMINGTON, DE:
2,546,678, CANC. MULTIPLE CLASS, INT. CLS. 36 AND 42.
- CIM SYSTEMS INC., NOBLESVILLE, IN:
3,567,464, PUB. 11-11-2008. INT. CL. 7.
- CIMINOCARE, CITRUS HEIGHTS, CA:
3,567,232, PUB. 11-11-2008. MULTIPLE CLASS, INT. CLS. 43 AND 45.
- CINZZETTI'S RESTAURANT CORP., SCOTTSDALE, AZ:
3,567,214, PUB. 11-11-2008. INT. CL. 43.
- CIRCUIT TECHNOLOGY CENTER, INC., HAVERHILL, MA:
2,547,017, CANC. INT. CL. 16.
- CITIGROUP GLOBAL MARKETS INC., NEW YORK, NY, SHEARSON LEHMAN HUTTON INC., NEW YORK, NY:
1,515,752. REN. 12-19-08. INT. CL. 36.
- CITIZENS COMMERCIAL REAL ESTATE GROUP, INC., BEDFORD, TX:
2,545,970, CANC. INT. CL. 36.
- CITIZENS FINANCIAL GROUP, INC., PROVIDENCE, RI:
2,548,459, CANC. INT. CL. 36.
- CITY CENTER 55TH STREET THEATER FOUNDATION, INC., NEW YORK, NY:
2,546,923, CANC. INT. CL. 41.
- CITY OF ANGELS - MELROSE, LLC, LOS ANGELES, CA:
3,568,791, INT. CL. 35.
- CITY OF GLENDALE, ARIZONA, GLENDALE, AZ:
3,567,290, PUB. 11-11-2008. INT. CL. 35.
- CITY OF LITTLE ROCK, LITTLE ROCK, AR:
1,481,141, CANC. INT. CL. 42.
- CITY OF NEW BRAUNFELS, NEW BRAUNFELS, TX:
2,215,092. REN. 12-22-08. MULTIPLE CLASS, INT. CLS. 6, 14, 16, 21, 25, 26 AND 28.
- CITY OF NEW YORK BY AND THROUGH THE NEW YORK CITY TAXI AND LIMOUSINE COMMISSION, NEW YORK, NY:
3,568,318, INT. CL. 28.
- CITY OF SAN DIEGO, SAN DIEGO, CA:
2,775,069, CANC. INT. CL. 16.
- CITY OF SANDY SPRINGS, GEORGIA, SANDY SPRINGS, GA:
3,567,186, PUB. 11-11-2008. MULTIPLE CLASS, INT. CLS. 16, 35, 37, 41, 42 AND 45.
- CITY OF WEST DES MOINES, WEST DES MOINES, IA:
3,566,905, PUB. 11-11-2008. INT. CL. 16.
- CITY YEAR, INC., BOSTON, MA:
2,197,250. REN. 12-20-08. INT. CL. 41.
- CITYBLOCK, INC., SCOTTSDALE, AZ:
3,095,304, CANC. INT. CL. 36.
- CITYSKILLS, INC., WATERTOWN, MA:
2,546,824, CANC. INT. CL. 35.
- CLARIANT AG, MUTTENZ, SWITZERLAND:
2,206,385. REN. 12-19-08. INT. CL. 1.
2,206,385, CANC. INT. CL. 2.
2,546,681, CANC. INT. CL. 1.
- CLARK EQUIPMENT COMPANY, WEST FARGO, SD, SHERMAN PRODUCTS, INC., ROYAL OAK, MI:
670,566. REN. 12-22-08. U.S. CL. 23 (INT. CL. 7).
- CLARK EQUIPMENT COMPANY, WEST FARGO, ND:
1,110,470. REN. 12-22-08. INT. CL. 12.
- CLARK/BARDES, INC., NORTH BARRINGTON, IL:
2,547,046, CANC. INT. CL. 36.
- CLARK, MELANIE, PLANO, TX, DBA BD WEB BUILDERS:
3,567,043, PUB. 11-11-2008. INT. CL. 42.
- CLARKE/TRANSFORM, LLC, CHEVY CHASE, MD:
3,568,177, INT. CL. 9.
- CLARUS MEDICAL, LLC, MINNEAPOLIS, MN:
1,480,701, CANC. INT. CL. 10.
- CLASS EVENTS, LLC, LOS ANGELES, CA:
3,567,478, PUB. 11-11-2008. INT. CL. 35.
- CLASSIC URBAN HOMES STANFORD LP, DALLAS, TX:
3,567,212, PUB. 11-11-2008. INT. CL. 37.
- CLAUSE TEZIER, PORTES-LES-VALENCE, FRANCE:
3,566,628, PUB. 9-9-2008. INT. CL. 31.
- CLAWSON CUSTOM CUES, INC., JACKSONVILLE, FL:
3,568,230, INT. CL. 28.
- CLAY, WILLIE, BRONX, NY:
3,566,311, PUB. 11-11-2008. INT. CL. 25.
- CLEARSTATION, INC., SAN FRANCISCO, CA:
2,546,252, CANC. MULTIPLE CLASS, INT. CLS. 9, 21 AND 25.
- CLENAIR MANUFACTURING, INC., FORT WASHINGTON, PA:
3,566,707, PUB. 11-11-2008. INT. CL. 5.
- CLICKINSIGHT CORPORATION, TORONTO, ONTARIO, CANADA:
3,566,460, PUB. 11-11-2008. INT. CL. 35.
- CLICK4.COM, INC., ROSELAND, NJ:
2,545,792, CANC. INT. CL. 42.
- CLIMATE LEADERS FUND MANAGEMENT LTD., LONDON, UNITED KINGDOM:
3,566,526, PUB. 11-11-2008. INT. CL. 36.
- CLOCKWORK LEARNING CENTERS MANAGEMENT COMPANY, INC., STAMFORD, CT:
3,566,834, PUB. 11-11-2008. INT. CL. 43.
3,566,835, PUB. 11-11-2008. INT. CL. 43.
- CLOUD, DONALD E., SARASOTA, FL:
2,144,088, CANC. INT. CL. 8.
- CLOYES GEAR AND PRODUCTS, INC., FT. SMITH, AR:
3,566,995, PUB. 11-11-2008. INT. CL. 7.
- CLS, INC., LA CANADA, CA:
3,567,675, PUB. 11-11-2008. INT. CL. 18.
- CLUB MONACO CORP., TORONTO, ONTARIO M5V 1L5, CANADA:
2,545,523, CANC. MULTIPLE CLASS, INT. CLS. 3, 9, 14, 16, 18, 25 AND 28.
- CLUB ORIGINAL AMBATO, LOS ANGELES, CA:
3,566,469, PUB. 11-11-2008. INT. CL. 41.
- CLUBSPACES, INC., PLEASANTON, CA:
3,566,753, PUB. 11-11-2008. MULTIPLE CLASS, INT. CLS. 35, 38 AND 42.
- CM MITCHELL CONSULTING, GOLDEN, CO:
3,567,366, PUB. 11-11-2008. INT. CL. 35.
- CME AMERICA, LLC, GOLDEN, CO:
3,567,596, PUB. 11-11-2008. INT. CL. 10.
3,567,599, PUB. 11-11-2008. INT. CL. 10.
- CNA HOLDINGS, INC., DALLAS, TX, CELANESE CORPORATION OF AMERICA, NEW YORK, NY:
682,715. REN. 12-19-08. U.S. CL. 1 (INT. CLS. 1 AND 17).
- CNA HOLDINGS, INC., SUMMIT, NJ:
2,547,437, CANC. INT. CL. 23.
- CNL INTELLECTUAL PROPERTIES, INC., ORLANDO, FL:
3,568,465, INT. CL. 36.
3,568,466, INT. CL. 36.
3,568,483, INT. CL. 36.
- COACH USA, INC., HOUSTON, TX:
2,548,394, CANC. INT. CL. 39.
- COAST TO COAST WOUND CARE SURGEONS, INC., SUNNY ISLES BEACH, FL:
3,568,748, INT. CL. 44.
- COATS ENGINEERING, INC., MARCO ISLAND, FL:
3,566,883, PUB. 11-11-2008. INT. CL. 9.
- COBALT GROUP, INC., THE, SEATTLE, WA:
2,266,514. REN. 12-23-08. INT. CL. 42.
- COBB TUNING PRODUCTS, LLC, SALT LAKE CITY, UT:
3,566,371, PUB. 11-11-2008. MULTIPLE CLASS, INT. CLS. 9, 37, 40 AND 42.
- COCA-COLA COMPANY, THE, ATLANTA, GA:
1,480,841, CANC. INT. CL. 21.
- COCAVIN RIDGE, NEWPORT BEACH, CA:
3,567,554, PUB. 11-11-2008. MULTIPLE CLASS, INT. CLS. 33 AND 44.
- COCO COMMUNICATIONS CORP., SEATTLE, WA:
3,567,772, PUB. 5-29-2007. INT. CL. 38.
- COCOON HAIR STUDIO, LLC, NEW YORK, NY:
3,568,672, INT. CL. 3.
- CODEPINK ACTION FUND, VENICE, CA, DBA CODEPINK:
3,567,287, PUB. 11-11-2008. INT. CL. 35.
- COELLO, RENAN ALMENDAREZ, GLENDALE, CA:
2,546,242, CANC. INT. CL. 41.

- COFINLUXE, 75017 PARIS, FRANCE:
2,545,924, CANC. INT. CL. 3.
- COGNAC PAUL GIRAUD ET FILS SARL, CHATEAUNEUF-SURCHARENTE, FRANCE:
3,566,711, PUB. 11-11-2008. INT. CL. 33.
- COHEN, DONALD M., ALEXANDRIA, VA:
3,567,458, PUB. 11-11-2008. INT. CL. 22.
- COHOE, LIZ, NELSON, CANADA:
3,566,385, PUB. 11-11-2008. INT. CL. 25.
3,566,386, PUB. 11-11-2008. INT. CL. 25.
- COKER, FRANK H., MILWAUKEE, WI:
2,547,554, CANC. INT. CL. 41.
- COLAS, 92100 BOULOGNE-BILLANCOURT, FRANCE:
3,568,022, INT. CL. 37.
- COLD STONE CREAMERY, INC., SCOTTSDALE, AZ:
2,546,785, CANC. INT. CL. 35.
- COLEMAN CABLE, INC., WAUKEGAN, IL:
1,480,522, CANC. INT. CL. 9.
- COLEMAN COMPANY, INC., THE, WICHITA, KS:
1,480,570, CANC. INT. CL. 9.
- COLGATE-PALMOLIVE COMPANY, NEW YORK, NY:
2,144,473, CANC. INT. CL. 3.
- COLLABTECH INCORPORATED, MONTEREY, CA:
2,545,636, CANC. MULTIPLE CLASS, INT. CLS. 35 AND 42.
- COLLECTION 2000 COSMETICS, INC., MIAMI, FL:
2,208,193, REN. 12-20-08. INT. CL. 3.
- COLLEEN PALLADINI, TIGNALL, GA:
3,567,340, PUB. 11-11-2008. INT. CL. 16.
- COLLEGE DROPOUT, LOS ANGELES, CA:
3,566,467, PUB. 11-11-2008. INT. CL. 25.
- COLLEGE ENTRANCE EXAMINATION BOARD, NEW YORK, NY, DBA THE COLLEGE BOARD:
3,567,089, PUB. 11-11-2008. MULTIPLE CLASS, INT. CLS. 9 AND 41.
- COLLEGEWARE, U.S.A., INC., NEW YORK, NY:
3,566,827, PUB. 11-11-2008. INT. CL. 25.
- COLLINS, PAMELA, BIRMINGHAM, AL:
3,567,277, PUB. 11-11-2008. INT. CL. 25.
- COLONIAL MILLS, INC., PAWTUCKET, RI:
2,548,037, CANC. INT. CL. 27.
- COLONIAL SHOE, INC., KENNEBUNK, ME:
1,481,181, CANC. INT. CL. 42.
- COLOR METHODS, INC., ROCHESTER, NY, DBA CMI COMMUNICATIONS:
3,566,817, PUB. 11-11-2008. INT. CL. 41.
3,566,818, PUB. 11-11-2008. INT. CL. 41.
- COLORADO COMMUNITY LAND TRUST, DENVER, CO:
3,568,094, INT. CL. 36.
- COLORADO LOCAL GOVERNMENT LIQUID ASSET TRUST, DENVER, CO:
1,527,333, REN. 12-19-08. INT. CL. 36.
- COLUMBIA INSURANCE COMPANY, OMAHA, NE:
1,515,646, REN. 12-19-08. INT. CL. 30.
1,515,982, REN. 12-19-08. INT. CL. 42.
1,515,983, REN. 12-19-08. INT. CL. 42.
1,515,984, REN. 12-19-08. INT. CL. 42.
1,518,181, REN. 12-19-08. INT. CL. 30.
- COLUMBIA SPORTSWEAR NORTH AMERICA, INC., PORTLAND, OR:
2,145,465, CANC. INT. CL. 25.
- COLUMBIA TELECOMMUNICATIONS GROUP, INC., PORT WASHINGTON, NY:
2,547,493, CANC. INT. CL. 9.
- COMBE INCORPORATED, WHITE PLAINS, NY:
2,145,473, CANC. INT. CL. 5.
- COMFORT AUDIO, INC., CULVER CITY, CA:
3,566,312, PUB. 11-11-2008. INT. CL. 35.
- COMINT LEATHER GOODS, INC., ENGLEWOOD CLIFFS, NJ:
2,547,550, CANC. INT. CL. 25.
- COMMEMORATIVE BRANDS, INC., AUSTIN, TX:
2,547,627, CANC. INT. CL. 35.
- COMMISSION ON ACCREDITATION OF HEALTHCARE MANAGEMENT EDUCATION, ARLINGTON, VA:
3,566,365, PUB. 11-11-2008. U.S. CL. B.
- COMMUNICATION ECOLOGY, INC., NEW YORK, NY:
2,546,614, CANC. INT. CL. 35.
- COMMUNITY COFFEE COMPANY OF TEXAS, INC., HOUSTON, TX:
3,566,277, PUB. 11-11-2008. MULTIPLE CLASS, INT. CLS. 35 AND 43.
- COMMUNITY FOUNDATION OF NORTHWEST INDIANA, INC., MUNSTER, IN:
3,566,278, PUB. 11-11-2008. INT. CL. 44.
- COMNEON GMBH, NEURNBERG, FED REP GERMANY:
2,774,391, CANC. MULTIPLE CLASS, INT. CLS. 35 AND 38.
2,774,564, CANC. MULTIPLE CLASS, INT. CLS. 35 AND 38.
- COMPAGNIE FRANCAISE D'EAUX DE VIE ET SPIRITUEUX, 19500 COLLONGES LA ROUGE, FRANCE:
2,545,633, CANC. MULTIPLE CLASS, INT. CLS. 29 AND 30.
- COMPANION AIR CORPORATION, BOCA RATON, FL:
2,547,171, CANC. INT. CL. 39.
- COMPASS GROUP USA, INC., CHARLOTTE, NC:
3,568,078, MULTIPLE CLASS, INT. CLS. 43 AND 44.
- COMPETITOR GROUP, INC., SAN DIEGO, CA:
3,568,519, INT. CL. 41.
- COMPREHENSIVE MANUFACTURING SERVICES, LLC, ST. LOUIS, MO, GUILBERT, INCORPORATED, PHILADELPHIA 24, PA:
669,232, REN. 12-19-08. U.S. CL. 23 (INT. CL. 7).
- COMPTON'S NEWMEDIA, INC., CARLSBAD, CA:
1,480,578, CANC. INT. CL. 9.
- COMPUREDIT INTELLECTUAL PROPERTY HOLDINGS CORP. II, LAS VEGAS, NV:
3,566,720, PUB. 11-11-2008. INT. CL. 36.
- COMPUTER ASSOCIATES INTERNATIONAL, INC., JERICHO, NY:
1,480,506, CANC. INT. CL. 9.
- COMQUIP, INC., WEST CHESTER, PA:
2,545,759, CANC. INT. CL. 9.
- COMSO INCORPORATED, GREENBELT, MD:
2,280,457, REN. 12-19-08. INT. CL. 42.
- COMSTELLAR TECHNOLOGIES, INC., FLORHAM PARK, NJ:
2,546,800, CANC. MULTIPLE CLASS, INT. CLS. 35 AND 36.
- COMUNIDAD HUEVO, S.A. DE C.V., MEXICO, D.F., MEXICO:
3,566,634, PUB. 11-11-2008. INT. CL. 41.
- CON-WAY INC., SAN MATEO, CA:
2,145,098, CANC. INT. CL. 39.
2,546,006, CANC. INT. CL. 39.
- CONCERIA MONTEBELLO S.P.A., MONTEBELLO VICENTINO (VICENZA), ITALY:
1,490,186, REN. 12-22-08. INT. CL. 18.
- CONDEA SERVO B.V., 7491 AE DELDEN, NETHERLANDS:
2,545,650, CANC. INT. CL. 1.
- CONN-SELMER, INC., ELKHART, IN:
2,548,375, CANC. INT. CL. 15.
- CONNECTICUT STONE SUPPLIES, INC., MILFORD, CT:
2,546,235, CANC. MULTIPLE CLASS, INT. CLS. 19 AND 35.
- CONNECTIONS CORPORATION, ARLINGTON, VA:
2,545,852, CANC. INT. CL. 35.
- CONSERVAS ARTESANAS ROSARA, S.L., ANDOSILLA (NAVARRA), SPAIN:
3,568,172, INT. CL. 29.
- CONSERVATORY SENIOR RESIDENCES, LTD., DALLAS, TX:
3,566,685, PUB. 11-11-2008. MULTIPLE CLASS, INT. CLS. 41, 43, 44 AND 45.
- CONSOLIDATED BISCUIT CO., MCCOMB, OH:
3,567,160, PUB. 11-11-2008. INT. CL. 30.
3,567,161, PUB. 11-11-2008. INT. CL. 30.
- CONSOLIDATED PLASTICS COMPANY, INC., HUDSON, OH:
3,566,967, PUB. 11-11-2008. INT. CL. 27.
- CONSOLTEX INC., ST. LAURENT, QUEBEC, CANADA:
2,545,604, CANC. INT. CL. 24.
- CONSTELLATION AUSTRALIA LIMITED, REYNELLA, S.A., AUSTRALIA:
2,217,458, REN. 12-22-08. INT. CL. 33.

CONSTRUCTION RESEARCH & TECHNOLOGY GMBH, TROSTBERG, FED REP GERMANY:
1,480,344, CANC. INT. CL. 2.

CONTEC, LLC, SCHENECTADY, NY:
3,568,490, INT. CL. 9.

CONTINENTAL INDUSTRIES, INCORPORATED, TULSA, OK, DOING BUSINESS AS CONTINENTAL INDUSTRIES INC.:
673,389, REN. 12-22-08. U.S. CL. 14 (INT. CL. 6).

CONTOS, GEORGE, NEW YORK, NY AND PRYOR, NEIL, GREENWICH, CT:
3,567,728, PUB. 11-11-2008. INT. CL. 32.

CONTRACT APPAREL NETWORK, INC., ATLANTA, GA:
1,481,022, CANC. INT. CL. 35.

CONTROL DATA CANADA, LTD., MISSISSAUGA, ONTARIO, CANADA TO CONTROL DATA SYSTEMS CANADA LTD., OTTAWA, ONTARIO, CANADA:
1,480,762, CANC. MULTIPLE CLASS, INT. CLS. 16 AND 42.

CONTROL F CORPORATION, SANTA BARBARA, CA, DBA LOKT:
3,567,224, PUB. 11-11-2008. MULTIPLE CLASS, INT. CLS. 38 AND 39.

CONTROVERSY SELLS INC., MURRIETA, CA:
3,567,446, PUB. 11-11-2008. INT. CL. 25.

CONVERGENCE DATA, LLC, CHICAGO, IL:
2,546,972, CANC. INT. CL. 36.

CONVERTEAM GROUP, FRANCE:
3,567,839, PUB. 11-11-2008. MULTIPLE CLASS, INT. CLS. 7, 9, 37 AND 42.

CONWAY ENGINEERING, INC., OAKLAND, CA:
1,480,594, CANC. INT. CL. 9.

CONWAY, MARY, CLEVELAND HEIGHTS, OH:
3,568,567, INT. CL. 14.

CONXTECH, INC., HAYWARD, CA:
3,567,144, PUB. 11-11-2008. MULTIPLE CLASS, INT. CLS. 6, 37 AND 40.

COO, MATIAS, LOS ANGELES, CA:
2,915,795, CANC. INT. CL. 41.

COOCUU, INC., SANTA CLARA, CA:
3,566,703, PUB. 11-11-2008. INT. CL. 35.

COOK, TODD KENTON, ANTWERP, OH:
2,310,252, CANC. MULTIPLE CLASS, INT. CLS. 11 AND 35.

COOKTEK, LLC, CHICAGO, IL:
2,547,632, CANC. INT. CL. 21.

COOL SCHOOL INCENTIVES, INC., BECKER, MN:
3,566,955, PUB. 11-11-2008. INT. CL. 35.

COOLCOP, LLC, PASO ROBLES, CA:
3,568,262, INT. CL. 17.

COOPERVISION, INC., PLEASANTON, CA:
2,546,000, CANC. INT. CL. 9.
3,566,749, PUB. 11-11-2008. INT. CL. 9.

COPY HOLDER INC., CORTLAND, OH:
2,546,715, CANC. INT. CL. 16.

CORINNE MACPARTLAND, WICHITA, KS:
3,567,261, PUB. 11-11-2008. INT. CL. 30.

CORN PRODUCTS INTERNATIONAL, INC., WESTCHESTER, IL, CORN PRODUCTS REFINING COMPANY, NEW YORK, NY:
69,224, REN. 12-23-08. U.S. CL. 46 (INT. CL. 30).

CORNBREAD FOUNDATION, INC., THE, WASHINGTON, DC, DBA COCKTAIL CHARITIES, INC.:
2,546,459, CANC. INT. CL. 36.
2,546,460, CANC. INT. CL. 36.

CORNISH HERITAGE FARMS LLC, CHINOOK, MT, DBA CORNISH HERITAGE FARMS:
3,567,523, PUB. 11-11-2008. INT. CL. 16.

CORNOVA, INC., BURLINGTON, MA:
3,568,586, INT. CL. 10.

CORONADO GROUP, LTD., CHEVY CHASE, MD:
2,218,383, REN. 12-20-08. INT. CL. 42.

CORPORACIÓN CHURRO MANIA C.A., LAS MERCEDES, VENEZUELA:
3,566,682, PUB. 11-11-2008. INT. CL. 30.
3,566,683, PUB. 11-11-2008. INT. CL. 30.
3,566,684, PUB. 11-11-2008. INT. CL. 30.

CORPORATE DEFENSE STRATEGIES, MAYWOOD, NJ:
2,547,087, CANC. INT. CL. 42.

CORPORATION SERVICE COMPANY, WILMINGTON, DE:
2,546,995, CANC. INT. CL. 42.

CORRECT CRAFT, INC., ORLANDO, FL:
3,566,254, PUB. 8-6-2002. MULTIPLE CLASS, INT. CLS. 12, 18 AND 25.
3,566,255, PUB. 1-22-2002. MULTIPLE CLASS, INT. CLS. 12, 18 AND 25.

CORRUGATED CHEMICALS, INC., CINCINNATI, OH:
1,480,317, CANC. INT. CL. 1.

COSBY, WILLIAM H., JR., SANTA MONICA, CA:
2,546,594, CANC. INT. CL. 25.
2,546,595, CANC. INT. CL. 25.
2,546,596, CANC. INT. CL. 25.

COSBY, WILLIAM J., JR., SANTA MONICA, CA:
2,546,597, CANC. INT. CL. 25.

COSINE COMMUNICATIONS, INC., REDWOOD CITY, CA:
2,546,181, CANC. INT. CL. 9.

COSMO BIO CO., LTD., JAPAN:
3,567,814, PUB. 11-11-2008. MULTIPLE CLASS, INT. CLS. 1, 5, 9, 10, 35, 41 AND 42.

COSMOPRO, INC., DAYTONA BEACH, FL:
3,568,419, INT. CL. 3.

COST HOUSE SAS, FRANCE:
3,567,955, PUB. 11-11-2008. INT. CL. 35.

COSTA DEL MAR SUNGLASSES, INC., ORMOND BEACH, FL:
2,545,499, CANC. INT. CL. 9.

COSTCO WHOLESALE MEMBERSHIP, INC., ISSAQUAH, WA:
2,545,922, CANC. INT. CL. 38.

COTTINGHAM & BUTLER INSURANCE SERVICES, INC., DUBUQUE, IA:
2,197,835, REN. 12-22-08. INT. CL. 36.

COTTON, STANLEY S., CATHEDRAL CITY, CA:
3,566,482, PUB. 11-11-2008. INT. CL. 4.

COTY INC., DANBURY, CT:
1,480,349, CANC. INT. CL. 3.

COUNCIL OF PETROLEUM ACCOUNTANTS SOCIETIES, INC. (COPAS), DENVER, CO:
3,566,586, PUB. 11-11-2008. U.S. CL. B.

COUNTRY LIFE, LLC, HAUPPAUGE, NY:
2,547,123, CANC. INT. CL. 30.

COUNTRYWIDE CREDIT INDUSTRIES, INC., CALABASAS, CA:
2,547,668, CANC. INT. CL. 36.
2,548,060, CANC. INT. CL. 36.

COURSE CRAFTERS, INC., NEWBURYPORT, MA:
2,547,503, CANC. INT. CL. 16.
2,547,504, CANC. INT. CL. 9.

COVANCE INC., PRINCETON, NJ:
3,567,640, PUB. 11-11-2008. INT. CL. 42.

COVERALL NORTH AMERICA, INC., BOCA RATON, FL:
2,204,464, REN. 12-23-08. INT. CL. 37.

COVET 18K, INC., ATLANTA, GA:
3,567,351, PUB. 11-11-2008. INT. CL. 14.

COVIDIEN AG, NEUHAUSEN AM RHEINFALL, SWITZERLAND:
3,566,508, PUB. 11-11-2008. MULTIPLE CLASS, INT. CLS. 1, 5, 9, 10, 16 AND 41.

COWAN SYSTEMS, LLC, BALTIMORE, MD:
2,546,341, CANC. INT. CL. 39.

COY JR., ARTHUR, HOUSTON, TX:
3,567,035, PUB. 11-11-2008. INT. CL. 25.

COÖPERATIEVE ZUIVELONDERNEMING CONO B.A., 1464 MB BEEMSTER, NETHERLANDS:
3,566,584, PUB. 11-11-2008. INT. CL. 29.

CPINGREDIENTS, LLC, GOLDEN, CO, TA GTC NUTRITION:
3,567,724, PUB. 11-13-2007. INT. CL. 5.

CPM MEDIA LLC, MANHASSET, NY:
2,548,457, CANC. INT. CL. 41.

CRANSWICK PREMIUM WINES LIMITED, NEW SOUTH WALES 2680, AUSTRALIA:
2,546,280, CANC. INT. CL. 33.

- CRARY, BUCHANAN, BOWDISH, BOVIE, ELDER & WIL-
LIAMSON, STUART, FL:
3,567,271, PUB. 11-11-2008. INT. CL. 45.
- CRAWFISH TOWN U.S.A., INC., BREAUX BRIDGE, LA:
3,566,340, PUB. 11-11-2008. INT. CL. 43.
- CRAWFORD AND COMPANY, ATLANTA, GA:
3,566,433, PUB. 11-11-2008. MULTIPLE CLASS, INT. CLS.
35, 37 AND 42.
- CREAMERY CORPORATION, THE, ANCHORAGE, AK:
2,545,908, CANC. INT. CL. 29.
- CREATIVE BATH PRODUCTS, INC., CENTRAL ISLIP, NY:
2,548,525, CANC. INT. CL. 21.
- CREATIVE BROADCAST CONCEPTS, BIDDEFORD, ME:
2,546,776, CANC. INT. CL. 35.
- CREATIVE EVENTS GROUP, L.P., THE, NEW YORK, NY:
2,144,624, CANC. INT. CL. 42.
- CREMIEUX, STÉPHANE, PARIS, FRANCE:
3,567,749, PUB. 3-25-2008. MULTIPLE CLASS, INT. CLS.
2, 3, 4, 8, 9, 14, 16, 18, 20, 21, 24, 25, 26, 27 AND 44.
- CRENSHAW, DAVID M., EAGLE MOUNTAIN, UT:
3,567,216, PUB. 11-11-2008. MULTIPLE CLASS, INT. CLS.
9, 35 AND 41.
- CRESSIE, JAMES T., CHICAGO, IL:
2,548,039, CANC. INT. CL. 9.
- CRESTECH, L.L.C., MILTON, WA:
2,144,004, CANC. INT. CL. 9.
- CRI 2000, L.P., SAN DIEGO, CA:
3,568,520, INT. CL. 16.
- CRISTAL SOLUTIONS, INC., BEVERLY HILLS, CA:
3,568,393, INT. CL. 35.
- CRITICAL MASS MEDIA, INC., CINCINNATI, OH:
1,524,782, REN. 12-19-08. INT. CL. 35.
- CRODA INTERNATIONAL PLC, UNITED KINGDOM:
3,567,961, PUB. 11-11-2008. INT. CL. 1.
3,567,962, PUB. 11-11-2008. INT. CL. 1.
- CROREY, DAVID J., CLINTON TOWNSHIP, MI:
3,568,089, INT. CL. 9.
- CROSSLINK TECHNOLOGY, ONTARIO, CANADA:
3,568,131, INT. CL. 2.
- CROSSPORT MOCEAN, COSTA MESA, CA:
3,566,266, PUB. 11-11-2008. INT. CL. 25.
- CROW-ERICKSON, INC., ASHEVILLE, NC:
3,568,717, INT. CL. 16.
- CROWN AMERICAN PROPERTIES, L.P., JOHNSTOWN, PA:
2,547,013, CANC. INT. CL. 35.
- CROWN CRAFTERS CORPORATION, GREENWICH, CT:
2,547,588, CANC. INT. CL. 42.
- CROWN CREATIVE CO., LTD., ADACHI-KU; TOKYO,
JAPAN:
3,567,904, PUB. 11-11-2008. MULTIPLE CLASS, INT. CLS.
9, 14, 16, 18, 24, 25 AND 28.
- CROWN TEXTILE COMPANY, JENINKTOWN, PA:
1,480,849, CANC. INT. CL. 24.
- CRUMRINE GOLD & SILVERSMITHS, RENO, NV:
2,546,636, CANC. INT. CL. 14.
- CRYSTAL GROUP, INC., HIAWATHA, IA:
2,547,232, CANC. INT. CL. 35.
- CSC BRANDS LP, CAMDEN, NJ:
3,283,902, CANC. INT. CL. 29.
- CST INDUSTRIES, INC., KANSIS CITY, KS:
2,144,574, CANC. INT. CL. 6.
- CSX IA, INC., JACKSONVILLE, FL:
3,567,764, PUB. 11-11-2008. INT. CL. 16.
- CTB WIRELESS, INC., PASADENA, CA:
2,547,038, CANC. INT. CL. 35.
- CTF DEVELOPMENT, INC., CORAL GABLES, FL:
3,568,660, INT. CL. 43.
- CTR PAYROLL COMPANY, WARRENDALE, PA:
2,545,990, CANC. INT. CL. 42.
- CTRAC COMPUTER SERVICES, INC., STRONGSVILLE,
OH, DBA C.TRAC INFORMATION SOLUTIONS:
3,568,065, INT. CL. 35.
- CTSNET, INC., BALTIMORE, MD, SOCIETY OF THORACIC
SURGEONS, THE, CHICAGO, IL:
2,231,810, REN. 12-24-08. INT. CL. 42.
- CUBE SOLUTIONS, L.L.C., DALLAS, TX:
3,568,639, INT. CL. 20.
- CULINAERIE DC LLC, WASHINGTON, DC:
3,568,266, INT. CL. 41.
- CULINARY CONCEPTS, LLC, SAN ANTONIO, TX:
3,568,441, INT. CL. 43.
- CULINARY MASTERS, INC., ALPHARETTA, GA:
2,546,370, CANC. INT. CL. 35.
- CURRENT INC., EAST HAVEN, CT:
3,567,779, PUB. 9-25-2007. INT. CL. 2.
- CUSOLITO, RICHARD, WESTLAKE VILLAGE, CA:
3,568,054, INT. CL. 25.
- CUSTOM BUILDING PRODUCTS, INC., SEAL BEACH, CA:
2,205,005, REN. 12-23-08. INT. CL. 19.
- CUSTOM COOLING & REFRIGERATION, INC., LAS VE-
GAS, NV:
3,567,126, PUB. 11-11-2008. INT. CL. 37.
- CUSTOM SOLUTIONS, INC., INDIALANTIC, FL:
2,546,392, CANC. INT. CL. 9.
- CVS PHARMACY, INC., WOONSOCKET, RI:
2,546,452, CANC. INT. CL. 28.
- CYBER TRADING, INC., MCLEAN, VA:
2,548,559, CANC. INT. CL. 42.
- CYBER-CARE, INC., BOYNTON BEACH, FL:
2,545,840, CANC. INT. CL. 38.
- CYBERCARE, INC., BOYNTON BEACH, FL:
2,545,839, CANC. INT. CL. 38.
- CYBERSOURCE CORPORATION, MOUNTAIN VIEW, CA:
2,144,171, CANC. INT. CL. 9.
- CYCON, DEAN, ORANGE, MA:
3,568,380, INT. CL. 16.
- CYGNUS BUSINESS MEDIA, INC., FORT ATKINSON, WI:
3,568,780, INT. CL. 16.
- CYLINK CORPORATION, SUNNYVALE, CA:
1,480,552, CANC. INT. CL. 9.
- CYTRANZ, INC., INDIANAPOLIS, IN:
2,547,417, CANC. INT. CL. 42.
- CYTYC CORPORATION, MARLBOROUGH, MA:
3,568,059, MULTIPLE CLASS, INT. CLS. 1, 5, 9 AND 10.
- CZ VETERINARIA, S.A., PORRIÑO (PONTEVEDRA),
SPAIN:
3,567,276, PUB. 11-11-2008. INT. CL. 5.
- D & F EQUIPMENT SALES, INC., CROSSVILLE, AL:
3,566,829, PUB. 11-11-2008. INT. CL. 7.
- D.E.S. STUDIO INC., MONTREAL (ST-LAURENT), CANA-
DA:
3,567,147, PUB. 11-11-2008. INT. CL. 25.
- D.R. INTELLECTUAL PROPERTIES, INC., PAUL, ID:
3,566,979, PUB. 11-11-2008. INT. CL. 11.
3,566,984, PUB. 11-11-2008. INT. CL. 7.
- D-1280, INC., WILMINGTON, CA:
2,545,677, CANC. INT. CL. 4.
- D'ANGELO BRANDS LTD., MISSISSAUGA, CANADA:
3,567,776, PUB. 5-13-2008. INT. CL. 32.
- DA EMPIRE ENTERTAINMENT GROUP, LLC, MERRILL-
VILLE, IN:
3,566,597, PUB. 11-11-2008. INT. CL. 41.
- DAEWOO MOTOR CO., LTD., INCHON, REPUBLIC OF
KOREA:
2,545,997, CANC. INT. CL. 12.
- DAIGLE, RICHARD A., THIBODAU, LA:
3,568,777, INT. CL. 22.
- DAIHAN SCIENTIFIC CO., LTD., SEOUL 136-120, REPUB-
LIC OF KOREA:
3,568,171, INT. CL. 9.
- DAIKIN INDUSTRIES, LTD., KITA-KU, OSAKA, JAPAN:
3,566,758, PUB. 11-11-2008. INT. CL. 1.
- DAIMLER TRUCKS NORTH AMERICA LLC, PORTLAND,
OR:
3,566,258, PUB. 11-11-2008. INT. CL. 7.
- DAINIPPON SCREEN MFG. CO., LTD., KYOTO 602-8585,
JAPAN:
3,566,308, PUB. 11-11-2008. INT. CL. 9.
- DAKA CORPORATION, PINE CITY, MN:
3,568,123, INT. CL. 6.
- DAKITAB, INC., WEST BLOOMFIELD, MI:
3,568,530, INT. CL. 35.
- DALLCO MARKETING, INC., DALLAS, TX:
2,656,218, COR. INT. CL. 8.

DALTON, ERIC L., NAPLES, FL AND POLLEY, WILLIAM F., NAPLES, FL:
3,568,126, MULTIPLE CLASS, INT. CLS. 6 AND 19.

DAM SPORT, LLC, OAKLAND, CA:
3,566,828, PUB. 11-11-2008. INT. CL. 25.

DAN-DEE INTERNATIONAL LIMITED, JERSEY CITY, NJ:
2,208,959. REN. 12-23-08. MULTIPLE CLASS, INT. CLS. 16 AND 28.
2,209,093. REN. 12-23-08. INT. CL. 28.

DAN-FOAM APS, AARUP, DENMARK:
3,567,703, PUB. 11-11-2008. INT. CL. 20.
3,567,704, PUB. 11-11-2008. INT. CL. 20.
3,567,705, PUB. 11-11-2008. INT. CL. 20.
3,567,706, PUB. 11-11-2008. INT. CL. 20.

DANA-FARBER CANCER INSTITUTE, INC., BOSTON, MA:
1,533,590. REN. 12-20-08. INT. CL. 36.

DANCE PAWS, LLC, CAMBRIDGE, MA:
3,568,102, INT. CL. 25.

DANIEL LUX, NEW YORK, NY:
3,566,787, PUB. 11-11-2008. INT. CL. 16.

DANIEL P. GAY, SAGINAW, MI:
3,568,189, INT. CL. 41.

DANNER, DAVID JESSE, PALM SPRINGS, CA:
2,548,497, CANC. INT. CL. 42.

DANROY CORP., PALM DESERT, CA, DBA DANIELS RESTORATION:
3,567,071, PUB. 11-11-2008. INT. CL. 37.

DANYA INTERNATIONAL, INC., SILVER SPRING, MD:
2,546,268, CANC. INT. CL. 42.

DAPHNE CONTRAROS RIOUX, SACO, ME:
3,567,159, PUB. 11-11-2008. INT. CL. 30.

DARAUX ANGELA, FRANCE:
3,567,856, PUB. 11-11-2008. MULTIPLE CLASS, INT. CLS. 11, 20 AND 21.

DARKSTRAND, INC., PEORIA, IL:
3,566,688, PUB. 11-11-2008. MULTIPLE CLASS, INT. CLS. 35 AND 42.

DARLINGTON RACEWAY OF SOUTH CAROLINA, LLC, DAYTONA BEACH, FL:
2,217,013. REN. 12-22-08. MULTIPLE CLASS, INT. CLS. 16, 21, 24, 25 AND 28.

DARNIGOLD FOREST, LLC, MARIETTA, GA:
3,567,456, PUB. 11-11-2008. INT. CL. 40.

DARREL R. CALHOUN, ASHVILLE, AL:
3,568,657, INT. CL. 20.

DAS, DEEPA, CEDAR GROVE, NJ AND DAS, MUNISH, CEDAR GROVE, NJ:
3,567,502, PUB. 11-11-2008. INT. CL. 44.

DASSAULT SYSTEMES ENOVIA CORP., LOWELL, MA:
2,212,711. REN. 12-22-08. INT. CL. 9.

DATA EXCHANGE, INC., RICHARDSON, TX:
2,546,219, CANC. INT. CL. 38.

DATAKINETICS LIMITED, HAMPSHIRE SP6 1HU, UNITED KINGDOM:
2,545,906, CANC. INT. CL. 9.

DATCO INTERNATIONAL, INC., HAZEL PARK, MI:
2,546,116, CANC. INT. CL. 21.

DAVE & JERRY'S, INC., WAYLAND, MA:
2,545,514, CANC. INT. CL. 30.

DAVID LIVINGSTON, CHINO HILLS, CA, DBA THE ACAPPELLA PARTNERSHIP LLC:
3,566,580, PUB. 11-11-2008. INT. CL. 41.

DAVID POURBABA, LOS ANGELES, CA:
3,568,658, INT. CL. 37.

DAVID RAVANDI, BEVERLY HILLS, CA:
3,566,848, PUB. 11-11-2008. INT. CL. 33.

DAVID SAMS INDUSTRIES, INC., BEVERLY HILLS, CA:
2,545,880, CANC. INT. CL. 42.

DAVIS, BRAD, GILBERT, AZ:
3,566,437, PUB. 9-25-2007. INT. CL. 37.

DAVIS, DEBBY CANTO, ARCHDALE, VA:
2,144,526, CANC. MULTIPLE CLASS, INT. CLS. 35 AND 42.

DAVIS, JERRY JR., PEORIA, IL:
2,547,717, CANC. INT. CL. 28.

DAY PITNEY LLP, NEW YORK, NY:
3,568,563, INT. CL. 35.

DAYTON T. BROWN INC., BOHEMIA, NY:
3,568,104, INT. CL. 42.

DBR FRANCHISING, LLC, BOUND BROOK, NJ:
1,514,093. REN. 12-23-08. INT. CL. 42.

DCAEV, INC., LAS VEGAS, NV:
3,567,258, PUB. 11-11-2008. INT. CL. 35.

DCI CHEESE COMPANY, INC., DALLAS, TX:
1,480,920, CANC. INT. CL. 29.

DCI CHEESE COMPANY, INC., RICHFIELD, WI:
3,568,552, INT. CL. 29.

DD4HIRE, INC., BOARDMAN, OH:
3,567,507, PUB. 11-11-2008. INT. CL. 39.
3,567,526, PUB. 11-11-2008. INT. CL. 39.

DE LA RUE SYSTEMS GMBH, MORFELDEN-WALLDORF, FED REP GERMANY:
3,567,793, PUB. 4-8-2008. INT. CL. 9.

DE MATTEIS AGROALIMENTARE S.P.A., ITALY:
3,294,338, COR. INT. CL. 29.

DEAN, LESTER M., KANSAS CITY, MO:
3,568,455, INT. CL. 2.

DEARBORN FINANCIAL PUBLISHING, INC., CHICAGO, IL:
2,144,298, CANC. INT. CL. 9.

DEBORAH WOOD ASSOCIATES, INC., CARMEL, IN:
3,566,481, PUB. 11-11-2008. INT. CL. 35.

DECATHLON, 5965 VILLENEUVE D'ASCQ, FRANCE:
2,547,469, CANC. MULTIPLE CLASS, INT. CLS. 9 AND 28.

DECIPHER INC., NORFOLK, VA:
2,547,889, CANC. INT. CL. 28.

DECO PATENTS, INC., EDISON, NJ:
2,547,694, CANC. MULTIPLE CLASS, INT. CLS. 2 AND 42.

DECOY MOTION MASTERS, ROGERS, MN:
3,566,294, PUB. 11-11-2008. INT. CL. 28.

DEEPLY ROOTED, LLC, MANHATTAN BEACH, CA:
3,566,782, PUB. 11-11-2008. INT. CL. 25.

DEEPSEA POWER & LIGHT, INC., SAN DIEGO, CA:
2,548,374, CANC. INT. CL. 9.

DEF CON COMMUNICATIONS, INC., SEATTLE, WA:
3,107,144, COR. INT. CL. 9.

DEFLINA RESTAURANT, INC., SAN FRANCISCO, CA:
3,567,300, PUB. 11-11-2008. INT. CL. 43.

DEGREE CONTROLS, INC., MILFORD, NH:
3,568,207, INT. CL. 11.

DEHAVEN, JOHN V., ST. PETERSBURG, FL, DBA AAA EMPLOYMENT:
1,563,711. REN. 12-22-08. INT. CL. 35.
1,564,986. REN. 12-22-08. INT. CL. 35.

DEI HEADQUARTERS, INC, VISTA, CA:
2,248,575. REN. 12-19-08. INT. CL. 9.

DEL FERRO INSTITUTE B.V., NETHERLANDS:
2,546,156, CANC. MULTIPLE CLASS, INT. CLS. 41 AND 42.

DEL MONTE CORPORATION, SAN FRANCISCO, CA, JERKY TREATS, INC., EL PASO, TX:
1,108,864. REN. 12-19-08. INT. CL. 31.

DEL MONTE CORPORATION, SAN FRANCISCO, CA:
1,481,000, CANC. INT. CL. 32.

DEL-RAIN CORPORATION, NIAGARA FALLS, NY:
2,545,487, CANC. INT. CL. 11.

DELALLA, PAUL V, JR., EMERSON, NJ:
3,566,578, PUB. 11-11-2008. INT. CL. 35.

DELANO FARMS COMPANY, DELANO, CA:
3,568,329, INT. CL. 31.

DELANO GROUP SECURITIES, WILMETTE, IL:
2,546,568, CANC. INT. CL. 36.

DELANO MOTOR CENTER, INC., DELANO, MN:
3,566,336, PUB. 11-11-2008. INT. CL. 35.

DELETTREZ S.R.L., ITALY:
3,567,866, PUB. 11-11-2008. MULTIPLE CLASS, INT. CLS. 14, 18 AND 25.

DELL INC., ROUND ROCK, TX:
2,545,844, CANC. MULTIPLE CLASS, INT. CLS. 41 AND 42.

DELPHILINK LLC, MOUNTAIN VIEW, CA:
3,568,650, MULTIPLE CLASS, INT. CLS. 38 AND 42.

- DELTA ALPHA CHI, INC., OKLAHOMA CITY, OK:
3,568,295, U.S. CL. 200.
3,568,296, U.S. CL. 200.
- DELTA CONSOLIDATE INDUSTRIES, INC., RALEIGH, NC:
2,547,650, CANC. INT. CL. 12.
- DELTA NETWORKS, INC., NEIHU TAIPEI, TAIWAN:
2,143,986, CANC. INT. CL. 9.
- DELTEK SYSTEMS, INC., MCLEAN, VA:
2,547,994, CANC. INT. CL. 9.
- DELUXE ENTERPRISE OPERATIONS, INC., SHOREVIEW, MN:
2,144,146, CANC. INT. CL. 35.
2,212,062, REN. 12-20-08. INT. CL. 42.
- DEMINOR INTERNATIONAL SOCIETE COOPERATIVE A RESPONSABILITE LIMITEE (CO-OPERATIVE LIMITED LIABILITY COMPANY), BRUSSELS, BELGIUM:
2,221,514, REN. 12-23-08. MULTIPLE CLASS, INT. CLS. 36 AND 42.
- DEMIURGE STUDIOS, INC., CAMBRIDGE, MA:
3,567,001, PUB. 11-11-2008. MULTIPLE CLASS, INT. CLS. 9 AND 41.
- DEMSONS, LLC, PEWAUKEE, WI:
3,566,328, PUB. 11-11-2008. INT. CL. 4.
- DENALI FLAVORS, L.L.C., HILLSDALE, MI TO DENALI CO., L.L.C., WAYLAND, MI:
2,145,510, CANC. INT. CL. 30.
- DENDINORA LLC, ANGIN, CA:
3,568,408, INT. CL. 33.
- DENIM APPAREL GROUP, INC., NORTHBROOK, IL:
2,548,500, CANC. INT. CL. 25.
- DENSO CORPORATION, KARIYA-CITY, AICHI-PREF, JAPAN:
2,545,739, CANC. INT. CL. 9.
- DENTAL/MEDICAL DIAGNOSTIC SYSTEMS, INC., WOODLAND HILLS, CA:
2,546,240, CANC. MULTIPLE CLASS, INT. CLS. 9 AND 10.
2,546,253, CANC. MULTIPLE CLASS, INT. CLS. 9 AND 10.
2,546,254, CANC. MULTIPLE CLASS, INT. CLS. 9 AND 10.
- DENTSPLY INTERNATIONAL INC., YORK, PA:
3,567,672, PUB. 11-11-2008. INT. CL. 9.
- DERBY INDUSTRIES, INC., LOUISVILLE, KY:
1,480,837, CANC. INT. CL. 21.
- DEREK BECKER, MOUNTAIN CITY, TN, DBA BECKER LABS:
2,546,434, CANC. INT. CL. 2.
- DESAI, NANDKISHORE, WALNUT CREEK, CA, DBA DESAI TECHNOLOGIES:
2,546,377, CANC. INT. CL. 9.
- DESCENTE, LTD., JAPAN:
3,567,798, PUB. 10-21-2008. MULTIPLE CLASS, INT. CLS. 18 AND 25.
- DESCHAINED, DAVID J., SOUTH PORTLAND, ME:
3,567,042, PUB. 11-11-2008. INT. CL. 37.
- DESIGNER SKIN, LLC, INDIANAPOLIS, IN:
3,567,626, PUB. 11-11-2008. INT. CL. 3.
3,567,627, PUB. 11-11-2008. INT. CL. 3.
3,568,409, INT. CL. 3.
- DESIGNS & MARKS INC., CONCORD, ONTARIO, CANADA:
2,547,860, CANC. INT. CL. 24.
- DESTILADORA DE LOS ALTOS S.A. DE C.V., ARANDAS, MEXICO:
3,568,523, INT. CL. 33.
- DESTINATION HOTELS AND RESORTS, INC., LOS ANGELES, CA:
2,199,532, REN. 12-22-08. MULTIPLE CLASS, INT. CLS. 35 AND 41.
- DESTINY HEALTH SERVICES PTY LTD, AUSTRALIA:
3,567,803, PUB. 11-11-2008. INT. CL. 41.
- DETAILS COMMUNICATIONS, INC., BIRMINGHAM, AL:
2,546,744, CANC. MULTIPLE CLASS, INT. CLS. 35 AND 42.
- DETERING, VOLKER, NEW YORK, NY:
2,547,433, CANC. INT. CL. 35.
- DETICA LIMITED, GUILDFORD, SURREY, UNITED KINGDOM:
3,566,396, PUB. 7-22-2008. MULTIPLE CLASS, INT. CLS. 9, 35, 37, 41 AND 42.
3,566,397, PUB. 7-22-2008. MULTIPLE CLASS, INT. CLS. 9, 16 AND 41.
- DEUTSCHE TELEKOM, BONN, FED REP GERMANY:
3,566,819, PUB. 9-2-2008. INT. CL. 35.
3,566,836, PUB. 9-9-2008. INT. CL. 38.
- DEUTSCHE TELEKOM AG, BONN, FED REP GERMANY:
3,566,511, PUB. 7-8-2008. INT. CL. 16.
3,566,517, PUB. 3-4-2008. INT. CL. 16.
- DEUTSCHE TELEKOM AG, BONN 53113, FED REP GERMANY:
3,566,556, PUB. 6-10-2008. INT. CL. 16.
3,566,557, PUB. 3-4-2008. INT. CL. 16.
- DEUTSCHE TELEKOM AG, BONN, FED REP GERMANY:
3,566,663, PUB. 5-20-2008. INT. CL. 38.
- DEVELOPMENT DIMENSIONS INTERNATIONAL, INC., BRIDGEVILLE, PA:
2,547,740, CANC. INT. CL. 41.
- DEVILS AND ANGELS LIMITED, WALTHAMSTOW, LONDON, UNITED KINGDOM:
3,567,796, PUB. 3-11-2008. MULTIPLE CLASS, INT. CLS. 9 AND 14.
- DEVON, L.L.C., SKOKIE, IL:
2,144,707, CANC. INT. CL. 42.
- DEZIGNARE' INTERIOR DESIGN COLLECTIVE, INC., AUSTIN, TX:
3,567,396, PUB. 11-11-2008. INT. CL. 35.
- DHANRAJ IMPORTS, INC, RIVERSIDE, CA:
3,567,693, PUB. 11-11-2008. INT. CL. 34.
- DIACENTRE, INC., NEW YORK, NY:
3,566,375, PUB. 11-11-2008. INT. CL. 14.
- DIAGEO BRANDS B.V., AMSTERDAM, NETHERLANDS:
2,145,428, CANC. INT. CL. 18.
- DIAL BRANDS, INC., SCOTTSDALE, AZ:
2,546,244, CANC. INT. CL. 5.
2,547,197, CANC. INT. CL. 3.
- DIAMOND BAKERY COMPANY, LTD., HONOLULU, HI:
1,480,982, CANC. INT. CL. 30.
- DIAMOND BRANDS OPERATING CORP., CLOQUET, MN:
2,547,274, CANC. INT. CL. 20.
- DIAMOND EQUIPMENT COMPANY, LTD., ROCKDALE, TX:
2,548,347, CANC. INT. CL. 2.
- DIAMOND FINANCIAL SERVICES, INC., RALEIGH, NC:
3,566,796, PUB. 11-11-2008. MULTIPLE CLASS, INT. CLS. 35 AND 36.
- DICK'S SPORTING GOODS, INC., PITTSBURGH, PA:
3,567,716, PUB. 11-11-2008. INT. CL. 28.
- DIEBOLD, INCORPORATED, NORTH CANTON, OH:
3,568,433, INT. CL. 9.
- DIETRICH DAVID WAYNE, ASSINIBOIA, CANADA:
3,566,497, PUB. 9-9-2008. INT. CL. 7.
- DIGIMARC CORPORATION, TUALATIN, OR:
2,548,492, CANC. INT. CL. 9.
- DIGITAL COMMERCE INTERNATIONAL, INC., SALT LAKE CITY, UT:
2,546,013, CANC. INT. CL. 36.
- DIGITAL IMS, INC., LINCOLN, NE:
3,567,683, PUB. 11-11-2008. INT. CL. 40.
3,567,684, PUB. 11-11-2008. INT. CL. 40.
3,567,685, PUB. 11-11-2008. INT. CL. 40.
- DIGIUM, INC., HUNTSVILLE, AL:
3,567,249, PUB. 11-11-2008. MULTIPLE CLASS, INT. CLS. 9 AND 42.
- DIME SAVINGS BANK OF NEW YORK, FSB, THE, NEW YORK, NY:
2,547,583, CANC. INT. CL. 36.
- DIME SAVINGS BANK OF WILLIAMSBURGH, THE, BROOKLYN, NY:
2,547,439, CANC. INT. CL. 36.
- DINAS CORP., MASPETH, NY:
3,567,501, PUB. 11-11-2008. INT. CL. 29.
- DINESOL PLASTICS, INC., NILES, OH:
3,567,524, PUB. 11-11-2008. INT. CL. 40.

DIRECT IMAGES INTERACTIVE, INC., SAN LEANDRO, CA:
 3,566,693, PUB. 11-11-2008. MULTIPLE CLASS, INT. CLS. 41 AND 42.
 3,566,718, PUB. 11-11-2008. MULTIPLE CLASS, INT. CLS. 41 AND 42.

DIRECT MARKETING TECHNOLOGIES LIMITED, GALWAY, IRELAND:
 2,547,562, CANC. INT. CL. 9.

DIRECTMARKETINGWORKS.COM, INC., DALLAS, TX:
 2,548,585, CANC. INT. CL. 35.

DIRECTV, INC., EL SEGUNDO, CA:
 2,547,145, CANC. INT. CL. 16.

DISCOVERY COMMUNICATIONS, INC., BETHESDA, MD:
 2,547,031, CANC. INT. CL. 41.

DISCOVERY COMMUNICATIONS, LLC, SILVER SPRING, MD:
 3,568,619, MULTIPLE CLASS, INT. CLS. 9, 16 AND 25.

DISCRETE DISTRIBUTION, L.L.C., IRVINE, CA:
 2,546,640, CANC. MULTIPLE CLASS, INT. CLS. 18 AND 25.

DISHRANK LTD., TAIPEI CITY, TAIWAN:
 3,568,341, INT. CL. 38.

DISNEY ENTERPRISES, INC., BURBANK, CA:
 3,568,706, INT. CL. 9.

DISPLAY TECHNOLOGIES, LLC, COLLEGE POINT, NY:
 2,224,765, REN. 12-20-08. MULTIPLE CLASS, INT. CLS. 16 AND 20.

DISPLAYTECH, INC., LONGMONT, CO:
 2,546,134, CANC. INT. CL. 9.

DISPLAYWARE LLC, SEATTLE, WA:
 3,567,440, PUB. 11-11-2008. INT. CL. 35.
 3,567,441, PUB. 11-11-2008. INT. CL. 9.
 3,567,442, PUB. 11-11-2008. INT. CL. 9.

DISTLER MICHAEL J., KEMAH, TX:
 3,568,498, INT. CL. 10.

DISTRIBUTION C.M.P. MAGADA INTERNATIONAL INC., BROSSARD, PQ J4Y 3A5, CANADA:
 2,144,201, CANC. MULTIPLE CLASS, INT. CLS. 9, 35 AND 41.

DISTRIBUTIVE EDUCATION CLUBS OF AMERICA, INC., RESTON, VA:
 2,271,957, REN. 12-20-08. MULTIPLE CLASS, U.S. CL. 20 INT. CLS. 6, 20 AND 26.

DIVENAV, INC., TUSTIN, CA:
 3,568,783, INT. CL. 42.

DIVERSITECH GENERAL, INC., AKRON, OH:
 1,480,881, CANC. INT. CL. 27.

DIXON TICONDEROGA COMPANY, HEATHROW, FL:
 1,533,078, REN. 12-23-08. INT. CL. 16.

DIZOGLIO, FRANK P., III, JAMESTOWN, RI:
 2,547,024, CANC. MULTIPLE CLASS, INT. CLS. 16 AND 21.

DLJJ & ASSOCIATES, LLC, BEVERLY HILLS, CA:
 3,568,240, MULTIPLE CLASS, INT. CLS. 18 AND 21.

DO SOMETHING, INC., NEW YORK, NY:
 2,144,269, CANC. INT. CL. 42.
 2,545,848, CANC. INT. CL. 41.

DOG TRAXX PARTNERS, SPARTANBURG, SC:
 2,523,439, CANC. INT. CL. 6.

DOLAN MEDIA COMPANY, MINNEAPOLIS, MN:
 3,568,732, INT. CL. 45.

DOLLAR GENERAL MERCHANDISING, INC., GOODLETTSVILLE, TN:
 2,546,014, CANC. INT. CL. 25.

DOLNICK, BARRIE, NEW YORK, NY:
 2,546,447, CANC. INT. CL. 42.

DOMAINE SELECT WINE ESTATES, LLC, NEW YORK, NY:
 2,239,571, REN. 12-19-08. INT. CL. 33.

DOME HEALING CENTER, INC, FERNANDINA BEACH, FL:
 2,547,409, CANC. INT. CL. 9.

DOMINEX, LC, ELKTON, FL:
 2,548,323, CANC. INT. CL. 29.

DOMINIO DE EGUREN, S.L., SPAIN:
 3,567,990, PUB. 11-11-2008. INT. CL. 33.

DOMINION RESOURCES, INC, RICHMOND, VA:
 2,546,016, CANC. MULTIPLE CLASS, INT. CLS. 37, 39, 40 AND 42.

DONOVAN INDUSTRIES, INC., TAMPA, FL:
 3,566,303, PUB. 11-11-2008. INT. CL. 3.

DORCHESTER PUBLISHING CO., INC., NEW YORK, NY:
 1,529,693, REN. 12-20-08. INT. CL. 16.

DORNER MFG. CORP., HARTLAND, WI:
 2,547,578, CANC. INT. CL. 7.

DOSKOCIL MANUFACTURING COMPANY, INC., ARLINGTON, TX:
 2,145,448, CANC. INT. CL. 19.
 3,566,287, PUB. 11-11-2008. MULTIPLE CLASS, INT. CLS. 18, 20 AND 21.

DOUBLE K INDUSTRIES, INC., CHATSWORTH, CA:
 2,198,707, REN. 12-20-08. MULTIPLE CLASS, INT. CLS. 3 AND 5.

DOUBLETEX, MONTREAL, QUEBEC, CANADA:
 2,208,059, REN. 12-19-08. INT. CL. 24.

DOUGLASS, HARLEY C., COLBERT, WA:
 3,568,347, INT. CL. 39.

DOVEBID, INC., FOSTER CITY, CA:
 2,546,425, CANC. INT. CL. 35.

DOVETAIL SOLUTIONS INC., DENVER, CO:
 3,566,752, PUB. 11-11-2008. INT. CL. 35.

DOW CHEMICAL COMPANY, THE, MIDLAND, MI:
 1,521,288, REN. 12-20-08. INT. CL. 41.
 1,521,422, REN. 12-20-08. INT. CL. 1.

DOW JONES & COMPANY, INC., NEW YORK, NY:
 2,218,001, REN. 12-22-08. INT. CL. 16.
 3,568,522, MULTIPLE CLASS, INT. CLS. 9, 16 AND 41.

DR. ING MAX SCHLOTTER GMBH & CO. KG, D-73312 GEISLINGEN/STEIGE, FED REP GERMANY:
 2,545,899, CANC. INT. CL. 1.

DR. JAMES L. GEIGER, M.D., OILMD, P.C., GILBERT, AZ:
 3,568,654, INT. CL. 3.

DRAGON RIVER RESOURCES, INC., SINGAPORE, SINGAPORE:
 2,144,704, CANC. MULTIPLE CLASS, INT. CLS. 41 AND 42.

DRAGON SYSTEMS, INC., MA:
 1,480,575, CANC. INT. CL. 9.
 1,480,769, CANC. INT. CL. 16.

DRAGON SYSTEMS, INC., NEWTON, MA:
 1,480,770, CANC. INT. CL. 16.

DRAPER, INC., SPICELAND, IN:
 3,567,062, PUB. 11-11-2008. INT. CL. 40.

DRAWLOOP TECHNOLOGIES, INC., TAMPA, FL:
 3,568,298, INT. CL. 42.

DREAMERZ FOODS, INC., SAN FRANCISCO, CA:
 3,567,465, PUB. 11-11-2008. INT. CL. 5.

DREAMSITE PRODUCTIONS INC., LOS ANGELES, CA:
 2,547,652, CANC. INT. CL. 25.
 2,547,654, CANC. INT. CL. 9.

DREAMWELL, LTD., LAS VEGAS, NV:
 2,144,887, CANC. INT. CL. 20.
 2,547,898, CANC. INT. CL. 20.

DREAMWORKS ANIMATION L.L.C., GLENDALE, CA:
 3,502,340, COR. MULTIPLE CLASS, INT. CLS. 9, 16, 25, 28 AND 41.

DREAMY CALENDARS LLC, LAS VEGAS, NV:
 3,568,781, INT. CL. 16.

DRY COTTONWOOD LLC DBA BIG SKY GEMS, BAKER CITY, OR, DBA BIG SKY GEMS:
 2,547,447, CANC. INT. CL. 14.

DSD HOMES, INC., LEHIGH ACRES, FL:
 3,566,495, PUB. 11-11-2008. MULTIPLE CLASS, INT. CLS. 36 AND 37.
 3,566,496, PUB. 11-11-2008. MULTIPLE CLASS, INT. CLS. 36 AND 37.

DSHEALTHCARE INC., YORK, PA:
 1,504,747, REN. 12-20-08. INT. CL. 10.

DSJ INTERNATIONAL, INC., EL MONTE, CA:
 2,546,500, CANC. INT. CL. 12.

DUCHESNEAU, JULIE N., COLUMBIA, SC AND DUCHESNEAU, SCOTT W., COLUMBIA, SC:
 3,567,235, PUB. 11-11-2008. INT. CL. 41.

DUCKARRI INC., TAHOE CITY, CA:
 2,547,425, CANC. INT. CL. 25.

- DUCKWALL, BYRON, WESTWOOD, MA:
2,547,032, CANC. INT. CL. 41.
- DUGERY, ERIN, NEWTOWN SQUARE, PA AND DAY,
KELLY, BRYN MAWR, PA:
3,568,656, INT. CL. 25.
- DUKE'S FIREHOSE COMPANY, INC., FRAZER, PA:
2,546,940, CANC. INT. CL. 37.
- DUNWOODIE, DAVID, DELTA, CANADA:
3,567,265, PUB. 11-11-2008. INT. CL. 15.
- DURANGO & SILVERTON NARROW GAUGE RAILROAD,
INC., DURANGO, CO:
2,547,218, CANC. INT. CL. 41.
2,547,219, CANC. INT. CL. 25.
- DURO DYNE CORPORATION, FARMINGDALE, NY:
1,109,290, REN. 12-20-08. INT. CL. 11.
1,518,637, REN. 12-20-08. INT. CL. 6.
- DW GROUP, LLC, CHICAGO, IL:
2,546,976, CANC. INT. CL. 42.
- DYER PROPERTIES LLC, ST. PETERSBURG, FL:
3,568,531, INT. CL. 35.
- DYNACRAFT BSC, INC., AMERICAN CANYON, CA:
2,145,509, CANC. INT. CL. 12.
- DYNAVET, 6300 CLERMONT-FERRAND, FRANCE:
3,566,623, PUB. 11-11-2008. MULTIPLE CLASS, INT. CLS.
9 AND 18.
- E. & J. GALLO WINERY, MODESTO, CA:
3,567,686, PUB. 11-11-2008. INT. CL. 33.
- E. I. DU PONT DE NEMOURS AND COMPANY, WILMING-
TON, DE:
2,195,771, REN. 12-23-08. INT. CL. 1.
- E. I. DU PONT DE NEMOURS AND COMPANY, WILMING-
TON,, DE:
2,211,869, REN. 12-23-08. INT. CL. 9.
- E.PROMOTIONS, INC., SAVANNAH, GA:
2,547,057, CANC. INT. CL. 35.
- E! ENTERTAINMENT TELEVISION, INC., LOS ANGELES,
CA:
2,547,844, CANC. INT. CL. 16.
- E*TRADE SECURITIES, INC., MENLO PARK, CA:
2,547,921, CANC. INT. CL. 36.
- E-BRANDS RESTAURANTS LLC, ORLANDO, FL:
2,548,445, CANC. INT. CL. 42.
- E-COMM-TECH.COM, INC., PEORIA, IL:
2,546,832, CANC. INT. CL. 41.
- E-TEL CORPORATION, WEST WARWICK, RI:
2,548,561, CANC. MULTIPLE CLASS, INT. CLS. 9 AND
42.
- E-TRANSPORT, INC., PITTSBURGH, PA:
2,546,882, CANC. INT. CL. 40.
- EAGENCY, INC., NEWPORT BEACH, CA:
3,567,334, PUB. 11-11-2008. MULTIPLE CLASS, INT. CLS.
9 AND 45.
- EARLE, EYVIND A., CARMEL, CA:
2,545,773, CANC. INT. CL. 16.
2,545,774, CANC. INT. CL. 9.
- EARLYCHILDHOOD, LLC, MONTEREY, CA:
2,546,836, CANC. MULTIPLE CLASS, INT. CLS. 41 AND
42.
- EARRINGMASTER, INC., LAS VEGAS, NV:
3,566,843, PUB. 11-11-2008. INT. CL. 21.
- EARTH CHEMICAL COMPANY LIMITED, CHIYODA-KU,
TOKYO, JAPAN:
3,566,521, PUB. 4-8-2008. INT. CL. 21.
- EARTHSKY COMMUNICATIONS, INC., AUSTIN, TX, DBA
BYRD AND BLOCK COMMUNICATIONS, INC.:
3,567,206, PUB. 11-11-2008. MULTIPLE CLASS, INT. CLS.
9 AND 41.
3,567,707, PUB. 11-11-2008. MULTIPLE CLASS, INT. CLS.
9 AND 41.
- EAST & ORIENT COMPANY, DALLAS, TX:
2,547,673, CANC. MULTIPLE CLASS, INT. CLS. 3 AND 4.
- EAST LION CORPORATION, CITY OF INDUSTRY, CA:
3,567,174, PUB. 11-11-2008. INT. CL. 25.
- EAST TENNESSEE .NET USERS GROUP, INC, KNOX-
VILLE, TN:
3,567,298, PUB. 11-11-2008. INT. CL. 41.
- EAST-WEST DISTRIBUTING CO., DEERFIELD, IL:
3,566,333, PUB. 11-11-2008. INT. CL. 33.
- EASTERN OUTLOOK, LLC, CHICAGO, IL:
2,545,987, CANC. INT. CL. 42.
- EASY & BUSY LTD, CHAIWAN, HONG KONG:
3,567,236, PUB. 11-11-2008. INT. CL. 30.
- EASY BUSINESS SERVICES, LLC, CAPE CORAL, FL:
3,567,164, PUB. 11-11-2008. INT. CL. 35.
- EAT 'N PARK HOSPITALITY GROUP, INC., HOMESTEAD,
PA:
2,234,823, REN. 12-19-08. INT. CL. 30.
- EATALY SRL, ITALY AND EATALY DISTRIBUZIONE SRL,
ITALY:
3,567,939, PUB. 11-11-2008. INT. CL. 41.
- EATON CORPORATION, CLEVELAND, OH TO DANA
LIMITED, TOLEDO, OH:
2,145,295, CANC. INT. CL. 12.
- EATWELL ENTERPRISES, L.P., NEW YORK, NY:
2,144,623, CANC. INT. CL. 30.
- EBAGS.COM, GREENWOOD VILLAGE, CO:
3,568,211, INT. CL. 38.
- EBAY INC., SAN JOSE, CA:
2,547,742, CANC. INT. CL. 35.
- EBERLE, GERHARD, 82211 HERRSCHING, FED REP GER-
MANY AND EBERLE, STEFAN, 82211 HERRSCHING,
FED REP GERMANY AND STARK, ROBERT, 82205
GILCHING, FED REP GERMANY:
2,547,725, CANC. INT. CL. 9.
- EBEWE PHARMA GES.M.B.H. NFG. KG, AUSTRIA:
3,151,117, COR. INT. CL. 5.
- EBSCO INDUSTRIES, INC., BIRMINGHAM, AL:
3,568,404, INT. CL. 41.
- ECHOING GREEN FOUNDATION, NEW YORK, NY:
3,566,555, PUB. 11-11-2008. MULTIPLE CLASS, INT. CLS.
35 AND 41.
- ECOLAB INC., ST. PAUL, MN, PENNSALT CHEMICALS
CORPORATION, PHILADELPHIA, PA:
672,023, REN. 12-19-08. U.S. CL. 6 (INT. CL. 3).
- ECONOMICS CONSULTANTS OREGON, LTD., EUGENE,
OR:
3,566,293, PUB. 11-11-2008. MULTIPLE CLASS, INT. CLS.
35, 39, 42 AND 45.
- ECOQUEST INTERNATIONAL, INC., GREENEVILLE, TN:
3,568,202, INT. CL. 11.
- ECOTECH, INC., DENVER, NC:
2,763,432, CANC. INT. CL. 4.
- ECOUSABLE, INC., REDONDO BEACH, CA:
3,567,427, PUB. 11-11-2008. INT. CL. 21.
- EDENTIFY, INC., BETHLEHEM, PA:
2,547,714, CANC. INT. CL. 42.
- EDGE QUEST, INC., LAKEVIEW TERRACE, CA:
2,144,900, CANC. INT. CL. 25.
- EDIBLE ARRANGEMENTS, LLC, WALLINGFORD, CT:
3,567,721, PUB. 11-11-2008. MULTIPLE CLASS, INT. CLS.
29 AND 30.
3,568,774, INT. CL. 30.
- EDITORIA EL SIGLO, S.A., SANTO DOMINGO, DOMINI-
CAN REP:
2,546,558, CANC. INT. CL. 16.
- EDMUNDS, GREGORY, ATLANTA, GA, DBA PRINCE
YACONIAH:
3,566,548, PUB. 11-11-2008. INT. CL. 16.
- EDUCATIONAL MEDIA, LLC, STAMFORD, CT:
2,548,173, CANC. INT. CL. 16.
- EDWARD DOMANSKIS, NEWPORT BEACH, CA:
3,567,392, PUB. 11-11-2008. INT. CL. 3.
- EDWARD LOWE FOUNDATION, CASSOPOLIS, MI:
2,547,974, CANC. INT. CL. 16.
- EGGZACK.COM, LLC, FLEMINGTON, NJ:
3,567,023, PUB. 11-11-2008. INT. CL. 35.
- EIDOS INTERACTIVE LTD., LONDON, UNITED KING-
DOM:
2,546,035, CANC. MULTIPLE CLASS, INT. CLS. 16, 25
AND 28.
- EINSTEIN MEDICAL, INC., LA JOLLA, CA:
2,545,936, CANC. INT. CL. 35.
2,545,937, CANC. INT. CL. 35.

EINSTEIN/NOAH BAGEL PARTNERS, INC., LAKEWOOD, CO. EINSTEIN/NOAH BAGEL PARTNERS, INC., LAKEWOOD, CO:
2,227,589. REN. 12-19-08. INT. CL. 42.
2,237,393. REN. 12-19-08. INT. CL. 30.

EISAI, INC., WOODCLIFF LAKE, NJ:
2,548,203. CANC. INT. CL. 5.

EJENDOMSSSELSKABET 2000 APS, DK-6100 HADERSLEV, DENMARK:
3,567,881. PUB. 11-11-2008. MULTIPLE CLASS, INT. CLS. 12, 25 AND 39.

EJ4 LLC, ST. LOUIS, MO:
3,566,709. PUB. 11-11-2008. INT. CL. 9.

EKISS, BRIAN, GRANITE BAY, CA AND EKISS, MARY, GRANITE BAY, CA:
3,568,159. INT. CL. 44.

EL PASO ELECTRIC COMPANY, EL PASO, TX:
2,547,618. CANC. INT. CL. 39.

EL REGALO.COM, INC., MIAMI, FL:
2,545,986. CANC. INT. CL. 35.

ELA MEDICAL, 92120 MONTROUGE, FRANCE:
2,546,926. CANC. INT. CL. 10.
2,546,927. CANC. INT. CL. 10.

ELCON INSTRUMENTS, INC., ANNAPOLIS, MD:
1,480,622. CANC. INT. CL. 9.

ELDORADO STONE OPERATIONS LLC, SOUTH JORDAN, UT:
3,311,629. COR. INT. CL. 19.

ELECTRA-LIGHT MANUFACTURING, INC., GARLAND, TX:
3,567,467. PUB. 11-11-2008. INT. CL. 10.

ELECTRIC VISUAL EVOLUTION, LLC, SAN CLEMENTE, CA:
2,548,204. CANC. INT. CL. 9.

ELECTRO-VOICE, INCORPORATED, BUCHANAN, MI:
1,480,566. CANC. INT. CL. 9.

ELEME MEDICAL INC., MERRIMACK, NH:
3,568,242. MULTIPLE CLASS, INT. CLS. 10 AND 44.

ELIAS, LORENZO ALFREDO, LA QUINTA, CA, DBA HEALTHY TRANSFORMATIONS:
3,566,629. PUB. 11-11-2008. INT. CL. 44.

ELICIT ENTERTAINMENT, LLC, HANOVER, MD:
3,567,048. PUB. 11-11-2008. INT. CL. 41.

ELINGTON, MARY W., EL CAJON, CA:
2,144,051. CANC. INT. CL. 42.

ELISA OYJ, FINLAND:
3,567,895. PUB. 11-11-2008. INT. CL. 9.
3,567,896. PUB. 11-11-2008. INT. CL. 9.

ELITE SA LLC, MORRISTOWN, NJ:
3,567,283. PUB. 11-11-2008. INT. CL. 41.

ELIZABETH BRADBERRY, LLC, FAYETTEVILLE, AR, DBA JERSERUT GAMEDAY CHIC:
3,566,630. PUB. 11-11-2008. INT. CL. 25.

ELKAY MANUFACTURING COMPANY, OAK BROOK, IL:
1,111,279. REN. 12-24-08. INT. CL. 11.

ELLIS, SUSAN, QUAKERTOWN, PA:
2,547,253. CANC. INT. CL. 14.

ELMER'S INVESTMENTS LLC, WILMINGTON, DE, T.M.I. ASSOCIATES, L.P., WILMINGTON, DE:
2,239,290. REN. 12-20-08. MULTIPLE CLASS, INT. CLS. 8 AND 16.

ELMER'S INVESTMENTS LLC, COLUMBUS, OH:
2,246,272. REN. 12-20-08. MULTIPLE CLASS, INT. CLS. 1, 2 AND 16.

ELMORE, STEVEN, OSWEGO, IL:
2,547,278. CANC. INT. CL. 28.

ELOF AB, SE-824 34 HUDIKSVALL, SWEDEN:
3,567,882. PUB. 11-11-2008. INT. CL. 12.

ELSNER PAC JUNGPFANZEN GBR, DRESDEN, FED REP GERMANY:
3,568,500. INT. CL. 31.

ELSTER PERFECTION CORPORATION, MADISON, OH:
1,105,573. REN. 12-22-08. INT. CL. 11.

EMBARK CORP., SAN FRANCISCO, CA:
2,547,894. CANC. MULTIPLE CLASS, INT. CLS. 36, 41 AND 42.

EMBOTICS CORPORATION, KANATA, ONTARIO, CANADA:
3,568,062. MULTIPLE CLASS, INT. CLS. 9 AND 42.

EMC CORPORATION, HOPKINTON, MA:
2,545,598. CANC. INT. CL. 9.

EMERSON RADIO CORP., PARSIPPANY, NJ:
2,548,024. CANC. INT. CL. 11.

EMILIO PUCCI INTERNATIONAL BV, NL-3743 KN BAARN, NETHERLANDS:
3,567,853. PUB. 11-11-2008. INT. CL. 25.

EMOTION, LLC, SEATTLE, WA:
2,548,575. CANC. MULTIPLE CLASS, INT. CLS. 35 AND 39.

EMPOWEREDBENEFITS, LLC, CHARLOTTE, NC:
3,568,750. MULTIPLE CLASS, INT. CLS. 9 AND 42.

EMSOURCE, INC., PORTLAND, ME:
2,261,125. REN. 12-24-08. INT. CL. 36.

ENCOMIUM DATA INTERNATIONAL, INC., INDEPENDENCE, OH:
2,292,705. REN. 12-20-08. INT. CL. 9.

ENCORE CONSTRUCTION CO., INC., DENNISPORT, MA:
3,566,982. PUB. 11-11-2008. INT. CL. 37.

ENCORE WIRE CORPORATION, MCKINNEY, TX:
2,263,692. REN. 12-19-08. INT. CL. 9.

ENDECE, LLC, MEQUON, WI:
3,567,445. PUB. 11-11-2008. INT. CL. 42.
3,567,679. PUB. 11-11-2008. INT. CL. 42.

ENDGAME ENTERPRISES, LLC, WESTMINSTER, CO:
3,568,518. INT. CL. 41.

ENDURE ENERGY, L.L.C., OVERLAND PARK,, KS:
3,567,086. PUB. 11-11-2008. INT. CL. 36.

ENDRUST TECHNOLOGIES INC., MONTREAL, CANADA:
3,567,778. PUB. 11-11-2008. INT. CL. 2.

ENERCOM, INC., ATLANTA, GA:
2,547,486. CANC. MULTIPLE CLASS, INT. CLS. 35 AND 37.

ENERGY MACHINERY, INC., ROCKLAND, MA:
1,517,460. REN. 12-20-08. INT. CL. 37.

ENERGY POTENTIAL AB.; ORG NR. 556614-9000, SWEDEN:
3,567,950. PUB. 11-11-2008. MULTIPLE CLASS, INT. CLS. 35, 36 AND 42.

ENERGYLED CORPORATION, SINDIAN CITY, TAIPEI COUNTY, TAIWAN:
3,568,366. INT. CL. 9.

ENERGYSEAL AIR BARRIER SYSTEMS, MCCALL, ID:
3,568,368. INT. CL. 17.

ENGINEERING DESIGN AUTOMATION, WALNUT CREEK, CA, SSD, INC., BERKELEY, CA:
1,503,746. REN. 12-23-08. INT. CL. 9.

ENGMAN-TAYLOR COMPANY, INC., MEMONONEE FALLS, WI:
3,568,382. MULTIPLE CLASS, INT. CLS. 35 AND 42.
3,568,383. MULTIPLE CLASS, INT. CLS. 35 AND 42.

ENHANCE INTERNATIONAL, INC., ROSWELL, GA:
2,547,222. CANC. INT. CL. 5.

ENIGMA DIAGNOSTICS LIMITED, SALISBURY, UNITED KINGDOM:
3,567,763. PUB. 11-11-2008. MULTIPLE CLASS, INT. CLS. 1, 5, 9 AND 10.

ENKEI INTERNATIONAL, INC., FORT WORTH, TX:
2,547,184. CANC. INT. CL. 12.

ENNIS, INC., MIDLOTHIAN, TX:
2,546,565. CANC. INT. CL. 35.

ENOFORUM - COMERCIO E EXPORTACAO DE VINHOS, S.A., 7005-482 EVORA, PORTUGAL:
3,566,768. PUB. 11-11-2008. INT. CL. 33.

ENSTO OY, 06150 PROVVOO, FINLAND:
2,667,970. CANC. INT. CL. 7.

ENTERBANK HOLDINGS, INC., CLAYTON, MO:
2,546,738. CANC. INT. CL. 36.

ENTERTAINMENT PUBLICATIONS, LLC, TROY, MI:
1,480,774. CANC. INT. CL. 16.

ENTRIQ INC., WILMINGTON, DE:
2,911,896. AM. MULTIPLE CLASS, INT. CLS. 35, 38, 41 AND 42.

ENVIOS EXPRESS, LLC, PROVO, UT:
2,546,669. CANC. INT. CL. 36.

- ENVOY CORPORATION, NASHVILLE, TN:
3,568,646, INT. CL. 9.
- EPARTY UNLIMITED, INC., SAN CARLOS, CA:
3,567,484, PUB. 11-11-2008. INT. CL. 35.
- EPIC MEDIA GROUP LLC, EL SEGUNDO, CA:
3,568,068, INT. CL. 35.
- EQUALFOOTING.COM, INC., STERLING, VA:
2,547,023, CANC. INT. CL. 42.
- EQUATOR TECHNOLOGIES, INC., CAMPBELL, CA:
2,547,455, CANC. INT. CL. 9.
- EQUINE FORGINGS LIMITED, FORT ERIE, ONTARIO L2A 5M4, CANADA:
2,547,517, CANC. INT. CL. 6.
- EQUINE VENTURES, L.L.C., WAUKEE, IA:
3,566,651, PUB. 11-11-2008. INT. CL. 24.
- EQUINOX CAPITAL MANAGEMENT LLC, NEW YORK, NY:
2,547,680, CANC. INT. CL. 36.
- EQUISOURCE LLC, LOUISVILLE, KY:
2,547,593, CANC. INT. CL. 16.
- EQUITY CAPITAL NETWORK, INC., NEW YORK, NY:
2,546,728, CANC. INT. CL. 36.
- ERA DESIGN, LTD., BROOKLYN, NY:
3,568,029, MULTIPLE CLASS, INT. CLS. 9, 14 AND 16.
- ERBEL AG, GERSTHOFEN, FED REP GERMANY:
3,566,539, PUB. 11-11-2008. INT. CL. 1.
- ERGO-INDUSTRIAL SEATING SYSTEMS INC., MISSISSAUGA, ONTARIO:
2,243,175, REN. 12-19-08. INT. CL. 20.
2,244,904, REN. 12-19-08. INT. CL. 20.
- ERGOMOTION, INC., GOLETA, CA:
3,567,572, PUB. 11-11-2008. INT. CL. 20.
- ERICKSON, KAREN, NEW YORK, NY AND FLACK, JEAN-MARC, NEW YORK, NY:
2,547,241, CANC. INT. CL. 35.
- ERNI ELECTRONICS GMBH, ADELBERG, FED REP GERMANY:
3,566,759, PUB. 9-16-2008. MULTIPLE CLASS, INT. CLS. 9 AND 17.
- ERNST KLETT SPRACHEN GMBH, FED REP GERMANY:
3,567,880, PUB. 11-11-2008. MULTIPLE CLASS, INT. CLS. 9, 16, 38, 41 AND 42.
- ERO INDUSTRIES, INC.:
1,480,839, CANC. INT. CL. 21.
- ERO INDUSTRIES, INC., ARLINGTON HEIGHTS, IL:
2,145,416, CANC. INT. CL. 16.
- ERUPTOR ENTERTAINMENT, INC., MARINA DEL REY, CA:
2,546,670, CANC. INT. CL. 9.
- ERWEKA GMBH, FED REP GERMANY:
3,567,972, PUB. 11-11-2008. INT. CL. 9.
- ESCADA AG, 85609 ASCHHEIM BEI MUNCHEN, FED REP GERMANY:
2,547,926, CANC. INT. CL. 3.
- ESCALADE SPORTS PLAYGROUND, INC., EVANSVILLE, IN:
1,111,368, REN. 12-23-08. INT. CL. 28.
- ESEARCHFORIT, LLC, BIRMINGHAM, AL:
2,547,191, CANC. INT. CL. 42.
- ESLEEP, INC., JERSEY CITY, NJ:
1,480,878, CANC. INT. CL. 25.
- ESPN, INC., BRISTOL, CT:
2,143,950, CANC. INT. CL. 41.
2,215,512, REN. 12-19-08. INT. CL. 42.
- ESSELTE CORPORATION, MELVILLE, NY:
1,480,632, CANC. INT. CL. 9.
- ESSMAN, TONY L., EULESS, TX:
2,548,436, CANC. INT. CL. 9.
- ESTREM, SCOTT A., SPRINGFIELD, MO:
3,568,086, INT. CL. 9.
- ESUPPORTNOW LLC, BOSTON, MA:
2,545,632, CANC. INT. CL. 35.
- ESYLVAN, LLC, BALTIMORE, MD:
2,548,111, CANC. INT. CL. 41.
- ETHIKIDS, INC., NEW YORK, NICARAGUA:
3,568,246, INT. CL. 16.
- ETIIP HOLDINGS INC., VANCOUVER, BRITISH COLUMBIA:
3,567,742, PUB. 11-11-2008. MULTIPLE CLASS, INT. CLS. 9, 38 AND 42.
- ETOILE DISTRIBUTION, FRANCE:
3,567,821, PUB. 11-11-2008. INT. CL. 10.
- EUKALIN SPEZIAL-KLEBSTOFF FABRIK GMBH, FED REP GERMANY:
3,567,975, PUB. 11-11-2008. MULTIPLE CLASS, INT. CLS. 1 AND 16.
- EUNIVERSITY, INC., SUNNYVALE, CA:
2,546,225, CANC. INT. CL. 41.
- EUROPADISK, LTD., NEW YORK, NY:
2,546,138, CANC. INT. CL. 40.
- EUROPEAN GAS TURBINES LIMITED, LINCOLN LN2 5DJ, ENGLAND:
1,480,661, CANC. INT. CL. 9.
- EVA DENMARK A/S, DK-2760 MÅLØV, DENMARK:
3,485,306, COR. MULTIPLE CLASS, INT. CLS. 6, 8, 11, 14, 20, 21, 28 AND 34.
- EVA SIGNAL CORPORATION, OMAHA, NE:
2,545,724, CANC. INT. CL. 9.
- EVENINGLINK INC, WEST LAKE HILLS, TX:
3,567,302, PUB. 11-11-2008. INT. CL. 35.
- EVENTS OF THE HEART, INC, NEW YORK, NY:
3,567,486, PUB. 11-11-2008. INT. CL. 35.
- EVENTURE, INC., VERONA, NJ:
2,545,702, CANC. MULTIPLE CLASS, INT. CLS. 9 AND 35.
- EVEREADY BATTERY COMPANY, INC., ST. LOUIS, MO:
2,548,334, CANC. INT. CL. 11.
- EVERGREEN COMMUNITY ASSOCIATION, WOODBURY, MN:
3,567,036, PUB. 11-11-2008. INT. CL. 35.
- EVERLAST WORLD'S BOXING HEADQUARTERS CORPORATION, NEW YORK, NY:
3,568,333, INT. CL. 25.
- EVONIK INDUSTRIES AG, ESSEN, FED REP GERMANY:
3,566,473, PUB. 11-11-2008. INT. CL. 32.
- EVOTEC BIOSYSTEMS AG, D-22525 HAMBURG, FED REP GERMANY:
2,665,353, CANC. MULTIPLE CLASS, INT. CLS. 1, 5 AND 9.
- EVRIHOLDER PRODUCTS LLC., ANAHEIM, CA:
3,568,140, INT. CL. 21.
- EXACT RESEARCH, INC., BOISE, ID:
2,548,446, CANC. INT. CL. 9.
- EXACT SOFTWARE NORTH AMERICA, INC., ANDOVER, MA:
1,480,776, CANC. INT. CL. 16.
- EXAUDIO AB, SWEDEN:
3,567,917, PUB. 11-11-2008. MULTIPLE CLASS, INT. CLS. 9 AND 42.
- EXCEL, INC., HYANNIS, MA:
2,210,286, REN. 12-20-08. INT. CL. 9.
- EXCELSIOR BELTING-EQUIPMENT CO.,INC., BROOKLYN, NY:
3,567,005, PUB. 11-11-2008. INT. CL. 7.
- EXECTRANS, LLC, BELLEVUE, WA:
3,568,448, INT. CL. 39.
- EXETER VENTURE MANAGEMENT COMPANY, LLC, BOSTON, MA:
3,568,478, MULTIPLE CLASS, INT. CLS. 35 AND 36.
- EXHIBITOR LABORATORIES, INC., NEWBURY PARK, CA:
2,547,871, CANC. INT. CL. 3.
- EXIDE CORPORATION, READING, PA:
2,548,234, CANC. INT. CL. 9.
- EXPEDIA, INC., BELLEVUE, WA:
3,566,545, PUB. 11-11-2008. INT. CL. 35.
- EXPERIENCE LEARNING COMMUNITY, SEATTLE, WA, FORMERLY EXPERIENCE MUSIC PROJECT:
2,546,818, CANC. INT. CL. 9.
2,546,819, CANC. INT. CL. 42.
- EXPERIENCE MUSIC PROJECT, SEATTLE, WA:
2,548,415, CANC. INT. CL. 42.
- EXPERIO SOLUTIONS CORPORATION, DALLAS, TX:
2,546,736, CANC. MULTIPLE CLASS, INT. CLS. 35 AND 42.

- EXPLORIA PRODUCTIONS, LLC, HARTFORD, CT:
2,546,849, CANC. INT. CL. 41.
- EXPO-MED JEZISCHEK KG, 84549 ENGELSBERG, FED
REP GERMANY:
2,545,608, CANC. MULTIPLE CLASS, INT. CLS. 3, 9, 10
AND 42.
- EXTERMITAL TERMITE SERVICE OF DAYTON, INC.,
DAYTON, OH:
856,234, REN. 12-19-08. U.S. CL. 103 (INT. CL. 37).
- EXTRA HELPING, LLC, LOS ANGELES, CA:
3,567,500, PUB. 11-11-2008. INT. CL. 41.
- EXUM MOUNTAIN GUIDE SERVICE AND SCHOOL OF
MOUNTAINEERING, INC., MOOSE, WY:
2,546,545, CANC. INT. CL. 41.
- EZ SUPER SELLERS, LLC, EVANSTON, IL:
3,567,105, PUB. 11-11-2008. INT. CL. 35.
- EZ-FLO INTERNATIONAL, INC., ONTARIO, CA:
3,568,025, MULTIPLE CLASS, INT. CLS. 6, 11 AND 17.
- EZDIRECTORY.COM INC., DENVER, CO:
2,546,527, CANC. INT. CL. 35.
- F.LLI RUATA S.P.A., ITALY:
3,567,910, PUB. 11-11-2008. INT. CL. 29.
- F.W. BRYCE, INC., GLOUCESTER, MA:
3,566,471, PUB. 11-11-2008. INT. CL. 29.
- FACC SERVICES GROUP, LLC, TALLAHASSEE, FL:
3,567,307, PUB. 11-11-2008. INT. CL. 9.
- FACTSAFE, INC., NORCROSS, GA:
2,546,012, CANC. INT. CL. 9.
- FAILING, MICHAEL B., TUSTIN, CA AND ASH, SUSAN L.,
TUSTIN, CA:
2,545,853, CANC. INT. CL. 35.
- FAIN, JOSEPH THOMAS, NEW YORK, NY:
2,546,478, CANC. INT. CL. 41.
- FAIRCHILD, LYNNE, MARENGO, IL:
2,547,250, CANC. INT. CL. 41.
- FAIRVIEW HEALTH SERVICES, MINNEAPOLIS, MN:
3,567,279, PUB. 11-11-2008. INT. CL. 44.
3,567,280, PUB. 11-11-2008. INT. CL. 44.
- FAIRWAY COURSE GUIDES LIMITED, COUNTY KIL-
DARE, IRELAND:
2,546,474, CANC. INT. CL. 16.
- FAKESPACE LABS, INC., MOUNTAIN VIEW, CA:
2,547,384, CANC. INT. CL. 9.
- FALCON CANDY COMPANY, PHILADELPHIA, PA:
1,480,965, CANC. INT. CL. 30.
- FALCON INTERNATIONAL, INC., DALLAS, TX:
3,567,215, PUB. 11-11-2008. INT. CL. 40.
3,567,217, PUB. 11-11-2008. INT. CL. 40.
- FALCON IP/COMPLETE, LLC, MALDEN, MO:
3,568,166, INT. CL. 38.
- FALCON TECHNOLOGY SYSTEMS LTD, LARAMIE, WY,
DBA WINDRIDER TECHNOLOGY, INC.:
3,567,009, PUB. 11-11-2008. INT. CL. 9.
- FAMIGLIA-DEBARTOLO, LLC, WHITE PLAINS, NY, MAR-
OSA CORPORATION, GROTON, CT:
1,515,970, REN. 12-19-08. INT. CL. 42.
- FAMILY BUSINESS RESOURCE CENTER, THE, ORLAN-
DO, FL:
2,547,515, CANC. MULTIPLE CLASS, INT. CLS. 35 AND
41.
- FAMILY CHRISTIAN STORES, INC., GRAND RAPIDS, MI:
2,213,785, REN. 12-19-08. INT. CL. 35.
- FAMILY DOLLAR STORES OF MICHIGAN, INC., MAT-
THEWS, NC:
3,567,701, PUB. 11-11-2008. INT. CL. 30.
- FAMILY VIOLENCE NETWORK, LAKE ELMO, MN:
2,547,316, CANC. INT. CL. 42.
2,547,317, CANC. INT. CL. 41.
- FAMKE HOLDINGS CORPORATION, NEW YORK, NY:
3,566,644, PUB. 11-11-2008. INT. CL. 35.
- FAMOUS DAVE'S OF AMERICA, INC., MINNETONKA,
MN:
3,567,383, PUB. 11-11-2008. INT. CL. 43.
- FANSTEEL INC., NORTH CHICAGO, IL:
2,547,019, CANC. INT. CL. 6.
- FANUKA INC., MASPEETH, NY:
3,567,237, PUB. 11-11-2008. INT. CL. 37.
3,567,238, PUB. 11-11-2008. INT. CL. 37.
- FAR BEYOND WOODWORKING, INC., WEST DOVER, VT:
3,567,272, PUB. 11-11-2008. INT. CL. 21.
- FARLEY'S & SATHERS CANDY COMPANY, INC., ROUND
LAKE, MN:
2,548,027, CANC. INT. CL. 20.
- FARMAPOSTA HEALTHCARE LTD, UNITED KINGDOM:
3,567,927, PUB. 11-11-2008. MULTIPLE CLASS, INT. CLS.
3 AND 5.
- FARR FINANCIAL INC., SAN JOSE, CA:
3,566,729, PUB. 11-11-2008. INT. CL. 36.
- FARRINGTON, ROBYN J., WESTFIELD, NJ:
3,568,710, MULTIPLE CLASS, INT. CLS. 8, 10, 12 AND 18.
- FARROW, SUZANNE J., OXNARD, CA:
3,566,420, PUB. 11-11-2008. INT. CL. 30.
- FASHION SHOE LICENSING LLC, NASHVILLE, TN:
2,547,595, CANC. INT. CL. 25.
- FASHION WORLD, INC., BEVERLY HILLS, CA:
1,480,389, CANC. INT. CL. 3.
- FAT CAT, INC., NORTH HILLS, CA:
2,228,741, REN. 12-22-08. INT. CL. 28.
- FAT CAT, INC., WILLISTON, VT:
2,547,338, CANC. INT. CL. 28.
- FCT ELECTRONIC GMBH, FED REP GERMANY:
3,567,868, PUB. 11-11-2008. MULTIPLE CLASS, INT. CLS.
9, 37, 40 AND 42.
- FEDERAL EXPRESS CORPORATION, MEMPHIS, TN:
1,481,087, CANC. INT. CL. 39.
- FEDERAL LABORATORIES CHEMICAL CORPORATION,
EAST AMHERST, NY, DBA JEFFREY TAUB:
3,567,324, PUB. 11-11-2008. INT. CL. 5.
- FEDERAL RESERVE BANK OF ATLANTA, ATLANTA, GA:
3,568,761, INT. CL. 35.
- FEDERAL RESERVE BANK OF ST. LOUIS, THE, ST. LOUIS,
MO:
2,545,962, CANC. INT. CL. 16.
- FELDSTEIN, TRACY, MARINA DEL REY, CA:
3,567,393, PUB. 11-11-2008. INT. CL. 3.
- FELICIA JAMES AND DAVID PATRICK WHITE PARTNER-
SHIP, THE, WAMBERAL, N.S.W. 2260, AUSTRALIA:
2,547,635, CANC. INT. CL. 16.
- FENCECRETE AMERICA, INC., SAN ANTONIO, TX:
1,517,197, REN. 12-19-08. MULTIPLE CLASS, INT. CLS.
19 AND 37.
- FERACI, JEREMY P., CAPE CORAL, FL:
3,568,768, INT. CL. 25.
- FERN GROUP LTD., THE, NORTH YORK, ONTARIO,
CANADA:
2,205,396, REN. 12-23-08. INT. CL. 4.
- FERRARA PAN CANDY CO., INC., FOREST PARK, IL:
2,205,626, REN. 12-20-08. INT. CL. 25.
- FERRELLGAS PARTNERS, L.P., OVERLAND PARK, KS:
3,568,610, INT. CL. 35.
- FERRERO S.P.A., I-12051 ALBA (CN), ITALY:
3,567,898, PUB. 11-11-2008. INT. CL. 30.
- FERRO CORPORATION, CLEVELAND, OH:
1,105,842, REN. 12-22-08. INT. CL. 1.
- FETCO HOME DECOR, RANDOLPH, MA:
2,144,717, CANC. INT. CL. 20.
- FETZER VINEYARDS, HOPLAND, CA:
3,568,276, INT. CL. 36.
3,568,277, INT. CL. 33.
- FIBER INDUSTRIES, INC., CHARLOTTE, NC:
2,547,614, CANC. INT. CL. 22.
- FIBERWEB SIMPSONVILLE, INC., SIMPSONVILLE, SC,
BBA NONWOVENS SIMPSONVILLE, INC., SIMPSON-
VILLE, SC:
2,196,147, REN. 12-22-08. INT. CL. 24.
- FILLMORE THOMAS & CO., INC., LAPEER, MI:
2,548,192, CANC. INT. CL. 19.
- FILLMORE-PIRU CITRUS ASSOCIATION, PIRU, CA:
2,145,080, CANC. INT. CL. 31.
- FILTREX HOLDINGS PTE LTD, PARKLANE MALL, SIN-
GAPORE:
3,568,258, INT. CL. 11.
- FINE CRAFT, INC., GLENCOE, IL:
3,568,080, INT. CL. 16.
- FINE, REBECCA-LYNN WEXLER, MINNEAPOLIS, MN:
3,567,176, PUB. 11-11-2008. INT. CL. 44.

- FINGERHUT DIRECT MARKETING, INC., EDEN PRAIRIE, MN:
2,659,758, CANC. INT. CL. 24.
- FINLEY, ROBERT, L., JENSEN BEACH, FL:
3,568,631, INT. CL. 7.
- FIORY S.A., MEDELLIN, COLOMBIA:
3,568,681, INT. CL. 25.
- FIRE HOUSE, INCORPORATED, EVANSVILLE, IN:
2,547,089, CANC. INT. CL. 35.
- FIRE NINE SOLUTIONS, INC., RENO, NV:
2,546,028, CANC. MULTIPLE CLASS, INT. CLS. 9 AND 42.
- FIREBOX RESEARCH & STRATEGY LLC, BEACHWOOD, OH:
3,566,349, PUB. 11-11-2008. INT. CL. 35.
- FIRENZE, ANGELO P., BELMONT, MA:
3,567,017, PUB. 11-11-2008. INT. CL. 30.
- FIRST BETHANY BANCORP, INC., BETHANY, OK:
2,145,514, CANC. INT. CL. 36.
- FIRST DATA CORPORATION, ATLANTA, GA:
2,547,879, CANC. INT. CL. 35.
- FIRST INTERNET COMMUNICATIONS, INC., WILMINGTON, DE:
2,548,226, CANC. INT. CL. 9.
- FIRST MEDIA (STARTUP) CORP., ETOBICOKE, ONTARIO, CANADA:
2,545,722, CANC. INT. CL. 38.
- FIRST NATIONAL OF NEBRASKA, INC., OMAHA, NE:
3,568,287, INT. CL. 36.
- FIRST UNION CORPORATION, CHARLOTTE, NC:
2,546,815, CANC. INT. CL. 36.
- FIRST UNITED BANK AND TRUST COMPANY, DURANT, OK:
2,208,341, REN. 12-20-08. INT. CL. 36.
- FISHER INVESTMENTS, INC., WOODSIDE, CA:
3,568,136, INT. CL. 36.
- FISSLINGER, JOHANNES R., CULVER CITY, CA:
2,548,179, CANC. INT. CL. 9.
- FIXICO, PHIL, WILKES, INGLEWOOD, CA:
3,568,327, INT. CL. 25.
- FJR ADVISORS, LLC, NEWPORT BEACH, CA:
3,568,707, INT. CL. 41.
- FKA DISTRIBUTING CO., COMMERCE TOWNSHIP, MI, DBA HOMEDICS, INC.:
3,568,623, INT. CL. 10.
- FLACHGLAS AKTIENGESELLSCHAFT, D-90766 FURTH, FED REP GERMANY:
2,545,648, CANC. INT. CL. 19.
- FLAIM, THOMAS A., TROY, MI:
2,244,223, REN. 12-19-08. U.S. CL. A.
- FLANNERY, DONALD H., WINTER SPRING, FL:
2,545,547, CANC. INT. CL. 35.
- FLAT WORLD MEDIA, TAMPA, FL:
3,566,353, PUB. 11-11-2008. INT. CL. 35.
- FLD INVESTMENTS, INC., SMITHFIELD, VA:
2,546,939, CANC. INT. CL. 29.
- FLEET WHOLESALE SUPPLY CO., INC., APPLETON, WI:
3,567,422, PUB. 11-11-2008. INT. CL. 25.
- FLEX, JOHN THOMAS, ALVIN, TX:
2,208,597, REN. 12-19-08. INT. CL. 5.
- FLEXFAB NIAGARA INC., MONTREAL, QUEBEC H3B 4G7, CANADA:
2,143,843, CANC. INT. CL. 17.
- FLIPSIDE, INC., EL SEGUNDO, CA:
2,546,343, CANC. INT. CL. 41.
2,546,396, CANC. INT. CL. 41.
- FLORA SPRINGS WINE COMPANY, ST. HELENA, CA:
2,293,768, REN. 12-23-08. INT. CL. 33.
- FLORENCE, JON, 3971 KE DRIEBERGEN, NETHERLANDS:
2,547,826, CANC. MULTIPLE CLASS, INT. CLS. 25 AND 35.
- FLORES DEL RIO S.A., SANTAFE DE BOGOTA, COLOMBIA:
2,545,996, CANC. INT. CL. 31.
- FLORIDA GREEN DISTRIBUTION, CORP., MIAMI, FL:
2,547,580, CANC. INT. CL. 31.
- FLOURISH STUDIOS LLC, CHICAGO, IL:
3,566,487, PUB. 11-11-2008. MULTIPLE CLASS, INT. CLS. 41 AND 44.
- FLOWERS FAMILY BAKERIES, INC., WILMINGTON, DE:
1,480,976, CANC. INT. CL. 30.
- FLOWTITE TECHNOLOGY A/S, SANDEFJORD, NORWAY TO FLOWTITE TECHNOLOGY A/S, SANDEFJORD, NORWAY:
2,622,564, CANC. INT. CL. 11.
- FLUID INNOVATION GROUP, INC., AUSTIN, TX:
3,566,594, PUB. 11-11-2008. MULTIPLE CLASS, INT. CLS. 35, 42 AND 45.
- FLYING FISH COVE PTY LTD, AUSTRALIA:
3,567,834, PUB. 11-11-2008. INT. CL. 33.
- FLYING STAR CAFE, ALBUQUERQUE, NM:
3,567,315, PUB. 11-11-2008. INT. CL. 30.
- FMC CORPORATION, PHILADELPHIA, PA:
2,166,250, REN. 12-23-08. INT. CL. 1.
2,547,483, CANC. INT. CL. 5.
- FMR LLC, BOSTON, MA:
1,481,040, CANC. INT. CL. 36.
2,214,563, REN. 12-23-08. INT. CL. 36.
2,214,583, REN. 12-22-08. INT. CL. 35.
2,548,344, CANC. MULTIPLE CLASS, INT. CLS. 16 AND 36.
2,548,419, CANC. INT. CL. 36.
3,566,844, PUB. 11-11-2008. INT. CL. 36.
- FOAMATION INC., ST. FRANCIS, WI:
2,191,735, REN. 12-23-08. INT. CL. 25.
- FOCUS ON THE FAMILY, COLORADO SPRINGS, CO:
3,567,358, PUB. 11-11-2008. INT. CL. 16.
3,567,687, PUB. 11-11-2008. INT. CL. 16.
- FOCUS, INC., SOUTH JORDAN, UT:
3,568,309, INT. CL. 9.
- FONDAZIONE MARINO GOLINELLI (ONLUS), 40133 BOLOGNA, ITALY:
2,546,288, CANC. MULTIPLE CLASS, INT. CLS. 9, 16, 41 AND 42.
- FONETIC DESIGN, SEATTLE, WA:
3,567,156, PUB. 11-11-2008. INT. CL. 25.
- FONSECA, BRIAN LEE, NORTHGLENN, CO, DBA USER-MAIL.COM:
2,547,265, CANC. INT. CL. 38.
- FOOT LOCKER RETAIL, INC., NEW YORK, NY:
2,145,191, CANC. INT. CL. 25.
- FOR YOUR EASE ONLY, INC., CHICAGO, IL:
3,568,060, MULTIPLE CLASS, INT. CLS. 4, 6, 9, 14, 18, 20, 21 AND 35.
- FORBES INC., NEW YORK, NY:
2,144,602, CANC. INT. CL. 16.
- FORCE FLOW EQUIPMENT, CONCORD, CA:
2,547,060, CANC. INT. CL. 9.
- FORD MOTOR COMPANY, DEARBORN, MI:
1,480,744, CANC. INT. CL. 12.
2,245,542, REN. 12-22-08. INT. CL. 14.
2,547,675, CANC. INT. CL. 36.
2,547,837, CANC. INT. CL. 36.
2,547,923, CANC. INT. CL. 35.
2,548,372, CANC. INT. CL. 20.
- FOREMOST CORPORATION OF AMERICA, CALEDONIA, MI:
3,566,770, PUB. 11-11-2008. MULTIPLE CLASS, INT. CLS. 35 AND 36.
- FOREMOST STAFFING, FORT WORTH, TX:
3,567,270, PUB. 11-11-2008. INT. CL. 35.
- FOREST COUNTY POTAWATOMI COMMUNITY, CRANDON, WI, DBA POTAWATOMI BINGO CASINO:
3,567,530, PUB. 11-11-2008. INT. CL. 43.
- FORGENT NETWORKS, INC., AUSTIN, TX:
3,568,332, INT. CL. 42.
- FORTIFIBER CORPORATION, INCLINE VILLAGE, NV:
2,144,038, CANC. INT. CL. 16.
- FORTIS UHREN A.G. (MONTRES FORTIS S.A.) (FORTIS WATCH LTD.), GRENCHEN, SWITZERLAND:
1,480,746, CANC. INT. CL. 14.
- FOSTER'S WINE ESTATES AMERICAS COMPANY, NAPA, CA:
3,568,319, INT. CL. 33.
- FOUNTAINHEAD CAPITAL, LLC, DALLAS, TX:
3,568,387, INT. CL. 36.

FOURSPOTS, INC., MARIETTA, GA:
3,568,694, INT. CL. 35.

FOX NEWS NETWORK, LLC, NEW YORK, NY:
3,567,368, PUB. 11-11-2008. INT. CL. 41.

FOX, KAREN C., WASHINGTON, DC AND COOKE, CATHERINE J., ARLINGTON, VA:
2,545,915, CANC. INT. CL. 41.

FRAMATOME CONNECTORS INTERNATIONAL, SOCIETE ANONYME, 92400 COURBEVOIE, FRANCE:
2,546,125, CANC. INT. CL. 9.

FRANCE EXCELLENCE S.A.R.L., 75017 PARIS, FRANCE:
2,546,236, CANC. INT. CL. 3.

FRANK BRUNCKHORST CO., L.L.C., BROOKLYN, NY:
3,568,678, MULTIPLE CLASS, INT. CLS. 29 AND 30.

FRANK KENT MOTOR CO., FORT WORTH, TX:
2,547,081, CANC. INT. CL. 35.

FRANKLIN COVEY CO., SALT LAKE CITY, UT:
2,545,558, CANC. INT. CL. 16.

FRASE', ANDREA, PEPPERELL, MA:
3,566,285, PUB. 11-11-2008. INT. CL. 44.

FRED WEHRENBURG CIRCUIT OF THEATRES, INC., ST. LOUIS, MO:
3,566,259, PUB. 11-11-2008. INT. CL. 41.

FRED'S INT'L HANDBAGS, INC., NEW YORK, NY:
2,547,865, CANC. INT. CL. 18.

FREDERICK'S OF HOLLYWOOD GROUP INC., NEW YORK, NY:
2,546,913, CANC. INT. CL. 25.

FREEI NETWORKS, INC, FEDERAL WAY, WA, DBA FREEINTERNET.COM:
2,546,084, CANC. INT. CL. 42.

FREEMAN CAPITAL COMPANY, LAS VEGAS, NV:
2,547,877, CANC. MULTIPLE CLASS, INT. CLS. 37, 39, 40, 41 AND 42.

FREEZOLAR TECHNOLOGIES GMBH, BERLIN, FED REP GERMANY:
3,566,381, PUB. 11-11-2008. MULTIPLE CLASS, INT. CLS. 10, 11 AND 21.

FREIGHTLINER LLC, PORTLAND, OR:
3,568,342, INT. CL. 39.

FRENCH, DONNA C., JACKSONVILLE, FL, DBA ULTIMATE OIL PRESENTS:
3,567,532, PUB. 11-11-2008. INT. CL. 3.

FRIEDLANDER, DANIEL, SAN FRANCISCO, CA:
1,516,029, REN. 12-19-08. INT. CL. 42.

FRIESLAND BRANDS BV, 7943 PE MEPPEL, NETHERLANDS:
3,566,490, PUB. 11-11-2008. INT. CL. 29.

FROMAGERIE LINCET, SALIGNY, FRANCE:
3,566,738, PUB. 11-11-2008. INT. CL. 29.

3,566,739, PUB. 11-11-2008. INT. CL. 29.

FRONT OFFICE COMMUNICATIONS, INC., CARY, NC:
2,547,202, CANC. INT. CL. 9.

FRUMTHA, INC., LAPWAI, ID:
3,566,307, PUB. 11-11-2008. INT. CL. 25.

FRY'S METALS, INC., ALTOONA, PA:
504,357, REN. 12-20-08. U.S. CL. 14 (INT. CL. 6).

FUEST, LUDGER, EUSKIRCHEN, FED REP GERMANY:
3,567,773, PUB. 11-11-2008. MULTIPLE CLASS, INT. CLS. 35, 38, 41 AND 42.

FUJIFILM CORPORATION, TOKYO, JAPAN:
2,224,107, REN. 12-19-08. INT. CL. 9.

FUKUDA, ETSUO, CERRITOS, CA:
2,145,085, CANC. INT. CL. 42.

FULDA, NANCY E., HOFHEIM, FED REP GERMANY:
3,566,731, PUB. 11-11-2008. INT. CL. 35.

FULLER, REBECCA A, LAS VEGAS, NV, DBA FULLER LAW PRACTICE, PC:
3,567,600, PUB. 11-11-2008. INT. CL. 45.

FUNTRONICS, INC., LOUISVILLE, KY:
2,547,969, CANC. INT. CL. 28.

2,547,970, CANC. INT. CL. 28.

FURITECHNICS GROUP PTY. LTD., WEST END, QUEENSLAND 4101, AUSTRALIA:
2,546,410, CANC. INT. CL. 8.

FUSHIMI PHARMACEUTICAL COMPANY LIMITED, MARUGAME-SHI, KAGAWA-KEN, JAPAN:
1,480,397, CANC. INT. CL. 5.

FUSION UV SYSTEMS, INC., GAITHERSBURG, MD:
3,568,624, INT. CL. 11.

3,568,625, INT. CL. 11.

FUTURE PIPE INDUSTRIES, INC., HOUSTON, TX:
3,566,689, PUB. 11-11-2008. MULTIPLE CLASS, INT. CLS. 17 AND 19.

3,566,691, PUB. 11-11-2008. MULTIPLE CLASS, INT. CLS. 17 AND 19.

FUTURO LATINO, LLC, SAN FRANCISCO, CA:
3,566,952, PUB. 11-11-2008. INT. CL. 41.

G & D RESTAURANT ASSOCIATES LLC, NEW YORK, NY, PAULI, FRANCESCA, MILANO, ITALY:
1,511,914, REN. 12-19-08. MULTIPLE CLASS, INT. CLS. 29, 30 AND 42.

G.C.I., INC., NEW ORLEANS, LA:
2,547,359, CANC. INT. CL. 16.

G.PULSE INTERNATIONAL CO., LTD., TAICHUNG HSIEN, TAIWAN:
2,545,800, CANC. INT. CL. 10.

G-UP CORPORATION, MILPITAS, CA:
2,548,504, CANC. INT. CL. 32.

GA MODEFINE S.A., MENDRISIO 6850, SWITZERLAND:
2,210,309, REN. 12-22-08. INT. CL. 35.

GACH, JONATHAN L., QUEEN CREEK, AZ AND MEDINA, DEBORAH A., GILBERT, AZ:
3,568,497, MULTIPLE CLASS, INT. CLS. 25 AND 33.

GAGNE, ALEC JAY, SAN JOSE, CA:
2,546,741, CANC. INT. CL. 9.

GALAXY UNLIMITED CORPORATION, SAN JOSE, CA:
2,547,982, CANC. INT. CL. 35.

GALE CORPORATION, SACRAMENTO, CA:
3,568,611, INT. CL. 9.

GALENCIA NUTRITION GMBH, ZURICH, SWITZERLAND:
3,567,999, INT. CL. 5.

GALLAGHER, STEVEN R., DEDHAM, MA AND QUINN, TIMOTHY C., WESTROXBURY, MA:
3,568,597, INT. CL. 25.

GALLOWAY, GRAHAM SCOTT, THUNDER BAY, ONTARIO, CANADA, DBA TECHINDEX PUBLISHING:
1,480,747, CANC. INT. CL. 14.

GALYA, SCOTT, MIAMI, FL:
3,568,738, INT. CL. 36.

GAMBIT GAMEWORKS, INC., NORTHRIDGE, CA:
2,548,443, CANC. INT. CL. 28.

GAMELOFT S.A., 75009 PARIS, FRANCE:
3,568,013, INT. CL. 9.

GAP INTERNATIONAL, INC., SPRINGFIELD, PA:
3,566,292, PUB. 11-11-2008. INT. CL. 35.

GARBER'S TRAVEL SERVICE, INC., BROOKLINE, MA:
1,481,092, CANC. INT. CL. 39.

GARDEN LIFE S.A., (1667) PCIA. DE BUENOS AIRES, ARGENTINA:
2,547,818, CANC. INT. CL. 20.

GARDEN STATE FOOT & ANKLE GROUP, LLC, LAKEWOOD, NJ:
3,567,506, PUB. 11-11-2008. INT. CL. 44.

GARELICK FARMS, INC., FRANKLIN, MA:
1,480,989, CANC. INT. CL. 32.

GARLOFF, RICK L., JACKSON, CA:
3,566,429, PUB. 4-15-2008. INT. CL. 41.

GARNER, RICHARD S., RIDGELAND, MS:
2,548,604, CANC. INT. CL. 42.

GAST MANUFACTURING, INC., BENTON HARBOR, MI:
2,546,289, CANC. INT. CL. 35.

GATEWAY HEALTH PLAN, L.P., PITTSBURGH, PA:
3,566,681, PUB. 11-11-2008. INT. CL. 44.

GATTEFOSSE SAS, 69800 SAINT PRIEST, FRANCE, SERAC, LYON (RHONE), FRANCE:
1,108,326, REN. 12-19-08. INT. CL. 1.

GAZUL PRODUCCIONES, S.L.U., MADRID, SPAIN:
3,568,255, INT. CL. 3.

GCA SERVICES GROUP, INC., CLEVELAND, OH:
3,568,596, MULTIPLE CLASS, INT. CLS. 35, 37, 39 AND 44.

GE FANUC AUTOMATION AMERICAS, INC., CHARLOTTEVILLE, VA:
3,568,271, INT. CL. 9.

- GE HEALTHCARE BIO-SCIENCES AB, UPPSALA, SWEDEN:
2,200,254. REN. 12-20-08. INT. CL. 1.
2,547,022. CANC. INT. CL. 35.
3,567,512. PUB. 11-11-2008. INT. CL. 1.
- GEARBOX SOFTWARE LLC, PLANO, TX:
3,568,006. INT. CL. 9.
- GEARWORKS, INC., EAGAN, MN:
3,566,579. PUB. 11-11-2008. MULTIPLE CLASS, INT. CLS. 35 AND 42.
- GEFRAN S.P.A., ITALY:
3,567,807. PUB. 11-11-2008. MULTIPLE CLASS, INT. CLS. 7, 9 AND 42.
- GELWIX, DAVID LARRY, SALT LAKE CITY, UT:
3,567,336. PUB. 11-11-2008. INT. CL. 41.
- GEM-CAP, INC., AUSTIN, TX, DBA DBS HAYES SOFTWARE SYSTEMS:
3,566,969. PUB. 11-11-2008. INT. CL. 9.
- GENDEX CORP., DES PLAINES, IL:
3,567,476. PUB. 11-11-2008. INT. CL. 10.
- GENERAL CIGAR CO., INC., RICHMOND, VA:
1,096,932. REN. 12-23-08. INT. CL. 34.
- GENERAL ELECTRIC COMPANY, SCHENECTADY, NY:
2,547,723. CANC. INT. CL. 36.
- GENERAL ENGINEERING COMPANY, THE, FREDERICK, MD:
1,480,442. CANC. INT. CL. 6.
- GENERAL HEARING INSTRUMENTS, INC., HARAHAH, LA:
2,548,463. CANC. INT. CL. 10.
- GENERAL MEDIA COMMUNICATIONS, INC., BOCA RATON, FL:
2,546,647. CANC. MULTIPLE CLASS, INT. CLS. 38 AND 42.
- GENERAL RE CORPORATION, STAMFORD, CT:
2,548,295. CANC. MULTIPLE CLASS, INT. CLS. 36 AND 42.
- GENERATION TECHNOLOGIES CORPORATION, OVERLAND PARK, KS:
2,143,991. CANC. INT. CL. 9.
- GENEROSITY, L.L.C., PHOENIX, AZ:
2,548,467. CANC. INT. CL. 16.
- GENESIS INDUSTRIES, LLC, ARCADIA, LA:
3,566,849. PUB. 11-11-2008. INT. CL. 9.
- GENESYS TELECOMMUNICATIONS LABORATORIES, INC., DALY CITY, CA:
2,161,483. REN. 12-19-08. MULTIPLE CLASS, INT. CLS. 9 AND 42.
- GENETIC EVOLUTIONARY NUTRITION, MARINA DEL REY, CA:
2,548,262. CANC. INT. CL. 5.
- GENOSIS LIMITED, KINGSTON, SURREY KT2 5AA, ENGLAND:
2,545,715. CANC. INT. CL. 5.
- GENX INTERNATIONAL, INC., GUILFORD, CT:
2,546,864. CANC. INT. CL. 9.
- GEORGE, MARY, SAINT THOMAS, US VIRGIN ISLANDS:
3,566,922. PUB. 11-11-2008. INT. CL. 28.
- GEORGIA AGRI-SALES, INC., GLENNVILLE, GA:
3,566,622. PUB. 11-11-2008. INT. CL. 31.
- GEORGIA DEPARTMENT OF NATURAL RESOURCES, ATLANTA, GA:
3,567,435. PUB. 11-11-2008. INT. CL. 41.
- GET KAYAKTIVE, L.L.C., ORIENTAL, NC:
3,568,285. INT. CL. 12.
- GET THE GIRL, INC., CHICAGO, IL, DBA GET THE GUY:
3,566,805. PUB. 11-11-2008. INT. CL. 45.
- GETTYS GROUP INC., THE, CHICAGO, IL:
2,547,645. CANC. MULTIPLE CLASS, INT. CLS. 37 AND 42.
- GEZARI, WALTER A., CALVERTON, NY:
2,547,738. CANC. INT. CL. 35.
- GIANNONI, GREG, ELBERTON, GA:
2,548,272. CANC. INT. CL. 13.
- GIANT GOLF COMPANY, IRVINE, CA:
2,548,378. CANC. INT. CL. 28.
2,548,382. CANC. INT. CL. 28.
- GIBSON LABORATORIES, INC., LEXINGTON, KY:
3,566,491. PUB. 11-11-2008. INT. CL. 1.
- GIBSON OVERSEAS, INC., COMMERCE, CA:
2,144,282. CANC. INT. CL. 21.
- GIFFIN, PHILIP G., MESA, AZ:
3,566,744. PUB. 11-11-2008. INT. CL. 25.
- GIFT LINK, INC., SOUTH PLAINFIELD, NJ, DBA POPULAR IMPORTS:
2,546,904. CANC. INT. CL. 20.
- GIFTCERTIFICATES.COM, INC., OMAHA, NE:
2,546,464. CANC. INT. CL. 35.
- GIGANTICANT.COM, INC., ST. LOUIS, MO:
2,547,015. CANC. MULTIPLE CLASS, INT. CLS. 35 AND 42.
- GILBARCO INC., GREENSBORO, NC:
2,211,785. REN. 12-20-08. INT. CL. 9.
- GILBERT, JAN WADE, LAWRENCE, NY:
2,546,561. CANC. INT. CL. 42.
- GILMAN, PETER A., TOLEDO, OH:
3,568,024. INT. CL. 16.
- GILSTER-MARY LEE CORPORATION, CHESTER, IL:
2,207,731. REN. 12-19-08. INT. CL. 31.
- GIMMI GMBH, D-78532, TUTTLINGEN, FED REP GERMANY:
2,667,582. CANC. INT. CL. 5.
- GINSEY INDUSTRIES, INC., BELLMAWR, NJ:
2,103,391. REN. 12-22-08. INT. CL. 11.
- GINTECH ENERGY CORPORATION, TAIPEI, TAIWAN:
3,566,643. PUB. 11-11-2008. INT. CL. 9.
- GIT LIT, INC., LOUISVILLE, KY:
2,548,315. CANC. INT. CL. 12.
- GIVEMEANING PRODUCTS INC., VANCOUVER, CANADA:
3,566,431. PUB. 11-11-2008. MULTIPLE CLASS, INT. CLS. 6, 16, 20, 35 AND 36.
3,566,432. PUB. 11-11-2008. MULTIPLE CLASS, INT. CLS. 6, 16, 20, 35 AND 36.
- GIVINGWORKS INC., FALLS CHURCH, VA:
3,566,725. PUB. 11-11-2008. INT. CL. 35.
- GIZMAUX, LLC, BROOKLYN, NY:
3,568,787. INT. CL. 16.
- GJL, INCORPORATED, CRESTWOOD, IL:
2,547,252. CANC. INT. CL. 40.
- GLACIALTECH, INC, CHINA:
3,567,899. PUB. 11-11-2008. INT. CL. 9.
- GLASSGOLD, SCOTT, NEW YORK, NY:
2,547,639. CANC. MULTIPLE CLASS, INT. CLS. 25 AND 41.
- GLAXO GROUP LIMITED, GREENFORD, MIDDLESEX, UNITED KINGDOM:
3,566,914. PUB. 11-11-2008. INT. CL. 5.
- GLENN MILLER ASSOCIATES, LAKEWOOD, CA:
3,567,564. PUB. 11-11-2008. INT. CL. 14.
- GLH SEEDS, INC., OVID, MI:
2,144,285. CANC. INT. CL. 31.
- GLIMCHER REALTY TRUST, COLUMBUS, OH:
3,567,143. PUB. 11-11-2008. MULTIPLE CLASS, INT. CLS. 35, 36 AND 37.
3,567,466. PUB. 11-11-2008. INT. CL. 35.
3,567,470. PUB. 11-11-2008. INT. CL. 42.
- GLOBAL COMMERCE NETWORK, IRVINE, CA:
2,270,911. REN. 12-19-08. INT. CL. 42.
- GLOBAL CORPORATE SERVICES LTD, MAHE, SEYCHELLES:
3,568,265. INT. CL. 9.
- GLOBAL GOLD, INC, NEW YORK, NY:
2,547,544. CANC. INT. CL. 25.
- GLOBAL HEALTHCARE CORPORATION, TEMPE, AZ:
2,547,900. CANC. INT. CL. 42.
- GLOBAL IMAGING SYSTEMS, INC., TAMPA, FL:
3,567,740. PUB. 11-11-2008. INT. CL. 37.
- GLOBAL NEURO-DIAGNOSTICS, LP, LEWISVILLE, TX:
3,566,842. PUB. 11-11-2008. INT. CL. 44.
- GLOBAL SOFTWARE SOLUTIONS, INC., PORTLAND, OR:
2,546,488. CANC. INT. CL. 9.
2,546,489. CANC. INT. CL. 42.
- GLOBAL TRAFFIC TECHNOLOGIES, LLC, ST. PAUL, MN:
3,566,298. PUB. 11-11-2008. INT. CL. 9.

GLOBAL WONDER ENTERTAINMENT, INC., SEATTLE, WA, DBA TOONED IN:
3,567,450, PUB. 11-11-2008. MULTIPLE CLASS, INT. CLS. 41, 42 AND 45.

GLOBAL ENGLISH CORPORATION, BRISBANE, CA:
2,547,916, CANC. INT. CL. 41.

GLOBEMED, EVANSTON, IL:
3,567,314, PUB. 11-11-2008. MULTIPLE CLASS, INT. CLS. 36 AND 41.
3,567,317, PUB. 11-11-2008. MULTIPLE CLASS, INT. CLS. 36 AND 41.

GLORIA MED PHARMA S.R.L., COMO, ITALY:
3,566,382, PUB. 8-12-2008. MULTIPLE CLASS, INT. CLS. 3 AND 5.

GLS, INC., LOS ANGELES, CA TO MATTHEW BENDER PROPERTIES, INC., WILMINGTON, DE:
2,145,126, CANC. INT. CL. 9.

GM NAMEPLATE, INC., SEATTLE, WA:
2,548,555, CANC. INT. CL. 42.

GM WORLDWIDE ENTERTAINMENT, INC., LAS VEGAS, NV:
3,568,095, INT. CL. 35.

GMAC COMMERCIAL FINANCE LLC, CHICAGO, IL:
2,546,369, CANC. INT. CL. 9.

GN RESOUND A/S, DENMARK:
3,567,967, PUB. 11-11-2008. INT. CL. 10.
3,567,968, PUB. 11-11-2008. INT. CL. 10.

GO-4 EXPRESS, INC., JANESVILLE, WI:
2,546,787, CANC. INT. CL. 39.

GODADDY.COM, INC., SCOTTSDALE, AZ:
3,568,445, MULTIPLE CLASS, INT. CLS. 9, 35, 39, 42 AND 45.

GODFREY HIRST AUSTRALIA PTY LTD., SOUTH GEE-
LONG VICTORIA, AUSTRALIA:
3,568,113, INT. CL. 27.
3,568,114, INT. CL. 27.
3,568,115, INT. CL. 27.

GODINGER SILVER ART CO., LTD., BROOKLYN, NY:
1,480,750, CANC. INT. CL. 14.

GODSPEAKS, INC., ATLANTA, GA:
2,546,010, CANC. INT. CL. 42.
2,546,011, CANC. INT. CL. 42.

GOLD MARK, LLC, ENCINITA, CA:
3,567,016, PUB. 11-11-2008. INT. CL. 44.

GOLDEN EAGLE ESTATES, LLC, MURPHYS, CA:
3,568,118, INT. CL. 33.
3,568,119, INT. CL. 33.

GOLDEN STATE WARRIORS, LLC, OAKLAND, CA:
2,207,409, REN. 12-19-08. INT. CL. 25.

GOLDFELLOW, LLC, WESTON, FL:
3,567,714, PUB. 11-11-2008. INT. CL. 35.

GOLDREYER, INC., GOLDEN, CO:
2,545,797, CANC. INT. CL. 42.

GOLVABIA AB, ANDERSTORP, SWEDEN:
2,547,513, CANC. INT. CL. 19.

GOMEZ, ROSA E., LOS ANGELES, CA:
3,567,449, PUB. 11-11-2008. MULTIPLE CLASS, INT. CLS. 14 AND 25.

GONDOLA ADVENTURES, INC., NEWPORT BEACH, CA:
3,567,535, PUB. 11-11-2008. INT. CL. 39.

GONGAWARE, KRIS D., ALLISON PARK, PA:
2,547,658, CANC. INT. CL. 42.

GONZALEZ, FRANCISCO, CASTAIC, CA AND GONZALEZ, JOSE A., CASTAIC, CA:
3,568,257, INT. CL. 33.

GONZALEZ, NIEVES IV, RICHMOND, TX, DBA MAKE YOU SMILE PHOTOGRAPHY:
3,567,591, PUB. 11-11-2008. INT. CL. 41.

GOOD SPORTS PLUS LTD., INGLEWOOD, CA:
3,567,021, PUB. 11-11-2008. INT. CL. 41.
3,567,022, PUB. 11-11-2008. INT. CL. 41.

GOODALL, CRAIG C., SUMMIT, NJ:
2,547,291, CANC. INT. CL. 42.

GOODALL, DONALD TERRY, BLAKEHURST, NEW SOUTH WALES 2221, AUSTRALIA AND MILNE, HARVEY MCKENZIE, BLAKEHURST, NEW SOUTH WALES 2221, AUSTRALIA:
2,545,952, CANC. MULTIPLE CLASS, INT. CLS. 20 AND 21.

GOODY PRODUCTS, INC., PEACHTREE CITY, GA:
2,546,366, CANC. INT. CL. 26.

GORDON FOOD SERVICE, INC., GRAND RAPIDS, MI:
2,144,130, CANC. INT. CL. 29.

GORT, KENNETH L., GRANDVILLE, MI:
2,548,187, CANC. INT. CL. 9.

GRACE SCHOOLS, INC., WINONA LAKE, IN:
3,568,378, INT. CL. 41.

GRADER, ROBERT, ELLICOTT CITY, MD:
3,568,637, INT. CL. 41.

GRAFE, JOACHIM K., JACKSONVILLE, FL:
3,568,541, INT. CL. 42.

GRAHL INDUSTRIES, INC., COLDWATER, MI:
2,548,388, CANC. INT. CL. 20.

GRAMERCY CAPITAL MANAGEMENT CORPORATION, NEW YORK, NY:
3,567,739, PUB. 11-11-2008. INT. CL. 36.

GRAND CIRCLE LLC, BOSTON, MA:
3,568,110, INT. CL. 39.

GRAND HOME HOLDINGS INC., GARLAND, TX:
1,481,183, CANC. INT. CL. 42.

GRANDISON BURNSIDE, RICHMOND, VA:
3,567,505, PUB. 11-11-2008. INT. CL. 25.

GRANT, W. GERRY, GETTYSBURG, PA AND REED, JAMES A., HANOVER, PA:
2,547,424, CANC. INT. CL. 9.

GRANUS, JACKIE, ST PAUL, MN:
3,568,521, INT. CL. 25.

GRAPHIC PACKAGING INTERNATIONAL, INC., MAR-
IETTA, GA:
1,492,914, REN. 12-20-08. MULTIPLE CLASS, INT. CLS. 7 AND 16.

GRASS ACT, INC., AUSTIN, TX:
3,566,966, PUB. 11-11-2008. INT. CL. 19.

GRAVES, KATHARINE, BRONXVILLE, NY:
3,566,726, PUB. 11-11-2008. INT. CL. 41.

GRAY COMMUNICATIONS SYSTEMS, INC., ALBANY, GA:
2,145,334, CANC. INT. CL. 38.

GRAY'S AQUA COMPANY LTD., NORTHAMPTON, NEW BRUNSWICK, E7N 1C7, CANADA:
2,545,699, CANC. INT. CL. 32.

GREAT OCEAN WALK PTY LTD, WATTLE HILL, AUS-
TRALIA:
3,566,369, PUB. 11-11-2008. INT. CL. 39.

GREAT PLAINS SOFTWARE, INC., FARGO, ND:
2,547,895, CANC. INT. CL. 9.

GREATER ATLANTA CHRISTIAN SCHOOLS, INC., NOR-
CROSS, GA:
3,566,317, PUB. 11-11-2008. INT. CL. 41.
3,566,318, PUB. 11-11-2008. INT. CL. 41.
3,566,319, PUB. 11-11-2008. INT. CL. 41.
3,566,320, PUB. 11-11-2008. INT. CL. 41.
3,566,321, PUB. 11-11-2008. INT. CL. 41.
3,566,322, PUB. 11-11-2008. INT. CL. 41.

GREATER PHILADELPHIA TOURISM MARKETING COR-
PORATION, PHILADELPHIA, PA:
3,568,372, INT. CL. 41.

GREATMATS.COM, MILLTOWN, WI:
3,567,020, PUB. 11-11-2008. INT. CL. 27.

GREEN APPLE DENTAL MANAGEMENT, LLC, PORT-
LAND, OR:
3,567,205, PUB. 11-11-2008. INT. CL. 44.

GREEN CIRCLE, INC., MOLINE, IL:
2,548,194, CANC. MULTIPLE CLASS, INT. CLS. 9 AND 36.

GREEN-TARANTELLI, HOLLY, ITHACA, NY:
3,568,494, INT. CL. 3.

GREEN, NEIL L., NORTHRIDGE, CA:
2,167,660, REN. 12-23-08. INT. CL. 20.

GREENBACKS BRINGING HOPE FOUNDATION, SALT LAKE CITY, UT:
2,547,181, CANC. INT. CL. 41.

GREENBEST INC., MENLO PARK, CA:
2,143,932, CANC. MULTIPLE CLASS, INT. CLS. 9 AND 21.

- GREENBRIER INTERNATIONAL, INC., CHESAPEAKE, VA:
2,659,022, CANC. INT. CL. 21.
- GREENLEE TEXTRON INC., ROCKFORD, IL:
2,546,216, CANC. INT. CL. 9.
- GREENMASTER INDUSTRIAL CORP., TAIPING, TAIWAN:
3,568,468, INT. CL. 28.
- GREENSTONE LTD., PORTAGE, MI:
2,547,476, CANC. INT. CL. 9.
- GREENWICH INDUSTRIES, L.P., LAKE BLUFF, IL:
2,145,245, CANC. INT. CL. 20.
- GRETТА ENTERPRISES, LLC, NEEDHAM, MA:
3,567,642, PUB. 11-11-2008. INT. CL. 25.
- GRIFFIN, HELEN, MANHATTAN BEACH, CA:
2,546,798, CANC. INT. CL. 25.
- GRINDMASTER CORPORATION, LOUISVILLE, KY:
2,545,849, CANC. MULTIPLE CLASS, INT. CLS. 11 AND 21.
- GROUP JS INTERNATIONAL LTD., NEW YORK, NY:
2,212,925. REN. 12-19-08. INT. CL. 25.
- GRYPHICS, INC., PLYMOUTH, MN:
2,208,761. REN. 12-20-08. INT. CL. 9.
- GSH MPLS FULL SERVICE, L.L.C., MINNEAPOLIS, MN:
3,566,329, PUB. 11-11-2008. INT. CL. 43.
- GS1 US, INC., LAWRENCEVILLE, NJ:
2,548,411, CANC. INT. CL. 41.
- GTE WIRELESS SERVICE CORPORATION, ALPHARETTA, GA:
2,548,536, CANC. INT. CL. 38.
- GTECH CORPORATION, WEST GREENWICH, RI:
2,145,285, CANC. INT. CL. 35.
- GTECH RHODE ISLAND CORPORATION, WEST GREENWICH, RI:
2,547,722, CANC. INT. CL. 9.
- GTEL NETWORKS, INC., WOODBURY, NY:
3,566,852, PUB. 11-11-2008. INT. CL. 42.
- GUANG YAN CORPORATION, WHITESTONE, NY:
2,547,402, CANC. INT. CL. 5.
- GUANGZHOU PULAN ELECT. CO. LTD, GUANGZHOU, CHINA:
3,568,452, INT. CL. 9.
- GUANGZHOU ZHAOYING; HARDWARE CO., LTD, CHINA:
3,567,867, PUB. 11-11-2008. INT. CL. 34.
- GUARANTY BROADCASTING CORPORATION, BATON ROUGE, LA:
2,546,572, CANC. INT. CL. 38.
- GUARDEX, INC., WINSTON-SALEM, NC:
2,547,365, CANC. INT. CL. 42.
- GUARDIAN ANGEL MORTGAGE SERVICES, INC., BOILING SPRINGS, PA:
2,827,355, CANC. INT. CL. 36.
- GUCCI AMERICA, INC., NEW YORK, NY:
3,566,589, PUB. 11-11-2008. INT. CL. 14.
- GUEST SUPPLY, LLC, MONMOUTH JUNCTION, NJ:
3,567,577, PUB. 11-11-2008. INT. CL. 3.
- GUGGENHEIM PRODUCTIONS INC., WASHINGTON DC, DC:
3,566,892, PUB. 11-11-2008. INT. CL. 41.
- GULL TOOL & ENGINEERING CO., INC., WEST WARWICK, RI:
3,566,795, PUB. 11-11-2008. INT. CL. 7.
- GUILLEMOT CORPORATION S.A., CARENTOIR, FRANCE:
2,545,645, CANC. INT. CL. 9.
- GUILTY CORPORATION, PALM SPRINGS, CA TO GUILTY CORPORATION, PALM SPRINGS, CA:
2,300,699, CANC. INT. CL. 25.
- GUINOT, PARIS, FRANCE:
3,566,436, PUB. 11-11-2008. INT. CL. 3.
- GUITAR CENTER, INC., WESTLAKE VILLAGE, CA:
3,568,607, INT. CL. 9.
- GUITTARD CHOCOLATE COMPANY, BURLINGAME, CA:
2,298,331. REN. 12-20-08. INT. CL. 30.
- GULFSTREAM HOME & GARDEN, INC., LEXINGTON, KY:
2,548,533, CANC. MULTIPLE CLASS, INT. CLS. 20 AND 21.
- GUNTHER, JOHAN M., SANTA MONICA, CA:
3,568,031, INT. CL. 37.
- GURRERA, JOSEPH R., NEW YORK, NY:
3,568,000, MULTIPLE CLASS, INT. CLS. 29 AND 30.
- GURU DENIM INC., VERNON, CA:
3,568,127, INT. CL. 25.
- GUSTAVE, TINA S., LADERA RANCH, CA:
2,242,231. REN. 12-23-08. INT. CL. 16.
- GVL INC., LITCHFIELD, MN:
3,568,720, MULTIPLE CLASS, INT. CLS. 7 AND 35.
- GYRO ADVERTISING, INC., PHILADELPHIA, PA, DBA GYRO WORLDWIDE:
3,567,534, PUB. 11-11-2008. INT. CL. 41.
- GYRO ADVERTISING, INC., PHILADELPHIA, PA:
3,567,680, PUB. 11-11-2008. MULTIPLE CLASS, INT. CLS. 25 AND 35.
3,567,681, PUB. 11-11-2008. INT. CL. 35.
- H. E. BUTT GROCERY COMPANY, SAN ANTONIO, TX:
2,547,812, CANC. INT. CL. 35.
- H.E. BUTT GROCERY COMPANY, SAN ANTONIO, TX:
1,480,971, CANC. INT. CL. 30.
- H.H. BROWN SHOE TECHNOLOGIES, INC., GREENWICH, CT:
3,568,162, INT. CL. 10.
- H.J. BAKER & BROS., INC., WESTPORT, CT:
1,480,312, CANC. INT. CL. 1.
- H.J.G. MCLEAN LIMITED, MONTREAL, QUEBEC, CANADA:
1,480,454, CANC. INT. CL. 7.
- H-D MICHIGAN, INC., ANN ARBOR, MI:
2,548,294, CANC. INT. CL. 12.
- HABERSHAM METAL PRODUCTS COMPANY, CORNELIA, GA:
3,566,668, PUB. 11-11-2008. MULTIPLE CLASS, INT. CLS. 6, 11 AND 20.
- HACHETTE FILIPACCHI MEDIA U.S. , INC., NEW YORK, NY:
2,202,666. REN. 12-22-08. MULTIPLE CLASS, INT. CLS. 16 AND 42.
- HADEN GROUP, LLC, NEW YORK, NY:
2,547,047, CANC. INT. CL. 37.
- HAGADONE HOSPITALITY CO., COEUR D'ALENE, ID:
3,567,370, PUB. 11-11-2008. INT. CL. 41.
3,567,437, PUB. 11-11-2008. INT. CL. 44.
- HAIR TEAM 53, LTD., ITASCA, IL:
3,568,599, INT. CL. 3.
- HAIRWHISPER INC., STONEY CREEK, CANADA:
3,566,582, PUB. 11-11-2008. INT. CL. 8.
- HALCOR METAL WORKS S.A., ATHENS, GREECE:
3,567,754, PUB. 4-3-2007. INT. CL. 6.
- HALFHANDICAPGOLF.COM, INC., CATONSVILLE, MD:
2,548,328, CANC. INT. CL. 41.
2,548,329, CANC. INT. CL. 28.
2,548,330, CANC. INT. CL. 41.
2,548,331, CANC. INT. CL. 41.
- HALL, RICHARD C., SEATTLE, WA:
1,481,190, CANC. INT. CL. 9.
- HALLIBURTON ENERGY SERVICES, INC., CARROLLTON, TX, BAROID DRILLING FLUIDS, INC., HOUSTON, TX:
1,562,894. REN. 12-22-08. INT. CL. 1.
- HALLMARK LICENSING, INC., KANSAS CITY, MO:
2,547,943, CANC. INT. CL. 16.
- HALLOWEEN ZONE, LLC, THE, DURHAM, NC:
2,144,464, CANC. INT. CL. 35.
- HAMA FOODSERVICE GESMBL, GITZEN 172, AUSTRIA:
2,546,472, CANC. MULTIPLE CLASS, INT. CLS. 29 AND 30.
- HAMILTON & BOND ADVERTISING, INC., MONTGOMERY, IL:
2,217,981. REN. 12-19-08. INT. CL. 42.
- HAMILTON BEACH BRANDS, INC., GLEN ALLEN, VA:
2,548,113, CANC. INT. CL. 7.
- HAMMEROCK EQUIPMENT INC., SURREY, CANADA:
3,566,451, PUB. 11-11-2008. INT. CL. 7.
- HAN JOO RESTAURANT, INC., FLUSHING, NY:
2,546,354, CANC. INT. CL. 42.

HANDCRAFT MANUFACTURING CORP., NEW YORK, NY:
2,547,545, CANC. INT. CL. 25.

HANDS TO HEARTS INTERNATIONAL, PORTLAND, OR:
3,567,607, PUB. 11-11-2008. INT. CL. 41.

HANS LUTH INTERNATIONAL A/S AF 1979, SLAGELSE, DENMARK TO GET ASSET MANAGEMENT A/S:
1,480,523, CANC. INT. CL. 9.

HANSEL 'N GRETEL BRAND, INC., GLENDALE, NY:
3,568,602, INT. CL. 29.

HANSEN, DON LEE, EVERETT, WA:
2,547,850, CANC. MULTIPLE CLASS, INT. CLS. 9 AND 16.

HANSEN, DUANE, FORT MILL, SC:
1,480,586, CANC. INT. CL. 9.

HARD ROCK HOTEL, INC., LAS VEGAS, NV:
3,567,750, PUB. 7-25-2006. INT. CL. 43.
3,567,751, PUB. 1-23-2007. INT. CL. 43.

HARDMAN, DAVID, MELBOURNE, FL:
3,567,397, PUB. 11-11-2008. INT. CL. 25.

HARES DE MEXICO, S.A. DE C.V., MONTERREY, MEXICO:
3,567,567, PUB. 11-11-2008. INT. CL. 10.

HARIDAN'S CATCH INCORPOREAL, LOS ANGELES, CA:
1,480,377, CANC. INT. CL. 3.

HARKNESS INDUSTRIES, INC., CHESHIRE, CT:
2,547,480, CANC. INT. CL. 9.

HARLEYSVILLE MUTUAL INSURANCE COMPANY, HARLEYSVILLE, PA:
1,481,111, CANC. INT. CL. 41.

HARPO, INC., CHICAGO, IL:
3,568,259, INT. CL. 35.

HARRIS, KATHERINE A., CLAREMONT, CA AND BRAYTON, THOMAS F., CLAREMONT, CA:
3,567,306, PUB. 11-11-2008. INT. CL. 41.

HARRIS, REBECCA D., COLORADO SPRINGS, CO AND HARRIS, ANGELA M., COLORADO SPRINGS, CO:
3,566,291, PUB. 11-11-2008. MULTIPLE CLASS, INT. CLS. 3 AND 9.

HARRISON ALLOYS, INC., HARRISON, NJ:
1,480,441, CANC. MULTIPLE CLASS, INT. CLS. 6 AND 9.

HARRISON VENTURES, INC., CHAPEL HILL, NC:
2,547,187, CANC. INT. CL. 35.

HARRISON, NANCY F., NASHVILLE, TN:
2,546,272, CANC. INT. CL. 41.

HARRISON, SHELTON E., CULVER CITY, CA:
3,567,288, PUB. 11-11-2008. INT. CL. 41.

HARTFORD COMPUTER GROUP, INC., INVERNESS, IL:
2,213,049, REN. 12-22-08. INT. CL. 35.
2,236,684, REN. 12-22-08. INT. CL. 35.

HARTFORD MANAGEMENT GROUP, INC., HOUSTON, TX:
1,481,180, CANC. INT. CL. 42.

HARTLAND FUEL PRODUCTS, L.L.C., ROCHESTER, MN:
2,547,849, CANC. INT. CL. 35.

HASBRO, INC., PAWTUCKET, RI:
2,547,340, CANC. INT. CL. 28.

HASHIMI, KAMAL S., ANTIOCH, CA:
3,566,574, PUB. 11-11-2008. INT. CL. 35.

HATANAKA, MINORU, TOKYO, JAPAN:
3,568,431, INT. CL. 41.

HAVEL'S INCORPORATED, CINCINNATI, OH:
3,567,477, PUB. 11-11-2008. INT. CL. 10.

HAVELLS SYLVANIA FIXTURES UK LIMITED, EAST SUSSEX, UNITED KINGDOM:
2,144,869, CANC. INT. CL. 11.

HAWAII GLOBAL EXCHANGE, INC., HONOLULU, HI, DBA PACIFIC TELECARD & WIRELESS:
3,567,031, PUB. 11-11-2008. INT. CL. 16.

HAWS ELLIOTT LIMITED, WARLEY, WEST MIDLANDS, ENGLAND:
1,495,834, REN. 12-22-08. INT. CL. 21.

HAYMAN, FRED J., BEVERLY HILLS, CA:
2,155,674, REN. 12-19-08. INT. CL. 3.

HAYWARD POOL CLEANERS CORP., ELIZABETH, NJ:
1,107,778, REN. 12-19-08. INT. CL. 7.

HBI BRANDED APPAREL ENTERPRISES, LLC, WINSTON-SALEM, NC:
3,568,345, INT. CL. 25.

HCL JAMES MARTIN, INC., FAIRFAX, VA:
2,547,899, CANC. INT. CL. 42.
2,547,981, CANC. INT. CL. 42.

HD MEDICAL GROUP, LIMITED, MELBOURNE, AUSTRALIA:
3,567,767, PUB. 11-11-2008. INT. CL. 10.

HEAD SPORT AG, A-6921 KENNELBACH, AUSTRIA:
2,548,353, CANC. INT. CL. 28.

HEADMINDER, INC., NEW YORK, NY:
2,548,157, CANC. MULTIPLE CLASS, INT. CLS. 9 AND 42.

HEALING FLOW YOGA AND RETREAT MINISTRIES LLC, NAPERVILLE, IL:
3,568,548, MULTIPLE CLASS, INT. CLS. 41 AND 45.

HEALTH CENTER FOR BETTER LIVING, INC., NAPLES, FL:
2,545,511, CANC. INT. CL. 5.

HEALTH FLEX TECHNOLOGIES, INC, MIAMI, FL:
3,568,645, INT. CL. 28.

HEALTH INSURANCE PLAN OF GREATER NEW YORK, NEW YORK, NY:
2,231,631, REN. 12-19-08. INT. CL. 36.

HEALTH STRATEGIES NETWORK, INC., DENVER, CO:
2,546,514, CANC. INT. CL. 35.

HEALTH SYSTEMS INTERNATIONAL, INC., MIAMI BEACH, FL:
3,567,759, PUB. 11-11-2008. INT. CL. 5.

HEALTHCARE DISCOVERIES, SAN ANTONIO, TX, DBA ICON DEVELOPMENT SOLUTIONS:
3,566,925, PUB. 11-11-2008. INT. CL. 42.

HEALTHCARE INTERNET TECHNOLOGIES, INC., DULUTH, GA, DBA SENIORPLANET.COM:
2,548,180, CANC. MULTIPLE CLASS, INT. CLS. 35, 41 AND 42.

HEALTHDIRECTOR.COM, INCLINE VILLAGE, NV:
2,545,694, CANC. INT. CL. 42.

HEALTHENET, ST. CLAIR SHORES, MI:
2,545,690, CANC. INT. CL. 41.

HEALTHY LIFESTYLE CHOICES, NEW ORLEANS, LA:
3,566,845, PUB. 11-11-2008. INT. CL. 35.

HEAR YOUR HOROSCOPE, LLC, LAGUNA BEACH, CA:
3,568,785, INT. CL. 35.
3,568,786, INT. CL. 45.

HEARTLAND FOOD PRODUCTS, INC., WESTWOOD, KS:
2,548,627, CANC. INT. CL. 30.

HEARTLAND STUDIO'S, INCORPORATED, OREGON, IL:
3,568,693, INT. CL. 9.

HEAVENLY ELECTRONICS, HOUSTON, TX:
2,143,939, CANC. INT. CL. 9.

HEAVY COVER, INC., MARICOPA, AZ:
3,567,046, PUB. 11-11-2008. INT. CL. 20.

HEDRICH, CHRIS K., RINGLING, MT AND HEDRICH, BARRY R., RINGLING, MT:
2,548,046, CANC. INT. CL. 25.

HELEN OF TROY LIMITED, ST. MICHAEL, BARBADOS:
2,547,902, CANC. INT. CL. 26.

HELENA LABORATORIES CORPORATION, BEAUMONT, TX:
3,568,397, INT. CL. 10.

HELPMAN, JANIS, FULLERTON, CA:
3,566,803, PUB. 11-11-2008. INT. CL. 14.

HELMAN GROUP, LTD., THE, OXNARD, CA:
2,145,252, CANC. INT. CL. 20.

HELSINN HEALTHCARE SA, 6912 PAZZALLO, SWITZERLAND:
3,567,729, PUB. 10-11-2005. INT. CL. 5.

HELTON, DON D., JR., MACON, GA:
3,568,167, INT. CL. 8.

HEMASURE, INC., MARLBOROUGH, MA:
2,547,602, CANC. INT. CL. 10.

HEMATOLOGY-ONCOLOGY ASSOCIATES OF CENTRAL NEW YORK, P.C., E. SYRACUSE, NY:
3,567,746, PUB. 11-11-2008. INT. CL. 44.

HEN-FEATHERS CORPORATION, KING OF PRUSSIA, PA:
2,545,742, CANC. MULTIPLE CLASS, INT. CLS. 20 AND 21.

HENDRICKS HOLDING COMPANY, INC., БЕЛОIT, WI:
2,547,727, CANC. MULTIPLE CLASS, INT. CLS. 7, 11

- AND 16.
 HENKEL CORPORATION, GULPH MILLS, PA:
 3,567,664, PUB. 11-11-2008. INT. CL. 17.
 HENLEY, KARYN, NASHVILLE, TN:
 2,144,640, CANC. INT. CL. 9.
 HENRY-GRIFFITTS, INC., HAYDEN, ID:
 1,507,307. REN. 12-23-08. INT. CL. 28.
 HEON YONG LEE, REPUBLIC OF KOREA:
 3,567,889, PUB. 11-11-2008. INT. CL. 43.
 HER MAJESTY THE QUEEN IN RIGHT OF CANADA, AS
 REPRESENTED BY THE DEPARTMENT OF FISHERIES
 AND OCEANS, OTTAWA, ONTARIO, K1A 0E6, CANADA:
 2,237,200. REN. 12-19-08. INT. CL. 20.
 HERAEUS KULZER GMBH, D-63450 HANAU, FED REP
 GERMANY:
 3,566,279, PUB. 9-9-2008. MULTIPLE CLASS, INT. CLS. 1,
 5, 9 AND 10.
 HERAEUS NOBLELIGHT GMBH, 63450 HANAU, FED REP
 GERMANY:
 2,545,874, CANC. MULTIPLE CLASS, INT. CLS. 9 AND
 10.
 HERB'S SEAFOOD, LLC, MIAMI, FL:
 2,548,199, CANC. INT. CL. 29.
 HERCULES INCORPORATED, WILMINGTON, DE:
 1,480,802, CANC. INT. CL. 17.
 HERGET, MICHAEL P., MISSION VIEJO, CA:
 2,547,223, CANC. INT. CL. 30.
 HERITAGE DESIGNS, L.L.C., PHOENIX, AZ:
 2,547,774, CANC. INT. CL. 9.
 HERITAGE MINT, LTD., SCOTTSDALE, AZ:
 2,548,623, CANC. INT. CL. 21.
 HERMAN MILLER, INC., ZEELAND, MI:
 2,548,385, CANC. INT. CL. 35.
 HERMES INTERNATIONAL, FRANCE:
 3,567,940, PUB. 11-11-2008. INT. CL. 18.
 HERRIN PUBLISHING PARNTERS, LP, PAOLI, PA:
 2,548,620, CANC. MULTIPLE CLASS, INT. CLS. 9 AND
 42.
 HERSHEY ASSOCIATES, SANTA MONICA, CA:
 3,566,632, PUB. 11-11-2008. INT. CL. 41.
 HERSHEY CHOCOLATE & CONFECTIONERY CORPORA-
 TION, WHEAT RIDGE, CO:
 3,567,527, PUB. 11-11-2008. INT. CL. 30.
 3,567,529, PUB. 11-11-2008. INT. CL. 30.
 3,567,531, PUB. 11-11-2008. INT. CL. 30.
 HESTA BETEILIGUNGS UND VERWALTUNGS GMBH,
 ZURICH, SWITZERLAND:
 2,143,829, CANC. INT. CL. 9.
 HEWLETT-PACKARD COMPANY, PALO ALTO, CA:
 2,546,631, CANC. INT. CL. 42.
 HG HOLDINGS (INTERNATIONAL) CORP., VANCOUVER,
 CANADA:
 3,567,747, PUB. 4-8-2008. MULTIPLE CLASS, INT. CLS. 29
 AND 30.
 HI LIMITED PARTNERSHIP, CLEARWATER, FL:
 3,568,638, INT. CL. 30.
 HI-FIVE PRODUCTS DEVELOPING CO., LTD., TAICHUNG,
 TAIWAN:
 2,277,807. REN. 12-20-08. INT. CL. 8.
 HI-TECH INDUSTRIES, INC., SOUTHFIELD, MI:
 3,568,081, INT. CL. 21.
 HI-TECH TRANSPORT ELECTRONICS, INC., EUGENE, OR:
 2,266,442. REN. 12-19-08. INT. CL. 42.
 HICKORY BUSINESS FURNITURE LLC, HICKORY, NC:
 3,566,619, PUB. 11-11-2008. MULTIPLE CLASS, INT. CLS.
 18 AND 24.
 3,566,620, PUB. 11-11-2008. MULTIPLE CLASS, INT. CLS.
 18 AND 24.
 HIGH DESERT PHARMACEUTICS, INC., RENO, NV:
 3,568,510, INT. CL. 3.
 3,568,511, INT. CL. 5.
 3,568,512, INT. CL. 3.
 3,568,513, INT. CL. 3.
 HIGH FALLS BREWING COMPANY, LLC, ROCHESTER,
 NY:
 3,566,767, PUB. 11-11-2008. INT. CL. 32.
 HIGH TOP PRODUCTS CORPORATION, MIAMI, FL:
 2,546,534, CANC. INT. CL. 29.
 HILITE INTERNATIONAL, INC., CLEVELAND, OH:
 3,567,997, MULTIPLE CLASS, INT. CLS. 16 AND 42.
 HILL COUNTRY SPRING WATER OF TEXAS, INC., SAN
 ANTONIO, TX:
 1,480,998, CANC. INT. CL. 32.
 HILL-ROM SERVICES, INC., BATESVILLE, IN, NAVICARE
 SYSTEMS, INC., ST. PAUL, MN:
 2,247,157. REN. 12-19-08. INT. CL. 9.
 HILL, JEFF A, SHINGLE SPRINGS, CA:
 3,566,766, PUB. 11-11-2008. INT. CL. 11.
 HILLERICH & BRADSBY CO., LOUISVILLE, KY:
 2,354,632, CANC. INT. CL. 1.
 HIMSTEDT, ANNETTE, 33100 PADERBORN, FED REP
 GERMANY:
 2,546,164, CANC. MULTIPLE CLASS, INT. CLS. 16 AND
 28.
 HINSHAW & CULBERTSON, MINNEAPOLIS, MN:
 2,548,276, CANC. INT. CL. 35.
 HISOFTWARE INC., NASHUA, NH:
 2,546,052, CANC. INT. CL. 9.
 HISTORIC JONESBOROUGH TOURISM COOPERATIVE,
 INC., JONESBOROUGH, TN:
 2,546,682, CANC. INT. CL. 35.
 HITCHIN, JOHN, SAN ANTONIO, IBIZA, SPAIN:
 2,546,306, CANC. INT. CL. 32.
 HLP CLEAR PACKAGING PRODUCTS (U.S.A.), INC.,
 TORRANCE, CA:
 3,567,434, PUB. 11-11-2008. INT. CL. 20.
 HLP CLEAR PACKAGING PRODUCTS (USA), INC., TOR-
 RANCE, CA:
 3,567,372, PUB. 11-11-2008. INT. CL. 20.
 HMP COMMUNICATIONS, LLC, MALVERN, PA:
 3,567,395, PUB. 11-11-2008. INT. CL. 16.
 HNTB HOLDINGS LTD, KANSAS CITY, MO:
 3,568,629, INT. CL. 9.
 HOCKEY HALL OF FAME AND MUSEUM, TORONTO,
 M5E 1X8, CANADA:
 3,566,547, PUB. 9-9-2008. MULTIPLE CLASS, INT. CLS. 16
 AND 41.
 HOECHST AKTIENGESELLSCHAFT, 5831 AN BOXMEER,
 NETHERLANDS:
 1,107,717. REN. 12-22-08. INT. CL. 5.
 HOFFORD, JAMES L., WASHINGTON, NH:
 3,568,225, INT. CL. 9.
 HOFMANN SAUSAGE COMPANY, INC., SYRACUSE, NY:
 1,480,923, CANC. INT. CL. 29.
 HOHENSEE, MATTHIAS, APTOS, CA:
 3,568,584, INT. CL. 42.
 HOLCIM IP LTD, SWITZERLAND:
 3,567,850, PUB. 11-11-2008. MULTIPLE CLASS, INT. CLS.
 4, 39, 40 AND 42.
 HOLIDAY HOSPITALITY CORPORATION, ATLANTA, GA:
 2,144,734, CANC. INT. CL. 42.
 HOLLAND USA, INC., NORTH MANKATO, MN:
 2,281,354. REN. 12-22-08. INT. CL. 42.
 HOLLARD HERVE, FRANCE:
 3,567,806, PUB. 11-11-2008. MULTIPLE CLASS, INT. CLS.
 9 AND 25.
 HOLLEY PERFORMANCE PRODUCTS, INC., BOWLING
 GREEN, KY:
 3,568,034, INT. CL. 7.
 HOLLIS LANKFORD INDUSTRIES, INC., EVANSVILLE,
 IN:
 2,547,892, CANC. INT. CL. 28.
 HOLMAN & MOODY, INC., CHARLOTTE, NC:
 3,566,659, PUB. 11-11-2008. MULTIPLE CLASS, INT. CLS.
 25 AND 28.
 HOLSOCOE PRECISION TOOLING INC., WHITBY, ONTAR-
 IO, CANADA:
 3,567,781, PUB. 2-19-2008. INT. CL. 28.
 HOME BOX OFFICE, INC., NEW YORK, NY:
 3,567,148, PUB. 11-11-2008. INT. CL. 41.
 HOMEAWAY, INC., AUSTIN, TX:
 3,566,394, PUB. 11-11-2008. MULTIPLE CLASS, INT. CLS.
 39 AND 43.
 HOMEOWNERS.COM, INC., SAN FRANCISCO, CA:
 2,545,847, CANC. MULTIPLE CLASS, INT. CLS. 35, 36
 AND 42.

HOMER TLC, INC., CLAYMONT, DE:
2,144,416, CANC. INT. CL. 39.
2,144,417, CANC. INT. CL. 39.

HOMESTAT FARM, LTD., DUBLIN, OH:
3,567,469, PUB. 11-11-2008. INT. CL. 30.

HOMESTORE, INC., WESTLAKE VILLAGE, CA:
2,143,892, CANC. INT. CL. 42.

HOMESUBLIME, LLC, WASHINGTON, DC:
2,546,085, CANC. INT. CL. 35.

HONEYWELL INTERNATIONAL INC., MORRISTOWN, NJ:
881,262, REN. 12-19-08. U.S. CL. 34 (INT. CL. 9).
2,295,113, REN. 12-19-08. INT. CL. 9.

HONG SAM NARA, CORP., RIDGEFIELD, NJ:
3,568,727, INT. CL. 5.

HOOKLOGIC, INC., NEW YORK, NY:
3,567,260, PUB. 11-11-2008. INT. CL. 35.

HOOVER, RICHARD L., CAREFREE, AZ AND LEWIN,
WENDY, PHOENIX, AZ:
2,145,351, CANC. INT. CL. 28.

HOPE CHEST FOR BREAST CANCER FOUNDATION,
WAYZATA, MN:
3,567,170, PUB. 11-11-2008. INT. CL. 35.

HOPE'S GIFT - INTERNATIONAL, SAN DIMAS, CA:
2,546,993, CANC. INT. CL. 35.

HORNBY, AMY, DUNWOODY, GA:
3,566,974, PUB. 11-11-2008. INT. CL. 25.

HORNELL BREWING COMPANY, INC., LAKE SUCCESS,
NY:
2,143,858, CANC. INT. CL. 32.

HORTAU INC., SAINT-ROMUALD (QUEBEC), CANADA:
3,566,534, PUB. 11-11-2008. MULTIPLE CLASS, INT. CLS.
37 AND 42.

HOSANNA, ALBUQUERQUE, NM:
3,567,007, PUB. 11-11-2008. MULTIPLE CLASS, INT. CLS.
9 AND 41.

HOSPICE ASSOCIATION OF CAPE COD, INC., HYANNIS,
MA:
2,548,131, CANC. MULTIPLE CLASS, INT. CLS. 41 AND
42.

HOSPICOMM, INC., PHILADELPHIA, PA:
3,566,484, PUB. 11-11-2008. INT. CL. 44.

HOSPITALITY PARTNERS, LLC, ARLINGTON HEIGHTS,
IL:
3,567,646, PUB. 11-11-2008. INT. CL. 41.

HOT STUFF FOODS, LLC, SIOUX FALLS, SD:
3,568,233, INT. CL. 43.

HOTLIX, INC., GROVER BEACH, CA:
3,567,533, PUB. 11-11-2008. INT. CL. 29.

HOTSEXYFIT, NEW YORK, NY:
3,567,511, PUB. 11-11-2008. INT. CL. 25.

HOWELL KDS L.L.C., MADISON, WI:
3,566,928, PUB. 11-11-2008. INT. CL. 16.

HOYA CORPORATION, TOKYO, JAPAN:
2,547,404, CANC. INT. CL. 9.
2,547,949, CANC. INT. CL. 9.

HP HOOD LLC, LYNNFIELD, MA:
2,209,259, REN. 12-19-08. INT. CL. 29.

HRNCIRIK, TOM, WOODLAKE, CA:
2,545,502, CANC. INT. CL. 1.

HSN LP, ST. PETERSBURG, FL:
2,546,521, CANC. INT. CL. 41.
3,568,184, INT. CL. 38.

HUANG, HUA, PAWTUCKET, RI:
3,567,525, PUB. 11-11-2008. INT. CL. 25.

HUBBARDTON FORGE, LLC, CASTLETON, VT:
3,566,567, PUB. 11-11-2008. INT. CL. 11.

HUBBELL INCORPORATED, ORANGE, CT:
2,144,455, CANC. INT. CL. 11.

HUFFMASTER COMPANIES, TROY, MI:
3,566,748, PUB. 11-11-2008. MULTIPLE CLASS, INT. CLS.
35, 36 AND 45.

HUMAN FINANCIAL, LLC, AUSTIN, TX, DBA HUMAN
FINANCIAL:
3,567,443, PUB. 11-11-2008. INT. CL. 36.

HUMAN INFERENCE ENTERPRISE B.V., 6824 BH, ARN-
HEM, NETHERLANDS:
2,546,043, CANC. INT. CL. 9.

HUNG FUNG GROUP HOLDINGS LIMITED, HAMILTON
HM 11, BERMUDA:
2,547,617, CANC. INT. CL. 28.

HUNT ASSISTED LIVING, L.L.C., ARLINGTON, VA:
2,545,682, CANC. INT. CL. 42.

HUNT, JAMES B., PALOS VERDES PENINSULA, CA:
3,567,380, PUB. 11-11-2008. INT. CL. 35.

HUNTER IMMUNOLOGY LTD, AUSTRALIA:
3,567,976, PUB. 11-11-2008. INT. CL. 5.

HUNTSMAN GROUP INTELLECTUAL PROPERTY HOLD-
INGS CORPORATION, SALT LAKE CITY, UT:
2,231,021, REN. 12-24-08. INT. CL. 1.

HURON CONSULTING GROUP INC., CHICAGO, IL:
3,566,372, PUB. 11-11-2008. MULTIPLE CLASS, INT. CLS.
35, 36 AND 45.

HUSH TOURS, INC, NEW YORK, NY:
3,567,431, PUB. 11-11-2008. INT. CL. 39.

HUTCHINS, CARA, PRIDES CROSSING, MA:
3,566,862, PUB. 11-11-2008. INT. CL. 35.

HUTCHINS, DONALD C., SPRINGFIELD, MA:
2,145,163, CANC. MULTIPLE CLASS, INT. CLS. 9, 41
AND 42.

HUTSCHENREUTHER CORPORATION, NORTH BRAN-
FORD, CT TO HUTSCHENREUTHER AKTIENGE-
SELLSCHAFT, 6872 SELB, FED REP GERMANY:
1,480,833, CANC. INT. CL. 21.

HYDRANAUTICS, INC., OCEANSIDE, CA:
2,547,745, CANC. INT. CL. 11.

HYDRO-QUEBEC, MONTREAL, QUEBEC, CANADA:
2,218,420, REN. 12-22-08. INT. CL. 39.

HYPERLINK INSURANCE SOLUTIONS, SALISBURY, NC:
3,567,060, PUB. 11-11-2008. INT. CL. 36.

HYPOGUARD LIMITED, SUFFOLK, UNITED KINGDOM:
2,144,675, CANC. INT. CL. 10.

HYRAN MEDIA SERVICES, INC., WOODINVILLE, WA:
3,568,399, INT. CL. 35.

HYUNDAI MOTOR AMERICA, FOUNTAIN VALLEY, CA:
2,266,884, REN. 12-19-08. INT. CL. 12.

HYUNDAI TRANSLEAD, SAN DIEGO, CA:
3,568,343, INT. CL. 12.
3,568,344, INT. CL. 12.

I AM 3RD.COM, INC., COPPELL, TX:
2,548,101, CANC. INT. CL. 42.

I D SERVICES, INC., COLUMBUS, GA:
3,568,792, INT. CL. 35.

I.C.E.D. MANAGEMENT, INC., WILMINGTON, DE:
1,480,780, CANC. INT. CL. 16.

IACOCCA, LEE, BOSTON, MA:
3,566,533, PUB. 11-11-2008. INT. CL. 29.

IAM HAWAII, LLC, HONOLULU, HI:
3,566,393, PUB. 11-11-2008. INT. CL. 41.

IBASIS, INC., BURLINGTON, MA:
3,568,169, INT. CL. 16.

IBB TECHNOLOGY GMBH, D-64846 GROSS-ZIMMERN,
FED REP GERMANY:
2,547,888, CANC. MULTIPLE CLASS, INT. CLS. 9 AND
42.

IBT EDUCATION LIMITED, CHURCHLANDS WA 6018,
AUSTRALIA:
3,567,833, PUB. 11-11-2008. MULTIPLE CLASS, INT. CLS.
16, 35 AND 41.

ICARUMBA, INC., BOTHELL, WA:
2,548,030, CANC. MULTIPLE CLASS, INT. CLS. 35, 37
AND 42.

ICBA BANCARD, INC., WASHINGTON, DC:
2,194,908, REN. 12-22-08. INT. CL. 16.

ICE QIK, LLC, MYRTLE BEACH, SC:
3,567,452, PUB. 11-11-2008. INT. CL. 11.

ICELAND AMERICA ENERGY, INC., LOS ANGELES, CA,
DBA ICELAND AMERICA ENERGY:
3,567,006, PUB. 11-11-2008. INT. CL. 40.

IDEALAND LLC, ATLANTA, GA:
3,567,595, PUB. 11-11-2008. INT. CL. 35.

IDEAL55 WINE LOCKERS, INC., HERMOSA BEACH, CA:
3,567,090, PUB. 11-11-2008. INT. CL. 39.

IDEARC MEDIA CORP., DALLAS/FORTH WORTH AIR-
PORT, TX:
2,546,355, CANC. INT. CL. 35.

- IFEELU INC., GASAN-DONG; GEUMCHEON-GU; SEOUL, REPUBLIC OF KOREA:
3,567,974, PUB. 11-11-2008. INT. CL. 9.
- IGN ENTERTAINMENT, INC., BRISBANE, CA:
3,568,589, INT. CL. 38.
- IGT, RENO, NV:
2,144,976, CANC. INT. CL. 9.
- IGUIDE, INC., WALTHAM, MA:
3,568,651, MULTIPLE CLASS, INT. CLS. 35 AND 42.
- IHBA, INC. ENGLEWOOD CLIFFS, NJ:
2,546,475, CANC. INT. CL. 3.
- IHFC PROPERTIES, LLC, HIGH POINT, NC:
3,566,563, PUB. 11-11-2008. INT. CL. 35.
3,566,564, PUB. 11-11-2008. INT. CL. 35.
- IHISPANO.COM, LLC, CHICAGO, IL:
3,567,076, PUB. 11-11-2008. MULTIPLE CLASS, INT. CLS. 35 AND 41.
- IKONICS CORPORATION, DULUTH, MN:
3,567,137, PUB. 11-11-2008. INT. CL. 1.
- IKOS SYSTEMS, INC., CUPERTINO, CA TO MENTOR GRAPHICS CORPORATION, WILSONVILLE, OR:
2,144,608, CANC. INT. CL. 9.
- IL PONTE FINANZIARIA S.P.A., SCANDICCI (FLORENCE), ITALY:
2,546,017, CANC. INT. CL. 25.
- ILC TRADEMARK CORP., TORTOLA, BR. VIRGIN ISLANDS:
1,107,860, REN. 12-19-08. MULTIPLE CLASS, INT. CLS. 9, 14, 16, 18, 24 AND 25.
- ILLINOIS TOOL WORKS INC., GLENVIEW, IL:
2,222,216, REN. 12-19-08. INT. CL. 21.
2,226,124, REN. 12-19-08. INT. CL. 21.
- ILLUSION TECHNOLOGIES INTERNATIONAL INC., VANCOUVER, WA, DBA INSTRUCIONAL TECNOLOGIES INC.:
2,546,632, CANC. INT. CL. 9.
- IMAGE GRAPHICS, INC., SHELTON, CT:
2,545,527, CANC. INT. CL. 9.
- IMAGE SENSING SYSTEMS, INC., ST. PAUL, MN:
2,548,613, CANC. INT. CL. 9.
- IMAGE TO INTERIOR INC., VANCOUVER, BC, CANADA:
3,566,398, PUB. 11-11-2008. MULTIPLE CLASS, INT. CLS. 16 AND 42.
- IMAGENATION CORPORATION, PORTLAND, OR:
2,547,698, CANC. INT. CL. 9.
- IMAGESPAN, INC., SAUSALITO, CA:
3,566,480, PUB. 11-11-2008. MULTIPLE CLASS, INT. CLS. 35, 38 AND 42.
- IMAGIFORCE, INC., TAMPA, FL:
1,512,479, REN. 12-20-08. INT. CL. 9.
- IMCERA BIOPRODUCTS, INC., TERRE HAUTE, IN TO MALLINCKRODT SPECIALTY CHEMICALS COMPANY, ST. LOUIS, MO:
1,480,332, CANC. INT. CL. 1.
- IMMUNOTEC INC., VAUDREUIL-DORIONQUEBEC, CANADA:
3,568,284, MULTIPLE CLASS, INT. CLS. 3, 5, 29 AND 32.
- IMO'S FRANCHISING, INC., ST. LOUIS, MO:
1,518,522, REN. 12-19-08. INT. CL. 42.
- IMPACT CONFECTIONS, INC., COLORADO SPRINGS, CO:
2,548,581, CANC. INT. CL. 30.
- IMPACT NUTRITION, INC., AURORA, CO:
2,547,230, CANC. INT. CL. 25.
- IMPACTO PROTECTIVE PRODUCTS INC., BELLEVILLE, ONTARIO K8N 5B2, CANADA:
2,545,641, CANC. INT. CL. 25.
- IMPERIAL BIRD'S NEST INTERNATIONAL CO. LIMITED, MONGKOK, KOWLOON, HONG KONG:
3,568,100, INT. CL. 35.
3,568,101, INT. CL. 35.
- IMPERIAL COUNCIL OF SHRINERS ANCIENT ARABIC ORDER NOBLES OF THE MYSTIC SHRINE (AAONMS) NATIONAL COMPACT USA, DAYTON, OH:
3,568,583, U.S. CL. 200.
- IMPROVENET, INC., REDWOOD CITY, CA:
2,548,223, CANC. INT. CL. 37.
- IN ART & FURNITURE GALLERY, INC., MIAMI, FL:
2,546,307, CANC. INT. CL. 35.
- IN SHAPE HEALTH CLUBS, INC., STOCKTON, CA:
3,566,964, PUB. 11-11-2008. INT. CL. 41.
3,566,971, PUB. 11-11-2008. INT. CL. 41.
3,566,972, PUB. 11-11-2008. INT. CL. 41.
- IN TOUCH DIRECT, INC., OVERLAND PARK, KS:
2,548,437, CANC. INT. CL. 16.
- IN ZONE BRANDS, INC., SMYRNA, GA:
3,567,597, PUB. 11-11-2008. INT. CL. 32.
- INALFA ROOF SYSTEMS GROUP B.V., 5804 AB VENRAY, NETHERLANDS:
2,218,357, REN. 12-24-08. MULTIPLE CLASS, INT. CLS. 12 AND 40.
- INDEPENDENT CHIROPRACTIC EXAMINERS SOCIETY INC., OLD BETHPAGE, NY:
2,545,943, CANC. MULTIPLE CLASS, INT. CLS. 41 AND 42.
- INDEPENDENT INSURANCE AGENTS & BROKERS OF AMERICA, INC., ALEXANDRIA, VA:
2,547,783, CANC. INT. CL. 42.
- INDIGGO ASSOCIATES, INC., ROCKVILLE, MD:
3,567,226, PUB. 11-11-2008. INT. CL. 35.
3,567,228, PUB. 11-11-2008. INT. CL. 35.
- INDIGO N.V., 622G GA MAASTRICHT, NETHERLANDS:
2,547,692, CANC. MULTIPLE CLASS, INT. CLS. 7 AND 9.
- INDIVISUAL LEARNING, LLC, ST. PAUL, MN:
2,546,942, CANC. INT. CL. 41.
- INDOPCO, INC., BRIDGEWATER, NJ, DBA NATIONAL STARCH & CHEMICAL COMPANY:
2,546,885, CANC. INT. CL. 7.
- INDRA'S GATE, MILWAUKEE, WI:
2,547,487, CANC. INT. CL. 42.
- INDUCTOTHERM CORP., RANOCAS, NJ:
3,567,113, PUB. 11-11-2008. INT. CL. 11.
- INDUSTRIA DE DISEÑO TEXTIL, S.A., CORUNA, SPAIN, AKA INDITEX S.A.:
2,546,684, CANC. INT. CL. 35.
- INDUSTRIA LA POPULAR, S.A., GUATEMALA CITY, GUATEMALA:
3,568,361, INT. CL. 3.
- INDUSTRIAL ACOUSTICS COMPANY, INC., BRONX, NY:
848,655, REN. 12-23-08. U.S. CL. 34 (INT. CL. 11).
- INDUSTRIAL DEVELOPMENTS INTERNATIONAL, INC., ATLANTA, GA:
2,202,844, REN. 12-20-08. MULTIPLE CLASS, INT. CLS. 36 AND 37.
- INDUSTRIAS PUNTI BLOND TENAX, S.A., BARCELONA, SPAIN:
3,568,224, INT. CL. 21.
- INFACOTRY INNOVATIONS & TRADE GMBH, AUSTRIA:
3,567,812, PUB. 11-11-2008. MULTIPLE CLASS, INT. CLS. 9 AND 14.
- INFORMATION BUILDERS, INC., NEW YORK, NY:
2,248,562, REN. 12-20-08. INT. CL. 9.
- INFORMEDRX, INC., LISLE, IL:
3,567,643, PUB. 11-11-2008. INT. CL. 35.
- INGENIO DEL CAUCA S.A., VALLE DEL CAUCA, COLOMBIA:
3,568,591, INT. CL. 30.
- INLAND COASTAL CONSTRUCTION LLC, MILFORD, VA:
3,566,919, PUB. 11-11-2008. INT. CL. 37.
- INNOVATIVE ARTS DENTAL LABORATORY INC., HARRISBURG, NC:
2,145,162, CANC. INT. CL. 28.
- INNOVATIVE BUILDING PRODUCTS INC., AJAX, ONTARIO, CANADA:
3,568,154, INT. CL. 19.
- INNOVATIVE GOLF CORPORATION, SCOTTSDALE, AZ:
3,567,733, PUB. 11-11-2008. INT. CL. 9.
3,567,734, PUB. 11-11-2008. INT. CL. 9.
- INNOVATIVE OFFICE PRODUCTS, INC., EASTON, PA:
2,548,610, CANC. INT. CL. 9.
- INOVA INTERACTIVE SARL, CASABLANCA, MOROCCO:
3,567,382, PUB. 11-11-2008. INT. CL. 41.
- INOVATEUS DEVELOPMENT, LLC, SOUTH BEND, IN:
3,566,361, PUB. 11-11-2008. INT. CL. 37.
- INPRIMIS INC., BOCA RATON, FL:
2,546,529, CANC. INT. CL. 42.

- INSIDEOUT LITERARY ARTS PROJECT, DETROIT, MI, DBA INSIDEOUT DETROIT:
3,566,785, PUB. 11-11-2008. INT. CL. 41.
- INSIDERS' PUBLISHING, INC., MANTEO, NC TO MORRIS BOOK PUBLISHING, LLC, AUGUSTA, GA:
2,144,946, CANC. INT. CL. 42.
- INSITE ARCHITECTURE, INC., HOUSTON, TX:
3,566,712, PUB. 11-11-2008. INT. CL. 42.
- INSTITUTE FOR POLICY INNOVATION, LEWISVILLE, TX:
2,548,286, CANC. INT. CL. 16.
- INSTITUTE OF GAS TECHNOLOGY, CHICAGO, IL:
1,480,647, CANC. INT. CL. 9.
- INSTITUTO ESPANOL DE COMERCIO EXTERIOR (ICEX), MARID, SPAIN:
1,521,753, REN. 12-20-08. INT. CL. 16.
- INSTRAS SCIENTIFIC LLC, TEANECK, NJ:
3,568,501, INT. CL. 42.
- INSTRATEX, INC., LOS ANGELES, CA:
3,567,231, PUB. 11-11-2008. INT. CL. 35.
- INSULATION DISTRIBUTORS, INC., EDEN PRAIRIE, MN:
3,567,114, PUB. 11-11-2008. INT. CL. 17.
3,567,117, PUB. 11-11-2008. INT. CL. 17.
3,567,119, PUB. 11-11-2008. INT. CL. 17.
3,567,122, PUB. 11-11-2008. INT. CL. 17.
- INSURANCE TECHNOLOGIES GROUP, INC., PASADENA, CA, DBA WORKCOMPARE, INC.:
3,568,473, MULTIPLE CLASS, INT. CLS. 35 AND 36.
- INTEGRATED SYSTEMS DEVELOPMENT, INC., HOLLAND, MI:
2,548,064, CANC. INT. CL. 9.
- INTEGREYED CONSULTANTS, LLC, CLIFTON, NY:
2,548,043, CANC. INT. CL. 42.
- INTEGRITY PRODUCTS OF SARASOTA, INC., SARASOTA, FL:
3,567,542, PUB. 11-11-2008. INT. CL. 25.
- INTEL CORPORATION, SANTA CLARA, CA:
2,547,564, CANC. INT. CL. 42.
2,547,565, CANC. INT. CL. 42.
- INTELENET COMMISSION, INDIANAPOLIS, IN:
2,546,706, CANC. MULTIPLE CLASS, INT. CLS. 35, 39 AND 41.
- INTELICUS, L.C., OCOEE, FL:
2,546,487, CANC. INT. CL. 41.
- INTELLIGENT COMMUNICATION, INC., FREMONT, CA, AKA INTELLICOM, INC.:
2,547,556, CANC. INT. CL. 9.
- INTELSAT CORPORATION, WILTON, CT:
2,546,901, CANC. INT. CL. 38.
- INTERACTIVE CONSORTIUM, INC., THE, NEW YORK, NY:
2,546,456, CANC. INT. CL. 41.
- INTERACTIVE IMAGINATION CORPORATION, SEATTLE, WA:
2,548,219, CANC. INT. CL. 16.
- INTERACTIVE SPORTS NETWORK, LLC, NEW YORK, NY:
3,567,562, PUB. 11-11-2008. INT. CL. 41.
- INTERACTIVE STUDY SYSTEMS, INC., INDIAN SHORES, FL:
3,566,600, PUB. 11-11-2008. MULTIPLE CLASS, INT. CLS. 9 AND 41.
- INTERBAKE FOODS, INC., RICHMOND, VA:
3,567,197, PUB. 11-11-2008. INT. CL. 30.
- INTERLINK BIOTECHNOLOGIES, LLC, PRINCETON, NJ:
2,548,120, CANC. INT. CL. 1.
2,548,121, CANC. INT. CL. 1.
- INTERNACIONAL DE EVENTOS Y CONCURSOS, C.A. (INTEVCON), CARACAS, VENEZUELA:
2,546,328, CANC. INT. CL. 38.
- INTERNATIONAL ASSOCIATION FOR THE STUDY OF PAIN, INC., SEATTLE, WA:
2,211,105, REN. 12-19-08. INT. CL. 41.
2,211,106, REN. 12-19-08. INT. CL. 42.
- INTERNATIONAL ASSOCIATION OF COACHING, NASHVILLE, TN:
3,567,335, PUB. 11-11-2008. INT. CL. 35.
- INTERNATIONAL ASSOCIATION OF ORAL AND MAXILLOFACIAL SURGEONS, OAK BROOK, IL:
3,568,196, INT. CL. 44.
- INTERNATIONAL ASSOCIATION OF STRUCTURAL INTEGRATORS, MISSOULA, MT:
3,566,776, PUB. 11-11-2008. INT. CL. 35.
- INTERNATIONAL BROTHERHOOD OF ELECTRICAL WORKERS, WASHINGTON, DC:
3,566,326, PUB. 11-11-2008. U.S. CL. A.
- INTERNATIONAL BUSINESS MACHINES CORPORATION, ARMONK, NY:
2,547,785, CANC. MULTIPLE CLASS, INT. CLS. 37 AND 42.
2,547,999, CANC. INT. CL. 16.
2,548,103, CANC. MULTIPLE CLASS, INT. CLS. 9, 35, 38 AND 42.
- INTERNATIONAL COMMERCE EXCHANGE SYSTEMS, INC., NEW YORK, NY:
2,545,834, CANC. INT. CL. 42.
- INTERNATIONAL ENVIROGUARD SYSTEMS, INC., MESQUITE, TX:
3,567,405, PUB. 11-11-2008. INT. CL. 27.
3,568,742, INT. CL. 9.
- INTERNATIONAL EXPEDITIONS, INC., HELENA, AL:
3,567,188, PUB. 11-11-2008. INT. CL. 39.
3,567,191, PUB. 11-11-2008. INT. CL. 39.
- INTERNATIONAL ORDER OF THE GOLDEN RULE, BRIDGETON, MO:
2,547,549, CANC. INT. CL. 16.
- INTERNATIONAL PAPER COMPANY, MEMPHIS, TN:
1,107,248, REN. 12-23-08. INT. CL. 42.
1,107,248, CANC. INT. CL. 16.
- INTERNATIONAL RAW MATERIALS LTD., PHILADELPHIA, PA:
3,568,301, MULTIPLE CLASS, INT. CLS. 1 AND 35.
- INTERNATIONAL RETT SYNDROME ASSOCIATION, THE, #2-B, CLINTON, MD:
1,481,185, CANC. U.S. CL. 200.
- INTERNATIONAL SERVICE FOR THE ACQUISITION OF AGRI-BIOTECH APPLICATIONS, ITHACA, NY:
2,546,685, CANC. INT. CL. 42.
2,546,686, CANC. INT. CL. 42.
- INTERNATIONAL SPEEDWAY CORPORATION, DAYTONA BEACH, FL TO WATKINS GLEN INTERNATIONAL, INC., DAYTONA BEACH, FL:
2,628,580, CANC. MULTIPLE CLASS, INT. CLS. 16 AND 28.
- INTERNATIONAL SURFACE PREPARATION GROUP, INC., GOLDEN, CO:
3,568,570, MULTIPLE CLASS, INT. CLS. 37, 40 AND 41.
- INTERNATIONAL TOBACCO PARTNERS, LTD., GREAT NECK, NY:
3,122,507, CANC. INT. CL. 34.
- INTERNATIONAL TRADE ADMINISTRATION, WASHINGTON, DC:
2,547,993, CANC. INT. CL. 16.
- INTERSTATE ELECTRONICS CORPORATION, ANAHEIM, CA:
2,264,451, REN. 12-22-08. INT. CL. 9.
- INTICOM S.P.A., GALLARATE (VARESE), ITALY:
3,566,522, PUB. 11-11-2008. INT. CL. 35.
- INTOWN SUITES MANAGEMENT, INC., ATLANTA, GA:
2,272,875, REN. 12-22-08. INT. CL. 42.
- INTRA LIGHTING., PROIZVODNJA SVETIL IN; OPREMA OBJEKTOV D.O.O., SLOVENIA:
3,567,957, PUB. 11-11-2008. INT. CL. 11.
- INTRIGO, INCORPORATED, THOUSAND OAKS, CA:
2,548,485, CANC. INT. CL. 16.
- INUS TECHNOLOGY, INC., SEOUL, REPUBLIC OF KOREA:
3,566,422, PUB. 11-11-2008. INT. CL. 9.
- INVESTSMART, INC., PITTSBURGH, PA:
2,546,702, CANC. INT. CL. 36.
- INVESTMENT COMPANY TROIKA DIALOG, MOSCOW 103012, RUSSIAN FED.:
2,203,822, REN. 12-22-08. MULTIPLE CLASS, INT. CLS. 36 AND 42.
- INVESTOR BROADCAST NETWORK, INC., PHILADELPHIA, PA:
2,545,719, CANC. INT. CL. 36.

- INVISIO, INC., TAYLOR, MI:
2,545,735, CANC. INT. CL. 42.
- INVISTA NORTH AMERICA S.A.R.L., WILMINGTON, DE:
2,547,488, CANC. INT. CL. 39.
- IOLTECH, PERIGNY, FRANCE:
2,547,615, CANC. INT. CL. 10.
- ION MEDIA NETWORKS, INC., WEST PALM BEACH, FL:
3,568,528, MULTIPLE CLASS, INT. CLS. 38 AND 41.
- IPAXS CORPORATION, TAMPA, FL:
2,546,170, CANC. INT. CL. 9.
- IPC SYSTEMS, INC., JERSEY CITY, NJ:
3,568,502, INT. CL. 9.
- IPEX INC., DON MILLS, ONTARIO M3B 2S9, CANADA:
2,215,794, REN. 12-23-08. INT. CL. 20.
- IPIAIGHT PTY LTD, AUSTRALIA:
3,567,829, PUB. 11-11-2008. MULTIPLE CLASS, INT. CLS.
9, 16, 35 AND 41.
- IPME, LLLP, WESTMINSTER, CO:
3,566,377, PUB. 11-11-2008. INT. CL. 16.
- IPR PHARMACEUTICALS, INC., CAROLINA 00984-196,
PUERTO RICO:
3,567,615, PUB. 11-11-2008. INT. CL. 5.
- IPVERSE, INC., SAN JOSE, CA:
2,547,788, CANC. MULTIPLE CLASS, INT. CLS. 9 AND
38.
- IRE, INC., PORTLAND, OR:
1,484,054, REN. 12-19-08. INT. CL. 7.
- IRVING OIL CORPORATION, BANGOR, ME:
2,545,721, CANC. MULTIPLE CLASS, INT. CLS. 29, 30
AND 35.
- ISAAC CLASS, BRONX, NY:
2,546,169, CANC. INT. CL. 25.
- ISI BRANDS INC., GRAND RAPIDS, MI:
1,480,417, CANC. INT. CL. 5.
- ISLAND CITY, LLC, MERRILL, WI:
3,568,689, INT. CL. 12.
- ISLAND HEALTH FOODS LLC, YAKIMA, WA:
3,309,604, CANC. INT. CL. 35.
- ISLIP SPECIAL ASSEMBLY CORPORATION, AMITYVILLE,
NY:
2,547,217, CANC. MULTIPLE CLASS, INT. CLS. 37 AND
42.
- ISO CLAIMS SERVICES, INC., COLUMBIA, SC:
3,567,737, PUB. 11-11-2008. INT. CL. 9.
- ISO SERVICES, INC., JERSEY CITY, NJ:
3,568,278, INT. CL. 36.
- ITALIAN ANGELS MOTORCYCLES BROTHERHOOD,
INC., PALM HARBOR, FL:
3,568,274, INT. CL. 35.
- ITRON, INC., LIBERTY LAKE, WA:
1,488,241, REN. 12-24-08. INT. CL. 9.
- ITT MANUFACTURING ENTERPRISES, INC., WILMING-
TON, DE:
2,546,645, CANC. INT. CL. 37.
- ITV MARKETING GROUP, INC., BEVERLY, MA:
3,568,715, INT. CL. 35.
- ITW FOOD EQUIPMENT GROUP LLC, TROY, OH:
3,566,641, PUB. 11-11-2008. INT. CL. 11.
- IU COSMETICS S.A. DE C.V., LEON GTO, MEXICO:
3,566,419, PUB. 11-11-2008. MULTIPLE CLASS, INT. CLS.
3 AND 16.
- IVANO BIAGI SRL, 202-51100, PISTOIA, ITALY:
2,547,066, CANC. INT. CL. 25.
2,547,067, CANC. INT. CL. 25.
- IVELICH, SANDY, RENO, NV:
2,547,924, CANC. INT. CL. 24.
- IVM GMBH & CO. KG, 81543 MUNCHEN, FED REP
GERMANY:
2,547,915, CANC. MULTIPLE CLASS, INT. CLS. 37, 40
AND 42.
- IVY ANIMAL HEALTH, INC., OVERLAND PARK, KS,
VETLIFE, L.L.C., OVERLAND PARK, KS:
2,204,294, REN. 12-20-08. INT. CL. 5.
- IVY, JERRY, SEATTLE, WA, DBA IID, INC.:
2,545,944, CANC. INT. CL. 35.
- IZEX TECHNOLOGIES, INC., GOLDEN VALLEY, MN:
2,545,540, CANC. INT. CL. 10.
- J. & P. COATS, LIMITED, UNITED KINGDOM:
3,567,973, PUB. 11-11-2008. INT. CL. 23.
- J. B. WORLD TRADE, LOGAN, UT:
1,480,933, CANC. INT. CL. 29.
- J. R. CARLSON LABORATORIES, INC., ARLINGTON
HEIGHTS, IL:
2,281,045, REN. 12-22-08. INT. CL. 3.
- J.J. BUCKLEY, LLC, OAKLAND, CA:
3,566,763, PUB. 11-11-2008. INT. CL. 33.
- J.J. MACKAY CANADA LTD., NEW GLASGOW, NOVA
SCOTIA B2H 5E3, CANADA:
2,206,586, REN. 12-19-08. INT. CL. 9.
- J.M. WESTON, 87000 LIMOGES, FRANCE:
2,180,890, REN. 12-20-08. INT. CL. 25.
- J.O.E.L. FOOD COMPANY, INC., DAVIS, CA:
2,545,829, CANC. INT. CL. 32.
- J.P. MORGAN CHASE & CO., NEW YORK, NY:
2,546,915, CANC. INT. CL. 36.
- J.R. CARLSON LABORATORIES, INC., ARLINGTON
HEIGHTS, IL:
2,290,262, REN. 12-23-08. INT. CL. 5.
- JACK REISS LLC, NEW YORK, NY:
3,568,568, INT. CL. 14.
- JACKSON, DWIGHT CURTIS, LOS ANGELES, CA:
2,546,315, CANC. INT. CL. 35.
- JACKSON, STEVEN, SCOTTSDALE, AZ:
3,567,373, PUB. 11-11-2008. INT. CL. 12.
- JACOB LEINENKUGEL BREWING CO., INC., CHIPPEWA
FALLS, WI:
2,546,905, CANC. INT. CL. 32.
- JACOB'S LIVING WATER, INC., THE HILLS, TX, DBA
JACOB'S SPRING, INC.:
3,567,560, PUB. 11-11-2008. INT. CL. 3.
- JADE-A-KINS, LTD., LAS VEGAS, NV:
3,568,067, INT. CL. 25.
- JAIFER LIMITED, HAMILTON HM12, BERMUDA:
3,567,762, PUB. 11-11-2008. INT. CL. 3.
- JAFFERSON, INC., IRVING, TX:
3,568,711, INT. CL. 25.
- JAGUAR CARS LIMITED, COVENTRY, UNITED KING-
DOM:
2,548,171, CANC. INT. CL. 28.
- JAKKS PACIFIC, INC., MALIBU, CA:
2,547,344, CANC. INT. CL. 16.
3,568,328, INT. CL. 16.
3,568,427, INT. CL. 16.
- JAMARK LABORATORIES, INC., GRAND RAPIDS, MI:
2,238,139, REN. 12-22-08. INT. CL. 3.
- JAMES R. LOWRY, JR., ALEXANDRIA, VA:
3,568,413, INT. CL. 9.
- JANG, MAN JOON, SEOUL, REPUBLIC OF KOREA:
3,566,690, PUB. 11-11-2008. INT. CL. 9.
- JANTZEN APPAREL, LLC, MIAMI, FL:
3,566,696, PUB. 11-11-2008. INT. CL. 25.
- JAPAN POST, TOKYO, JAPAN:
3,365,751, COR. MULTIPLE CLASS, INT. CLS. 36 AND
39.
- JASBON, HUGO, DERRY, NH:
3,568,398, INT. CL. 35.
- JASMAN ASIA LTD., KOWLOON, HONG KONG:
2,269,721, REN. 12-19-08. INT. CL. 28.
- JASON INTERNATIONAL, INC., NORTH LITTLE ROCK,
AR:
1,544,308, REN. 12-19-08. INT. CL. 11.
- JASPER FUNDS, LLC, STAMFORD, CT:
3,566,313, PUB. 11-11-2008. INT. CL. 36.
- JAX, LTD., INC., PLYMOUTH, MN:
3,567,310, PUB. 11-11-2008. INT. CL. 28.
- JAZZWISE PUBLICATIONS LIMITED, LONDON, GREAT
BRITAIN:
3,566,570, PUB. 11-11-2008. INT. CL. 16.
- JD SUPRA, LLC, MARSHALL, CA:
3,568,214, INT. CL. 42.
- JEAN DODDS, INDIANAPOLIS, IN:
3,566,756, PUB. 11-11-2008. INT. CL. 16.
- JEANS AND A TEE, LLC, SPRINGFIELD GARDENS, NY:
3,566,991, PUB. 11-11-2008. INT. CL. 25.

- JENKINS, JIM, SAN DIEGO, CA:
3,567,499, PUB. 11-11-2008. INT. CL. 20.
- JENNER & BLOCK LLP, CHICAGO, IL:
2,547,065, CANC. INT. CL. 42.
- JENNIE-O TURKEY STORE, LLC, WILLMAR, MN:
3,568,680, INT. CL. 29.
- JENNIFER LOOMIS, SEATTLE, WA:
3,566,565, PUB. 11-11-2008. INT. CL. 41.
- JENSEN TRANSFORMERS, INCORPORATED, VAN NUYS, CA:
1,480,598, CANC. INT. CL. 9.
- JEOPARDY PRODUCTIONS, INC., CULVER CITY, CA:
2,545,994, CANC. INT. CL. 41.
- JEREMY BLAIR CLEMONS, RALEIGH, NC:
3,568,313, INT. CL. 9.
- JERRY THOMPSON & ASSOCIATES, INC., KENSINGTON, MD:
2,545,611, CANC. INT. CL. 42.
- JESSICA MCCLINTOCK, INC., SAN FRANCISCO, CA:
3,566,811, PUB. 11-11-2008. MULTIPLE CLASS, INT. CLS. 20 AND 21.
- JET CITY ROLLERGIRLS, EVERETT, WA:
3,566,627, PUB. 11-11-2008. INT. CL. 41.
- JIANGSU JIANHU PYROTECHNICS INDUSTRY LTD., JIANGSU, CHINA:
2,545,898, CANC. INT. CL. 13.
- JILLMERICA, LLC, PHOENIX, AZ:
2,548,125, CANC. MULTIPLE CLASS, INT. CLS. 9, 16, 25, 28 AND 41.
- JIM COLEMAN COMPANY, HOUSTON, TX:
2,547,598, CANC. INT. CL. 7.
- JJI LIGHTING GROUP, INC., GREENWICH, CT:
2,547,901, CANC. INT. CL. 11.
- JOANNA'S SOLUTION, INC. READING, PA:
2,546,400, CANC. INT. CL. 5.
- JOANNE'S BED & BACK STORES, INC., BELTSVILLE, MD:
2,547,237, CANC. INT. CL. 20.
- JOBBOUND, CHICAGO, IL:
3,567,240, PUB. 11-11-2008. INT. CL. 35.
3,567,241, PUB. 11-11-2008. INT. CL. 35.
- JODY HOUGHTON DESIGNS, INC., SALEM, OR:
3,567,520, PUB. 11-11-2008. INT. CL. 16.
- JOE BENBASSET, INC., NEW YORK, NY:
3,568,206, INT. CL. 25.
- JOE WATSON, INC., NOKOMIS, FL:
3,568,385, INT. CL. 3.
- JOH. WILH. VON EICKEN GMBH, LUBECK, FED REP GERMANY:
2,215,104, REN. 12-22-08. INT. CL. 34.
- JOHANSSON, ROLF, OREBRO, SWEDEN:
1,480,455, CANC. INT. CL. 7.
- JOHN B. SANFILIPPO & SON, INC., ELGIN, IL:
2,145,318, CANC. INT. CL. 30.
- JOHN F. SCHATZ RESEARCH & CONSULTING, INC., DEL MAR, CA:
2,545,704, CANC. INT. CL. 9.
- JOHN L. PUTNAM, NORTH POMFRET, VT:
3,567,326, PUB. 11-11-2008. INT. CL. 29.
- JOHN L. ROTONTI, JR., NEW ORLEANS, LA:
3,566,942, PUB. 11-11-2008. INT. CL. 41.
- JOHN PARRY & ALEXANDER, INC., LAFAYETTE, CA:
2,545,612, CANC. INT. CL. 35.
- JOHN, ORISHA, BROOKLYN, NY:
2,546,851, CANC. INT. CL. 41.
- JOHNSON & JOHNSON, NEW BRUNSWICK, NJ:
2,548,279, CANC. INT. CL. 10.
2,548,302, CANC. INT. CL. 16.
3,566,297, PUB. 11-11-2008. INT. CL. 3.
3,566,364, PUB. 11-11-2008. MULTIPLE CLASS, INT. CLS. 16 AND 44.
3,567,633, PUB. 11-11-2008. INT. CL. 3.
3,567,634, PUB. 11-11-2008. INT. CL. 5.
3,567,726, PUB. 12-16-2003. INT. CL. 3.
- JOHNSON CONTROLS, INC., MILWAUKEE, WI:
2,547,690, CANC. MULTIPLE CLASS, INT. CLS. 37, 40 AND 42.
- JOHNSON TRANSMISSION, INC., LAFAYETTE, IN, DBA GUARANTEED TRANSMISSION SERVICES:
3,566,443, PUB. 11-11-2008. INT. CL. 37.
- JOHNSON, ISRAEL C., SHREVEPORT, LA, DBA I JOHNSON ENTERPRISES:
2,547,931, CANC. INT. CL. 7.
- JOHNSON, MELISSA, INDIO, CA:
3,567,670, PUB. 11-11-2008. INT. CL. 28.
3,567,671, PUB. 11-11-2008. INT. CL. 28.
- JOHNSON DIVERSEY, INC., STURTEVANT, WI, MISCO INTERNATIONAL CHEMICALS, INC., WICHITA, KS:
1,107,688, REN. 12-19-08. INT. CL. 3.
1,107,697, REN. 12-19-08. INT. CL. 3.
- JOLNA DESIGN GROUP, INC., SUN VALLEY, CA:
2,547,077, CANC. INT. CL. 25.
- JOMARA SEAFOOD, INC, HIALEAH, FL:
3,568,204, INT. CL. 29.
- JONASSON, ELEANOR, TENAFLY, NJ:
2,547,806, CANC. INT. CL. 16.
- JONATHAN F. PRATT AND JULIANNE M. NEWTON PARTNERSHIP, THE, FEDERAL HEIGHTS, CO:
2,547,300, CANC. INT. CL. 16.
- JONES INVESTMENT CO., INC., WILMINGTON, DE:
2,547,457, CANC. INT. CL. 25.
- JONES, MAMIE A., WASHINGTON, DC:
2,546,810, CANC. INT. CL. 35.
- JOORABCHI, REZA, WELLESLEY, MA:
3,568,016, INT. CL. 30.
- JOSEPH DE ART APPAREL, INC., NEW YORK, NY:
2,546,971, CANC. INT. CL. 25.
- JOSEPH P. CHRISTIAN, ALBUQUERQUE, NM:
3,567,444, PUB. 11-11-2008. INT. CL. 35.
- JOSEPH, KENNETH D., NORTHBROOK, IL AND JOSEPH, DONALD, NORTHBROOK, IL:
1,105,291, REN. 12-24-08. INT. CL. 36.
1,105,291, CANC. MULTIPLE CLASS, INT. CLS. 37 AND 42.
1,105,776, REN. 12-24-08. INT. CL. 36.
1,105,776, CANC. MULTIPLE CLASS, INT. CLS. 37 AND 42.
- JOSHUA KESSELMAN, LAS VEGAS, NV:
3,566,552, PUB. 11-11-2008. INT. CL. 9.
- JOSYVAL (S.A.R.L.), 75008, PARIS, FRANCE:
2,546,564, CANC. MULTIPLE CLASS, INT. CLS. 3 AND 5.
- JPG PRODUCTS, LLC, ARLINGTON HEIGHTS, IL:
3,568,005, INT. CL. 25.
- JPMORGAN CHASE & CO., NEW YORK, NY:
2,548,410, CANC. INT. CL. 36.
2,548,434, CANC. INT. CL. 36.
- JRC REFLEX, FRANCE:
3,567,906, PUB. 11-11-2008. MULTIPLE CLASS, INT. CLS. 9, 10, 17, 24 AND 26.
- JRL INDUSTRIES, ANAHEIM, CA:
2,546,946, CANC. INT. CL. 25.
- JS LOGISTICS, INC., ST. LOUIS, MO:
3,566,735, PUB. 11-11-2008. INT. CL. 39.
- JT SPORTS LLC, BENTONVILLE, AR:
2,547,710, CANC. INT. CL. 41.
2,548,379, CANC. INT. CL. 28.
- JUICE TYME, INC., CHICAGO, IL:
3,566,540, PUB. 11-11-2008. INT. CL. 20.
- JULIE ANN TURNER & COMPANY, PLANO, TX:
2,548,503, CANC. INT. CL. 41.
- JULIUS ZORN GMBH, AICHACH, FED REP GERMANY:
2,546,512, CANC. MULTIPLE CLASS, INT. CLS. 10 AND 25.
- JUNGPFLANZEN GRÜNEWALD GMBH, FED REP GERMANY:
3,567,983, PUB. 11-11-2008. INT. CL. 31.
- JUST FOOD, INC., NEW YORK, NY:
2,545,945, CANC. MULTIPLE CLASS, INT. CLS. 35 AND 41.
- JUST WHEELS & TIRE CO., HUNTINGTON BEACH, CA:
3,568,325, INT. CL. 9.
- JUSTSYSTEMS CANADA INC., VANCOUVER, BRITISH COLUMBIA, CANADA:
2,545,948, CANC. INT. CL. 9.

- K & M INTERNATIONAL, TWINSBURG, OH:
2,547,069, CANC. INT. CL. 28.
2,547,070, CANC. INT. CL. 28.
2,547,071, CANC. INT. CL. 28.
- K & T; HANDELS- UND UNTERNEHMENSBERATUNG GMBH, FED REP GERMANY:
3,567,918, PUB. 11-11-2008. MULTIPLE CLASS, INT. CLS. 14, 18 AND 25.
- K.N.R.K. INC., MCKINNEY, TX, DBA R K CLEANERS:
2,546,142, CANC. INT. CL. 37.
- K&W BUTTER SLICK AUTO GROUP, INC., GARY, IN:
2,547,078, CANC. INT. CL. 3.
- K-2 INDUSTRIES, INC., BERGEN, NY, DBA PAVILION GIFT COMPANY:
2,546,840, CANC. INT. CL. 20.
- KABLE NEWS COMPANY, INC., MT. MORRIS, IL:
2,548,143, CANC. INT. CL. 35.
- KABUSHIKI KAISHA BANDAI NAMCO HOLDINGS, TOKYO, JAPAN, TA NAMCO BANDAI HOLDINGS, INC.:
3,566,267, PUB. 10-2-2007. MULTIPLE CLASS, INT. CLS. 9, 10, 11, 12, 16, 20, 21, 25, 28, 35, 41 AND 42.
3,566,268, PUB. 10-2-2007. MULTIPLE CLASS, INT. CLS. 9, 10, 11, 12, 16, 20, 21, 25, 28, 35, 41 AND 42.
- KABUSHIKI KAISHA HITACHI SEISAKUSHO, TOKYO, JAPAN:
1,480,678, CANC. INT. CL. 9.
1,480,679, CANC. INT. CL. 9.
- KABUSHIKI KAISHA HITACHI SEISAKUSHO, TOKYO, JAPAN, DBA HITACHI, LTD.:
2,547,704, CANC. INT. CL. 9.
- KABUSHIKI KAISHA KOMATSU SEISAKUSHO, MINATOKU, TOKYO, JAPAN, DBA KOMATSU LTD.:
1,103,652, REN. 12-23-08. INT. CL. 42.
- KABUSHIKI KAISHA MITSUKAN GROUP HONSHA, AICHI-KEN, JAPAN:
3,568,369, INT. CL. 29.
- KABUSHIKI KAISHA MIYAKE DESIGN JIMUSHO, SHIBUYA-KU, TOKYO, JAPAN, DBA MIYAKE DESIGN STUDIO:
3,568,323, INT. CL. 25.
- KABUSHIKI KAISHA PROTEC FUJI, OSAKA-FU 530, JAPAN, TA PROTEC FUJI CO., LTD.:
2,547,512, CANC. INT. CL. 28.
- KABUSHIKI KAISHA RAIZING, TOKYO 144-0051, JAPAN:
2,548,028, CANC. INT. CL. 9.
- KABUSHIKI KAISHA YAKULT HONSHA, MINATO-KU, TOKYO, JAPAN:
3,566,815, PUB. 9-9-2008. INT. CL. 3.
- KABUSHIKI KAISHA ZUKEN, KANAQAWA-KEN, JAPAN:
1,531,762, REN. 12-20-08. INT. CL. 9.
- KADENA INDUSTRIES, LTD., HANGZHOU, CHINA:
3,567,052, PUB. 11-11-2008. INT. CL. 25.
- KAHN REALTY, INC., GLENCOE, IL:
1,481,035, CANC. INT. CL. 36.
- KAHN, PETER K., BROOKHAVEN HAMLET, NY:
2,547,020, CANC. INT. CL. 8.
- KALI SYSTEMS LLC, KAILUA, HI:
3,567,436, PUB. 11-11-2008. INT. CL. 42.
- KAMICO INSTRUCTIONAL MEDIA, INC., SALADO, TX:
2,547,161, CANC. INT. CL. 16.
- KAMINS, HELEN, MANCHESTER-BY-THE-SEA, MA:
2,209,767, REN. 12-22-08. INT. CL. 14.
- KAMMERER FOUNDATION, SANTA FE, NM:
2,546,329, CANC. MULTIPLE CLASS, INT. CLS. 25 AND 41.
- KAMPFFMEYER MÜHLEN GMBH, FED REP GERMANY:
3,567,869, PUB. 11-11-2008. MULTIPLE CLASS, INT. CLS. 29, 30 AND 31.
- KANSAS STEAM, LLC, ANDOVER, KS:
2,548,002, CANC. INT. CL. 9.
- KANT, NEALE ARVIND, PENNANT HILLS NSW 2120, AUSTRALIA AND THARMALINGAM, SURESH KUMAR, PENNANT HILLS NSW 2120, AUSTRALIA:
2,546,025, CANC. MULTIPLE CLASS, INT. CLS. 9, 28 AND 41.
- KAPLAN, LINDA A., ORMOND BEACH, FL:
3,566,772, PUB. 11-11-2008. INT. CL. 25.
- KAREN KANE COMPANY, INC., LOS ANGELES, CA:
1,480,864, CANC. INT. CL. 25.
- KARL WEISS TECHNOLOGIEUNTERNEHMEN GMBH & CO. KG, BERLIN, FED REP GERMANY:
2,195,640, REN. 12-20-08. INT. CL. 17.
- KARMIC MANAGEMENT, LLC, NEW YORK, NY:
3,567,253, PUB. 11-11-2008. INT. CL. 41.
- KARO INTERNET GMBH, FED REP GERMANY:
3,567,916, PUB. 11-11-2008. MULTIPLE CLASS, INT. CLS. 9, 35, 38, 41, 42 AND 45.
- KAROUN DAIRIES, INC., SUN VALLEY, CA:
2,256,723, REN. 12-20-08. INT. CL. 29.
- KASHI COMPANY, LA JOLLA, CA:
3,567,313, PUB. 11-11-2008. INT. CL. 30.
- KASPER, LESLIE, ALPHARETTA, GA:
3,567,549, PUB. 11-11-2008. INT. CL. 16.
- KATE BECKER, TUCSON, AZ, DBA KATE'S MAGIK:
3,567,053, PUB. 11-11-2008. INT. CL. 3.
- KATZ MILLENNIUM SALES & MARKETING INC., SAN ANTONIO, TX:
1,480,765, CANC. MULTIPLE CLASS, INT. CLS. 16, 35 AND 41.
- KAY, SHARONA, BOCA RATON, FL:
3,567,632, PUB. 11-11-2008. INT. CL. 36.
- KCI LICENSING, INC., SAN ANTONIO, TX:
2,224,795, REN. 12-20-08. INT. CL. 10.
- KEARNS-TRIBUNE, LLC, DENVER, CO:
3,566,260, PUB. 11-11-2008. MULTIPLE CLASS, INT. CLS. 35 AND 41.
- KEATING INVESTMENTS, LLC, GREENWOOD VILLAGE, CO:
3,567,669, PUB. 11-11-2008. INT. CL. 36.
- KEATING TECHNOLOGIES INC., MARKHAM, ONTARIO, CANADA:
3,566,715, PUB. 11-11-2008. MULTIPLE CLASS, INT. CLS. 35, 37 AND 42.
- KEDMAN COMPANY, SALT LAKE CITY, UT:
1,480,527, CANC. INT. CL. 9.
- KEEP CHICAGO BEAUTIFUL, CHICAGO, IL, DBA CHICAGO CLEAN STREAK:
2,210,263, REN. 12-19-08. INT. CL. 41.
2,215,800, REN. 12-19-08. INT. CL. 41.
- KEEP IT COVERED INC., INCLINE VILLAGE, NV:
3,566,389, PUB. 11-11-2008. INT. CL. 40.
- KEITH L. GOOD, P.C., SHILLINGTON, PA, DBA GOOD PHYSICAL THERAPY:
3,567,118, PUB. 11-11-2008. INT. CL. 44.
3,567,136, PUB. 11-11-2008. INT. CL. 44.
- KELLEHER & ASSOCIATES, LLC, SAUSALITO, CA:
3,567,211, PUB. 11-11-2008. INT. CL. 45.
- KELLY-MOORE PAINT COMPANY, INC., SAN CARLOS, CA:
3,567,169, PUB. 11-11-2008. INT. CL. 2.
- KENA KAI, INC., ANAHEIM HILLS, CA:
3,567,364, PUB. 11-11-2008. INT. CL. 18.
- KENG'S FIREARMS SPECIALTY, INC., ATLANTA, GA:
3,568,137, INT. CL. 13.
- KENNEDY, ANTHONY JOSEPH, NEW SOUTH WALES, 2441, AUSTRALIA:
3,567,621, PUB. 11-11-2008. INT. CL. 21.
- KENNETH L. MERRILL, SHERMAN OAKS, CA:
3,568,745, INT. CL. 25.
3,568,746, INT. CL. 25.
3,568,747, INT. CL. 25.
- KENT FEEDS, INC., MUSCATINE, IA:
2,547,371, CANC. INT. CL. 5.
- KENZO S.A, FRANCE:
3,567,871, PUB. 11-11-2008. INT. CL. 3.
- KERN MEAT COMPANY, INC., ST. LOUIS, MO:
3,566,832, PUB. 11-11-2008. INT. CL. 29.
- KERTZ, MALCOLM GLEN, EL PASO, TX:
3,567,784, PUB. 11-11-2008. MULTIPLE CLASS, INT. CLS. 3 AND 21.
3,567,786, PUB. 11-11-2008. INT. CL. 3.
3,567,787, PUB. 11-11-2008. INT. CL. 3.
3,567,788, PUB. 11-11-2008. INT. CL. 3.

KEVIN MCCARNEY, NORTH HOLLYWOOD, CA, DBA POQUITO MAS:
3,567,153, PUB. 11-11-2008. INT. CL. 43.

KEY ENERGY SERVICES, INC., HOUSTON, TX:
3,568,581, INT. CL. 1.

KEYSTONE SCENT COMPANY, INC., BALTIMORE, MD:
3,568,188, INT. CL. 5.

KEYSTONE-TEXAS PROPERTY HOLDING CORP., DALLAS, TX:
1,481,052, CANC. INT. CL. 36.

KEYSTONE-TEXAS PROPERTY HOLDINGS CORP., DALLAS, TX:
1,481,053, CANC. INT. CL. 36.

KIANOSH, MIRKIA, REDWOOD CITY, CA:
3,567,489, PUB. 11-11-2008. INT. CL. 25.

KIDDIE KORRAL COMPANY, DALLAS, TX:
2,217,315, REN. 12-19-08. INT. CL. 25.
2,217,316, REN. 12-19-08. INT. CL. 25.

KIDSBOOKS LLC, CHICAGO, IL:
2,190,163, REN. 12-19-08. INT. CL. 16.

KIER BAKER HOLDINGS LIMITED, UNITED KINGDOM:
3,567,876, PUB. 11-11-2008. INT. CL. 31.

KIERNAN, JAMES E., ROCKAWAY PARK, NY:
3,568,712, INT. CL. 44.

KIKS JAPAN CO., LTD, TOKYO 153-0062, JAPAN:
3,567,865, PUB. 11-11-2008. INT. CL. 25.

KIM, CHI KYUNG, SEOUL, REPUBLIC OF KOREA:
2,545,521, CANC. INT. CL. 10.

KIM, FRANCESCO, WALNUT, CA:
3,567,575, PUB. 11-11-2008. INT. CL. 28.

KIM, GUN WOO, SANTA FE SPRINGS, CA:
3,566,488, PUB. 11-11-2008. INT. CL. 12.
3,566,489, PUB. 11-11-2008. INT. CL. 12.

KIM, JUNG PIL, CERRITOS, CA:
2,547,846, CANC. INT. CL. 35.

KIMBERLY-CLARK CORPORATION, NEENAH, WI:
2,546,850, CANC. INT. CL. 16.
2,548,468, CANC. INT. CL. 16.

KINDERWORKS CORPORATION, PORTSMOUTH, NH:
1,480,820, CANC. INT. CL. 20.

KINDRED HANDS, LLC, VAN METER, IA:
3,566,290, PUB. 11-11-2008. INT. CL. 28.

KINETEK CORPORATION, BOTHELL, WA:
2,144,045, CANC. INT. CL. 9.

KING LOMBARDI ACQUISITIONS, INC., FORT LAUDERDALE, FL:
3,567,318, PUB. 11-11-2008. INT. CL. 36.

KING SCHOOLS, INC., SAN DIEGO, CA:
2,546,697, CANC. INT. CL. 9.

KING, GARY, CAMBRIDGE, MA:
3,568,077, INT. CL. 9.

KINGSID VENTURES, LTD., LAS VEGAS, NV:
3,566,904, PUB. 11-11-2008. INT. CL. 43.

KINPLEX CORPORATION, EDGEWOOD, NY:
2,203,823, REN. 12-22-08. MULTIPLE CLASS, INT. CLS. 11 AND 20.

KIP PRAHL ASSOCIATES LLC, LAFAYETTE, CO:
3,566,519, PUB. 11-11-2008. INT. CL. 35.

KIPP, MASTIN, LOS ANGELES, CA:
3,568,703, INT. CL. 25.

KIRKEMINDE, JAMES E., GLENDALE, AZ:
2,546,501, CANC. INT. CL. 16.

KITCHEN KNEADS, INC., OGDEN, UT:
3,567,255, PUB. 11-11-2008. INT. CL. 35.

KLAUS D. ZENKNER, FED REP GERMANY:
3,567,813, PUB. 11-11-2008. INT. CL. 19.

KLD ASSOCIATES, INC., HAUPPAUGE, NY:
3,568,592, INT. CL. 9.

KLEIN CUTLERY, LLC, CHICAGO, IL:
2,210,837, REN. 12-22-08. INT. CL. 8.

KLEIN TOOLS, INC., LINCOLNSHIRE, IL:
3,568,330, INT. CL. 9.

KLUCZNIK, JOHN H., TELFORD, PA, DBA BONNET PRO:
3,566,325, PUB. 11-11-2008. INT. CL. 7.

KNAPE & VOGT MANUFACTURING COMPANY, GRAND RAPIDS, MI:
3,567,097, PUB. 11-11-2008. INT. CL. 20.

KNOGO CORPORATION, HICKSVILLE, NY:
1,480,565, CANC. INT. CL. 9.

KNOLOGY, INC., WEST POINT, GA:
3,566,697, PUB. 11-11-2008. INT. CL. 38.

KNOVATION, INC., CHILLICOTHE, OH:
2,258,655, REN. 12-22-08. INT. CL. 42.

KNOWLEDGE LEARNING CORPORATION, PORTLAND, OR:
3,568,316, MULTIPLE CLASS, INT. CLS. 35, 41 AND 43.

KNOWLEDGEBALL LLC, PASADENA, CA:
3,568,474, INT. CL. 28.

KOBRA INTERNATIONAL, LTD., NEW YORK, NY:
3,568,310, INT. CL. 25.

KODAK POLYCHROME GRAPHICS LLC, NORWALD, CT:
1,480,310, CANC. INT. CL. 1.

KOEI CO., LTD., YOKOHAMA, JAPAN:
3,567,639, PUB. 11-11-2008. INT. CL. 9.
3,568,373, INT. CL. 9.

KOFRICA ENTERTAINMENT INC., MALIBU, CA:
2,547,761, CANC. INT. CL. 41.

KOHL'S ILLINOIS, INC., AURORA, IL:
2,547,663, CANC. INT. CL. 25.
3,566,373, PUB. 11-11-2008. INT. CL. 20.

KOIS CENTER, LLC, SEATTLE, WA:
3,568,446, INT. CL. 10.

KOLINA TECHNOLOGIES, INC., BETHESDA, MD:
2,547,848, CANC. INT. CL. 35.

KOMA INVESTMENTS AND FINANCE B.V., 6045 JE ROERMOND, NETHERLANDS:
2,546,247, CANC. INT. CL. 11.
2,546,248, CANC. INT. CL. 11.

KOMODO ENTERPRISES, INC., IRVINE, CA:
3,566,569, PUB. 11-11-2008. MULTIPLE CLASS, INT. CLS. 7, 11, 37 AND 42.

KONAMI GAMING, INC., LAS VEGAS, NV:
3,568,367, INT. CL. 9.

KONG'S (AUST) PTY LIMITED, AUSTRALIA:
3,567,928, PUB. 11-11-2008. MULTIPLE CLASS, INT. CLS. 5, 9, 11, 16, 19, 20, 21 AND 31.

KONINKLIJKE DE KUYPER B.V., AB SCHIEDAM, NETHERLANDS, TA DE KUYPER ROYAL DISTILLERS:
1,122,521, REN. 12-22-08. INT. CL. 33.

KONINKLIJKE PHILIPS ELECTRONICS N.V., EINDHOVEN, NETHERLANDS:
1,513,367, REN. 12-22-08. INT. CL. 10.
1,513,367, CANC. INT. CL. 9.
2,545,492, CANC. INT. CL. 7.

KONINKLIJKE PHILIPS ELECTRONICS N.V., NETHERLANDS:
3,567,978, PUB. 11-11-2008. MULTIPLE CLASS, INT. CLS. 9 AND 10.

KOONICHI INCORPORATED, FRESH MEADOWS, NY:
3,567,766, PUB. 11-11-2008. INT. CL. 5.

KOP-COAT, INC., PITTSBURGH, PA:
3,567,563, PUB. 11-11-2008. INT. CL. 19.

KOREN, THOMAS, SAN FRANCISCO, CA:
2,548,311, CANC. INT. CL. 42.

KOS LIFE SCIENCES, INC., WESTON, FL:
2,548,562, CANC. INT. CL. 5.

KOTT KOATINGS, INC., FOOTHILL RANCH, CA:
3,566,873, PUB. 11-11-2008. MULTIPLE CLASS, INT. CLS. 35 AND 37.
3,566,874, PUB. 11-11-2008. MULTIPLE CLASS, INT. CLS. 35 AND 37.

KRADJIAN IMPORTING CO., INC., GLENDALE, CA:
3,566,346, PUB. 11-11-2008. INT. CL. 29.

KRAFT FOODS GLOBAL BRANDS LLC, NORTHFIELD, IL:
670,330, REN. 12-20-08. U.S. CL. 46 (INT. CLS. 29, 30, 31 AND 32).
2,211,910, REN. 12-20-08. INT. CL. 29.

KRAFT FOODS HOLDINGS, INC., NORTHFIELD, IL:
2,548,198, CANC. INT. CL. 35.

KRAFTELEKTRONIK AB, S-445 02 SURTE, SWEDEN:
1,480,511, CANC. INT. CL. 9.

KRAGIE, LAURA A, CHEVY CHASE, MD:
3,566,754, PUB. 11-11-2008. INT. CL. 44.

KRANICKE, MICHAEL J, CHICAGO, IL:
2,546,920, CANC. INT. CL. 41.

- KRANSCO, SAN FRANCISCO, CA:
1,706,955, CANC. INT. CL. 28.
- KRAUSE MANUFACTURING, INC., BELLINGHAM, WA:
3,567,150, PUB. 11-11-2008. INT. CL. 7.
- KRAUTNER, MARIA, WALNUT CREEK, CA, DBA KRAUTNER CREATIONS:
3,566,937, PUB. 11-11-2008. INT. CL. 25.
- KRESSLEY, PAMELA A., ORLANDO, FL:
3,567,375, PUB. 11-11-2008. INT. CL. 39.
- KRICKETS LICENSING INC., MONTREAL, QUEBEC, CANADA:
2,545,802, CANC. INT. CL. 25.
- KROGER CO. OF MICHIGAN, THE, LIVONIA, MI:
2,548,237, CANC. INT. CL. 30.
- KRUEGER, JEFFREY W., BOONE, NC, DBA PAPELEO INC:
3,566,598, PUB. 11-11-2008. INT. CL. 35.
- KRUPS GMBH, 42719 SOLINGEN, FED REP GERMANY:
2,548,579, CANC. INT. CL. 9.
- KRUSH, PEARL LOUISE, RAPID CITY, SD:
2,547,155, CANC. INT. CL. 26.
- KSC INDUSTRIES INCORPORATED, CHULA VISTA, CA:
3,567,430, PUB. 11-11-2008. INT. CL. 9.
3,567,432, PUB. 11-11-2008. INT. CL. 9.
- KSM CORPORATION, KALAMAZOO, MI:
2,547,721, CANC. INT. CL. 11.
- KURT MANUFACTURING COMPANY, INC., MINNEAPOLIS, MN:
1,563,049, REN. 12-20-08. INT. CL. 7.
- KURT SALMON ASSOCIATES, INC., ATLANTA, GA:
2,546,124, CANC. INT. CL. 35.
- KUSKEY, MARIANA SUMMERHILL, SANTA BARBARA, CA, DBA SUMMERHILL FINE FOODS:
2,546,054, CANC. INT. CL. 30.
- KUSTER LIMITED, DEDDINGTON, UNITED KINGDOM:
3,566,423, PUB. 11-11-2008. MULTIPLE CLASS, INT. CLS. 8, 10, 11 AND 20.
- KUSTOM PAK FOODS, LTD., SIOUX CITY, IA:
2,257,329, REN. 12-20-08. INT. CL. 29.
- KUTNER, RICHARD B., BROOMALL, PA:
2,546,588, CANC. INT. CL. 24.
- KVASNIK, ALAN SCOTT, MINNEAPOLIS, MN:
2,553,038, CANC. MULTIPLE CLASS, INT. CLS. 12 AND 25.
- KW INTELLECTUAL PROPERTIES, INC., POLK CITY, FL:
3,568,239, MULTIPLE CLASS, INT. CLS. 25 AND 41.
- KWGC, INC., DALLAS, TX:
2,546,559, CANC. MULTIPLE CLASS, INT. CLS. 35 AND 42.
2,546,560, CANC. MULTIPLE CLASS, INT. CLS. 35 AND 42.
- KWV INTELLECTUAL PROPERTIES (PTY) LIMITED, PAARL, SOUTH AFRICA:
2,545,525, CANC. INT. CL. 33.
- KYOCERA WIRELESS CORP., SAN DIEGO, CA:
3,567,360, PUB. 11-11-2008. INT. CL. 9.
- K2 HEALTH PRODUCTS, BROOKLYN, NY:
3,567,004, PUB. 11-11-2008. MULTIPLE CLASS, INT. CLS. 12 AND 20.
- K2 HEALTH PRODUCTS, LLC, BROOKLYN, NY:
3,567,008, PUB. 11-11-2008. MULTIPLE CLASS, INT. CLS. 10, 16 AND 25.
- K2 MOTOR CORP, WALNUT, CA:
3,568,476, INT. CL. 35.
- L'OREAL, PARIS, FRANCE:
2,545,712, CANC. INT. CL. 3.
- L & P PROPERTY MANAGEMENT COMPANY, IL:
1,480,821, CANC. INT. CL. 20.
- L & S PRODUCTIONS, INC., DALLAS, TX:
2,213,340, REN. 12-23-08. INT. CL. 16.
- L.B. CONFECIONES E COMERCIO DE ROUPAS LTDA, SANTA CECILIA, BRAZIL:
3,567,402, PUB. 11-11-2008. INT. CL. 25.
- L'OREAL, 75008 PARIS, FRANCE:
2,220,610, REN. 12-22-08. INT. CL. 3.
2,545,592, CANC. MULTIPLE CLASS, INT. CLS. 3 AND 5.
2,546,224, CANC. INT. CL. 3.
- L'OREAL USA CREATIVE, INC., NEW YORK, NY:
3,567,561, PUB. 11-11-2008. INT. CL. 3.
- LA CORNUE SA, 95310 SAINT-OUEN L' AUMONE, FRANCE:
2,396,947, CANC. MULTIPLE CLASS, INT. CLS. 8, 14, 20, 21 AND 38.
- LA FAMILLE DES GRANDS VINS ET SPIRITUEUX (FGVS), NUITS SAINT GEORGES, FRANCE:
3,566,775, PUB. 11-11-2008. INT. CL. 33.
- LA MADRILEÑA, S.A. DE C.V., COL. DEL VALLE, MEXICO:
3,567,165, PUB. 11-11-2008. INT. CL. 33.
3,567,166, PUB. 11-11-2008. INT. CL. 33.
- LA MODE ORIGINALS, INC., ABERDEEN, NJ:
3,568,026, INT. CL. 25.
- LA QUINTA WORLDWIDE, LLC, LAS VEGAS, NV:
3,567,063, PUB. 11-11-2008. INT. CL. 43.
- LABCOAT LIMITED, GALWAY, IRELAND:
3,566,434, PUB. 11-11-2008. MULTIPLE CLASS, INT. CLS. 1, 5, 10, 42 AND 44.
- LABEYRIE S.A., DE MAREMNE, FRANCE:
2,545,946, CANC. INT. CL. 29.
- LABORATOIRE D'EVOLUTION DERMATOLOGIQUE (L.E.D.), F-75008 PARIS, FRANCE:
2,545,560, CANC. INT. CL. 3.
- LABORATOIRES LEHNING, 57640 SAINTE BARBE, FRANCE:
2,161,245, REN. 12-19-08. INT. CL. 5.
- LACOSTE ALLIGATOR S.A., GENEVA 3, SWITZERLAND, LA CHEMISE LACOSTE, PARIS, FRANCE:
879,171, REN. 12-22-08. U.S. CL. 39 (INT. CL. 25).
- LACOSTE ALLIGATOR S.A., GENEVA 3, SWITZERLAND:
2,247,880, REN. 12-22-08. INT. CL. 14.
- LACY, AUBREY, LAPLACE, LA:
3,568,484, INT. CL. 30.
- LADCO, LTD., HOUSTON, TX:
3,567,538, PUB. 11-11-2008. INT. CL. 42.
- LAKE COUNTY, FLORIDA, GROVELAND, FL:
2,547,988, CANC. INT. CL. 35.
- LAKOTA LAKE CAMP, LLC, RAPID CITY, SD:
3,567,325, PUB. 11-11-2008. INT. CL. 37.
- LALLEMAND INC., MONTREAL, CANADA:
3,568,479, INT. CL. 1.
- LAMBS & IVY, INC., EL SEGUNDO, CA:
3,568,394, MULTIPLE CLASS, INT. CLS. 24, 25 AND 28.
- LAMDA DATA SYSTEMS, INC., NEW YORK, NY:
2,283,586, REN. 12-22-08. INT. CL. 9.
- LAMPERTZ GMBH & CO. KG, D-57584 WALLMENROTH, FED REP GERMANY:
2,743,448, CANC. INT. CL. 16.
- LAMPLIGHT FARMS, INC., MENOMONEE FALLS, WI:
2,161,487, REN. 12-19-08. MULTIPLE CLASS, INT. CLS. 4 AND 11.
- LANCASTER GROUP AG, D-67059 LUDWIGSHAFEN, FED REP GERMANY:
2,545,497, CANC. INT. CL. 3.
- LANCE MFG. LLC, CHARLOTTE, NC:
2,548,080, CANC. INT. CL. 35.
- LANCOME PARFUMS ET BEAUTE & CIE, 75008 PARIS, FRANCE:
2,546,743, CANC. INT. CL. 3.
- LANCOME PARFUMS ET BEAUTE & CIE., 75008 PARIS, FRANCE:
2,545,526, CANC. INT. CL. 3.
- LAND O'LAKES PURINA FEED LLC, SHOREVIEW, MN:
2,240,992, REN. 12-22-08. MULTIPLE CLASS, INT. CLS. 5 AND 31.
- LAND ROVER, WARWICKSHIRE, UNITED KINGDOM:
3,566,367, PUB. 11-11-2008. MULTIPLE CLASS, INT. CLS. 12, 27 AND 28.
- LANDAUER, INC., GLENWOOD, IL:
3,568,739, INT. CL. 42.
- LANDCAR AGENCY, INC., SANDY, UT:
3,568,209, INT. CL. 37.
- LANGSETH, KENT BRUCE, RYDAL, GA, DBA JEVERSI SOFTWARE:
3,566,858, PUB. 11-11-2008. INT. CL. 9.
- LANSING, KAREN, APTOS, CA:
3,567,601, PUB. 11-11-2008. INT. CL. 41.

LANUM ELECTRIC LLC, BETTENDORF, IA, DBA RUSSELL ELECTRIC:
3,566,716, PUB. 11-11-2008. INT. CL. 37.

LARGESMALL SYSTEMS, INC., AUSTIN, TX:
3,567,331, PUB. 11-11-2008. INT. CL. 42.

LASER GARDEN, INC., WILMETTE, IL:
2,547,364, CANC. INT. CL. 3.

LASER IMPRESSIONS, INC., SUNNYVALE, CA:
2,201,261, REN. 12-19-08. INT. CL. 6.

LASER TECHNOLOGY, INC., CENTENNIAL, CO AND KAMA-TECH, HK LTD., TSIM SHA TSUI, HONG KONG:
3,568,186, INT. CL. 9.

LAST MINUTE TOUR S.P.A., MILAN, ITALY:
2,546,395, CANC. MULTIPLE CLASS, INT. CLS. 16, 39 AND 42.

LAST RESORT, INC, CAMBRIDGE, MA:
2,547,771, CANC. INT. CL. 42.

LATASHA ANTOINETTE OBRIEN, HOUSTON, TX, DBA KIMMI KENNEDY:
3,568,788, INT. CL. 9.

LAU, LINCOLN T., WINNIPEG, CANADA, DBA INTERNATIONAL MANUPRACTIC INSTITUTE:
3,566,788, PUB. 11-11-2008. INT. CL. 44.

LAUFER BATINOVICH, SARA, FEDERAL WAY, WA:
3,275,119, AM. INT. CL. 35.

LAUNCHPOWER, INC., PALO ALTO, CA:
2,546,589, CANC. INT. CL. 35.

LAVALLEY, WILLIAM, AUSTIN, TX:
3,568,620, INT. CL. 28.

LAVISH LASHES, LLC, RIVERSIDE, CA:
3,568,614, MULTIPLE CLASS, INT. CLS. 3, 35 AND 41.

LAXTON, TERRY, BELLEVUE, WA:
3,568,496, INT. CL. 41.

LE CHAUVINIST, INC., LA JOLLA, CA:
3,568,612, INT. CL. 25.

LEADERSHIP STRATEGIES INTERNATIONAL, SANTA CLARITA, CA:
3,567,184, PUB. 11-11-2008. INT. CL. 35.

LEAN ACCOUNTING NEWSLETTER LLC, CLEVELAND, OH:
3,568,759, INT. CL. 41.

LEARNING CURVE INTERNATIONAL, INC., CHICAGO, IL:
2,547,750, CANC. INT. CL. 28.

LEARNING PROJECT, INC., THE, NEW YORK, NY:
2,545,858, CANC. INT. CL. 41.
2,546,045, CANC. INT. CL. 41.

LEAVER, RYAN J., MADISON, WI:
2,547,444, CANC. INT. CL. 36.

LECTIONARY HOMILETICS, INC., MIDLOTHIAN, VA:
3,568,749, INT. CL. 41.

LEDESMA S.A.A.I., BUENOS AIRES, ARGENTINA:
3,115,461, CANC. INT. CL. 16.

LEE & RO CONSULTING ENGINEERS, INC., CITY OF INDUSTRY, CA:
2,145,054, CANC. INT. CL. 42.

LEE, ANNE, LOS ANGELES, CA, DBA AMBER & LINLEY:
3,567,551, PUB. 11-11-2008. INT. CL. 3.

LEE, SHUYEN, SAINT-LAURENT-QUEBEC, CANADA:
3,566,445, PUB. 6-3-2008. MULTIPLE CLASS, INT. CLS. 16, 25, 28 AND 35.

LEELINCO PLASTICS, INC., PASADENA, TX:
2,548,343, CANC. INT. CL. 40.

LEGAL AID SOCIETY OF ORANGE COUNTY, SANTA ANA, CA:
3,568,588, MULTIPLE CLASS, INT. CLS. 35 AND 42.

LEGALREMEDY.NET, INC., SAN BERNARDINO, CA:
3,566,912, PUB. 11-11-2008. INT. CL. 45.

LEGATO SYSTEMS, INC., MOUNTAIN VIEW, CA:
2,547,412, CANC. INT. CL. 42.

LEHMAN SUGARFREE CONFECTIONS, INC., BROOKLYN, NY:
2,546,569, CANC. INT. CL. 30.

LEHMKUHL, WILLIAM J., MINSTER, OH, DBA PRECISION AGR SERVICES:
2,548,231, CANC. INT. CL. 7.

LEIGHTRONIX, INC., HOLT, MI:
3,567,455, PUB. 11-11-2008. INT. CL. 35.

LEISURE BAY INDUSTRIES, INC., ORLANDO, FL:
2,546,362, CANC. INT. CL. 28.

LEISURE SALES, INCORPORATED, DALLAS, TX:
3,568,461, INT. CL. 21.

LENNAR PACIFIC PROPERTIES MANAGEMENT, INC., ALISO VIEJO, CA:
3,566,299, PUB. 11-11-2008. INT. CL. 37.
3,566,300, PUB. 11-11-2008. INT. CL. 37.

LEONARD, THOMAS, RUSKIN, FL:
2,548,462, CANC. INT. CL. 41.

LEONHARD KURZ GMBH & CO., D-90763 FURTH, FED REP GERMANY:
2,547,724, CANC. INT. CL. 2.

LESLIE LAMBERT TURNQUEST, NASSAU, BAHAMAS:
3,568,439, INT. CL. 26.

LETNES RESTAURANT GROUP, INC., WAITE PARK, MN:
2,237,905, REN. 12-19-08. INT. CL. 42.

LETS STAY IN TOUCH, INC, PEACHTREE CITY, GA:
2,546,698, CANC. INT. CL. 42.

LEUPOLD & STEVENS, INC., BEAVERTON, OR:
870,081, REN. 12-20-08. U.S. CL. 26 (INT. CL. 9).
1,541,250, REN. 12-20-08. INT. CL. 9.

LEVY, JEFFREY, THORNHILL, CANADA:
3,568,756, MULTIPLE CLASS, INT. CLS. 35 AND 38.

LEWIS AND CLARK BICENTENNIAL MARKETING GROUP, INC., LAKESIDE, MT:
2,548,215, CANC. INT. CL. 14.

LEWIS, ANN LINDA, LOS ANGELES, CA:
2,546,935, CANC. INT. CL. 20.

LEWIS, EDWARD, BRONX, NY:
2,548,418, CANC. INT. CL. 3.

LEYBOLD SYSTEMS GMBH, D-63450 HANAU, FED REP GERMANY:
2,547,672, CANC. INT. CL. 7.

LF, LLC, WILMINGTON, DE:
3,568,506, INT. CL. 7.

LIAM-E INFORMATION SERVICES CORP., TAIPEI, TAIWAN:
2,547,906, CANC. INT. CL. 38.

LIBERATE TECHNOLOGIES, REDWOOD SHORES, CA:
2,547,810, CANC. INT. CL. 41.

LIBERTY BAY CREDIT UNION, BOSTON, MA:
3,567,513, PUB. 11-11-2008. INT. CL. 36.

LIBERTY HARBOR YACHT CLUB, HACKENSACK, NJ:
2,547,537, CANC. INT. CL. 41.

LIBERTY HARDWARE MFG. CORP., WINSTON-SALEM, NC:
2,548,186, CANC. INT. CL. 21.
3,568,181, INT. CL. 6.

LIBERTY MUTUAL INSURANCE COMPANY, BOSTON, MA:
3,566,792, PUB. 11-11-2008. MULTIPLE CLASS, INT. CLS. 35 AND 36.
3,566,794, PUB. 11-11-2008. MULTIPLE CLASS, INT. CLS. 35 AND 36.

LIDL STIFTUNG & CO. KG, 74172 NECKARSULM, FED REP GERMANY:
2,546,777, CANC. INT. CL. 30.

LIEBHERR-HOLDING GMBH, 88400 BIBERACH, FED REP GERMANY:
2,232,642, REN. 12-20-08. INT. CL. 9.

LIENTEN TECHNOLOGY CO., LTD., CHANGHUA HSIEN, TAIWAN:
2,546,421, CANC. INT. CL. 9.

LIFEBURST, INC., LOS ANGELES, CA:
3,567,363, PUB. 11-11-2008. INT. CL. 5.

LIFECARE TECHNOLOGIES, INC., CLEARWATER, FL:
2,545,933, CANC. INT. CL. 42.

LIFELINK FOUNDATION, INC., TAMPA, FL:
3,567,545, PUB. 11-11-2008. INT. CL. 35.

LIFEMINDERS, INC., HERNDON, VA:
2,547,751, CANC. INT. CL. 35.

LIFEMODELER, INC., SAN CLEMENTE, CA:
3,568,245, INT. CL. 9.

LIFESTATION, INC., BROOKLYN, NY:
3,566,648, PUB. 11-11-2008. INT. CL. 45.

LIFETIME PRODUCTS, INC., CLEARFIELD, UT:
2,548,325, CANC. INT. CL. 20.

- LIGHTNING BURGERS, INC., IRVING, TX:
2,546,158, CANC. INT. CL. 30.
- LIGHTNING MASTER CORPORATION, CLEARWATER, FL:
2,548,190, CANC. INT. CL. 19.
- LILESTONE, PLC, LONDON, W11 2DF, UNITED KINGDOM:
3,567,727, PUB. 9-19-2006. INT. CL. 3.
- LIMETREE ENTERPRISES INC, LIVINGSTON, NJ:
3,568,215, INT. CL. 41.
- LIMETREE, INC., ATLANTA, GA:
3,566,777, PUB. 11-11-2008. INT. CL. 35.
- LIMITED STORES, LLC, COLUMBUS, OH:
3,568,178, INT. CL. 35.
- LINCOLN BENEFIT LIFE COMPANY, LINCOLN, NE:
2,144,589, CANC. INT. CL. 36.
- LINCOLN LABORATORIES, INC., MIAMI, FL TO MERIEUX AMERICA HOLDINGS COMPANY, INC., LAS VEGAS, NV:
1,480,395, CANC. INT. CL. 5.
- LINCOLN NATIONAL CORPORATION, RADNOR, PA:
3,568,402, INT. CL. 36.
- LINCOLN PAPER AND TISSUE, LLC, LINCOLN, ME:
2,212,657, REN. 12-19-08. INT. CL. 16.
- LINDA ENTERPRISES LIMITED, UNITED KINGDOM:
3,567,832, PUB. 11-11-2008. MULTIPLE CLASS, INT. CLS. 29 AND 30.
- LINE 6, INC., CALABASAS, CA:
3,566,868, PUB. 11-11-2008. INT. CL. 9.
- LINE, BONNIE, LUBBOCK, TX:
3,567,662, PUB. 11-11-2008. INT. CL. 30.
- LINKYO CORP., LA PUENTE, CA:
3,566,719, PUB. 11-11-2008. INT. CL. 9.
3,566,734, PUB. 11-11-2008. INT. CL. 9.
- LINWOOD HOMES, LTD., DELTA, V4G1B5, CANADA:
3,566,362, PUB. 11-11-2008. MULTIPLE CLASS, INT. CLS. 35, 37, 41 AND 42.
- LIPARI FOODS, INC., WARREN, MI:
3,568,158, INT. CL. 29.
- LIPO CHEMICALS, INC, PATERSON, NJ:
3,566,331, PUB. 11-11-2008. INT. CL. 16.
3,566,332, PUB. 11-11-2008. INT. CL. 16.
- LISA FRANK, INC., TUCSON, AZ:
2,545,726, CANC. INT. CL. 28.
- LISTO PENCIL CORPORATION, ALAMEDA, CA:
3,566,546, PUB. 11-11-2008. MULTIPLE CLASS, INT. CLS. 8 AND 16.
- LITI HOLOGRAPHICS, NEWPORT NEWS, VA:
2,546,122, CANC. MULTIPLE CLASS, INT. CLS. 16 AND 42.
2,546,123, CANC. MULTIPLE CLASS, INT. CLS. 16 AND 42.
- LITTERST HOLDINGS CORPORATION, CONCORD, ONTARIO, L4K 1L6, CANADA:
2,545,552, CANC. INT. CL. 30.
- LITTLE MOON INC., POUGHKEEPSIE, NY:
2,623,813, CANC. INT. CL. 30.
- LITTLE, DONALD WARREN, SUN VALLEY, CA:
2,547,712, CANC. INT. CL. 25.
- LITTLEYE LLC, MARINA DEL REY, CA:
3,566,816, PUB. 11-11-2008. INT. CL. 35.
- LIVBAG, 755017 PARIS, FRANCE:
2,546,867, CANC. MULTIPLE CLASS, INT. CLS. 11, 12 AND 13.
- LIVING CONSCIOUSLY BY DESIGN, INC., FOXBORO, MA:
3,568,365, MULTIPLE CLASS, INT. CLS. 9, 35 AND 41.
3,568,425, MULTIPLE CLASS, INT. CLS. 3, 4, 9, 14, 16, 18 AND 25.
3,568,532, INT. CL. 16.
- LIZ CLAIBORNE, INC., NEW YORK, NY:
1,480,853, CANC. INT. CL. 25.
- LOCALE SYSTEMS CORPORATION, AUSTIN, TX:
2,545,955, CANC. INT. CL. 35.
- LOCKTON RISK SERVICES, INC., OVERLAND PARK, KS:
3,567,091, PUB. 11-11-2008. INT. CL. 36.
- LOCO BEVERAGES LLC, NEW YORK, NY:
2,548,398, CANC. INT. CL. 32.
- LOEWE S.A., MADRID, SPAIN:
1,513,278, REN. 12-20-08. MULTIPLE CLASS, INT. CLS. 3 AND 14.
- LOGICRULES, ALPHARETTA, GA:
3,567,510, PUB. 11-11-2008. INT. CL. 16.
- LOGTEK LIMITED, LOUTH, LINCOLNSHIRE, GREAT BRITAIN:
2,546,748, CANC. INT. CL. 9.
- LOHMANN AND RAUSCHER INTERNATIONAL GMBH & CO., KG, 56579 RENGSDORF, FED REP GERMANY:
2,545,662, CANC. MULTIPLE CLASS, INT. CLS. 3, 5, 10, 24, 25, 35, 39 AND 42.
- LOLA B, L.L.C., PHOENIX, AZ:
3,567,041, PUB. 11-11-2008. INT. CL. 10.
- LOMOGRAPHISCHE AG, AUSTRIA:
3,468,285, COR. INT. CL. 18.
- LONG AGRIBUSINESS, LLC, TARBORO, NC:
2,547,729, CANC. MULTIPLE CLASS, INT. CLS. 6, 7 AND 12.
- LONG WINNER TRADING LIMITED, MONGKOK, KOWLOON, HONG KONG, CHINA:
2,547,301, CANC. INT. CL. 9.
- LONZA INC., FAIR LAWN, NJ:
1,106,410, REN. 12-20-08. INT. CL. 1.
1,106,411, REN. 12-20-08. INT. CL. 1.
1,106,412, REN. 12-20-08. INT. CL. 1.
- LOOMIS, RODNEY, TRANSFER, PA, DBA LOOMCO INTERNATIONAL:
2,547,944, CANC. INT. CL. 35.
- LOPEZ, RUBEN LEE, LOS ANGELES, CA:
2,546,166, CANC. INT. CL. 16.
- LOS ANGELES COUNTY FAIR ASSOCIATION, POMONA, CA, DBA LOS ANGELES COUNTY FAIR:
1,481,112, CANC. INT. CL. 41.
- LOTUS OPTICAL INDUSTRIES CORP., S. EL MONTE, CA:
2,546,237, CANC. INT. CL. 9.
- LOUIS DESIGNS USA LIMITED, RIDGEWOOD, NY:
3,566,444, PUB. 11-11-2008. INT. CL. 18.
- LOUIS DREYFUS TRADEMARKS B.V., NETHERLANDS:
3,567,933, PUB. 11-11-2008. MULTIPLE CLASS, INT. CLS. 1, 3, 4, 6, 7, 12, 19, 22, 23, 24, 29, 30, 31, 32, 35, 36, 37, 38, 39, 40 AND 42.
3,567,934, PUB. 11-11-2008. MULTIPLE CLASS, INT. CLS. 1, 3, 4, 6, 7, 12, 19, 22, 23, 24, 29, 30, 31, 32, 35, 36, 37, 38, 39, 40 AND 42.
3,567,935, PUB. 11-11-2008. MULTIPLE CLASS, INT. CLS. 1, 3, 4, 6, 7, 12, 19, 22, 23, 24, 29, 30, 31, 32, 35, 36, 37, 38, 39, 40 AND 42.
3,567,936, PUB. 11-11-2008. MULTIPLE CLASS, INT. CLS. 1, 3, 4, 6, 7, 12, 19, 22, 23, 24, 29, 30, 31, 32, 35, 36, 37, 38, 39, 40 AND 42.
- LOUISIANA STATE BAR ASSOCIATION, NEW ORLEANS, LA:
2,180,727, REN. 12-20-08. INT. CL. 16.
- LOVE LINE, INC., HOUSTON, TX, DBA LOVE LINE, INC:
3,568,617, INT. CL. 25.
- LOVERLY, INC., ASTORIA, NY:
3,568,565, INT. CL. 25.
- LSI LOGIC CORPORATION, MILPITAS, CA:
2,145,004, CANC. INT. CL. 9.
- LSP INDUSTRIES, INC., ROCKFORD, IL:
1,480,472, CANC. INT. CL. 7.
- LTV NETWORKS, INC., NEW YORK, NY:
2,545,917, CANC. INT. CL. 41.
- LUBECK, SUSAN, TUSTIN RANCH, CA:
2,547,533, CANC. INT. CL. 35.
- LUBRIZOL ADVANCED MATERIALS, INC., CLEVELAND, OH:
1,534,690, REN. 12-22-08. MULTIPLE CLASS, INT. CLS. 40 AND 42.
- LUCASFILM ENTERTAINMENT COMPANY LTD., SAN FRANCISCO, CA:
3,568,587, INT. CL. 28.
- LUDWIG, TIMOTHY, MISHAWAKA, IN:
2,548,114, CANC. INT. CL. 25.
- LUMABED INCORPORATED, CHICAGO, IL:
2,546,692, CANC. INT. CL. 35.

LUMENCRAFT INC., NOVATO, CA:
3,567,297, PUB. 11-11-2008. INT. CL. 11.

LUMI-LITE CANDLE COMPANY, INC., NORWICH, OH:
2,548,365, CANC. MULTIPLE CLASS, INT. CLS. 3 AND 4.

LUND, SHARON, SAN DIEGO, CA:
3,566,956, PUB. 11-11-2008. INT. CL. 41.

LURE BOX, INC., HACKETTSTOWN, NJ:
2,548,584, CANC. INT. CL. 28.

LURIE COMPANY, THE, SAN FRANCISCO, CA:
2,206,059, REN. 12-22-08. INT. CL. 42.

LUTRIS TECHNOLOGIES, INC., SANTA CRUZ, CA:
2,548,346, CANC. MULTIPLE CLASS, INT. CLS. 9 AND 42.

LYFESYSTEMS, INC, SEATTLE, WA:
3,568,395, INT. CL. 36.
3,568,396, INT. CL. 36.

LYONS, WENDY K., JACKSON, MS AND LYONS, CURTIS B., BRANDON, MS:
3,566,476, PUB. 11-11-2008. INT. CL. 28.

M & B PETS, INC., HONOLULU, HI:
2,546,788, CANC. INT. CL. 35.

M STREET RESTAURANT CORPORATION, WASHINGTON, DC:
1,481,116, CANC. INT. CL. 42.

M. BRANDON SMITH, BIRMINGHAM, AL:
3,566,837, PUB. 11-11-2008. INT. CL. 37.

M. S. WALKER, INC., SOMERVILLE, MA:
668,477, REN. 12-20-08. U.S. CL. 49 (INT. CL. 33).

M.E.D.C. CORP., THE, BEACON, NY:
1,480,900, CANC. INT. CL. 28.

M.G. MINI GEARS S.P.A., ITALY:
3,567,991, PUB. 11-11-2008. MULTIPLE CLASS, INT. CLS. 7 AND 12.

MAC-LACE LEATHER PTY, LTD., SOUTH BRISBANE, QUEENSLAND 4101, AUSTRALIA:
2,547,153, CANC. INT. CL. 3.

MACCARTY, WILLIAM "SKIP", BERRIEN SPRINGS, MI:
2,546,731, CANC. INT. CL. 16.

MACE SECURITY INTERNATIONAL, INC., BENNINGTON, VT:
3,568,302, INT. CL. 13.

MACHNIEWSKA-SCHLUSSMAN, MALGORZATA TERESA, NEW YORK, NY:
2,545,501, CANC. INT. CL. 42.

MACK TRUCKS, INC., ALLENTOWN, PA:
3,566,701, PUB. 11-11-2008. INT. CL. 12.

MACKEY, PRECIOUS, PORT SAINT LUCIE, FL:
3,567,460, PUB. 11-11-2008. INT. CL. 35.

MACMILLAN, INC., NEW YORK, NY:
1,480,792, CANC. INT. CL. 16.

MACRAE DESIGNS, INC., ATLANTA, GA:
3,567,316, PUB. 11-11-2008. INT. CL. 20.

MACRONIX INTERNATIONAL CO., LTD., TAIWAN, TAIWAN:
3,567,730, PUB. 11-11-2008. MULTIPLE CLASS, INT. CLS. 9, 40 AND 42.

MADE IN RESPECT, FRANCE:
3,567,924, PUB. 11-11-2008. MULTIPLE CLASS, INT. CLS. 35, 42 AND 45.

MADISON, JULIETTE, B., WASHINGTON, DC:
2,547,453, CANC. INT. CL. 21.

MAGGIE BRANCH HANDKNITS LTD., QUALICUM BEACH, BRITISH COLUMBIA, CANADA:
2,144,796, CANC. INT. CL. 25.

MAGIC VENT COMPANY, INC., HIGHLAND, IN:
2,547,601, CANC. INT. CL. 11.

MAGLA WORLD WIDE, LTD, VEGA BAJA, PUERTO RICO:
2,548,161, CANC. INT. CL. 9.

MAGNESITAS NAVARRAS S.A., ZUBIRI (NAVARRAS), SPAIN:
3,567,327, PUB. 11-11-2008. INT. CL. 19.
3,567,330, PUB. 11-11-2008. INT. CL. 19.
3,567,332, PUB. 11-11-2008. INT. CL. 19.

MAGNETICS USA, INC., MIAMI, FL:
3,567,251, PUB. 11-11-2008. INT. CL. 9.

MAGNETIZER GROUP, INC., THE, GARDENVILLE, PA:
2,547,499, CANC. INT. CL. 9.

MAGNOLIA CITRUS ASSOCIATION, PORTERVILLE, CA:
517,141, REN. 12-19-08. U.S. CL. 46 (INT. CL. 31).

MAGNUS RESEARCH CONSULTANTS, INC., POMPANO BEACH, FL:
3,567,659, PUB. 11-11-2008. INT. CL. 45.
3,567,661, PUB. 11-11-2008. INT. CL. 45.

MAGTEC ENERGY, LLC, FARGO, ND:
3,567,641, PUB. 11-11-2008. INT. CL. 11.

MAIER, ANTON, GREECE:
3,567,888, PUB. 11-11-2008. INT. CL. 25.

MAIN STREET PICTURES, INC., HOLLYWOOD, CA:
3,568,232, INT. CL. 41.

MAINE PUBLIC SERVICE COMPANY, PRESQUE ISLE, ME:
2,546,833, CANC. INT. CL. 35.

MAJESTIC DRUG CO., INC., SOUTH FALLSBURG, NY:
2,548,188, CANC. INT. CL. 5.

MAJORS, MONICA, LONG BEACH, CA:
3,568,493, INT. CL. 42.

MAKHTESHIM CHEMICAL WORKS LTD., 84100 BEER SHEVA, ISRAEL AND AGAN CHEMICAL MANUFACTURERS LTD., 77102 ASHDOD, ISRAEL:
2,148,901, REN. 12-20-08. INT. CL. 5.

MAKO METALS, INC., OLYMPIA FIELDS, IL:
3,567,424, PUB. 11-11-2008. INT. CL. 35.
3,567,425, PUB. 11-11-2008. INT. CL. 35.

MAL TECHNOLOGY SDN BHD, PUCHONG, SELANGOR, MALAYSIA:
3,568,331, INT. CL. 9.

MALATESTAS LLC, SAN FRANCISCO, CA:
3,566,510, PUB. 11-11-2008. INT. CL. 44.

MALDONADO, MARGARET, LOS ANGELES, CA:
3,567,678, PUB. 11-11-2008. INT. CL. 41.

MALENA PRODUCE, INC., RIO RICO, AZ:
3,566,379, PUB. 11-11-2008. INT. CL. 31.

MALIA, TARA, A., SEA GIRT, NJ:
3,567,093, PUB. 11-11-2008. INT. CL. 41.

MALT-O-MEAL CO., MINNEAPOLIS, MN:
1,540,726, REN. 12-19-08. INT. CL. 30.

MALT-O-MEAL COMPANY, MINNEAPOLIS, MN:
2,251,926, REN. 12-19-08. INT. CL. 30.
2,263,764, REN. 12-19-08. INT. CL. 30.
2,290,589, REN. 12-19-08. INT. CL. 30.

MALVERN INSTRUMENTS INCORPORATED, SOUTH-BOROUGH, MA:
1,480,675, CANC. INT. CL. 9.

MAN POWER MUSIC GROUP, LLC, ATLANTA, GA:
3,567,406, PUB. 11-11-2008. INT. CL. 41.

MANAGEMENT COMPUTER SERVICES, INC., COLUMBUS, OH:
1,480,577, CANC. INT. CL. 9.

MANAGEMENT EXPERTS, INC. FROSTPROOF, FL:
3,566,531, PUB. 11-11-2008. INT. CL. 35.

MANDALAY REAL ESTATE LIMITED, 2001 NEUCHATEL, SWITZERLAND:
3,568,174, INT. CL. 25.

MANGANLOTIS, JOHNNY, CLIFTON, NJ:
3,568,544, MULTIPLE CLASS, INT. CLS. 25 AND 30.

MANGO IMPORTS, INC., SEATTLE, WA:
3,567,074, PUB. 11-11-2008. INT. CL. 24.

MANHATTAN JEWISH EXPERIENCE SYNAGOGUE, NEW YORK, NY:
3,566,872, PUB. 11-11-2008. INT. CL. 41.

MANIFATTURE GENERALI SRL, VIA CARRIONA 261, ITALY:
2,214,794, REN. 12-24-08. MULTIPLE CLASS, INT. CLS. 18 AND 25.

MANIFESTO, INC., CHICAGO, IL:
1,496,296, REN. 12-24-08. INT. CL. 42.

MANUFACTURAS ALHAMBRA, S.L., SPAIN:
3,567,903, PUB. 11-11-2008. INT. CL. 15.

MANUFACTURED PLASTICS & DISTRIBUTION, INC., DENVER, CO:
1,480,803, CANC. INT. CL. 17.

MANULI RUBBER INDUSTRIES S.P.A., ITALY:
3,567,854, PUB. 11-11-2008. MULTIPLE CLASS, INT. CLS. 6 AND 17.
3,567,857, PUB. 11-11-2008. INT. CL. 17.
3,567,859, PUB. 11-11-2008. MULTIPLE CLASS, INT. CLS.

- 6 AND 17.
3,567,861, PUB. 11-11-2008. MULTIPLE CLASS, INT. CLS.
6 AND 17.
3,567,862, PUB. 11-11-2008. INT. CL. 17.
- MAPDENTIST, INC, IRVINE, CA:
3,567,650, PUB. 11-11-2008. INT. CL. 35.
- MAPLE LEAF CONSUMER FOODS INC./LES ALIMENTS
DE CONSOMMATION MAPLE LEAF INC., KITCHENER,
CANADA:
2,546,143, CANC. INT. CL. 30.
- MAQUET CRITICAL CARE AB, SE-171 95 SOLNA, SWE-
DEN:
3,567,894, PUB. 11-11-2008. MULTIPLE CLASS, INT. CLS.
9 AND 10.
- MARA CAROL S.R.L., ITALY:
3,567,947, PUB. 11-11-2008. MULTIPLE CLASS, INT. CLS.
14, 18 AND 25.
- MARCADY, INC., BROOKLYN, NY:
3,566,847, PUB. 11-11-2008. MULTIPLE CLASS, INT. CLS.
8 AND 21.
- MARCHESI DE' FRESCOBALDI SOCIETA' AGRICOLA
S.R.L., 50125 FIRENZE, ITALY, FRESCOBALDI, FIRE-
NZE, ITALY:
1,109,623, REN. 12-19-08. INT. CL. 33.
- MARCHON EYEWEAR, INC., MELVILLE, NY:
2,548,326, CANC. INT. CL. 9.
- MARES, THOMAS, LAS VEGAS, NV:
3,567,320, PUB. 11-11-2008. INT. CL. 41.
- MARGARETE STEIFF GMBH, FED REP GERMANY:
3,567,808, PUB. 6-10-2008. MULTIPLE CLASS, INT. CLS.
14, 16, 18, 21 AND 25.
- MARIANNE VAN ESSEN; H.O.D.N. MARIAN VAN ESSEN;
ATELIER VOOR KUNST EN ONTWERP, NETHER-
LANDS:
3,567,937, PUB. 11-11-2008. INT. CL. 14.
- MARK ANTHONY INTERNATIONAL SRL, ROCKLEY,
CHRIST CHURCH, BARBADOS:
3,566,512, PUB. 5-6-2008. MULTIPLE CLASS, INT. CLS. 32
AND 33.
- MARKARIAN, MEREDITH LEE, NEW YORK, NY, DBA
MEREDITH INTERNATIONAL:
2,547,951, CANC. INT. CL. 28.
- MARKEM CORPORATION, KEENE, NH:
1,480,793, CANC. INT. CL. 16.
- MARKER/VOLKLE USA, INC., WEST LEBANON, NH:
3,568,719, INT. CL. 28.
- MARKET CENTRAL, INC., PITTSBURGH, PA:
3,568,549, INT. CL. 9.
- MARKET PLANNING SOLUTIONS INC., TULSA, OK:
2,545,793, CANC. INT. CL. 9.
- MARKET STRATEGIES, INC., LIVONIA, MI:
2,547,120, CANC. INT. CL. 35.
- MARKETSMARTZ, INC., KANSAS CITY, MO:
2,548,271, CANC. INT. CL. 35.
- MARKEY MACHINERY COMPANY, INC., SEATTLE, WA:
3,566,906, PUB. 11-11-2008. INT. CL. 42.
- MARKOWITZ, GARY, LEXINGTON, MA:
2,547,073, CANC. MULTIPLE CLASS, INT. CLS. 16, 35
AND 42.
- MARKSMEN INC., GLENDALE, CA:
2,208,330, REN. 12-20-08. INT. CL. 35.
- MARLENA INC., CHICAGO, IL:
2,546,222, CANC. MULTIPLE CLASS, INT. CLS. 3 AND
35.
- MARLENE M. GUIRGUIS, NORTHRIDGE, CA:
3,568,686, INT. CL. 25.
- MARLIN INDUSTRIAL DIVISION, INC., NORTH HAVEN,
CT:
1,480,757, CANC. INT. CL. 16.
- MARPESSA, INC., SOLANA BEACH, CA:
3,568,358, INT. CL. 25.
3,568,514, INT. CL. 25.
- MARRA, MELISSA M., CHESTERLAND, OH, DBA KID-
CARDS:
3,568,515, INT. CL. 16.
- MARRIOTT INTERNATIONAL, INC., BETHESDA, MD:
1,481,150, CANC. INT. CL. 42.
2,231,050, REN. 12-22-08. MULTIPLE CLASS, INT. CLS.
- 41 AND 42.
- MARROQUIN, MICHAEL, ANTHONY, BONITA, CA:
3,567,758, PUB. 11-11-2008. INT. CL. 36.
- MARS, INCORPORATED, MCLEAN, VA:
1,480,951, CANC. INT. CL. 30.
3,568,286, INT. CL. 31.
- MARSHALL INSTITUTE, INC., RALEIGH, NC:
2,144,031, CANC. INT. CL. 41.
- MARSHALL RESEARCH, LLC, DUBLIN, GA:
2,547,619, CANC. INT. CL. 9.
- MARSHALLS OF NEVADA, INC., NORTH LAS VEGAS, NV:
2,547,681, CANC. INT. CL. 41.
- MARSHALLTOWN COMPANY, MARSHALLTOWN, IA:
2,548,317, CANC. INT. CL. 8.
- MARTEX FIBER SOUTHERN CORP., PHILADELPHIA, PA:
2,204,518, REN. 12-24-08. INT. CL. 23.
- MARTIN EAGLE OIL COMPANY, INC., DENTON, TX:
3,566,430, PUB. 11-11-2008. INT. CL. 35.
- MARTIN, BROOKS B., HATTIESBURG, MS:
3,567,508, PUB. 11-11-2008. MULTIPLE CLASS, INT. CLS.
16 AND 25.
- MARTIN, HELEN, STUART, FL:
3,568,411, INT. CL. 41.
- MARTINEZ, FELIX B., SAN JUAN, PUERTO RICO:
2,547,351, CANC. INT. CL. 3.
- MARTINI & ROSSI CORPORATION, MIAMI, FL:
2,545,938, CANC. INT. CL. 33.
- MARTINTATE, L.L.C. CINCINNATI, OH:
2,545,596, CANC. INT. CL. 41.
- MARUI, LTD., KOBE 650-0022, JAPAN:
2,196,275, REN. 12-19-08. INT. CL. 12.
- MARY KAY COSMETICS, INC.:
1,513,319, REN. 12-20-08. INT. CL. 5.
- MARY KAY INC., DALLAS, TX:
2,548,487, CANC. INT. CL. 28.
- MARY NICHOLS LLC, HOUSTON, TX:
3,567,278, PUB. 11-11-2008. INT. CL. 18.
- MARYLAND JOCKEY CLUB OF BALTIMORE CITY, INC.,
THE, BALTIMORE, MD:
1,514,013, REN. 12-20-08. INT. CL. 41.
- MASADA LEATHER COMPANY, INC., ATHENS, GA:
3,566,723, PUB. 11-11-2008. INT. CL. 35.
- MASON, GENE, CHATTANOOGA, TN:
2,547,611, CANC. INT. CL. 21.
- MASONITE INTERNATIONAL CORPORATION, MISSIS-
SAUGA, CANADA:
3,568,633, INT. CL. 19.
3,568,634, INT. CL. 19.
- MASPICA SRL, ITALY:
3,567,945, PUB. 11-11-2008. MULTIPLE CLASS, INT. CLS.
9 AND 25.
- MASSACHUSETTS FINANCIAL SERVICES COMPANY,
BOSTON, MA:
2,224,011, REN. 12-22-08. INT. CL. 36.
- MASSEY, GREIG B., KNOXVILLE, TN, DBA MACBOMB:
2,144,057, CANC. INT. CL. 42.
- MASTER COUNSEL TECHNOLOGIES, LEWISVILLE, NC:
2,547,238, CANC. INT. CL. 9.
- MASTER MARINERS BENEVOLENT ASSOCIATION, NO-
VATO, CA, DBA MASTER MARINERS OF SAN FRAN-
CISCO BAY:
3,567,333, PUB. 11-11-2008. INT. CL. 41.
- MASTER SHIELD BUILDING PRODUCTS CO., L.P.,
WEATHERFORD, TX:
1,480,817, CANC. INT. CL. 19.
- MASTRANGELO, LAURA M., BROOKLYN, NY:
2,548,230, CANC. INT. CL. 24.
- MASTRONET, INC., OAK BROOK, IL:
2,546,578, CANC. INT. CL. 35.
- MATERIAL HANDLING INDUSTRY, CHARLOTTE, NC:
2,547,134, CANC. INT. CL. 42.
- MATRIX TECHNOLOGIES LLC, HUDSON, NH:
2,210,708, REN. 12-19-08. INT. CL. 9.
- MATSUO SANGYO CO., LTD., OSAKA 550-0011, JAPAN:
3,567,920, PUB. 11-11-2008. MULTIPLE CLASS, INT. CLS.
14, 18, 21, 25 AND 26.
- MATTEL, INC., EI SEGUNDO, CA:
2,547,770, CANC. INT. CL. 28.

MATTEL, INC., EL SEGUNDO, CA:
 2,547,876, CANC. INT. CL. 28.
 2,547,883, CANC. INT. CL. 28.
 2,547,959, CANC. INT. CL. 28.
 3,566,676, PUB. 11-11-2008. INT. CL. 28.
 3,568,191, INT. CL. 28.
 3,568,194, INT. CL. 28.
 3,568,195, INT. CL. 28.
 3,568,688, MULTIPLE CLASS, INT. CLS. 9 AND 28.

MATTIOLI ENGINEERING LTD., W2 1HY, UNITED KINGDOM:
 2,548,018, CANC. INT. CL. 10.

MAUER S.A.S. DI FABIO POZZALI & C., 26013 CREMA, ITALY:
 3,566,581, PUB. 11-11-2008. INT. CL. 29.

MAUI USA, INC., LAHAINA, HI:
 2,546,861, CANC. INT. CL. 37.

MAURA DANIEL, INC., CULVER CITY, CA:
 3,568,326, INT. CL. 11.

MAURY FRIEDMAN, AGOURA HILLS, CA:
 3,568,250, INT. CL. 38.

MAVERICK INTERNATIONAL PROCESSING SERVICES, INC., TUCSON, AZ:
 2,548,014, CANC. INT. CL. 9.

MAXCOMM, LLC, SALT LAKE CITY, UT:
 3,567,423, PUB. 11-11-2008. MULTIPLE CLASS, INT. CLS. 35 AND 41.

MAXI MILIAAN B.V., HELMOND, NETHERLANDS:
 3,568,096, INT. CL. 12.

MAXIMA MANUFACTURING COMPANY MEINEL VERWALTUNGES GMBH & CO. KG, GERETSRIED, FED REP GERMANY:
 3,568,460, INT. CL. 28.

MAXIMAR LLC, PACIFICA, CA:
 2,546,505, CANC. INT. CL. 22.

MAYER-PAETZ, INC., INDIANAPOLIS, IN:
 2,279,082, REN. 12-20-08. INT. CL. 24.

MAYO FOUNDATION FOR MEDICAL EDUCATION AND RESEARCH, ROCHESTER, MN:
 2,547,366, CANC. INT. CL. 9.

MAYR-MELNHOF KARTON AKTIENGESELLSCHAFT, A-1040 WIEN, AUSTRIA:
 2,162,367, REN. 12-22-08. INT. CL. 16.

MAZDA MOTOR CORPORATION, AKI-GUN, HIROSHIMA, JAPAN:
 2,219,891, REN. 12-19-08. MULTIPLE CLASS, INT. CLS. 6 AND 12.

MAZZEI, SARAH E., CHANDLER, AZ:
 3,568,097, INT. CL. 35.

MBV, INC., WILMINGTON, DE:
 2,547,707, CANC. INT. CL. 16.

MCALLISTER, DONNA C., SAN FRANCISCO, CA, DBA STINKWEAR:
 3,566,850, PUB. 11-11-2008. INT. CL. 25.

MCBRIDE, SUSAN, ASHEVILLE, NC:
 3,567,198, PUB. 11-11-2008. INT. CL. 42.

MCCAIN FOODS USA, INC., OAK BROOK, IL:
 2,281,718, REN. 12-20-08. INT. CL. 29.

MCCARNEY, KEVIN, NORTH HOLLYWOOD, CA, DBA POQUITO MAS:
 3,567,088, PUB. 11-11-2008. INT. CL. 43.

MCCORD RESEARCH, INC., IOWA CITY, IA:
 3,567,697, PUB. 11-11-2008. MULTIPLE CLASS, INT. CLS. 3 AND 5.

MCCRACKIN INDUSTRIES, INC., CONLEY, GA:
 1,480,805, CANC. INT. CL. 18.

MCDONALD'S CORPORATION, OAK BROOK, IL:
 1,113,227, REN. 12-20-08. INT. CL. 28.
 2,196,134, REN. 12-24-08. INT. CL. 42.

MCDONOUGH, BRIAN W., LOS ANGELES, CA:
 3,566,778, PUB. 11-11-2008. INT. CL. 16.

MCGARRY MACHINE, INC., PORTLAND, OR:
 2,547,646, CANC. INT. CL. 12.

MCGRAW-HILL COMPANIES, INC., THE, NEW YORK, NY, MCGRAW-HILL COMPANIES, INC., THE, NEW YORK, NY:
 2,163,258, REN. 12-23-08. INT. CL. 16.

MCGRAW-HILL COMPANIES, INC., THE, NEW YORK, NY TO MCGRAW-HILL COMPANIES, INC., THE, NEW YORK, NY:
 2,163,258, CANC. INT. CL. 9.

MCGRAW-HILL COMPANIES, INC., THE, NEW YORK, NY:
 2,207,329, REN. 12-19-08. INT. CL. 16.
 2,546,371, CANC. INT. CL. 36.

MCKECHNIE SPECIALIST PRODUCTS LIMITED, WEST MIDLANDS WS9 8DS, ENGLAND:
 2,546,414, CANC. MULTIPLE CLASS, INT. CLS. 6 AND 7.

MCKELLER, MICHAEL A., ATLANTA, GA:
 2,545,838, CANC. INT. CL. 9.

MCKELVEY FINANCIAL, RAMONA, CA:
 3,566,355, PUB. 11-11-2008. INT. CL. 36.

MCKENZIE RIVER CORPORATION, SAN FRANCISCO, CA:
 2,145,022, CANC. INT. CL. 33.

MCLEAN INSURANCE AGENCY, INC., POTOMAC FALLS, VA:
 3,566,896, PUB. 11-11-2008. INT. CL. 36.
 3,566,897, PUB. 11-11-2008. INT. CL. 36.

MCRAE'S, INC., BIRMINGHAM, AL:
 2,548,244, CANC. INT. CL. 25.

MC2 LEARNING SYSTEMS INC., BURNABY, BRITISH COLUMBIA, CANADA:
 2,545,513, CANC. INT. CL. 9.

MEAD CORPORATION, THE, DAYTON, OH:
 2,548,333, CANC. INT. CL. 16.

MEADOWS OF WICKENBURG, L.P., THE, WICKENBURG, AZ:
 2,548,583, CANC. INT. CL. 41.

MEADWESTVACO CORPORATION, GLEN ALLEN, VA, UNITED STATES ENVELOPE COMPANY, SPRINGFIELD, MA:
 442,636, REN. 12-22-08. U.S. CL. 2 (INT. CL. 16).

MEADWESTVACO CORPORATION, STAMFORD, CT:
 2,548,392, CANC. INT. CL. 16.

MEAKINGS, BARRY, BURLINGTON, CANADA:
 3,566,670, PUB. 11-11-2008. MULTIPLE CLASS, INT. CLS. 17 AND 37.

MECHANICAL PLASTICS CORP., ELMSFORD, NY:
 2,212,578, REN. 12-23-08. MULTIPLE CLASS, INT. CLS. 7 AND 8.

MECKEL, BARRETT T, WALTON, NY:
 3,568,432, INT. CL. 30.

MECPLAST S.R.L., ITALY:
 3,567,849, PUB. 11-11-2008. INT. CL. 12.

MED APPRISE, INC., CHARLOTTE, NC:
 2,548,269, CANC. INT. CL. 35.

MEDASSETS SUPPLY CHAIN SYSTEMS, INC., ALPHARETTA, GA:
 2,545,609, CANC. MULTIPLE CLASS, INT. CLS. 16 AND 42.

MEDEA, ANDRA, CHICAGO, IL:
 3,566,661, PUB. 11-11-2008. INT. CL. 41.

MEDI-TECH INTERNATIONAL CORPORATION, BROOKLYN, NY:
 3,566,454, PUB. 11-11-2008. INT. CL. 5.

MEDIA BOUTIQUE, SAN FRANCISCO, CA:
 2,547,670, CANC. MULTIPLE CLASS, INT. CLS. 9, 16, 25, 41 AND 42.

MEDIA RESEARCH CENTER, ALEXANDIRA, VA:
 3,566,315, PUB. 11-11-2008. MULTIPLE CLASS, INT. CLS. 41 AND 42.

MEDIA 100, INC., MARLBORO, MA:
 2,548,136, CANC. INT. CL. 9.

MEDICAL ACTION INDUSTRIES INC., HAUPPAUGE, NY:
 2,548,402, CANC. INT. CL. 5.

MEDICAL ADVISORS, INC., PLYMOUTH MEETING, PA:
 2,212,032, REN. 12-23-08. INT. CL. 42.

MEDICAL EDUCATION PROGRAMS LTD., WILTON, CT:
 1,480,781, CANC. INT. CL. 16.

MEDITERRANEAN INDUSTRIES AND CONSULTING SERVICES LTD., EDMONTON, ALBERTA T6J 6S9, CANADA:
 2,548,259, CANC. INT. CL. 6.

MEDLINE INDUSTRIES, INC., MUNDELEIN, IL:
 2,293,865, REN. 12-19-08. INT. CL. 10.

MEDPOOL.COM, REDWOOD CITY, CA:
 2,548,013, CANC. INT. CL. 35.

- MEDS AND FOOD FOR KIDS, ST. LOUIS, MO:
3,568,052, INT. CL. 5.
- MEDTAC, L.C., SALT LAKE CITY, UT:
2,547,885, CANC. INT. CL. 41.
- MEDTRONIC, INC., MINNEAPOLIS, MN:
3,568,616, INT. CL. 9.
- MEIJER, INC., GRAND RAPIDS, MI:
2,546,996, CANC. MULTIPLE CLASS, INT. CLS. 16, 20 AND 21.
- MEIMETEAS, GEORGE C., SALEM, MA:
2,546,174, CANC. MULTIPLE CLASS, INT. CLS. 35 AND 42.
- MEL BERNIE AND COMPANY, INC., BURBANK, CA:
3,566,257, PUB. 11-11-2008. INT. CL. 14.
- MEMBERSRESOURCES.COM, INC., MILFORD, CT:
2,546,086, CANC. INT. CL. 42.
- MEMSCAP, 38920 CROLLES, FRANCE:
3,566,455, PUB. 11-11-2008. MULTIPLE CLASS, INT. CLS. 9, 10, 41 AND 42.
- MENACE ENTERTAINMENT GROUP L.L.C., THE, PRAIRIEVILLE, LA:
2,546,997, CANC. INT. CL. 9.
- MENARD, INC., EAU CLAIRE, WI:
3,568,222, INT. CL. 11.
3,568,223, INT. CL. 11.
- MENDELSON ELECTRONICS CO., INC., DAYTON, OH:
2,271,534, REN. 12-20-08. INT. CL. 35.
- MENDES, EVA, BEVERLY HILLS, CA:
3,568,564, MULTIPLE CLASS, INT. CLS. 24 AND 41.
- MENDEZ, CHRISTOPHER, APOPKA, FL:
3,566,378, PUB. 11-11-2008. INT. CL. 37.
- MENORAH MANOR, INC., ST. PETERSBURG, FL:
3,567,219, PUB. 11-11-2008. MULTIPLE CLASS, INT. CLS. 43 AND 44.
- MENSONIDES, NICOLE L., MUKILTEO, WA, DBA ASHLYN DESIGNS:
2,546,928, CANC. INT. CL. 26.
- MENTON S.A., LUXEMBOURG 2015, LUXEMBOURG:
2,545,615, CANC. INT. CL. 11.
- MENTOR TECHNOLOGIES GROUP, INC., ANNAPOLIS, MD:
2,546,062, CANC. INT. CL. 41.
- MEPLA-WERKE LAUTENSCHLÄGER GMBH & CO. KG, FED REP GERMANY:
3,567,851, PUB. 11-11-2008. MULTIPLE CLASS, INT. CLS. 6, 11 AND 20.
- MERCURIA ENERGY TRADING S.A., SWITZERLAND:
3,567,863, PUB. 11-11-2008. MULTIPLE CLASS, INT. CLS. 4, 35, 39 AND 40.
3,567,864, PUB. 11-11-2008. MULTIPLE CLASS, INT. CLS. 4, 35, 39 AND 40.
- MERCURY COMPOSITE TECHNOLOGIES, LLC, OXNARD, CA:
2,145,356, CANC. INT. CL. 28.
- MERCURY MADNESS, INC., WOODINVILLE, WA:
3,567,124, PUB. 11-11-2008. INT. CL. 43.
3,567,127, PUB. 11-11-2008. INT. CL. 43.
3,567,128, PUB. 11-11-2008. INT. CL. 43.
3,567,130, PUB. 11-11-2008. INT. CL. 43.
- MEREDITH COLLEGE, RALEIGH, NC:
3,566,740, PUB. 11-11-2008. INT. CL. 25.
3,566,761, PUB. 11-11-2008. INT. CL. 16.
3,566,762, PUB. 11-11-2008. INT. CL. 25.
- MEREDITH CORPORATION, DES MOINES, IA:
2,548,316, CANC. INT. CL. 28.
3,567,625, PUB. 11-11-2008. INT. CL. 16.
- MERIT GOLF COMPANY, KENNESAW, GA:
2,547,952, CANC. INT. CL. 28.
- MERLYN CONTRACTORS, INC., NOVI, MI:
2,214,519, REN. 12-24-08. INT. CL. 37.
- MERRELL, JOSH, IRVINE, CA:
3,568,148, INT. CL. 25.
- MERRILL LYNCH & CO., INC., NEW YORK, NY, CITY NATIONAL BANK & TRUST COMPANY, COLUMBUS, OH:
1,118,929, REN. 12-22-08. INT. CL. 36.
- MERRILL LYNCH & CO., INC., NEW YORK, NY:
2,144,017, CANC. INT. CL. 36.
2,548,549, CANC. INT. CL. 36.
- MERRILL LYNCH BANK & TRUST CO., FSB, NEW YORK, NY, DBA FIRST REPUBLIC BANK:
3,566,831, PUB. 11-11-2008. INT. CL. 36.
- MERTER HELVA SANAYI VE TICARET ANONIM SIRKETI, MERTER, ISTANBUL, TURKEY:
2,672,394, CANC. MULTIPLE CLASS, INT. CLS. 29 AND 30.
- MERZ PHARMA GMBH & CO. KGAA, FRANKFURT, FED REP GERMANY, MERZ & CO., 06000 FRANKFURT (MAIN)1, FED REP GERMANY:
1,111,173, REN. 12-24-08. INT. CL. 3.
- MESAS, MANUEL CAMACHO, BARCELONA, SPAIN:
2,546,266, CANC. INT. CL. 3.
- MESSINGER MULTIMEDIA COMPANY, MIAMI BEACH, FL:
2,548,612, CANC. MULTIPLE CLASS, INT. CLS. 9 AND 41.
- MET-PRO CORPORATION, HARLEYSVILLE, PA:
2,287,624, REN. 12-23-08. INT. CL. 11.
- METAGON TECHNOLOGIES, LLC, CHARLOTTE, NC:
2,545,856, CANC. INT. CL. 9.
- METAL ROOFS PLUS, INC., MANDEVILLE, LA:
2,546,097, CANC. INT. CL. 37.
2,546,098, CANC. INT. CL. 37.
- METROPOLITAN INDIANAPOLIS BOARD OF REALTORS, INDIANAPOLIS, IN:
3,568,356, INT. CL. 36.
- METROPOLITAN LIFE INSURANCE COMPANY, LONG ISLAND CITY, NY:
3,568,725, INT. CL. 36.
- METSO PAPER INC., FINLAND:
3,567,926, PUB. 11-11-2008. MULTIPLE CLASS, INT. CLS. 7 AND 37.
- MEYER MANUFACTURING COMPANY LIMITED, KOWLOON, HONGKONG, CHINA:
3,568,499, INT. CL. 21.
- MEZIAB INTERNATIONAL, L.L.C., TUCSON, AZ:
3,567,498, PUB. 11-11-2008. INT. CL. 35.
- MEZON, INC., LOS ANGELES, CA:
3,566,456, PUB. 10-30-2007. INT. CL. 18.
- MHA GLOBAL, L.L.C., SAN RAFAEL, CA:
2,547,324, CANC. INT. CL. 35.
- MI CHULA'S CORPORATION, SOUTHLAKE, TX:
3,567,341, PUB. 11-11-2008. INT. CL. 43.
- MIAMI SPORTSWEAR COMPANY, INC., HIALEAH, FL:
1,515,484, REN. 12-19-08. INT. CL. 25.
- MIAMI WABASH PAPER LLC, NORWALK, CT:
2,125,112, CANC. INT. CL. 16.
- MIBRO PARTNERS, TORONTO, ONTARIO, CANADA:
2,548,012, CANC. INT. CL. 7.
- MICERIUM SPA, I-16030 AVEGNO (GE), ITALY:
3,567,952, PUB. 11-11-2008. INT. CL. 5.
- MICHAEL A. TATE, MISSOULA, MT:
3,567,349, PUB. 11-11-2008. INT. CL. 30.
- MICHAEL C. POULIOT, INC., CLOVIS, CA:
2,546,497, CANC. MULTIPLE CLASS, INT. CLS. 16 AND 30.
- MICHAEL ELOVITZ, SAN CLEMENTE, CA:
3,566,856, PUB. 11-11-2008. INT. CL. 35.
- MICHAEL FIELDS AGRICULTURAL INSTITUTE, INC., MADISON, WI:
2,547,242, CANC. INT. CL. 29.
- MICHAEL GIBSON, GILBERT, AZ, DBA FACTORY DIRECT MODELS:
3,568,779, INT. CL. 28.
- MICHAEL MAN, HOK LIN, MORTON GROVE, IL:
2,548,267, CANC. INT. CL. 16.
- MICHAEL PETER MCHUGH, AUSTRALIA:
3,567,892, PUB. 11-11-2008. MULTIPLE CLASS, INT. CLS. 9, 16 AND 41.
- MICHELIN TIRE CORPORATION, GREENVILLE, SC:
1,480,740, CANC. INT. CL. 12.
- MICHIGAN ECONOMIC DEVELOPMENT CORPORATION, LANSING, MI:
3,566,692, PUB. 11-11-2008. INT. CL. 35.

- MICKEY DYE-ISHIKAWA, ASHEVILLE, NC, DBA THINGS FROM HOME INC.:
3,566,513, PUB. 11-11-2008. MULTIPLE CLASS, INT. CLS. 3 AND 45.
- MICREL, INCORPORATED, SAN JOSE, CA:
3,567,233, PUB. 11-11-2008. INT. CL. 9.
- MICRO IMAGING TECHNOLOGY, LAGUNA HILLS, CA:
2,546,238, CANC. INT. CL. 9.
- MICROMEDICS, INC., VERNON HILLS, IL:
3,567,038, PUB. 11-11-2008. INT. CL. 37.
- MICRONAS GMBH, 79108 FREIBURG, FED REP GERMANY:
3,567,826, PUB. 11-11-2008. MULTIPLE CLASS, INT. CLS. 9, 38 AND 42.
- MICROSOFT CORPORATION, REDMOND, WA:
2,546,480, CANC. INT. CL. 36.
2,547,606, CANC. MULTIPLE CLASS, INT. CLS. 9, 38, 39, 41 AND 42.
3,568,210, MULTIPLE CLASS, INT. CLS. 9 AND 42.
- MICROWEST DESIGN LTD., PRINCE GEORGE, CANADA:
3,566,541, PUB. 8-5-2008. INT. CL. 9.
- MID CONTINENT FARM'S, WASHINGTON, KS:
2,545,753, CANC. INT. CL. 35.
- MID RIVER MINERALS, INC., MORRIS, IL:
2,198,278, REN. 12-20-08. INT. CL. 6.
- MID-TOWN PETROLEUM INC., BRIDGEVIEW, IL:
3,567,386, PUB. 11-11-2008. INT. CL. 9.
- MIDAS-KAPITI INTERNATIONAL LIMITED, WIMBLEDON, LONDON SW19 4DR, ENGLAND:
2,547,864, CANC. MULTIPLE CLASS, INT. CLS. 9, 35, 36, 38, 41 AND 42.
- MIDLAND NATIONAL LIFE INSURANCE COMPANY, WEST DES MOINES, IA:
3,566,609, PUB. 11-11-2008. INT. CL. 36.
- MIDSOUTH PARTNERS, LANDOVER, MD:
2,546,506, CANC. INT. CL. 17.
- MIDWEST HOLDING, INC, STERLING HEIGHTS, MI:
2,545,534, CANC. INT. CL. 35.
- MIDWEST INDUSTRIES, INC., IDA GROVE, IA:
2,145,320, CANC. INT. CL. 12.
- MIDWEST MANUFACTURING SOLUTIONS, LLC, MASON, OH:
3,567,426, PUB. 11-11-2008. INT. CL. 35.
- MIDWIVES ALLIANCE OF NORTH AMERICA, WASHINGTON, DC:
3,568,183, INT. CL. 44.
- MIGHTY FINE BURGERS FRIES SHAKES, AUSTIN, TX:
3,567,120, PUB. 11-11-2008. INT. CL. 43.
- MIGUEL PEREZ COMMUNICATIONS, INC., MAITLAND, FL:
3,568,674, INT. CL. 38.
- MIHO, INC., WESTMINSTER, CA, DBA HUEY SPORT:
2,205,193, REN. 12-20-08. INT. CL. 25.
- MIKE TRYKE INC., SHERWOOD, OR:
2,547,726, CANC. INT. CL. 12.
- MIKODI, INC., RENO, NV:
1,480,572, CANC. INT. CL. 9.
- MILACRON INDUSTRIAL PRODUCTS, INC., LIVONIA, MI:
1,526,347, REN. 12-19-08. INT. CL. 1.
- MILANIAN, CYRUS, POMPANO BEACH, FL:
2,548,291, CANC. INT. CL. 35.
- MILITARY OFFICERS ASSOCIATION OF AMERICA, ALEXANDRIA, VA:
3,568,032, INT. CL. 35.
- MILLER BREWING COMPANY, MILWAUKEE, WI:
2,547,863, CANC. INT. CL. 32.
2,548,486, CANC. INT. CL. 32.
- MILLER PRODUCTS COMPANY, MILWAUKEE, WI:
2,548,222, CANC. INT. CL. 32.
- MILLER, ANDREW S., GREENDALE, WI:
2,545,594, CANC. INT. CL. 16.
- MILLER, PERCY, SANTA MONICA, CA:
3,567,376, PUB. 11-11-2008. INT. CL. 9.
3,567,377, PUB. 11-11-2008. INT. CL. 9.
- MILLER, WAYNE, VENICE, CA:
2,546,626, CANC. INT. CL. 41.
- MILLIPORE CORPORATION, BILLERICA, MA:
3,568,334, INT. CL. 1.
- MILTON-LLOYD LTD, LONDON SE27 9NR, ENGLAND:
2,545,975, CANC. INT. CL. 3.
- MIMEO.COM, INC., NEW YORK, NY:
3,566,899, PUB. 11-11-2008. MULTIPLE CLASS, INT. CLS. 40 AND 41.
3,566,900, PUB. 11-11-2008. MULTIPLE CLASS, INT. CLS. 40 AND 41.
- MINE SAFETY APPLIANCES COMPANY, PITTSBURGH, PA:
2,243,900, REN. 12-22-08. INT. CL. 16.
- MINERAL MASTERS CORPORATION, WEST CHICAGO, IL:
2,546,823, CANC. INT. CL. 7.
- MINERAL WORKS, MERIDIAN, ID:
2,210,939, REN. 12-22-08. INT. CL. 5.
- MINES, ANTHONY J., PALNYRA, VA:
1,480,830, CANC. INT. CL. 20.
- MINI DENTAL IMPLANT CENTERS OF AMERICA, INC., AMHERST, NY:
3,566,658, PUB. 11-11-2008. INT. CL. 44.
- MINICOM DATA CORPORATION, MARKHAM, ONTARIO, CANADA:
1,480,539, CANC. INT. CL. 9.
- MINNESOTA TIMBERWOLVES BASKETBALL LIMITED PARTNERSHIP, MINNEAPOLIS, MN:
2,212,589, REN. 12-20-08. INT. CL. 18.
- MINRAD INC., ORCHARD PARK, NY:
2,546,154, CANC. INT. CL. 10.
- MINVILLE, LAURA LAVALLE, 06700 MEXICO CITY, MEXICO:
2,546,376, CANC. INT. CL. 14.
- MIPS TECHNOLOGIES, INC., MOUNTAIN VIEW, CA:
3,568,481, INT. CL. 9.
- MIRACLE RECREATION EQUIPMENT COMPANY, MONETT, MO:
3,568,765, INT. CL. 36.
- MIRACOM CORPORATION, SANFORD, FL:
2,545,958, CANC. INT. CL. 35.
- MIRAMAR SECURITIES, LLC, COLUMBUS, GA:
2,144,577, CANC. INT. CL. 36.
- MIRRACO L.L.C., CARLSBAD, CA:
3,567,783, PUB. 11-11-2008. INT. CL. 25.
- MISHKA PRODUCTIONS, INC., SCOTTSDALE, AZ:
3,566,551, PUB. 11-11-2008. INT. CL. 41.
- MISS MELLOW, ROSEVILLE, CA:
3,567,367, PUB. 11-11-2008. INT. CL. 35.
- MISSION DESIGN AND DEVELOPMENT, L.L.C., ANN ARBOR, MI:
3,568,151, INT. CL. 43.
- MISTER HOLLYWOOD CO., LTD., OSAKA-SHI, OSAKA, JAPAN:
3,568,566, INT. CL. 25.
- MITALENA COFFEE INC., HOUSTON, TX:
2,547,004, CANC. INT. CL. 30.
- MITCHEM, JAMES D., NAPLES, FL:
3,568,108, INT. CL. 9.
- MITSUBA ELECTRIC MFG. CO., LTD., KIRYU-CITY, GUNMA-PREFECTURE, JAPAN:
1,480,742, CANC. INT. CL. 12.
- MITSUBISHI CHEMICAL COMPANY, TOKYO, JAPAN:
1,509,718, REN. 12-20-08. INT. CL. 1.
- MITSUBISHI HITEC PAPER FLENSBURG, GMBH, D-24941 FLENSBURG, FED REP GERMANY:
2,546,654, CANC. INT. CL. 16.
- MITSUMI CHEMICALS, INC., TOKYO, JAPAN:
3,568,141, INT. CL. 5.
- MITSUMI MINING & SMELTING CO., LTD., TOKYO, JAPAN:
2,144,799, CANC. INT. CL. 9.
- MITSUMI KOSHI (U.S.A.), INC., NEW YORK, NY:
3,566,532, PUB. 11-11-2008. INT. CL. 43.
- MITUTOYO CORPORATION, TAKATSU-KU, KAWASAKI, KANAGAWA, JAPAN:
2,235,151, REN. 12-22-08. INT. CL. 9.
- MIXED SIGNALS TECHNOLOGIES, INC., CULVER CITY, CA:
2,548,568, CANC. INT. CL. 9.

- MIZUNO USA, INC., NORCROSS, GA:
2,546,346, CANC. INT. CL. 28.
- MÉTIER, LTD., ARLINGTON, VA:
3,567,256, PUB. 11-11-2008. INT. CL. 9.
- MOBEX COMMUNICATIONS, INC., LAFAYETTE, CA:
2,545,579, CANC. MULTIPLE CLASS, INT. CLS. 35, 37 AND 38.
- MOBILE SNIPS PTY LTD., EVATT, ACT 2617, AUSTRALIA:
2,546,351, CANC. INT. CL. 42.
- MOBILE STUDIOS, INC., BOCA RATON, FL:
3,567,273, PUB. 11-11-2008. INT. CL. 9.
- MOBIMANAGE, LLC, TULSA, OK:
3,566,935, PUB. 11-11-2008. MULTIPLE CLASS, INT. CLS. 9 AND 42.
- MODASOLUTIONS CORPORATION, KANATA, ONTARIO, CANADA:
3,566,743, PUB. 11-11-2008. INT. CL. 35.
- MODELS PREFER, LTD., OXFORD, CT:
2,548,480, CANC. INT. CL. 3.
- MODERN ACCESS SYSTEMS INC., GUELPH, ONTARIO, CANADA:
3,566,264, PUB. 11-11-2008. MULTIPLE CLASS, INT. CLS. 9, 37, 40 AND 42.
- MODMODE, INC., ORMOND BEACH, FL:
2,203,453, REN. 12-20-08. INT. CL. 3.
- MODULAR SECURITY SYSTEMS, INC., IRONTON, OH:
3,567,102, PUB. 11-11-2008. INT. CL. 9.
- MOEN INCORPORATED, ELYRIA, OH:
1,480,719, CANC. INT. CL. 11.
- MOHAMMAD-BAGHERZADEH, NARGES, MONTREAL, CANADA:
3,566,477, PUB. 9-9-2008. MULTIPLE CLASS, INT. CLS. 30 AND 35.
- MOHAWK BRANDS, INC., WILMINGTON, DE:
2,220,313, REN. 12-20-08. INT. CL. 27.
2,220,731, REN. 12-20-08. INT. CL. 27.
- MOHAWK CARPET CORPORATION, CALHOUN, GA:
2,548,327, CANC. INT. CL. 27.
- MOHAWK EUROPA LTD., COUNTY CLARE, IRELAND:
2,546,310, CANC. INT. CL. 7.
- MOLE-RICHARDSON COMPANY, HOLLYWOOD, CA:
2,548,582, CANC. INT. CL. 35.
- MOLECULAR BIOLOGY RESOURCES INC., MILWAUKEE, WI:
3,566,465, PUB. 11-11-2008. MULTIPLE CLASS, INT. CLS. 1, 5 AND 42.
- MOLECULAR BIOLOGY RESOURCES, INC, MILWAUKEE, WI, DBA CHIMERX:
3,567,539, PUB. 11-11-2008. INT. CL. 1.
- MOLECULAR OPTOELECTRONICS CORPORATION, WATERVLIET, NY:
2,546,301, CANC. INT. CL. 9.
- MOLKEREI ALOIS MULLER GMBH & CO., 8935 ARETSRIED, FED REP GERMANY:
2,545,862, CANC. MULTIPLE CLASS, INT. CLS. 29 AND 30.
- MOLL CONSULTING, INC., SAN DIEGO, CA:
2,546,350, CANC. INT. CL. 35.
- MOLNLYCKE AB, S-405 03 GOTEBOG, SWEDEN:
1,480,772, CANC. MULTIPLE CLASS, INT. CLS. 16 AND 21.
- MONA LISA DEVELOPMENT, LLC, CELEBRATION, FL:
3,566,717, PUB. 11-11-2008. MULTIPLE CLASS, INT. CLS. 36 AND 43.
- MONARCH CONSULTING, INC., THOUSAND OAKS, CA:
2,547,604, CANC. INT. CL. 41.
- MONDOFIX, INC., MONTREAL, QUEBEC:
2,233,448, REN. 12-19-08. INT. CL. 37.
- MONFOX LLC, ALPHARETTA, GA:
3,567,266, PUB. 11-11-2008. INT. CL. 9.
- MONIKKER PTY LTD, MELBOURNE VIC 3000, AUSTRALIA:
3,567,815, PUB. 11-11-2008. MULTIPLE CLASS, INT. CLS. 9, 38 AND 41.
- MONNET GILLES, ST GERMAIN EN LAYE, FRANCE:
3,567,801, PUB. 11-11-2008. INT. CL. 28.
- MONSTER (CALIFORNIA), INC., LOS ANGELES, CA:
3,567,457, PUB. 11-11-2008. MULTIPLE CLASS, INT. CLS. 35 AND 41.
- MONSTER CABLE PRODUCTS, INC., BRISBANE, CA:
2,184,002, REN. 12-23-08. INT. CL. 9.
3,568,454, INT. CL. 9.
3,568,463, INT. CL. 9.
3,568,464, INT. CL. 9.
- MONTES Y CIA., S.A. DE C.V., PONCITLÁN, JALISCO, MEXICO:
3,567,145, PUB. 11-11-2008. INT. CL. 30.
- MONTRES CORUM SARL, 2300 LA CHAUX-DE-FONDS, SWITZERLAND:
2,546,446, CANC. INT. CL. 14.
- MOODTV PTY LTD, VENICE, CA:
3,566,948, PUB. 11-11-2008. INT. CL. 38.
- MOODY BIBLE INSTITUTE OF CHICAGO, CHICAGO, IL:
3,567,311, PUB. 11-11-2008. MULTIPLE CLASS, INT. CLS. 38 AND 41.
- MOORE INDUSTRIES-INTERNATIONAL, INC., SEPULVEDA, CA:
3,567,356, PUB. 11-11-2008. INT. CL. 9.
3,567,359, PUB. 11-11-2008. INT. CL. 9.
- MOORE, JOHN AUSTIN, BRANSON, MO AND MOORE, CRISTINA SUSANNA, BRANSON, MO:
3,566,289, PUB. 11-11-2008. INT. CL. 43.
- MOORTON, PATRICK J., NAPLES, FL AND STECKER, CARL M., GREENVILLE, SC:
1,517,239, REN. 12-19-08. INT. CL. 25.
- MORELAW, INC., TULSA, OK:
2,545,601, CANC. MULTIPLE CLASS, INT. CLS. 35 AND 42.
- MORELX GMBH, 50668 KÖLN, FED REP GERMANY:
3,567,824, PUB. 11-11-2008. MULTIPLE CLASS, INT. CLS. 35, 36, 38, 39, 41, 43 AND 45.
- MORGAN CHANEY LLC, PHOENIX, AZ:
3,566,680, PUB. 11-11-2008. INT. CL. 35.
- MORGAN STANLEY DEAN WITTER & CO., NEW YORK, NY:
2,547,669, CANC. INT. CL. 36.
2,548,490, CANC. INT. CL. 36.
- MORRIS BOOK PUBLISHING, LLC, AUGUSTA, GA:
3,567,204, PUB. 11-11-2008. INT. CL. 16.
3,567,689, PUB. 11-11-2008. INT. CL. 16.
- MORRIS COMMUNICATIONS CORPORATION, AUGUSTA, GA:
2,545,966, CANC. MULTIPLE CLASS, INT. CLS. 16 AND 42.
- MORRIS, CHRISTIAN C., PHOENIX, AZ:
2,546,073, CANC. MULTIPLE CLASS, INT. CLS. 35 AND 37.
- MORT CRIM COMMUNICATIONS INCORPORATED, SOUTHFIELD, MI:
2,547,122, CANC. INT. CL. 41.
- MORTGAGE GUARANTY INSURANCE CORPORATION, MILWAUKEE, WI:
2,548,590, CANC. INT. CL. 36.
- MORTGAGES LTD., PHOENIX, AZ:
2,546,273, CANC. INT. CL. 36.
- MOSS, MARISSA, BERKELEY, CA:
2,547,976, CANC. INT. CL. 9.
- MOSTOLES INDUSTRIAL, S.A., 28935 MOSTOLES, MADRID, SPAIN:
2,577,805, CANC. INT. CL. 20.
- MOTO TASSINARI, INC., LEBANON, NH:
2,213,914, REN. 12-22-08. INT. CL. 7.
- MOTOROLA, INC., SCHAUMBURG, IL:
2,204,950, REN. 12-19-08. MULTIPLE CLASS, INT. CLS. 9, 11, 14, 16, 18, 20, 21, 24 AND 25.
2,204,950, CANC. MULTIPLE CLASS, INT. CLS. 6, 8, 26 AND 28.
- MP GLOBAL PRODUCTS, LLC, NORFOLK, NE:
3,568,509, INT. CL. 17.
- MRS. GOOCH'S NATURAL FOOD MARKETS, INC., AUSTIN, TX:
1,480,415, CANC. MULTIPLE CLASS, INT. CLS. 5, 16, 25, 29, 30, 31 AND 32.
- MRS. GROSSMAN'S PAPER COMPANY, PETALUMA, CA:
2,546,677, CANC. INT. CL. 16.

MTS EUROPE GMBH, KONSTANZ, FED REP GERMANY:
3,568,730, INT. CL. 10.

MUELHENS GMBH & CO. KG, 50828 KOLN, FED REP GERMANY:
2,546,298, CANC. INT. CL. 3.

MUELLER, DON R., MONMOUTH JUNCTION, NJ:
2,547,501, CANC. INT. CL. 21.

MULLER INTERNATIONAL, INC., ATLANTA, GA:
1,490,849, REN. 12-24-08. INT. CL. 9.

MULLER, JANET EILEEN, PALM DESERT, CA:
2,545,832, CANC. INT. CL. 16.

MULTI MEDIA EXPOSURE, INC., BERNARDSVILLE, NJ:
3,568,559, INT. CL. 14.

MULTIENLACE S.A., MEDELLÍN, COLOMBIA:
3,568,662, INT. CL. 35.
3,568,663, MULTIPLE CLASS, INT. CLS. 35 AND 38.

MULTINATIONAL ASSOCIATION OF SUPPORTIVE CARE IN CANCER, NEW ORLEANS, LA:
3,566,882, PUB. 11-11-2008. INT. CL. 41.

MUNICIPALTRADE.COM, INC., ATLANTA, GA:
2,546,717, CANC. INT. CL. 36.

MURATA POWER SOLUTIONS, INC., MANSFIELD, MA:
2,545,689, CANC. INT. CL. 42.

MUSCULAR DYSTROPHY ASSOCIATION, INC., TUCSON, AZ:
1,517,455, REN. 12-24-08. INT. CL. 36.

MUSE IMPORTS LTD., NEW YORK, NY:
3,567,263, PUB. 11-11-2008. INT. CL. 14.

MUSEUM OF THE AMERICAN COCKTAIL, INC., WASHINGTON, DC:
3,566,924, PUB. 11-11-2008. INT. CL. 41.

MUSIC ENGINEERING AND TECHNOLOGY ALLIANCE, LLC, NASHVILLE, TN:
3,567,286, PUB. 11-11-2008. MULTIPLE CLASS, INT. CLS. 35 AND 42.

MVP RV, INC., MORENO VALLEY, CA:
3,568,125, INT. CL. 12.

MY SMART HOME, INC., DUNEDIN, FL:
3,566,863, PUB. 11-11-2008. INT. CL. 9.

MYCORPORATION BUSINESS SERVICES, INC., AGOURA HILLS, CA, DBA MYCORPORATION.COM:
2,546,308, CANC. INT. CL. 42.

MYHEALTH LLC, NORTH LOGAN, UT:
2,547,813, CANC. MULTIPLE CLASS, INT. CLS. 9 AND 16.

MYKNOBS.COM, INC., ASTORIA, NY:
3,566,296, PUB. 11-11-2008. INT. CL. 35.

MYLLC.COM, INC., LAS VEGAS, NV:
3,566,410, PUB. 11-11-2008. INT. CL. 35.

MYLNEK, DONALD A., OCEANSIDE, CA:
3,568,726, INT. CL. 10.

MYMAIL, LTD., DENTON, TX:
3,567,100, PUB. 11-11-2008. INT. CL. 42.

MYMENU CANADA INC., KITCHENER, ONTARIO, CANADA:
3,568,251, MULTIPLE CLASS, INT. CLS. 29, 30 AND 35.

MYROLD, JOELLE, MADISON, WI:
2,546,877, CANC. INT. CL. 14.

MYSOBERLIFE, LLC, BELLEVUE, WA:
3,566,781, PUB. 11-11-2008. INT. CL. 38.

MYSWINGONLINE LLC, HUNTERSVILLE, NC:
3,567,619, PUB. 11-11-2008. INT. CL. 41.

MYVESTA FOUNDATION, HOUSTON, TX:
2,545,736, CANC. INT. CL. 41.

MZE MASCHINENBAU GMBH & CO. KG, KELKHEIM, FED REP GERMANY:
3,566,588, PUB. 11-11-2008. INT. CL. 7.

N B I, INC., BOULDER, CO:
1,480,568, CANC. INT. CL. 9.

N.V. NEDERLANDSCHE; APPARATENFABRIEK NEDAP, NETHERLANDS:
3,567,964, PUB. 11-11-2008. INT. CL. 9.

N.Y.D.F., INC., NEW YORK, NY:
2,547,307, CANC. INT. CL. 25.

NABISCO BRANDS COMPANY, WILMINGTON, DE:
2,548,521, CANC. INT. CL. 28.

NAFTULIN, JUDITH M., NEW HOPE, PA:
2,548,227, CANC. INT. CL. 39.

NAIL SOUP MEDIA, LLC, WILMINGTON, DE:
3,568,128, MULTIPLE CLASS, INT. CLS. 35 AND 36.

NAKAMICHI CORPORATION, TOKYO, JAPAN:
1,480,520, CANC. INT. CL. 9.

NAKED JUICE CO. OF GLENDORA, INC., AZUSA, CA:
2,291,885, REN. 12-19-08. INT. CL. 32.

NAKED TAN, INC., TAMPA, FL:
2,548,218, CANC. MULTIPLE CLASS, INT. CLS. 3 AND 25.

NALCO COMPANY, NAPERVILLE, IL:
1,512,254, REN. 12-24-08. INT. CL. 1.
3,566,888, PUB. 11-11-2008. INT. CL. 1.

NAMESTYLES, INCORPORATED, BENICIA, CA:
2,547,422, CANC. INT. CL. 38.

NANCY E. RESNICK, D.O., P.C., LIVONIA, MI:
2,546,207, CANC. INT. CL. 42.

NANNY CADDY LLC, GOLD CANYON, AZ:
3,567,553, PUB. 11-11-2008. INT. CL. 9.

NANOGEN, INC., SAN DIEGO, CA:
2,547,605, CANC. INT. CL. 5.

NANOMETRICS INCORPORATED, MILPITAS, CA:
2,547,144, CANC. INT. CL. 9.

NANOREPRO GMBH, FED REP GERMANY:
3,567,843, PUB. 11-11-2008. MULTIPLE CLASS, INT. CLS. 5 AND 42.

NANPING YANFA BAMBOO & WOODEN; PRODUCTS LTD, NANPING, FUJIAN 353000, CHINA:
3,567,817, PUB. 11-11-2008. INT. CL. 19.

NARA MACHINERY CO., LTD., JAPAN:
3,567,825, PUB. 11-11-2008. INT. CL. 11.

NARDI'S (LLC), COLUMBIA, MD:
2,547,679, CANC. INT. CL. 42.

NARDY, JUSTIN, COLUMBIA, MO:
3,566,973, PUB. 11-11-2008. MULTIPLE CLASS, INT. CLS. 9 AND 41.

NASARE ENTERPRISES, LLC., NEW YORK, NY:
3,568,063, INT. CL. 25.

NASHVILLE WIRE PRODUCTS MANUFACTURING COMPANY, NASHVILLE, TN:
2,547,586, CANC. INT. CL. 6.

NATE B, LLC, SKOKIE, IL:
3,567,379, PUB. 11-11-2008. INT. CL. 3.

NATIONAL ACADEMY OF RECORDING ARTS & SCIENCES, INC., SANTA MONICA, CA:
3,568,414, INT. CL. 41.

NATIONAL ASSOCIATION FOR STOCK CAR AUTO RACING, INC., DAYTONA BEACH, FL:
3,568,436, INT. CL. 41.

NATIONAL ASSOCIATION OF REAL ESTATE INVESTMENT TRUSTS, WASHINGTON, DC:
2,546,304, CANC. INT. CL. 16.

NATIONAL AUTOMATED CLEARING HOUSE ASSOCIATION, HERNDON, VA:
3,567,708, PUB. 11-11-2008. INT. CL. 36.

NATIONAL BOARD FOR PROFESSIONAL TEACHING STANDARDS, INC., SOUTHFIELD, MI:
2,546,811, CANC. INT. CL. 16.

NATIONAL BOARD OF SURGICAL TECHNOLOGY AND SURGICAL ASSISTING, LITTLETON, CO:
2,217,122, REN. 12-19-08. U.S. CL. B.

NATIONAL CENTER FOR MISSING & EXPLOITED CHILDREN, ALEXANDRIA, VA:
2,202,638, REN. 12-23-08. INT. CL. 42.

NATIONAL CONSUMER COOPERATIVE BANK, WASHINGTON, DC, DBA NATIONAL COOPERATIVE BANK:
2,227,709, REN. 12-19-08. INT. CL. 16.

NATIONAL COUNCIL OF STATE BOARDS OF NURSING, INC., CHICAGO, IL:
2,143,783, CANC. INT. CL. 9.

NATIONAL CUTTING HORSE ASSOCIATION, FORT WORTH, TX:
3,484,442, COR. MULTIPLE CLASS, INT. CLS. 16, 35 AND 41.

3,487,996, COR. INT. CL. 41.

NATIONAL EDUCATIONAL SERVICE, BLOOMINGTON, IN:
2,144,729, CANC. MULTIPLE CLASS, INT. CLS. 16 AND

41.
NATIONAL ENVELOPE CORPORATION, UNIONDALE, NY:
2,236,851. REN. 12-19-08. INT. CL. 16.
- NATIONAL FOUNDATION QUARTER HORSE ASSOCIATION, INC., ENTERPRISE, OR:
2,547,335. CANC. INT. CL. 42.
- NATIONAL GEOGRAPHIC SOCIETY, WASHINGTON, DC:
2,547,127. CANC. INT. CL. 16.
2,672,456. CANC. MULTIPLE CLASS, INT. CLS. 9 AND 16.
2,672,518. CANC. MULTIPLE CLASS, INT. CLS. 9 AND 16.
- NATIONAL HEALTH COUNCIL, WASHINGTON, DC:
2,206,585. REN. 12-19-08. MULTIPLE CLASS, INT. CLS. 16 AND 41.
- NATIONAL HEALTH PARTNERS, INC., HORSHAM, PA:
3,568,405. INT. CL. 35.
- NATIONAL HEALTH SYSTEMS, INC., FORT WORTH, TX:
2,211,774. REN. 12-22-08. INT. CL. 42.
- NATIONAL HEARING CENTERS, INC., PLYMOUTH, MN:
3,568,044. INT. CL. 35.
- NATIONAL INDUSTRIES FOR THE BLIND, ALEXANDRIA, VA:
2,296,130. REN. 12-20-08. INT. CL. 8.
2,296,131. REN. 12-20-08. INT. CL. 5.
- NATIONAL INFORMATION CORPORATION, SPRING HILL, FL:
2,545,909. CANC. MULTIPLE CLASS, INT. CLS. 16, 35 AND 41.
- NATIONAL INSURANCE PRODUCER REGISTRY, KANSAS CITY, MO:
2,546,305. CANC. INT. CL. 36.
- NATIONAL LEAGUE OF JUNIOR COTILLIONS, CHARLOTTE, NC:
2,103,172. REN. 12-20-08. INT. CL. 41.
- NATIONAL LIFE INSURANCE COMPANY, MONTPELIER, VT:
2,546,737. CANC. INT. CL. 36.
- NATIONAL METAL FABRICATORS, ELK GROVE VILLAGE, IL:
1,480,567. CANC. INT. CL. 9.
- NATIONAL MULTIPLE SCLEROSIS SOCIETY, NEW YORK, NY:
2,144,062. CANC. INT. CL. 36.
- NATIONAL NUDIST COUNCIL OF THE AMERICAS, FITZ-WILLIAM, NH:
2,546,634. CANC. INT. CL. 42.
- NATIONAL OAK FLOORING MANUFACTURERS ASSOCIATION, MEMPHIS, TN:
362,428. REN. 12-22-08. U.S. CL. 12 (INT. CL. 19).
- NATIONAL PRACTICE INSTITUTE, INC., MINNEAPOLIS, MN:
2,546,416. CANC. INT. CL. 41.
- NATIONAL REAL ESTATE SERVICE, INC., SOUTHGATE, MI, GALLERY OF HOMES, INC., ORLANDO, FL:
1,488,805. REN. 12-23-08. INT. CL. 36.
- NATIONAL RESTAURANT ASSOCIATION EDUCATIONAL FOUNDATION, THE, CHICAGO, IL:
2,214,434. REN. 12-20-08. MULTIPLE CLASS, INT. CLS. 9 AND 16.
- NATIONAL RURAL ELECTRIC COOPERATIVE ASSOCIATION, ARLINGTON, VA:
3,568,771. INT. CL. 9.
- NATIONAL SKI PATROL SYSTEM, INC., DENVER, CO:
861,188. REN. 12-20-08. U.S. CL. 200.
- NATIONAL SOCIETY OF PROFESSIONAL ENGINEERS, ALEXANDRIA, VA:
3,566,821. PUB. 11-11-2008. INT. CL. 35.
3,566,822. PUB. 11-11-2008. INT. CL. 35.
- NATIONAL TAXIDERMISTS ASSOCIATION, SLIDELL, LA:
2,545,886. CANC. U.S. CL. B.
- NATIONWIDE CHILDREN'S HOSPITAL, COLUMBUS, OH:
2,546,538. CANC. INT. CL. 42.
- NATIONWIDE PRIVATE INVESTIGATIONS, SAN ANTONIO, TX:
2,546,573. CANC. INT. CL. 42.
- NATURAL BIO-ACTIVE PRODUCTS LLC, NEWPORT BEACH, CA:
3,567,389. PUB. 11-11-2008. U.S. CL. A.
- NATURAL BUSINESS COMMUNICATIONS, L.L.C., BOULDER, CO:
2,546,212. CANC. MULTIPLE CLASS, INT. CLS. 16 AND 41.
- NATURAL MARKETING INSTITUTE, HARLEYSVILLE, PA:
3,566,721. PUB. 11-11-2008. INT. CL. 35.
3,566,722. PUB. 11-11-2008. INT. CL. 35.
- NATURAL MATTERS INC., SEATTLE, WA:
2,545,873. CANC. INT. CL. 30.
- NATURALLY RAW LLC, LAKE MILLS, WI:
3,566,383. PUB. 7-17-2007. INT. CL. 31.
- NATURE TECHNOLOGIES, PLEASANTVILLE, NY:
3,567,229. PUB. 11-11-2008. INT. CL. 37.
- NATUS MEDICAL INCORPORATED, SAN CARLOS, CA:
3,567,620. PUB. 11-11-2008. INT. CL. 10.
- NAU, TODD, BROOKLYN, NY AND MEREDITH, LEDA, BROOKLYN, NY, DBA THEIA BATH PRODUCTS:
2,545,714. CANC. INT. CL. 3.
- NAVAS, MAURICIO, BUCARAMANGA, COLOMBIA:
3,566,439. PUB. 11-11-2008. INT. CL. 9.
- NAVIGON AG, FED REP GERMANY:
3,567,941. PUB. 11-11-2008. MULTIPLE CLASS, INT. CLS. 9, 12, 35, 38, 39 AND 42.
- NCMIC GROUP, INC., WEST DES MOINES, IA:
2,546,794. CANC. INT. CL. 36.
- NCS HEALTHCARE, LLC, COVINGTON, KY:
2,546,316. CANC. INT. CL. 42.
- NEAR & FAR, L.L.C., DALLAS, TX:
2,546,875. CANC. INT. CL. 35.
- NEBRASKA BEEF, LTD., OMAHA, NE:
2,546,665. CANC. INT. CL. 40.
- NEC USA, INC., MELVILLE, NY:
2,546,198. CANC. INT. CL. 9.
- NECKTOP COMPUTING, INC., WESTERVILLE, OH:
2,548,396. CANC. INT. CL. 35.
- NEGOTIATION STRATEGIES, LLC, DES MOINES, IA:
2,546,380. CANC. INT. CL. 41.
2,546,381. CANC. INT. CL. 41.
2,546,384. CANC. INT. CL. 41.
- NEGRETE, RICHARD, EL SEGUNDO, CA:
3,568,649. INT. CL. 28.
- NEIGHBOR TO NEIGHBOR, INC., VENICE, CA:
3,567,606. PUB. 11-11-2008. INT. CL. 35.
- NELSON PRODUCTS, INC., ATLANTA, GA:
2,547,769. CANC. INT. CL. 1.
- NEMCOVA, PETRA, NEW YORK, NY:
3,567,361. PUB. 11-11-2008. MULTIPLE CLASS, INT. CLS. 35 AND 41.
- NEMIROFF INTELLECTUAL PROPERTY ESTABLISHMENT, LIECHTENSTEIN:
3,567,800. PUB. 11-11-2008. INT. CL. 33.
- NEMIROFF; INTELLECTUAL PROPERTY ESTABLISHMENT, LIECHTENSTEIN:
3,567,873. PUB. 11-11-2008. INT. CL. 33.
- NEO DENTAL CHEMICAL PRODUCTS CO., LTD, TOKYO 150, JAPAN:
2,203,094. REN. 12-23-08. INT. CL. 5.
- NEO-CONCEPT (HOLDINGS) CO. LTD, KWUNTONG, CHINA:
3,567,885. PUB. 11-11-2008. MULTIPLE CLASS, INT. CLS. 24, 25 AND 42.
- NEOPART, LLC, HONEY BROOK, PA:
3,568,540. INT. CL. 35.
- NEST NATURALS, INC., EMERYVILLE, CA:
3,568,562. INT. CL. 30.
- NETDEPOSIT, INC., SALT LAKE CITY, UT:
3,567,573. PUB. 11-11-2008. INT. CL. 36.
- NETIK PRODUCTS INC., NASSAU, BAHAMAS:
2,545,583. CANC. INT. CL. 9.
- NETLOGIC MICROSYSTEMS INC., MOUNTAIN VIEW, CA:
2,145,371. CANC. INT. CL. 9.
- NETOPIA, INC., EMERYVILLE, CA:
2,547,319. CANC. INT. CL. 9.

NETVIEW TECHNOLOGIES, INC., PHOENIX, AZ:
2,547,596, CANC. INT. CL. 9.

NETWORK COMMUNICATIONS, INC., LAWRENCEVILLE, GA:
2,546,673, CANC. INT. CL. 36.

NETWORK EQUIPMENT TECHNOLOGIES, INC., REDWOOD CITY, CA:
2,547,498, CANC. INT. CL. 9.

NETWORK FOUNDATION TECHNOLOGIES, LLC, CENTURY CITY, CA:
3,566,596, PUB. 11-11-2008. INT. CL. 38.

NEUTRON DYNAMIC SYSTEMS INC., CRESTON, BRITISH COLUMBIA, CANADA:
3,568,420, INT. CL. 9.

NEVAREZ, MICHAEL, BATTLE CREEK, MI:
3,568,201, INT. CL. 21.

NEW CENTURY SOLUTIONS INC., READING, PA:
2,546,363, CANC. INT. CL. 16.

NEW ENGLAND BRICKMASTER WINDOWS & EXTERIORS, INC., TEWKSBURY, MA:
3,566,846, PUB. 11-11-2008. INT. CL. 37.

NEW ENGLAND SERVICE SOURCE, INC., BEDFORD, NH:
2,547,792, CANC. MULTIPLE CLASS, INT. CLS. 35, 41 AND 42.

NEW GLARUS BREWING COMPANY, NEW GLARUS, WI:
3,566,380, PUB. 11-11-2008. INT. CL. 32.
3,566,447, PUB. 11-11-2008. MULTIPLE CLASS, INT. CLS. 25 AND 32.

NEW JERSEY BASKETBALL, LLC, EAST RUTHERFORD, NJ:
2,283,626, REN. 12-23-08. INT. CL. 18.

NEW LINE PRODUCTIONS, INC., NEW YORK, NY:
2,547,824, CANC. INT. CL. 16.

NEW MEDIA TECHNOLOGY CORPORATION, NEW YORK, NY:
2,546,668, CANC. MULTIPLE CLASS, INT. CLS. 9 AND 42.

NEW PRODUCTS INC., PORTLAND, OR:
2,548,197, CANC. INT. CL. 8.

NEW WORLD PASTA COMPANY, HARRISBURG, PA, SKINNER MANUFACTURING COMPANY, OMAHA, NE:
670,993, REN. 12-22-08. U.S. CL. 46 (INT. CL. 30).

NEW YORK CITY BALLET, INC., NEW YORK, NY:
3,568,743, INT. CL. 16.

NEWELL IMPORT CORP., S. EL MONTE, CA:
3,567,354, PUB. 11-11-2008. INT. CL. 21.

NEWFRESHCO FOODS, LLC, NAPERVILLE, IL:
3,567,323, PUB. 11-11-2008. INT. CL. 30.

NEWPAGE WISCONSIN SYSTEMS INC., MIAMISBURG, OH:
2,548,531, CANC. INT. CL. 16.

NEWSGATOR TECHNOLOGIES, INC., DENVER, CO:
3,567,744, PUB. 11-11-2008. INT. CL. 42.

NEXPAK CORPORATION, DULUTH, GA:
3,567,648, PUB. 11-11-2008. INT. CL. 9.

NEXT PHASE SOLUTIONS, LLC, PHOENIX, AZ:
3,568,105, INT. CL. 29.

NEXTERNA LIMITED, BURLINGTON, ONTARIO, CANADA:
2,545,764, CANC. INT. CL. 9.

NEXTHMARK, INC., HANOVER, NH:
3,567,416, PUB. 11-11-2008. INT. CL. 35.

NEXTMED SYSTEMS, INC., CLEVELAND, OH:
2,548,570, CANC. INT. CL. 35.

NEXTSET SOFTWARE, INC., PALO ALTO, CA:
2,546,323, CANC. INT. CL. 9.

NEXUS ENERGY SOFTWARE, INC., WELLESLEY, MA:
2,546,063, CANC. INT. CL. 9.

NEXWAVE SOLUTIONS, SOCIETE ANONYME, MONTPELLIER, FRANCE:
3,280,262, CANC. MULTIPLE CLASS, INT. CLS. 9 AND 42.

NGEN MANAGEMENT, L.L.C., SANTA BARBARA, CA:
3,566,261, PUB. 11-11-2008. INT. CL. 36.

NIAGARA CONSERVATION CORPORATION, CEDAR KNOLLS, NJ:
3,566,345, PUB. 11-11-2008. INT. CL. 9.

NICK STAFFORD AND SALLY STAFFORD, NORTH YORKSHIRE, UNITED KINGDOM, TA HAMBLETON ALES:
3,568,038, INT. CL. 32.

NICKEL & NICKEL VINEYARDS, LLC, OAKVILLE, CA:
3,567,111, PUB. 11-11-2008. INT. CL. 33.

NICKEL, KEVIN, ORANGE, CA:
2,547,917, CANC. INT. CL. 37.

NIL-COR, LLC, KENTWOOD, MI:
2,547,945, CANC. INT. CL. 7.

NINE WEST DEVELOPMENT CORP, WILMINGTON, DE:
2,626,723, AM. INT. CL. 14.

NINGBO YINGQI; ELECTRICAL INDUSTRY CO., LTD., CHINA:
3,567,938, PUB. 11-11-2008. INT. CL. 11.

NINJAI GANG, LLC, KALIUA, HI:
2,547,546, CANC. INT. CL. 41.
2,547,547, CANC. INT. CL. 41.

NINTENDO OF AMERICA INC., REDMOND, WA:
2,548,363, CANC. INT. CL. 16.

NITREX METAL INC., ST. LAURENT, QUEBEC:
2,547,590, CANC. INT. CL. 40.

NITTO DENKO CORPORATION, IBARAKI-SHI, OSAKA, JAPAN:
3,568,084, INT. CL. 9.

NIVIN INC, BROOKFIELD, WI:
2,545,940, CANC. INT. CL. 40.

NM NEVADA TRUST, LAS VEGAS, NV:
2,209,260, REN. 12-22-08. INT. CL. 36.

NMG, INC., DALLAS, TX:
2,546,806, CANC. INT. CL. 9.

NO NAME, INC., ALDAN, PA:
2,547,803, CANC. INT. CL. 35.

NO TOUCH NORTH AMERICA, LAKE FOREST, CA:
2,548,292, CANC. INT. CL. 3.
2,548,293, CANC. INT. CL. 3.

NOBEL LEARNING COMMUNITIES INC., WEST CHESTER, PA:
1,481,106, CANC. INT. CL. 41.

NOBIS, INC., MARKHAM, CANADA:
3,568,267, INT. CL. 25.

NOBLE APPAREL, INC., LOS ANGELES, CA:
2,217,297, REN. 12-20-08. INT. CL. 25.

NOBLESTAR, INCORPORATED, ALGONQUIN, IL, DBA INTEGRATED SUPPLEMENTS:
3,566,656, PUB. 11-11-2008. INT. CL. 5.

NOCK, MARGARET, UPPER SAINT CLAIR, PA:
3,567,247, PUB. 11-11-2008. INT. CL. 18.

NOIR KENNEDY, FRANCE AND NOIR KENNEDY, FRANCE:
3,567,886, PUB. 11-11-2008. INT. CL. 25.

NONNI'S FOOD COMPANY, INC., TULSA, OK:
3,568,153, INT. CL. 30.

NORCROSS SAFETY PRODUCTS L.L.C., ROCK ISLAND, IL:
2,284,072, REN. 12-20-08. INT. CL. 25.

NORDITUBE TECHNOLOGIES SE, BELGIUM:
3,567,915, PUB. 11-11-2008. MULTIPLE CLASS, INT. CLS. 17, 35 AND 37.

NORDSTROM'S AUTOMOTIVE, INC., GARRETSON, SD:
3,567,617, PUB. 11-11-2008. INT. CL. 39.

NORMAN R. WOLFORD SCHOOL OF NURSE ANESTHESIA, INC., NAPLES, FL:
2,548,135, CANC. INT. CL. 41.

NORMAN SECURITY SYSTEMS, INC., CHICAGO, IL:
1,481,176, CANC. INT. CL. 42.

NORMARK CORPORATION, MINNETONKA, MN:
2,548,407, CANC. INT. CL. 8.

NORSTAN NETWORK SERVICES, INC., MAPLE GROVE, MN:
2,143,801, CANC. INT. CL. 38.

NORTH SHORE ANIMAL LEAGUE AMERICA, INC., PORT WASHINGTON, NY:
3,566,647, PUB. 11-11-2008. MULTIPLE CLASS, INT. CLS. 36 AND 45.

NORTHCOAST HOLDING CO., DOVER, DE:
2,144,742, CANC. INT. CL. 30.

- NORTHEAST IOWA TELEPHONE COMPANY, MONONA, IA:
3,568,635, INT. CL. 38.
- NORTHEAST SUSTAINABLE ENERGY ASSOCIATION, INC., GREENFIELD, MA, DBA NESEA:
3,567,570, PUB. 11-11-2008. INT. CL. 41.
- NORTHERN DIGITAL INC., WATERLOO, ONTARIO, CANADA:
1,549,853, REN. 12-23-08. INT. CL. 9.
- NORTHLAND INSURANCE COMPANY, ST. PAUL, MN:
3,568,450, INT. CL. 36.
- NORTHPOINT TRADING, INC., NEW YORK, NY:
3,567,055, PUB. 11-11-2008. INT. CL. 24.
- NORTHWEST AIRLINES, INC., ST. PAUL, MN:
1,559,278, REN. 12-20-08. INT. CL. 39.
2,545,539, CANC. INT. CL. 39.
- NORTHWEST AREA FOUNDATION, SAINT PAUL, MN:
3,566,474, PUB. 11-11-2008. INT. CL. 35.
- NORTHWESTERN UNIVERSITY, EVANSTON, IL:
2,546,936, CANC. INT. CL. 41.
- NOTTS SPORT LIMITED, OADBY, LEICESTERSHIRE, UNITED KINGDOM, NOTTINGHAMSHIRE COUNTY COUNCIL, WEST BRIDGFORD, NOTTINGHAM, ENGLAND:
1,518,006, REN. 12-22-08. INT. CL. 19.
- NOVARTIS AG, CH-4002 BASEL, SWITZERLAND:
2,548,160, CANC. INT. CL. 9.
- NOVIN, SALADIN, FRANKLIN, TN:
3,567,078, PUB. 11-11-2008. INT. CL. 35.
- NOVITA CO., LTD., CHUNGCHEONGNAM-DO, REPUBLIC OF KOREA:
3,568,467, INT. CL. 11.
- NOVOZYMES A/S, BAGSVAERD 2880, DENMARK:
2,202,923, REN. 12-24-08. INT. CL. 1.
- NOW INTERACTIVE CORP., STATEN ISLAND, NY:
2,545,653, CANC. INT. CL. 35.
- NSB RETAIL SOLUTIONS, INC., POINTE, QUEBEC:
2,545,926, CANC. MULTIPLE CLASS, INT. CLS. 9, 16, 41 AND 42.
- NSS MUSIC, INC., NEW YORK, NY:
3,568,237, INT. CL. 41.
- NUBAR, LLC, LOS ANGELES, CA:
2,547,420, CANC. INT. CL. 3.
- NUBOTANIC INTERNATIONAL, INC., LOS ANGELES, CA:
2,145,542, CANC. MULTIPLE CLASS, INT. CLS. 3 AND 5.
- NUEVO ENERGY COMPANY, HOUSTON, TX:
2,547,989, CANC. INT. CL. 42.
- NUTRABELLA, LLC, SAN MATEO, CA:
3,568,601, INT. CL. 5.
- NUTRACEA, PHOENIX, AZ, AKA NUTRACEA, INC.:
2,546,546, CANC. INT. CL. 3.
- NUTRICIA INTERNATIONAL B.V., 2712 PB ZOETERMEER, NETHERLANDS:
2,546,646, CANC. INT. CL. 5.
- NUTRIMATE, 78160 MARLY-LE-ROI, FRANCE:
2,144,882, CANC. INT. CL. 9.
- NUTRITION RETAIL COMPANY, INC., ATLANTA, GA:
2,547,085, CANC. INT. CL. 35.
- NUVEX INGREDIENTS INC., BLUE EARTH, MN:
2,546,866, CANC. INT. CL. 40.
- NV BISCUITS DELACRE SA, B-17002, BELGIUM:
3,568,488, INT. CL. 30.
- NXP B.V., NETHERLANDS:
3,567,823, PUB. 11-11-2008. INT. CL. 9.
- O'REILLY MEDIA, INC., SEBASTOPOL, CA:
2,209,120, REN. 12-22-08. INT. CL. 42.
3,568,529, INT. CL. 35.
- OBCHTCHESTVO S OGRANITCHENNOI; OTVETSTVEN-NOSTIOU; "SIBIRSKOE ZDOROVIE K", RUSSIAN FED.:
3,567,948, PUB. 11-11-2008. INT. CL. 3.
- OBERTO SAUSAGE COMPANY OF OREGON, KENT, WA, BEATRICE FOODS CO., DENVER, CO, DBA LOWREY'S FRESHIES:
1,091,503, REN. 12-22-08. INT. CL. 29.
- OBJECTIVE INSIGHTS, INC., GRASS VALLEY, CA:
2,233,100, REN. 12-20-08. INT. CL. 35.
- OBJECTIVE SYSTEMS INTEGRATORS, INC., FOLSOM, CA:
2,546,635, CANC. INT. CL. 42.
- OBJECTSOFT, INC., CHICAGO, IL:
2,548,336, CANC. MULTIPLE CLASS, INT. CLS. 9 AND 42.
- OC TUTOR, SANTA ANA, CA:
3,568,789, INT. CL. 41.
- OCEAN REEF CLUB INC., KEY LARGO, FL:
3,566,932, PUB. 11-11-2008. INT. CL. 43.
3,566,933, PUB. 11-11-2008. INT. CL. 44.
3,566,959, PUB. 11-11-2008. U.S. CL. 200.
3,566,965, PUB. 11-11-2008. INT. CL. 44.
- OCEANSTYLE YACHTING LIMITED, UNITED KINGDOM:
3,567,887, PUB. 11-11-2008. MULTIPLE CLASS, INT. CLS. 12, 35, 36 AND 39.
- OCÉ DOCUMENT TECHNOLOGIES GMBH, 78467 KONSTANZ, FED REP GERMANY:
3,567,822, PUB. 11-11-2008. INT. CL. 9.
- OCTAVIO VELASQUEZ, JOSE, DORAL, FL:
3,566,606, PUB. 11-11-2008. INT. CL. 43.
- OCTOBERKAT INC., LOS ANGELES, CA:
2,546,292, CANC. INT. CL. 39.
- OCTOPUS, 13797 AIX EN PROVENCE, FRANCE:
2,545,553, CANC. MULTIPLE CLASS, INT. CLS. 9, 41 AND 42.
- ODEGARD, INC., NEW YORK, NY:
2,197,816, REN. 12-20-08. INT. CL. 27.
2,197,817, REN. 12-20-08. INT. CL. 27.
2,197,818, REN. 12-20-08. INT. CL. 27.
2,197,819, REN. 12-20-08. INT. CL. 27.
- ODESA GELISTIRILMIS POLIMER; YATIRIMLARI VE DIS TICARET A.S., TURKEY:
3,567,835, PUB. 11-11-2008. MULTIPLE CLASS, INT. CLS. 17, 19, 20 AND 35.
- OFFICE OF THE PRESIDING BISHOP OF THE TEMPLE OF HEALTH AND ECSTASY AFTER THE ORDER OF MELCHIZEDEK, THE, BEVERLY HILLS, CA:
2,144,664, CANC. INT. CL. 5.
- OFFICINE SORDINA S.P.A., I-36015 SCHIO, VICENZA, ITALY:
2,545,819, CANC. MULTIPLE CLASS, INT. CLS. 10 AND 11.
- OH KRUSE PERFECTION, LLC, ONTARIO, CA, O. H. KRUSE GRAIN & MILLING COMPANY, EL MONTE, CA:
1,109,593, REN. 12-20-08. INT. CL. 31.
- OHIO MUTUAL INSURANCE COMPANY, BUCYRUS, OH:
3,566,724, PUB. 11-11-2008. INT. CL. 36.
- OIKOS INTERNATIONAL LTD., 33 CANTON RD., KOWLOON, HONG KONG:
3,568,702, MULTIPLE CLASS, INT. CLS. 8 AND 21.
- OILTRASH.COM, INC., DENVER, CO:
2,545,846, CANC. MULTIPLE CLASS, INT. CLS. 35 AND 40.
- OJMAR, S.A., SPAIN:
3,567,969, PUB. 11-11-2008. INT. CL. 9.
- OKAMOTO MACHINE TOOL WORKS, LIMITED, YOKOHAMA, JAPAN:
1,480,467, CANC. MULTIPLE CLASS, INT. CLS. 7 AND 9.
- OLAF'S, INC., CENTER MORICHES, NY:
2,545,627, CANC. MULTIPLE CLASS, INT. CLS. 25 AND 28.
- OLD REPUBLIC INTERNATIONAL CORPORATION, CHICAGO, IL:
3,567,676, PUB. 11-11-2008. INT. CL. 36.
3,567,677, PUB. 11-11-2008. INT. CL. 36.
- OLD TOWN CANOE COMPANY, OLD TOWN, ME:
2,547,609, CANC. INT. CL. 12.
- OLDENBURG, LAURA J., PORTAGE, MI:
3,567,242, PUB. 11-11-2008. INT. CL. 35.
- OLIN ACQUISITION CORPORATION, BROOMFIELD, CO:
2,144,712, CANC. INT. CL. 9.
- OLIVE OIL IMPORTS, LLC, RED BANK, NJ:
3,568,307, MULTIPLE CLASS, INT. CLS. 29 AND 30.
3,568,308, MULTIPLE CLASS, INT. CLS. 3 AND 35.
- OLIVER, JASON NEWSON, BRIMINGHAM, AL:
2,546,173, CANC. MULTIPLE CLASS, INT. CLS. 40 AND 42.
- OLIVER, JON, BOSTON, MA:
2,546,404, CANC. MULTIPLE CLASS, INT. CLS. 16 AND

41.
2,546,405, CANC. MULTIPLE CLASS, INT. CLS. 16 AND 41.
- OLSON, PETER, PHILADELPHIA, PA:
2,547,522, CANC. INT. CL. 42.
- OLYMPUS AMERICA, INC., CENTER VALLEY, PA:
3,568,197, INT. CL. 10.
- OLYMPUS CORPORATION, WOODBURY, NY:
1,480,685, CANC. INT. CL. 9.
- OLYMPUS CORPORATION, TOKYO, JAPAN, OLYMPUS CORPORATION, WOODBURY, NY:
1,526,700, REN. 12-22-08. INT. CL. 10.
- OLYMPUS IMAGING CORP., TOKYO, JAPAN:
3,568,179, INT. CL. 9.
3,568,185, INT. CL. 9.
- OMAHASTEAKS.COM, INC., OMAHA, NE:
2,669,995, CANC. INT. CL. 35.
- OMNI CABLE CORPORATION, WEST CHESTER, PA:
3,567,110, PUB. 11-11-2008. INT. CL. 35.
- OMNIMEDIX INSTITUTE, PORTLAND, OR:
2,546,513, CANC. MULTIPLE CLASS, INT. CLS. 35 AND 42.
- OMNISCENT CORP., AVENTURA, FL:
3,567,578, PUB. 11-11-2008. INT. CL. 9.
- OMP INC., LONG BEACH, CA:
3,568,040, INT. CL. 3.
- OMRON LASERFRONT INC., KANAGAWA-KEN, JAPAN:
3,568,573, MULTIPLE CLASS, INT. CLS. 7, 9 AND 11.
- OMS INVESTMENTS, INC., LOS ANGELES, CA, CALIFORNIA SPRAY - CHEMICAL CORPORATION, WILMINGTON, DE:
364,386, REN. 12-19-08. U.S. CL. 6 (INT. CL. 5).
- OMS INVESTMENTS, INC., WILMINGTON, DE:
2,547,905, CANC. INT. CL. 1.
- OMX, INC., LAS VEGAS, NV:
2,546,643, CANC. INT. CL. 42.
2,547,607, CANC. INT. CL. 9.
- OMX, INC., NAPERVILLE, IL:
3,568,491, INT. CL. 16.
- ON THE MARC EVENTS, LLC, STAMFORD, CT:
3,567,387, PUB. 11-11-2008. INT. CL. 41.
- ONCOR ELECTRIC DELIVERY COMPANY, DALLAS, TX:
2,144,990, CANC. INT. CL. 9.
- ONDECK RECORDS AND ASSOCIATES, INC., ATLANTA, GA:
3,568,144, INT. CL. 41.
- ONE ELEVEN INTERACTIVE, INC., BROOKLYN, NY:
3,566,698, PUB. 11-11-2008. INT. CL. 42.
- ONE PEOPLE PROJECT, LLC, ENCINITAS, CA:
3,567,580, PUB. 11-11-2008. INT. CL. 25.
- ONE PROPERTY PLACE CORPORATION, OWENSBORO, KY:
3,567,181, PUB. 11-11-2008. INT. CL. 36.
- ONE, INC., BARRINGTON, IL:
2,546,110, CANC. INT. CL. 42.
- ONEWORLD GLOBAL MANUFACTURING SOLUTIONS LTD, KOWLOON BAY, HONG KONG:
3,568,348, INT. CL. 9.
- ONLEX TECHNOLOGIES, INC., AURORA, OH:
2,159,609, REN. 12-20-08. INT. CL. 9.
- ONLINEMRO.COM, INC., OAK RIDGE, TN:
2,545,748, CANC. INT. CL. 35.
- ONLY IN U.S.A., INC., LOS ANGELES, CA:
1,465,583, REN. 12-23-08. INT. CL. 25.
- OPEN COMPANIES, INC., THE, ASHEVILLE, NC:
3,568,023, INT. CL. 42.
- OPHTHALMIC NETWORK OF EXCELLENCE, INC., NEW YORK, NY:
2,546,318, CANC. INT. CL. 35.
- OPTIMAL HEALTH SCIENCE, LLC, NORTH SALT LAKE, UT:
3,566,994, PUB. 11-11-2008. INT. CL. 5.
- OPTION CARE, INC., BUFFALO GROVE, IL:
2,548,601, CANC. INT. CL. 42.
- OPTIONSPRESS HOLDINGS, INC., CHICAGO, IL:
3,568,709, INT. CL. 36.
- OPTIX TECH SP. Z O. O., 00-367 WARSAW, POLAND:
2,545,518, CANC. INT. CL. 9.
- ORANGE COUNTY BAR FOUNDATION, INC., SANTA ANA, CA:
2,545,622, CANC. INT. CL. 41.
- ORANGE ELECTRONIC CO., LTD., TAICHUNG COUNTY, TAIWAN:
3,566,306, PUB. 11-11-2008. INT. CL. 9.
- ORCHARD HOUSE LICENSING COMPANY, ROXBURY, CT:
2,216,377, REN. 12-23-08. INT. CL. 16.
- ORCHARD SUPPLY HARDWARE LLC, SAN JOSE, CA:
2,547,267, CANC. INT. CL. 35.
- ORDINE DI SAN GIOVANNI DI GERUSALEMME, ITALY:
3,567,842, PUB. 11-11-2008. INT. CL. 45.
- OREGON CHERRY GROWERS, INC., DALLAS, OR:
1,508,425, REN. 12-20-08. INT. CL. 29.
- ORIGINAL DESIGNS/FAMOR INC., LONG ISLAND CITY, NY:
2,547,555, CANC. INT. CL. 14.
- ORIKI COSMETICS, INC., WESTMINSTER, CA:
3,567,142, PUB. 11-11-2008. INT. CL. 3.
- ORION CORPORATION, SEOUL, REPUBLIC OF KOREA:
3,566,604, PUB. 11-11-2008. INT. CL. 30.
- ORIZON INTERNATIONAL PTE LTD., TRADEMART SINGAPORE #05-30, SINGAPORE:
2,547,804, CANC. INT. CL. 9.
- ORSOGRIL S.P.A., ANZANO DEL PARCO (CO), ITALY:
3,567,635, PUB. 11-11-2008. INT. CL. 6.
- ORTEGA, RAFAEL, HOUSTON, TX:
3,568,421, INT. CL. 30.
- OSIM INTERNATIONAL LTD., SINGAPORE, SINGAPORE:
3,566,441, PUB. 11-11-2008. MULTIPLE CLASS, INT. CLS. 10, 25 AND 35.
- OSIRIS INC., BRAMPTON, ONTARIO, CANADA:
3,567,715, PUB. 11-11-2008. INT. CL. 21.
- OSPREY SYSTEMS, INC., CHARLOTTE, NC:
2,548,566, CANC. MULTIPLE CLASS, INT. CLS. 9 AND 42.
- OSRAM SYLVANIA INC., DANVERS, MA:
2,547,933, CANC. INT. CL. 11.
- OTF GROUP, INC., BELMONT, MA AND S.E. VEN FUND, INC., CAMBRIDGE, MA:
3,567,292, PUB. 11-11-2008. INT. CL. 35.
- OTT, BRYAN WILLIAM, WOODLAND HILLS, CA:
2,546,676, CANC. INT. CL. 9.
- OTTO BOCK HEALTHCARE GMBH, 37115 DUDERSTADT, FED REP GERMANY:
2,279,026, REN. 12-22-08. INT. CL. 10.
2,280,927, REN. 12-22-08. INT. CL. 10.
- OUR NETWORKING CANADA LTD., THORNHILL, CANADA:
3,568,642, MULTIPLE CLASS, INT. CLS. 36 AND 41.
- OUTLET PARK RPFIV ASSOCIATES LLC, STAMFORD, CT:
2,545,939, CANC. INT. CL. 36.
- OWEN OIL TOOLS, INC., FORT WORTH, TX TO CORE LABORATORIES GLOBAL N.V., WILLEMSTAD, CURA-CAO, NETHERLD ANTILLES:
2,144,888, CANC. INT. CL. 13.
- OWOC, EILEEN, COOPER CITY, FL:
3,568,716, INT. CL. 41.
- OXFORD INDUSTRIES, INC., ATLANTA, GA:
1,490,301, CANC. INT. CL. 25.
- OXFORD MAGNET TECHNOLOGY LIMITED, EYNSHAM, OXFORD, ENGLAND:
1,480,697, CANC. INT. CL. 10.
- OYO ELECTRIC CO., LTD., JAPAN:
3,567,925, PUB. 11-11-2008. MULTIPLE CLASS, INT. CLS. 7 AND 9.
- P.C. RICHARD & SON LONG ISLAND CORP., FARMINGDALE, NY:
2,144,030, CANC. INT. CL. 35.
2,144,801, CANC. MULTIPLE CLASS, INT. CLS. 9, 14, 16, 25 AND 28.
- PABST BREWING COMPANY, SAN ANTONIO, TX:
2,546,443, CANC. INT. CL. 32.
3,568,093, INT. CL. 32.
- PACIFIC COAST FEATHER COMPANY, SEATTLE, WA:
2,145,218, CANC. INT. CL. 20.

- PACIFIC FRESH PRODUCE, INC., OXNARD, CA:
3,566,910, PUB. 11-11-2008. INT. CL. 31.
3,566,911, PUB. 11-11-2008. INT. CL. 31.
- PACIFIC MEDIA ASSOCIATES, MOUNTAIN VIEW, CA:
2,546,624, CANC. INT. CL. 35.
- PACIFIC TRAIL CORPORATION, PORTLAND, OR:
3,568,661, INT. CL. 18.
3,568,692, INT. CL. 18.
- PACKETEER, INC., CUPERTINO, CA:
2,547,379, CANC. INT. CL. 9.
- PAGEMART, INC., DALLAS, TX:
2,144,001, CANC. INT. CL. 9.
- PAGLO LABS INC., PALO ALTO, CA:
3,568,375, INT. CL. 9.
3,568,376, INT. CL. 42.
- PAILBOY, INC., SAN FRANCISCO, CA:
2,546,493, CANC. MULTIPLE CLASS, INT. CLS. 9 AND 41.
- PALACE CANDLES, INC., BEER SHEVA, ISRAEL:
2,547,996, CANC. INT. CL. 4.
2,547,997, CANC. INT. CL. 4.
- PALE HORSE BREWING COMPANY, SALEM, OR:
3,568,426, INT. CL. 32.
- PALLOTTA, DANIEL M. MR., LOS ANGELES, CA:
2,547,095, CANC. INT. CL. 36.
2,547,096, CANC. INT. CL. 36.
2,547,942, CANC. INT. CL. 25.
- PALMER SNYDER FURNITURE COMPANY, MILWAUKEE, WI:
3,567,081, PUB. 11-11-2008. INT. CL. 20.
3,567,207, PUB. 11-11-2008. INT. CL. 20.
- PANACYA, INC., ANNAPOLIS JUNCTION, MD:
2,547,983, CANC. INT. CL. 9.
- PANAMA GOLD OF AMERICA, INC., MIAMI, FL:
1,480,986, CANC. INT. CL. 31.
- PANAVISION INTERNATIONAL, L.P., WOODLAND HILLS, CA, PANAVISION, INCORPORATED, TARZANA, CA:
1,109,241, REN. 12-23-08. INT. CL. 9.
- PANCIL, LLC, LA JOLLA, CA:
3,568,630, INT. CL. 37.
- PANISH, SHARON LOUISE, WOODLAND HILLS, CA AND PANISH, MICHAEL STEVEN, WOODLAND HILLS, CA:
2,547,204, CANC. MULTIPLE CLASS, INT. CLS. 21 AND 28.
- PAPER AUSTRALIA PTY LTD, AUSTRALIA:
3,567,943, PUB. 11-11-2008. INT. CL. 16.
- PAPER-PAK PRODUCTS, INC., LA VERNE, CA:
1,480,788, CANC. INT. CL. 16.
- PAPILLON INTERNATIONAL INC., MONTREAL, CANADA:
3,566,575, PUB. 11-11-2008. INT. CL. 18.
- PARDEE HOMES, LOS ANGELES, CA:
3,567,106, PUB. 11-11-2008. MULTIPLE CLASS, INT. CLS. 36 AND 37.
- PAREX, INCORPORATED, REDAN, GA:
1,480,827, CANC. INT. CL. 20.
- PARFUMS DE COEUR, LTD., DARIEN, CT:
2,203,342, REN. 12-22-08. INT. CL. 3.
- PARK, BRADLEE CRAIG, DIAMOND BAR, CA, DBA AMERICA'S NEXT MOVIE STAR:
3,568,554, INT. CL. 41.
- PARTANEN, ANNALISA, BONHAM, TX:
3,566,895, PUB. 11-11-2008. INT. CL. 41.
- PARTNER'S ROYALTIES, LLC, WOODSTOCK, GA:
3,568,314, INT. CL. 40.
- PARTNERS IN LEADERSHIP IP II, LLC, TEMECULA, CA:
3,568,457, MULTIPLE CLASS, INT. CLS. 35 AND 41.
3,568,458, MULTIPLE CLASS, INT. CLS. 35 AND 41.
3,568,459, MULTIPLE CLASS, INT. CLS. 35 AND 41.
- PASSAGEWAYS INSTITUTE, INC., BOULDER, CO, DBA PASSAGEWORKS INSTITUTE, INC.:
3,566,543, PUB. 11-11-2008. INT. CL. 16.
- PASSALACQUA, ANTHONY, ORMOND BEACH, FL:
2,547,428, CANC. INT. CL. 41.
- PASSION PLAY MINISTRIES INTERNATIONAL, WHEATRIDGE, CO:
3,566,771, PUB. 11-11-2008. INT. CL. 41.
- PASTA SHOPPE, LLC, THE, NASHVILLE, TN:
2,211,452, REN. 12-22-08. INT. CL. 30.
- PATCH EDWARD, LLC, SAN FRANCISCO, CA:
3,567,347, PUB. 11-11-2008. INT. CL. 43.
- PATEL, RUPEN BIPIN, NEW YORK, NY:
3,566,592, PUB. 11-11-2008. INT. CL. 35.
- PATENT & LICENSE EXCHANGE, INC., THE, PASADENA, CA:
2,545,875, CANC. MULTIPLE CLASS, INT. CLS. 35, 36 AND 42.
- PATENT CENTRAL, LLC, HOLLYWOOD, FL:
2,224,180, REN. 12-22-08. INT. CL. 42.
- PATHWAYS INTERNATIONAL, INC., DALTON, GA:
2,545,528, CANC. INT. CL. 27.
- PATIENTS COUNT, LLC, DELTONA, FL:
3,567,157, PUB. 11-11-2008. INT. CL. 35.
- PATMONT MOTOR WERKS, INC., MINDEN, NV:
2,144,352, REN. 12-24-08. INT. CL. 12.
- PATRICK EINHORN, FRANCE:
3,567,912, PUB. 11-11-2008. MULTIPLE CLASS, INT. CLS. 3, 9, 14, 18, 24 AND 25.
- PATTIWORKS, INC., APPLE VALLEY, MN:
2,547,563, CANC. INT. CL. 40.
- PAUL S. TROCKI, HOLBROOK, MA, SENTRON, INC., SOMERVILLE, MA:
872,480, REN. 12-24-08. U.S. CL. 21 (INT. CL. 9).
- PAULSON AMBOOKAN, COMPUTERUSER, INC., SYOSSET, NY:
2,545,500, CANC. INT. CL. 35.
- PAVE TECH, INC., PRIOR LAKE, MN:
3,568,762, MULTIPLE CLASS, INT. CLS. 1, 2, 3, 8 AND 11.
- PAVLISKO, GEORGE C., ORANGE PARK, FL:
2,546,577, CANC. INT. CL. 3.
- PAW WASH, LLC, LEAWOOD, KS:
3,568,784, INT. CL. 21.
- PAXANIC TAZOKA, LLC, CARSON CITY, NV:
3,568,576, INT. CL. 35.
- PCI GEOMATICS ENTERPRISES, INC., RICHMOND HILL, ONTARIO, CANADA:
2,546,644, CANC. INT. CL. 9.
- PEARL S. BUCK INTERNATIONAL INC., PERKASIE, PA:
2,661,691, CANC. INT. CL. 35.
- PEARSON EDUCATION, INC., UPPER SADDLE RIVER, NJ:
1,104,315, REN. 12-20-08. INT. CL. 16.
2,547,728, CANC. INT. CL. 16.
- PEARSON, MELANIE A., ANTELOPE, CA AND PEARSON, KENT D., ANTELOPE, CA:
3,568,659, INT. CL. 28.
- PEASLEY, JULIE R, LOS ANGELES, CA:
3,567,381, PUB. 11-11-2008. INT. CL. 28.
- PEDERSEN, DARLENE D., NARBERTH, PA:
2,548,177, CANC. INT. CL. 42.
- PEDRO GARCIA BRANDS, S.L., ELDA, ALICANTE, SPAIN, AMAT, PEDRO GARCIA, ELDA (ALICANTE), SPAIN:
1,110,968, REN. 12-20-08. INT. CL. 25.
- PEERLESS INDUSTRIES, INC., MELROSE PARK, IL:
3,566,861, PUB. 11-11-2008. INT. CL. 6.
- PEGASO COMUNICACIONES Y SISTEMAS, S.A. DE C.V., 05120 MEXICO, D.F., MEXICO:
2,545,733, CANC. INT. CL. 38.
- PEI LICENSING, INC., MIAMI, FL:
3,567,761, PUB. 11-11-2008. INT. CL. 25.
- PELLA ART AND GRAPHICS, INC., PELLA, IA:
2,546,107, CANC. INT. CL. 35.
- PEM MANAGEMENT, INC., WILMINGTON, DE:
2,209,683, REN. 12-19-08. INT. CL. 6.
3,567,528, PUB. 11-11-2008. INT. CL. 7.
- PENDLETON WOOLEN MILLS, INC., PORTLAND, OR:
506,303, REN. 12-23-08. U.S. CL. 42 (INT. CL. 24).
1,524,639, REN. 12-23-08. INT. CL. 25.
3,568,773, INT. CL. 25.
- PENLEY SPORTS, LLC, SAN DIEGO, CA:
2,144,794, CANC. INT. CL. 28.
- PENN RACQUET SPORTS, INC., PHOENIX, AZ:
3,568,551, INT. CL. 28.
- PENNSYLVANIA DENTAL ASSOCIATION, HARRISBURG, PA:
2,546,281, CANC. INT. CL. 42.

- PENTAIR PUMP GROUP, INC., GOLDEN VALLEY, MN:
3,566,536, PUB. 11-11-2008. MULTIPLE CLASS, INT. CLS.
7 AND 9.
- PENTAIR WATER POOL AND SPA, INC., SANFORD, NC:
1,535,009. REN. 12-22-08. INT. CL. 7.
- PENTEL OF AMERICA, LTD., TORRANCE, CA:
3,568,008, INT. CL. 16.
- PENTON BUSINESS MEDIA, INC., NEW YORK, NY:
2,233,320. REN. 12-23-08. MULTIPLE CLASS, INT. CLS.
16 AND 42.
- PENTON PUBLISHING, INC., CLEVELAND, OH:
508,189. REN. 12-20-08. U.S. CL. 38 (INT. CL. 16).
- PEORIA CHIEFS COMMUNITY BASEBALL CLUB LLC,
PEORIA, IL:
3,566,980, PUB. 11-11-2008. INT. CL. 25.
- PEPSICO, INC., PURCHASE, NY:
3,567,613, PUB. 11-11-2008. INT. CL. 32.
- PERDUE HOLDINGS, INC., WILMINGTON, DE:
2,545,964, CANC. INT. CL. 29.
- PERFECT WEB CORPORATION, THE, DELRAY BEACH,
FL:
2,547,068, CANC. MULTIPLE CLASS, INT. CLS. 35 AND
42.
- PERFICIO NETWORKS, IRVINE, CA:
3,568,758, INT. CL. 5.
- PERFORMANCE BENEFITS, INC., LAFAYETTE, LA:
3,567,121, PUB. 11-11-2008. MULTIPLE CLASS, INT. CLS.
35 AND 36.
- PERFORMANCE DESIGNED PRODUCTS LLC, SHERMAN
OAKS, CA:
2,545,984, CANC. INT. CL. 9.
- PERFORMANCE PROCESS STRATEGISTS, INC., GILBERT,
AZ:
2,547,431, CANC. INT. CL. 41.
- PERFORMANCE PUMPS, INC., CASSELBERRY, FL TO
WELLPOINTING BY KENNEY, INC., CASSELBERRY, FL:
2,144,094, CANC. INT. CL. 7.
- PERMEDICS INC., SAN BERNARDINO, CA:
2,547,388, CANC. INT. CL. 9.
- PET FRIENDLY TRAVEL, LLC, UNIVERSAL CITY, CA:
3,567,731, PUB. 11-11-2008. INT. CL. 35.
- PETFOOD2U, INC., PORTLAND, OR:
2,547,002, CANC. INT. CL. 35.
- PETROCOFSKI, ANTHONY, TROY, NY:
3,568,667, INT. CL. 20.
- PETROLEO BRASILEIRO S.A.- PETROBRAS, RIO DE JA-
NEIRO, BRAZIL:
3,567,774, PUB. 11-11-2008. INT. CL. 4.
3,567,775, PUB. 11-11-2008. INT. CL. 40.
- PETROPED, INC., OAKDALE, CA:
2,546,603, CANC. INT. CL. 28.
- PFIP, LLC, DOVER, NH:
3,566,624, PUB. 11-11-2008. MULTIPLE CLASS, INT. CLS.
25 AND 41.
3,566,625, PUB. 11-11-2008. MULTIPLE CLASS, INT. CLS.
25 AND 41.
3,566,626, PUB. 11-11-2008. MULTIPLE CLASS, INT. CLS.
25 AND 41.
- PFISTER, ROLAND C., LE MONT-SUR-LAUSANNE, SWIT-
ZERLAND:
3,566,859, PUB. 11-11-2008. INT. CL. 3.
- PFIZER INC., NEW YORK, NY:
2,294,633. REN. 12-19-08. INT. CL. 5.
2,296,342. REN. 12-19-08. INT. CL. 5.
- PHALANX CORPORATION, BOCA RATON, FL:
2,548,564, CANC. INT. CL. 13.
- PHARMAGEL INTERNATIONAL, INC., CHATSWORTH,
CA:
3,566,918, PUB. 11-11-2008. INT. CL. 3.
- PHARMAMETRICS, INC., FORT WASHINGTON, PA TO
PHARMAMETRICS, INC., FORT WASHINGTON, PA:
2,145,208, CANC. INT. CL. 9.
- PHARMAXIS LTD, AUSTRALIA:
3,567,944, PUB. 11-11-2008. INT. CL. 5.
- PHD, INC., FORT WAYNE, IN, PNEUMATIC-HYDRAULIC
DEVELOPMENT COMPANY, INC., FORT WAYNE, IN:
673,154. REN. 12-23-08. U.S. CL. 23 (INT. CLS. 6, 7, 8, 9, 11,
12, 16, 21 AND 28).
- PHIL MUSUMECI AND BARNEY LANGNER JR., SANTA
CRUZ, CA:
3,567,688, PUB. 11-11-2008. INT. CL. 25.
- PHIL MUSUMECI AND BARNEY LANGNER, JR., SANTA
CRUZ, DE:
3,567,491, PUB. 11-11-2008. INT. CL. 25.
- PHIL MUSUMECI AND BARNEY LANGNER, JR., SANTA
CRUZ, CA:
3,567,494, PUB. 11-11-2008. INT. CL. 25.
3,567,654, PUB. 11-11-2008. INT. CL. 25.
3,567,655, PUB. 11-11-2008. INT. CL. 25.
- PHIL MUSUMECI AND BARRY LANGNER JR., SANTA
CRUZ, CA:
3,567,490, PUB. 11-11-2008. INT. CL. 25.
- PHIL MUSUMECI AND BARRY LANGNER, JR., SANTA
CRUZ, CA:
3,567,656, PUB. 11-11-2008. INT. CL. 25.
- PHILADELPHIA 76ERS L.P., PHILADELPHIA, PA:
2,283,624. REN. 12-23-08. INT. CL. 16.
2,283,625. REN. 12-22-08. INT. CL. 25.
- PHILHARMONIC SOCIETY OF ORANGE COUNTY, IR-
VINE, CA:
3,568,685, INT. CL. 41.
- PHILIP WOOD, INC., BERKELEY, CA:
1,513,536. REN. 12-20-08. MULTIPLE CLASS, INT. CLS.
16 AND 42.
- PHOENIX CONTACT GMBH & CO., 32825 BLOMBERG, FED
REP GERMANY:
2,210,524. REN. 12-24-08. INT. CL. 9.
- PHOENIX INTANGIBLES HOLDING COMPANY, WIL-
MINGTON, DE:
2,546,551, CANC. INT. CL. 30.
2,546,628, CANC. INT. CL. 30.
- PHOENIX SUNS LIMITED PARTNERSHIP, PHOENIX, AZ:
2,163,052. REN. 12-22-08. INT. CL. 41.
- PHOENIX WINDEU GROUP, LITTLE ROCK, AR:
2,548,091, CANC. INT. CL. 19.
- PHONE ON-HOLD MARKETING SYSTEMS, INC., THOU-
SAND OAKS, CA:
2,545,725, CANC. MULTIPLE CLASS, INT. CLS. 9 AND
41.
- PHONEGUYS VOICE & DATA SYSTEMS, INC., HUNTING-
TON BEACH, CA, DBA PHONE GUYS:
3,567,012, PUB. 11-11-2008. INT. CL. 9.
- PHOTOMEDEX, INC., MONTGOMERYVILLE, PA:
3,567,428, PUB. 11-11-2008. INT. CL. 10.
3,567,548, PUB. 11-11-2008. INT. CL. 10.
- PHOXXIE LLC, TAMPA, FL:
3,567,244, PUB. 11-11-2008. INT. CL. 41.
- PHYSICAL OPTICS CORPORATION, TORRANCE, CA:
1,515,959. REN. 12-24-08. INT. CL. 42.
3,568,622, INT. CL. 9.
- PHYSICIANS FORMULA COSMETICS, INC., AZUSA, CA:
2,547,162, CANC. INT. CL. 3.
- PHYSICIANS HEALTH PLAN OF NORTHERN INDIANA,
INC., FORT WAYNE, IN:
3,568,437, MULTIPLE CLASS, INT. CLS. 36 AND 44.
- PIANO PLAY MUSIC SYSTEMS, INC., SHERMAN OAKS,
CA:
3,568,640, INT. CL. 16.
- PIASAA USA LLC, BRONX, NY:
3,567,365, PUB. 11-11-2008. INT. CL. 25.
- PICASSO'S CUP, INC, LAKELAND, FL:
3,567,369, PUB. 11-11-2008. INT. CL. 35.
- PIERRE FABRE DERMO-COSMETIQUE, 92100 BOU-
LOGNE, FRANCE:
2,546,929, CANC. MULTIPLE CLASS, INT. CLS. 3 AND 5.
- PIERRE FABRE DERMO-COSMETIQUE, FRANCE:
3,567,989, PUB. 11-11-2008. INT. CL. 3.
- PIERRE FOODS, INC., CINCINNATI, OH:
3,566,953, PUB. 11-11-2008. INT. CL. 30.
- PII NORTH AMERICA, INC., HOUSTON, TX:
2,546,625, CANC. INT. CL. 9.
- PILGRIM IMPORTS, INC., MILWAUKEE, WI:
3,567,104, PUB. 11-11-2008. INT. CL. 35.
3,567,218, PUB. 11-11-2008. MULTIPLE CLASS, INT. CLS.
16 AND 28.

- PILLSBURY COMPANY, THE, MINNEAPOLIS, MN:
2,548,004, CANC. INT. CL. 30.
- PILOT TRADING COMPANY, INC., ZEPHYR COVE, NV:
2,174,706, REN. 12-24-08. INT. CL. 29.
- PINEHILLS LLC, PLYMOUTH, MA:
2,547,782, CANC. MULTIPLE CLASS, INT. CLS. 36 AND 37.
- PINEHURST COMPANY, THE, DALLAS, TX:
2,545,768, CANC. INT. CL. 36.
- PINNACLES UNLIMITED LLC, STURGEON BAY, WI:
3,568,734, INT. CL. 36.
- PIOV, LLC, BOWLING GREEN, KY:
3,567,384, PUB. 11-11-2008. INT. CL. 38.
- PIPELINE FINANCIAL GROUP, INC., NEW YORK, NY:
3,568,002, INT. CL. 36.
- PITNEY BOWES INC., STAMFORD, CT:
2,548,050, CANC. INT. CL. 9.
- PITTENGER, LARRY, MONTOURSVILLE, PA AND PIT-
TENGER, KELLY, MONTOURSVILLE, PA:
3,566,784, PUB. 11-11-2008. INT. CL. 21.
- PIZARRO, GLADYS A., NEW YORK, NY:
3,566,733, PUB. 11-11-2008. INT. CL. 41.
- PIZZA CONCEPTS, INC., TYLER, TX:
2,548,598, CANC. INT. CL. 42.
- PIZZA PIPELINE, INC., SPOKANE, WA:
2,216,326, REN. 12-19-08. INT. CL. 42.
2,216,327, REN. 12-19-08. INT. CL. 42.
- PLACENTRA, MICHAEL ANTHONY, ATLANTIC CITY, NJ:
2,548,123, CANC. INT. CL. 35.
- PLANET HOLLYWOOD (REGION IV), INC., ORLANDO, FL:
3,566,996, PUB. 11-11-2008. MULTIPLE CLASS, INT. CLS.
25, 41 AND 43.
- PLANSMITH CORPORATION, SCHAUMBURG, IL:
3,567,014, PUB. 11-11-2008. INT. CL. 42.
- PLANTATION SALES, INC., FAIRHOPE, AL:
2,145,484, CANC. INT. CL. 29.
- PLASEC, INC., RESTON, VA:
3,567,559, PUB. 11-11-2008. INT. CL. 9.
- PLASTIC-CART, INC., MIDLOTHIAN, VA:
2,548,224, CANC. INT. CL. 12.
- PLASTINUM POLYMER TECHNOLOGIES CORP., LOS
ANGELES, CA:
3,566,938, PUB. 11-11-2008. INT. CL. 40.
3,566,940, PUB. 11-11-2008. INT. CL. 40.
3,566,941, PUB. 11-11-2008. INT. CL. 1.
- PLATINA COSMETICOS LTDA., SAO BENEDITO, UBERA-
BA - MG, BRAZIL:
3,568,628, INT. CL. 3.
- PLATINI JEWELRY, INC., NEW YORK, NY:
2,723,383, CANC. MULTIPLE CLASS, INT. CLS. 35 AND
40.
- PLATINUM REVIEW COURSES, LLC, CULVER CITY, CA:
3,567,146, PUB. 11-11-2008. INT. CL. 41.
- PLAUDITS!, INC., OCOEE, FL:
3,566,360, PUB. 11-11-2008. INT. CL. 45.
- PLAYBACK MEDIA CORPORATION, REDWOOD CITY,
CA:
2,548,321, CANC. INT. CL. 41.
2,548,322, CANC. INT. CL. 41.
- PLAYBOY ENTERPRISES INTERNATIONAL, INC., CHICA-
GO, IL:
3,568,109, INT. CL. 16.
- PLAYFIRST, INC., SAN FRANCISCO, CA:
3,568,363, INT. CL. 9.
- PLAYING MANTIS, INC., SOUTH BEND, IN:
2,546,201, CANC. INT. CL. 28.
- PLAYTEX PRODUCTS, INC., WESTPORT, CT:
3,567,695, PUB. 11-11-2008. INT. CL. 21.
- PLBD, INC., IRVING, TX:
3,568,279, INT. CL. 25.
- PLEMONS, JOHN DOUGLAS, SAN FRANCISCO, CA:
3,567,079, PUB. 11-11-2008. INT. CL. 35.
- PLIANT CORPORATION, SCHAUMBURG, IL:
2,547,349, CANC. INT. CL. 9.
- PLUMMER, GREGORY G., PORTLAND, OR:
2,547,462, CANC. INT. CL. 25.
- PM FOOD SRL, MILAN, ITALY:
2,158,094, REN. 12-22-08. INT. CL. 42.
- PNS & WSS, INC., THOROFARE, NJ:
2,548,628, CANC. INT. CL. 16.
- POET RESEARCH, INC., SIOUX FALLS, SD:
3,568,072, INT. CL. 1.
3,568,073, INT. CL. 31.
3,568,074, INT. CL. 35.
3,568,075, INT. CL. 42.
- POGGENSEE, JOHN F., MARTINEZ, CA:
2,547,743, CANC. INT. CL. 18.
- POINTER, TOM L., HOUSTON, TX:
2,548,547, CANC. INT. CL. 35.
- POLA CHEMICAL INDUSTRIES INC., SHIZUOKA-KEN,
JAPAN:
3,568,652, INT. CL. 35.
- POLARIS INDUSTRIES INC., MEDINA, MN:
2,547,400, CANC. INT. CL. 12.
- POLAROID CORPORATION, WALTHAM, MA:
1,480,390, CANC. INT. CL. 3.
1,480,891, CANC. INT. CL. 28.
- POLIAKOFF, GARY A., SOUTHWEST RANCHES, FL:
3,566,747, PUB. 11-11-2008. INT. CL. 16.
- POLIKOR BOYA SANAYI VE TICARET ANONIM SIRKETI,
BURSA, TURKEY:
3,567,355, PUB. 11-11-2008. INT. CL. 1.
- POLKALOCA, INC., KEW GARDENS, NY:
3,567,515, PUB. 11-11-2008. INT. CL. 25.
- POLY-AMERICA, L.P., GRAND PRAIRIE, TX:
3,566,478, PUB. 11-11-2008. INT. CL. 17.
- POLYGLASS S.P.A., TREVISO, ITALY:
2,144,598, CANC. INT. CL. 19.
- POLYMORPH INSTRUMENTS, INC., SANTA CLARA, CA:
3,568,723, INT. CL. 9.
- POLYPLUS-TRANSFECTION; (SOCIÉTÉ ANONYME),
FRANCE:
3,567,877, PUB. 11-11-2008. MULTIPLE CLASS, INT. CLS.
1 AND 42.
- POLYSPEDE ELECTRONICS CORPORATION, DALLAS,
TX:
1,480,477, CANC. INT. CL. 7.
- POMWONDERFUL LLC, LOS ANGELES, CA:
3,568,594, INT. CL. 32.
- PONOKO LIMITED, AUCKLAND, NEW ZEALAND:
3,566,636, PUB. 11-11-2008. MULTIPLE CLASS, INT. CLS.
35, 40 AND 42.
- PONTICLARO INC., AUSTIN, TX:
3,568,173, INT. CL. 42.
- POP3 MEDIA, LLC, NEW YORK, NY:
2,546,132, CANC. INT. CL. 35.
- POROCEL INTERNATIONAL LLC, CINCINNATI, OH, DBA
THE ALUCHEM GROUP LLC:
3,566,865, PUB. 11-11-2008. MULTIPLE CLASS, INT. CLS.
1 AND 40.
- PORSCHE DESIGN PRODUKTE VERTRIEBS GMBH, 80539
MUNCHEN, FED REP GERMANY:
2,143,812, CANC. INT. CL. 3.
- PORT CITY AMPLIFICATION, BURGAW, NC:
3,567,409, PUB. 11-11-2008. INT. CL. 9.
3,567,411, PUB. 11-11-2008. INT. CL. 9.
- PORTA SYSTEMS CORP., SYOSSET, NY:
1,507,932, REN. 12-20-08. INT. CL. 9.
- PORTALSPHERE INC., OTTAWA ONTARIO, CANADA:
2,546,007, CANC. INT. CL. 9.
- PORTER-ZASADA, MARC, LOS ANGELES, CA:
3,566,653, PUB. 11-11-2008. MULTIPLE CLASS, INT. CLS.
16 AND 41.
- POST FOODS, LLC, ST. LOUIS, MO:
3,568,555, INT. CL. 30.
- POSTSENTRY, LLC., SAN JOSE, CA:
3,567,610, PUB. 11-11-2008. INT. CL. 9.
- POURMEHDI, HOUMAN, LOS ANGELES, CA:
2,546,517, CANC. INT. CL. 9.
- POWELL GARDENS INC., KINGSVILLE, MO:
3,566,983, PUB. 11-11-2008. INT. CL. 41.
- POWELL, KAREN, NEW YORK, NY:
2,547,516, CANC. MULTIPLE CLASS, INT. CLS. 9 AND
41.
- POWER DRIVES, INC., BUFFALO, NY:
1,481,209, CANC. INT. CL. 42.

POWER PLANTER, INC., PAXTON, IL:
2,297,936. REN. 12-24-08. INT. CL. 7.

POWER TECHNOLOGY ASSOCIATES, INC., SHARON, MA:
2,545,582, CANC. INT. CL. 35.

POWERS, MATTHEW A., ST. JOHNS, FL AND XSCAPES, LLC, JACKSONVILLE, FL:
3,566,679, PUB. 11-11-2008. INT. CL. 35.

POWERTEL, INC., WEST POINT, GA:
2,548,137, CANC. INT. CL. 38.

PPG ARCHITECTURAL FINISHES, INC., PITTSBURGH, PA:
2,545,942, CANC. INT. CL. 2.

PPG INDUSTRIES OHIO, INC., CLEVELAND, OH:
3,568,698, INT. CL. 41.

PPP, INC., SAN ANTONIO, TX:
2,545,544, CANC. INT. CL. 41.

PRADA S.A., LUXEMBOURG, LUXEMBOURG:
3,568,190, INT. CL. 9.

PRAETORIAN FITNESS PRODUCTS, INC., CARLISLE, PA:
3,568,603, INT. CL. 28.

PRAIRIE GODMOTHERS LLC, FLOSSMOOR, IL:
3,566,913, PUB. 11-11-2008. INT. CL. 44.

PRAVDEN, MARJORIE W., MELBOURNE, FL, DBA PRAVDEN & COMPANY:
2,144,754, CANC. INT. CL. 35.

PREBBLE, LANCE EDMUND KNIGHTS, LONDON, UNITED KINGDOM:
3,566,535, PUB. 11-11-2008. INT. CL. 45.

PRECHECK, INC., HOUSTON, TX:
3,567,492, PUB. 11-11-2008. INT. CL. 45.

PRECIMED S.A., 2534 ORVIN, SWITZERLAND:
3,567,077, PUB. 11-11-2008. INT. CL. 42.

PRECISION MANUFACTURING GROUP, LLC, CEDAR GROVE, NJ:
3,567,346, PUB. 11-11-2008. MULTIPLE CLASS, INT. CLS. 40 AND 42.

PRECISION VASCULAR SYSTEMS, INC., SALT LAKE CITY, UT:
2,547,929, CANC. INT. CL. 10.

PRECO NEW PRODUCTS CORP., BOISE, ID:
2,547,765, CANC. INT. CL. 9.

PRECURSOR, LLC, MC LEAN, VA:
2,546,865, CANC. INT. CL. 41.

PREFERRED HOTEL GROUP, INC., CHICAGO, IL:
3,568,142, MULTIPLE CLASS, INT. CLS. 36 AND 43.

PREMARK RWP HOLDINGS, INC., WELMINGTON, DE:
1,565,977. REN. 12-20-08. INT. CL. 20.

PREMIUM DENIM, LLC, CULVER CITY, CA:
3,566,793, PUB. 11-11-2008. INT. CL. 25.

PRESIDIO WINES, INC., LOMPOC, CA:
3,566,463, PUB. 11-11-2008. INT. CL. 33.

PRESTON BAILEY HOLDINGS, LLC, NEW YORK, NY:
3,568,626, INT. CL. 44.

PRESTONE PRODUCTS CORPORATION, DANBURY, CT:
2,144,982, CANC. INT. CL. 1.

PRETEND CITY, THE CHILDREN'S MUSEUM OF ORANGE COUNTY, IRVINE, CA:
2,547,049, CANC. INT. CL. 41.

PRICEPOINT FURNITURE, INC., MADISON, TN, DBA PRICE POINT FURNITURE:
3,567,540, PUB. 11-11-2008. INT. CL. 35.
3,567,543, PUB. 11-11-2008. INT. CL. 35.
3,567,546, PUB. 11-11-2008. INT. CL. 35.

PRIDE INTEGRATED SERVICES, INC., WEST PALM BEACH, FL:
2,548,009, CANC. INT. CL. 42.

PRIEBE, LANCE, KELOWNA, BRITISH COLUMBIA, DBA ROCKETSNAIL GAMES:
2,546,537, CANC. MULTIPLE CLASS, INT. CLS. 41 AND 42.

PRIME SOURCE ACCESSORIES, LTD., STUART, FL:
3,567,343, PUB. 11-11-2008. MULTIPLE CLASS, INT. CLS. 18 AND 21.

PRIMEDIA INC., NORCROSS, GA TO PRIMEDIA INC., NORCROSS, GA:
2,591,823, CANC. INT. CL. 41.

PRIMOS, INC., FLORA, MS:
3,566,674, PUB. 11-11-2008. INT. CL. 28.

PRINCELY, NICO, SHERMAN OAKS, CA:
2,546,258, CANC. INT. CL. 42.

PRINSOURCE CAPITAL COMPANIES, LLC, ST. LOUIS PARK, MN, DBA PRINSOURCE:
3,567,070, PUB. 11-11-2008. INT. CL. 36.

PRINTERON CORPORATION, KITCHENER ONTARIO N2R 1G1, CANADA:
2,202,629. REN. 12-19-08. INT. CL. 9.

PRINTERS PLUS, VIENNA, VA:
1,481,136, CANC. INT. CL. 42.

PRINTING DEVELOPMENTS, INC., RACINE, WI:
1,480,331, CANC. INT. CL. 1.

PRINTRAK INTERNATIONAL, INC., IRVINE, CA:
2,548,413, CANC. INT. CL. 9.

PRISMSOFT, GLENDALE, AZ:
3,566,263, PUB. 11-11-2008. INT. CL. 42.

PRITCHETT, WILLIE L., INDIANAPOLIS, IN:
3,567,189, PUB. 11-11-2008. INT. CL. 35.

PRIVET HOUSE, LLC, WARREN, CT:
3,567,095, PUB. 11-11-2008. INT. CL. 35.

PRL USA HOLDINGS, INC., WILMINGTON, DE:
2,548,470, CANC. INT. CL. 3.

PRN CORPORATION, SAN FRANCISCO, CA:
2,548,148, CANC. MULTIPLE CLASS, INT. CLS. 35, 41 AND 42.

PRO FOOTBALL WEEKLY LLC, RIVERWOODS, IL:
2,547,975, CANC. INT. CL. 41.

PRO-LINE INTERNATIONAL, INC., MELROSE PARK, IL:
3,568,590, INT. CL. 3.

PROCTER & GAMBLE COMPANY, THE, CINCINNATI, OH:
3,568,571, INT. CL. 41.

PROCURE TREATMENT CENTERS, INC., NEW YORK, NY:
3,567,158, PUB. 11-11-2008. INT. CL. 42.

PRODIGY COMMUNICATIONS CORPORATION, WHITE PLAINS, NY:
2,545,675, CANC. MULTIPLE CLASS, INT. CLS. 35 AND 42.

PRODRIVE 2000 LIMITED, OXFORDSHIRE, OX16 7XS, ENGLAND:
2,546,077, CANC. MULTIPLE CLASS, INT. CLS. 12 AND 25.

PRODUCE PRODUCTIONS, INC., CHERRY HILL, NJ:
2,144,230, CANC. INT. CL. 41.

PRODUCTS FINISHING CORPORATION, BROOKLYN, NY:
2,548,596, CANC. INT. CL. 18.

PROF. ARNEBORG ERNST, 14169 BERLIN, FED REP GERMANY:
3,567,818, PUB. 11-11-2008. MULTIPLE CLASS, INT. CLS. 9, 10 AND 44.

PROFESSIONAL CASE MANAGEMENT, SOUTHFIELD, MI, DBA CAREFORWARD:
3,567,109, PUB. 11-11-2008. INT. CL. 45.

PROFESSIONAL CONVENTION MANAGEMENT ASSOCIATION, CHICAGO, IL:
2,546,753, CANC. U.S. CL. B.
2,546,768, CANC. U.S. CL. B.

PROFESSIONAL DISPOSABLES INTERNATIONAL, INC., ORANGEBURG, NY:
3,568,609, INT. CL. 5.

PROFESSIONAL GOLFERS' ASSOCIATION OF AMERICA, THE, PALM BEACH GARDENS, FL:
2,238,785. REN. 12-22-08. INT. CL. 35.

PROFESSIONAL SECRETARIES INTERNATIONAL, KANSAS CITY, MO:
1,481,206, CANC. INT. CL. 42.

PROFUSE GROUP BV, BARNEVELD, NETHERLANDS:
2,547,799, CANC. INT. CL. 9.

PROGRESSIVE AGRICULTURE FOUNDATION, BIRMINGHAM, AL:
3,566,999, PUB. 11-11-2008. INT. CL. 41.

PROGRESSIVE ENERGY GROUP LLC, AURORA, IL, DBA PROSPECTIVE LLC:
3,567,185, PUB. 11-11-2008. INT. CL. 42.

PROJECT AIM, INC., PRAIRIE VILLAGE, KS:
2,546,491, CANC. INT. CL. 41.

PROKUPAC A.D., PROKUPLJE, SERBIA/MONTENEGRO:
3,568,017, INT. CL. 33.

- PROLA VEGA LLC, WILSON, WY:
3,568,428, MULTIPLE CLASS, INT. CLS. 35 AND 45.
- PROMARK BRANDS INC., MERIDIAN, ID:
2,224,447, REN. 12-19-08. INT. CL. 31.
2,229,109, REN. 12-19-08. INT. CL. 31.
- PROMECON PROZESS- & MESSTECHNIK CONRADS
GMBH, D-39179 BARLEBEN, FED REP GERMANY:
2,547,185, CANC. INT. CL. 9.
- PROMETHEAN INVESTMENT GROUP, LLC, NEW YORK,
NY:
2,548,001, CANC. INT. CL. 36.
- PROMOLA L.L.C., ROYAL OAK, MI:
2,546,345, CANC. INT. CL. 42.
- PROMOTIONS DISTRIBUTOR SERVICES CORPORATION,
ARLETA, CA:
2,545,755, CANC. INT. CL. 35.
- PRONEXUS INC., OTTAWA, CANADA:
3,567,771, PUB. 4-15-2008. INT. CL. 9.
- PRONGO.COM, INC., NAPERVILLE, IL:
2,546,967, CANC. INT. CL. 41.
- PROSTAR SERVICES, INC. CARROLLTON, TX:
3,566,347, PUB. 11-11-2008. INT. CL. 43.
- PROTECH PROFESSIONAL PRODUCTS, INC., BOYNTON
BEACH, FL:
3,568,673, INT. CL. 5.
- PROTECH THEATRICAL SERVICES, NORTH LAS VEGAS,
NV:
3,567,152, PUB. 11-11-2008. INT. CL. 9.
- PROTECTIVE LIFE CORPORATION, BIRMINGHAM, AL:
2,279,368, REN. 12-22-08. INT. CL. 36.
- PROUDFOOT, RALPH, YAKIMA, WA AND PROUDFOOT,
BRENDA, YAKIMA, WA:
2,545,982, CANC. INT. CL. 35.
- PROVENTUS AKTIEBOG, STOCKHOLM, SWEDEN:
3,566,595, PUB. 11-11-2008. INT. CL. 35.
- PROVIDENCE SEMINARS, INC., OCEANSIDE, CA:
2,547,109, CANC. INT. CL. 41.
- PRUDENTIAL INSURANCE COMPANY OF AMERICA,
THE, NEWARK, NJ:
2,548,099, CANC. INT. CL. 16.
- PS ENERGY GROUP, INC., ATLANTA, GA:
3,566,590, PUB. 11-11-2008. INT. CL. 39.
- PSC INC., WEBSTER, NY:
2,545,489, CANC. INT. CL. 9.
- PSYCHOLOGICAL CONSULTANTS TO MANAGEMENT,
SAN DIEGO, CA:
2,545,507, CANC. INT. CL. 9.
- PSYCHSOLUTIONS, LLC, MADISON, WI:
2,547,490, CANC. INT. CL. 9.
- PUBGET INC., CHESTNUT HILL, MA:
3,567,504, PUB. 11-11-2008. INT. CL. 42.
- PUBLIC BROADCASTING SERVICE, ARLINGTON, VA:
3,568,666, INT. CL. 38.
- PUBLISHING HOUSE OF THE EVANGELICAL LUTHERAN
CHURCH IN AMERICA, MINNEAPOLIS, MN:
3,567,274, PUB. 11-11-2008. INT. CL. 41.
3,567,275, PUB. 11-11-2008. INT. CL. 36.
- PUCHALSKI, JEFFERY L., LAGUNA NIGUEL, CA:
3,568,744, INT. CL. 35.
- PUGET SOUND BLOOD CENTER AND PROGRAM, SEAT-
TLE, WA:
3,566,728, PUB. 11-11-2008. INT. CL. 35.
- PULPDENT CORPORATION, WATERTOWN, MA:
1,103,810, REN. 12-19-08. INT. CL. 10.
- PULSIC LIMITED, BRISTOL, UNITED KINGDOM:
3,568,157, INT. CL. 9.
- PUMA AKTIENGESELLSCHAFT; RUDOLF DASSLER
SPORT, FED REP GERMANY:
3,567,960, PUB. 11-11-2008. INT. CL. 25.
2,547,662, CANC. INT. CL. 30.
- PUNALU'S BAKERY, INC., PAPAIKOU, HI:
2,547,662, CANC. INT. CL. 30.
- PUPGEAR CORPORATION, LOS GATOS, CA:
3,567,072, PUB. 11-11-2008. INT. CL. 21.
- PUR PREMIUM DENIM, INC., LOS ANGELES, CA:
3,566,356, PUB. 11-11-2008. INT. CL. 25.
- PURE & NATURAL COMPANY, SCOTTSDALE, AZ:
3,568,542, INT. CL. 3.
- PURINA MILLS, LLC, SHOREVIEW, MN:
2,221,955, REN. 12-23-08. INT. CL. 31.
- PUTZMEISTER CONCRETE PUMPS GMBH, AICHTAL,
FED REP GERMANY:
2,225,519, REN. 12-20-08. INT. CL. 7.
- Q-SPORT, LLC, SANTA BARBARA, CA:
2,548,066, CANC. INT. CL. 28.
2,548,084, CANC. INT. CL. 28.
- QBS SOFTWARE LIMITED, CHISWICK, LONDON W4 4PH,
ENGLAND:
2,545,529, CANC. MULTIPLE CLASS, INT. CLS. 9, 41
AND 42.
- QIAGEN GMBH, FED REP GERMANY:
3,567,797, PUB. 9-20-2005. MULTIPLE CLASS, INT. CLS.
1, 5 AND 9.
- QINETIQ LIMITED, FARNBOROUGH, HAMPSHIRE, UNI-
TED KINGDOM:
3,566,271, PUB. 11-11-2008. MULTIPLE CLASS, INT. CLS.
9, 40 AND 44.
- QSTAR TECHNOLOGIES, INC., MARY ESTHER, FL:
3,567,419, PUB. 11-11-2008. INT. CL. 9.
3,567,682, PUB. 11-11-2008. INT. CL. 9.
- QUADRILLE WALLPAPERS AND FABRICS, INC., NEW
YORK, NY:
1,108,706, REN. 12-19-08. MULTIPLE CLASS, INT. CLS.
21 AND 27.
- QUAKER LORRAINE HOLDINGS, LLC, CORAL SPRINGS,
FL:
3,566,350, PUB. 11-11-2008. INT. CL. 24.
- QUALIOPE, ESPACE PROVENCE 13002 MARSEILLE,
FRANCE:
2,545,749, CANC. MULTIPLE CLASS, INT. CLS. 35, 38
AND 42.
- QUALITY CARE SOLUTIONS, INC., PHOENIX, AZ:
2,546,388, CANC. MULTIPLE CLASS, INT. CLS. 35, 36
AND 42.
- QUALITY DISCOUNT PRESS PARTS & EQUIPMENT, INC.,
EGG HARBOR TOWNSHIP, NJ:
2,275,700, REN. 12-19-08. INT. CL. 7.
- QUANTEGY, INC., OPELIKA, AL:
2,546,842, CANC. INT. CL. 35.
2,546,911, CANC. INT. CL. 35.
- QUANTUM LEAP RESEARCH, INC., CLAYMONT, DE:
3,566,814, PUB. 11-11-2008. INT. CL. 9.
- QUANTUMCAST.NET, INC., RICHLAND, MI:
2,546,358, CANC. INT. CL. 38.
- QUANZHOU SOUTHEAST PHOTOELECTRIC CO., LTD.,
FUJIAN, CHINA:
3,567,878, PUB. 11-11-2008. INT. CL. 9.
- QUATRO AUTOMATION GROUP, LAGUNA HILLS, CA:
3,568,775, INT. CL. 7.
- QUEEN'S HARBOUR YACHT & COUNTRY CLUB OWNERS
ASSOCIATION, INC., JACKSONVILLE, FL:
3,567,034, PUB. 11-11-2008. INT. CL. 36.
- QUEENSEN-AMSINGER, LTD., ST. LOUIS, MO:
2,548,074, CANC. INT. CL. 35.
- QUEHANNA TILE COMPANY, WILMINGTON, DE:
2,547,506, CANC. INT. CL. 19.
- QUEST INTERNATIONAL, INC., IRVINE, CA:
3,566,780, PUB. 11-11-2008. INT. CL. 9.
- QUEST-TEC SOLUTIONS, INC., HOUSTON, TX:
3,566,527, PUB. 11-11-2008. INT. CL. 9.
3,566,528, PUB. 11-11-2008. INT. CL. 9.
3,566,537, PUB. 11-11-2008. INT. CL. 9.
- QUIBOS S.R.L., ITALY:
3,385,776, COR. INT. CL. 25.
- QUICK & REILLY TARA CORPORATION, PALM BEACH,
FL TO QUICK & REILLY/FLEET SECURITES INC, NEW
YORK, NY:
2,144,620, CANC. INT. CL. 36.
- QUICKLOGIC CORPORATION, SUNNYVALE, CA:
2,547,825, CANC. INT. CL. 9.
- QUIDEL CORPORATION, SAN DIEGO, CA:
2,547,327, CANC. INT. CL. 5.
- QUIET STORM RECORDS, INC., KANEOHE, HI:
2,546,176, CANC. INT. CL. 9.
- QUIK TRAX , LLC, ENTERPRISE, OR:
3,567,000, PUB. 11-11-2008. INT. CL. 28.

QUIKTRIP WEST, INC., WICHITA, KS:
2,548,314, CANC. INT. CL. 35.

QUINN, JANET F, LYONS, CO:
3,568,156, INT. CL. 20.

QUINTILES TRANSNATIONAL CORP., RESEARCH TRI-
ANGLE PARK, NC:
2,231,124, REN. 12-20-08, INT. CL. 35.

QUINTILES TRANSNATIONAL CORP., DURHAM, NC:
3,568,317, MULTIPLE CLASS, INT. CLS. 35, 41, 42, 44
AND 45.

QVC, INC., WEST CHESTER, PA:
2,144,766, CANC. INT. CL. 35.

QWEST COMMUNICATIONS INTERNATIONAL, INC.,
DENVER, CO, US WEST, INC., ENGLEWOOD, CO:
2,244,861, REN. 12-24-08, INT. CL. 38.

R. HAMMER ENTERPRISES, INC., LONGVIEW, TX:
3,568,406, INT. CL. 1.

R. TWINING AND COMPANY LIMITED, LONDON, SWIX
7LQ, UNITED KINGDOM:
2,545,696, CANC. INT. CL. 30.

R.I. LAMPUS COMPANY, SPRINGDALE, PA:
3,567,337, PUB. 11-11-2008, INT. CL. 19.

R.J. LONDON CHEMICALS INDUSTRIES CO., LTD., CHA-
CHOENSAO PROVINCE, THAILAND:
3,566,741, PUB. 11-11-2008, INT. CL. 2.

R-EQUAL, LLC, MEMPHIS, TN:
2,281,433, REN. 12-20-08, INT. CL. 20.
2,281,433, CANC. INT. CL. 6.

R:BASE TECHNOLOGIES, INC., MURRAYSVILLE, PA:
3,566,985, PUB. 11-11-2008, INT. CL. 9.
3,567,029, PUB. 11-11-2008, INT. CL. 9.

RACK ROOM SHOES OF VIRGINIA, LLC, CHARLOTTE,
NC:
2,145,344, CANC. INT. CL. 42.

RADARLUX RADAR SYSTEMS GMBH, FED REP GER-
MANY:
3,567,830, PUB. 11-11-2008, MULTIPLE CLASS, INT. CLS.
9 AND 11.

RADIOLOGY ADVOCACY ALLIANCE, RESTON, VA:
2,547,076, CANC. MULTIPLE CLASS, INT. CLS. 16 AND
42.

RADIUS TRACK CORPORATION, COON RAPIDS, MN:
2,215,593, REN. 12-19-08, INT. CL. 6.

RADPHARM, INC., WELLESLEY, MA:
2,546,964, CANC. INT. CL. 42.

RAFFERTY, ROBERT, EASTCHESTER, NY:
2,545,729, CANC. INT. CL. 42.

RAGLIN, TERRY R., CULVER CITY, CA:
3,566,374, PUB. 11-11-2008, INT. CL. 3.

RAGULA SYSTEMS DEVELOPMENT CORP., SALT LAKE
CITY, UT, DBA FATPIPE NETWORKS:
3,568,580, INT. CL. 9.

RAINBOW CHEMICALS, INC., HOUSTON, TX:
3,566,518, PUB. 11-11-2008, INT. CL. 1.

RAINBOW SANDALS, INC., SAN CLEMENTE, CA:
3,568,381, INT. CL. 25.

RAINMAKER MULTINATIONAL INC., BARRIE, ONTARIO
L4N 7W8, CANADA:
2,545,488, CANC. INT. CL. 28.

RAINMAKER THINKING, INC., NEW HAVEN, CT:
2,548,133, CANC. MULTIPLE CLASS, INT. CLS. 16 AND
41.

RAINS, RICHARD L., WOODRIDGE, IL:
2,547,234, CANC. INT. CL. 35.

RALLY! EDUCATION, GLEN HEAD, NY:
3,567,338, PUB. 11-11-2008, MULTIPLE CLASS, INT. CLS.
9, 16 AND 41.
3,567,468, PUB. 11-11-2008, INT. CL. 16.
3,567,509, PUB. 11-11-2008, MULTIPLE CLASS, INT. CLS.
16 AND 41.

RAM DYNAMICS INC., TEANECK, NJ:
1,480,648, CANC. INT. CL. 9.
1,480,649, CANC. INT. CL. 9.
1,480,650, CANC. INT. CL. 9.

RAM DYNAMICS INC., RANDOLPH, NJ:
1,480,651, CANC. INT. CL. 9.
1,481,157, CANC. INT. CL. 42.

RAMOS, DANIEL, CANOGA PARK, CA:
3,566,665, PUB. 11-11-2008, INT. CL. 41.

RANDALL INTERNATIONAL LLC, CARLSBAD, CA:
2,144,968, CANC. INT. CL. 3.

RANDYRUN GMBH, FED REP GERMANY:
3,567,840, PUB. 11-11-2008, MULTIPLE CLASS, INT. CLS.
35 AND 41.
3,567,841, PUB. 11-11-2008, MULTIPLE CLASS, INT. CLS.
35 AND 41.

RANGER INSURANCE COMPANY, HOUSTON, TX:
1,481,056, CANC. INT. CL. 36.

RANPAK CORP., CONCORD TOWNSHIP, OH:
1,480,787, CANC. INT. CL. 16.

RAPID RAKE, LLC, FARGO, ND:
2,548,597, CANC. INT. CL. 8.

RAPIDTEXT, INC., NEWPORT BEACH, CA:
2,546,270, CANC. MULTIPLE CLASS, INT. CLS. 9, 35, 41
AND 42.

RASMUSSEN, DONALD C., CHINO HILLS, CA:
2,547,395, CANC. INT. CL. 41.

RAVINIA FESTIVAL ASSOCIATION, HIGHLAND PARK,
IL:
3,568,187, INT. CL. 43.

RAYCOM MEDIA, INC., MONTGOMERY, AL:
2,546,251, CANC. INT. CL. 41.

RAYMOND J. AND JOSEPHINE A. KELLY PARTNERSHIP,
THE, CAMINO DE LAS BRISAS MURRIETA, CA, DBA
LAS BRISAS CONFERENCE CENTER:
2,546,884, CANC. INT. CL. 41.

RAYSPAN CORPORATION, SAN DIEGO, CA:
3,566,415, PUB. 11-11-2008, INT. CL. 9.

RCP, INC., HOUSTON, TX:
3,566,646, PUB. 11-11-2008, INT. CL. 35.

RDSK, INC., IRVINE, CA:
2,144,439, CANC. INT. CL. 9.

RDTG, INC., NORTH HIGHLANDS, CA, DBA RONI
DEUTCH TAX CENTER:
3,568,354, INT. CL. 35.
3,568,355, INT. CL. 35.

READER'S DIGEST ASSOCIATION, INC., THE, PLEASANT-
VILLE, NY:
2,204,577, REN. 12-22-08, INT. CL. 9.

READY PAC PRODUCE, INC., IRWINDALE, CA:
2,145,068, CANC. INT. CL. 29.

READYSETMOM, INC., PORTLAND, OR:
3,567,073, PUB. 11-11-2008, INT. CL. 45.

REAL ESTATE BUSINESS SERVICES, INC., LOS ANGELES,
CA:
3,566,806, PUB. 11-11-2008, INT. CL. 9.

REAL ESTATE 997 INC., LUDINGTON, MI:
3,567,098, PUB. 11-11-2008, INT. CL. 36.

REAL-TIME INNOVATIONS, INC., SUNNYVALE, CA:
2,548,458, CANC. INT. CL. 9.

REALMINDER, INC., NEWPORT BEACH, CA, DBA REAL
MINDER.COM:
2,546,394, CANC. INT. CL. 42.

REALPRICE, INCORPORATED, CHAPEL HILL, NC:
3,567,103, PUB. 11-11-2008, INT. CL. 36.

REALTYTMS, INC, BOULDER, CO:
3,567,582, PUB. 11-11-2008, INT. CL. 35.
3,567,588, PUB. 11-11-2008, INT. CL. 35.
3,567,592, PUB. 11-11-2008, INT. CL. 36.
3,567,593, PUB. 11-11-2008, INT. CL. 36.

REASONING SYSTEMS INC., PALO ALTO, CA:
2,144,652, CANC. INT. CL. 42.

RECKITT BENCKISER INC., PARSIPPANY, NJ:
2,595,588, CANC. INT. CL. 4.

RECONINSIGHT, LTD, DENVER, CO:
3,567,101, PUB. 11-11-2008, INT. CL. 9.

RED BULL GMBH, FUSCHL AM SEE, AUSTRIA:
2,545,746, CANC. MULTIPLE CLASS, INT. CLS. 32, 33
AND 42.

RED DEVELOPMENT, LLC, KANSAS CITY, MO:
3,567,054, PUB. 11-11-2008, INT. CL. 36.

RED GOLDSTEIN, DANIEL J., FORT WORTH, TX:
2,548,387, CANC. INT. CL. 41.

RED HAT, INC., RALEIGH, NC:
3,567,700, PUB. 11-11-2008, INT. CL. 9.

- RED STORM ENTERTAINMENT, INC., MORRISVILLE, NC:
2,548,324, CANC. INT. CL. 9.
- RED.COM, INC., EASTSOUND, WA:
3,567,172, PUB. 11-11-2008. INT. CL. 9.
- RED/GREEN A/S, 8000 ARHUS, DENMARK, B. KREBS SPORTSWEAR A/S, ARHUS C, DENMARK:
1,517,276, REN. 12-23-08. INT. CL. 25.
- RED'S DONUT SHOP, PADUCAH, KY:
3,567,059, PUB. 11-11-2008. INT. CL. 30.
- REDCATS, ROUBAIX, FRANCE:
3,566,502, PUB. 4-22-2008. MULTIPLE CLASS, INT. CLS. 24 AND 25.
3,566,503, PUB. 4-22-2008. INT. CL. 25.
3,566,504, PUB. 4-22-2008. MULTIPLE CLASS, INT. CLS. 16 AND 25.
- REDDECK SOFTWARE, INC., CLOVIS, CA:
2,547,991, CANC. INT. CL. 35.
- REDFLY MOTORSPORTS, INC., VIROQUA, WI:
3,568,699, INT. CL. 35.
- REDMOND, AMY C., BREAUX BRIDGE, LA AND REDMOND, DANIEL J., BREAUX BRIDGE, LA:
3,568,014, INT. CL. 41.
- REEBOK INTERNATIONAL LIMITED, LANCASTER LA1 IGF, UNITED KINGDOM, REEBOK SPORTS LIMITED, UXBRIDGE, MIDDLESEX UB9 6NS, ENGLAND:
2,215,348, REN. 12-19-08. INT. CL. 16.
- REED BUSINESS INFORMATION LIMITED, SUTTON, SURREY SM2 5AS, UNITED KINGDOM:
2,548,614, CANC. INT. CL. 16.
- REFRACTEC, INC., IRVINE, CA:
2,548,208, CANC. INT. CL. 42.
- REGAL HOTEL GROUP PLC, NEWBURY, BERKSHIRE, RG14 1NE, UNITED KINGDOM:
2,546,435, CANC. MULTIPLE CLASS, INT. CLS. 35, 41 AND 42.
- REGENCY CASINOS HOLDINGS LIMITED, CHICAGO, IL:
2,546,477, CANC. INT. CL. 41.
- REGGAE RUNNINS, HALLANDALE BEACH, FL:
3,566,339, PUB. 11-11-2008. INT. CL. 41.
- REHRER, JOHN W, ORANGE PARK, FL:
2,548,129, CANC. INT. CL. 25.
- REID, PERRI, ATLANTA, GA:
2,547,584, CANC. INT. CL. 20.
- REIGNING CATS AND DOGS, LLC, PORTLAND, OR:
3,566,869, PUB. 11-11-2008. MULTIPLE CLASS, INT. CLS. 31, 35, 39, 44 AND 45.
- RELIANT PHARMACEUTICALS, INC., LIBERTY CORNER, NJ:
1,480,436, CANC. INT. CL. 5.
- RELIEF-MART, INC., WESTLAKE VILLAGE, CA:
3,315,437, CANC. INT. CL. 20.
- RENAISSANCE HOLDING COMPANY, OKEMOS, MI:
3,566,449, PUB. 11-11-2008. MULTIPLE CLASS, INT. CLS. 35 AND 36.
- RENAISSANCE INSTITUTE, INC. THE, DESOTO, TX:
2,548,607, CANC. INT. CL. 41.
- RENAISSANCE KID PUBLISHING CORPORATION, MIAMI, FL:
2,548,130, CANC. INT. CL. 16.
- RENDA BROADCASTING CORPORATION, PITTSBURGH, PA:
3,566,962, PUB. 11-11-2008. INT. CL. 41.
- RENEGY HOLDINGS, INC., TEMPE, AZ:
3,567,149, PUB. 11-11-2008. INT. CL. 39.
- RENOVO ENERGY LLC, CHICAGO, IL:
3,566,593, PUB. 11-11-2008. INT. CL. 35.
- REPUBLIC PROMOTION CO., ORLANDO, FL:
3,567,087, PUB. 11-11-2008. INT. CL. 41.
- RESERVOIR SIMULATION RESEARCH CORP., TULSA, OK:
1,480,658, CANC. INT. CL. 9.
- RESOLUTION LASER, LLC, MINNETONKA, MN:
3,568,111, INT. CL. 44.
- RESONATE, CINCINNATI, OH:
2,144,599, CANC. INT. CL. 41.
- RESOUNDING JOY, INC., SAN DIEGO, CA:
3,566,549, PUB. 11-11-2008. MULTIPLE CLASS, INT. CLS. 41 AND 44.
- RESOURCE ENGINEERING, INC., GLENWOOD SPRINGS, CO:
2,548,220, CANC. INT. CL. 42.
- RESPIRATORY DISTRIBUTORS, INC., FOLEY, AL:
2,546,989, CANC. INT. CL. 36.
2,546,990, CANC. INT. CL. 7.
- RESTORATION LLC, MAIDEN, NC:
3,566,281, PUB. 4-29-2008. INT. CL. 35.
- RESTORATION, LLC, MAIDEN, NC:
3,566,282, PUB. 4-29-2008. INT. CL. 35.
- REVENT INTERNATIONAL AB, UPPLANDS VÄSBY, SWEDEN:
3,566,562, PUB. 11-11-2008. INT. CL. 11.
- REVENUE TECHNOLOGIES CORPORATION, ATLANTA, GA:
2,546,587, CANC. INT. CL. 35.
- REVOLUTIONARY INVESTMENTS, LLC, NAPERVILLE, IL:
3,568,527, INT. CL. 5.
- REYNOLDS AND REYNOLDS COMPANY, THE, DAYTON, OH:
1,513,376, REN. 12-20-08. INT. CL. 9.
- RF SURGICAL SYSTEMS, INC., BELLEVUE, WA:
3,568,103, INT. CL. 9.
- RFIDCOMPLETE, ANCHORAGE, AK:
3,568,047, MULTIPLE CLASS, INT. CLS. 35 AND 42.
- RFR, INC, RIDOTT, IL, DBA JANSEN ELECTRONICS:
3,567,622, PUB. 11-11-2008. INT. CL. 45.
- RFTL, LLC, SAN FRANCISCO, CA:
3,406,336, CANC. INT. CL. 14.
- RHEA, MATTHEW, LA MESA, CA:
3,567,200, PUB. 11-11-2008. INT. CL. 16.
- RICH PRODUCTS CORPORATION, BUFFALO, NY:
859,007, REN. 12-23-08. U.S. CL. 46 (INT. CL. 29).
- RICH WORLDWIDE TRAVEL, INC., SCARSDALE, NY:
3,566,824, PUB. 11-11-2008. MULTIPLE CLASS, INT. CLS. 39 AND 43.
- RICHARD E THIBAUT, INC., NEWARK, NJ:
2,546,275, CANC. INT. CL. 27.
- RICHARD WOLF GMBH, FED REP GERMANY:
3,567,977, PUB. 11-11-2008. INT. CL. 10.
- RICOLA AG, LAUFEN, SWITZERLAND:
1,480,398, CANC. MULTIPLE CLASS, INT. CLS. 5 AND 30.
- RIDGE CAPITAL, LLC, DENVER, CO:
3,566,820, PUB. 11-11-2008. INT. CL. 37.
- RIDGES, LUCILLE, TALLULAH, LA:
2,546,192, CANC. INT. CL. 41.
- RIGGS-BERGESEN, CATHERINE, NEW YORK, NY:
2,545,927, CANC. INT. CL. 42.
- RILEY, RANDOLPH, NEWBURYPORT, MA:
1,480,496, CANC. INT. CL. 8.
- RIMBACK, GRANT R., ROCKFORD, TN AND RIMBACK, DANA S., MARYVILLE, TN:
3,568,238, INT. CL. 41.
- RIO PRODUCTS INTL., INC., IDAHO FALLS, ID:
2,209,245, REN. 12-19-08. INT. CL. 28.
- RIOS, FRANCISCO, MORENO VALLEY, CA:
3,567,743, PUB. 6-19-2007. INT. CL. 41.
- RISE CLUB, INC., BOSTON, MA:
2,582,239, AM. INT. CL. 41.
- RISING PHARMACEUTICALS, INC., ALLENDALE, NJ:
3,568,718, INT. CL. 5.
- RISKE, MARTIN J, FARGI, ND, DBA MJR HOLDINGS, LLLP:
3,567,472, PUB. 11-11-2008. INT. CL. 9.
- RITEN INDUSTRIES, INC., WASHINGTON COURT HOUSE, OH:
2,266,149, REN. 12-23-08. INT. CL. 7.
- RITTER, ROBERT, SAN RAMON, CA:
1,480,603, CANC. INT. CL. 9.
- RIVERA PRIMO, INC, WHITTIER, CA, DBA RIVERA ENGINEERING:
3,566,839, PUB. 11-11-2008. INT. CL. 12.
- RIVIERA OPERATING CORPORATION, LAS VEGAS, NV:
2,547,701, CANC. INT. CL. 25.

RIZ OFFICE S.P.A., 33074 CEOLINI DI FONTANAFREDDA PN, ITALY:
2,547,832, CANC. INT. CL. 20.

RJA GROUP, INC., THE, CHICAGO, IL:
2,545,564, CANC. INT. CL. 37.

RJP S.R.L., ISERNIA, ITALY:
2,545,816, CANC. INT. CL. 18.

RMC OF ILLINOIS, PHILADELPHIA, PA:
3,568,134, MULTIPLE CLASS, INT. CLS. 35 AND 41.

RMI CORPORATION, CUPERTINO, CA, DBA RAZA MICROELECTRONICS, INC.:
3,568,751, INT. CL. 9.
3,568,752, INT. CL. 9.

ROAD RAGE, INC., SPRING GROVE, IL:
3,566,529, PUB. 11-11-2008. INT. CL. 40.
3,566,530, PUB. 11-11-2008. INT. CL. 40.

ROANOKE TECHNOLOGY CORPORATION, ROANOKE RAPIDS, NC:
2,545,660, CANC. INT. CL. 9.

ROBERT D. BOTELHO JR., CANTON, MA:
3,566,571, PUB. 11-11-2008. INT. CL. 35.
3,566,572, PUB. 11-11-2008. INT. CL. 35.

ROBERT J. HILL JR., SURFSIDE BEACH, SC, DBA MOUSE TALES TRAVEL:
3,567,225, PUB. 11-11-2008. INT. CL. 39.

ROBERT JAMES ENGEL, ATLANTA, GA:
2,548,370, CANC. INT. CL. 35.

ROBIN EILEEN INCORPORATED, BUFFALO GORVE, IL:
2,548,134, CANC. MULTIPLE CLASS, INT. CLS. 30 AND 35.

ROBIN REED TABANA, SAN DIEGO, CA:
3,567,299, PUB. 11-11-2008. INT. CL. 25.

ROBINSON, RHASAIH J., CINCINNATI, OH:
3,567,304, PUB. 11-11-2008. INT. CL. 25.

ROCHE DIAGNOSTICS GMBH, 68305 MANNHEIM, FED REP GERMANY:
3,567,986, PUB. 11-11-2008. INT. CL. 10.
3,567,987, PUB. 11-11-2008. INT. CL. 10.

ROCK CITY MUSIC, LLC, SPOKANE, WA:
2,548,019, CANC. INT. CL. 15.

ROCK RIVER ARMS, INC., COLONA, IL:
3,568,721, INT. CL. 13.

ROCKET BALL, LTD., HOUSTON, TX:
2,547,470, CANC. INT. CL. 25.

ROCKET SOFTWARE, INC, NEWTON, MA:
2,548,520, CANC. INT. CL. 9.

ROCKLER COMPANIES, INC., MEDINA, MN:
2,548,435, CANC. INT. CL. 7.

RODERICK, BRANDE, SAN MARCOS, CA:
3,566,284, PUB. 11-11-2008. MULTIPLE CLASS, INT. CLS. 25 AND 35.

RODIN, MOSES, TALLAHASSEE, FL:
3,566,667, PUB. 11-11-2008. MULTIPLE CLASS, INT. CLS. 35 AND 36.

RODRIGUEZ, GEORGE, CORAL GABLES, FL:
3,567,132, PUB. 11-11-2008. MULTIPLE CLASS, INT. CLS. 35 AND 43.

ROGER D. EMERSON CO., LPA, AKRON, OH:
2,548,416, CANC. INT. CL. 42.

ROHM AND HAAS COMPANY, PHILADELPHIA, PA:
1,480,319, CANC. INT. CL. 1.
1,524,120, REN. 12-20-08. INT. CL. 5.

ROLITE COMPANY, INC., HARTLAND, WI:
3,568,697, INT. CL. 3.

ROMA POMODORI, INC., MEMPHIS, TN:
3,567,717, PUB. 11-11-2008. INT. CL. 32.

ROMAN BRATASIUK, KENSINGTON PARK, AUSTRALIA:
3,566,923, PUB. 11-11-2008. INT. CL. 33.

ROMAN CHEESE PRODUCTS LIMITED, NIAGARA FALLS, ONTARIO, CANADA:
1,480,954, CANC. INT. CL. 30.

ROOFERS' SUCCESS INTERNATIONAL, LLC, ST. LOUIS, MO:
3,567,996, INT. CL. 37.

ROSADO, MARCUS, NEW YORK, NY AND ROSADO, STEVEN, NEW YORK, NY:
3,566,652, PUB. 11-11-2008. INT. CL. 41.

ROSAEN PRODUCTS, LLC, HAZEL PARK, MI:
3,568,243, INT. CL. 6.

ROSCOE COMPANY, THE, CHICAGO, IL:
2,548,571, CANC. INT. CL. 35.

ROSEA HOLDING B.V., WILLEMSTAD, CURACAO, NETHERLD ANTILLES, HOUBIGANT, INC., NEW YORK, NY:
865,472, REN. 12-23-08. U.S. CL. 51 (INT. CLS. 3 AND 5).
877,162, REN. 12-23-08. U.S. CL. 51 (INT. CLS. 3 AND 5).

ROSENDORF, CHARLES H., WEST ORANGE, NJ:
3,566,466, PUB. 11-11-2008. INT. CL. 9.

ROSS ACQUISITIONS, INC., CINCINNATI, OH, DBA THE JELLY BEAN FACTORY:
3,566,256, PUB. 11-11-2008. INT. CL. 28.

ROTOR TOOL COMPANY, THE, CLEVELAND, OH TO COOPER TECHNOLOGIES COMPANY, HOUSTON, TX:
2,144,024, CANC. INT. CL. 9.

ROWLAND INSTITUTE FOR SCIENCE, INC., THE, CAMBRIDGE, MA:
2,548,240, CANC. MULTIPLE CLASS, INT. CLS. 9, 16, 17 AND 42.

ROW COATING GESELLSCHAFT FUR BESCHICHTUNG MBH, D-79336 HERBOLZHEIM, FED REP GERMANY:
2,545,957, CANC. INT. CL. 17.

ROYAL ADHESIVES AND SEALANTS, LLC, SOUTH BEND, IN:
863,734, REN. 12-24-08. U.S. CL. 1 (INT. CL. 17).

ROYAL ALUMINUM & STEEL, INC., CHESTERFIELD TWP., MI:
3,566,494, PUB. 11-11-2008. INT. CL. 6.

ROYAL APPLIANCE MFG. CO., GLENWILLOW, OH:
3,568,048, INT. CL. 3.

RPB S.P.A., ITALY:
3,567,811, PUB. 11-11-2008. MULTIPLE CLASS, INT. CLS. 18 AND 25.

RSC EQUIPMENT RENTAL, INC., SCOTTSDALE, AZ:
2,233,465, REN. 12-20-08. MULTIPLE CLASS, INT. CLS. 35 AND 37.

RSIALARM, INC., CIRCLE PINES, MN:
3,568,069, MULTIPLE CLASS, INT. CLS. 9, 37 AND 45.

RUAG AMMOTEC GMBH, 90765 FURTH, FED REP GERMANY:
3,566,710, PUB. 11-11-2008. INT. CL. 13.

RUBIE'S COSTUME CO., INC., RICHMOND HILL, NY:
3,567,691, PUB. 11-11-2008. INT. CL. 25.

RUGGERO BAULI S.P.A., ITALY:
3,567,858, PUB. 11-11-2008. INT. CL. 30.

RUSKINN LIFE SCIENCES LIMITED, PENCOED, UNITED KINGDOM:
3,566,368, PUB. 4-1-2008. MULTIPLE CLASS, INT. CLS. 9, 10 AND 44.

RUSSELL CORPORATION, ATLANTA, GA:
3,567,663, PUB. 11-11-2008. INT. CL. 28.
3,567,694, PUB. 11-11-2008. INT. CL. 28.

RUSSELL HARRINGTON CUTLERY, INC., SOUTHBRIDGE, MA:
2,545,751, CANC. INT. CL. 8.

RUSSON, MARK, PALO ALTO, CA:
2,144,955, CANC. INT. CL. 35.

RUSTIC RECORDS, INC., PHOENIX, AZ:
2,547,064, CANC. INT. CL. 9.

RUTLAND PLASTIC TECHNOLOGIES, INC., PINEVILLE, NC:
3,566,452, PUB. 11-11-2008. MULTIPLE CLASS, INT. CLS. 1 AND 2.

RVG GROUP, INC., MIAMI, FL:
1,480,385, CANC. INT. CL. 3.

RWD TECHNOLOGIES, LLC, BALTIMORE, MD:
2,548,289, CANC. INT. CL. 41.

RX REVERSE DISTRIBUTORS, INC., SEBASTIAN, FL:
3,567,269, PUB. 11-11-2008. INT. CL. 35.

RYAN AMUSEMENTS, INC., LEWES, DE:
2,546,696, CANC. INT. CL. 17.

R4 TELEMEDICINE SYSTEMS, INC., FALL RIVER, MA:
2,545,741, CANC. INT. CL. 9.

S. ROTHSCHILD & CO., INC., NEW YORK, NY:
3,566,576, PUB. 11-11-2008. INT. CL. 25.

- S.C. JOHNSON COMMERCIAL MARKETS, INC., STURTEVANT, WI:
2,547,666, CANC. INT. CL. 3.
- S.D. MYERS, INC., AKRON, OH:
1,481,067, CANC. INT. CL. 37.
- S&C ELECTRIC COMPANY, CHICAGO, IL:
1,118,152, REN. 12-22-08. INT. CL. 9.
- S&D COFFEE, INC., CONCORD, NC:
3,567,196, PUB. 11-11-2008. INT. CL. 30.
- S://SCAPE COMMUNICATIONS, INC., TORONTO, ONTARIO, CANADA:
2,546,469, CANC. INT. CL. 35.
- SA PICANDINE, FRANCE:
3,567,979, PUB. 11-11-2008. INT. CL. 29.
- SA SA OVERSEAS LIMITED, ROADTOWN, BR. VIRGIN ISLANDS:
3,566,376, PUB. 11-11-2008. MULTIPLE CLASS, INT. CLS. 5 AND 18.
- SAATARA, MEHRDAD, AZUSA, CA AND NGUYEN, VIET, AZUSA, CA AND PAYNE, CHRIS, AZUSA, CA AND PACHECO, ARTURO, AZUSA, CA AND NGUYEN, DAT, AZUSA, CA:
2,546,618, CANC. INT. CL. 41.
- SACHTLEBEN CHEMIE GMBH, FED REP GERMANY:
3,567,855, PUB. 11-11-2008. MULTIPLE CLASS, INT. CLS. 1, 2 AND 5.
- SADOWSKY GUITARS, LTD., NEW YORK, NY:
1,524,442, REN. 12-22-08. INT. CL. 15.
- SAE INTERNATIONAL, WARRENDALE, PA:
1,481,166, CANC. INT. CL. 42.
- SAFECO CORPORATION, SEATTLE, WA:
3,566,413, PUB. 11-11-2008. INT. CL. 36.
- SAFEEXITS, INC., FRUIT HEIGHTS, UT:
3,335,873, CANC. INT. CL. 11.
- SAFEGUARD TECHNOLOGY, INC., CHAGRIN FALLS, OH:
2,199,323, REN. 12-24-08. INT. CL. 6.
- SAFETY PRODUCTS ENGINEERING GROUP, INC., COMMERCE CITY, CO:
3,566,351, PUB. 11-11-2008. INT. CL. 7.
- SAFETY TECHNOLOGIES, INC., RED WING, MN:
2,548,429, CANC. INT. CL. 9.
- SAFEWAY INC., PLEASANTON, CA:
3,568,028, INT. CL. 29.
- SAGE ENGINEERING, INC., HOUSTON, TX:
2,212,398, REN. 12-20-08. INT. CL. 42.
- SAIGON COSMETICS COMPANY, HO CHI MINH CITY, VIETNAM:
2,145,110, CANC. INT. CL. 3.
- SAINT LOUIS TRADING CO. INC., SAN JUAN, PUERTO RICO:
1,490,281, REN. 12-19-08. INT. CL. 25.
- SAINT, INC., WICHITA, KS:
2,546,093, CANC. INT. CL. 14.
- SAKEONE CORPORATION, FOREST GROVE, OR:
3,566,857, PUB. 11-11-2008. INT. CL. 33.
- SALDANA, PETER JAMES, CORONA, CA:
2,547,778, CANC. INT. CL. 41.
- SALEDO ITALIA S.R.L., MILANO, ITALY:
2,547,893, CANC. INT. CL. 3.
- SALOMON SMITH BARNEY INC., NEW YORK, NY:
2,548,438, CANC. INT. CL. 36.
- SALONCLICK, LLC, MARLTON, NJ:
2,548,162, CANC. INT. CL. 3.
- SAMBUCA GROUP, INC., CARROLLTON, TX:
2,547,776, CANC. INT. CL. 39.
2,547,777, CANC. INT. CL. 39.
- SAMPLE DIGITAL, INC., LOS ANGELES, CA:
2,704,736, CANC. INT. CL. 35.
- SAMS, JUANITA B., LEXINGTON, KY, DBA NINA:
1,480,825, CANC. INT. CL. 20.
- SAMSKIP HF., ICELAND:
3,567,980, PUB. 11-11-2008. MULTIPLE CLASS, INT. CLS. 35, 36 AND 39.
- SAMSO HITE LLC, LONG BEACH, CA:
3,567,329, PUB. 11-11-2008. MULTIPLE CLASS, INT. CLS. 37 AND 38.
- SAMSON, FLORENCE MARYLENE, MARSEILLE, FRANCE:
3,566,412, PUB. 8-26-2008. INT. CL. 30.
- SAMSUNG ELECTRONICS CO., LTD., REPUBLIC OF KOREA:
3,567,883, PUB. 11-11-2008. INT. CL. 9.
3,567,884, PUB. 11-11-2008. INT. CL. 9.
- SAMSUNG TELECOMMUNICATIONS AMERICA, INC., RICHARDSON, TX:
2,547,940, CANC. INT. CL. 9.
2,547,967, CANC. INT. CL. 9.
- SAMUEL F. MULGREW, PEOSTA, IA:
3,568,340, INT. CL. 16.
- SAN DIEGO SWISS MACHINING, INC., CHULA VISTA, CA:
2,547,102, CANC. INT. CL. 28.
- SAN MARTIN, KRISTY RAIN, BOZEMAN, MT AND SAN MARTIN, SAGE WILLIAM, BOZEMAN, MT:
3,568,682, INT. CL. 9.
- SAN SWISS ARMS AG, NEUHAUSEN AM RHEINFALL, SWITZERLAND:
3,566,411, PUB. 5-27-2008. MULTIPLE CLASS, INT. CLS. 16, 18 AND 25.
- SAN SWISS ARMS TECHNOLOGY AG, NEUHAUSEN AM RHEINFALL, SWITZERLAND:
3,567,791, PUB. 3-25-2008. MULTIPLE CLASS, INT. CLS. 13 AND 28.
- SANDLER SYSTEMS, INC., OWINGS MILLS, MD:
3,568,632, INT. CL. 41.
- SANDLOT GAMES, BOTHELL, WA:
3,568,489, INT. CL. 9.
- SANDRA KING, AIEA, HI, DBA LIQUID METAL TATTOO & PIERCING:
3,567,555, PUB. 11-11-2008. INT. CL. 44.
- SANFORD, L.P., OAK BROOK, IL:
2,211,838, REN. 12-19-08. INT. CL. 16.
- SANITORS, INC., SAN ANTONIO, TX:
2,545,963, CANC. INT. CL. 42.
- SANOPI PASTEUR LIMITED/SANOPI PASTEUR LIMITEE, TORONTO, ONTARIO, CANADA:
3,568,121, INT. CL. 5.
3,568,122, INT. CL. 5.
- SANTA MONICA CONVENTION AND VISITORS BUREAU, SANTA MONICA, CA:
1,481,027, CANC. INT. CL. 35.
- SANTEN SEIYAKU KABUSHIKI KAISHA, HIGASHIYODOGAWA-KU, OSAKA, JAPAN, DBA SANTEN PHARMACEUTICAL CO., LTD.:
2,143,772, CANC. INT. CL. 5.
- SANY HEAVY INDUSTRY CO., LTD., CHANGSHA HUNAN PROVINCE, CHINA:
3,568,091, MULTIPLE CLASS, INT. CLS. 7 AND 37.
3,568,092, MULTIPLE CLASS, INT. CLS. 7 AND 37.
- SAP AKTIENGESELLSCHAFT, 69190 WALLDORF, FED REP GERMANY:
2,545,973, CANC. INT. CL. 25.
- SAP SCHUTZ ADVENTURE PRODUCTS INDUSTRIA E COMERCIO LTDA., CAMPO BOM, BRAZIL:
3,566,855, PUB. 11-11-2008. MULTIPLE CLASS, INT. CLS. 18, 25 AND 35.
- SARA LEE BAKERY GROUP, INC., DOWNERS GROVE, IL:
2,145,168, CANC. INT. CL. 30.
- SARBEK INC, LOS ANGELES, CA:
3,567,227, PUB. 11-11-2008. MULTIPLE CLASS, INT. CLS. 30 AND 35.
- SAREEN, IVA, LOS ANGELES, CA:
2,547,149, CANC. INT. CL. 7.
- SARL DES PETITS HAUTS, FRANCE:
3,567,893, PUB. 11-11-2008. MULTIPLE CLASS, INT. CLS. 18, 24 AND 25.
- SARTEC CORPORATION, ANOKA, MN:
2,547,452, CANC. INT. CL. 1.
- SASAKI, HIROHIKO, NEW YORK, NY:
2,548,268, CANC. INT. CL. 42.
- SAUDER WOODWORKING CO., ARCHBOLD, OH:
2,231,507, REN. 12-19-08. INT. CL. 20.

- SAVVY GRAD LLC, CAMBRIDGE, MA:
3,567,451, PUB. 11-11-2008. INT. CL. 41.
3,567,453, PUB. 11-11-2008. INT. CL. 41.
3,567,454, PUB. 11-11-2008. INT. CL. 41.
- SAZERAC COMPANY, INC., NEW ORLEANS, LA:
3,568,043, INT. CL. 33.
- SBLI USA MUTUAL LIFE INSURANCE COMPANY, INC.,
NEW YORK, NY:
3,568,001, INT. CL. 36.
- SCAFFOLDING RENTAL & ERECTION SERVICES, LLC,
PORT ALLEN, LA:
3,566,825, PUB. 11-11-2008. INT. CL. 37.
- SCANA CORPORATION, COLUMBIA, SC:
3,568,704, INT. CL. 39.
- SCANDICRAFTS CUISINE INTERNATIONAL, INC., CA-
MARILLO, CA:
2,547,090, CANC. INT. CL. 3.
- SCANDINAVIAN MIDSUMMER FESTIVAL ASSOCIATION,
ASTORIA, OR:
2,545,967, CANC. INT. CL. 35.
- SCANNON S.A., 75001 PARIS, FRANCE:
2,548,537, CANC. INT. CL. 3.
- SCHALLER ELECTRONIC GMBH, FED REP GERMANY:
3,567,879, PUB. 11-11-2008. MULTIPLE CLASS, INT. CLS.
9 AND 15.
- SCHEMA LTD., HERZELIA, ISRAEL:
2,547,485, CANC. INT. CL. 9.
- SCHIAVONE CONSTRUCTION CO., SEACAUCUS, NJ:
3,566,305, PUB. 11-11-2008. INT. CL. 37.
- SCHIFFMAN'S, INC., GREENSBORO, NC:
2,547,594, CANC. INT. CL. 35.
- SCHMANSKI, DONALD W., RENO, NV:
3,567,123, PUB. 11-11-2008. INT. CL. 11.
- SCHNEIDER, DAVID L., SAN DIEGO, CA:
2,548,616, CANC. INT. CL. 41.
- SCHOLAR BALLER I.M.A.G.E., LLC, MESA, AZ:
3,568,575, MULTIPLE CLASS, INT. CLS. 25 AND 41.
- SCHOLARBUYS LLC, HAMPSHIRE, IL:
3,567,167, PUB. 11-11-2008. INT. CL. 35.
- SCHOLARSHIP AMERICA, INC., ST. PETER, MN:
2,145,088, CANC. MULTIPLE CLASS, INT. CLS. 35 AND
41.
- SCHOLASTIC INC., NEW YORK, NY:
3,568,391, INT. CL. 41.
3,568,418, INT. CL. 41.
3,568,434, INT. CL. 41.
3,568,435, INT. CL. 41.
- SCHOOL ZONE PUBLISHING COMPANY, GRAND HA-
VEN, MI:
1,516,351, REN. 12-23-08. INT. CL. 16.
- SCHOOL-LINK NETWORK, INC., SANTA MONICA, CA:
2,545,876, CANC. INT. CL. 42.
- SCHOTT AG, D-55122 MAINZ, FED REP GERMANY:
2,221,401, REN. 12-24-08. INT. CL. 21.
- SCHOTT AKTIENGESSELLSCHAFT, FED REP GERMANY:
3,567,919, PUB. 11-11-2008. INT. CL. 9.
3,567,921, PUB. 11-11-2008. INT. CL. 9.
3,567,922, PUB. 11-11-2008. INT. CL. 9.
3,567,923, PUB. 11-11-2008. INT. CL. 9.
- SCHRODER JOSEPH & ASSOCIATES LLP, BUFFALO, NY:
3,567,019, PUB. 11-11-2008. INT. CL. 45.
- SCHUBERT, SUSANNE F, BROOKLYN, NY, DBA UMSTEI-
GEN:
3,566,870, PUB. 11-11-2008. INT. CL. 25.
- SCHUMACHER UMWELT-UND TRENNTRECHNIK GMBH,
D-74564 CRAILSHEIM, FED REP GERMANY:
2,546,030, CANC. MULTIPLE CLASS, INT. CLS. 1, 7, 11
AND 17.
- SCHWAN'S IP, LLC, MARSHALL, MN:
2,548,195, CANC. INT. CL. 30.
- SCHWARTZ & CO., LLC, MINNEAPOLIS, MN:
3,568,769, INT. CL. 35.
3,568,770, INT. CL. 35.
- SCHWARTZ ELECTRO-OPTICS, INC., ORLANDO, FL:
2,548,332, CANC. INT. CL. 9.
- SCHWEITZER ENGINEERING LABORATORIES, INC.,
PULLMAN, WA:
3,566,889, PUB. 11-11-2008. INT. CL. 9.
- SCHWING GMBH, D-44653 HERNE, FED REP GERMANY:
1,517,014, REN. 12-22-08. INT. CL. 7.
- SCHWINN ACQUISITION LLC, MADISON, WI, GT BMX
PRODUCTS, INC., HUNTINGTON BEACH, CA:
1,516,316, REN. 12-19-08. INT. CL. 12.
- SCIENTIFIC EQUIPMENT AND FURNITURE ASSOCIA-
TION, GARDEN CITY, NY:
3,567,594, PUB. 11-11-2008. INT. CL. 35.
- SCIENTIFIC TOYS, LTD., KOWLOON, HONG KONG,
CHINA:
3,567,168, PUB. 11-11-2008. INT. CL. 28.
- SCORPION BAY, INC., MURRIETTA, CA:
2,144,701, CANC. INT. CL. 32.
- SCOTT DOERR, CHARLOTTE, NC:
3,566,867, PUB. 11-11-2008. INT. CL. 36.
- SCOTT PAPER COMPANY, DELAWARE COUNTY, PA:
1,480,845, CANC. INT. CL. 21.
- SCOTT TECHNOLOGIES, INC., BOCA RATON, FL:
1,119,513, REN. 12-22-08. INT. CL. 7.
- SCOTT, MARILYN, MANHATTAN BEACH, CA:
3,568,003, INT. CL. 25.
- SCOTT, MEREDITH, GREENSBORO, NC:
3,568,106, INT. CL. 16.
- SCOTT, RICHARD, ALAMO, CA:
1,480,819, CANC. INT. CL. 20.
- SCRIPPS NETWORKS, INC., KNOXVILLE, TN:
2,145,008, CANC. INT. CL. 9.
- SCRIPTPRO LLC, MISSION, KS:
2,548,150, CANC. INT. CL. 9.
- SDAD. COOP. AGRARIA NUESTRO PADRE JESUS DEL
PERDON, 13200 MANZANARES (CIUDAD REAL), SPAIN:
2,545,593, CANC. INT. CL. 33.
- SEA BREEZE FRUIT FLAVORS, INC., TOWACO, NJ:
3,568,324, INT. CL. 32.
- SEA PACIFIC INVESTMENTS, LLC, BURBANK, CA:
3,566,403, PUB. 4-8-2008. MULTIPLE CLASS, INT. CLS. 6,
9 AND 21.
- SEA WORLD, INC., ST. LOUIS, MO:
2,227,129, REN. 12-24-08. INT. CL. 41.
- SEAFAIR, SEATTLE, WA:
1,516,501, REN. 12-20-08. INT. CL. 26.
- SEALANT, WATERPROOFING & RESTORATION INSTI-
TUTE, KANSAS CITY, MO:
3,567,408, PUB. 11-11-2008. INT. CL. 16.
- SEARS BRANDS, LLC, HOFFMAN ESTATES, IL, JS TOOL
COMPANY, INC., ATLANTA, GA:
1,108,406, REN. 12-20-08. INT. CL. 7.
- SEATTLE DOWNTOWN ASSOCIATION, SEATTLE, WA:
2,546,847, CANC. INT. CL. 41.
- SECURE CONSTRUCTION SYSTEMS L.C, WEST PALM
BEACH, FL:
2,546,770, CANC. INT. CL. 19.
- SECURELOGIX CORPORATION, SAN ANTONIO, TX:
2,548,348, CANC. INT. CL. 9.
- SECUREPIPE COMMUNICATIONS LLC, TROY, VA:
2,546,467, CANC. MULTIPLE CLASS, INT. CLS. 9 AND
42.
- SECURIS CORPORATION, SEATTLE, WA:
2,208,171, REN. 12-24-08. INT. CL. 9.
- SEE-PRO, LLC, LAKELAND, LA:
2,548,430, CANC. INT. CL. 5.
2,548,431, CANC. INT. CL. 5.
- SEED AND LIGHT INTERNATIONAL, ALBUQUERQUE,
NM:
3,567,250, PUB. 11-11-2008. INT. CL. 36.
- SEED CORPS, THE, SANTA ROSA, CA:
1,481,041, CANC. INT. CL. 36.
- SEEFELD, MATT, ENCINITAS, CA:
3,568,112, MULTIPLE CLASS, INT. CLS. 35 AND 42.
- SEEK EDUCATION, INC., SAN GABRIEL, CA:
3,566,492, PUB. 11-11-2008. INT. CL. 44.
- SEGA ENTERTAINMENT U.S.A., INC., GLENDALE, CA:
2,548,447, CANC. INT. CL. 42.
- SEIKO HOLDINGS KABUSHIKI KAISHA, TOKYO, JAPAN,
TA SEIKO HOLDINGS CORPORATION:
2,145,471, CANC. INT. CL. 14.
- SELECT BRANDS, INC., CHICAGO, IL:
2,144,246, CANC. INT. CL. 30.

- SELECT MY SPACE, BIRMINGHAM, AL:
3,566,324, PUB. 11-11-2008. INT. CL. 36.
- SELLS GOALKEEPER PRODUCTS LIMITED, LONDON,
UNITED KINGDOM:
3,568,593, MULTIPLE CLASS, INT. CLS. 18, 25 AND 28.
- SEMI-BULK SYSTEMS, INC., FENTON, MO:
2,261,406. REN. 12-19-08. INT. CL. 7.
- SEMINOLE NIGHT CLUB, LLC, WASHINGTON, DC:
3,567,741, PUB. 11-11-2008. INT. CL. 41.
- SENIOR CARE DEVELOPMENT, LLC, NORTH BRAN-
FORD, CT:
2,145,393, CANC. MULTIPLE CLASS, INT. CLS. 35, 37
AND 42.
- SENSIBLE SOLUTIONS, LLC, GRANITE BAY, CA:
2,547,834, CANC. INT. CL. 24.
- SENSIENT FLAVORS MEXICO, S.A. DE C.V., MILWAUKEE,
WI:
2,145,083, CANC. INT. CL. 30.
- SENSIRION AG, 8052 ZURICH, SWITZERLAND:
2,546,161, CANC. MULTIPLE CLASS, INT. CLS. 9 AND
42.
- SENSORMEDICS CORPORATION, YORBA LINDA, CA:
2,144,005, CANC. INT. CL. 10.
- SENTRUS GROUP, INC., COLORADO SPRINGS, CO:
3,567,084, PUB. 11-11-2008. INT. CL. 35.
- SENTRY CHEMICAL COMPANY, ATLANTA, GA:
2,659,870, CANC. MULTIPLE CLASS, INT. CLS. 9 AND
37.
- SERENDIPITY 3, INC., NEW YORK, NY:
2,545,977, CANC. INT. CL. 30.
- SERMO, INC., CAMBRIDGE, MA:
3,568,647, MULTIPLE CLASS, INT. CLS. 35, 38 AND 42.
- SEROPIAN, HAGOP SEVAG, NICOSIA, CYPRUS:
3,568,618, INT. CL. 41.
- SERTA, INC., HOFFMAN ESTATES, IL:
2,239,866. REN. 12-20-08. INT. CL. 20.
- SERVICES GROUP OF AMERICA, INC., SCOTTSDALE, AZ:
3,568,036, INT. CL. 35.
3,568,037, INT. CL. 35.
- SERVISAIR GMBH, DUSSELDORF, FED REP GERMANY:
2,545,576, CANC. MULTIPLE CLASS, INT. CLS. 37 AND
42.
- SESTECH INTERNATIONAL, LLC, LOS ANGELES, CA:
2,546,839, CANC. INT. CL. 35.
- SEVEN DAYS PUBLISHING LLC, LONG BEACH, CA:
3,568,163, INT. CL. 16.
- SEWING CENTER SUPPLY CO., INC., PORTLAND, OR:
2,145,472, CANC. INT. CL. 23.
- SEYFARTH SHAW, CHICAGO, IL:
2,546,148, CANC. MULTIPLE CLASS, INT. CLS. 16 AND
41.
- SHABAZZ, ABDUL HAKIM R., HENDERSON, NV:
3,566,352, PUB. 11-11-2008. INT. CL. 37.
- SHAHEED, ABDUL A., SILVER SPRING, MD:
3,566,272, PUB. 11-11-2008. INT. CL. 27.
- SHAKLEE CORPORATION, PLEASANTON, CA:
2,548,310, CANC. INT. CL. 5.
- SHAMROCK BROADCASTING, INC., BURBANK, CA:
1,481,082, CANC. INT. CL. 38.
- SHANNAHAN, TIM, E., SAN DIEGO, CA:
2,547,442, CANC. INT. CL. 42.
- SHAPE UP AMERICA!, BETHESDA, MD:
2,547,909, CANC. INT. CL. 42.
- SHAPEMASTER USA, INC., TULSA, OK:
3,566,946, PUB. 11-11-2008. INT. CL. 41.
- SHARP KABUSHIKI KAISHA, OSAKA 545-8522, JAPAN, TA
SHARP CORPORATION:
3,568,030, INT. CL. 11.
- SHARPER IMAGE CORPORATION, SAN FRANCISCO, CA:
2,546,722, CANC. INT. CL. 20.
- SHAW INDUSTRIES GROUP, INC., DALTON, GA:
3,567,792, PUB. 11-11-2008. INT. CL. 22.
- SHAW-ROSS INTERNATIONAL IMPORTERS, INC., MIA-
MI, FL:
1,481,005, CANC. INT. CL. 33.
- SHE-EDISON, LLC, AURORA, CO:
3,566,903, PUB. 11-11-2008. INT. CL. 8.
- SHEARDIGITAL INC., AUSTIN, TX, DBA GRAVITANT,
INC.:
3,568,728, INT. CL. 9.
- SHEN SHYE METAL MANUFACTURING CO., LTD.,
CHANG HUA HSIEN, TAIWAN:
2,548,202, CANC. INT. CL. 12.
- SHENYANG JINLONG HEALTH CARE PRODUCTS CO.,
LTD., SHENYANG, CHINA:
2,545,776, CANC. INT. CL. 5.
- SHENZHEN SUNZONE ELECTRICAL APPLIANCES LTD.,
SHENZHEN, CHINA:
3,568,039, INT. CL. 11.
- SHEPHERDS OF THE STRAND, INC., MCLEAN, VA:
1,481,135, CANC. INT. CL. 42.
- SHERWOOD IMS, INC., CARLSBAD, CA:
1,480,505, CANC. INT. CL. 9.
- SHETLER STAINLESS STEEL HOUSEWARES, GENEVA, IN:
3,568,533, INT. CL. 21.
- SHIFF FAMILY, LLC, SAN FRANCISCO, CA:
3,567,649, PUB. 11-11-2008. MULTIPLE CLASS, INT. CLS.
36 AND 37.
- SHIN KWANG INDUSTRIAL CO., LTD., CHUNG CHEONG
NAM-DO, 336-820, REPUBLIC OF KOREA:
2,547,553, CANC. INT. CL. 12.
- SHIN-ETSU HANDOTAI CO., LTD., CHIYODA-KU, TO-
KYO, JAPAN:
2,546,271, CANC. INT. CL. 9.
- SHINAS, GEORGE, VICTORIA, AUSTRALIA:
3,567,032, PUB. 11-11-2008. INT. CL. 33.
- SHINDAIWA, INC., TUALATIN, OR:
3,567,026, PUB. 11-11-2008. INT. CL. 7.
- SHINING SHAKTI, SAN FRANCISCO, CA:
3,566,826, PUB. 11-11-2008. INT. CL. 25.
- SHINKAWA, PAUL, HONOLULU, HI:
2,546,941, CANC. INT. CL. 14.
- SHISEIDO COMPANY, LTD., TOKYO, JAPAN:
2,547,954, CANC. MULTIPLE CLASS, INT. CLS. 41 AND
42.
- SHMAKOFF, CARL N., TWENTYNINE PALMS, CA:
2,206,643, REN. 12-20-08. INT. CL. 7.
- SHOCKWAVE PICTURES, LLC, OAKLAND, CA:
2,545,914, CANC. INT. CL. 41.
- SHURE INCORPORATED, NILES, IL:
2,548,106, CANC. INT. CL. 9.
- SHURGARD STORAGE CENTERS, LLC, GLENDALE, CA:
3,568,598, INT. CL. 16.
- SI.CLA S.R.L., UDINE, ITALY:
2,545,789, CANC. INT. CL. 3.
- SIAI S.R.L. SOCIETA ITALIANA ABRASIVI INDUSTRIALI,
BOLLATE, MILAN, ITALY:
1,480,371, CANC. INT. CL. 3.
- SICA, DANIELE, SALERNO, ITALY:
3,568,691, INT. CL. 41.
- SICHUAN QINGXIANGYUAN FLAVORING; CORPORA-
TION, CHINA:
3,567,913, PUB. 11-11-2008. INT. CL. 30.
- SIDDIQUI, WASIF, CHINO, CA:
2,547,781, CANC. INT. CL. 11.
- SIEMENS AKTIENGESELLSCHAFT, MUNICH, FED REP
GERMANY:
2,545,657, CANC. MULTIPLE CLASS, INT. CLS. 35, 37
AND 42.
- SIEMENS AKTIENGESELLSCHAFT, MUNICH, FED REP
GERMANY:
2,545,638, CANC. MULTIPLE CLASS, INT. CLS. 9 AND
42.
- SIEMENS AKTIENGESELLSCHAFT, FED REP GERMANY:
3,567,909, PUB. 11-11-2008. INT. CL. 35.
- SIEMENS AUDIOLOGISCHE TECHNIK GMBH, FED REP
GERMANY:
3,567,981, PUB. 11-11-2008. INT. CL. 10.
- SIEMENS NIXDORF INFORMATIONSSYSTEME AG, PA-
DERBORN, FED REP GERMANY:
2,545,541, CANC. MULTIPLE CLASS, INT. CLS. 9 AND
42.
- SIEMON COMPANY, THE, WATERTOWN, CT:
2,548,307, CANC. INT. CL. 36.

- SIERRA ON-LINE, INC., LOS ANGELES, CA:
2,548,154, CANC. INT. CL. 9.
- SIGMA PERFORMANCE SOLUTIONS, INC., HUNT VALLEY, MD, CUSTOMER SERVICE PROGRAMS, INC., RESTON, VA:
1,487,857, REN. 12-19-08. INT. CL. 41.
- SIGMA-ALDRICH BIOTECHNOLOGY L.P., ST. LOUIS, MO:
3,568,388, MULTIPLE CLASS, INT. CLS. 1 AND 5.
- SIGMA-TAU INDUSTRIE FARMACEUTICHE RIUNITE S.P.A., ROME 00147, ITALY:
2,545,517, CANC. INT. CL. 5.
- SIGMA-TAU INDUSTRIE FARMACEUTICHE RIUNITE S.P.A., ITALY:
2,545,530, CANC. INT. CL. 5.
- SIGNAL INVESTMENT & MANAGEMENT CO., WILMINGTON, DE:
3,566,783, PUB. 11-11-2008. INT. CL. 5.
- SIGNCO, LINCOLN, NE:
3,567,552, PUB. 11-11-2008. MULTIPLE CLASS, INT. CLS. 9, 19 AND 40.
- SIGTRAN CONSULTING, BELLEVUE, WA, DBA SPARK-BLISS:
3,568,764, INT. CL. 45.
- SIKA SARNAFIL, INC., CANTON, MA:
2,548,038, CANC. INT. CL. 19.
- SILICONE SPECIALITIES, INC., TULSA, OK:
3,566,968, PUB. 11-11-2008. MULTIPLE CLASS, INT. CLS. 1 AND 19.
- SILK ROAD TECHNOLOGY, INC., WINSTON-SALEM, NC:
2,546,891, CANC. INT. CL. 42.
- SILVER CROSS HOLDINGS LIMITED, BROUGHTON, SKIPTON, UNITED KINGDOM:
3,567,901, PUB. 11-11-2008. INT. CL. 20.
- SILVERFLASH, INC., LA JOLLA, CA:
2,144,539, CANC. MULTIPLE CLASS, INT. CLS. 9 AND 41.
- SIMCO INDUSTRIES, INC., ROSEVILLE, MI:
1,480,466, CANC. INT. CL. 7.
- SIMON WIESENTHAL CENTER, LOS ANGELES, CA:
3,568,132, INT. CL. 41.
3,568,133, INT. CL. 41.
- SIMONSKI, PHILIP G., BAKER CITY, OR, DBA POWDER RIVER TACKLE CO.:
2,546,999, CANC. INT. CL. 28.
- SIMPLE PLEASURES FLOWERBULBS & PERENNIALS, INC., W. BABYLON, NY, SIMPLE PLEASURES FLOWERBULBS & PERENNIALS, INC., W. BABYLON, NY:
2,219,473, REN. 12-19-08. INT. CL. 31.
- SIMPLETECH, INC., SANTA ANA, CA:
2,548,391, CANC. INT. CL. 9.
- SIMPSON STRONG-TIE COMPANY, INC., PLEASANTON, CA:
2,145,055, CANC. INT. CL. 6.
- SIMPSON, WILLIAM E., LAKE OSWEGO, OR:
2,545,692, CANC. INT. CL. 9.
- SIMU, F-70100 GRAY, FRANCE:
3,567,911, PUB. 11-11-2008. MULTIPLE CLASS, INT. CLS. 7 AND 9.
- SIMULA, INC., PHOENIX, AZ:
2,548,453, CANC. INT. CL. 9.
- SINCLAIR, LISBETH K., LOS ANGELES, CA:
3,568,677, INT. CL. 42.
- SINGER, JESSICA M., SALT LAKE CITY, UT AND SINGER, STANFORD A., SALT LAKE CITY, UT:
3,567,068, PUB. 11-11-2008. INT. CL. 35.
- SINGH, RAJESH PRATAP, NEW DELHI, INDIA:
3,566,774, PUB. 11-11-2008. INT. CL. 25.
- SINNESLOSCHEN, LLC, DALLAS, TX:
3,568,487, INT. CL. 9.
- SINNOTT, JOHN, HORSHAM, PA:
2,548,251, CANC. INT. CL. 16.
- SINTERMASK TECHNOLOGIES AKTIEBOLAG, SWEDEN:
3,567,931, PUB. 11-11-2008. MULTIPLE CLASS, INT. CLS. 1, 9, 11 AND 40.
- SITEPEN, INC., PALO ALTO, CA:
3,566,558, PUB. 11-11-2008. INT. CL. 42.
- SITOA CORPORATION, SAN MATEO, CA:
3,567,782, PUB. 11-11-2008. INT. CL. 35.
- SIX FLAGS THEME PARKS, INC., OKLAHOMA CITY, OK:
2,548,352, CANC. INT. CL. 41.
- SJF CORP., TEMPE, AZ:
2,547,178, CANC. INT. CL. 30.
- SJOMAN BJORN CORPORATION, BOCA RATON, FL:
3,567,493, PUB. 11-11-2008. INT. CL. 9.
- SKI MARKET LTD., INC., THE, WELLESLEY, MA:
1,516,818, REN. 12-20-08. INT. CL. 42.
- SKIPPACK CREEK CORPORATION, WILMINGTON, DE:
3,568,229, INT. CL. 29.
- SKY KIDS, INC., CRESSKILL, NY:
2,547,112, CANC. INT. CL. 28.
- SKY KIDS, INC., CRESSKILL, NJ:
2,547,113, CANC. INT. CL. 28.
2,547,115, CANC. INT. CL. 28.
- SKY W NETWORK INC., MOSES LAKE, WA:
2,547,273, CANC. INT. CL. 29.
- SLENDER GOURMENT, INC., ROCKVILLE, MD:
1,480,963, CANC. MULTIPLE CLASS, INT. CLS. 30 AND 42.
- SLOAN VALVE COMPANY, FRANKLIN AVENUE, IL:
3,568,695, INT. CL. 11.
- SLOWINSKI, CHRISTOPHER, NEW YORK, NY AND SCHINDLER, ERNIE ISAAC, NEW YORK, NY:
2,548,207, CANC. INT. CL. 9.
- SM SUMMIT HOLDINGS LIMITED, SINGAPORE:
2,545,833, CANC. INT. CL. 9.
- SMART BEAUTY HOLDINGS LIMITED, DOUGLAS, UNITED KINGDOM:
3,568,655, INT. CL. 3.
- SMARTMONEY, NEW YORK, NY:
2,548,127, CANC. INT. CL. 9.
- SMARTPORTFOLIO.COM, INC., LAKELAND, FL:
2,546,005, CANC. MULTIPLE CLASS, INT. CLS. 35 AND 36.
- SMED INTERNATIONAL INC., CALGARY, ALBERTA, T2C 2A2, CANADA:
2,545,504, CANC. INT. CL. 20.
2,545,505, CANC. INT. CL. 20.
- SMILEY, KAREN, ATLANTA, GA:
3,567,748, PUB. 11-11-2008. INT. CL. 43.
- SMITH & NEPHEW, INC., MEMPHIS, TN:
2,217,466, REN. 12-20-08. INT. CL. 2.
- SMITH & VANDIVER, INC., WATSONVILLE, CA:
2,546,857, CANC. INT. CL. 3.
- SMITH, BOBBY C., JENNINGS, LA:
2,548,270, CANC. INT. CL. 35.
- SMITH, BYRON WAYNE, SILSBEE, TX:
2,548,524, CANC. INT. CL. 38.
- SMITH, JEANENE, CRANBERRY TOWNSHIP, PA:
2,144,563, CANC. INT. CL. 14.
- SMITH, ROBERT W., GULF BREEZE, FL:
2,546,954, CANC. INT. CL. 35.
2,546,956, CANC. INT. CL. 35.
2,546,957, CANC. INT. CL. 35.
2,546,958, CANC. INT. CL. 35.
2,546,959, CANC. INT. CL. 35.
2,546,960, CANC. INT. CL. 35.
2,546,962, CANC. INT. CL. 35.
- SMITHKLINE BEECHAM CORPORATION, PHILADELPHIA, PA:
2,548,105, CANC. INT. CL. 21.
- SMITHS MEDICAL ASD, INC., KEENE, NH:
1,556,694, REN. 12-22-08. INT. CL. 10.
2,169,649, REN. 12-20-08. INT. CL. 10.
- SMITHS MEDICAL MD, INC., ST. PAUL, MN:
1,547,216, REN. 12-22-08. INT. CL. 10.
- SMT MACHINE AB, S-721 22 VASTERAS, SWEDEN:
2,144,219, CANC. INT. CL. 7.
- SMURFIT-STONE CONTAINER CORPORATION, CHICAGO, IL:
2,547,625, CANC. INT. CL. 17.
- SMUTKO, MATTHEW, GARDEN CITY SOUTH, NY:
2,546,792, CANC. INT. CL. 41.
- SNAP-ON INCORPORATED, KENOSHA, WI:
2,195,210, REN. 12-20-08. INT. CL. 9.
- SNAPPLE BEVERAGE CORP, RYE BROOK, NY:
2,546,639, CANC. INT. CL. 30.

- SNAPPLE BEVERAGE CORP., RYE BROOK, NY:
2,546,638, CANC. INT. CL. 30.
- SNELL & WILMER L.L.P., PHOENIX, AZ:
2,218,920. REN. 12-20-08. INT. CL. 42.
- SNOW PEAK U.S.A., INC., LAKE OSWEGO, OR:
2,547,757, CANC. MULTIPLE CLASS, INT. CLS. 4 AND 11.
- SNYDER, DAVID, EAGLE ROCK, CA AND SNYDER, NJERI, EAGLE ROCK, CA:
3,568,150, INT. CL. 28.
- SOCIETE BIC, CLICHY, FRANCE:
2,145,178, CANC. INT. CL. 16.
- SOCIETE DES PRODUITS NESTLE S. A., CH-1800 VEVEY, SWITZERLAND:
2,209,131. REN. 12-20-08. INT. CL. 30.
- SOCIETE DES PRODUITS NESTLE S.A., 1800 VEVEY, SWITZERLAND, NESTLE COMPANY, INC., THE, WHITE PLAINS, NY:
1,110,632. REN. 12-20-08. INT. CL. 30.
- SOCIETE DES PRODUITS NESTLE S.A., 1800 VEVEY, SWITZERLAND:
1,113,733. REN. 12-20-08. INT. CL. 30.
2,213,495. REN. 12-20-08. INT. CL. 30.
- SOCIETE DES PRODUITS NESTLE S.A., VEVEY, SWITZERLAND:
3,509,743, COR. INT. CL. 31.
- SOCIETE DES PRODUITS NESTLE, S.A., 1800 VEVEY, SWITZERLAND:
1,076,090. REN. 12-23-08. INT. CL. 30.
- SOCIETY FOR HUMAN RESOURCE MANAGEMENT, ALEXANDRIA, VA:
3,568,021, INT. CL. 41.
- SOCIETY INSURANCE, A MUTUAL COMPANY, FOND DU LAC, WI:
1,563,780. REN. 12-22-08. INT. CL. 36.
- SOCIETY INSURANCE, A MUTUAL COMPANY, FOND DU LAC, WI, THRESHERMEN'S MUTUAL INSURANCE COMPANY, FOND DU LAC, WI:
1,568,805. REN. 12-22-08. INT. CL. 36.
- SOCOMECA (SA), 67230 BENFELD, FRANCE:
2,210,663. REN. 12-22-08. INT. CL. 9.
2,210,664. REN. 12-22-08. INT. CL. 9.
- SODA BY AMY, LLC, CHICAGO, IL:
3,568,451, MULTIPLE CLASS, INT. CLS. 21 AND 27.
- SODEXHO MARRIOTT SERVICES, INC., BETHESDA, MD:
2,547,667, CANC. INT. CL. 42.
- SODINI, JIM, WINTON, CA. DBA TNO ENTERPRISES:
3,566,462, PUB. 7-29-2008. MULTIPLE CLASS, INT. CLS. 16 AND 25.
- SOFA CONNECTION, INC., MADISON, TN:
2,547,160, CANC. INT. CL. 20.
- SOFINA FOODS INC./ALIMENTS SOFINA INC., BRAMPTON, ONTARIO, CANADA:
2,545,635, CANC. INT. CL. 29.
- SOFON B.V., NL-5692 EG SON, NETHERLANDS:
3,567,870, PUB. 11-11-2008. MULTIPLE CLASS, INT. CLS. 9, 35 AND 42.
- SOFTEYES, INC., WEST DES MOINES, IA:
2,546,482, CANC. INT. CL. 9.
- SOFTWARE SCIENTIFIC CORP., BROOKLYN, NY:
2,547,629, CANC. INT. CL. 9.
- SOLAMATRIX, INC., SAINT PETERSBURG, FL:
3,567,199, PUB. 11-11-2008. INT. CL. 17.
- SOLARAIRE, LLC, FOLSOM, CA:
3,567,350, PUB. 11-11-2008. INT. CL. 37.
- SOLDADORAS INUDSTRIALES INFRA, S.A. D.E. C.V., ESTADO DE MEXICO, MEXICO:
2,202,053. REN. 12-20-08. INT. CL. 7.
- SOLERA COMMUNITY CHURCH, INC., SUNRISE, FL, DBA COVENANT LIFE CHRISTIAN CHURCH, INC.:
3,566,730, PUB. 11-11-2008. INT. CL. 41.
- SOLI MIZRAHI, BROOKLYN, NY AND ELI MIZRAHI, BROOKLYN, NY:
3,567,448, PUB. 11-11-2008. INT. CL. 9.
- SOLJA LIFE RECORD INC., BRIDGE HAMPTON, NY:
3,568,004, INT. CL. 41.
- SOLOMON, DAVID, HAMPSTEAD, MD AND SOLOMON, CAROLYN, HAMPSTEAD, MD:
2,685,926, CANC. INT. CL. 42.
- SOLVAY, BRUSSELS, BELGIUM:
1,480,416, CANC. INT. CL. 5.
- SOLVAY PHARMACEUTICALS B.V., WEESP, NETHERLANDS:
3,566,424, PUB. 11-11-2008. INT. CL. 5.
3,566,425, PUB. 11-11-2008. INT. CL. 5.
3,566,426, PUB. 11-11-2008. INT. CL. 5.
3,566,427, PUB. 11-11-2008. INT. CL. 5.
3,566,428, PUB. 11-11-2008. INT. CL. 5.
- SOMERA, ANTONIO, STOCKTON, CA:
3,566,954, PUB. 11-11-2008. INT. CL. 41.
- SONNY'S ENTERPRISES, INC., TAMARAC, FL:
3,566,642, PUB. 11-11-2008. INT. CL. 7.
- SONY KABUSHIKI KAISHA, TOKYO-141, JAPAN, TA SONY CORPORATION:
2,159,379. REN. 12-20-08. INT. CL. 9.
- SONY KABUSHIKI KAISHA, TOKYO 141, JAPAN, TA SONY CORPORATION:
2,213,402. REN. 12-22-08. INT. CL. 9.
- SONY KABUSHIKI KAISHA, TOKYO, JAPAN, TA SONY CORPORATION:
2,547,641, CANC. INT. CL. 9.
- SOREMARTEC S.A., BELGIUM:
3,567,902, PUB. 11-11-2008. MULTIPLE CLASS, INT. CLS. 29, 30, 32 AND 33.
- SORENSEN, JEFFREY DEAN, SCOTTSDALE, AZ:
3,566,871, PUB. 11-11-2008. INT. CL. 16.
- SORENSEN BIOSCIENCE, INC., SALT LAKE CITY, UT:
3,566,357, PUB. 11-11-2008. INT. CL. 9.
- SOTR, LLC, NORTHFIELD, OH:
3,566,950, PUB. 11-11-2008. INT. CL. 30.
- SOURCE ONE DISTRIBUTORS, INC., WELLINGTON, FL:
3,566,304, PUB. 11-11-2008. INT. CL. 35.
3,566,309, PUB. 11-11-2008. INT. CL. 35.
- SOUTH CAROLINA EDUCATION LOTTERY COMMISSION, COLUMBIA, SC:
3,567,495, PUB. 11-11-2008. INT. CL. 41.
- SOUTHCO, INC., CONCORDVILLE, PA:
2,547,597, CANC. INT. CL. 6.
- SOUTHERN CROSS BIOTECH PTY LIMITED, TOORAK, VICTORIA 3142, AUSTRALIA:
2,545,614, CANC. INT. CL. 5.
- SOUTHERN FAIRFIELD COUNTY BODY SHOP ASSOCIATION, INC., DARIEN, CT:
2,144,039, CANC. INT. CL. 42.
- SOUTHERN MERCHANDISING GROUP, INC., NORCROSS, GA:
2,546,775, CANC. INT. CL. 35.
- SOUTHERN SUN TEAS (PRIVATE) LIMITED, COLOMBO 4, SRI LANKA:
3,567,713, PUB. 11-11-2008. INT. CL. 30.
- SOUTHERN THERAPY, INC. (STY), AUSTIN, TX:
2,545,727, CANC. INT. CL. 12.
- SOUTHWEST RESEARCH INSTITUTE, SAN ANTONIO, TX:
2,208,164. REN. 12-22-08. U.S. CL. A.
- SPACE COAST WORLD TRADE COUNCIL, INC., MERRITT ISLAND, FL:
2,546,968, CANC. INT. CL. 41.
- SPACE CONTROL INDUSTRIES, D-82284 GRAFRATH, FED REP GERMANY:
2,546,079, CANC. INT. CL. 9.
- SPACEBOUND, INC., AVON, OH:
2,546,067, CANC. INT. CL. 35.
- SPACELABS MEDICAL, INC., REDMOND, WA:
2,547,861, CANC. INT. CL. 9.
- SPANISH GOLF ADVENTURES, INC., VIRGINIA BEACH, VA:
2,545,885, CANC. INT. CL. 39.
- SPARBOE FARMS, INC., LITCHFIELD, MN:
3,568,400, INT. CL. 29.
- SPARE SOME FOR AUTISM, INC., RALEIGH, NC:
3,567,401, PUB. 11-11-2008. INT. CL. 36.
- SPATIAL TECHNOLOGY, INC., BOULDER, CO:
2,548,540, CANC. INT. CL. 9.

SPECIALIZED BICYCLE COMPONENTS, INC., MORGAN HILL, CA:
3,568,492, INT. CL. 12.

SPERIAN EYE & FACE PROTECTION, INC., SMITHFIELD, RI, UVEX WINTER OPTIK GMBH, FURTH/BAY, FED REP GERMANY:
1,486,802, REN. 12-23-08. INT. CL. 9.

SPERIAN EYE & FACE PROTECTION, INC., SMITHFIELD, RI:
2,215,172, REN. 12-19-08. INT. CL. 9.

SPERZEL, ROBERT J., CLEVELAND, OH:
2,203,910, REN. 12-24-08. INT. CL. 15.

SPINEART S.A., SWITZERLAND:
3,567,845, PUB. 11-11-2008. INT. CL. 10.

SPIRIT SPORTSWEAR, INC., NEW YORK, NY:
2,546,259, CANC. INT. CL. 25.

SPONG, DOUGLAS BENSON, ISLE OF CAPRI, QUEENSLAND, AUSTRALIA:
2,546,516, CANC. INT. CL. 9.

SPORTS WIDOW ENTERTAINMENT LLC, SEATTLE, WA:
3,568,569, INT. CL. 41.

SPORTSUSA GROUP, INC., SEMINOLE, FL:
2,548,629, CANC. INT. CL. 16.
2,548,630, CANC. INT. CL. 16.

SPRAGINS, ELLYN, PENNINGTON, NJ:
3,567,141, PUB. 11-11-2008. INT. CL. 38.

SPRING AIR IP HOLDING, LLC, ELK GROVE VILLAGE, IL:
2,548,360, CANC. INT. CL. 20.

SPRING HILL NURSERIES LLC, GUILFORD, IN:
2,209,529, REN. 12-22-08. INT. CL. 31.

SPRINGS GLOBAL US, INC., FORT MILL, SC:
2,144,581, CANC. INT. CL. 20.
2,145,188, CANC. INT. CL. 24.

SPX CORPORATION, CHARLOTTE, NC:
2,245,256, REN. 12-20-08. INT. CL. 9.

SPYVILLE, LLC, MONTEREY, TN:
3,566,274, PUB. 11-11-2008. INT. CL. 45.

SQUARE D COMPANY, PALATINE, IL:
2,546,979, CANC. INT. CL. 9.

SRYGLEY, PAUL DEAN, VISTA, CA:
2,547,460, CANC. INT. CL. 5.

SSC GROUP, LLC, WOODLAND HILLS, CA:
3,566,875, PUB. 11-11-2008. INT. CL. 41.

ST ANDREWS LINKS LIMITED, FIFE, UNITED KINGDOM:
3,566,400, PUB. 11-11-2008. MULTIPLE CLASS, INT. CLS. 7, 37, 42 AND 44.

ST. CAMILLE, MARC, CHICAGO, IL:
3,566,791, PUB. 11-11-2008. MULTIPLE CLASS, INT. CLS. 9, 41, 44 AND 45.

ST. LOUIS RAMS PARTNERSHIP, ST. LOUIS, MO:
3,568,042, INT. CL. 25.

ST. LOUIS TAG CO., INC., ST. LOUIS, MO:
2,546,566, CANC. INT. CL. 40.

STACIA, INC., SANTA MONICA, CA:
2,545,920, CANC. MULTIPLE CLASS, INT. CLS. 18, 25 AND 35.

STAFFME.NET, LLC., KNOXVILLE, TN:
3,566,838, PUB. 11-11-2008. INT. CL. 9.

STAFFORD-MILLER (IRELAND) LIMITED, DUNGARVAN, IRELAND:
2,582,408, CANC. INT. CL. 21.

STAKARE, KANSAS CITY, MO:
2,205,692, REN. 12-19-08. INT. CL. 42.

STAM, HERBERT H., WATSEKA, IL, DBA HI-PRO MFG.:
2,546,799, CANC. INT. CL. 7.

STANCO MANUFACTURING, INC., ATLANTA, TX:
2,547,643, CANC. INT. CL. 9.

STANFORD, DEWITT, IRVINE, CA:
2,547,434, CANC. INT. CL. 42.

STANGL/FULPER COLLECTORS CLUB, FLEMINGTON, NJ:
2,545,910, CANC. MULTIPLE CLASS, INT. CLS. 35, 41 AND 42.

STANLEY LOGISTICS, INC., NEW BRITAIN, CT:
2,547,930, CANC. INT. CL. 20.

STANLEY LOGISTICS, L.L.C., NEW BRITAIN, CT:
1,514,478, REN. 12-23-08. INT. CL. 9.
2,204,396, REN. 12-23-08. INT. CL. 8.

STARBUCKS U.S. BRANDS, LLC, MINDEN, NV:
2,258,080, REN. 12-20-08. INT. CL. 30.

STARGAYZER, INC, CHARLOTTE, NC:
3,568,010, INT. CL. 41.
3,568,011, INT. CL. 41.

STARKEY LABORATORIES, INC., EDEN PRAIRIE, MN:
3,566,797, PUB. 11-11-2008. INT. CL. 9.

STARTEK, INC., DENVER, CO:
2,545,685, CANC. MULTIPLE CLASS, INT. CLS. 35 AND 42.

STATE EMPLOYEES' CREDIT UNION, RALEIGH, NC:
3,568,495, INT. CL. 36.

STATEWIDE SUPPLY, INC., DANE, WI:
3,566,951, PUB. 11-11-2008. INT. CL. 3.

STATIONERY STATION, LTD., HIGHLAND PARK, IL:
1,530,274, REN. 12-19-08. INT. CL. 42.

STAUNTON CAPITAL INCORPORATED, GASTONIA, NC, DBA RWM CASTERS COMPANY:
2,548,124, CANC. INT. CL. 6.

STEINBACH GERHARD, FED REP GERMANY:
3,567,932, PUB. 11-11-2008. MULTIPLE CLASS, INT. CLS. 12, 36 AND 45.

STEINBERG, MARTHA JEAN, DETROIT, MI:
1,514,986, REN. 12-19-08. INT. CL. 42.

STEMMLER, CAROLINE, DOROTHY, GAINESVILLE, GA:
2,547,446, CANC. INT. CL. 24.

STEMPNOWSKI, RICHARD H, FORT MYERS, FL:
3,568,311, INT. CL. 21.

STENOGRAPH, L.L.C., MT. PROSPECT, IL:
2,145,277, CANC. INT. CL. 9.

STEPAN COMPANY, NORTHFIELD, IL:
660,216, REN. 12-23-08. U.S. CL. 52 (INT. CL. 3).

STEPHEN J. TAYLOR, APPLE VALLEY, CA:
3,567,223, PUB. 11-11-2008. INT. CL. 11.

STEPHENS, SCOTT, ENCINITAS, CA:
2,545,904, CANC. INT. CL. 41.

STERIL-AIRE, INC., BURBANK, CA:
3,568,370, INT. CL. 11.

STERIS INC., TEMECULA, CA:
3,568,192, MULTIPLE CLASS, INT. CLS. 37 AND 42.

STERLING CANDY CORP., MOONACHIE, NJ:
1,480,952, CANC. INT. CL. 30.

STERN, KATE, SANTA MONICA, CA:
2,548,635, CANC. INT. CL. 8.

STEUBER CORPORATION, LONG BEACH, CA, DBA ALTA OFFICE SERVICES:
2,219,628, REN. 12-19-08. INT. CL. 42.

STEVEN J CAUCHI, AUSTRALIA:
3,567,971, PUB. 11-11-2008. INT. CL. 25.

STEVENS, CHARLES, VALLEY CENTER, KS:
2,545,887, CANC. INT. CL. 25.

STICKS AND STRINGS, LLC, SCARSDALE, NY:
3,567,544, PUB. 11-11-2008. MULTIPLE CLASS, INT. CLS. 35 AND 41.

STILLE SURGICAL AKTIEBOLAG, SE-171 73 SOLNA, SWEDEN:
3,567,959, PUB. 11-11-2008. INT. CL. 10.

STOCKWALK.COM, INC., MINNEAPOLIS, MN:
2,545,951, CANC. INT. CL. 36.

STONECUSHION, INC., HEALDSBURG, CA:
1,512,983, REN. 12-19-08. INT. CL. 33.

STORAGE CONCEPTS, INC., TUSTIN, CA:
2,547,839, CANC. INT. CL. 9.

STORANDT PANN MARGOLIS, INC., LA GRANGE, IL:
3,568,220, INT. CL. 44.

STORE, MATAKOVICH & WOLFBERG, SOUTH EL MONTE, CA:
2,547,040, CANC. INT. CL. 42.

STORM INTERIORS, SANTA MONICA, CA:
3,567,208, PUB. 11-11-2008. INT. CL. 42.

STOWE WOODWARD, LLC, WESTBOROUGH, MA:
3,568,440, INT. CL. 7.

STRADA SHOE LIMITADA, CAMPO BOM - RS, BRAZIL:
3,566,583, PUB. 11-11-2008. INT. CL. 25.

STRAKA, REGIS, JEFFERSON BORO, PA AND LYTLE, ROBERT, COLUMBUS, OH:
2,144,369, CANC. INT. CL. 31.

- STRANGER & STRANGER LIMITED, LONDON, UNITED KINGDOM:
3,566,764, PUB. 11-11-2008. INT. CL. 33.
- STRATALOC TECHNOLOGY PRODUCTS LLC, HOUSTON, TX:
3,568,641, INT. CL. 7.
- STRATEGIC PLANNERS GROUP, LLC, NAPLES, FL:
3,567,459, PUB. 11-11-2008. INT. CL. 36.
3,567,479, PUB. 11-11-2008. INT. CL. 36.
- STRICTLY DIRECT, INC., DURHAM, NC:
3,567,497, PUB. 11-11-2008. INT. CL. 35.
- STRICTLY HODAKA, LLC, CHARLESTOWN, RI:
3,566,479, PUB. 11-11-2008. INT. CL. 12.
- STRIDE RITE CANADA LIMITED, CAMBRIDGE, CANADA:
3,566,662, PUB. 11-11-2008. INT. CL. 25.
- STROKIN, LLC, CHASKA, MN:
3,568,088, INT. CL. 28.
- STUTZMAN ENVIRONMENTAL PRODUCTS, INC., CANBY, OR:
2,546,309, CANC. INT. CL. 1.
- SUBSURFACE IMAGING CORPORATION, ROCHESTER, NY:
3,568,714, INT. CL. 42.
- SUCCESSFUL MONEY MANAGEMENT SEMINARS, INC., PORTLAND, OR:
1,481,101, CANC. INT. CL. 41.
- SUD-CHEMIE, INC., LOUISVILLE, KY:
2,547,656, CANC. INT. CL. 1.
- SUHRBIER, NADINE, WINCHESTER, MA:
2,144,716, CANC. INT. CL. 28.
- SUITECOMMUTE, ST. LOUIS, MO:
3,567,107, PUB. 11-11-2008. INT. CL. 35.
- SUIZA DAIRY GROUP, L.P., DALLAS, TX:
2,546,177, CANC. MULTIPLE CLASS, INT. CLS. 29 AND 32.
- SULLIVAN, DON, LA QUINTA, CA:
3,568,339, INT. CL. 41.
- SUMMERFIELD MEDIA GROUP LLC, RAYNHAM, MA, DBA PLEASANT ST. PRESS:
3,567,259, PUB. 11-11-2008. INT. CL. 16.
- SUMMIT AUTONOMOUS INC., WALTHAM, MA:
2,548,096, CANC. INT. CL. 9.
- SUMMIT OIL CO., INC., TYLER, TX:
1,480,393, CANC. INT. CL. 4.
- SUMMIT TRAINING SOURCE, INC., GRAND RAPIDS, MI:
2,235,693, REN. 12-24-08. MULTIPLE CLASS, INT. CLS. 9 AND 41.
- SUMTER ELECTRIC COOPERATIVE, INC., SUMTERVILLE, FL:
2,545,758, CANC. INT. CL. 42.
- SUN & HEALTH INTERNATIONAL LIMITED, WORCESTERSHIRE B97 5AG, ENGLAND:
2,547,576, CANC. INT. CL. 3.
- SUN CHEMICAL CORPORATION, PARSIPPANY, NJ:
2,144,111, CANC. INT. CL. 9.
- SUN DRILLING PRODUCTS CORPORATION, BELLE CHASSE, LA:
3,568,643, INT. CL. 1.
- SUN WATER SYSTEMS, INC., FORT WORTH, TX:
3,568,644, INT. CL. 35.
- SUNBEAM CORPORATION, DOWNERS GROVE, IL:
858,325, REN. 12-20-08. U.S. CL. 44 (INT. CLS. 7 AND 10).
- SUNCATCHER COMMUNITIES, LLC, GRAPEVINE, TX:
3,567,051, PUB. 11-11-2008. INT. CL. 37.
- SUNDS DEFIBRATOR LOVIISA OY, FIN-07910 VALKO, FINLAND:
2,547,491, CANC. MULTIPLE CLASS, INT. CLS. 7 AND 40.
- SUNERGY, INC., ALBUQUERQUE, NM:
3,567,398, PUB. 11-11-2008. MULTIPLE CLASS, INT. CLS. 37 AND 42.
- SUNGARD HIGHER EDUCATION INC., WILMINGTON, DE:
2,545,747, CANC. MULTIPLE CLASS, INT. CLS. 9 AND 35.
- SUNHEALTH CORPORATION, CHARLOTTE, NC:
1,481,010, CANC. MULTIPLE CLASS, INT. CLS. 35, 41 AND 42.
- SUNNI RAIN INC., SAN MARCOS, CA:
3,567,438, PUB. 11-11-2008. INT. CL. 42.
- SUNNY DISTRIBUTOR, INC., S. EL MONTE, CA:
3,567,264, PUB. 11-11-2008. MULTIPLE CLASS, INT. CLS. 10 AND 28.
- SUNNYSIDE CORPORATION, WHEELING, IL, SUNNYSIDE PRODUCTS, INC., CHICAGO, IL:
856,829, REN. 12-24-08. MULTIPLE CLASS, U.S. CLS. 6 (INT. CLS. 1, 2, 3, 4 AND 5) AND 15 (INT. CL. 4).
- SUNOPTA, INC., ONTARIO, CANADA:
3,568,227, INT. CL. 32.
- SUNPENTOWN INTERNATIONAL, INC., CITY OF INDUSTRY, CA:
2,547,472, CANC. INT. CL. 11.
- SUNSHINE GLOBAL MEDIA GROUP, LLC, MELBOURNE BEACH, FL:
3,566,708, PUB. 11-11-2008. INT. CL. 35.
- SUNSHINE MAKERS, INC., HUNTINGTON HARBOUR, CA:
3,566,516, PUB. 11-11-2008. INT. CL. 3.
- SUNWARD ELECTRONICS, INC., TROY, NY:
3,567,769, PUB. 11-11-2008. INT. CL. 9.
- SUPACHILL USA, INC., HOUSTON, TX:
2,547,955, CANC. INT. CL. 42.
- SUPER ABSORBENT COMPANY, PHOENIX, AZ:
3,567,284, PUB. 11-11-2008. INT. CL. 1.
- SUPER CREW, INC., BROOMFIELD, CO:
3,568,304, INT. CL. 36.
- SUPERIOR CIGARS USA INC., BOCA RATON, FL:
3,566,550, PUB. 11-11-2008. INT. CL. 34.
- SUPERIOR PRODUCTS, INC., CLEVELAND, OH:
2,546,947, CANC. INT. CL. 35.
- SUPRACOR SYSTEMS, INC, SAN JOSE, CA:
2,210,961, REN. 12-23-08. INT. CL. 17.
- SURCO PRODUCTS, INC., BRADDOCK, PA:
1,480,404, CANC. INT. CL. 5.
- SURE FIT INC., NEW YORK, NY:
2,547,468, CANC. INT. CL. 24.
- SURECOMP INTERNATIONAL LTD., BRIDGETOWN, BARBADOS:
3,568,164, INT. CL. 42.
- SURFACE TECHNOLOGY HOLDINGS, LTD., CINCINNATI, OH:
3,567,995, MULTIPLE CLASS, INT. CLS. 40 AND 42.
- SURFATECH CORPORATION, DACULA, GA:
3,568,560, INT. CL. 9.
- SURGICAL OUTCOME SUPPORT, INC., PALM BEACH GARDENS, FL:
3,568,175, U.S. CL. B.
- SURGIDYNE, INC., EDEN PRAIRIE, MN:
1,480,707, CANC. INT. CL. 10.
- SURMODICS, INC., EDEN PRAIRIE, MN:
2,158,020, REN. 12-22-08. INT. CL. 1.
- SURROUND TECHNOLOGIES, LLC, HACKETTSTOWN, NJ:
2,546,424, CANC. INT. CL. 9.
- SUSAN P. WALSH, NORTHVILLE, MI:
3,568,303, INT. CL. 28.
- SUSQUEHANNA VALLEY VISITORS BUREAU, LEWISBURG, PA:
3,566,927, PUB. 11-11-2008. INT. CL. 35.
- SUSTAIN DANE, INC., MADISON, WI:
3,568,753, INT. CL. 19.
- SUTER S.A.I.C.A.F.I, 5600 SAN RAFAEL, MENDOZA, ARGENTINA:
2,547,685, CANC. INT. CL. 33.
- SWALLOW PRODUCTIONS, LLC, LAS VEGAS, NV:
3,568,504, INT. CL. 41.
- SWAN KING EDITIONS, LLC, SAN FRANCISCO, CA:
3,566,851, PUB. 11-11-2008. INT. CL. 16.
- SWANK AUDIO VISUALS, L.L.C., ST. LOUIS, MO:
3,566,472, PUB. 11-11-2008. INT. CL. 41.
- SWANK, INC., NEW YORK, NY:
2,211,415, REN. 12-19-08. INT. CL. 14.
- SWANSON VINEYARDS AND WINERY, OAKVILLE, CA:
3,567,400, PUB. 11-11-2008. INT. CL. 33.

SWARTZ, KEVIN L., ELMHURST, IL:
2,545,661, CANC. INT. CL. 2.

SWATCH AG (SWATCH SA) (SWATCH LTD), SWITZERLAND:
3,567,953, PUB. 11-11-2008. MULTIPLE CLASS, INT. CLS. 14, 35 AND 37.

SWEET TIDINGS, INC., ROELAND PARK, KS:
1,480,974, CANC. INT. CL. 30.

SWINGER INTERNATIONAL S.P.A., BUSSOLENGO, VERONA, ITALY:
1,516,118, REN. 12-23-08. MULTIPLE CLASS, INT. CLS. 3 AND 18.

SWOBODA ASSOCIATES, INC., BLOOMFIELD HILLS, MI:
2,547,918, CANC. INT. CL. 21.

SYBASE, INC., DUBLIN, CA:
2,233,432, REN. 12-19-08. INT. CL. 9.

SYMBIOTIC ENGINEERING, LLC, BOULDER, CO:
3,568,757, INT. CL. 42.
3,568,760, INT. CL. 42.

SYMPATHYFOOD.COM, LLC, BOWLING GREEN, VA:
3,568,724, MULTIPLE CLASS, INT. CLS. 29, 30, 31 AND 35.

SYMPHONY VIDEO, INC., SYRACUSE, NY:
3,566,947, PUB. 11-11-2008. INT. CL. 9.

SYMYX TECHNOLOGIES, SANTA CLARA, CA:
2,547,746, CANC. INT. CL. 9.

SYNAPS, INC., ATLANTA, GA:
2,546,924, CANC. INT. CL. 42.

SYNCHRONET INDUSTRIES, INC., WEST SENECA, NY:
3,567,647, PUB. 11-11-2008. INT. CL. 42.

SYNDESIS LIMITED, RICHMOND HILL, ONTARIO:
2,545,932, CANC. MULTIPLE CLASS, INT. CLS. 35 AND 42.

SYNDICATE SALES, INC., KOKOMO, IN:
2,547,082, CANC. INT. CL. 28.

SYNERGYLINK, MOUNTAIN VIEW, CA:
2,545,705, CANC. INT. CL. 9.

SYNGENTA INVESTMENT CORPORATION, GREENSBORO, NC:
2,209,405, REN. 12-19-08. INT. CL. 5.

SYNGENTA PARTICIPATIONS AG, BASEL, SWITZERLAND:
3,568,208, INT. CL. 5.

SYNKRONIX, INC., PLEASANTON, CA:
2,547,809, CANC. INT. CL. 9.

SYNTIRO HEALTHCARE SERVICES, INC., IRVINE, CA:
2,546,217, CANC. MULTIPLE CLASS, INT. CLS. 38 AND 42.

SYRATECH CORPORATION, EAST BOSTON, MA:
2,144,378, CANC. INT. CL. 8.

SYSTALEX CORPORATION, GAITHERSBURG, MD:
2,547,358, CANC. INT. CL. 42.

SYSTEM 48 PLUS, INC., RIVIERA BEACH, FL:
3,566,621, PUB. 11-11-2008. MULTIPLE CLASS, INT. CLS. 35 AND 42.

SYSTEMS PACKAGING INC., LOS ANGELES, CA:
1,480,847, CANC. INT. CL. 22.

T. L. CORPORATION, CHESTERFIELD, MO:
3,566,544, PUB. 11-11-2008. INT. CL. 44.

T.F.H. PUBLICATIONS, INC., NEPTUNE CITY, NJ:
2,145,374, CANC. INT. CL. 31.
2,217,286, REN. 12-22-08. INT. CL. 17.

T.J. PUPILLO, INC., HARLEYSVILLE, PA:
3,568,577, INT. CL. 29.

TABLESCAPES, LTD., CHICAGO, IL, DBA TABLESCAPES:
1,558,569, REN. 12-22-08. INT. CL. 42.

TABOOLA.COM LTD., BET DAGAN, ISRAEL:
3,568,099, INT. CL. 42.

TACTICAL SOLUTION PARTNERS, INC., GLEN BURNIE, MD, DBA PELICAN MOBILE COMPUTERS, INC.:
3,566,618, PUB. 11-11-2008. INT. CL. 35.

TACTRONICS GROUP INTERNATIONAL, LLC, ENCINO, CA:
3,566,404, PUB. 11-11-2008. INT. CL. 9.

TAIWAN GOOD WILL ENTERPRISE CO., LTD, PEI TUN DISTRICT, TAICHUNG, TAIWAN:
1,480,469, CANC. INT. CL. 7.

TAIWAN VIDEO & MONITOR CORP., TAIPEI, TAIWAN:
3,567,293, PUB. 11-11-2008. INT. CL. 9.

TAIYO YUDEN CO., LTD., TOKYO, JAPAN:
3,568,621, INT. CL. 9.

TAKE SOLUTIONS, INC., PRINCETON, NJ:
3,567,760, PUB. 12-4-2007. INT. CL. 9.

TAKEDA CHEMICAL INDUSTRIES, LTD., CHUO-KU OSAKA, JAPAN:
2,546,693, CANC. INT. CL. 1.

TAKES 2 ENTERPRISES, INC., ELK GROVE VILLAGE, IL, DBA HAPPY ELEPHANT THAI CUISINE:
3,567,064, PUB. 11-11-2008. MULTIPLE CLASS, INT. CLS. 25 AND 43.
3,567,069, PUB. 11-11-2008. MULTIPLE CLASS, INT. CLS. 25 AND 43.

TALLEY, CHRISTOPHER, L., MERIDIAN, ID:
2,548,505, CANC. INT. CL. 28.

TAMPA BAY RAYS BASEBALL LTD., ST. PETERSBURG, FL:
2,547,518, CANC. INT. CL. 6.

TANGSHAN AYERS BATH EQUIPMENT CO., LTD., HE BEI PROVINCE, CHINA:
3,566,804, PUB. 11-11-2008. INT. CL. 11.

TANISTRY, INC., AUSTIN, TX TO INC RESEARCH, INC., RALEIGH, NC:
2,570,877, CANC. INT. CL. 42.

TANKEBLUE SEMICONDUCTOR CO., LTD., CHINA:
3,567,988, PUB. 11-11-2008. INT. CL. 9.

TARGET DATA LLC, CHICAGO, IL:
3,567,581, PUB. 11-11-2008. INT. CL. 36.

TASTE L. FINE FOOD PVT. LTD., MUMBAI, INDIA:
3,566,866, PUB. 11-11-2008. MULTIPLE CLASS, INT. CLS. 29 AND 30.

TATE, TRACY ELIZABETH, HESPERIA, CA, DBA CAGE CANDY:
3,567,305, PUB. 11-11-2008. INT. CL. 35.

TAU BETA PI ASSOCIATION, INC., THE, KNOXVILLE, TN:
663,264, REN. 12-20-08. U.S. CL. 200.

TAWANNA L. MYLES, HOUSTON, TX, DBA LADY MYLES ENTERPRISE:
3,567,285, PUB. 11-11-2008. INT. CL. 5.

TAYLOR MADE GOLF COMPANY, INC., CARLSBAD, CA:
2,547,767, CANC. MULTIPLE CLASS, INT. CLS. 18, 24, 25 AND 28.

TAYLOR, DOUGLAS B., NOKOMIS, FL:
3,567,362, PUB. 11-11-2008. INT. CL. 35.

TAYMAC CORPORATION, TEMPE, AZ:
3,568,374, INT. CL. 9.

TBB PARTNERS INC., CHAPPAQUA, NY:
3,567,291, PUB. 11-11-2008. INT. CL. 35.

TC LICENSE, LTD, HUMMELSTOWN, PA:
2,546,083, CANC. INT. CL. 9.
2,546,749, CANC. INT. CL. 39.

TCBY ENTERPRISES, INC., LITTLE ROCK, AR:
2,145,359, CANC. INT. CL. 30.
2,145,362, CANC. INT. CL. 30.

TDD ENTERPRISES, INC., SAN DIEGO, CA, DBA TUESDAY PRODUCTIONS:
2,144,548, CANC. INT. CL. 35.

TDI MANAGED CARE SERVICES, INC., PITTSBURGH, PA:
2,545,683, CANC. INT. CL. 36.

TDK RF SOLUTIONS INC., CEDAR PARK, TX:
2,546,183, CANC. MULTIPLE CLASS, INT. CLS. 9 AND 42.

TEA TOO PTY LTD, AUSTRALIA:
3,567,804, PUB. 7-24-2007. INT. CL. 43.

TEAM SYNERGY, INC., WILLOW, NY:
2,546,150, CANC. INT. CL. 41.

TEBCHERANI, GLORIA, WASHINGTON, DC:
1,481,156, CANC. INT. CL. 42.

TECHEXPRESS EXPRESS, INCORPORATED, OCEANSIDE, CA:
3,567,115, PUB. 11-11-2008. INT. CL. 37.

TECHIE TRENDS, LLC, IRVINE, CA:
3,567,066, PUB. 11-11-2008. INT. CL. 9.

TECHNICA SOFTWARE CORPORATION, OTTAWA, ONTARIO, K1P 5V5, CANADA:
2,545,549, CANC. MULTIPLE CLASS, INT. CLS. 9 AND

42.
 TECHNICAL KNOCKOUT, INC, POMPANO BEACH, FL:
 2,144,483, CANC. INT. CL. 11.
 TECHNICAL RUBBER COMPANY, INC., JOHNSTOWN,
 OH:
 1,480,730, CANC. INT. CL. 12.
 TECHNIGRAPHICS, INC., WOOSTER, OH:
 3,567,702, PUB. 11-11-2008. INT. CL. 42.
 TECHNOBRANDS, INC., COLONIAL HEIGHTS, VA, DBA
 FIRSTSTREET:
 3,567,390, PUB. 11-11-2008. INT. CL. 35.
 TECHNOLINES, L.L.C., PERRYSBURG, OH:
 2,547,525, CANC. INT. CL. 42.
 TECHNOLOGY CONSERVATION GROUP, INC., LECAN-
 TO, FL:
 3,567,096, PUB. 11-11-2008. INT. CL. 40.
 TECHNOLOGYCONNECT.COM, INC., BROOKLINE, MA:
 2,547,956, CANC. INT. CL. 35.
 TEENESS AS, TRONDHEIM, NORWAY:
 2,545,882, CANC. INT. CL. 7.
 TEFAL S.A., 74150 RUMILLY, FRANCE:
 2,547,104, CANC. INT. CL. 21.
 TELE-PUBLISHING, INC., BOSTON, MA:
 2,144,557, CANC. INT. CL. 38.
 TELECOMPETITION, INC., SAN RAMON, CA:
 2,546,758, CANC. INT. CL. 9.
 TELEFONICA, S.A., 28013 MADRID, SPAIN:
 2,546,185, CANC. INT. CL. 35.
 TELEMED TECHNOLOGIES INTERNATIONAL, INC.,
 TURTLE CREEK, PA, DBA CARDIAC TELECOM, INC.:
 2,546,004, CANC. INT. CL. 42.
 TELEVISA, S.A. DE C.V., COL. SANTA FE ZEDEC, MEXICO:
 3,568,337, INT. CL. 41.
 TELEVISION FOOD NETWORK G. P., NEW YORK, NY:
 2,548,300, CANC. INT. CL. 41.
 TELIA AB (PUBL), 123 86 FARSTA, SWEDEN:
 2,545,542, CANC. MULTIPLE CLASS, INT. CLS. 35, 37, 38
 AND 42.
 2,545,543, CANC. MULTIPLE CLASS, INT. CLS. 35, 37, 38
 AND 42.
 TELL IT PRODUCTIONS, LLC, NEW ORLEANS, LA:
 2,547,167, CANC. INT. CL. 9.
 TELTRONICS, INC., SARASOTA, FL:
 2,264,371, REN. 12-20-08. INT. CL. 9.
 TEMASIS, LLC, CHESTERFIELD, MI:
 2,546,795, CANC. INT. CL. 9.
 TEMCO JAPAN CO., LTD., SUQINAMI-KU, TOKYO, JA-
 PAN:
 2,546,197, CANC. INT. CL. 9.
 TEMENOS, INC., HONOLULU, HI:
 1,491,450, REN. 12-19-08. INT. CL. 35.
 TEN LBS LTD., HOUSTON, TX, DBA BAYOU CITY WINGS:
 3,566,525, PUB. 11-11-2008. INT. CL. 43.
 TERAMED, INC., MAPLE GROVE, MN:
 2,548,216, CANC. INT. CL. 10.
 TERMOVENTILER I ULRICEHAMN AB, SWEDEN:
 3,567,838, PUB. 11-11-2008. INT. CL. 11.
 TERRA RESORT GROUP LLC, TETON VILLAGE, WY:
 3,568,058, INT. CL. 35.
 TERRIO PHYSICAL THERAPY-FITNESS, INC., BAKERS-
 FIELD, CA:
 3,566,587, PUB. 11-11-2008. INT. CL. 41.
 TERVIS TUMBLER CO., OSPREY, FL:
 2,546,650, CANC. INT. CL. 21.
 TEST UNIVERSITY INC., NEW YORK, NY:
 2,548,144, CANC. INT. CL. 41.
 TEXON MANAGEMENT LTD., CLEVELAND, UNITED
 KINGDOM:
 2,661,048, CANC. INT. CL. 6.
 TEXSTYLE, LLC, CINCINNATI, OH:
 3,568,256, INT. CL. 24.
 THALES COMMUNICATIONS SA, FRANCE:
 3,567,985, PUB. 11-11-2008. INT. CL. 9.
 THAT WINE IS MINE, INC., ENGLEWOOD, CO:
 2,547,221, CANC. INT. CL. 21.
 THE AIMBRIDGE GROUP, DENVER, CO:
 3,567,794, PUB. 8-15-2006. MULTIPLE CLASS, INT. CLS.
 36 AND 42.
 THE ARNOLD COMPANY I, TRENTON, IL:
 3,567,028, PUB. 11-11-2008. INT. CL. 7.
 THE BARN YARD, CHRISTIANA, PA:
 3,567,058, PUB. 11-11-2008. INT. CL. 20.
 THE BEGINNER'S BACKPACK L.L.C., NORTHVILLE, MI:
 3,568,735, INT. CL. 18.
 THE BOARD OF REGENTS OF THE UNIVERSITY OF
 NEBRASKA, LINCOLN, NE:
 2,546,473, CANC. MULTIPLE CLASS, INT. CLS. 16, 25, 35
 AND 41.
 THE CENTER FOR CAMPUS FIRE SAFETY, INC., NEW-
 BURYPORT, MA:
 3,566,864, PUB. 11-11-2008. MULTIPLE CLASS, INT. CLS.
 41 AND 45.
 THE COCA-COLA COMPANY, ATLANTA, GA:
 3,566,602, PUB. 11-11-2008. INT. CL. 30.
 THE COOKIE CORNER, HONOLULU, HI:
 3,566,779, PUB. 11-11-2008. INT. CL. 30.
 THE ECONO-RACK GROUP INC., MISSISSAUGA, CANA-
 DA:
 3,566,493, PUB. 4-29-2008. INT. CL. 20.
 THE FILM CREW, INC., STAFFORD, TX:
 3,566,440, PUB. 11-11-2008. INT. CL. 17.
 THE FINLANDIA FOUNDATION, INC., PASADENA, CA:
 3,568,456, INT. CL. 41.
 THE FORMULAAH, LLC, PORTLAND, ME:
 3,566,908, PUB. 11-11-2008. INT. CL. 3.
 3,566,909, PUB. 11-11-2008. INT. CL. 3.
 THE FOURNAISE MARKETING GROUP PTE LTD, SINGA-
 PORE, SINGAPORE:
 3,566,475, PUB. 11-11-2008. INT. CL. 35.
 THE GENERAL COUNCIL OF THE ASSEMBLIES OF GOD,
 SPRINGFIELD, MO:
 3,448,131, COR. INT. CL. 45.
 THE GENERATIONS NETWORK, INC., PROVO, UT:
 3,566,509, PUB. 11-11-2008. MULTIPLE CLASS, INT. CLS.
 9, 35 AND 42.
 THE GIVING WEB, WOODMERE, NY:
 2,547,416, CANC. INT. CL. 42.
 THE GLIDDEN COMPANY, STRONGSVILLE, OH:
 3,568,477, INT. CL. 16.
 THE GOOD COW COMPANY, EAGLE, ID:
 3,566,810, PUB. 11-11-2008. INT. CL. 29.
 THE GUARDIAN LIFE INSURANCE COMPANY OF AMER-
 ICA, NEW YORK, NY:
 3,567,195, PUB. 11-11-2008. INT. CL. 36.
 THE HAIN CELESTIAL GROUP, INC., MELVILLE, NY:
 3,568,538, INT. CL. 16.
 THE HAIR SHOP INC., LOS ANGELES, CA:
 3,566,993, PUB. 11-11-2008. INT. CL. 26.
 THE HARRINGTON GROUP, ORLANDO, FL:
 3,568,281, INT. CL. 9.
 THE HEALTH AND WEALTH TEAM INC., ENCINO, CA:
 3,567,056, PUB. 11-11-2008. INT. CL. 41.
 THE ISOPURE COMPANY, LLC, HAUPPAUGE, NY:
 2,225,537, REN. 12-22-08. INT. CL. 5.
 THE JAR GROUP, INC., BROOKLYN, NY:
 3,566,314, PUB. 11-11-2008. INT. CL. 42.
 THE JEWELERS BOARD OF TRADE, WARWICK, RI:
 3,567,094, PUB. 11-11-2008. INT. CL. 36.
 THE KILPATRICK COMPANY, INC., BOYNTON BEACH,
 FL:
 3,566,742, PUB. 11-11-2008. INT. CL. 35.
 THE KINGS OF CAZ, EAST SYRACUSE, NY:
 3,567,154, PUB. 11-11-2008. INT. CL. 9.
 THE LARYNGEAL MASK COMPANY LIMITED, VICTOR-
 IA, MAHE, SEYCHELLES:
 2,220,745, REN. 12-23-08. INT. CL. 10.
 THE LEADERSHIP EDGE, INC., LA JOLLA, CA:
 3,566,926, PUB. 11-11-2008. MULTIPLE CLASS, INT. CLS.
 35, 41 AND 45.
 THE LITTLE POTATO COMPANY LTD., EDMONTON,
 CANADA:
 3,566,802, PUB. 11-11-2008. INT. CL. 31.
 THE MANDERLEY CORPORATION, NEPEAN, ONTARIO
 K2G 5X8, CANADA:
 2,644,946, CANC. INT. CL. 42.

- THE MCGRAW-HILL COMPANIES, INC., NEW YORK, NY:
862,440. REN. 12-19-08. U.S. CL. 38 (INT. CL. 16).
- THE MEDIA-CATION FOUNDATION, CHICAGO, IL:
3,567,566, PUB. 11-11-2008. INT. CL. 41.
- THE MELTING POT RESTAURANTS, INC., TAMPA, FL:
3,566,789, PUB. 11-11-2008. INT. CL. 43.
- THE METAL WARE CORPORATION, TWO RIVERS, WI:
3,567,010, PUB. 11-11-2008. INT. CL. 30.
- THE MONKS OF NEW SKETE, INC., CAMBRIDGE, NY:
3,567,536, PUB. 11-11-2008. MULTIPLE CLASS, INT. CLS.
18 AND 25.
- THE MURANO GROUP, INC., MIAMI BEACH, FL:
3,567,173, PUB. 11-11-2008. INT. CL. 19.
- THE NATIONAL COUNCIL ON COMPENSATION INSURANCE, INC., BOCA RATON, FL:
2,547,709, CANC. INT. CL. 16.
- THE NATIONAL OSTEOPOROSIS FOUNDATION, WASHINGTON, DC:
3,568,561, MULTIPLE CLASS, INT. CLS. 36 AND 43.
- THE NORTH FACE APPAREL CORP., WILMINGTON, DE:
3,568,579, INT. CL. 20.
- THE PAUL J. AICHER FOUNDATION, INC., EAST HARTFORD, CT:
3,566,705, PUB. 11-11-2008. MULTIPLE CLASS, INT. CLS.
35 AND 41.
- THE POLISHED PALATE, LLC, TARPON SPRINGS, FL:
3,567,342, PUB. 11-11-2008. INT. CL. 41.
3,567,345, PUB. 11-11-2008. INT. CL. 41.
- THE PROCTER & GAMBLE COMPANY, CINCINNATI, OH:
3,567,394, PUB. 11-11-2008. INT. CL. 30.
3,567,579, PUB. 11-11-2008. INT. CL. 3.
3,568,231, MULTIPLE CLASS, INT. CLS. 1, 3, 5 AND 21.
3,568,261, MULTIPLE CLASS, INT. CLS. 1, 3, 5 AND 21.
3,568,482, INT. CL. 3.
- THE PRUDENTIAL INSURANCE COMPANY OF AMERICA, NEWARK, NJ:
3,568,247, INT. CL. 36.
3,568,248, INT. CL. 36.
3,568,475, INT. CL. 35.
- THE RED BAND FILM COMPANY, WINTER HAVEN, FL:
3,568,550, INT. CL. 41.
- THE REGENTS OF THE UNIVERSITY OF CALIFORNIA, OAKLAND, CA:
3,566,459, PUB. 11-11-2008. MULTIPLE CLASS, INT. CLS.
6, 12, 16 AND 41.
- THE RENEWAL GROUP INC., CRANSTON, RI AND WOJICK, THOMAS J. CRANSTON, RI:
3,566,765, PUB. 11-11-2008. INT. CL. 35.
- THE ROSE, HOUSTON, TX:
3,566,884, PUB. 11-11-2008. INT. CL. 44.
- THE SHELburne COMPANY, TANeyTOWN, MD:
3,566,421, PUB. 11-11-2008. INT. CL. 7.
- THE STARJAM CHARITABLE TRUST, GREENLANE, AUCLAND, NEW ZEALAND:
3,567,210, PUB. 11-11-2008. MULTIPLE CLASS, INT. CLS.
36 AND 41.
3,567,220, PUB. 11-11-2008. MULTIPLE CLASS, INT. CLS.
36 AND 41.
- THE STUDENT CONSERVATION ASSOCIATION, INC., CHARLESTOWN, NH:
3,568,046, MULTIPLE CLASS, INT. CLS. 9, 16, 21, 25 AND
41.
- THE SWISS COLONY, INC., MONROE, WI:
3,567,344, PUB. 11-11-2008. INT. CL. 30.
- THE TALENT MINE, INC., NEW YORK, NY:
3,567,308, PUB. 11-11-2008. INT. CL. 35.
- THE THREE ARCHES CO., LTD., BETHLEHEM, ISRAEL:
2,545,640, CANC. INT. CL. 3.
- THE TRIZM PUZZLE COMPANY, LLC, MIDDLEBURG, FL:
3,566,902, PUB. 11-11-2008. MULTIPLE CLASS, INT. CLS.
28 AND 41.
- THE TRUSTEES OF THE RAUL J. WALTERS REVOCABLE LIVING TRUST, A MISSOURI TRUST, THE TRUSTEES COMPRISING RAUL J. WALTERS, A UNITED STATES CITIZEN, AND VICKI WALTERS, A UNITED STATES CITIZEN, COLUMBIA, MO:
3,568,335, INT. CL. 37.
- THE UPPER DECK COMPANY, NORTH LAS VEGAS, NV:
3,568,147, MULTIPLE CLASS, INT. CLS. 20 AND 28.
- THE WILLIS GROUP, COLORADO SPRINGS, CO:
3,566,554, PUB. 11-11-2008. INT. CL. 41.
- THE WINNING COMBINATION INC., WINNIPEG, CANADA:
3,567,420, PUB. 11-11-2008. INT. CL. 5.
3,567,421, PUB. 11-11-2008. INT. CL. 5.
- THECIRCLE.ORG, LLC, CINCINNATI, OH:
3,568,708, INT. CL. 45.
- THEODORE ROOSEVELT CONSERVATION PARTNERSHIP, WASHINGTON, DC:
3,566,714, PUB. 11-11-2008. INT. CL. 35.
- THEPLATFORM, INC., SEATTLE, WA:
2,548,450, CANC. INT. CL. 9.
- THERAPEUTIC RESEARCH CENTER, INC., STOCKTON, CA:
3,567,374, PUB. 11-11-2008. INT. CL. 35.
- THERECORD.NET, INC., HUNTINGDON VALLEY, PA:
2,545,889, CANC. INT. CL. 42.
- THERMAL WINDOWS, INC., TULSA, OK:
2,547,624, CANC. INT. CL. 19.
- THERMO-RITE MANUFACTURING COMPANY, AKRON, OH:
1,480,826, CANC. INT. CL. 20.
- THERMON MANUFACTURING COMPANY, SAN MARCOS, TX:
1,109,271. REN. 12-24-08. INT. CL. 11.
- THIERREE, JEAN-PIERRE HENRI, 75010 PARIS, FRANCE, AKA JEAN BAPTISTE THIERREE AND CHAPLIN, VICTORIA, 75010 PARIS, FRANCE:
2,545,820, CANC. INT. CL. 41.
- THIRD DAY, INC., NASHVILLE, TN:
3,567,357, PUB. 11-11-2008. INT. CL. 25.
- THOMAS L. VATER, D.O., LTD., LAS VEGAS, NV:
3,567,045, PUB. 11-11-2008. INT. CL. 44.
- THOMAS NELSON, INC., NASHVILLE, TN:
1,480,760, CANC. INT. CL. 16.
- THOMAS PUBLISHING COMPANY, NEW YORK, NY:
3,567,140, PUB. 11-11-2008. INT. CL. 41.
- THOMAS, STEPHEN, TOMS RIVER, NJ:
3,568,015, INT. CL. 41.
- THOMAS, STEVEN J., MARGATE, FL:
2,547,985, CANC. INT. CL. 42.
- THOMPSON, GEORGE J. PH.D, AUBURN, NY AND VERBAL JUDO INSTITUTE, INC., AUBURN, NY:
3,566,773, PUB. 11-11-2008. MULTIPLE CLASS, INT. CLS.
9 AND 41.
- THOMPSON, JULIAN, SANTA CRUZ, CA:
2,547,106, CANC. INT. CL. 5.
- THOMSON FINANCIAL LLC, NEW YORK, NY, ME LICENSING CORPORAITON, WILMINGTON, DE:
2,208,422. REN. 12-22-08. INT. CL. 16.
- THOMSON FINANCIAL LLC, NEW YORK, NY:
2,548,557, CANC. INT. CL. 36.
- THOMSON REUTERS (TAX & ACCOUNTING) INC., CARROLLTON, TX, ME LICENSING CORPORATION, WILMINGTON, DE:
2,214,203. REN. 12-22-08. INT. CL. 36.
- THOR TECHNOLOGIES, INC., NEW YORK, NY:
2,546,938, CANC. INT. CL. 9.
- THOU SHALT LAUGH, LLC, BURBANK, CA:
3,568,701, INT. CL. 41.
- THREAT MANAGEMENT AND PROTECTION, INC., HUNTINGTON BEACH, CA:
3,567,013, PUB. 11-11-2008. INT. CL. 45.
- THREE E FARMS, LLC., HOOVER, AL:
3,566,945, PUB. 11-11-2008. INT. CL. 35.
- THREE J'S PACKING CO., INC., LOS ANGELES, CA:
1,480,984, CANC. INT. CL. 31.
- THREE RINGS DESIGN, INC., SAN FRANCISCO, CA:
3,566,986, PUB. 11-11-2008. INT. CL. 9.
3,566,987, PUB. 11-11-2008. INT. CL. 38.
3,566,988, PUB. 11-11-2008. INT. CL. 41.
3,566,989, PUB. 11-11-2008. INT. CL. 42.
- THRESHOLD.COM, INC., THE, SANTA MONICA, CA:
2,546,171, CANC. INT. CL. 38.

- THRONE PARTNERSHIP, THE, SOUTH WINDSOR, CT:
2,546,873, CANC. INT. CL. 41.
- THWEATT, BARBARA ELLEN, ROCKWELL, NC, DBA
LIFELITE PRODUCTIONS:
3,566,727, PUB. 11-11-2008. INT. CL. 9.
- TI GOLF HOLDINGS INC., NEW YORK, NY:
2,144,988, CANC. MULTIPLE CLASS, INT. CLS. 9 AND
41.
- TIA MARIA LIMITED, LONDON, UNITED KINGDOM:
2,218,821. REN. 12-19-08. INT. CL. 33.
- TIA'S RESTAURANT, INC., IRVING, TX:
2,545,516, CANC. INT. CL. 33.
- TIETEX INTERNATIONAL, LTD., SPARTANBURG, SC:
2,546,943, CANC. INT. CL. 24.
- TIFFANY SAIDNIA, LOS ANGELES, CA:
3,567,487, PUB. 11-11-2008. INT. CL. 25.
- TIMBER CREEK BUFFET LLC, SPOKANE, WA:
3,566,943, PUB. 11-11-2008. INT. CL. 43.
- TIME DOLLAR INSTITUTE, WASHINGTON, DC:
3,396,810, COR. INT. CL. 35.
- TIME INC., NEW YORK, NY:
3,568,066, INT. CL. 20.
- TIME WARNER ENTERTAINMENT COMPANY, L.P., NEW
YORK, NY:
2,547,827, CANC. INT. CL. 42.
2,548,142, CANC. INT. CL. 16.
- TIMELESS TOYS, INC., FOSTER CITY, CA:
2,547,034, CANC. INT. CL. 28.
- TIMMINCO LIMITED, TORONTO, ONTARIO M5H 1J9,
CANADA:
2,545,524, CANC. INT. CL. 6.
- TINBU, LLC, PENSACOLA, FL:
3,566,283, PUB. 11-11-2008. MULTIPLE CLASS, INT. CLS.
38 AND 42.
- TINGLEY RUBBER CORPORATION, SOUTH PLAINFIELD,
NJ:
1,518,065. REN. 12-22-08. INT. CL. 25.
- TINY MACHINES, GREAT NECK, NY:
3,566,671, PUB. 11-11-2008. INT. CL. 41.
- TIROLER RÖHREN- UND METALLWERKE; AKTIENGE-
SELLSCHAFT, AUSTRIA:
3,567,809, PUB. 11-11-2008. MULTIPLE CLASS, INT. CLS.
6 AND 7.
- TITLE LOAN COMPANY, ST. LOUIS, MO:
3,566,841, PUB. 11-11-2008. INT. CL. 36.
- TKTV, LLC, NEWPORT BEACH, CA:
3,567,151, PUB. 11-11-2008. INT. CL. 41.
- TOBACK & COMPANY, PHOENIX, AZ:
1,481,026, CANC. INT. CL. 35.
- TODAYS TEMPORARY, INC., PHILADELPHIA, PA:
1,481,028, CANC. INT. CL. 35.
- TOEI ANIMATION CO., LTD., TOKYO 104, JAPAN:
2,546,465, CANC. MULTIPLE CLASS, INT. CLS. 11, 14, 18,
20, 21, 24 AND 30.
- TOKATLIAN, ARA, BLUE JAY, CA AND TOKATLIAN,
BOHDANA, BLUE JAY, CA:
2,144,156, CANC. INT. CL. 41.
- TOKENS, THE, BEVERLY HILLS, CA, DBA THE TOKENS:
1,520,204. REN. 12-19-08. INT. CL. 41.
- TOLEDO HOSPITAL, THE, TOLEDO, OH:
2,548,632, CANC. INT. CL. 28.
- TOLEDO ZOOLOGICAL SOCIETY, TOLEDO, OH:
1,516,758. REN. 12-22-08. INT. CL. 41.
- TOLSTOY, SVIATOSLAV G., BOSTON, MA:
3,568,741, MULTIPLE CLASS, INT. CLS. 9 AND 41.
- TON, QUY THAT, BATON ROUGE, LA:
3,568,524, MULTIPLE CLASS, INT. CLS. 10 AND 11.
- TONNELLERIE TARANSAUD & CIE, FRANCE:
3,567,890, PUB. 11-11-2008. INT. CL. 20.
- TONOS ENTERTAINMENT, INC., LOS ANGELES, CA:
2,546,496, CANC. INT. CL. 41.
- TONY'S SEAFOOD, LTD., BATON ROUGE, LA:
3,568,007, MULTIPLE CLASS, INT. CLS. 29 AND 30.
- TOOBA TANGO INC., LOS GATOS, CA:
2,545,519, CANC. INT. CL. 25.
- TOP HEALTH INC., CRESTWOOD, NY:
2,546,055, CANC. MULTIPLE CLASS, INT. CLS. 5 AND
42.
- TOP WERBEMITTEL GMBH, DITTELBRUNN, FED REP
GERMANY:
3,567,312, PUB. 11-11-2008. INT. CL. 11.
- TOPPS COMPANY, INC., THE, NEW YORK, NY:
2,548,358, CANC. INT. CL. 16.
- TOPTRONIC LIMITED, CENTRAL HONG KONG, HONG
KONG:
3,568,606, INT. CL. 9.
- TORA HOLDINGS LIMITED, GEORGE TOWN, CAYMAN
ISLANDS:
3,567,447, PUB. 11-11-2008. INT. CL. 36.
3,567,636, PUB. 11-11-2008. INT. CL. 36.
3,567,651, PUB. 11-11-2008. INT. CL. 42.
3,567,690, PUB. 11-11-2008. INT. CL. 42.
- TOTAL PETROCHEMICALS USA, INC., HOUSTON, TX
AND TOTAL PETROCHEMICALS USA, INC., HOUSTON,
TX:
2,545,580, CANC. INT. CL. 36.
- TOTAL SYNERGY PTY LTD, NORTH SYDNEY, AUSTRA-
LIA:
3,568,216, MULTIPLE CLASS, INT. CLS. 9 AND 42.
- TOTAL SYSTEM SERVICES, INC., COLUMBUS, GA:
2,275,636. REN. 12-23-08. INT. CL. 9.
- TOTALBANK, MIAMI, FL:
2,547,664, CANC. INT. CL. 36.
- TOTES ISOTONER CORPORATION, CINCINNATI, OH:
1,525,716. REN. 12-22-08. INT. CL. 21.
1,528,120. REN. 12-22-08. INT. CL. 11.
1,530,893. REN. 12-22-08. INT. CL. 20.
- TOTO LTD., KITAKYUSHU-SHI, JAPAN:
3,405,304, COR. MULTIPLE CLASS, INT. CLS. 1, 2, 6, 7, 9,
11, 19, 35 AND 42.
- TOURISM & MORE, INC., COLLEGE STATION, TX:
3,566,520, PUB. 11-11-2008. MULTIPLE CLASS, INT. CLS.
41 AND 45.
- TOVA CORPORATION, BEVERLY HILLS, CA:
2,546,100, CANC. MULTIPLE CLASS, INT. CLS. 3 AND 4.
- TOWN & COUNTRY SURF SHOP, INC., AIEA, HI:
2,547,703, CANC. MULTIPLE CLASS, INT. CLS. 16, 18, 24
AND 25.
- TOYO BOSEKI KABUSHIKI KAISHA, OSAKA, JAPAN, DBA
TOYOBO CO., LTD.:
3,568,364, INT. CL. 12.
- TPI ACQUISITION SUBSIDIARY, INC., SOMERVILLE, NJ,
HARVARD INDUSTRIES, INC., FARMINGDALE, NJ:
1,511,770. REN. 12-22-08. INT. CL. 17.
- TR SALES PLANTATION, LLC, BELVEDERE, SC, DBA
THREE RUNS PLANTATION:
3,567,171, PUB. 11-11-2008. INT. CL. 37.
- TRADENAME NETWORK, INC., HIGLEY, AZ:
3,567,630, PUB. 11-11-2008. INT. CL. 41.
- TRAFFIX DEVICES, INC., SAN CLEMENTE, CA:
3,566,992, PUB. 11-11-2008. INT. CL. 6.
- TRANS UNION L.L.C., CHICAGO, IL:
2,566,190, CANC. INT. CL. 36.
- TRANS-LUX CORPORATION, NORWALK, CT:
2,546,348, CANC. INT. CL. 9.
- TRANS-UNITED, INC., BURNS HARBOR, IN:
3,567,262, PUB. 11-11-2008. INT. CL. 39.
3,567,267, PUB. 11-11-2008. INT. CL. 39.
- TRANSACTIS, INC., BETHESDA, MD:
3,568,083, INT. CL. 36.
- TRANSAMERICA COMMERCIAL FINANCE CORPORA-
TION, ROLLING MEADOWS, IL:
2,547,626, CANC. INT. CL. 36.
- TRANSDERMAL TECHNOLOGIES, INC., LAKE PARK, FL:
2,546,468, CANC. INT. CL. 1.
- TRANSPORTATION TECHNOLOGIES INC., BLUE BELL,
PA:
2,545,870, CANC. INT. CL. 9.
- TRANSPOWER CORPORATION, TREVOSE, PA:
2,548,622, CANC. INT. CL. 9.
- TRANSVERSE LLC, AUSTIN, TX:
3,566,907, PUB. 11-11-2008. MULTIPLE CLASS, INT. CLS.
35 AND 42.
- TRAVELER'S EMERGENCY NETWORK, INC., DURHAM,
NC:
2,143,946, CANC. INT. CL. 39.

TREES UP, SOUTHFIELD, MI:
2,145,161, CANC. INT. CL. 28.

TRELLEBORG EMERSON & CUMING, INC., MANSFIELD, MA, EMERSON & CUMING, INC., CANTON, MA:
677,140. REN. 12-23-08. U.S. CL. 1 (INT. CL. 21).

TRENCH PLATE RENTAL CO., DOWNEY, CA:
3,566,920, PUB. 11-11-2008. MULTIPLE CLASS, INT. CLS. 9 AND 39.

TREND MICRO INCORPORATED, CUPERTINO, CA:
2,547,705, CANC. INT. CL. 9.

TRENDMASTERS, INC., ST. LOUIS, MO:
2,548,126, CANC. INT. CL. 28.

TREVIGEN, INC., GAITHERSBURG, MD:
3,567,243, PUB. 11-11-2008. INT. CL. 1.
3,567,246, PUB. 11-11-2008. INT. CL. 1.

TRI-ARC FINANCIAL SERVICES, INC., WAYNE, PA:
3,566,316, PUB. 11-11-2008. INT. CL. 36.

TRI-COASTAL DESIGN GROUP, INC., BRIDGEWATER, NJ:
3,566,262, PUB. 7-29-2008. INT. CL. 18.

TRI-KAY CO., CAPE CORAL, FL:
2,547,143, CANC. INT. CL. 3.

TRI-TECH LABORATORIES, INC., LYNCHBURG, VA:
1,480,354, CANC. INT. CL. 3.

TRIAL EXHIBITS, INC., HOUSTON, TX, DBA PENNEBAKER:
3,566,700, PUB. 11-11-2008. INT. CL. 35.

TRIALTECH, LLC, SAUSALITO, CA:
2,547,840, CANC. MULTIPLE CLASS, INT. CLS. 9 AND 16.

TRIANGLE GLOBAL INDUSTRIES, INC., WEST PALM BEACH, FL:
3,566,695, PUB. 11-11-2008. INT. CL. 9.

TRIBORO QUILT MFG. CORP., WHITE PLAINS, NY:
1,489,393. REN. 12-23-08. INT. CL. 24.
1,489,393, CANC. INT. CL. 25.

TRIBUNE TELEVISION HOLDINGS, INC., CHICAGO, IL:
2,547,448, CANC. INT. CL. 42.

TRICE, LAURA, VENICE, CA:
3,567,618, PUB. 11-11-2008. INT. CL. 30.

TRIDEL CORPORATION, TORONTO, ONTARIO M3H 5S9, CANADA:
2,227,016. REN. 12-23-08. MULTIPLE CLASS, INT. CLS. 35, 37 AND 42.
2,227,016, CANC. INT. CL. 36.

TRIDENT SECURITY CONCEPTS, LLC, TEMPLETON, CA:
3,568,155, INT. CL. 9.

TRIGEMINAL NEURALGIA ASSOCIATION, INC., GAINESVILLE, FL:
3,568,772, INT. CL. 45.

TRIMBLE HOUSE CORPORATION, NORCROSS, GA:
1,481,191, CANC. INT. CL. 11.

TRIMBLE NAVIGATION LIMITED, SUNNYVALE, CA:
2,547,660, CANC. INT. CL. 9.

TRINE ACCESS TECHNOLOGY, INC., BRONX, NY:
2,547,802, CANC. INT. CL. 42.

TRINKAUS, KAREN, LA VERNE, CA:
2,546,361, CANC. INT. CL. 31.

TRION, INC., SANFORD, NC:
1,480,553, CANC. INT. CL. 9.

TROEGS BREWING CO, HARRISBURG, PA:
3,566,542, PUB. 11-11-2008. INT. CL. 32.

TRONEX TECHNOLOGY, INC, FAIRFIELD, CA:
2,203,846. REN. 12-24-08. INT. CL. 8.

TROPICAL SEAS, INC, ORMOND BEACH, FL:
2,144,760, CANC. INT. CL. 3.

TROWELON, INC., GREEN BAY, WI:
1,481,065, CANC. INT. CL. 37.

TRUCK ACCESSORIES GROUP, INC., ELKHART, IN:
2,545,911, CANC. MULTIPLE CLASS, INT. CLS. 12 AND 25.

TRUCKERS AND CITIZENS UNITED, MYERSTOWN, PA:
3,567,519, PUB. 11-11-2008. INT. CL. 38.

TRUDELL MEDICAL INTERNATIONAL, LONDON, CANADA:
3,566,678, PUB. 11-11-2008. INT. CL. 10.

TRUE WORLD HOLDINGS LLC, FALLS CHURCH, VA:
3,566,790, PUB. 11-11-2008. INT. CL. 43.

TRUMP, DONALD J., NEW YORK, NY:
3,566,654, PUB. 11-11-2008. MULTIPLE CLASS, INT. CLS. 41 AND 43.

TRUMPF-BLUSEN-KLEIDER WALTER GIRGNER GMBH & CO. KG, D-81510 MUENCHEN, FED REP GERMANY:
1,091,464, CANC. INT. CL. 25.

TRUSTEES OF COLUMBIA UNIVERSITY, THE, NEW YORK, NY:
2,545,808, CANC. INT. CL. 9.

TRUSTEES OF JAMES DEAN FOUNDATION TRUST, INDIANAPOLIS, IN:
1,480,606, CANC. INT. CL. 9.

TRUSTEES OF THE JAMES DEAN FOUNDATION, INDIANAPOLIS, IN:
1,480,617, CANC. INT. CL. 9.

TRY CHANGE LLC, WOODBRIDGE, VA:
3,567,281, PUB. 11-11-2008. INT. CL. 25.

TSA CORPORATE SERVICES, INC., ENGLEWOOD, CO:
3,568,403, INT. CL. 35.

TSS PHOTOGRAPHY, INC, DULUTH, GA:
3,566,963, PUB. 11-11-2008. MULTIPLE CLASS, INT. CLS. 36 AND 40.

TSURUTA SHOKUHIN KOGYO KABUSHIKI KAISHA, TOMIOKA-SHI, GUNMA-KEN, JAPAN:
2,547,910, CANC. INT. CL. 30.

TUCKER-JOHNSON, BRENDA, OAKLAND, CA:
3,567,674, PUB. 11-11-2008. INT. CL. 3.

TUDOR, GRACE M., WESTLAKE VILLAGE, CA:
3,568,320, INT. CL. 25.

TUFENKIAN IMPORT/EXPORT VENTURES, INC., NEW YORK, NY:
3,568,322, INT. CL. 35.

TUFFY COMPANY, WALLA WALLA, WA:
3,567,018, PUB. 11-11-2008. INT. CL. 19.

TUMI, INC., SOUTH PLAINFIELD, NJ:
2,546,779, CANC. INT. CL. 18.

TUNG LOK MILLENNIUM PTE LTD, CENTRAL PLAZA, SINGAPORE:
3,566,694, PUB. 11-11-2008. INT. CL. 43.

TURBOMECA, CEDEX, FRANCE:
3,566,435, PUB. 8-5-2008. MULTIPLE CLASS, INT. CLS. 7, 12, 37 AND 42.

TURBOSOFT PTY LTD., ULTIMO NSW 2007, AUSTRALIA:
2,545,509, CANC. INT. CL. 9.

TURNER ORIGINAL PRODUCTIONS, INC., ATLANTA, GA:
2,145,061, CANC. INT. CL. 41.

TURNER-ORCUTT, KAREN, HERMITAGE, TN:
2,547,536, CANC. INT. CL. 9.

TURTLE WAX, INC., CHICAGO, IL:
1,480,335, CANC. INT. CL. 1.

TUTERA, DAVID, NEW YORK, NY:
3,567,027, PUB. 11-11-2008. INT. CL. 41.

TUTORMARK, LLC, HENDERSON, NV:
2,545,740, CANC. INT. CL. 41.

TV GUIDE FINANCIAL, INC., NEW YORK, NY:
2,144,495, CANC. INT. CL. 42.

TWENTIETH CENTURY FOX FILM CORPORATION, LOS ANGELES, CA:
2,547,183, CANC. INT. CL. 9.
3,568,061, INT. CL. 42.

TWENTYFIRST GROUP, INC., NEW YORK, NY:
2,546,934, CANC. INT. CL. 14.

TWI FRANCHISING, INC., SIOUX CITY, IA:
3,566,338, PUB. 11-11-2008. INT. CL. 3.

TWI INTERACTIVE, INC., CLEVELAND, OH:
2,548,539, CANC. INT. CL. 35.

TWO STAR DOG, INC., BERKELEY, CA:
3,568,539, INT. CL. 25.

TWO WOODS L.L.C., WINTER HAVEN, FL:
2,145,531, CANC. INT. CL. 32.

TWP ENTERPRISES, INC, CHEVY CHASE, MD:
2,661,439, CANC. INT. CL. 37.

TX TECHNOLOGY ACQUISITION CORP., SANTA CLARA, CA:
2,546,378, CANC. INT. CL. 42.

TYCOM FINANCE AG, SCHAFFHAUSEN, SWITZERLAND:
2,548,426, CANC. INT. CL. 39.

- TYE SAUNDERS, GOBLES, MI:
3,566,737, PUB. 11-11-2008. INT. CL. 25.
3,566,757, PUB. 11-11-2008. INT. CL. 38.
- T2CURE GMBH, FED REP GERMANY:
3,567,827, PUB. 11-11-2008. MULTIPLE CLASS, INT. CLS.
5 AND 42.
- U ASSIST BUILDERS, SCOTTSDALE, AZ:
3,567,162, PUB. 11-11-2008. INT. CL. 37.
- U. S. SILICA COMPANY, BERKELEY SPRINGS, WV:
1,531,997. REN. 12-20-08. INT. CL. 19.
- U.S. EQUITIES, NEW YORK, NY:
2,545,656, CANC. INT. CL. 16.
- U.S. GEAR TOOLS, INC., BLACK MOUNTAIN, NC:
2,144,099, CANC. INT. CL. 7.
- U.S. MEDICAL ASSISTANCE FOUNDATION, AUSTIN, TX:
2,546,535, CANC. INT. CL. 42.
- U.S. NANOCORP, INC., FARMINGTON, CT:
2,213,390. REN. 12-23-08. INT. CL. 1.
- U-DUMP TRAILERS, INC., OCALA, FL:
3,567,722, PUB. 11-11-2008. INT. CL. 12.
- UAV CORPORATION, FORT MILL, SC:
2,546,536, CANC. INT. CL. 22.
- UBERSPAT HOLDINGS, LLC, RICHARDSON, TX:
3,566,358, PUB. 11-11-2008. INT. CL. 38.
- UBS CLEAN CARE, INC., PRINCETON, IN:
3,566,840, PUB. 11-11-2008. INT. CL. 16.
- UCHOW, INC., WATERTOWN, MA:
2,547,098, CANC. INT. CL. 42.
- UDELL ASSOCIATES, INC., ORLANDO, FL:
2,548,085, CANC. INT. CL. 36.
- UES, INC., DAYTON, OH:
3,568,299, INT. CL. 9.
- ULLICO INC., WASHINGTON, DC:
2,546,714, CANC. INT. CL. 36.
- ULTRA SCIENTIFIC, INCORPORATED, NORTH KINGSTOWN, RI:
3,566,745, PUB. 11-11-2008. INT. CL. 42.
3,566,746, PUB. 11-11-2008. INT. CL. 1.
- ULTRADENT PRODUCTS, INC., SOUTH JORDAN, UT:
1,520,742. REN. 12-19-08. INT. CL. 10.
- ULTRASOUND SERVICES OF AMERICA, INC., LARGO, MD, DBA PREVENTFIRST:
3,567,481, PUB. 11-11-2008. INT. CL. 44.
- ULTRASUN PROFESSIONAL B. V., 7554 TR HENGELO, NETHERLANDS:
2,545,486, CANC. INT. CL. 11.
- UMAX DATA SYSTEMS INC., HSINCHU, TAIWAN:
2,547,946, CANC. INT. CL. 9.
- UNCLE EDDIE'S, FORT WAYNE, IN:
3,566,929, PUB. 11-11-2008. INT. CL. 29.
- UNCLE RAY'S DAIRYLAND, INC., FENTON, MI:
2,213,025. REN. 12-20-08. INT. CL. 42.
- UNCLE SAM REALTY INC., SAN DIEGO, CA:
3,568,124, INT. CL. 41.
- UNDER ARMOUR, INC., BALTIMORE, MD:
3,566,830, PUB. 11-11-2008. INT. CL. 25.
- UNEX CORPORATION, MAHWAH, NJ:
3,567,770, PUB. 11-11-2008. INT. CL. 7.
- UNI-CLEANER AMERIKA APS, DK-6990 ULFBORG, DENMARK:
3,568,020, MULTIPLE CLASS, INT. CLS. 3, 7 AND 22.
- UNICAP, INC., UNITY, ME:
3,566,507, PUB. 11-11-2008. INT. CL. 38.
- UNIDEN AMERICA CORPORATION, FORT WORTH, TX:
3,567,517, PUB. 11-11-2008. INT. CL. 9.
- UNIDISC MUSIC INC., CARLE PLACE, NY:
3,566,891, PUB. 11-11-2008. INT. CL. 9.
- UNILEVER N.V., ROTTERDAM, NETHERLANDS:
2,576,906, CANC. INT. CL. 29.
- UNILEVER SUPPLY CHAIN, INC., CLINTON, CT:
2,547,299, CANC. INT. CL. 30.
2,548,474, CANC. INT. CL. 3.
- UNILOY LILACRON USA INC., MANCHESTER, MI:
2,215,353. REN. 12-20-08. INT. CL. 7.
- UNION CARBIDE CORPORATION, MIDLAND, MI:
1,111,160. REN. 12-20-08. INT. CL. 1.
- UNION PACIFIC RAILROAD COMPANY, OMAHA, NE, CHICAGO AND NORTH WESTERN RAILWAY COMPANY, CHICAGO, IL:
504,855. REN. 12-19-08. U.S. CL. 105 (INT. CL. 39).
- UNION STATION KANSAS CITY, INC., KANSAS CITY, MO:
3,566,387, PUB. 11-11-2008. INT. CL. 41.
- UNIQUE MINDS FOUNDATION, INC., SHARON, CT:
2,548,045, CANC. MULTIPLE CLASS, INT. CLS. 9 AND 16.
- UNITE MEDIA GROUP, INC., FOUNTAIN VALLEY, CA:
2,546,483, CANC. INT. CL. 16.
- UNITED BUSINESS MEDIA LLC, MANHASSET, NY, TECH ONLINE, INC., WALTHAM, MA:
2,220,651. REN. 12-19-08. MULTIPLE CLASS, INT. CLS.
35 AND 42.
- UNITED BUSINESS MEDIA LLC, MANHASSET, NY:
3,566,649, PUB. 11-11-2008. MULTIPLE CLASS, INT. CLS.
41 AND 42.
- UNITED FACES OF ISLAM, INC., ALEXANDRIA, VA, DBA UFI, INC.:
2,547,182, CANC. INT. CL. 9.
- UNITED GENERAL TRADING, INC., REDONDO BEACH, CA:
3,566,666, PUB. 11-11-2008. INT. CL. 35.
- UNITED LAUNCH ALLIANCE, CENTENNIAL, CO:
3,568,226, INT. CL. 39.
- UNITED PARCEL SERVICE OF AMERICA, INC., ATLANTA, GA:
2,547,478, CANC. INT. CL. 9.
- UNITED SERVICES OF AMERICA FEDERAL CREDIT UNION, SAN DIEGO, CA:
1,481,042, CANC. INT. CL. 36.
- UNITED STATES CURLING ASSOCIATION, INC., STEVENS POINT, WI:
2,211,393. REN. 12-20-08. MULTIPLE CLASS, INT. CLS.
14, 16, 24, 25, 26 AND 41.
- UNITED STATES LIME & MINERALS, INC., FAIRFAX, VA:
1,480,315, CANC. INT. CL. 1.
- UNITED STATES MANUFACTURING COMPANY, PASADENA, CA:
1,480,688, CANC. INT. CL. 10.
- UNITED STATES OLYMPIC COMMITTEE, COLORADO SPRINGS, CO:
2,547,011, CANC. INT. CL. 20.
3,567,720, PUB. 11-11-2008. MULTIPLE CLASS, INT. CLS.
18 AND 25.
- UNITED STATES PRACTICAL SHOOTING ASSOCIATION, SEDRO WOOLLEY, WA:
2,546,105, CANC. INT. CL. 42.
- UNITED STATES RACQUETBALL ASSOCIATION, COLORADO SPRINGS, CO:
2,662,988, CANC. INT. CL. 41.
- UNITED STATES TENNIS ASSOCIATION INCORPORATED, WHITE PLAINS, NY:
2,547,763, CANC. INT. CL. 41.
- UNITED STATIONS RADIO NETWORKS, INC., NEW YORK, NY:
2,145,325, CANC. INT. CL. 38.
- UNITED WAY OF AMERICA, ALEXANDRIA, VA:
3,568,264, INT. CL. 35.
- UNITOOL PUNCH AND DIE CO., INC., BUFFALO, NY:
2,547,157, CANC. INT. CL. 7.
- UNIVERSAL COIL MANUFACTURERS, L.L.C., HARVEY, LA:
2,548,265, CANC. INT. CL. 40.
- UNIVERSAL CONSULTING & TECHNOLOGY INC., FORT COLLINS, CO:
3,566,639, PUB. 11-11-2008. INT. CL. 9.
- UNIVERSAL TEA COMPANY, INC., PORTLAND, OR, DBA STASH TEA COMPANY:
1,517,342. REN. 12-24-08. INT. CL. 30.
- UNIVERSAL TELEVISION NETWORKS, UNIVERSAL CITY, CA:
2,547,000, CANC. INT. CL. 41.
- UNIVERSITY OF HOUSTON SYSTEM, THE, HOUSTON, TX:
2,547,190, CANC. INT. CL. 16.
2,547,192, CANC. INT. CL. 42.

UNIVERSITY OF MASSACHUSETTS AT LOWELL ALUMNI ASSOCIATION, INC., LOWELL, MA:
2,547,008, CANC. MULTIPLE CLASS, INT. CLS. 36 AND 42.

UNIVISION COMMUNICATIONS INC., LOS ANGELES, CA:
3,566,359, PUB. 11-11-2008. INT. CL. 16.

UNIVISION NETWORK LIMITED PARTNERSHIP, MIAMI, FL:
2,210,613. REN. 12-22-08. INT. CL. 41.

UP COUNTRY INC., EAST PROVIDENCE, RI:
3,568,351, INT. CL. 28.
3,568,352, INT. CL. 16.
3,568,353, INT. CL. 21.

UPC MEDICAL SUPPLIES, INC., ALHAMBRA, CA, DBA UNITED PACIFIC COMPANY:
2,547,041, CANC. INT. CL. 5.

UPSHOT INTERACTIVE, INC., NEW YORK, NY:
3,566,958, PUB. 11-11-2008. INT. CL. 42.
3,566,960, PUB. 11-11-2008. INT. CL. 42.

UPTIME SCIENCE CORPORATION, ALPHARETTA, GA:
3,567,061, PUB. 11-11-2008. INT. CL. 42.

UR-NEW HOME LLC, CENTERLINE, MI:
3,568,315, INT. CL. 35.

URBAN BODY ARMOR, CORP., MIAMI, FL:
3,567,614, PUB. 11-11-2008. INT. CL. 9.

URBAN DECAY COSMETICS LLC, COSTA MESA, CA:
2,548,253, CANC. INT. CL. 3.

URBAN DECAY COSMETICS, LLC, HOLLYWOOD, FL:
3,567,623, PUB. 11-11-2008. INT. CL. 35.
3,567,624, PUB. 11-11-2008. INT. CL. 35.

URBAN MAPPING, INC., SAN FRANCISCO, CA:
3,568,149, MULTIPLE CLASS, INT. CLS. 35, 42 AND 45.
3,568,713, INT. CL. 42.

URBAN PIRATES, LLC, BALTIMORE, MD:
3,568,525, MULTIPLE CLASS, INT. CLS. 25, 39 AND 41.

URBAN SHOPPING CENTERS, INC., CHICAGO, IL:
2,546,458, CANC. MULTIPLE CLASS, INT. CLS. 35 AND 36.

URBANSTONE PTY LTD, JANDAKOT, WESTERN AUSTRALIA 6164, AUSTRALIA:
2,545,568, CANC. INT. CL. 19.

URGENT CARE ASSOCIATION OF AMERICA, WARRENVILLE, IL:
3,568,790, INT. CL. 35.

URGENT GEAR, INC., LOS ANGELES, CA:
2,144,322, CANC. INT. CL. 25.

US ECOMMERCE ASSOCIATION, INC., WASHINGTON, DC:
2,546,708, CANC. INT. CL. 41.

US LEC CORP., CHARLOTTE, NC:
2,548,577, CANC. INT. CL. 9.

US NET 2000 INC., HOUSTON, TX:
2,547,010, CANC. INT. CL. 36.

US SAWS, INC., SANTA ANA, CA:
3,568,018, INT. CL. 7.

US TECHNOLOGY RESOURCES, LLC, ALISO VIEJO, CA:
3,568,009, INT. CL. 42.

US WEALTH MANAGEMENT, LLC, BRAINTREE, MA:
3,566,538, PUB. 11-11-2008. INT. CL. 41.

USA ADMINISTRATION SERVICES, INC., LOUISVILLE, KY:
2,207,818. REN. 12-19-08. INT. CL. 36.

USEFULJOBS.COM, HYATTSVILLE, MD:
2,548,427, CANC. INT. CL. 35.

USENIX ASSOCIATION, BERKELEY, CA:
2,546,137, CANC. MULTIPLE CLASS, INT. CLS. 41 AND 42.

UWINK, INC., VAN NUYS, CA:
3,568,049, MULTIPLE CLASS, INT. CLS. 25, 41 AND 43.
3,568,050, MULTIPLE CLASS, INT. CLS. 25, 41 AND 43.
3,568,051, MULTIPLE CLASS, INT. CLS. 25, 41 AND 43.

V GRAM LLC., NEW YORK, NY:
2,547,784, CANC. INT. CL. 9.

V&S VIN & SPRIT AKTIEBOLAG (PUBL), STOCKHOLM, SWEDEN:
3,568,349, INT. CL. 35.
3,568,350, MULTIPLE CLASS, INT. CLS. 33 AND 35.

V-CAN SPORTS, INC., EL MONTE, CA:
3,566,930, PUB. 11-11-2008. MULTIPLE CLASS, INT. CLS. 9 AND 38.

V-ONE CORPORATION, GERMANTOWN, MD:
2,145,060, CANC. INT. CL. 9.

VA TECH AI INFORMATICS GMBH & CO KG, 1020 VIENNA, AUSTRIA:
2,545,639, CANC. MULTIPLE CLASS, INT. CLS. 9, 16, 35, 37, 38, 41 AND 42.

VAC-TEC SYSTEMS, INC., BOULDER, CO TO HAUZER INDUSTRIES B.V., 5916 PA VENLO, NETHERLANDS:
1,480,558, CANC. INT. CL. 9.

VALCO ENTERPRISES, L.L.C., NEWARK, DE:
3,568,595, INT. CL. 29.

VALENCIA DEL TORO, RICARDO, COLIMA, MEXICO:
2,547,432, CANC. MULTIPLE CLASS, INT. CLS. 9, 16 AND 41.

VALERIE IDEHEN, NEW YORK, NY:
3,566,809, PUB. 11-11-2008. INT. CL. 35.

VALIDUS MEDICAL SYSTEMS, INC., SANTA CRUZ, CA:
3,568,193, INT. CL. 9.

VALLEY APPAREL COMPANY, CEDAR RAPIDS, IA:
2,548,042, CANC. INT. CL. 25.

VALLEY ELECTRIC CO. OF MT. VERNON, INC., MOUNT VERNON, WA, DBA FASTLAMPS.COM:
2,546,504, CANC. INT. CL. 35.

VALLEY NATIONAL GROUP, BETHLEHEM, PA:
3,567,439, PUB. 11-11-2008. INT. CL. 36.

VALLEY RESEARCH, INC., SOUTH BEND, IN:
2,547,093, CANC. INT. CL. 1.

VALLUM RESOURCES, LLC, RICHMOND, VA:
3,567,282, PUB. 11-11-2008. INT. CL. 35.

VALPAK DIRECT MARKETING SYSTEMS, INC., LARGO, FL:
3,568,390, INT. CL. 16.

VALUE DRYCLEANERS OF AMERICA, LLC, GREENBELT, MD:
3,037,348, AM. INT. CL. 37.

VAN CAMP, GORDON, RIO RICO, AZ:
3,568,407, INT. CL. 7.

VAN DORN DEMAG CORPORATION, STRONGSVILLE, OH:
2,546,439, CANC. INT. CL. 42.

VAN RUITEN FAMILY WINERY, LLC, LODI, CA:
3,568,027, INT. CL. 33.

VAN-ACTION INC., ST-LAURENT, QUEBEC, CANADA:
2,547,463, CANC. MULTIPLE CLASS, INT. CLS. 12 AND 37.

VANCE, JOHN, BAY CITY, TX:
3,568,547, INT. CL. 12.

VANDERWEIL FACILITY ADVISORS, INC., BOSTON, MA:
2,547,135, CANC. INT. CL. 42.

VAPOR CLEAN SYSTEMS, INC., PLANTATION, FL:
2,547,206, CANC. INT. CL. 5.

VARSITY GOLD, INC., GILBERT, AZ:
3,566,944, PUB. 11-11-2008. MULTIPLE CLASS, INT. CLS. 29, 30 AND 36.

VARSITY SPIRIT CORPORATION, MEMPHIS, TN:
3,567,653, PUB. 11-11-2008. INT. CL. 41.

VASE WRAPS, LLC, FRAMINGHAM, MA:
3,568,794, INT. CL. 16.

VCAT LLC, SAN DIEGO, CA:
2,144,150, CANC. INT. CL. 41.

VCFO HOLDINGS, INC., AUSTIN, TX:
3,568,212, INT. CL. 35.

VEAT, INC., TORRANCE, CA:
2,236,876. REN. 12-20-08. INT. CL. 29.

VEBLEN CHEESE FACTORY, INC., VEBLEN, SD:
1,480,946, CANC. INT. CL. 29.

VECTIV CORPORATION, SAN FRANCISCO, CA:
2,546,407, CANC. INT. CL. 42.

VECTORVEST, INC., AKRON, OH:
1,518,874. REN. 12-24-08. INT. CL. 16.

VEEDA CLINICAL RESEARCH, INC., COLUMBUS, OH:
3,566,337, PUB. 11-11-2008. INT. CL. 42.

VEER CORPORATION, CALGARY, CANADA:
3,567,789, PUB. 7-1-2008. INT. CL. 16.

- VEGAS.COM, LLC, LAS VEGAS, NV:
3,568,669, INT. CL. 20.
- VENETIAN BLIND & FLOOR COVERING SHOP, INC., HOUSTON, TX, DBA GULF COAST WINDOW COVERINGS:
2,548,081, CANC. INT. CL. 20.
- VENTIV HEALTH COMMUNICATIONS, INC., STAMFORD, CT:
2,546,291, CANC. INT. CL. 9.
- VENTURA FOODS, LLC, BREA, CA:
3,567,718, PUB. 11-11-2008. INT. CL. 35.
- VERITECH CORPORATION, EAST LONGMEADOW, MA:
2,165,243. REN. 12-24-08. INT. CL. 9.
- VERIZON TRADEMARK SERVICES LLC, ARLINGTON, VA:
3,568,690, MULTIPLE CLASS, INT. CLS. 38 AND 42.
- VEROPEDIA, INC., ST. PETERSBURG, FL:
3,568,386, INT. CL. 41.
- VERSO VERILINK, LLC F/K/A WINSLOW ASSET HOLDINGS, LLC, MADISON, AL:
2,546,825, CANC. INT. CL. 9.
2,547,137, CANC. INT. CL. 42.
- VERTEBRAL TECHNOLOGIES, INC., MINNETONKA, MN:
3,568,417, INT. CL. 10.
- VERTIGO MULTIMEDIA, INC., MONTREAL, QUEBEC, CANADA:
2,547,941, CANC. INT. CL. 9.
- VESTAL ASPHALT, INC., VESTAL, NY:
1,480,814, CANC. INT. CL. 19.
2,548,386, CANC. INT. CL. 19.
- VESTAS CONTROL SYSTEMS A/S, RANDERS, DENMARK:
2,545,634, CANC. MULTIPLE CLASS, INT. CLS. 7 AND 9.
- VEYANCE TECHNOLOGIES, INC., AKRON, OH:
2,547,811, CANC. INT. CL. 17.
- VIACOM INTERNATIONAL INC., NEW YORK, NY:
2,144,775, CANC. INT. CL. 30.
2,202,871. REN. 12-23-08. INT. CL. 16.
2,202,872. REN. 12-23-08. INT. CL. 41.
2,206,408. REN. 12-19-08. INT. CL. 28.
2,546,232, CANC. INT. CL. 41.
2,546,311, CANC. INT. CL. 38.
2,547,884, CANC. INT. CL. 16.
3,568,254, INT. CL. 41.
- VIALINK COMPANY, THE, EDMOND, OK:
2,546,182, CANC. INT. CL. 9.
- VIAVANTI, LLC, CHAPPAQUA, NY:
3,567,556, PUB. 11-11-2008. INT. CL. 30.
- VICTOR TECHNOLOGY, LLC, BOLINGBROOK, IL:
3,568,263, INT. CL. 9.
- VICTOR, INC., LIBERTY, MS:
2,546,429, CANC. INT. CL. 41.
- VIDEOJET TECHNOLOGIES INC., WOOD DALE, IL:
3,568,683, INT. CL. 9.
- VIDEOLEARNING SYSTEMS, INC., BRYN MAWR, PA:
2,546,367, CANC. INT. CL. 35.
- VIEWPOINT SYSTEMS, INC., DALLAS, TX:
2,145,138, CANC. INT. CL. 9.
- VIEWWORKS MEDIA, LLC., HOUSTON, TX:
3,567,463, PUB. 11-11-2008. INT. CL. 41.
- VIKING CORPORATION, THE, HASTINGS, MI:
2,547,819, CANC. INT. CL. 6.
- VILLEROY & BOCH AG, 66693 METTLACH, FED REP GERMANY:
2,545,624, CANC. INT. CL. 19.
- VIMS EDUCATION GROUP, MORENO VALLEY, CA:
3,566,833, PUB. 11-11-2008. INT. CL. 41.
- VINEYARD & WINERY SERVICES, INC., WINDSOR, CA, DBA VINEYARD & WINERY MANAGEMENT:
2,221,753. REN. 12-19-08. INT. CL. 41.
- VIRGIN HEALTHMILES, INC., BOSTON, MA:
3,566,614, PUB. 11-11-2008. MULTIPLE CLASS, INT. CLS. 35 AND 41.
3,566,615, PUB. 11-11-2008. MULTIPLE CLASS, INT. CLS. 35 AND 41.
3,566,616, PUB. 11-11-2008. INT. CL. 41.
3,566,617, PUB. 11-11-2008. INT. CL. 9.
- VIRGINIA K. FREYERMUTH, INC., CARVER, MA:
3,568,679, INT. CL. 41.
- VIRGINIA LOTTERY, RICHMOND, VA:
2,546,108, CANC. MULTIPLE CLASS, INT. CLS. 16, 25, 26, 35 AND 41.
- VIRGINIA'S HERITAGE MUSIC TRAIL: THE CROOKED ROAD, INC., ABINGDON, VA:
3,568,203, INT. CL. 35.
- VIRGINIE NEUMANN, PARIS, FRANCE:
3,568,135, MULTIPLE CLASS, INT. CLS. 18 AND 25.
- VIRGO PUBLISHING, LLC, PHOENIX, AZ:
3,567,482, PUB. 11-11-2008. INT. CL. 35.
- VIRTUAL HUMAN RESOURCES, LLC, WAYZATA, MN:
2,547,496, CANC. INT. CL. 35.
2,547,497, CANC. INT. CL. 35.
- VISA INTERNATIONAL SERVICE ASSOCIATION, FOSTER CITY, CA:
2,145,312, CANC. INT. CL. 36.
- VISHAY GENERAL SEMICONDUCTOR, LLC, MALVERN, PA, GENERAL INSTRUMENT CORPORATION OF DELAWARE, CHICAGO, IL:
2,196,444. REN. 12-20-08. INT. CL. 9.
- VISIONSPRING, INC., NEW YORK, NY:
3,567,309, PUB. 11-11-2008. INT. CL. 36.
3,567,385, PUB. 11-11-2008. INT. CL. 36.
- VISIONWORKS, L.L.C., LENEXA, KS:
3,567,602, PUB. 11-11-2008. INT. CL. 28.
3,567,603, PUB. 11-11-2008. INT. CL. 28.
3,567,605, PUB. 11-11-2008. INT. CL. 28.
3,567,608, PUB. 11-11-2008. INT. CL. 28.
3,567,609, PUB. 11-11-2008. INT. CL. 28.
3,567,611, PUB. 11-11-2008. INT. CL. 28.
3,567,612, PUB. 11-11-2008. INT. CL. 28.
- VISUAL WORKPLACE, LLC, BYRON CENTER, MI:
3,568,736, INT. CL. 17.
- VITACOST.COM INC., BOCA RATON, FL:
3,568,696, INT. CL. 5.
- VITAL MILLENNIUM, CORP., SAN GABRIEL, CA:
3,567,433, PUB. 11-11-2008. INT. CL. 25.
- VITAQUEST INTERNATIONAL, INC., WEST CALDWELL, NJ:
2,546,801, CANC. INT. CL. 5.
- VIVANTY FOODS INC., BRITISH COLUMBIA, CANADA:
3,566,704, PUB. 11-11-2008. INT. CL. 43.
- VIVAX MEDICAL CORPORATION, TORRINGTON, CT:
3,568,700, INT. CL. 44.
- VIVIDENCE CORPORATION, SAN MATEO, CA:
2,548,115, CANC. INT. CL. 35.
- VOICE WEB CORPORATION, SANTA MONICA, CA:
2,545,578, CANC. INT. CL. 35.
- VOIP SUPPLY LLC, BUFFALO, NY:
3,566,310, PUB. 11-11-2008. INT. CL. 35.
- VOLVO TRADEMARK HOLDING AB, GSE-405 08 GÖTEBORG, SWEDEN:
3,566,438, PUB. 11-11-2008. MULTIPLE CLASS, INT. CLS. 2 AND 9.
- VONS COMPANIES, INC., THE, ARCADIA, CA:
1,480,942, CANC. INT. CL. 29.
- VOSGES, LTD, CHICAGO, IL:
3,566,893, PUB. 11-11-2008. MULTIPLE CLASS, INT. CLS. 25, 30 AND 41.
- VOSS, RANDY E., LAVALLE, WI:
2,548,146, CANC. INT. CL. 7.
- VSA DESIGNS, INC., WOODLAND HILLS, CA:
3,566,286, PUB. 11-11-2008. MULTIPLE CLASS, INT. CLS. 14, 18 AND 25.
- VTECH INDUSTRIES, L.L.C., WHEELING, IL:
2,547,036, CANC. INT. CL. 28.
- VUSTAR, LLC, FALLS CHURCH, VA:
3,568,064, MULTIPLE CLASS, INT. CLS. 9 AND 38.
- W & M CAFE, INC., ORLANDO, FL, DBA D/B/A PRESS 101:
3,567,638, PUB. 11-11-2008. INT. CL. 43.
- W. ATLEE BURPEE COMPANY, WARMINSTER, PA:
3,568,338, INT. CL. 17.
- W. FRANK HARSHAW AND ASSOCIATES, INC., LOUISVILLE, KY:
2,144,328, CANC. MULTIPLE CLASS, INT. CLS. 35 AND 37.
- W.C. BRADLEY/ZEBCO HOLDINGS, INC., TULSA, OK:
123,029. REN. 12-20-08. U.S. CL. 22 (INT. CL. 28).

- W.W. GRAINGER, INC., LAKE FOREST, IL:
2,548,003, CANC. INT. CL. 42.
- WACHOVIA CORPORATION, CHARLOTTE, NC:
3,567,696, PUB. 11-11-2008. INT. CL. 36.
- WAGGON-CELLERS, INC., THE, AMARILLO, TX:
2,547,203, CANC. INT. CL. 12.
- WAHL CLIPPER CORPORATION, STERLING, IL:
2,221,496, REN. 12-19-08. INT. CL. 8.
- WAJID, TALIAH, ATLANTA, GA:
2,545,801, CANC. INT. CL. 3.
- WAKE FOREST UNIVERSITY HEALTH SCIENCES, WINSTON-SALEM, NC:
2,164,644, REN. 12-24-08. INT. CL. 42.
- WAKEFERN FOOD CORP., ELIZABETH, NJ:
2,548,239, CANC. MULTIPLE CLASS, INT. CLS. 28, 30 AND 32.
- WALDENBOOKS PROPERTIES, INC., ANN ARBOR, MI:
2,546,809, CANC. INT. CL. 35.
- WALENTINE, ELLIS, SPRINGTOWN, PA:
3,566,713, PUB. 11-11-2008. INT. CL. 35.
- WALKER FANCY, INC., PALM HARBOR, FL:
3,567,239, PUB. 11-11-2008. INT. CL. 10.
- WALKING THE WORLD, INC., FT. COLLINS, CO:
2,202,684, REN. 12-23-08. MULTIPLE CLASS, INT. CLS. 16 AND 25.
- WALL STREET PRODUCTIONS INC., NEW YORK, NY:
2,546,149, CANC. INT. CL. 41.
- WALPOLE WOODWORKERS, INC., WALPOLE, MA:
3,567,190, PUB. 11-11-2008. MULTIPLE CLASS, INT. CLS. 19, 20, 21, 35 AND 37.
3,567,192, PUB. 11-11-2008. INT. CL. 19.
- WALTER SHELBY GROUP LTD., OAKLAND, CA TO LYRIS TECHNOLOGIES INC., EMERYVILLE, CA:
2,143,958, CANC. INT. CL. 9.
- WALTER, JESSICA G, NEW YORK, NY:
3,567,015, PUB. 11-11-2008. INT. CL. 41.
- WALTERS, DAVID, C, DENVER, NJ:
3,566,706, PUB. 11-11-2008. INT. CL. 43.
- WANER, JANE M., LITTLE ROCK, AR:
3,568,600, MULTIPLE CLASS, INT. CLS. 3 AND 5.
- WANNA GET FRESH RESTAURANTS LLC, SAN ANTONIO, TX:
3,567,044, PUB. 11-11-2008. INT. CL. 43.
- WARNACO U.S., INC., BRIDGEPORT, CT:
2,144,772, CANC. INT. CL. 25.
- WARTHER, RICHARD O., EXTON, PA:
2,211,386, REN. 12-20-08. INT. CL. 20.
- WASATCH PHARMACEUTICAL INC., MIDVALE, UT:
2,546,155, CANC. INT. CL. 42.
- WASTEWATER BIOLOGICAL SOLUTIONS CORP., STONY BROOK, NY:
2,545,710, CANC. INT. CL. 40.
- WATCHCRAFT, INC., LONG ISLAND CITY, NY:
2,214,275, REN. 12-22-08. INT. CL. 14.
- WATERFORD WEDGWOOD PLC, WATERFORD, IRELAND:
3,566,461, PUB. 11-11-2008. MULTIPLE CLASS, INT. CLS. 35, 39, 41, 43 AND 45.
- WATERLOOV INC, RED BANK, NJ:
2,546,789, CANC. INT. CL. 20.
- WATERS TECHNOLOGIES IRELAND LIMITED, DUBLIN, IRELAND:
2,548,221, CANC. INT. CL. 9.
- WATSON, JR. JAMES H., LITTLETON, CO:
3,566,553, PUB. 3-11-2008. INT. CL. 25.
- WATSON, STEVENS, FIORILLA & RUTTER, LLP, NEW BRUNSWICK, NJ:
2,546,961, CANC. INT. CL. 42.
- WATTS, JAMIE, SAN MATEO, FL:
3,567,134, PUB. 11-11-2008. INT. CL. 45.
3,567,135, PUB. 11-11-2008. INT. CL. 45.
3,568,505, INT. CL. 45.
- WAUGH HOLDINGS, INC., CLEARWATER, FL:
2,199,764, REN. 12-22-08. INT. CL. 39.
- WAVE IMAGING TECHNOLOGY INC., KATY, TX, DBA WAVE IMAGING, WIT INC.:
3,567,629, PUB. 11-11-2008. MULTIPLE CLASS, INT. CLS. 35 AND 42.
- WCI COMMUNITIES, INC., BONITA SPRINGS, FL:
2,546,227, CANC. INT. CL. 42.
2,546,228, CANC. INT. CL. 42.
2,546,230, CANC. INT. CL. 36.
2,546,231, CANC. INT. CL. 39.
- WE R. FUN, INC., CUSHING, MN:
2,216,095, REN. 12-20-08. INT. CL. 28.
- WEATHER UNDERGROUND, INC., THE, ANN ARBOR, MI:
2,281,088, REN. 12-20-08. INT. CL. 42.
2,297,683, REN. 12-20-08. INT. CL. 42.
- WEATHERGUARD BUILDING PRODUCTS, INC., WEST PALM BEACH, FL:
3,568,290, MULTIPLE CLASS, INT. CLS. 6 AND 19.
- WEBASTO AG, GAUTING, FED REP GERMANY:
3,567,905, PUB. 11-11-2008. INT. CL. 11.
- WEBEDU, LLC, LAKE SHERWOOD, CA:
3,566,939, PUB. 11-11-2008. INT. CL. 41.
- WEBER ADVERTISING AND MARKETING, LANCASTER, PA:
3,567,660, PUB. 11-11-2008. INT. CL. 35.
- WEBTERNITY INC., JERSEY CITY, NJ:
2,547,854, CANC. INT. CL. 42.
- WECO WESTER EBBINGHAUS GMBH & CO. KG, HANAU, FED REP GERMANY:
3,566,388, PUB. 8-12-2008. INT. CL. 9.
- WEE WILLY'S INC., AFTON, MN:
3,567,417, PUB. 11-11-2008. INT. CL. 30.
- WEIDER HISTORY GROUP, INC., WOODLAND HILLS, CA:
2,546,856, CANC. MULTIPLE CLASS, INT. CLS. 35, 38 AND 42.
- WEINGARDEN, MARSHALL L., HAWORTH, NJ:
2,548,059, CANC. INT. CL. 9.
- WEINGARDT, GARY, LAS VEGAS, NV:
2,168,372, REN. 12-19-08. INT. CL. 41.
- WEINTEK LABS., INC., TAIPEI HSIEN, TAIWAN:
3,567,496, PUB. 11-11-2008. INT. CL. 9.
- WELL'S DAIRY, INC., LE MARS, IA:
2,545,960, CANC. INT. CL. 30.
- WELLS FARGO & COMPANY, SAN FRANCISCO, CA TO WFC HOLDINGS CORPORATION, MINNEAPOLIS, MN:
1,428,720, AM. INT. CL. 36.
- WELLS FARGO & COMPANY, MINNEAPOLIS, MN:
2,546,671, CANC. INT. CL. 36.
- WELLS FARGO BANK, N.A., NEW YORK, NY:
2,547,345, CANC. INT. CL. 35.
2,547,346, CANC. INT. CL. 42.
2,547,347, CANC. INT. CL. 9.
- WELLS FARGO BANK, NATIONAL ASSOCIATION, MINNEAPOLIS, MN:
2,123,411, REN. 12-22-08. INT. CL. 36.
- WELLS FARGO HOME MORTGAGE, A DIVISION OF WELLS FARGO BANK, N.A., DES MOINES, IA:
2,547,587, CANC. INT. CL. 36.
- WELLSFORD COMMERCIAL PROPERTIES TRUST, NEW YORK, NY:
2,545,991, CANC. MULTIPLE CLASS, INT. CLS. 36 AND 37.
- WELTON SOUND SYSTEMS U.S.A. LIMITED:
1,480,646, CANC. INT. CL. 9.
- WEN FEN, CHIANG, TAIPEI, TAIWAN:
3,566,416, PUB. 11-11-2008. INT. CL. 25.
3,566,417, PUB. 11-11-2008. INT. CL. 25.
3,566,418, PUB. 11-11-2008. INT. CL. 25.
- WENDY'S OF NORTH ALABAMA, INC., HUNTSVILLE, AL:
1,480,599, CANC. INT. CL. 9.
- WERNER ENTERPRISES, INC., OMAHA, NE:
3,568,087, INT. CL. 35.
- WERNER MEDIA PARTNERS, LLC, DAVIE, FL, DBA NATURE'S SLEEP, LLC:
3,568,205, INT. CL. 20.
- WES MICKLE, WEATHERFORD, TX:
3,566,931, PUB. 11-11-2008. INT. CL. 28.
- WESCONE CRUSHERS PTY LTD, WESTERN AUSTRALIA, AUSTRALIA:
2,547,577, CANC. INT. CL. 7.
- WESTERN DAIRY ASSOCIATION, THORNTON, CO:
3,566,610, PUB. 11-11-2008. MULTIPLE CLASS, INT. CLS.

- 35 AND 41.
 WESTERN LEGACY SALES, LLC, ALVARADO, TX:
 3,566,498, PUB. 11-11-2008. INT. CL. 18.
 WESTERN RESOURCES, INC., TOPEKA, KS:
 2,546,008, CANC. INT. CL. 36.
 WESTERN STATES ADMINISTRATORS, FRESNO, CA:
 1,481,167, CANC. INT. CL. 42.
 WESTON SOLUTIONS (IPR), INC., WEST CHESTER, PA:
 3,568,270, INT. CL. 35.
 WESTONE LABORATORIES, INC., COLORADO SPRINGS,
 CO:
 2,203,950, REN. 12-24-08. INT. CL. 10.
 2,210,825, REN. 12-19-08. INT. CL. 10.
 WEYCO GROUP, INC., GLENDALE, WI:
 3,566,812, PUB. 11-11-2008. INT. CL. 25.
 WEYERHAEUSER COMPANY, FEDERAL WAY, WA:
 2,144,047, CANC. INT. CL. 35.
 WF ACQUISITION, INC., COLORADO SPRINGS, CO:
 2,547,534, CANC. INT. CL. 8.
 WFJM ENTERPRISES, INC., LA CROSSE, WI:
 3,567,319, PUB. 11-11-2008. MULTIPLE CLASS, INT. CLS.
 24 AND 25.
 3,567,353, PUB. 11-11-2008. INT. CL. 25.
 WGU, LLC, PLANO, TX:
 2,547,214, CANC. INT. CL. 28.
 WHIRLPOOL PROPERTIES, INC., BENTON HARBOR, MI:
 2,548,094, CANC. MULTIPLE CLASS, INT. CLS. 9, 20
 AND 21.
 WHISTLER GROUP INC., THE, BENTONVILLE, AR:
 2,144,077, CANC. INT. CL. 9.
 WHITAKER CORPORATION, THE, WILMINGTON, DE:
 1,103,805, REN. 12-20-08. INT. CL. 9.
 1,104,227, REN. 12-20-08. INT. CL. 9.
 WHITE CASTLE MANAGEMENT CO., COLUMBUS, OH:
 3,568,755, MULTIPLE CLASS, INT. CLS. 21 AND 30.
 WHITE EAGLE FEDERAL SAVINGS BANK, WILMING-
 TON, DE:
 1,481,058, CANC. INT. CL. 36.
 WHITE HORSE CERAMIC CO., LTD., TAOYUAN HSIEN,
 TAIWAN:
 2,548,047, CANC. INT. CL. 19.
 WHITEFLASH.COM, INC., HOUSTON, TX:
 3,566,390, PUB. 11-11-2008. INT. CL. 14.
 WHITLOCK INTERNATIONAL, LLC, BOCA RATON, FL:
 1,480,698, CANC. INT. CL. 10.
 WHITMORE MANUFACTURING COMPANY, THE, ROCK-
 WALL, TX:
 1,480,394, CANC. INT. CL. 4.
 WHITNEY INTERNATIONAL UNIVERSITY, LTD., HAMIL-
 TON, BERMUDA:
 3,568,305, INT. CL. 41.
 WHOLESAL MAILING LISTS, INC., SHERMAN OAKS,
 CA:
 3,566,561, PUB. 11-11-2008. MULTIPLE CLASS, INT. CLS.
 36 AND 40.
 3,566,603, PUB. 11-11-2008. MULTIPLE CLASS, INT. CLS.
 36 AND 40.
 WIKO, LIMITED, ORLAND PARK, IL:
 1,480,718, CANC. INT. CL. 11.
 WILBERT FUNERAL SERVICES, INC., FOREST PARK, IL:
 861,528, REN. 12-19-08. U.S. CL. 2 (INT. CL. 20).
 861,529, REN. 12-19-08. U.S. CL. 2 (INT. CL. 20).
 WILCOX ARLOTTO & ASSOCIATES, ALPHARETTA, GA:
 2,547,796, CANC. INT. CL. 35.
 WILD FLAVORS, INC., ERLANGER, KY:
 3,568,146, MULTIPLE CLASS, INT. CLS. 29 AND 30.
 WILD GINGER ASIAN RESTAURANT, SEATTLE, WA:
 3,567,485, PUB. 11-11-2008. INT. CL. 43.
 WILD WELL CONTROL, INC., HOUSTON, TX:
 3,566,486, PUB. 11-11-2008. INT. CL. 41.
 WILD, JONATHAN, HARROGATE, NORTH YORKSHIRE,
 ENGLAND:
 2,546,061, CANC. MULTIPLE CLASS, INT. CLS. 9, 14
 AND 25.
 WILDEN PUMP & ENGINEERING CO., COLTON, CA:
 1,480,476, CANC. INT. CL. 7.
 WILDSIDE DIVERSIFIED, INC., WALKER, MN:
 2,654,121, CANC. INT. CL. 16.
 WILEY PUBLISHING, INC., HOBOKEN, NJ:
 2,143,881, CANC. INT. CL. 16.
 2,548,040, CANC. MULTIPLE CLASS, INT. CLS. 16 AND
 41.
 WILFER, HANS-PETER, D-08258 MARKNEUKIRCHEN,
 FED REP GERMANY:
 2,547,843, CANC. MULTIPLE CLASS, INT. CLS. 9 AND
 15.
 WILLIAM B. MAY JR. FAMILY LIMITED PARTNERSHIP,
 CHESTERTOWN, MD:
 3,568,582, INT. CL. 36.
 WILLIAM BRIDGES & ASSOCIATES, INC., MILL VALLEY,
 CA:
 2,144,779, CANC. INT. CL. 41.
 WILLIAMS, JEFF, SAN DIEGO, CA:
 2,547,391, CANC. INT. CL. 5.
 WILLIAMS, ROBERT PAUL, WOODSIDE, CA, DBA TAD
 WILLIAMS, AND DEBORAH BEALE, A CITIZEN OF
 THE U.S.A.:
 2,547,304, CANC. INT. CL. 9.
 WILLIAMS, VENUS, NEW YORK, NY:
 3,568,165, MULTIPLE CLASS, INT. CLS. 9, 14 AND 25.
 WILLITTS DESIGNS INTERNATIONAL, INC., PETALUMA,
 CA:
 2,547,953, CANC. INT. CL. 20.
 WILSON SPORTING GOODS CO., CHICAGO, IL:
 3,567,780, PUB. 11-11-2008. INT. CL. 28.
 WILSON-COOK MEDICAL INC., WINSTON-SALEM, NC:
 3,568,705, INT. CL. 10.
 WILSON, ANTHONY V, ANTIOCH, TN:
 3,567,139, PUB. 11-11-2008. INT. CL. 44.
 WILSON, DESOTA ALPHONSO, DULUTH, GA:
 2,547,800, CANC. INT. CL. 35.
 WILSON, DINA, BURLESON, TX:
 3,567,178, PUB. 11-11-2008. INT. CL. 25.
 WIN CHOICE AMERICA, INC., COMMERCE, CA:
 3,567,230, PUB. 11-11-2008. INT. CL. 25.
 3,567,268, PUB. 11-11-2008. INT. CL. 25.
 WIN FINANCIAL CORP., SACRAMENTO, CA:
 3,566,348, PUB. 11-11-2008. INT. CL. 36.
 WINCO FIREWORKS INTERNATIONAL, L.L.C., PRAIRIE
 VILLAGE, KS:
 3,568,033, INT. CL. 13.
 WIND CAPITAL GROUP, LLC, ST. LOUIS, MO:
 3,566,453, PUB. 11-11-2008. INT. CL. 37.
 WINDMÖLLER & HÖLSCHER, FED REP GERMANY:
 3,567,951, PUB. 11-11-2008. INT. CL. 7.
 WINDOWS-ON-OUR-WATERS, SANTA MONICA, CA:
 3,567,057, PUB. 11-11-2008. INT. CL. 41.
 WINDY CITY WIRE CABLE AND TECHNOLOGY PRO-
 DUCTS, LLC, BOLINGBROOK, IL:
 3,568,416, INT. CL. 9.
 WINE & DINE PROPERTIES LTD, LAS VEGAS, NV:
 3,566,323, PUB. 11-11-2008. INT. CL. 41.
 WINFIELD SOLUTIONS, LLC, SHOREVIEW, MN:
 1,527,599, REN. 12-23-08. INT. CL. 1.
 WINNER INTERNATIONAL ROYALTY LLC, SHARON, PA:
 2,145,486, CANC. INT. CL. 12.
 WINZONE CORPORATION, DRAPER, UT:
 2,545,581, CANC. INT. CL. 42.
 WIRELESS APPLICATIONS, CORP., BELLEVUE, WA:
 2,547,418, CANC. INT. CL. 42.
 WISOLUTION LTD., IRELAND:
 3,567,946, PUB. 11-11-2008. INT. CL. 42.
 WITRHO CORPORATION, ELKBRIDGE, MD:
 2,546,562, CANC. INT. CL. 25.
 WITT, MARES & COMPANY, PLC, NEWPORT NEWS, VA:
 2,547,362, CANC. INT. CL. 35.
 WITTER, LOWELL F., ELGIN, IL:
 2,547,542, CANC. INT. CL. 8.
 WIZARDS OF THE COAST, INC., PAWTUCKET, RI:
 3,568,019, INT. CL. 28.
 WMS SOLUTIONS, INC., FRISCO, TX, DBA INTERLINK
 TECHNOLOGIES:
 3,566,917, PUB. 11-11-2008. INT. CL. 42.

WNBA ENTERPRISES, LLC, SECAUCUS, NJ:
2,196,488. REN. 12-19-08. INT. CL. 16.
2,286,604. REN. 12-20-08. INT. CL. 41.
2,547,062. CANC. INT. CL. 38.
2,547,791. CANC. INT. CL. 28.

WOLF & COHEN LIFE INSURANCE, INC., WASHINGTON, DC, DBA WOLF AND COHEN INSURANCE GROUP:
2,045,625. CANC. INT. CL. 36.

WOLFGANG CANDY COMPANY, INC., YORK, PA:
3,568,235. MULTIPLE CLASS, INT. CLS. 30 AND 35.

WOMEN'S CAMPAIGN FORUM FOUNDATION, WASHINGTON, DC:
3,567,474. PUB. 11-11-2008. INT. CL. 41.

WONG, CONNIE OY YEN, BEALE AFB, CA:
2,547,411. CANC. INT. CL. 25.

WOOD WORLDWIDE, INC., NEW YORK, NY:
2,545,974. CANC. MULTIPLE CLASS, INT. CLS. 35 AND 42.

WOODFIN HEATING, INC., GARNER, NC, DBA US FLEET UNIVERSAL:
3,566,800. PUB. 11-11-2008. INT. CL. 36.
3,566,801. PUB. 11-11-2008. INT. CL. 36.

WOODHEAD INDUSTRIES, INC., DEERFIELD, IL:
2,209,634. REN. 12-20-08. INT. CL. 11.

WOODROW WILSON NATIONAL FELLOWSHIP FOUNDATION, THE, PRINCETON, NJ:
2,547,125. CANC. INT. CL. 42.

WOODS HOLE OCEANOGRAPHIC INSTITUTION, WOODS HOLE, MA:
2,202,129. REN. 12-19-08. MULTIPLE CLASS, INT. CLS. 9, 16, 18, 21, 25 AND 41.
2,202,129. CANC. INT. CL. 28.

WOODWARD CAMP, INC., WOODWARD, PA:
2,546,765. CANC. INT. CL. 41.

WOODWARD LABORATORIES, INC., LOS ALAMITOS, CA:
2,546,246. CANC. INT. CL. 41.

WOODWORKER, INC., WESTPORT, CT:
1,481,194. CANC. INT. CL. 16.

WOOPS CONCEPT LIMITED, CENTRAL, HONG KONG:
3,568,129. INT. CL. 16.

WORD ENTERPRISES, LTD., ELIZABETHTOWN, PA, DBA ELEXIO:
3,567,002. PUB. 11-11-2008. INT. CL. 42.

WORKFORCE CHEMISTRY, INC., RALEIGH, NC:
3,567,399. PUB. 11-11-2008. INT. CL. 41.

WORKFORCE LOGISTICS, INC., NEW YORK, NY:
2,546,033. CANC. INT. CL. 42.

WORKMAN FARMS, INC., MURRAY, KY:
3,567,252. PUB. 11-11-2008. INT. CL. 31.

WORLD CARRIER, INC., INCLINE VILLAGE, NV:
2,548,548. CANC. INT. CL. 38.

WORLD COMMERCE ONLINE, INC., ORLANDO, FL:
2,546,040. CANC. INT. CL. 35.

WORLD GOLF FOUNDATION, INC., ST. AUGUSTINE, FL, WORLD GOLF FOUNDATION, INC., ST. AUGUSTINE, FL:
2,213,226. REN. 12-19-08. INT. CL. 16.
2,214,966. REN. 12-19-08. INT. CL. 21.

WORLD OF JEANS & TOPS, INC., IRVINE, CA:
3,567,328. PUB. 11-11-2008. INT. CL. 25.

WORLD STOCK FOOTAGE LTD., WANCHAI, HONG KONG:
3,567,085. PUB. 11-11-2008. INT. CL. 41.

WORLD WIDE WIRELESS WEB, CORP., SAN DIEGO, CA:
2,546,190. CANC. INT. CL. 38.
2,546,191. CANC. INT. CL. 38.

WORLD WRESTLING ENTERTAINMENT, INC., STAMFORD, CT:
3,568,362. INT. CL. 41.

WORLD'S TOUGHEST BULLS & BRONCS LLC, MINNEAPOLIS, MN:
2,170,682. REN. 12-19-08. INT. CL. 41.

WORLDDATWORK, SCOTTSDALE, AZ:
2,292,338. REN. 12-22-08. U.S. CL. B.

WORLDNAMES, INC., MEDFIELD, MA:
2,548,071. CANC. MULTIPLE CLASS, INT. CLS. 35 AND 42.

WORLDNET MARKETING, CATONSVILLE, MD:
2,546,945. CANC. INT. CL. 25.

WORLDWIDE DISCIPLESHIP ASSOCIATION, FAYETTEVILLE, GA:
3,566,500. PUB. 11-11-2008. MULTIPLE CLASS, INT. CLS. 9 AND 41.

WORLDWIDE FINANCIAL SERVICES, INC., SOUTHFIELD, MI:
2,733,257. CANC. INT. CL. 36.

WORLEY CLAIMS SERVICES, INC., HAMMOND, LA:
3,568,182. INT. CL. 36.

WORMSER COMPANY, CHICAGO, IL:
1,480,879. CANC. INT. CL. 25.
1,480,880. CANC. INT. CL. 25.

WORTHING, ALLAN L., COLORADO SPRINGS, CO:
2,545,491. CANC. INT. CL. 42.

WP IP, LLC, NEW YORK, NY:
2,546,869. CANC. INT. CL. 24.

WRAP-ART, INC., COCONUT CREEK, FL:
2,272,927. REN. 12-19-08. INT. CL. 22.

WRIGHT, JAMES, FELTON, CA:
2,202,652. REN. 12-23-08. INT. CL. 42.

WYHE'S CHOICE, INC., LESTER, IA, DBA DUTCHLAND FROZEN FOODS:
3,566,798. PUB. 11-11-2008. INT. CL. 30.
3,566,799. PUB. 11-11-2008. INT. CL. 30.

WYLD STYLE LLC, LONG BEACH, CA:
3,567,522. PUB. 11-11-2008. INT. CL. 41.

X-BACK BRACING SERVICES, INC. BIRDSBORO, PA:
3,567,407. PUB. 11-11-2008. INT. CL. 10.

XCAPER INDUSTRIES, LLC, NEWPORT BEACH, CA:
2,548,359. CANC. INT. CL. 9.

XCPT COMMUNICATION TECHNOLOGIES, LLC, VENICE, FL:
3,568,653. INT. CL. 9.

XERTUS SYNERGISTICS, L.P., VALLEY FORGE, PA:
2,548,093. CANC. MULTIPLE CLASS, INT. CLS. 35 AND 38.

XLEAR INC., OREM, UT:
2,547,176. CANC. INT. CL. 30.

XS ENERGY, LLC, SANTA FE SPRINGS, CA:
3,568,574. INT. CL. 5.

XTEND WORKOUT, BOCA RATON, FL:
3,567,616. PUB. 11-11-2008. INT. CL. 41.

XYPRO TECHNOLOGY CORPORATION, SIMI VALLEY, CA:
1,480,604. CANC. INT. CL. 9.

X10 LTD., HAMILTON, BERMUDA:
2,545,798. CANC. INT. CL. 9.

YALE OGRON MANUFACTURING CO., INC., OPA-LOCKA, FL:
2,548,170. CANC. MULTIPLE CLASS, INT. CLS. 6 AND 19.

YALE RESIDENTIAL SECURITY PRODUCTS, INC., NORCROSS, GA:
2,144,978. CANC. INT. CL. 6.

YAMAHA CORPORATION, SHIZUOKA, JAPAN:
3,566,269. PUB. 11-11-2008. INT. CL. 15.

YAMAHA ELECTRONICS CORPORATION, USA, BUENA PARK, CA:
2,547,261. CANC. INT. CL. 9.

YAMAHA HATSUDOKI KABUSHIKI KAISHA, IWATA-SHI, SHIZUOKA-KEN, JAPAN:
1,480,727. CANC. INT. CL. 12.

YAMAWA MANUFACTURING COMPANY LIMITED, CHUO-KU, TOKYO, JAPAN:
1,517,787. REN. 12-22-08. INT. CL. 7.

YANGTZE RIVER EXPRESS AIRLINES COMPANY LIMITED, SHANGHAI, CHINA:
3,568,289. INT. CL. 39.

YANKEE CANDLE COMPANY, INC., THE, SOUTH DEERFIELD, MA:
2,144,657. CANC. INT. CL. 4.

YARNELL ICE CREAM CO., INC., SEARCY, AR:
2,172,033. REN. 12-19-08. INT. CL. 30.
2,181,580. REN. 12-19-08. MULTIPLE CLASS, INT. CLS. 29, 30 AND 32.

- YELLOWSTAR TECHNOLOGY, LLC, CHICAGO, IL:
3,567,125, PUB. 11-11-2008. INT. CL. 9.
- YESKE BUIE INC., SAN FRANCISCO, CA:
3,567,541, PUB. 11-11-2008. INT. CL. 36.
- YIHUA INTERNATIONAL GROUP (U.S.A.) INC., CITY OF INDUSTRY, CA:
2,547,224, CANC. INT. CL. 19.
- YMC CO., LTD., KYOTO 600-8106, JAPAN:
3,567,891, PUB. 11-11-2008. MULTIPLE CLASS, INT. CLS. 7 AND 40.
- YOGO IMPORTS LTD., MAPLE RIDGE, B.C., CANADA:
3,566,934, PUB. 11-11-2008. INT. CL. 24.
- YOKOGAWA ELECTRIC CORPORATION, MUSASHINO-SHI; TOKYO 180-8750, JAPAN:
3,567,846, PUB. 11-11-2008. INT. CL. 9.
- YOOPERSOFT, INC., ESCANABA, MI:
3,568,486, INT. CL. 42.
- YOU, KWAN BIN, TEMPLE CITY, CA:
2,546,359, CANC. INT. CL. 20.
- YOUNG BROADCASTING OF NASHVILLE LLC, NASHVILLE, TN:
3,567,003, PUB. 11-11-2008. MULTIPLE CLASS, INT. CLS. 35 AND 41.
- YOUNG JEA SHIN, PLAINFIELD, IL:
3,568,392, INT. CL. 38.
- YOUNG WOMEN'S CHRISTIAN ASSOCIATION OF THE UNITED STATES OF AMERICA, INC., WASHINGTON, DC:
2,546,485, CANC. MULTIPLE CLASS, INT. CLS. 16, 25 AND 41.
- YOUNG-BRUEHL, ELISABETH, PHILADELPHIA, PA AND BETHELARD, FAITH, PHILADELPHIA, PA:
2,547,510, CANC. MULTIPLE CLASS, INT. CLS. 41 AND 42.
- YOUNG, BRIAN Q., SAN GABRIEL, CA:
2,547,001, CANC. INT. CL. 7.
- YOUTHFUL AGING ASSOCIATES, INC., SARASOTA, FL:
2,548,527, CANC. INT. CL. 42.
- YSL BEAUTE INC., NEW YORK, NY:
2,209,603, REN. 12-22-08. INT. CL. 3.
- YUANTIAN ZHANG, CHINA:
3,567,872, PUB. 11-11-2008. MULTIPLE CLASS, INT. CLS. 9, 38 AND 42.
- YULONG COMPUTER TELECOMMUNICATION; SCIENTIFIC (SHENZHEN) CO., LTD, CHINA:
3,567,860, PUB. 11-11-2008. INT. CL. 9.
- YUMMY FOOD PRODUCTS, INC., GLENDALE, CA:
3,567,645, PUB. 11-11-2008. INT. CL. 29.
- YVES SAINT LAURENT INTERNATIONAL, B.V., AMSTERDAM, NETHERLANDS:
853,369, REN. 12-20-08. U.S. CL. 51 (INT. CL. 3).
- ZABAR'S & CO., INC., NEW YORK, MA:
3,567,521, PUB. 11-11-2008. MULTIPLE CLASS, INT. CLS. 29, 30 AND 32.
- ZABAR'S & CO., INC., NEW YORK, NY:
3,567,550, PUB. 11-11-2008. MULTIPLE CLASS, INT. CLS. 35 AND 43.
- 3,567,719, PUB. 11-11-2008. INT. CL. 28.
- ZACHARY JIRKOVSKY, CAMARILLO, CA:
3,568,228, INT. CL. 28.
- ZADI FOODS LIMITED, TORONTO, ONTARIO, CANADA:
2,545,665, CANC. INT. CL. 29.
- ZANDERS FEINPAPIERE AG, 51465 BERGISCH, GLADBACH, FED REP GERMANY:
2,545,548, CANC. INT. CL. 16.
- ZAPMEDIA.COM, INC., ATLANTA, GA:
2,546,165, CANC. MULTIPLE CLASS, INT. CLS. 38 AND 42.
- ZAVALA, AIMEE, DANVILLE, CA:
3,568,763, INT. CL. 42.
- ZEBRA MACHINE WORKS, INC., STATE COLLEGE, PA:
2,547,581, CANC. INT. CL. 7.
- 2,547,582, CANC. INT. CL. 7.
- ZEBRA PEN CORP., EDISON, NJ:
2,546,391, CANC. INT. CL. 16.
- ZEBRA PEN CORPORATION, EDISON, NJ:
2,149,829, REN. 12-20-08. INT. CL. 16.
- ZEBWARE, INC., NEW YORK, NY:
2,546,356, CANC. INT. CL. 9.
- ZEIGLER BROS., INC., GARDNERS, PA:
2,546,557, CANC. INT. CL. 31.
- ZEN SPA ENTERTAINMENT, INC., SAN JUAN, PUERTO RICO:
3,566,483, PUB. 11-11-2008. INT. CL. 3.
- ZENE INC., NAUTUN DISTRICT, TAICHUNG CITY 408, TAIWAN:
3,566,334, PUB. 11-11-2008. INT. CL. 9.
- 3,566,335, PUB. 11-11-2008. INT. CL. 12.
- ZERO TO SEVEN INC., SEOUL, REPUBLIC OF KOREA:
3,567,897, PUB. 11-11-2008. MULTIPLE CLASS, INT. CLS. 10 AND 11.
- ZETA BETA TAU FRATERNITY INC., INDIANAPOLIS, IN:
1,127,341, REN. 12-23-08. U.S. CL. 200.
- 1,127,342, REN. 12-22-08. U.S. CL. 200.
- ZHEJIANG FOREST BAMBOO CHARCOAL CO., LTD., CHINA:
3,567,949, PUB. 11-11-2008. MULTIPLE CLASS, INT. CLS. 5, 20 AND 21.
- ZIBI JACQUY, FRANCE:
3,567,970, PUB. 11-11-2008. MULTIPLE CLASS, INT. CLS. 3, 14, 18 AND 25.
- ZICAM, LLC, SCOTTSDALE, AZ:
3,568,241, INT. CL. 5.
- ZILOG, INC., SAN JOSE, CA:
3,567,657, PUB. 11-11-2008. INT. CL. 9.
- ZOEZA GROUP, LLC, PHILADELPHIA, PA:
3,568,776, INT. CL. 41.
- ZOHAR WATERWORKS, LLC, CHARLOTTE, NC:
2,546,023, CANC. INT. CL. 11.
- ZONDERVAN CORPORATION, THE, GRAND RAPIDS, MI:
2,547,730, CANC. INT. CL. 16.
- ZOTEFOMAS PLC, SURREY CR9 3AL, UNITED KINGDOM:
2,545,647, CANC. INT. CL. 17.
- ZOTTER HOLDING GMBH, AUSTRIA:
3,567,929, PUB. 11-11-2008. INT. CL. 30.
- 10 FITNESS, INC., NORTH LITTLE ROCK, AR:
3,567,067, PUB. 11-11-2008. INT. CL. 41.
- 101 HUNTINGTON HOLDINGS, LLC, BOSTON, MA:
3,566,664, PUB. 11-11-2008. INT. CL. 36.
- 1063304 ONTARIO INC., TORONTO, ONTARIO, CANADA:
2,547,928, CANC. INT. CL. 25.
- 123HIRE.COM, INC., CHARLOTTE, NC:
2,547,053, CANC. INT. CL. 35.
- 1354846 ONTARIO, INC., TORONTO, ONTARIO M6K 3B6, CANADA:
2,548,211, CANC. INT. CL. 35.
- 2C, INC., SAN JOSE, CA:
2,547,413, CANC. INT. CL. 42.
- ZONE5 LLC, PHILADELPHIA, PA:
3,566,673, PUB. 11-11-2008. INT. CL. 25.
- 2WRONGS.COM, INC., MCLEAN, VA:
2,546,571, CANC. INT. CL. 42.
- 21ST CENTURY BUSINESS TOOLS, L.L.C., PHOENIX, AZ:
2,545,720, CANC. INT. CL. 35.
- 3'S COMPANY, LLC, CHERRY HILL, NJ:
3,567,785, PUB. 11-11-2008. INT. CL. 2.
- 3E TECHNOLOGIES INTERNATIONAL, INC., ROCKVILLE, MD:
3,566,853, PUB. 11-11-2008. INT. CL. 9.
- 4-BALL, LLC, OJAI, CA:
2,546,282, CANC. INT. CL. 41.
- 4B ELEVATOR COMPONENTS, LTD., EAST PEORIA, IL:
3,566,276, PUB. 11-11-2008. MULTIPLE CLASS, INT. CLS. 7 AND 9.
- 52ND STREET CHOCOLATE CO., LLC, PEARL RIVER, NY:
3,566,573, PUB. 11-11-2008. INT. CL. 30.
- 55 BROAD STREET L.P., NEW YORK, NY:
2,144,115, CANC. MULTIPLE CLASS, INT. CLS. 35, 36, 37, 38 AND 42.
- 566382 ONTARIO LIMITED, C/O/B UWG, MISSISSAUGA, ONTARIO, CANADA:
2,545,879, CANC. MULTIPLE CLASS, INT. CLS. 35, 39 AND 42.

JANUARY 27, 2009

U.S. PATENT AND TRADEMARK OFFICE

TMI 81

600 UK LIMITED, LETCHWORTH, HERTFORDSHIRE
SG62HB, ENGLAND:
1,515,210. REN. 12-19-08. INT. CL. 9.
7-ELEVEN, INC., DALLAS, TX:
2,547,269, CANC. INT. CL. 35.
750 MUSIC, INC., DAYTON, OH:
2,546,515, CANC. INT. CL. 41.

800 MARKETING SOLUTIONS, INC., LOGANVILLE, GA:
3,566,633, PUB. 11-11-2008. MULTIPLE CLASS, INT. CLS.
35 AND 36.

88 INTERNATIONAL, INC., ALHAMBRA, CA:
3,568,722, INT. CL. 25.

* * * * *